

Generating Sequential Triangle Strips by Using Hopfield Nets

Jiří Šíma



Institute of Computer Science
Academy of Sciences of the Czech Republic

joint work with **Radim Lněnička**

J. Šíma, R. Lněnička: Sequential triangle strip generator based on Hopfield networks. To appear in *Neural Computation*, 21(2), 2009.

Motivation from Graphics and Visualization

- 3D geometric models are represented by triangulated surfaces \longrightarrow **triangulation** = a set of triangles

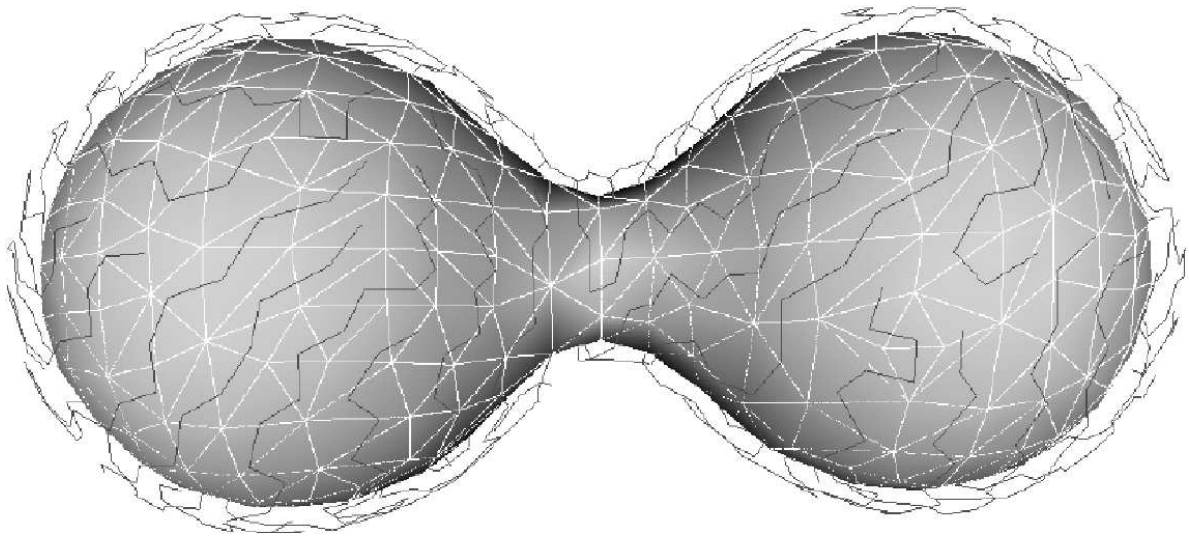

- 3D graphics rendering hardware: memory bus bandwidth bottleneck in the processor-to-graphics pipeline
- **the coordinates of edges that are shared by two triangles can be transmitted only once**
- efficient encoding of triangulated surfaces by using so-called *sequential triangle strips*
- supported by **graphics libraries** (e.g. IGL, PHIGS, Inventor, OpenGL)

Sequential Triangle Strip (Tristrip)

an ordered sequence of $m \geq 3$ vertices $\sigma = (v_1, \dots, v_m)$ encoding $n(\sigma) = m - 2$ different triangles $\{v_p, v_{p+1}, v_{p+2}\}$ for $1 \leq p \leq m - 2$ such that their shared edges follow **alternating left and right turns**

Example:

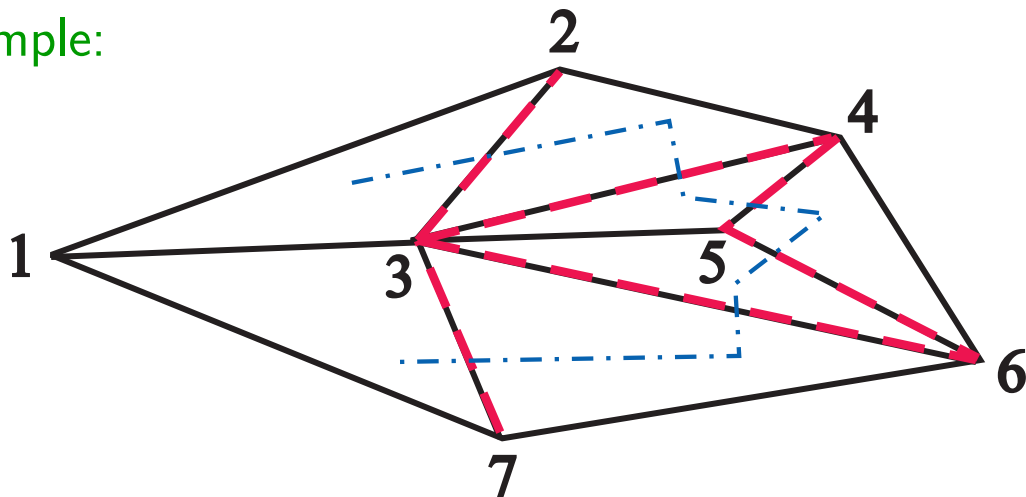

tristrip $(1, 2, 3, 4, 5, 6, 3, 7, 1)$ encodes 7 triangles $\{1, 2, 3\}$, $\{2, 3, 4\}$, $\{3, 4, 5\}$, $\{4, 5, 6\}$, $\{5, 6, 3\}$, $\{6, 3, 7\}$, $\{3, 7, 1\}$

a tristrip with n triangles allows transmitting of only $n+2$ (rather than $3n$) vertices

a triangulated surface model T with n triangles that is decomposed into k **tristrips** $\Sigma = \{\sigma_1, \dots, \sigma_k\}$ requires **only $n + 2k$ vertices** to be transmitted

Stripification Problem: decompose a given triangulation T into the fewest tristrips Σ

the stripification problem is **NP-complete**

(Estkowski, Mitchell, Xiang, 2002)

Hopfield Networks

- fundamental neural network model introduced by John Hopfield in 1982
- inspired by [Ising spin glass model](#) in statistical physics
- [convergence](#) guarantees (energy function)
- natural [hardware implementations](#) by analog electrical networks and optical computers
- influential [associative memory](#) model (low storage capacity)
- fast approximate solution of combinatorial [optimization problems](#) (e.g. traveling salesman problem)

Architecture:

- s computational [units \(neurons\)](#), indexed as $N = \{1, \dots, s\}$, that are connected into an undirected graph $G = (N, \mathcal{E})$
- each edge between i and j is labeled with an integer [symmetric weight](#)

$$w(i, j) = w(j, i)$$

- $w(i, j) = 0$ means no connection between i and j ;
assume $w(j, j) = 0$ for $j = 1, \dots, s$

Discrete-Time Sequential Computation

the evolution of the *network state*

$$\mathbf{y}^{(t)} = (y_1^{(t)}, \dots, y_s^{(t)}) \in \{0, 1\}^s$$

at discrete time instants $t = 0, 1, 2, \dots$

1. *initial state* $\mathbf{y}^{(0)}$, e.g. $\mathbf{y}^{(0)} = (0, \dots, 0)$
2. at discrete time $t \geq 0$ the *excitation*

$$\xi_j^{(t)} = \sum_{i=1}^s w(i, j) y_i^{(t)} - h_j \quad \text{for } j = 1, \dots, s$$

where h_j is an integer *threshold* of unit j

3. at the next time instant $t + 1$ one (e.g. randomly) selected neuron j computes its new *state (output)*

$$y_j^{(t+1)} = H(\xi_j^{(t)})$$

where $H : \mathfrak{R} \longrightarrow \{0, 1\}$ is the *Heaviside* activation function:

$$H(\xi) = \begin{cases} 1 & \text{for } \xi \geq 0 \\ 0 & \text{for } \xi < 0, \end{cases}$$

while $y_i^{(t+1)} = y_i^{(t)}$ for $i \neq j$

Convergence

macroscopic time $\tau = 0, 1, 2, \dots$: all the units in the network are updated within one macroscopic step

a Hopfield net *converges* or *reaches a stable state* $\mathbf{y}^{(\tau^*)}$ at macroscopic time $\tau^* \geq 0$ if

$$\mathbf{y}^{(\tau^*)} = \mathbf{y}^{(\tau^*+1)}$$

Energy Function:

$$E(\mathbf{y}) = -\frac{1}{2} \sum_{j=1}^s \sum_{i=1}^s w(i, j) y_i y_j + \sum_{j=1}^s h_j y_j$$

- **bounded** function
- **decreasing** along any nonconstant computation path ($\xi_j^{(t)} \neq 0$ is assumed without loss of generality)

→ Starting from any initial state, the Hopfield network converges towards some stable state corresponding to a **local minimum** of E . (Hopfield, 1982)

Combinatorial Optimization

the **cost function** of a hard combinatorial optimization problem is encoded into the energy of a Hopfield net which is minimized in the course of computation

Minimum Energy Problem: given a Hopfield net, find its state with minimum energy

the minimum energy problem is **NP-complete**
(Barahona, 1982)

Boltzmann machine = stochastic Hopfield network:
randomly selected neuron j computes its new state:

$$y_j^{(t+1)} = 1 \quad \text{with probability} \quad P\left(\xi_j^{(t)}\right)$$

(i.e. $y_j^{(t+1)} = 0$ with probability $1 - P(\xi_j^{(t)})$) where $P: \mathfrak{R} \rightarrow (0, 1)$ is the **probabilistic activation function**:

$$P(\xi) = \frac{1}{1 + e^{-2\xi/T(\tau)}},$$

$T^{(\tau)} > 0$ is a **temperature** at microscopic time $\tau \geq 0$

Simulated Annealing: starting with sufficiently high initial $T^{(0)}$, the temperature gradually decreases, e.g.

$$T^{(\tau)} = \frac{T^{(0)}}{\log(1 + \tau)} \quad \text{for } \tau > 0$$

Notation & Definitions

- T is a set of n triangles = a triangulated surface model (2-manifold of genus 0 with possible boundaries)
- each edge is incident to **at most two** triangles
- B and I are the sets of **boundary** and **internal edges** that are shared by exactly one and two triangles, respectively
- **Sequential Cycle** = a “cycled tristrip” $c = (v_1, \dots, v_m)$ (m is even) such that $v_{m-1} = v_1, v_m = v_2$

Example:

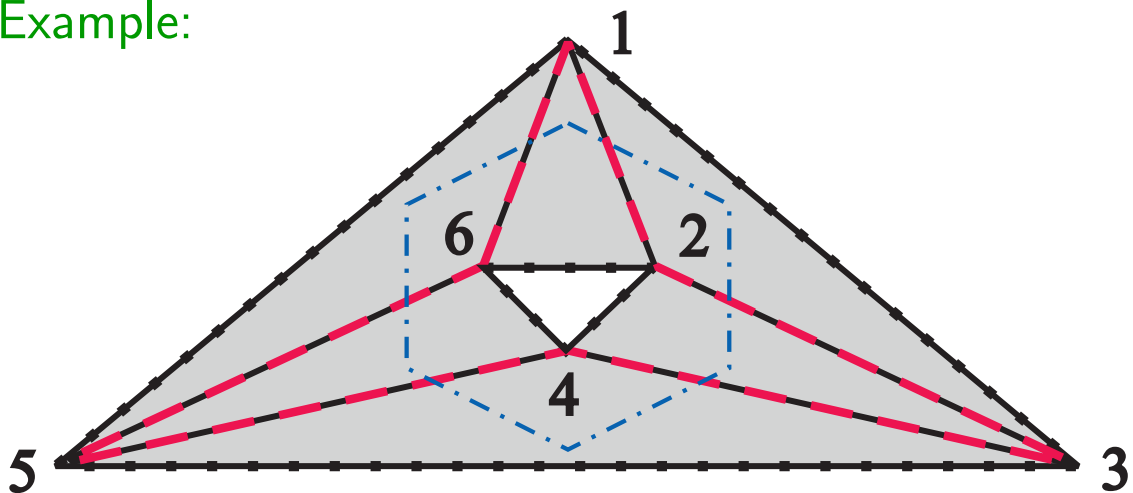

sequential cycle $(1, 2, 3, 4, 5, 6, 1, 2)$

- $I_c = \{\{v_p, v_{p+1}\}; 1 \leq p \leq m - 2\}$ is the set of **internal** edges of sequential cycle c (red dashed line)
- $B_c = \{\{v_p, v_{p+2}\}; 1 \leq p \leq m - 2\}$ is the set of **boundary** edges of sequential cycle c (dotted line)
- \mathcal{C} is the set of **all sequential cycles** in T

Generating the Set of All Sequential Cycles \mathcal{C}

- start with any internal edge e of T and traverse e either **clockwise** or **counter-clockwise**
- go on along a corresponding **tristrip** by alternating the left and right turns

→ **this tristrip**

1. ends up in a boundary edge of the surface
 2. terminates before some of its edge is traversed **for the second time** but in the **opposite direction**
 3. comes **back to the initial edge** e which is traversed solely clockwise or solely counter-clockwise
i.e. the tristrip is **properly cycled** and included in \mathcal{C}
- the procedure is **repeated** until all internal edges are traversed both clockwise and counter-clockwise
 - the **computational time** for generating \mathcal{C} is proportional to the number of edges in T (each internal edge is traversed exactly twice) which is **linear** in terms of $n = |T|$

Representative Internal Edges

to each sequential cycle $c \in \mathcal{C}$, assign a **unique representative** internal edge $e_c \in I_c$ using the following procedure:

1. **start** with any $c \in \mathcal{C}$ and choose any edge from I_c to be its representative edge e_c
2. **stop** if all the sequential cycles do have their representative edges
3. denote by c' the sequential cycle **having no representative edge so far** which shares its internal edge $e_c \in I_c \cap I_{c'}$ with c if such c' exists; otherwise let c' be any sequential cycle with no representative internal edge
4. choose any edge from $I_{c'} \setminus \{e_c\}$ to be the representative edge $e_{c'}$ of c'
5. $c := c'$ and **go to 2**

Correctness:

$I_{c'} \setminus \{e_c\} \neq \emptyset$ contains no representative edge when performing step 4

→ each $c \in \mathcal{C}$ has a **unique** representative edge e_c

The Construction of Hopfield Network \mathcal{H}_T

for generating the stripifications for a given T

Hopfield network \mathcal{H}_T is composed of two parts:

$$N = N_1 \cup N_2$$

1. the first part N_1 encodes tristrips of a stripification Σ :

- N_1 contains two neurons ℓ_e and r_e for each internal edge $e \in I$:

$$N_1 = \{\ell_e, r_e \mid e \in I\}$$

- two triangles in T that share internal edge e are connected in a tristrip $\sigma \in \Sigma$ iff either $y_{\ell_e} = 1$ (σ traverses e counter-clockwise) or $y_{r_e} = 1$ (σ traverses e clockwise)
- \mathcal{H}_T converges to the states that encode disjoint correct tristrips which alternate the left and right turns

2. the second part N_2 prevents \mathcal{H}_T from converging to the states that encode cycled tristrips along the sequential cycles from \mathcal{C}

- such infeasible states may have less energy than those encoding the optimal stripifications
- N_2 contains two neurons a_c and d_c for each sequential cycle $c \in \mathcal{C}$:

$$N_2 = \{a_c, d_c \mid c \in \mathcal{C}\}$$

→ the size of \mathcal{H}_T is $|N| = 2|I| + 2|\mathcal{C}| = O(n)$

The Architecture of \mathcal{H}_T (first part)

- for each internal edge $e = \{v_1, v_2\} \in I$

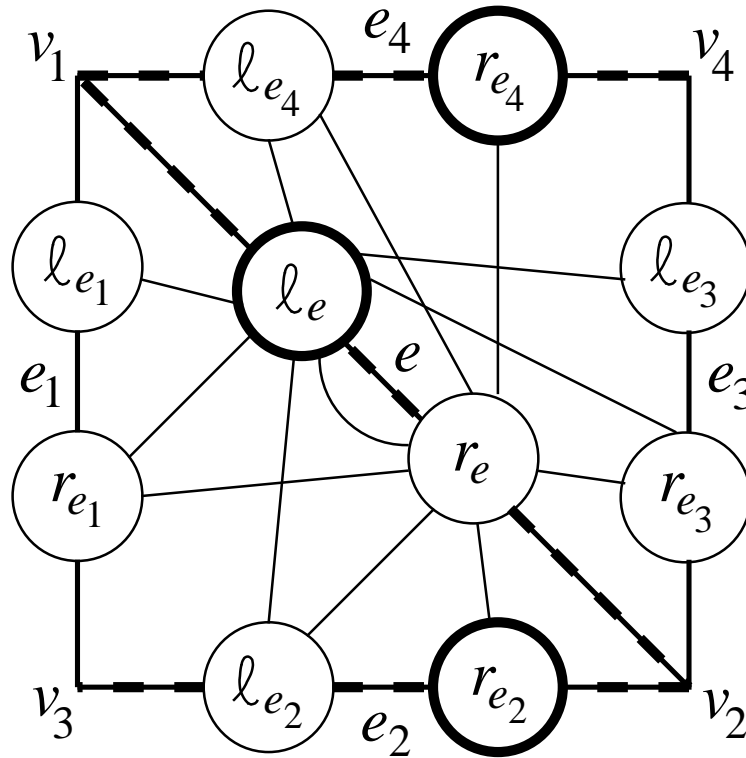

- $L_e = \{e, e_1, e_2, e_3, e_4\}$ is the set of edges of the **two triangles** $\{v_1, v_2, v_3\}, \{v_1, v_2, v_4\}$ that share edge e
 $\longrightarrow J_e = \{\ell_f, r_f; f \in L_e \cap I\}$ are associated neurons
- symmetric **negative weights**

$$w(\ell_e, i) = -7 \quad \text{for } i \in J_e \setminus \{r_{e_2}, \ell_e, r_{e_4}\}$$

$$w(r_e, i) = -7 \quad \text{for } i \in J_e \setminus \{\ell_{e_1}, r_e, \ell_{e_3}\}$$

$(h_{\ell_e} = h_{r_e} = -5)$ force a tristrip to traverse edge e

either counter-clockwise if $y_{\ell_e} = 1$

$\longrightarrow y_i = 0$ for all $i \in J_e \setminus \{r_{e_2}, \ell_e, r_{e_4}\}$

or clockwise if $y_{r_e} = 1$

$\longrightarrow y_i = 0$ for all $i \in J_e \setminus \{\ell_{e_1}, r_e, \ell_{e_3}\}$

The Architecture of \mathcal{H}_T (second part)

2. for each sequential cycle $c \in \mathcal{C}$

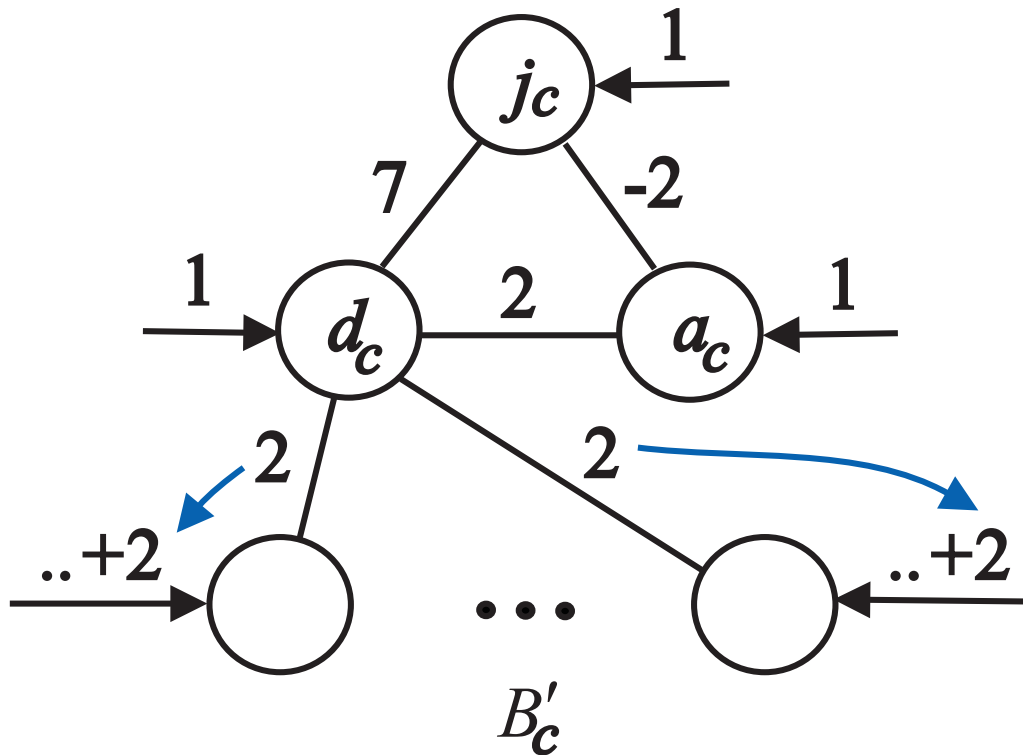

- $$j_c = \begin{cases} \ell_{e_c} & \text{if } c \text{ traverses } e_c \text{ counter-clockwise} \\ r_{e_c} & \text{if } c \text{ traverses } e_c \text{ clockwise} \end{cases}$$

neuron j_c can be activated, i.e. a possible trisrip σ can go along sequential cycle c via e_c **only if** $y_{d_c} = 1$

- unit d_c computes the **disjunction** of the outputs from neurons ℓ_e, r_e associated with the **boundary edges** $e \in B'_c = B_c \setminus L_{e_c}$ of sequential cycle c

$\longrightarrow y_{d_c} = 1$ **iff** $(\exists e \in B'_c) y_{\ell_e} = 1$ or $y_{r_e} = 1$

iff there is another trisrip σ' traversing a boundary edge $e \in B'_c$ of sequential cycle c and crossing c , which **prevents a possible σ to be cycled along c**

- **auxiliary unit** a_c balances the contribution of active d_c to the energy E when j_c is passive

The Complexity of the Reduction

1. number of units in \mathcal{H}_T :

$$|N| = |N_1| + |N_2| = 2|I| + 2|C|$$

each internal edge can be traversed by at most two sequential cycles (clockwise or counter-clockwise), i.e. $|C| \leq 2|I|$

$$\longrightarrow |N| \leq 4|I| = O(n)$$

2. number of connections in \mathcal{H}_T :

$$\begin{aligned} |\mathcal{E}| \leq & \sum_{e \in I} \underbrace{|J_e \setminus \{r_{e_2}, \ell_e, r_{e_4}\}|}_7 + \sum_{e \in I} \underbrace{|J_e \setminus \{\ell_{e_1}, r_e, \ell_{e_3}\}|}_7 \\ & + \sum_{c \in C} \underbrace{|{\{\{d_c, j_c\}, \{a_c, j_c\}, \{d_c, a_c\}\}}|}_3 + \sum_{c \in C} 2|B'_c| \end{aligned}$$

each internal edge can be a boundary for at most two sequential cycles, i.e. $\sum_{c \in C} |B'_c| \leq 2|I|$

$$\longrightarrow |\mathcal{E}| \leq 2 \cdot 7|I| + 3|C| + 2 \cdot 2|I| = O(n)$$

\longrightarrow the Hopfield network \mathcal{H}_T has a **linear number of units and connections** in terms of $n = |T|$ and can be constructed in **linear time**

The Correctness of the Reduction

a stripification Σ is *equivalent* with Σ' if their corresponding tristrrips encode the same sets of triangles

e.g., $\Sigma \sim \Sigma'$ may differ in a tristrrip encoding the triangles of a sequential cycle which is split at two different positions

Theorem 1 **Let** \mathcal{H}_T be a Hopfield network corresponding to a triangulation T with n triangles and denote by $Y^* \subseteq \{0, 1\}^s$ the *set of all stable states* that can be reached during the sequential computation by \mathcal{H}_T starting at the zero initial state. **Then** each state $\mathbf{y} \in Y^*$ encodes a *correct stripification* $\Sigma_{\mathbf{y}}$ of T and has energy

$$E(\mathbf{y}) = -5(n - |\Sigma_{\mathbf{y}}|).$$

In addition, there is a *one-to-one correspondence* between the classes of equivalent *optimal stripifications* $[\Sigma]_{\sim}$ having the minimum number of tristrrips for T and the *states in Y^* with the minimum energy* $\min_{\mathbf{y} \in Y^*} E(\mathbf{y})$.

Comments:

- *another NP-completeness proof* for the minimum energy problem in Hopfield networks
- *arbitrary initial states* if the weight $w(d_c, j_c) = 7$ is *asymmetric* (i.e. $w(j_c, d_c) = 0$) which does not break the convergence of \mathcal{H}_T to the states $\mathbf{y} \in Y^*$

Idea of Proof

Energy Calculation:

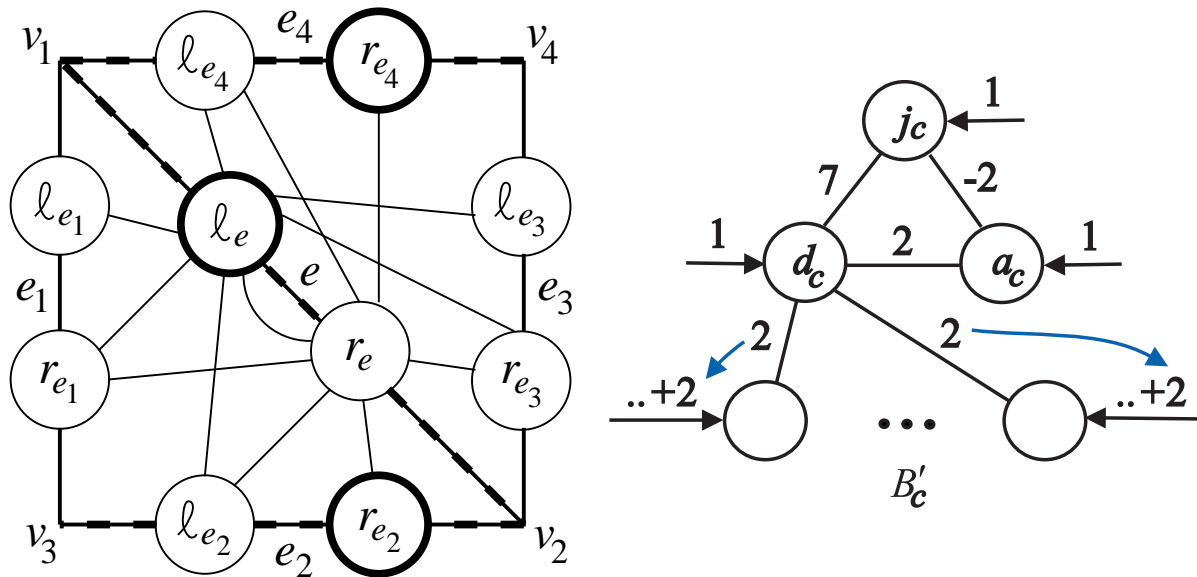

recall $E(\mathbf{y}) = -\frac{1}{2} \sum_{j=1}^s \sum_{i=1}^s w(i, j) y_i y_j + \sum_{j=1}^s h_j y_j$

1. a contribution to E from $y_j = 1$ for $j \in \{l_e, r_e\}$ such that $e \neq e_c$:
 $h_j = -5$

2. a contribution to E from $y_{j_c} = 1$ for $j_c \in \{l_{e_c}, r_{e_c}\}$ ($\longrightarrow y_{d_c} = 1, y_{a_c} = 0$):

$$-\frac{1}{2} w(d_c, j_c) - \frac{1}{2} w(j_c, d_c) + h_{d_c} + h_{j_c} = -7 + 1 + 1 = -5$$

for $y_{j_c} = 0$ and $y_{d_c} = 1 \longrightarrow y_{a_c} = 1$:

$$-w(d_c, a_c) + h_{d_c} + h_{a_c} = -2 + 1 + 1 = 0$$

energy $E(\mathbf{y})$ for $\mathbf{y} \in Y^*$:

$$\begin{aligned} E(\mathbf{y}) &= -5 \cdot |\{j \in N_1; y_j = 1\}| \\ &= -5 \cdot \sum_{\sigma \in \Sigma_{\mathbf{y}}} (n(\sigma) - 1) = -5(n - |\Sigma_{\mathbf{y}}|) \end{aligned}$$

Problem with Unreachable States:

define a **directed graph** $G = (\mathcal{C}, \mathcal{A})$ whose nodes are sequential cycles:

$$(c_1, c_2) \in \mathcal{A} \quad \text{iff} \quad e_{c_1} \in B'_{c_2}$$

consider a **directed cycle in** G , e.g. $(c_1, c_2), (c_2, c_1) \in \mathcal{A}$:

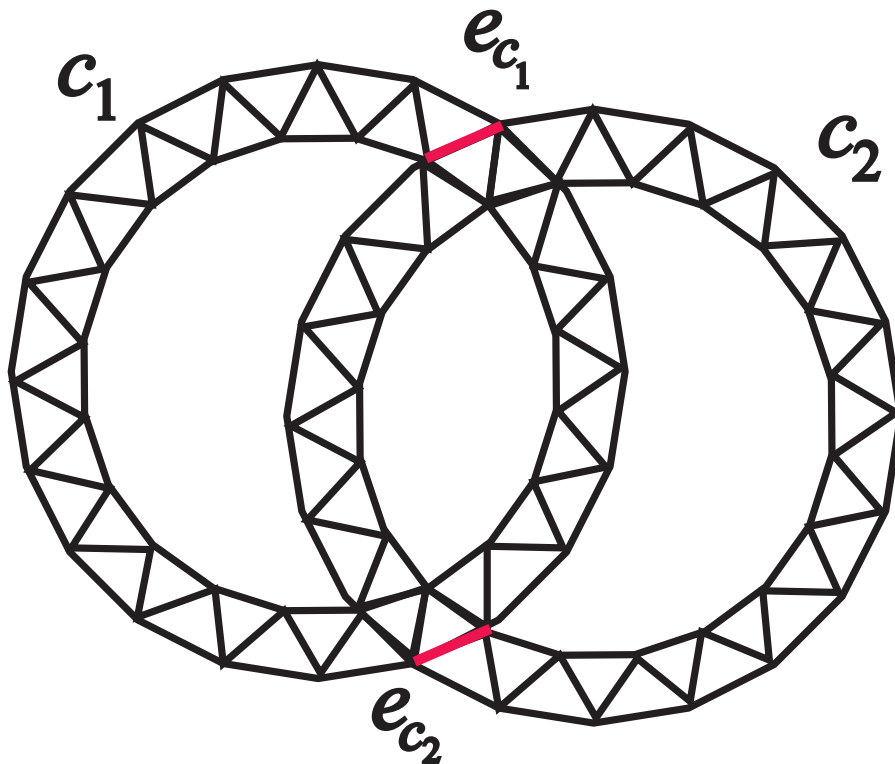

a **stable state** \mathbf{y} satisfying

1. $y_{j_{c_1}} = y_{j_{c_2}} = 1$

2. $y_j = 0$ for all $j \in \{\ell_e, r_e; e \in B'_{c_1} \cup B'_{c_2}\} \setminus \{j_{c_1}, j_{c_2}\}$

is **unreachable** by \mathcal{H}_T from the zero initial state (j_{c_1} or j_{c_2} is activated only if a unit from $\{\ell_e, r_e; e \in B'_{c_1} \cup B'_{c_2}\}$ is active)

× it can be proved that \mathbf{y} is **not optimal**

Computer Experiments

Program HTGEN

- ANSI C program available [online](http://www.cs.cas.cz/~sima/htgen-en.html) at <http://www.cs.cas.cz/~sima/htgen-en.html>
- *Input:* a **Wavefront .obj file** describing **triangulated surface model T** (i.e. a list of triangular faces together with geometric vertex coordinates)
- generates a corresponding **Hopfield network \mathcal{H}_T**
- performs **computations of \mathcal{H}_T** including the **simulated annealing** with the optional parameters:
 - initial temperature $T^{(0)}$
 - stopping criterion $\varepsilon =$ the maximum percentage of unstable units at the end of stochastic computation
- *Output:* an **.objf file** with a **stripification Σ_y of T** (i.e. a list of tristrips) which is extracted from the final stable state $\mathbf{y} \in Y^*$ of \mathcal{H}_T at microscopic time τ^*

Used Computer

- notebook HP Compaq nx6110 1.6GHz with 512MB RAM, running Linux operating system
- the **running time** is stated **in seconds** including the system overhead but not including the time needed for the construction of \mathcal{H}_T (mostly less than one second)

Used Models

- 3D geometric models represented via polygonal meshes from several repositories
- sometimes triangulated using the software package LODestar or converted into the .obj format

| Model | Triangulated Mesh T | | | Hopfield Net \mathcal{H}_T | |
|--------------|-----------------------|---------------------|-----------------------|------------------------------|-----------------------|
| | Number of Vertices | Number of Triangles | Number of Seq. Cycles | Number of Neurons | Number of Connections |
| asteroid250 | 110 | 216 | 20 | 688 | 3544 |
| asteroid500 | 223 | 442 | 12 | 1350 | 5445 |
| asteroid1k | 477 | 950 | 18 | 2886 | 11757 |
| asteroid2.5k | 1211 | 2418 | 30 | 7314 | 30039 |
| asteroid5k | 2422 | 4840 | 43 | 14606 | 60237 |
| asteroid10k | 4916 | 9828 | 62 | 29608 | 122476 |
| asteroid20k | 9902 | 19800 | 89 | 59578 | 246971 |
| asteroid40k | 19814 | 39624 | 126 | 119124 | 494550 |
| asteroid60k | 29798 | 59592 | 155 | 179086 | 743981 |
| asteroid80k | 39782 | 79560 | 179 | 239038 | 993437 |
| asteroid100k | 49649 | 99294 | 200 | 298282 | 1239987 |
| asteroid200k | 99467 | 198930 | 284 | 597358 | 2484945 |
| asteroid300k | 149802 | 299600 | 349 | 899498 | 3742939 |
| shuttle | 476 | 616 | 0 | 1528 | 4490 |
| f-16 | 2344 | 4592 | 9 | 13794 | 48643 |
| cessna | 6763 | 7446 | 10 | 16882 | 46083 |
| lung | 3121 | 6076 | 4 | 18064 | 63116 |
| triceratops | 2832 | 5660 | 2 | 16984 | 59532 |
| Roman | 10473 | 20904 | 0 | 62548 | 218426 |
| bunny | 34834 | 69451 | 1 | 208132 | 727951 |
| dragon | 437645 | 871414 | 334 | 2610640 | 9144021 |

Examples of Used Models

Asteroid1k Model (950 triangles)

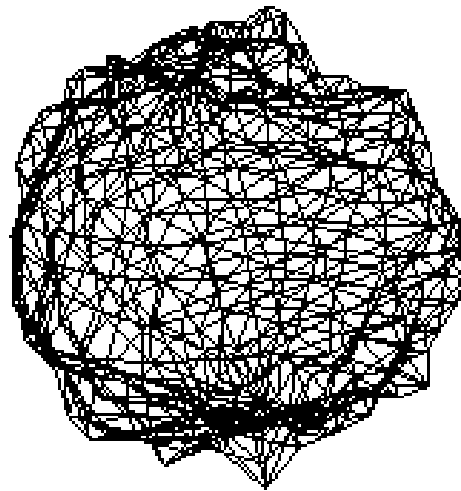

Triceratops Model (5660 triangles)

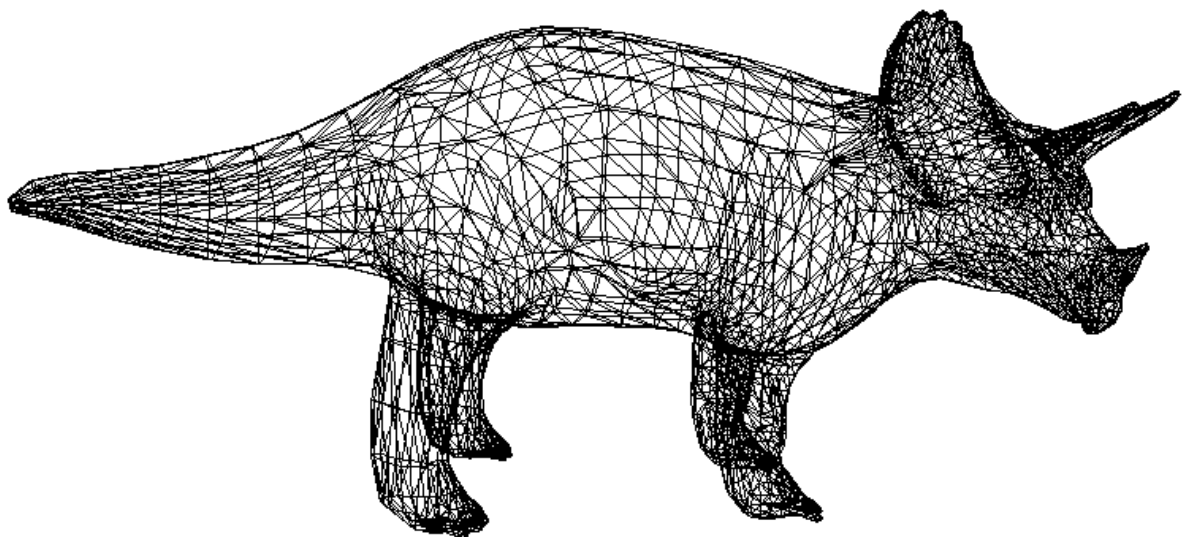

The Number of Trials of Simulated Annealing

the dependence of the achieved stripification quality (i.e. the best number of tristrrips) on the number of performed trials of simulated annealing:

| Number of Trials | Best Number of Tristrrips | | |
|------------------|---------------------------|-------------|-------|
| | asteroid2.5k | asteroid10k | Roman |
| 10 | 244 | 929 | 2442 |
| 20 | 227 | 929 | 2425 |
| 30 | 228 | 897 | 2410 |
| 40 | 221 | 941 | 2405 |
| 50 | 228 | 938 | 2403 |
| 60 | 224 | 905 | 2408 |
| 70 | 219 | 908 | 2392 |
| 80 | 223 | 918 | 2412 |
| 90 | 220 | 945 | 2401 |
| 100 | 223 | 939 | 2380 |
| 200 | 214 | 935 | 2364 |
| 400 | 219 | 893 | 2395 |
| 600 | 208 | 905 | 2372 |
| 800 | 217 | 895 | 2364 |
| 1000 | 211 | 915 | 2380 |

→ the stripification quality does not substantially increase with the increasing number of trials and the results averaged over 10 to 30 trials are reasonably reliable

The Choice of Parameters $T^{(0)}$ and ε

- the **dependence** of the resulting **number of tristrrips** and the **running time** on **both** the **initial temperature** $T^{(0)}$ and the **stopping criterion** ε
- illustrated on the **asteroid40k** model
- results averaged over **10 trials**
- each cell in the **following table** contains
 - Average Number of Tristrrips
 - Best Number of Tristrrips
 - Average Computation Time in Seconds
 - Average Macroscopic Time

→ *at the cost of additional running time the quality of stripifications improves with **increasing** $T^{(0)}$ and **decreasing** ε*

| $\downarrow T^{(0)} \bar{\epsilon}$ | 6 | 5.5 | 5 | 4.5 | 4 | 3.5 | 3 | 2.5 | 2 | 1.5 | 1 | | |
|-------------------------------------|------|--------------------------------|---|--------------------------------|---|--------------------------------|--------------------------------|--|--|--|----------------------------------|--|-------|
| 10000 | 1.5 | 12076 11980 3.8 5.0 | 12070 12014 3.8 5.0 | 12095 12029 3.6 5.0 | 12110 12033 3.7 5.0 | 12126 12077 3.4 5.0 | 12082 12011 3.8 5.0 | 12108 11991 3.9 5.0 | 12094 11988 3.8 5.0 | 12058 11958 4.4 5.9 | 12055 11933 4.5 6.0 | 12033 11955 4.4 6.0 | |
| | 3 | 10774 10610 4.4 6.0 | 10780 10674 4.6 6.0 | 10809 10691 4.3 6.0 | 10789 10674 4.5 6.0 | 10750 10590 4.7 6.2 | 10740 10480 5.0 6.2 | 10518 10399 5.3 7.0 | 10519 10406 5.0 7.0 | 10534 10422 5.1 7.0 | 10330 10190 5.7 8.0 | 10254 10185 6.2 9.0 | 10000 |
| | 4.5 | 9964 9849 5.0 7.0 | 9991 9925 5.3 7.1 | 9972 9895 5.0 7.0 | 9981 9924 5.2 7.0 | 9639 9591 5.5 8.0 | 9635 9584 5.9 8.2 | 9390 9289 6.6 9.0 | 9377 9230 6.5 9.2 | 9154 9058 7.3 10.0 | 8997 8941 7.7 11.1 | 8598 8513 9.4 13.9 | 9000 |
| 9000 | 6 | 9483 9396 5.5 8.0 | 9515 9388 5.9 8.1 | 9117 9042 6.4 9.0 | 9126 9063 6.7 9.0 | 8944 8722 6.8 9.5 | 8831 8760 6.8 10.0 | 8556 8454 7.8 11.0 | 8328 8171 8.3 12.0 | 8161 8045 8.9 13.1 | 7814 7703 10.4 15.3 | 7404 7313 13.2 19.8 | 8000 |
| | 7.5 | 8833 8761 7.0 10.1 | 8824 8693 6.8 10.1 | 8682 8413 7.0 10.5 | 8517 8398 8.0 11.1 | 8231 8170 8.1 12.0 | 8006 7922 9.0 13.0 | 7786 7694 9.7 14.0 | 7605 7381 10.3 15.0 | 7274 7221 11.5 17.1 | 6855 6812 14.2 20.9 | 6428 6278 18.4 27.1 | 7000 |
| | 9 | 8373 8251 8.4 11.9 | 8332 8178 8.5 12.0 | 8060 7990 8.8 13.0 | 7874 7721 9.6 13.9 | 7682 7547 9.9 14.8 | 7440 7276 10.8 16.0 | 7173 7072 11.6 17.5 | 6893 6826 13.0 19.4 | 6510 6412 15.0 22.7 | 6096 5996 18.6 27.9 | 5593 5510 25.0 38.0 | 6000 |
| 8000 | 10.5 | 8041 7931 9.3 14.0 | 7772 7627 10.4 15.2 | 7546 7409 10.8 16.1 | 7364 7310 11.7 17.0 | 7124 7035 12.1 18.4 | 6867 6758 13.8 19.8 | 6592 6523 15.0 22.1 | 6229 6111 16.5 25.2 | 5838 5712 19.4 30.0 | 5377 5308 24.9 38.0 | 4849 4788 35.0 53.4 | 5000 |
| | 12 | 7631 7513 11.4 17.1 | 7408 7290 12.3 18.3 | 7084 6892 13.2 19.9 | 6859 6698 14.7 21.3 | 6582 6433 15.5 23.1 | 6272 6202 17.9 26.1 | 5932 5822 19.1 29.1 | 5605 5512 22.4 33.6 | 5236 5098 26.3 40.3 | 4784 4657 33.8 51.3 | 4255 4171 48.2 74.7 | 4000 |
| | 13.5 | 7240 7170 14.3 21.0 | 6939 6766 15.3 22.9 | 6694 6585 16.0 24.6 | 6372 6274 17.9 26.7 | 6102 6004 19.7 29.8 | 5794 5679 21.6 32.7 | 5399 5314 24.8 37.9 | 5030 4917 29.1 44.6 | 4678 4561 35.1 53.8 | 4234 4176 46.0 71.0 | 3726 3647 69.5 106.5 | 7000 |
| 7000 | 15 | 6806 6571 17.9 26.6 | 6551 6387 18.7 28.5 | 6228 6125 21.0 31.5 | 5954 5856 22.9 34.2 | 5616 5464 24.7 38.0 | 5247 5164 28.8 42.9 | 4934 4813 33.0 49.9 | 4551 4494 39.3 58.9 | 4144 4064 48.4 74.1 | 3714 3605 64.8 100.1 | 3179 3093 99.5 155.1 | 6000 |
| | 16.5 | 6435 6288 22.1 33.4 | 6134 5987 24.5 36.1 | 5822 5697 25.9 39.9 | 5517 5452 28.5 43.5 | 5166 5049 32.2 49.3 | 4801 4599 36.8 56.8 | 4424 4376 42.6 65.5 | 4084 4007 51.2 79.3 | 3652 3514 65.5 100.6 | 3226 3105 91.8 141.2 | 2778 2690 142.9 222.3 | 3000 |
| | 18 | 6096 6011 27.8 41.7 | 5815 5723 30.1 45.6 | 5455 5403 33.0 50.4 | 5123 5000 36.8 56.5 | 4803 4715 41.8 63.7 | 4426 4337 48.4 73.3 | 4029 3925 56.6 86.8 | 3658 3549 68.5 106.2 | 3274 3215 89.5 136.7 | 2854 2774 124.7 192.6 | 2363 2281 206.3 320.6 | 6000 |
| 6000 | 19.5 | 5754 5656 35.0 53.3 | 5404 5328 38.1 58.6 | 5084 4958 42.5 64.9 | 4775 4684 47.8 73.6 | 4365 4255 53.9 82.9 | 4028 3921 62.4 95.6 | 3637 3518 75.0 115.3 | 3268 3195 91.7 141.5 | 2835 2759 123.2 188.6 | 2449 2364 177.8 275.3 | 2050 1956 301.1 467.9 | 5000 |
| | 21 | 5477 5267 43.7 66.9 | 5095 4985 48.0 74.3 | 4786 4692 54.6 83.0 | 4431 4331 61.5 93.6 | 4008 3813 70.5 108.2 | 3642 3483 82.4 127.0 | 3279 3236 100.6 154.7 | 2893 2796 125.2 193.7 | 2530 2480 167.6 259.4 | 2129 2072 251.5 387.8 | 1790 1753 442.2 686.0 | 2000 |
| | 22.5 | 5194 5018 55.4 84.5 | 4846 4728 62.9 95.9 | 4483 4355 67.9 105.6 | 4085 3932 78.8 121.8 | 3697 3596 91.2 140.2 | 3329 3178 109.0 167.2 | 2951 2888 132.0 204.5 | 2616 2512 170.4 263.2 | 2215 2163 232.8 359.6 | 1875 1772 354.9 549.7 | 1502 1404 657.5 1018.5 | 5000 |
| 5000 | 24 | 5008 4920 70.0 108.0 | 4565 4492 79.2 121.8 | 4201 4111 88.0 136.5 | 3781 3596 100.4 155.6 | 3382 3295 117.8 183.5 | 3049 2951 140.9 219.4 | 2687 2627 175.3 272.0 | 2308 2223 229.9 355.7 | 1965 1882 319.7 497.2 | 1668 1609 506.7 783.4 | 1304 1237 963.1 1495.9 | 5000 |
| | 25.5 | 4699 4526 89.9 137.8 | 4270 4193 99.4 153.2 | 3962 3904 112.8 175.4 | 3533 3484 130.7 202.0 | 3119 3022 153.4 236.6 | 2758 2681 184.4 286.1 | 2419 2359 233.0 362.9 | 2078 1990 313.4 484.2 | 1752 1682 442.0 686.6 | 1427 1340 710.1 1102.3 | 1112 1073 1397.4 2175.0 | 5000 |
| | 27 | 4480 4382 113.1 175.1 | 4087 4020 129.3 198.9 | 3695 3538 147.0 227.3 | 3321 3118 170.0 262.8 | 2914 2845 199.2 308.1 | 2477 2392 247.1 382.4 | 2138 2049 313.0 485.8 | 1854 1729 428.0 663.9 | 1560 1425 621.8 963.5 | 1248 1210 1017.7 1580.4 | 978 931 2086.0 3243.8 | 1000 |
| 4000 | 28.5 | 4252 4071 145.5 224.4 | 3853 3738 163.9 252.5 | 3462 3345 186.8 288.3 | 3084 3035 218.8 341.3 | 2658 2523 265.3 410.8 | 2297 2207 323.5 502.2 | 1994 1882 414.0 645.9 | 1634 1545 574.6 893.8 | 1376 1296 859.8 1337.5 | 1083 976 1465.3 2273.7 | 807 710 3120.6 4825.9 | 4000 |
| | 30 | 4118 3986 183.0 282.9 | 3676 3555 209.0 323.2 | 3272 3144 241.5 372.1 | 2835 2683 287.0 444.0 | 2488 2375 343.4 535.1 | 2099 1971 429.1 666.4 | 1756 1657 564.4 876.2 | 1478 1376 784.9 1219.6 | 1227 1112 1212.6 1882.5 | 966 893 2108.2 3264.3 | 702 590 4593.4 7143.1 | 4000 |

“Contour Lines”

- connect the cells in the table that represent approximately **the same quality of stripification**
- a given number of tristrrips need not be achieved at all for ε greater than some **upper threshold**
- a given number of tristrrips can be obtained already for some small $T^{(0)}$ if ε is below some **lower threshold** where the contour line stagnates at some level of $T^{(0)}$
- a continuous **transition** between these two extremes
- the **shortest running time** for a given number of tristrrips is usually achieved within this transition region closer to the lower threshold of ε (cells in blue)

—→ ε can be chosen **empirically above its lower threshold** where the quality of stripifications scales with $T^{(0)}$ and with the almost optimal running time (see e.g. $\varepsilon = 1$)

The Empirical Average Time Complexity

- the dependence of the computational macroscopic time by HTGEN on the model size (the number of triangles)
- the asteroid model meshes whose sizes scale from 216 up to 198930 triangles
- for fixed values of $T^{(0)}$ and ε HTGEN converges within almost a constant number of macroscopic time steps (except for minor fluctuations for small meshes)

→ average linear time complexity of HTGEN for fixed $T^{(0)}, \varepsilon$

100 Trials, $\varepsilon = 0.1$, $T^{(0)} = 5$

| Model | Number of Triangles | Best Number of Tristrips | Average Number of Tristrips | Average Tristrip Length | Average Macro. Time |
|--------------|---------------------|--------------------------|-----------------------------|-------------------------|---------------------|
| asteroid250 | 216 | 31 | 39 | 6.97 | 79.98 |
| asteroid500 | 442 | 67 | 82 | 6.60 | 45.14 |
| asteroid1k | 950 | 151 | 171 | 6.29 | 59.69 |
| asteroid2.5k | 2418 | 397 | 429 | 6.09 | 62.67 |
| asteroid5k | 4840 | 808 | 853 | 5.99 | 67.43 |
| asteroid10k | 9828 | 1633 | 1711 | 6.02 | 68.17 |
| asteroid20k | 19800 | 3342 | 3435 | 5.92 | 70.26 |
| asteroid40k | 39624 | 6720 | 6868 | 5.90 | 70.41 |
| asteroid60k | 59592 | 10090 | 10327 | 5.91 | 69.51 |
| asteroid80k | 79560 | 13525 | 13757 | 5.88 | 70.35 |
| asteroid100k | 99294 | 16995 | 17176 | 5.84 | 70.07 |
| asteroid200k | 198930 | 34109 | 34400 | 5.83 | 70.25 |

80 Trials, $\varepsilon = 0.3$, $T^{(0)} = 9$

| Model | Number of Triangles | Best Number of Tristrips | Average Number of Tristrips | Average Tristrip Length | Average Macro. Time |
|--------------|---------------------|--------------------------|-----------------------------|-------------------------|---------------------|
| asteroid250 | 216 | 18 | 27 | 12.00 | 159.35 |
| asteroid500 | 442 | 43 | 58 | 10.28 | 88.54 |
| asteroid1k | 950 | 86 | 114 | 11.05 | 106.62 |
| asteroid2.5k | 2418 | 255 | 280 | 9.48 | 113.84 |
| asteroid5k | 4840 | 518 | 556 | 9.34 | 116.59 |
| asteroid10k | 9828 | 1052 | 1114 | 9.34 | 114.76 |
| asteroid20k | 19800 | 2148 | 2237 | 9.22 | 114.45 |
| asteroid40k | 39624 | 4347 | 4451 | 9.12 | 113.53 |
| asteroid60k | 59592 | 6550 | 6690 | 9.10 | 112.86 |
| asteroid80k | 79560 | 8650 | 8898 | 9.20 | 113.06 |
| asteroid100k | 99294 | 10884 | 11110 | 9.12 | 112.94 |
| asteroid200k | 198930 | 21994 | 22257 | 9.04 | 111.65 |

50 Trials, $\varepsilon = 0.5$, $T^{(0)} = 13$

| Model | Number of Triangles | Best Number of Tristrips | Average Number of Tristrips | Average Tristrip Length | Average Macro. Time |
|--------------|---------------------|--------------------------|-----------------------------|-------------------------|---------------------|
| asteroid250 | 216 | 12 | 21 | 18.00 | 392.76 |
| asteroid500 | 442 | 26 | 43 | 17.00 | 180.60 |
| asteroid1k | 950 | 72 | 88 | 13.19 | 191.00 |
| asteroid2.5k | 2418 | 188 | 208 | 12.86 | 199.72 |
| asteroid5k | 4840 | 355 | 405 | 13.63 | 199.76 |
| asteroid10k | 9828 | 762 | 808 | 12.90 | 200.94 |
| asteroid20k | 19800 | 1535 | 1605 | 12.90 | 204.48 |
| asteroid40k | 39624 | 3047 | 3204 | 13.00 | 197.92 |
| asteroid60k | 59592 | 4653 | 4784 | 12.81 | 198.16 |
| asteroid80k | 79560 | 6217 | 6365 | 12.80 | 197.16 |
| asteroid100k | 99294 | 7802 | 7965 | 12.73 | 197.08 |
| asteroid200k | 198930 | 15595 | 15923 | 12.76 | 194.98 |

Comparing with FTSG

- FTSG is a leading (non-neural) practical program providing the stripifications **online** within a few tens of milliseconds (Xiang,Held,Mitchell,1999)
- FTSG v.1.31 was run with its most successful options
- HTGEN performed **30 trials** from which the best stripifications were chosen (anyway the best and average results do not differ much)

| Model | Number of Triangles | HTGEN (30 Trials) | | | | FTSG | |
|-------------|---------------------|-------------------|-----------|--------------------------|------------------------|-----------|---------------------|
| | | ϵ | $T^{(0)}$ | Best Number of Tristrips | Average Comp. Time (s) | Options | Number of Tristrips |
| shuttle | 616 | 0.12 | 17 | 95 | 2.70 | -dfs -alt | 145 |
| f-16 | 4592 | 0.6 | 26 | 312 | 197.57 | -dfs -alt | 478 |
| triceratops | 5660 | 0.2 | 20 | 557 | 286.33 | -bfs | 960 |
| lung | 6076 | 0.14 | 19 | 613 | 428.03 | | 857 |
| cessna | 7446 | 0.5 | 19 | 1249 | 241.17 | -dfs -alt | 1459 |
| bunny | 69451 | 0.7 | 23 | 4404 | 4129.93 | -dfs -alt | 6191 |

→ *HTGEN provides much better results than FTSG although the running time of HTGEN grows rapidly when the global optimum is being approached*

Graphical Comparison

HTGEN: F-16 Model, 312 tristrrips



FTSG: F-16 Model, 478 tristrrips



HTGEN: Triceratops Model, 557 tristrrips



FTSG: Triceratops Model, 960 tristrrips

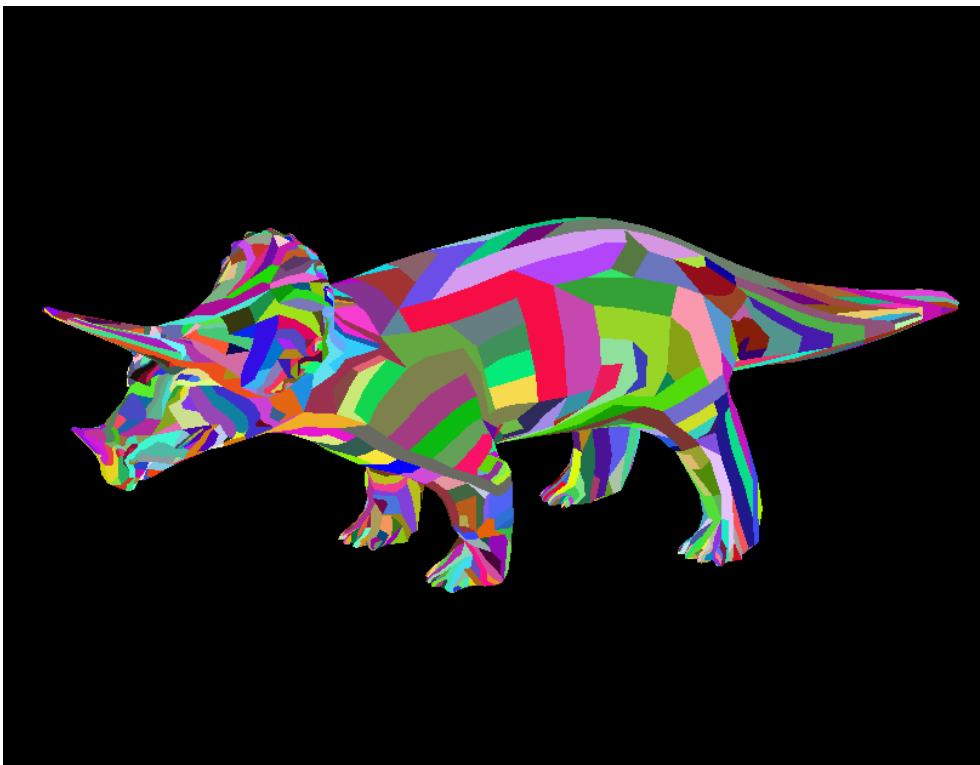

Huge Models

- HTGEN was tested on huge models with **hundreds of thousands of triangles**
- simulation **parameters**: 3 trials, $\varepsilon = 0.3$, $T^{(0)} = 10$
- e.g. FTSG generates **133072 tristrips** for the **dragon** model within **7 seconds**

| Model | Number of Triangles | Best Number of Tristrips | Average Comp. Time | Average Macro. Time | Memory Usage |
|--------------|---------------------|--------------------------|--------------------|---------------------|--------------|
| asteroid300k | 299600 | 29702 | 32min 56s | 147.33 | 139 MB |
| dragon | 871414 | 130106 | 4h 25min 50s | 235.00 | 390 MB |

—→ *HTGEN generates the stripifications even for huge models in doable time frame*

Conclusion

- a new heuristic method for generating tristrips, which represents an **important problem in computer graphics**
- the **reduction** to the minimum energy problem in Hopfield networks (a **one-to-one correspondence**)
- a **theoretically** interesting relation between two combinatorial problems of different types
- the method is **practically applicable** since the Hopfield net has only a linear number of units and connections
- **program HTGEN** can generate much smaller numbers of tristrips than those obtained by the leading conventional real-time program FTSG
- HTGEN exhibits **empirical linear time complexity** for fixed parameters of simulated annealing although the running time grows rapidly near the global optimum

→ *HTGEN can be used **offline** for generating **almost optimal** stripifications*

Open Problems

- a **rigorous approximation** stripification algorithm with a high performance guarantee
- a **generalization** of HTGEN for sequential strips with **zero-area** triangles, e.g. (1,2,3,2,4,5)