



3rd Annual Conference of COST Action MP1204

&

**6th International Conference on
Semiconductor Mid-IR Materials and Optics
SMMO2015**

Book of Abstracts



Institute of Photonics and Electronics
The Czech Academy of Sciences
Prague, Czech Republic

April 8 - 11, 2015

ORGANIZERS

Institute of Photonics and Electronics, The Czech Academy of Sciences

&

COST Action MP1204,
TERA-MIR Radiation: Materials, Generation, Detection and Applications.

CONFERENCE CHAIR

Mauro Pereira (United Kingdom)

CONFERENCE CO-CHAIRS

Pavel Honzátko (Czech Republic),

Marian Marciniak (Poland),

Maciej Bugajski (Poland).

PROGRAMME COMMITTEE

Filip Todorov (Czech Republic),

Pavel Peterka (Czech Republic),

Eduard Hulicius (Czech Republic),

Mauro Pereira (United Kingdom),

Anna Wójcik-Jedlińska (Poland),

Emilia Pruszyńska-Karbownik (Poland),

Antoine Muller (Switzerland),

Andreas Wacker (Sweden),

Ivan Buchvarov (Bulgaria),

Johan Stiens (Belgium),

Florin Mihailescu (Romania),

Czesław Skierbiszewski (Poland),

Shumin Wang (Sweden).

CONFERENCE WEBSITE

www.ufe.cz/smмо2015

Wednesday, April 8

09:00-09:30 Registration

09:30-10:00 Opening Remarks

10:00-10:30 ● **Roberto Morandotti** 9
Novel THz Applications from Bio-imaging to Signal Processing

10:30-11:00 ● **Anna Sitek**..... 10
Corner-induced electron distribution and optical absorption in polygonal nanorings

11:00-11:30 Coffee Break

11:30-12:00 ● **Hynek Němec**..... 11
Transient Terahertz Conductivity in Nanoscaled Systems

12:00-12:20 ○ **Irina Khromova** 12
Measuring terahertz conductivity of resonant carbon microfibers through aperture-based near-field spectroscopy

12:20-12:40 ○ **Filipa R. Prudêncio** 13
One-Way Propagation of Light with Topological Insulators

12:40-13:00 ○ **Mateusz Dyksik** 14
Fast Differential Reflectance as a quantitative method of carrier concentration determination in the infrared device structure

13:00-14:30 Lunch Time

14:30-15:00 ● **Christelle Kadlec** 15
Dielectric Metamaterials for the Terahertz Range

15:00-15:20 ○ **Cumali Sabah** 16
Fishnet Based Metamaterial Loaded THz Patch Antenna

15:20-15:40 ○ **Markku Vainio** 17
Mid-Infrared Frequency Comb Generation by Cascaded Quadratic Optical Nonlinearities

15:40-16:00 ○ **Kerstin Mader** 18
Mid-infrared Microscopic Imaging for the Characterisation of Intervertebral discs

16:00-16:30 Coffee Break

16:30-18:00 **POSTER SESSION**..... 6

-
- invited talks
 - contributed talks

Thursday, April 9

09:00-09:30 Registration

- 09:30-10:00 ● **Gaetano Scamarcio** 19
Optical feedback interferometry in THz quantum cascade lasers:
free carrier imaging and optical metamaterial response
- 10:00-10:30 ● **Miriam Serena Vitiello** 20
Photonic engineering of THz quantum cascade resonators
- 10:30-11:00 ● **Anna Szerling** 21
Processing of AlGaAs/GaAs and InGaAs/InAlAs/InP
semiconductor structures for QC lasers

11:00-11:30 Coffee Break

- 11:30-12:00 ● **Marcin Motyka** 22
On the active region improvement in interband cascade lasers
- 12:00-12:20 ○ **Maciej Bugajski** 23
High temperature operation of InGaAs/AlGaAs/GaAs quantum
cascade lasers
- 12:20-12:40 ○ **Emilia Pruszyńska-Karbownik** 24
Hybrid modes of mid-infrared double trench quantum cascade
lasers
- 12:40-13:00 ○ **Sarah Houver** 25
Optical sideband generation with mid-infrared quantum cascade
lasers up to room temperature

13:00-14:30 Lunch Time

- 14:30-15:00 ● **Tomasz Czystanowski** 26
Monolithic subwavelength high-index-contrast grating VCSEL
- 15:00-15:20 ○ **Artur Broda** 27
Experimental investigation on multi-wavelengths generation in
Vertical External Cavity Surface-Emitting Laser
- 15:20-15:40 ○ **Marian Marciniak** 28
Optimal 1D microcavity for THz emission from optically
pumped GaP layer: numerical analysis
- 15:40-16:00 ○ **Traian Dascalu** 29
Intense THz pulses for THz pump – THz probe experiments

16:00-16:30 Coffee Break

16:30-16:50	○ Yauhen Baravets	30
	Comparison of tunable narrow-band CW mid-IR generators based on the difference frequency generation in KTP and KTA crystals	
16:50-17:10	○ Leonardo Viti	31
	THz detection in Topological Insulator Field Effect Transistor	
17:10-17:30	○ Vladimir Vaks	32
	Multifrequency high precise spectroscopy of biological tissues	
17:30-17:50	○ Mauro Pereira	33
	Progress in Microscopic Theory of TERA-MIR Semiconductor Materials and Optics	
19:00-23:00	<u>Conference Dinner</u>	

Friday, April 10

09:00-09:30 Registration

09:30-10:00	● Shumin Wang	36
	Recent progress on dilute bismide	
10:00-10:30	● Arūnas Krotkus	37
	Growth and characterization of dilute bismides for terahertz and laser applications	
10:30-10:50	○ Lutfi Ozyuzer	38
	Terahertz Wave Emission and Detection from Single Crystals of High Temperature Superconducting $\text{Bi}_2\text{Sr}_2\text{CaCu}_2\text{O}_{8+\delta}$	

10:50-11:20 Coffee Break

11:20-11:40	○ Teodor Milenov	39
	Deposition of graphene/ graphene-related phases on different substrates by thermal decomposition of acetone	
11:40-12:00	○ Feodor Kusmartsev	40
	The analogy and differences between Sub-Tera-Flux Flow Oscillator and Graphene, Semiconductor Superlattices	
12:00-12:20	○ Taylan Takan	41
	Graphene-enabled Electrically-Controlled Terahertz Light Modulators	
12:20-12:40	○ Lukáš Nádvořník	42
	Artificial graphene: a useful playground for THz spectroscopy?	
12:40-13:00	○ Florin Mihailescu	43
	Validation of molecules force field parameters using Terahertz spectroscopy	

13:00-14:30 Lunch Time

- 14:30-15:00 ● **Till Mohr** 44
Terahertz homodyne self-mixing: A new spectroscopic technique-
Basics and two-dimensional tomographic imaging applications
- 15:00-15:20 ○ **Antonello Andreone** 45
Dispersion of carbon nanotubes in melt compounded
polypropylene based composites investigated by THz
spectroscopy
- 15:20-15:40 ○ **Marian Janek** 46
THz-TDS investigation of dielectric properties of CaZrO₃
- 15:40-16:00 ○ **Á. Rubén Criado** 47
Photonic-based generation of ultra-pure THz radiation

16:00-16:30 Coffee Break

- 16:30-16:50 ○ **Vedat Ali Özkan** 48
Compressive Sensing Imaging and Image Fusion at sub-THz
frequency in Transmission Mode
- 16:50-17:10 ○ **Hakan Altan** 49
Detection of Far-Infrared Radiation using Glow Discharge
Detectors (GDDs)
- 17:10-17:30 ○ **Hakan Altan**..... 50
Rapid-Scan Fiber-Integrated Terahertz Spectrometer for Time-
Resolved Measurements
- 17:30-17:50 ○ **Oleg Mitrofanov** 51
Spectroscopy of Mie resonances in single TiO₂ microspheres

17:50-18:00 Closing Remarks

Saturday, April 11

09:00-09:30 Registration

09:30-11:00 COST Action MP1204 MC Meeting

11:00-11:30 Coffee Break

11:30-end COST Action MP1204 MC Meeting

List of Posters

P01	Filip Kadlec	53
	Achieving a negative refractive index in arrays of dielectric rods	
P02	Piotr I. Karbownik	54
	Mirror coatings for InGaAs/InAlAs/InP mid-IR QCL	
P03	Albert Ratajczak	55
	Optimization of MBE growth of InSb on semi-insulating GaAs substrate for mid-wavelength infrared detectors	
P04	Yasemin Demirhan	56
	A comparative study of ITO, Ti and Cu metal mesh resonant filters for THz applications	
P05	Krzysztof Czuba	57
	High temperature operation of Mid-IR type-II InAs/GaSb superlattice photodiodes	
P06	Hakan Alaboz	58
	High TCR DC Sputtered VO _x Films for THz Bolometer Applications	
P07	Asaf Şahin	59
	Varying Temperature Surface Reflection and its Effect on the Indoor Terahertz Wireless Communications	
P08	Jarosław Jureńczyk	60
	Selected processing aspects of MWIR detectors based on antimonide type II superlattices	
P09	Jelena Radovanovic	61
	Influence of Carrier Diffusion on RNGH Instabilities in Semiconductor Lasers	
P10	Michał Kozub	62
	Spectroscopic characterization of highly Si-doped InAs layers in terahertz emitters	
P11	Andres Udál	63
	Development of the software tools for simulation of quantum well media for radiation amplification in MIR and THz regions	

P12	Dominika Urbańczyk	64
	Optical investigation of high contrast grating fabricated by focused-ion beam process	
P13	Lilian Sirbu	65
	LT-InP Film for Ewod Technology for THz Applications	
P14	Jakub Cajzl	66
	Characterization and numerical modelling of holmium-doped optical fibers for fiber lasers at 2.1 μm	
P15	Eduard Hulicius	67
	AlSb/InAs _(1-x) Sb _x /AlSb quantum wells used for the high temperature superlinear luminescence in the Near-Mid infrared region	
P16	Marco Ribeiro	68
	Electro-Mechanical Analysis of a THz Wireless Sensor for Structural Health Monitoring	
P17	Mariusz Pluska	69
	Focused Ion Beam (FIB) Post-Processing Impact on Properties of Coupled-Cavity Quantum Cascade Laser Structures	
P18	Mariusz Pluska	70
	Cathodoluminescence Studies and Focused Ion Beam (FIB) processing of photonic structures	
P19	Helena Jelínková	71
	Fe:ZnSe and Dy:PbGa ₂ S ₄ lasers generating radiation in the 4-5 μm spectral region	
P20	Michal Jelínek	72
	Cr:ZnSe laser generating at 2.3 μm pumped by Tm-fiber 1.94 μm laser	
P21	Olga Diabina	73
	Criogenic effects on cancer stem cells - can we monitor and manipulate them with THz radiation?	

PLENARY TALKS

Novel THz Applications from Bio-imaging to Signal Processing

A. Mazhorova, M. Clerici, R. Naccache, M. K. Mridha, L. Razzari, F. Vetrone
and R. Morandotti

SIS/MI6, Vauxhall Cross, London SE1 1B, UK

¹*INRS-EMT, 1650, Blvd. Lionel-Boulet, Varennes, Quebec JSX 1S2, Canada*

³*School of Engineering&Physical Sciences, Heriot Watt University, Edinburgh EH14 4AS, UK*
morandotti@emt.inrs.ca

During the past decade, various Terahertz technologies were successfully implemented in THz sensing and imaging for chemical, biological, biomedical and other interdisciplinary study. We demonstrate an active two-wire waveguide by generating a THz electric field directly within the guiding structure. By integrating a polymer Bragg grating with the two-wire waveguide, we demonstrate efficient THz frequency filtering with a notch of 23 dB and a linewidth of 16 GHz [1]. Such a combination of active wave guiding and frequency filtering may open up new perspectives for generating THz pulses with desired pulse shapes and spectra while making the proposed configuration extremely versatile.

Furthermore, the rapid ascent of nanoscience has garnered significant attention in recent years. Much of the interest generated has dealt with the use of Gold Nanorods (GNRs) in imaging and therapeutics. GNRs show a surface plasmon resonance (SPR) following the excitation with an appropriate irradiation source. A fascinating by-product of SPRs is a localized temperature increase, which can be used to heat the interstitial waters and induce hyperthermia in cells. We study the use of THz waves for temperature sensing and imaging in vitro, given the sensitivity of the THz waves to changes in the absorption and the refractive indices of water and other aqueous media. We have shown that THz waves can be used for temperature sensing in the biological temperature window of 25-60 °C (Fig. 1). Combined with sensitive imaging capacities, and localized plasmonic heating, the proposed technique can be further extended to applications in skin cancer therapy.

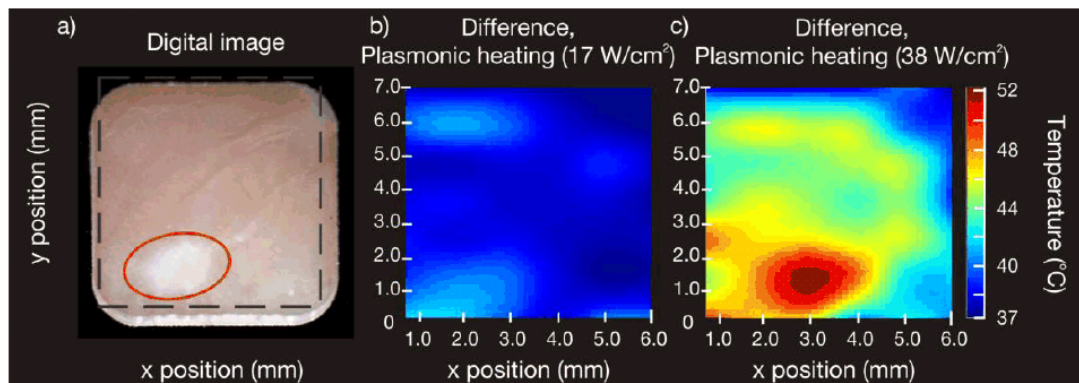

Fig. 1. Terahertz reflection map of (a) digital image photograph of the actual sample of pig skin injected with GNRs. The red ellipse marks the injection site in the skin while the dashed lines mark the imaged area, (b) thermal image map obtained following image subtraction showing a 7 °C localized temperature rise at the injection site (17 W/cm² power density) and (c) thermal image map obtained following image subtraction showing a 16 °C localized temperature rise at the injection site (38 W/cm² power density).

References

[1] M. K. Mridha, A. Mazhorova, M. Clerici, I. Al-Naib, M. Daneau, X. Ropagnol, M. Peccianti, C. Reimer, M. Ferrera, L. Razzari, F. Vidal and R. Morandotti “Active terahertz two-wire waveguides,” *Opt. Express*, **22**, 22340-22348 (2014)

Corner-induced electron distribution and optical absorption in polygonal nanorings

Anna Sitek^{1,2}, Vidar Guðmundsson¹, and Andrei Manolescu³

1. Science Institute, University of Iceland, Dunhaga 3, IS-107 Reykjavik, Iceland
2. Department of Theoretical Physics, Wrocław University of Technology, Wybrzeże Wyspiańskiego 27, 50-370 Wrocław, Poland
3. School of Science and Engineering, Reykjavik University, Menntavegur 1, IS-101 Reykjavik, Iceland

We present a theoretical study of polygonal nanorings which experimentally correspond to short core-shell nanowires. We show how the geometry of the ring determines the electronic energy spectrum, and also the localization of wave functions within the rings, with consequences on the optical absorption. We analyse symmetric rings with sharp or soft corners, as well as non-symmetric rings. Regular polygonal samples induce multiple degeneracies depending on the number of corners, whereas the states of non-symmetric samples are usually only spin degenerated. The corners always attract the lowest-energy electrons such that for every ring a number of states equal to twice the number of corners is localized only within corner areas. Higher energy states may be completely localized over the side areas or distributed between sides and corners. Interesting features occur for samples with smooth corners which allow more complex localization effects. For example, in such a triangular ring one can obtain three localization peaks within the corner areas corresponding to the lowest energy levels which split into six peaks still localized at the corners for a higher energy. In order to make connections with possible experiments we calculate the optical absorption coefficient, which is governed by dipole elements dependent on wave functions. We show that optical absorption strongly depends on the sample geometry combined with the light polarization. We also show how the transitions can be controlled by an external electric field which not only changes absorption intensity but also 'opens' some and 'closes' other transitions.

The author acknowledges support from MPNS COST ACTION MP1204 - TERA-MIR Radiation: Materials, Generation, Detection and Applications.

Transient Terahertz Conductivity in Nanoscaled Systems

Hynek Němec and Petr Kužel

*Institute of Physics, The Czech Academy of Sciences, Na Slovance 2, Prague, Czech Republic
nemec@fzu.cz*

Ultrafast photoconductivity and charge carrier transport in nanostructured semiconductors is poorly understood on the microscopic level in many systems. Terahertz spectroscopy constitutes a suitable method to probe nanoscopic motion of charges with a sub-picosecond time resolution and without need to deposit electrical contacts. However, straightforward fitting of the raw terahertz conductivity spectra by the Drude-Smith model, which was abundantly used in the literature, did not lead to a significant advance in an in-depth understanding of these phenomena. Instead, two major effects need to be accounted for in the analysis of measured terahertz conductivity spectra: (i) interaction of mobile charges with nanoparticles boundary, and (ii) screening of the incident terahertz pulse by depolarization fields. In this contribution, we will discuss the microscopic description of these processes. The response of charges to the local electric field is calculated by Monte-Carlo simulations of quasi-classical carrier thermal motion [1] which involve parameters like nanoparticle size or coupling between nanoparticles. The depolarization fields are accounted for using effective medium approximation: we show that for most nanostructures only the percolation degree is important whereas further details of the morphology play only a minor role [2].

We will demonstrate the power of terahertz spectroscopy by investigations of various materials, which include Si nanocrystals prepared by thermal decomposition of Si-rich layers (Fig. 1), MOVPE-grown InP nanowires, or Si nanocrystals prepared by electrochemical etching of silicon wafer [3]. In the analysis, the scaling of the effective conductivity with excitation intensity provides information on the percolation degree whereas parameters of charge transport can be determined from the spectrum at the low excitation intensities.

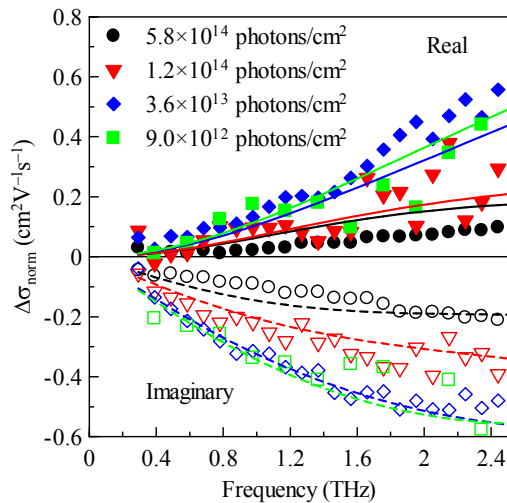

Figure 1: Silicon nanocrystals prepared by thermal decomposition of $\text{SiO}_2/\text{SiO}_{0.64}$ superlattices: spectra of effective transient conductivity normalized by charge density [$\Delta\sigma_{\text{norm}} = \Delta\sigma/(e_0n_{\text{exc}})$; $\Delta\sigma$ is effective transient conductivity, n_{exc} is excitation density]. The decrease of $\Delta\sigma_{\text{norm}}$ with increasing excitation intensity shows that the nanocrystals do not form a long-range percolation network. The pronounced increase of the real part with frequency is incompatible with the 3.5-nm average size of nanocrystals observed in TEM images, but it points out to the existence of 40-nm sized mutually isolated clusters of nanocrystals. Symbols: measured data; lines: global fit with three adjustable parameters (cluster size, fraction of nanocrystals in clusters, and percolation strength).

References

- [1] H. Němec et al., Phys. Rev. B **79**, 115309 (2009)
- [2] H. Němec et al., IEEE T. THz. Science Technol. **3**, 302 (2013).
- [3] C. S. Ponseca et al., Phys. Rev. B **90**, 085405 (2014); V. Zajac et al., New J. Phys **16**, 093013 (2014); H. Němec et al., *Charge transport in silicon nanocrystal superlattices in the terahertz regime*, submitted to Phys. Rev. B.

Measuring terahertz conductivity of resonant carbon microfibers through aperture-based near-field spectroscopy

I. Khromova¹, O. Mitrofanov¹, M. Navarro-Cia^{1,2}, I. Brener³, J. Reno³, A. Ponomarev⁴

¹ University College London, London, UK

² Imperial College London, London, UK

³ Sandia National Laboratory, Albuquerque, USA

⁴ STC of Applied Nanotechnologies, St. Petersburg, Russia

i.khromova@ucl.ac.uk

Carbon micro- and nanostructures are promising building blocks for functional terahertz (THz) materials [1,2]. We performed near-field time-domain spectroscopy on individual carbon microfibres (CMFs) to verify the presence of strong plasmonic resonances at THz frequencies. These plasma-chemically treated microfibres are 7 μm in diameter and their lengths vary from 10 μm to 150 μm . Fig.1 shows: (a) a SEM image of the CMFs, and (b) a space-time THz near-field map and (c) an image of a 133 μm -long CMF.

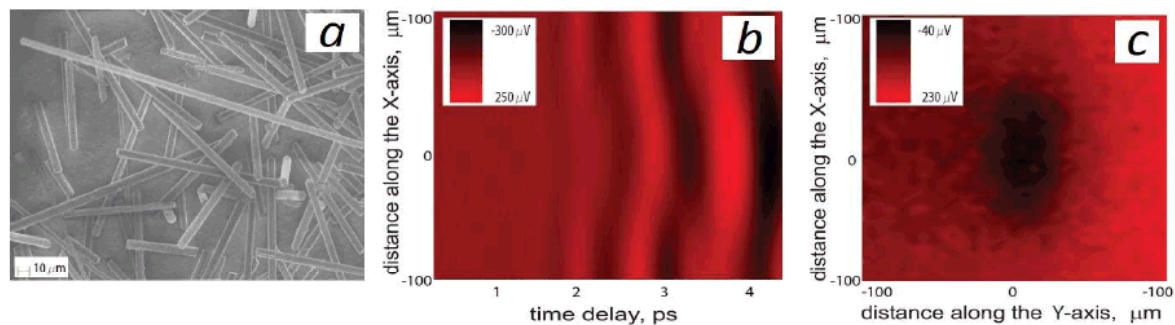

We observed a strong dependence of the resonant field enhancement on the distance to the subwavelength aperture of the THz detector. It allowed us to extract information about the THz conductivity of the measured CMFs. Its value lies very close to the condition of maximum absorption to scattering relation (appr. 10^4 S).

We used semi-analytical models to predict the usability of CMFs for efficient THz absorbers with engineerable response. Combining the effective medium approximation with a simple dipole antenna model, we numerically obtained scattering and absorption characteristics of composites containing CMFs with given lengths distributions.

We experimentally studied the THz response of thin pellets of high density polyethylene (HDPE) with arbitrarily oriented and differently sized CMF inclusions. These samples demonstrated a clearly resonant behaviour: broad absorption peaks at around 1.5 THz indicate the presence of size effects distributed over lengths of CMFs in each sample. With artificially created distribution of lengths, CMF-based composites may be designed according to desirable absorption profiles. This simple and inexpensive technique may, in particular, be used to achieve flat absorption at THz frequencies.

References

- [1] R. R. Hartmann, J. Kono, and M. E. Portnoi, *Nanotechnology* 25, 322001 (2014).
- [2] F. Qin and C. Brosseau, *J. Appl. Phys.*, 111, 061301 (2012).

One-Way Propagation of Light with Topological Insulators

Filipa R. Prudêncio^{1*}, and Mário G. Silveirinha²

¹*Instituto Superior Técnico, Instituto de Telecomunicações, Av. Rovisco Pais, 1049-001, Lisboa, Portugal, filipa.prudencio@lx.it.pt*

²*Universidade de Coimbra, Instituto de Telecomunicações, 3030-290, Coimbra, Portugal, mario.silveirinha@co.it.pt*

The "one-way" propagation of light is usually achieved with the help of either ferrites biased with an external applied magnetic field [1] or with nonlinear elements. This effect has important applications in the realization of optical isolators and generally requires a broken time-reversal symmetry [1]. In this work, we theoretically propose a new paradigm for optical isolation with a truncated photonic crystal formed by nonreciprocal topological insulators [2] combined with a reciprocal chiral slab [see Fig. 1a]. Importantly, antiferromagnetic topological insulators may naturally break the time-reversal symmetry and thus a nonreciprocal response may be obtained without any form of external biasing [2]. As seen in Fig. 1b, by combining nonreciprocal elements modeled by the magneto-electric parameter $\kappa = 0.2$ [3] and a chiral slab [4] it may be possible to have a nearly perfect optical isolation, such that for $\omega l / c \approx 3.41$ the wave propagation is only allowed for right circularly polarized (RCP) incoming waves propagating along the $+z$ -direction, while it is strongly suppressed for all right-to-left incoming waves.

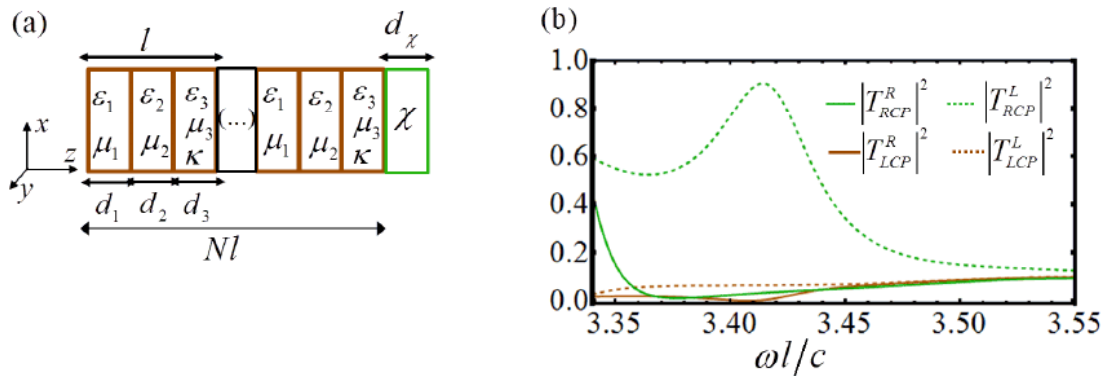

Figure 1 (a) Truncated nonreciprocal photonic crystal juxtaposed to a chiral slab. (b) Transmissivity as a function of the normalized frequency for an incoming circularly polarized plane wave. The superscript R (L) indicates that the incoming wave propagates from the right to the left (left to the right), whereas the subscript RCP (LCP) indicates if the wave is right (left) circularly polarized. The constitutive parameters are taken equal to $\epsilon_1 = \mu_1 = \mu_2 = \mu_3 = 1$, $\epsilon_2 = 6$, $\epsilon_3 = 8$ and $\kappa = 0.2$, and the thicknesses are chosen as $d_1 = d_2 = 0.2l$, $d_3 = 0.6l$ and $d_\chi = l$. The truncated crystal is formed by $N = 8$ cells.

References

- [1] A. Figotin and I. Vitebsky, Phys. Rev. E, vol. 63, pp. 066609, (2001).
- [2] R. S. K. Mong, A. M. Essin and J. E. Moore, Phys. Rev. B, vol. 81, pp. 245209, (2010).
- [3] F. R. Prudêncio, S. A. Matos and C. R. Paiva, IEEE Trans. Microw. Theory Techn., vol. 62, no. 7, pp. 1417-1428, (2014).
- [4] R. Zhao, T. Koschny and C. M. Soukoulis, Opt. Express, vol. 18, no. 14 pp. 14553-14567, (2010).

The author acknowledges support from MPNS COST ACTION MP1204 - TERA-MIR Radiation: Materials, Generation, Detection and Applications.

Fast Differential Reflectance as a quantitative method of carrier concentration determination in the infrared device structure

M. Dyksik¹, M. Motyka¹, G. Sęk¹, F. Janiak¹, J. Misiewicz¹,
M. Dallner², S. Höfling², M. Kamp²

¹Department of Experimental Physics, Wrocław University of Technology, Wybrzeże
Wyspianskiego 27, 50-370 Wrocław, Poland

²Technische Physik, Physikalisches Institut, Universität Würzburg, Am Hubland, D-97074
Würzburg, Germany

During the last years mid-infrared semiconductor lasers have continuously increased their application range, including gas sensing for detection and control of the presence and concentration of harmful gases like CO₂, SO_x and NH₃. The so-called interband cascade lasers (ICLs) based on GaSb are able to cover spectral ranges between 2 and 6 μm. In order to extend the region of interest to longer wavelengths indium arsenide substrates are required [1]. Furthermore, a InAs/AlSb superlattice cladding region, based on index-guiding method, well-liked in GaSb-ICLs, is no longer suitable due to stronger absorption in mid and far-infrared, thus it is replaced by a highly doped InAs layer. This plasmon-enhanced waveguide approach reduces cladding thickness that leads to enhanced heat dissipation and shorter growth time. In order to precisely control and optimize the doping of the cladding layers to minimize the threshold gain of ICLs, it is very helpful to have a measurement method of the carrier concentration. It has been already reported that by means of reflectance measurements the identification of a minimum in the spectrum near the plasma frequency, i.e. the so-called plasma-edge, allows for the estimation of carrier concentration through the Berreman effect [2]. Although this method provides a dielectric response in a quantitative manner, it is generally difficult to analyze the spectra if the structure is multi-layered. A novel approach to carrier concentration's determination is fast differential reflectivity (FDR) [3].

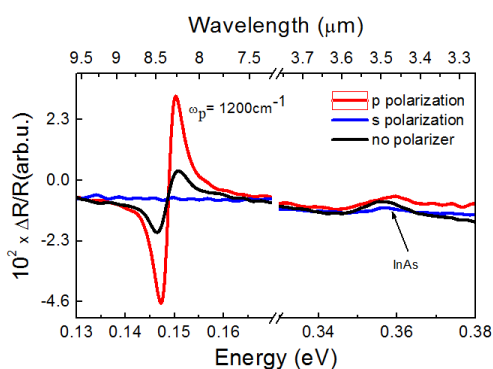

Due to its differential nature, this technique is sensitive to various optical transitions and singularities in the dielectric response and eliminates background signals related to the material features and set-up characteristic. The standard reflectance approach involves measurement of two orthogonal polarizations, *p* and *s*, in order to precisely locate the plasma-edge in vastly reach spectrum, whilst FDR technique provides direct information through

resonance corresponding to a Berreman minimum. As a result, there is no polarizer requirement. Furthermore, FDR is a non-destructive technique with average measurement time as short as 1 min, which makes it suitable for in-situ measurements or industrial scale testing. FDR measurements were performed on a set of samples, including highly doped InAs layers and ICL structures, employing an FTIR-spectrometer-based setup. The figure presents exemplary polarization-resolved FDR spectra. A feature corresponding to indium arsenide fundamental energy gap is observed, while the line at around 1200 cm⁻¹ is to be understood as the plasma-edge.

[1] Z. Tian et al., Electronics Letters **48** (2012)

[2] R. T. Hinkey et al., Journal of Applied Physics **110**, 043113 (2011)

[3] M. Motyka et al., Appl. Phys. Express **3**, 112401 (2010)

Acknowledgements: Work performed within WideLase Project No. 318798 of EC 7th Framework Programme. M.D. would also like to acknowledge COST Action MP1204.

Dielectric Metamaterials for the Terahertz Range

C. Kadlec, H. Němec, F. Dominec, F. Kadlec, V. Skoromets and P. Kužel
Institute of Physics, AS CR v.v.i., Na Slovance 2, Prague 8, Czech Republic
kadlecch@fzu.cz

Metamaterials (MMs) are man-made structures exhibiting electromagnetic properties not found in nature, such as negative indices of refraction. Realization of MM operating at terahertz (THz) frequencies has been an issue for the last few years. In our work, we focus on dielectric MMs.

In high-permittivity materials such as SrTiO₃ rods [1] and TiO₂ microspheres [2], a negative effective permeability related to Mie resonances can be reached in the THz range. Usually the comparison of the THz transmission spectra with the simulated MM response of the structure is considered as a sufficient proof of their MM behavior. We will present an alternative experimental method permitting to retrieve both the effective permittivity and permeability of a dielectric MM. We place a thin layer of the MM between two thick sapphire slabs. The shape of the THz pulses passing directly through the structure enables us to evaluate the complex transmittance of the MM while the delayed one, coming from reflections on the sapphire/MM interfaces, also includes information about the reflectance of the MM. Thanks to this approach we are able to simultaneously measure the complex transmittance and reflectance of a thin layer of dielectric MM. Its effective permittivity and permeability can then be retrieved using the procedure described in [3].

We will also introduce our progress in realizing tunable MMs for the THz range. Our approach relies on SrTiO₃ thin films epitaxially grown on DyScO₃ substrates. Thanks to the tensile strain induced by the lattice mismatch with the substrate, the ferroelectric phase transition in SrTiO₃ thin films occurs near room temperature (RT). Thus, the electric tunability of these films is highly enhanced compared to that of bulk SrTiO₃ [4,5]. On top of them, we plan to deposit sub-wavelength structures designed to exhibit a MM resonance in the THz range and to enable tuning of the film properties by applied electric field.

References

- [1] H. Němec et al., Phys. Rev. B **79**, 24 1108(R) (2009).
- [2] H. Němec et al., Appl. Phys. Lett. **100**, 06 1117 (2012).
- [3] D. R. Smith et al., Phys. Rev. B **65**, 195104 (2002).
- [4] C. Kadlec et al., Phys. Rev. B **80**, 17 4116 (2009).
- [5] V. Skoromets et al., Phys. Rev. B **89**, 214116 (2014).

The authors acknowledge the support of the Czech Science Foundation under the Grant No. 14-25639S.

Fishnet Based Metamaterial Loaded THz Patch Antenna

Y. Denizhan Sirmaci, Cagdas K. Akin, Cumali Sabah

Middle East Technical University - Northern Cyprus Campus, Department of Electrical and Electronics Engineering, Kalkanli, Guzelyurt, TRNC / Mersin 10, Turkey

sabah@metu.edu.tr

In this paper, a high gain and broadband rectangular patch antenna using coupled fishnet based metamaterial (MTM) topology for THz frequencies is analyzed. Based on a classical patch antenna, a planar left-handed MTM is used as a ground plane in the proposed design [1] [2]. The simulations have been done by a 3D electromagnetic simulator based on finite integration technique. Fig. 1 shows the structure with its dimensions. The metallic parts are assigned as silver with a thickness of 5 μm and they are placed on top and bottom sides of a quartz substrate with a thickness of 10 μm . The directivity and gain are found as 6.57 dB and 3.78 dB, respectively. Since the increased carrier frequency promises higher data rates and channel capacity, the next generation communication systems will possibly focus on THz region. Therefore, the proposed design (antenna with MTM) can find a place in new generation wireless THz and satellite communication systems [3]. Simulation results for the return loss (S_{11}) and far field gain of proposed antenna are shown in Figs. 2 and 3, respectively. According to the return loss, the main resonance occurs at 1.088 THz with -57.391dB and VSWR of 1.003. It can be inferred from the results that proposed antenna provides ultra-wide bandwidth as seen from the results.

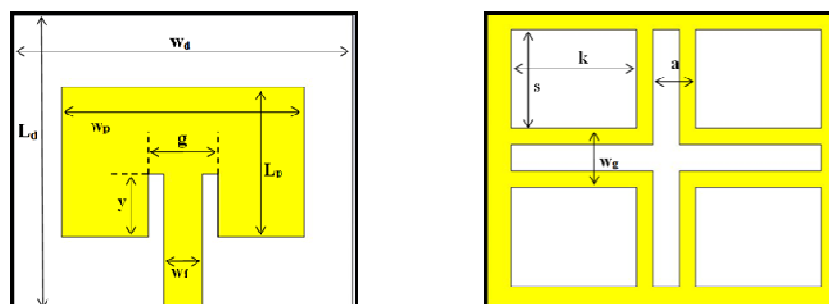

Fig. 1. The proposed structure with dimensions (front and back respectively), $w_d=212$, $l_d=180$, $w_p=152$, $l_p=92$, $g=10$, $y=39$, $w_f=24$, $k=82$, $s=66$, $w_g=43.5$, $a=29.5$.

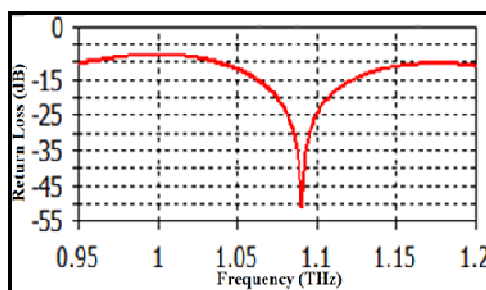

Fig. 2. Return loss versus frequency

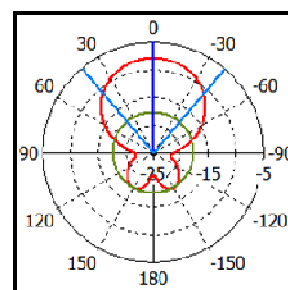

Fig. 3. Far field gain

References

- [1] Han Xiong, Jing-Song Hong, Yue-Hong Peng, Radio Engineering Vol. 21, No. 4 (2012).
- [2] E. Dogan, E. Unal, D. Kapusuz, M. Karaaslan, C. Sabah, Applied Computational Electromagnetics Society Vol. 18, No. 21, (2013).
- [3] S. Koenig, W. Freude, J. Leuthold, I. Kallfass, Nature Photonics 7, 977-981 (2013).

Mid-Infrared Frequency Comb Generation by Cascaded Quadratic Optical Nonlinearities

M. Vainio^{1,2}, C.R. Phillips³, V. Ulvila¹, and L. Halonen¹

¹Laboratory of Physical Chemistry, Department of Chemistry, University of Helsinki, Finland

²VTT Technical Research Centre of Finland Ltd, Centre for Metrology MIKES, Finland

³ETH Zürich, Ultrafast Laser Physics, Zürich, Switzerland

markku.vainio@helsinki.fi

An optical frequency comb (OFC) generator emits coherent broadband light, whose spectrum consists of a large number of discrete, equidistant lines. Mid-infrared OFCs are needed especially in molecular spectroscopy [1].

In our conference contribution, we discuss a new versatile method for mid-infrared OFC generation. This method, which is called CASCHI comb, is based on cascaded quadratic nonlinearities (CQNs) in a nonlinear optical crystal, such as lithium niobate or gallium arsenide [2]. These CQNs mimic third order optical nonlinear effects, hence leading to effective four-wave mixing and frequency comb formation when pumped with a continuous-wave (cw) laser. Our solution utilizes a cw-pumped optical parametric oscillator, which inherently transfers the OFC from near-infrared to the mid-infrared region [2]. Figure 1 shows example spectra of our tunable mid-infrared OFC generator. The total output power is several watts, and the power per comb mode is record high, ~ 1 mW.

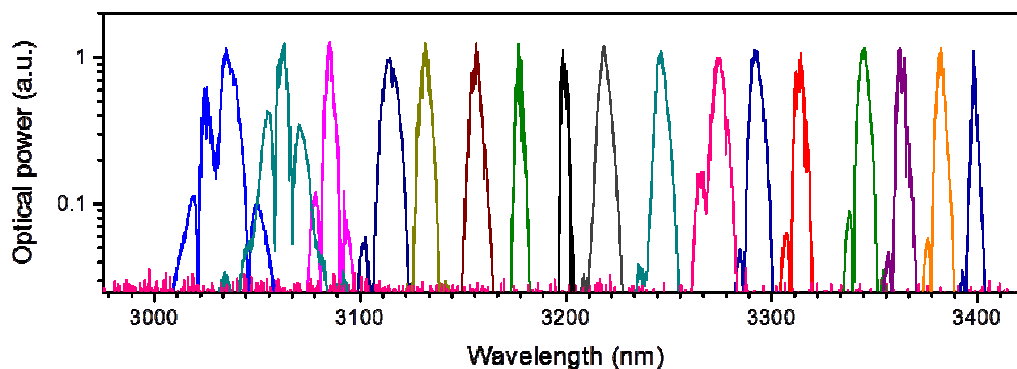

Fig. 1. Tuning of the CASCHI comb from 3 to 3.4 μm . Only the envelope spectra are shown – the spectra actually consist of equidistant laser lines, the line spacing being 208 MHz.

References

- [1] A. Schliesser, N. Picqué, and T.W. Hänsch, Nat. Photonics 6, 440 (2012)
- [2] V. Ulvila, C. R. Phillips, L. Halonen, and M. Vainio, Opt. Express, 22, 10535 (2014).

The authors acknowledge support from MPNS COST ACTION MP1204 - TERA-MIR Radiation: Materials, Generation, Detection and Applications.

Mid-infrared Microscopic Imaging for the Characterisation of Intervertebral discs

K.T. Mader¹, C.L. Le Maitre², C. Sammon¹

1. *Sheffield Hallam University, Materials and Engineering Research Institute, Howard St, Sheffield, S1 1WB, UK*
2. *Sheffield Hallam University, Biomedical Research Centre, Howard St, Sheffield, S1 1WB, UK.*
K.Mader@shu.ac.uk

Lower back pain affects millions of people worldwide, and has been linked to degenerative changes in the intervertebral disc (IVD) of the spine. In the ‘NPmimetic’ project, a multidisciplinary team has come together to develop a biomimetic nano-polymer based gel for minimally invasive disc regeneration (<http://npmimetic.com/>). An IVD is a chemically and structurally very complex tissue. It consists primarily of a proteoglycan-water gel embedded in a randomly arranged collagen II network, surrounded by highly ordered concentric collagen I lamella. For a successful regeneration, tissue integrity together with the right mechanical environment is essential for normal cell function. In order to develop suitable biomimetic implants, a thorough characterisation profile, that can be used as an aspirational target is important. In this study we use FTIR microscopic imaging in transfection mode to generate infrared images of unstained paraffin embedded transverse cross-sections (~2.8 x 2.3 cm) of control and in vivo CABC degenerated goat IVDs [1]. While mid-infrared images hold very detailed intra- and intermolecular information, a major challenge is handling and analysing such large and chemically complex data sets in order to extract meaningful information. Using a multivariate curve resolution-alternating least squares algorithm (MCR-ALS, [2]) on a reduced data matrix derived from principal component analysis (PCA) of 2nd derivative infrared spectra, it is possible to deconvolute the highly overlapped infrared peaks into single contributions of different molecular species at each pixel of the image.

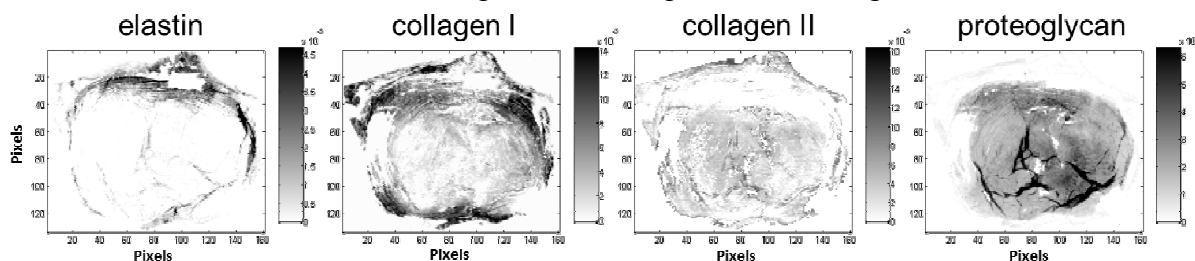

Figure 1: Extracted Mid-infrared distribution maps of major matrix components of an IVD.

Here we describe the application of FTIR imaging with multivariate data analysis to determine the structure of healthy and diseased IVDs, providing a more cost effective solution to traditional (immuno)-histological staining methods typically employed.

We thank the European Union (NPMIMETIC ref 246351) for 7th Framework Programme funding, and MPNS COST ACTION MP1204 - TERA-MIR Radiation: Materials, Generation, Detection and Applications for their support.

References

- [1] Hoogendoorn RJW, Helder MN, Kroeze RJ, et al., *Spine*, 33: 949–954(2008).
- [2] J.J. Andrew, T.M. Hanczewicz, *Applied Spectroscopy*, 52(6): 797-807(1998).

Optical feedback interferometry in THz quantum cascade lasers: free carrier imaging and optical metamaterial response

Gaetano Scamarcio

*Dipartimento Interateneo di Fisica “M. Merlin”
Università degli Studi di Bari “Aldo Moro”, Politecnico di Bari
CNR – Istituto di Fotonica e Nanotecnologie*

After reviewing the basics of self-mixing interferometry, I will present our recent results on a novel contact-free method based on the use of THz quantum cascade lasers operating under optical feedback to image in reflection mode the free electron plasma photogenerated onto a semiconductor surface. Self-mixing interferometry is also used to demonstrate the possibility to produce sub-wavelength patterns acting as metamaterials in semiconductors pumped by a spatially modulated near-infrared beam.

Photonic engineering of THz quantum cascade resonators

Miriam S. Vitiello

NEST, CNR - Istituto Nanoscienze and Scuola Normale Superiore, Piazza San Silvestro 12, 56127, Pisa, Italy

Terahertz (THz) radiation lies in the region of the electromagnetic spectrum, loosely defined as the 30-300 μ m wavelength region that is often called “THz gap”. Recent technological innovation in photonics and nanotechnology is now enabling THz frequency research to be applied in an increasingly widespread range of applications, such as information and communications technology, sensing, medical diagnostics, global environmental monitoring, homeland security, and quality and process controls. Most of these applications require systems with targeted sensitivity and specificity exploiting advanced quantum devices, novel materials and technologies. To address the above application requirements, high power, widely tunable sources with controlled and directional beam profiles, together with high-speed and high-sensitivity resonant detectors need to be developed. This requires parallel developments in semiconductor materials and heterostructures, including micro/nanostructuring and plasmonics, as well as related multifunctional THz optical components.

The talk will provide an overview of our recent technological developments of Terahertz quantum cascade lasers, from the development of quasi-crystal THz intersubband lasers,¹ to novel DFB concepts exploiting bi-period feedback gratings to control the emission frequency and the output beam direction independently². A final emphasis on our microcavity approaches for continuous tuning of THz QCL emission and waveguide adapters for efficient THz radiation out-coupling³ will be provided.

References

¹M.S. Vitiello, M. Nobile, A. Ronzani, A. Tredicucci, F. Castellano, A. Talora, L.H.Li, E.H. Linfield, A.G. Davies “Photonic Quasi-crystal Terahertz Lasers”, *Nature Communications* 5, 5884 (2014).

²F. Castellano, S. Zanotto, L. H. Li, A. Pitanti, A. Tredicucci, E. H. Linfield, A. G. Davies and M. S. Vitiello, “Distributed feedback terahertz frequency quantum cascade lasers with dual periodicity gratings”, *Appl. Phys. Lett.* 106, 011103, (2015).

³F. Castellano, L. Li, E. H. Linfield, A. G. Davies, H. E. Beere, D. A. Ritchie, and M. S. Vitiello, “THz waveguide adapters for efficient radiation out-coupling from double metal THz QCLs”, *Optics Express* 23, 5190 (2015).

Processing of AlGaAs/GaAs and InGaAs/InAlAs/InP semiconductor structures for QC lasers

Anna Szerling¹, Kamil Kosiel¹, Michał Szymański², Maciej Kozubal¹, Marcin Myśliwiec¹, Piotr Prokaryn¹, Renata Kruszka¹, Krystyna Gołaszewska¹, Karolina Pągowska¹, Artur Trajnerowicz¹, Piotr Karbownik¹, Mariusz Płuska¹, Adam Łaszcz¹, Anna Piotrowska¹

Steven Slivken³, Yanbo Bai³, Manijeh Razeghi³

Zbig Wasilewski⁴

¹ Institute of Electron Technology, Al. Lotników 32/46, 02-668 Warsaw, Poland

² Warsaw University of Life Sciences, Faculty of Applied Informatics and Mathematics, ul. Nowoursynowska 159, 02-776 Warsaw, Poland

³ Center for Quantum Devices, Department of Electrical Engineering and Computer Science, Northwestern University, Evanston, Illinois 60208, USA

⁴ University of Waterloo, 200 University Ave W, Waterloo, ON N2L 3G1, Canada

The work presents the issues of processing of AlGaAs/GaAs and InGaAs/InAlAs/InP semiconductor structures for quantum cascade lasers (QCLs).

The processing of QCLs consists some crucial steps like the mesa formation, electric contacts fabrication, electrical isolation formation and mounting. For THz QCLs, the basic processing steps include also fabrication of metallic cladding layers, wafer bonding and removing of the substrate. The paper discusses selected technological problems, like for example an obtainment of low-series-resistance and time-stable and thermal-stable electrical metal-semiconductor contacts that must be characterized by a very good lateral uniformity and shallow diffusion depths of. It will be shown the influence of the type of electrical isolation on the devices' performance.

As a source of knowledge of morphological, mechanical, chemical, electrical and optical properties of the discussed structures a wide range of characterization techniques was employed, like optical microscopy, atomic force microscopy (AFM), scanning electron microscopy (SEM), transmission electron microscopy (TEM), energy dispersive X-ray spectroscopy (EDXS), and Fourier transform infrared (FTIR) spectrometry.

It will be presented the results for AlGaAs/GaAs Mid-IR lasers emitting $\lambda \sim 9,5 \mu\text{m}$ (with threshold current densities $\sim 20 \text{kA/cm}^2$ at 270K) and AlGaAs/GaAs THz-frequency lasers emitting $\lambda \sim 100 \mu\text{m}$ (with the maximum operating temperature 130K and with threshold current densities $\leq 1.8 \text{kA/cm}^2$). It will be shown the multimode emission of InGaAs/InAlAs/InP lasers ($\lambda \sim 16 \mu\text{m}$) with pulsed peak power up to 700 mW at 30°C.

Acknowledgments: The work was partially financially supported by project LIDER/34/70/L-3/11/NCBR/2012 by The National Centre for Research and Development and by project 2011/03/D/ST7/03146 by Polish National Science Center. Dr Anna Szerling was supported from COST ACTION MP1204 TERA-MIR Radiation: Materials, Generation, Detection and Applications.

On the active region improvement in interband cascade lasers

M. Motyka¹, G. Sęk¹, K. Ryczko¹, F. Janiak¹, M. Dyksik¹, J. Misiewicz¹
R. Weih², M. Dallner², S. Höfling^{2,3}, M. Kamp²

¹*Institute of Physics, Wrocław University of Technology, Wrocław, Poland*

²*Technische Physik, University of Würzburg, Würzburg, Germany*

³*School of Physics and Astronomy, University of St. Andrews, St. Andrews, United Kingdom*

Applications related to the detection of hazardous and environmentally-relevant gasses drive the growing demands with respect to all the sensor system components, requiring cheap and compact laser sources. This can be well fulfilled by semiconductor lasers, where one of the efficient solutions is interband cascade laser (ICL). Such devices have already been proven to emit at some wavelengths of the mid-infrared (to beyond 10 μm even), i.e. in ranges characteristic for maximal absorption of many gasses, and shown to offer continuous wave single mode operation at room temperature between 3 and 5 μm , and additionally significantly lower power consumption [1] than the more common quantum cascade lasers. However, ICLs still need further developments regarding especially the demanded performances at longer wavelengths, broad bandwidth or widely tunable devices.

We have investigated, both experimentally and theoretically, several modifications in the active region of the ICLs. The considered structures are based on InAs/(Ga,In)(As,Sb) materials forming a broken gap system, i.e. confining electrons and holes in spatially separate layers. The lasers are usually grown on either GaSb or InAs substrates. Our study is aimed at maximizing the optical transition oscillator strength (OS) via tailoring the electronic structure, the related strain and wave function engineering. OS is the most critical parameter of the type II system because it can allow for compensating the intrinsic losses while extending the emission wavelength or the gain bandwidth. We will cover such issues as variation of compositions and thicknesses, importance of the band offsets, the active transition intensity and external factors as temperature or electric field.

A combination of two spectroscopic techniques is used, emission-like (photoluminescence) and absorption-like (modulated reflectivity) supported by the energy level calculations employing multiband $k\cdot p$ modeling. We demonstrate that addition of arsenic into the commonly used ternary layer of GaInSb for the holes confinement can significantly enhance the transition oscillator strength, while decreasing the overall strain and keeping still the type II design [2,3]. There is also investigated the use of a triple type II quantum well structure instead of a commonly used double well “W-design”[4]. This allows for simultaneous red shift of the transitions and increase of the oscillator strength. Eventually, further structure optimizations utilizing uncommon material combinations will be discussed. In this part, application of the GaAsSb layers instead of typically used GaInSb will be considered as a new way for holes confinement. Performed calculation includes strain engineering, will be finally supported by their experimental verification.

1. I. Vurgaftman et al., *Nature Commun.* **2**, 585 (2011)
2. F. Janiak et al., *Appl. Phys. Lett.* **100**, 231908 (2012)
3. K. Ryczko et al., *J. Appl. Phys.* **114**, 223519 (2013)
4. Motyka et al., *J. Appl. Phys.* in press (2015)

High temperature operation of InGaAs/AlGaAs/GaAs quantum cascade lasers

Maciej Bugajski¹, Andrzej Kolek², Piotr Gutowski¹, Kamil Pierściński¹, Dorota Pierścińska¹,
Piotr Karbownik¹, Maciej Sakowicz¹

¹Institute of Electron Technology, Al. Lotników 32/46, 02 668 Warsaw, Poland

²Department of Electronics Fundamentals, Rzeszów University of Technology,
W. Pola 2, 35 959 Rzeszów, Poland

Mid-IR QCLs can be divided into two main categories based on the material system involved; GaAs- and InP-based devices. The latter offer unquestionable advantages in terms of high temperature, CW operation. The former, however, offer performance in pulsed mode operation at room temperature, which is sufficient in many applications. The main issue that limits high temperature performance of GaAs-based devices is the low conduction band-offset, causing the electrons to escape to 3D continuum of states at elevated temperatures of the active region. There were attempts taken to increase the band-offset by e.g. increasing the Al content in the barrier layers. Unfortunately, increased Al content leads to increased inter-valley scattering to X and L minima and consequently to decreased laser performance.

In this work we report on the design, realization and characterization of a mid-IR QCLs based on InGaAs/AlGaAs/GaAs structures grown by molecular beam epitaxy. Structures were grown with indium content of 3% in QWs and 45% of Al in AlGaAs barrier layers. The design results in strained heterostructure, however, no strain relaxation was observed as documented by X-ray diffraction measurements. Devices exhibit performance largely improved over standard AlGaAs/GaAs QCLs. More than 2 times reduction of threshold current density was observed. Lasing at $\sim 9.5 \mu\text{m}$ was achieved in the pulse mode up to $T = 50 \text{ }^\circ\text{C}$ with characteristic temperature $T_0 = 120 \text{ K}$.

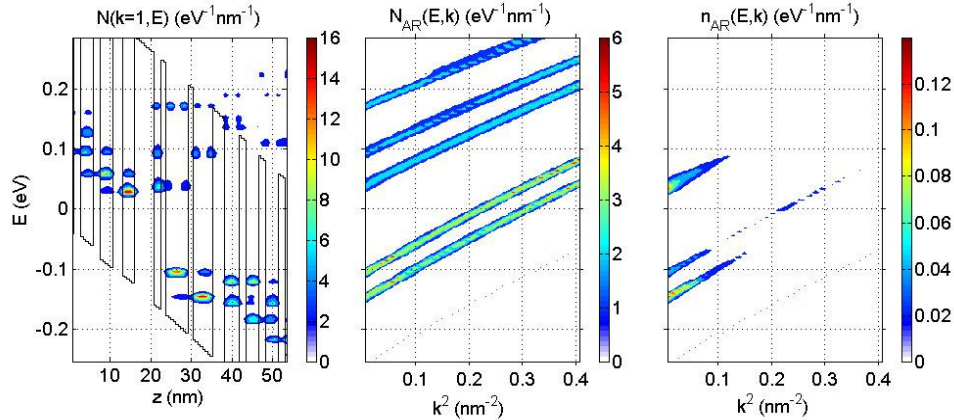

Fig.1 (a) Conduction band edge (solid line) and density of states $N(k_{\perp=0}, E)$, (b) energy-momentum-resolved density of states N_{AR} and (c) density of electrons n_{AR} in the active region of the laser polarized by voltage $U=0.28 \text{ V/period}$.

Non-equilibrium Green's functions model of InGaAs/AlGaAs/GaAs laser that utilizes single-phonon resonance scheme has been analyzed. This method is used to examine electronic transport, optical gain, and carrier distributions in the subbands of the laser. The problem is completely solved in k -space and nonparabolicity is accounted for through energy dependent effective mass. Scattering self-energies included in NEGF formalism are that for LO-phonon, interface roughness (IR), alloy disorder (AD), ionized impurity (I-I) scatterings and for energy averaged LA-phonon scattering. Electron-electron scattering was included within Hartree approximation by solving Poisson equation (with the boundary conditions that preserve charge neutrality of each QCL period) selfconsistently with NEGF equations. Good agreement with experimental data is found.

This work was partially supported by PROFIT PBS 2/A3/15/2013 and by National Science Centre Grant SONATA no. 2013/09/D/ST7/03966 .

Hybrid modes of mid-infrared double trench quantum cascade lasers

E. Pruszyńska-Karbownik, A. Trajnerowicz, P. Karbownik, P. Gutowski,
K. Regiński, M Bugajski

Institute of Electron Technology, al. Lotników 32/46, Warsaw, Poland
ekarb@ite.waw.pl

It is commonly believed that quantum cascade lasers (QCL) can emit only radiation which is linearly polarized in the quantum well growth direction (transverse-magnetic/TM mode), because polarization selection rule of intersubband transition allows gain only for TM modes [1]. Although a photocurrent experiment showed that the selection rule is not absolute and is fulfilled to the accuracy of 3% [2].

We made QCL polarization measurements in the far-field by using a goniometric profilometer. The studied laser is a lattice matched $\text{Al}_{0.477}\text{In}_{0.523}\text{As}/\text{In}_{0.533}\text{Ga}_{0.467}\text{As}/\text{InP}$ QCL [3] fabricated into double-trench structures using wet etching and Si_3N_4 for electrical insulation. The measured amount of light polarized perpendicular to the growth direction varies from 2% for the fundamental mode to 7% for higher order modes. Waveguide analysis showed that the waveguide confined by the trenches induces hybrid modes of far-field distributions resembling the experimental ones. The theoretical amounts of perpendicularly polarized radiation are equal to 1% and 7%, respectively. The analysis was made by using full-vectorial finite-difference waveguide solver [4].

References

- [1] J. Faist, *Quantum Cascade Lasers*, OUP Oxford (2013).
- [2] H.C. Liu et al., *Appl. Phys. Letters* 72. 1682-1684 (1998)
- [3] M. Bugajski et al., *phys. status solidi (b)* 251, 1144–1157 (2014)
- [4] FIMMWAVE ver. 6.1.2, Photon Design, www.photond.com

The author acknowledges support from MPNS COST ACTION MP1204 - TERA-MIR Radiation: Materials, Generation, Detection and Applications.

Optical sideband generation with mid-infrared quantum cascade lasers up to room temperature

S. Houver, A. Lebreton, J. Tignon and S. S. Dhillon

Laboratoire Pierre Aigrain, Ecole Normale Supérieure-PSL Research University, CNRS, Université Pierre et Marie Curie-Sorbonne Universités, Université Paris Diderot-Sorbonne Paris Cité, 24 rue Lhomond, 75231 Paris Cedex 05, France
sarah.houver@lpa.ens.fr

The combined giant nonlinear optical properties of intersubband and interband transitions in quantum wells have recently received considerable attention. Indeed efficient nonlinear wave mixing between a near-infrared (NIR) pump (interband resonance) in presence of an intense terahertz (THz) beam (intersubband resonance) in quantum wells systems has been previously demonstrated to generate THz-optical sidebands i.e. $E_{\text{NIR}} \pm nE_{\text{THz}}$ where n is an integer [1]. However, the THz radiation is provided by a Free Electron Laser. Recently, we have demonstrated [2, 3] that these types of resonant nonlinear processes can be realized using THz quantum cascade lasers (QCL) [4]. These previous demonstrations, however, have been performed using THz QCLs and thus inherently limited to cryogenic temperatures. In this work [5], through a new design of the QCL waveguide, we demonstrate sideband generation up to room temperature between a resonant NIR beam and a mid-infrared QCL.

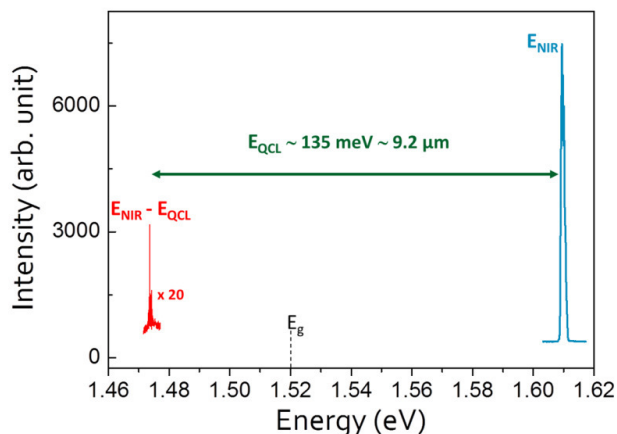

The figure shows the optical spectrum transmitted through a QCL held at 210K and operating at $E_{\text{QCL}} = 135$ meV ($\lambda \sim 9$ μm , $f \sim 33$ THz) for an interband excitation $E_{\text{NIR}} = 1.615$ eV. The difference frequency, the sideband, is clearly observed at $E_{\text{NIR}} - E_{\text{QCL}} = 1.48$ eV. Sideband generation was shown up to room temperature, limited only by the maximum temperature operation of the QCL.

This work can be applied to large all-optical wavelength shifts in communications and enable the use of mature and high performance NIR techniques (such as fast and sensitive detectors) to be applied to the characterization of QCL in regimes such as modelocking or frequency comb generation.

References

1. S. G. Carter, V. Ciulin, M. S. Sherwin, M. Hanson, A. Huntington, L. A. Coldren, and A. C. Gossard, *Appl Phys Lett* **84**, 840-842 (2004).
2. J. Madeo, P. Cavalie, J. R. Freeman, N. Jukam, J. Maysonave, K. Maussang, H. E. Beere, D. A. Ritchie, C. Sirtori, J. Tignon, and S. S. Dhillon, *Nat Photonics* **6**, 519-524 (2012).
3. P. Cavalie, J. Freeman, K. Maussang, E. Strupiechonski, G. Xu, R. Colombelli, L. Li, A. G. Davies, E. H. Linfield, J. Tignon, and S. S. Dhillon, *Appl Phys Lett* **102**(2013).
4. R. Kohler, A. Tredicucci, F. Beltram, H. E. Beere, E. H. Linfield, A. G. Davies, D. A. Ritchie, R. C. Iotti, and F. Rossi, *Nature* **417**, 156-159 (2002).
5. S. Houver, P. Cavalie, M. R. St-Jean, M. I. Amanti, C. Sirtori, L. H. Li, A. G. Davies, E. H. Linfield, T. A. S. Pereira, A. Lebreton, J. Tignon, and S. S. Dhillon, *Opt Express* **23**, 4012-4020 (2015).

Monolithic subwavelength high-index-contrast grating VCSEL

Marcin Gębski, Maciej Dems, Michał Wasiak, Tomasz Czyszanowski

Lodz University of Technology, Institute of Physics, Photonics Group,

Wólczańska 219, 90-924 Łódź, Poland

tomasz.czyszanowski@p.lodz.pl

We propose and numerically investigate a new vertical-cavity surface-emitting laser (VCSEL) structure consisting of a nearly lambda-thick active optical cavity sandwiched between two planar monolithic subwavelength high-index-contrast gratings (MHCGs) etched directly into the semiconductor layers surrounding the optical cavity (Fig. 1). The structure allows the reduction of the vertical thickness of the subsequent MHCG VCSEL to roughly 1 μm for emission for infrared region (Fig. 2). Compared to a conventional all-semiconductor VCSEL with distributed Bragg reflector mirrors, the MHCG VCSEL has a shorter effective cavity length and thus a shorter roundtrip cavity time. Our proposed design enables the fabrication of VCSELs with lattice-matched mirror layers in all common semiconductor optoelectronic material systems, or alternatively VCSELs with hybrid HCGs.

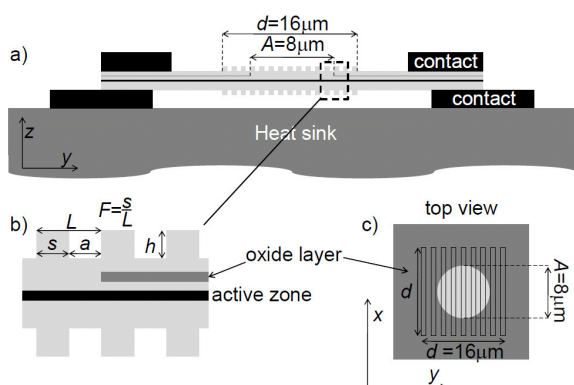

Fig. 1 Schematic illustrations (not to scale) of: a) the MHCG VCSEL mounted on a copper heat sink with an intracavity metal contact scheme; b) definition of the geometrical parameters including: h - height of the stripe; L - period of the grating; s - width of the stripe; a - distance between the stripes; and F - fill factor. c) Top view of the laser showing the dimensions (d) and arrangement of the top and bottom MHCG and oxide aperture (A) used in the calculations. The structures are illustrated in the z - y plane in a) and b), and in the x - y plane in c).

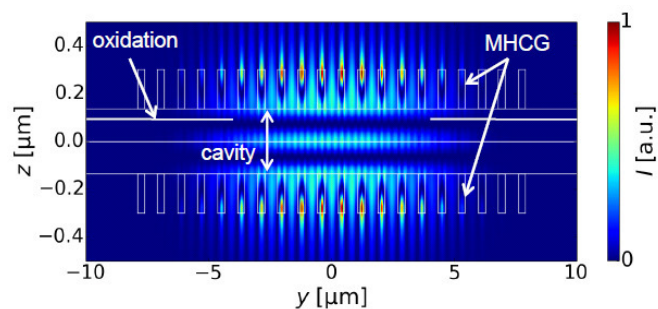

Fig. 2 The calculated optical field intensity distribution I of the HE_{11} mode in the z - y plane for the MHCG VCSEL.

The author acknowledges support from the Polish National Centre of Research and Development in the frame of the project: "A Novel Photonic Crystal Surface Emitting Laser Incorporating a High-Index-Contrast Grating." M. Gębski acknowledges support from the Polish National Science Centre within the project PRELUDIUM 2013/11/N/ST7/02826.

Experimental investigation on multi-wavelengths generation in Vertical External Cavity Surface-Emitting Laser

A. Broda, A. Jasik, A. Wójcik-Jedlińska, A. Trajnerowicz, I. Sankowska,
J. Kubacka-Traczyk and J. Muszalski

Instytut Technologii Elektronowej, Al. lotników 32/46, 02 668 Warszawa, Poland

In recent years Vertical-External-Cavity Surface-Emitting Lasers (VECSEL) are of great interest as the attractive sources of coherent light. The external cavity and flexibility of the semiconductor epitaxy allows to design and fabricate VECSEL source for almost any wavelength directly or by intracavity frequency conversion (e.g. second harmonic generation process (SHG)). Moreover, the flexibility for accurate wavelength control by means of bandgap engineering has enabled to develop VECSEL capable of two wavelength emission.

In this paper we report our new data on the realizations of two VECSEL heterostructure designs, which can deliver high power and tunable two color emission. First design of VECSEL was with the two different types of active regions enclosed inside a single microcavity. In order to obtain gain coefficient high enough we deposited double quantum wells at antinodes of standing wave. Moreover, both active regions were separated with a potential barrier, preventing against excess diffusion of carriers to the long wavelength region. Such structure permitted for a simultaneous dual-wavelength emission at 980 nm and 1024 nm.

Second unique design is switchable two wavelength VECSEL. The laser emitting at 967nm or 1018nm. The emission wavelengths can be switched by simply changing laser operation conditions: the pump power or the temperature of heatsink. This feature has been achieved by making a single active region enclosed in a two mode microcavity. Either the increase of the pump power or the heatsink temperature result in a spectral red-shift of the gain maximum, what, in turn, switches the laser emission from short to long wavelength mode. The drop of the gain value due to the temperature increase is compensated by the larger value of longitudinal confinement factor for the longer wavelength mode. Both devices can operate at each wavelength up to 1W, each in the single TEM₀₀ mode.

We believe that coaxial two wavelength laser emission can be an attractive source in a number of application, especially where a high reliability of beam guiding is required or the space is limited. The application of the SHG process in a cavity of the switchable two wavelength VECSEL can transfer it to a two color source, for instant, blue and green what can be of great use in the low volume projectors.

Acknowledgment:

the reported research was supported by the grants: NCBiR NR 02 0023 06 and NCN N N515 360636.

Optimal 1D microcavity for THz emission from optically pumped GaP layer: numerical analysis

H.V. Baghdasaryan, T.M. Knyazyan, T.T. Hovhannisyan, A.A. Hakhoumian¹,
M. Marciniak^{2,3}

SEUA, 105 Terian str., Yerevan 0009, Armenia:

hovik@seua.am

¹ IRPhE/ANAS 1. Alikhanian brs., Ashtarak 0203, Armenia

² NIT 1. Szachowa str., Warsaw 04-894, Poland

³ KUT, 7. Al. Tysiaclecia Panstwa Polskiego, Kielce 25-314, Poland

In the current work an influence of 1D micro cavity on THz emission from semiconductor layer of GaP at optical pump (THz wave rectification [1]) is analysed. Fabry – Perot type microresonator with DBR mirrors of SiO₂/Air bilayers is analysed. For the numerical analysis the method of single expression (MSE) is used [1,2].

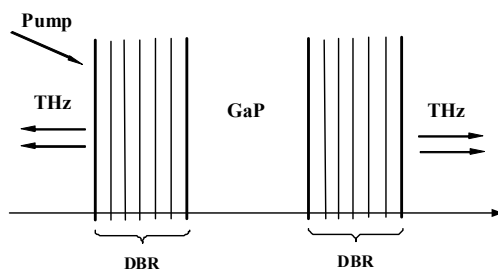

Fig.1 Fabry-Perot structure under modelling

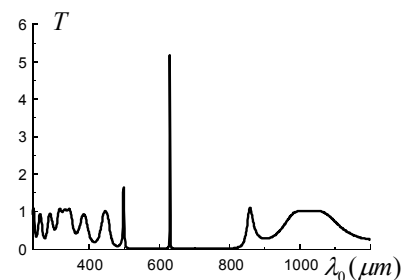

Fig.2 Transmission spectra of (HL)⁴-GaP-(LH)⁴ structure at external optical pump

It is obtained, that emission intensity from “DBR – GaP layer – DBR” structure strongly depends not only on the number of layers in DBRs but also on their outermost layers’ permittivity. For efficient emission of THz waves from GaP layer an adjacent to semiconductor layers of DBRs should be of low dielectric permittivity. An enhancement of THz emission from the considered multilayer structure is possible by an increase of microresonator’s Q – factor, which requires an increase of bilayers number in DBRs.

Electromagnetic modelling by the MSE permits to obtain also electric and magnetic fields and Poynting vector distribution within the structure that gives clear explanation of physics of specific frequencies emission from the microcavity. Resonant emission takes place at frequencies coinciding with resonant transparency of microcavity with GaP as a spacer.

References

- [1] K.Sakai, ed., Terahertz Optoelectronics (Springer, 2005).
- [2] H.V. Baghdasaryan, Method of backward calculation, in the book: *Photonic Devices for Telecommunications: how to model and measure/* Editor G. Guekos, Springer-Verlag, , pp.56-65 (1999).
- [3] H.V. Baghdasaryan, T.M. Knyazyan. Problem of plane EM wave self-action in multilayer structure: An exact solution, *Optical and Quantum Electronics*, **31** 1059 (1999).

The author acknowledges support from MPNS COST ACTION MP1204 - TERA-MIR

Radiation: Materials, Generation, Detection and Applications.

Intense THz pulses for THz pump – THz probe experiments

Dascalu T., Cojocaru G., Ungureanu R., Grigore O., Dinca M. P., Mihailescu D.F.

National Institute for Laser Plasma and Radiation Physics, Atomistilor 409, Magurele, Ilfov,
Romania, University of Bucharest Faculty of Physics, University of Bucharest Faculty of Biology

Author e-mail address: traian.dascalu@inflpr.ro

Intense THz transients interact with gases and solid matter as well as proteins and biological tissues and they can be used to modify molecular orientation and rotations, spin, electrons, phonons. The numerical simulations of protein behavior as well as the experimental techniques have shown that high energy THz pulses are of great interest for biology and medicine [1,2]. Well established techniques like pump-probe requires high intensity THz sources with a delay of tens of picoseconds range and tailored shape, polarization, and energy. Here we report on two methods for generation of multiple high intensity THz pulse by using air-plasma filament two-color technique [3]. Optical pulses of few mJ and about 50 femtoseconds length at 800 nm fundamental wavelength (FW) are split by an assembly of thin film beam splitter (TFBS) and a mirror (Fig. 1). The delay between optical pulses and their energy ratio are controlled by the distance between TFBS and mirror and the polarization orientation. The pulses are then focused through a BBO crystal to generate second harmonic (SH) and then, by balance action of self-focus and defocus, two plasma filament delayed by τ are created. The combined action of FW and SH on plasma filament creates an asymmetrical electromagnetic field that interacts with charged particles generating two high intensity THz transients which are recorded by using electrooptical sampling in ZnTe crystal, fig. 2. The energy ratio between optical pulses is controlled by inserting a half wave plate before TFBS.

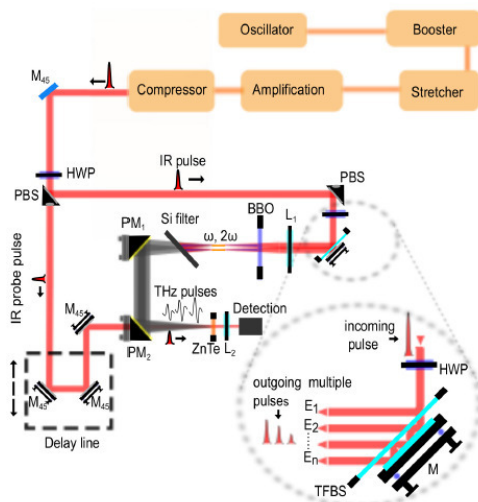

Fig. 1. Experimental setup of multiple high energy THz generation by TFBS method.

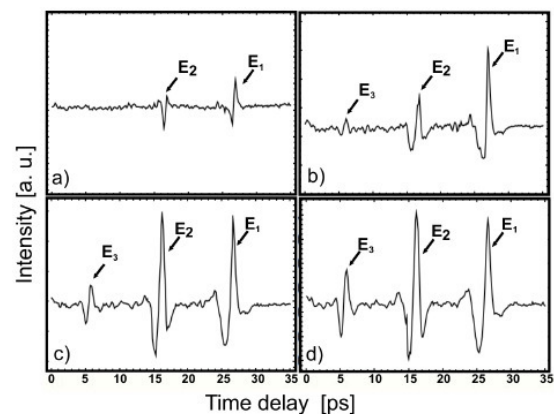

Fig. 2. THz pulses resulted when optical pump energy is: a) 1mJ, b) 1.7mJ, c) 2.85 mJ, d) 4 mJ

References

- [1]. Mernea M et al, Journal of optoelectronics and advanced materials, Vol 12, 1, 135 (2010)
- [2]. Dinca MP et al, Journal of optoelectronics and advanced materials, Vol. 12, 1, 110, (2010)
- [3]. R. Ungureanu et al, *Laser Phys. Lett.* **12** 045301. doi:10.1088/1612-2011/12/4/045301, (2015)

The authors acknowledges support from grant PN-II-ID-PCE-2011-3-0801, MPNS COST ACTION MP1204 - TERA-MIR Radiation: Materials, Generation, Detection and Applications and LASERLAB Europe 284464.

Comparison of tunable narrow-band CW mid-IR generators based on the difference frequency generation in KTP and KTA crystals

Y. Baravets, P. Honzatko, F. Todorov, P. Gladkov

*Institute of Photonics and Electronics, The Czech Academy of Sciences,
Chaberska 57, Prague 18251, Czech Republic
baravets@ufe.cz*

We have compared narrow-band CW mid-IR generators based on a difference frequency generation in periodically poled (PP) KTP and KTA crystals. The nonlinear crystals are used to mix the beams from tunable high power master-oscillator power-amplifier (MOPA) laser sources working at 1060 nm and 1550 nm bands, respectively (Fig. 1). The master-oscillators use a fiber ring configuration built of polarization maintaining (PM) fibers and components in order to achieve linearly polarized light of the laser output. The seed lasers are tunable in the spectral range of 1040-1089 and 1540-1589 nm, respectively and their line widths are less than 0.03 nm. The signals at fundamental wavelengths are amplified in high-power amplifiers (YDFA, EDFA) based on double-clad fibers pumped by multimode laser diodes (LD) by means of pump signal combiners (PM-PSC). The pump and the signal are combined in a polarization maintaining wavelength division multiplexer (PM-WDM). The maximum output power of the system at 1060 nm and 1550 nm range is 2 W and 0.5 W of CW power correspondingly. The linearly polarized light from the output of the multiplexer is focused in the nonlinear media. The PP-KTP and PP-KTA crystals have a length of 16.5 mm and thickness of 1 mm. The length of the periodically poled pattern is 15 mm. The transmitted pump and signal beams at the output of the crystal are reflected by a dichroic filter (F) to a control detector (D1). The idler beam goes through a germanium window (GW) to a beam splitter (BS). A PbSe detector (D2) is used as a reference detector. The transmitted mid-IR beam is focused into an output fiber. The maximum tuning range within the mid-IR region achieved with the PP-KTA crystal with a period of 39.8 μm is 3100-3620 nm (Fig.2).

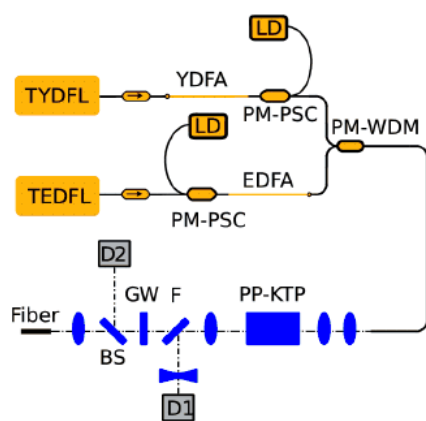

Fig.1. Principal setup.

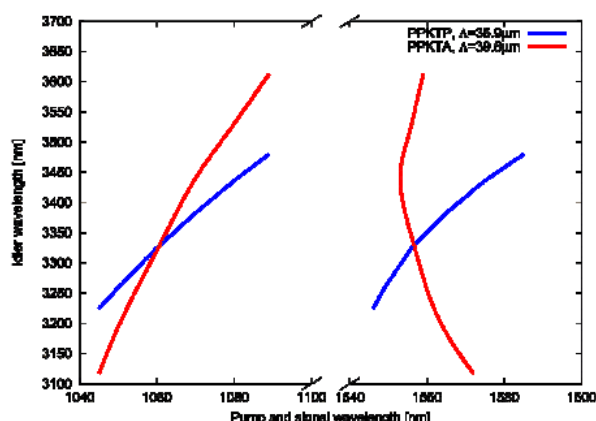

Fig.2. Output wavelength of the generator.

The authors acknowledge support from MPNS COST ACTION MP1204 - TERA-MIR Radiation: Materials, Generation, Detection and Applications.

THz detection in Topological Insulator Field Effect Transistor

Leonardo Viti¹, Dominique Coquillat², Wojciech Knap², Miriam S. Vitiello¹

¹NEST, Istituto Nanoscienze – CNR and Scuola Normale Superiore, Piazza San Silvestro 12, Pisa, I-56127 Italy

²Université Montpellier 2 and CNRS, TERALAB-GIS, L2C UMR 5221, 34095 Montpellier, France

We report on room temperature THz detection with top-gated FETs having as active channel Bi₂Se₃ or Bi₂Te_{2.2}Se_{0.8} flakes. Among three-dimensional topological insulating materials (3DTIs), Bi₂Se₃ is one of the most appealing because of its topologically non-trivial energy gap of 0.3 eV, about ten times higher than thermal excitation at room temperature, which allows to access the single Dirac cone boundary states without requiring cooling [1]. On the other hand, ternary Bi-based compounds are known to be good thermoelectric materials with in-plane Seebeck coefficient up to -330 μV/K at room temperature [2].

Two THz detectors were fabricated using standard EBL techniques applied on exfoliated flakes of Bi₂Se₃ and Bi₂Te_{2.2}Se_{0.8} (samples A and B, respectively). The optical characterization of the detectors was carried on using a frequency tunable source in the range from 0.26 - 3.8 THz. Responsivities of 3.0 V/W and 0.25 V/W were estimated for samples A and B, respectively, corresponding to a noise equivalent power (NEP) of about 20 nW/√Hz in both cases.

From the analysis of the THz response it turned out that, whereas for sample B the detection is triggered by overdamped plasma instabilities induced in the active channel of the FET by the incoming THz *ac* field [3], the detection mechanism of sample A relies on the photothermoelectric effect.

The huge Seebeck coefficient is capable, in our sub-micron geometry, to transform the small gradient in the electron thermal distribution, induced between source and drain by the asymmetrically fed THz radiation, in a measurable *dc* voltage.

We found that the controllable composition of Bi-based compounds can be exploited to select the dominant contribution to THz detection, thus enabling further study towards the detectors optimization and the use of THz radiation as a possible way to access topologically protected surface states.

References

- [1] Duan J., et al., *Identification of Helicity-Dependent Photocurrents from topological surface states in Bi₂Se₃ gated by Ionic Liquid*, Scientific Reports 4, 4889, 2014
- [2] A. M. Shikin et al., *Electronic and spin structure of the topological insulator Bi₂Te_{2.4}Se_{0.6}* Phys Rev B **89**, 125416 (2014).
- [3] M. Dyakonov and M. Shur, *Detection, mixing, and frequency multiplication of terahertz radiation by two dimensional electronic fluid*, IEEE Trans. Electron. Dev. **43**(3), 380–387 (1996).

The author acknowledges support from MPNS COST ACTION MP1204 - TERA-MIR Radiation: Materials, Generation, Detection and Applications. This work is a report of the Short Term Scientific Mission “Characterization of NW-FET THz detectors” [COST-STSM-MP1204-20459](#).

Multifrequency high precise spectroscopy of biological tissues

V. Vaks, M. Chernyaeva, E. Domracheva, S. Pripolzin

IPM RAS, Academicheskaya 7, Nizhny Novgorod, Russia

vax@ipmras.ru

The important concern of the growing food industry involves control and monitoring of the product's quality that stimulates development and optimization of instrumental methods. One of the promising techniques for rapid, non-destructive analysis involves examination of the food's smell that is e-nose technology. This examination is considerably complicated by a need to analyze a multicomponent gas mixture that requires reliable detection, discrimination and quantification of many volatile compounds.

Development of a combined IR-THz gas analyzer increases the number of gases that can be identified and the reliability of the detection by confirming the signature in both THz and MIR ranges. The subTHz, THz and MIR radiation sources of the spectrometer based on solid state harmonics generator and quantum cascade lasers (QCL) have been developed. The subTHz radiation source has been developed on the solid state harmonics generator. It has a number of advantages comparing with other well-known microwave generators. For THz and MIR ranges the QCLs are used. They have a high output power and can generate radiation in

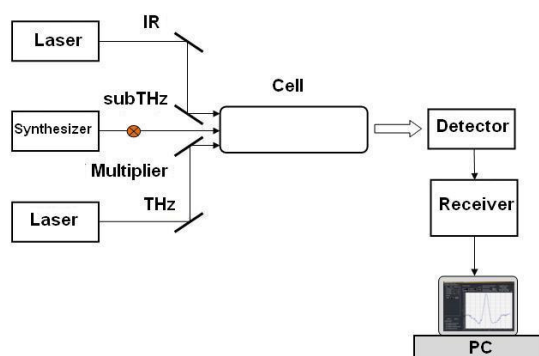

pulse and continuous modes together with fast tuning of frequency. Detection of the radiation in all three frequency ranges (subTHz, THz and MIR) are realized by the unique receiver block based on quantum semiconductor superlattices.

We have studied odors composition of fresh meat (veal, chicken), fish (salmon, trout) and their vapors during natural decay. The sample preparation was the same for meat and fish. Before measurements the tissue sample was cut to pieces and dried in a vacuum cell to remove the water. The spectroscopic analysis was done

with the sample at room temperature and heated up to 100 - 150°C. The studies started on the day of meat (fish) purchase and continued the following days up to appearance of the new volatile compounds, signaling of the sample natural decay. Between measurements the tissues were kept in a refrigerator at +4°C. The results demonstrate that the fresh meat odor composition includes ethyl formate, diethyl ether, alanine and glycine, which vanish during natural decay. The later is characterized, first of all, by appearance of sulfur-containing substances (H₂S, SO₂). Then decay is followed by emission of ammonia and organic molecules (phormamid, ethylamine). The vapor composition of the spoiled fish contains propylene glycol, urethane, hydrogen sulphide, sulfur dioxide and nitriles.

The preliminary investigations of biomarkers in three frequency ranges have demonstrated the advantages of the combined MIR-THz spectrometer for analysis of the composition for multicomponent gas mixtures.

The authors acknowledge support from MPNS COST ACTION MP1204 - TERA-MIR Radiation: Materials, Generation, Detection and Applications, TeraDec 047.018.005, NATO.EAP.SFPP 9840.

TE and TM THz intervalence band polaritons

I.A. Faragai¹ and M.F. Pereira²

¹*Department of Physics, Kano University of Science and Technology, Nigeria.*

²*Materials and Engineering Research Institute, Sheffield Hallam University, UK*

THz-polaritonics devices have strong potential for applications in spectroscopy, imaging and improved data transmission in communications and ultra-strong coupling of THz radiation with intersubband transitions which can further improve the applicability of polaritonics. Conduction band-based polariton coupling is restricted to the TM mode [1]. However, the fact that valence subband transitions can be coupled with both TE and TM modes polarized cavity modes, stimulated us to extend our studies of TE valence band polaritons [2] by comparing results obtained for THz polaritons and antipolaritons for the two possible modes. Both cases are investigated for different cavities and excitation conditions and the possibility of switching between one mode to the other with a large change in resonant frequency and polariton splittings are discussed. The strong nonparabolicity and k-dependence of the transition dipole moment has a very strong role in the shifting of effective resonance frequencies between TE and TM modes for the same transition. Our numerical results can stimulate further experimental investigations for a deeper understanding of the valence band coupling scenario, targeting applications in which a simple design with two possible outputs with different polarizations and resonant frequencies could be of relevance.

References

- [1] M.F. Pereira Jr., Intersubband antipolaritons: Microscopic approach, Phys Rev B75, 195301 (2007).
- [2] M.F. Pereira and I. A. Faragay, Optics Express 22, 3439 (2014).

The authors acknowledge support from MPNS COST ACTION MP1204 - TERA-MIR Radiation: Materials, Generation, Detection and Applications.

Simulations of Terahertz Resonators for Heterodyne Photomixing

L. Juul¹, M. Mikulics², M. Marso¹ and M.F. Pereira³

¹*Université du Luxembourg, 1359 Luxembourg, Luxembourg*

²*Forschungszentrum Jülich, 52425 Jülich, Germany*

³*Materials and Engineering Research Institute, Sheffield Hallam University, UK*

THz photomixers, which have become commercially available for CW spectroscopy applications over the last decade, are still among the simplest methods for THz-generation in terms of device complexity and fabrication. In addition, stacked InGaAs and InAlAs quantum well structures have been shown to have a low carrier lifetime and a band gap of 1.55 μm enabling the use of less costly optical sources. Using the numerical method presented in Ref. [1], we deliver a novel and very simple terahertz photomixer structure based on a conventional photoconductor driving a coplanar stripline (CPS) terminated with a multilayer capacitance and RF-chokes doubling as bond pads for the photoconductor bias circuit. The transmission line is a better and more compact inductive reactance element than a comparable uniplanar meander structure and contributes to a higher radiation resistance of the resonant circuit. The design leads to a predicted a radiated power of close to 15 μW at 0.85 THz, which is a five fold improvement over Ref. [2]. The current distribution on the transmission line indicates a linear polarisation of the radiated power. The layout features of the design are intentionally conservative and can be produced with conventional, inexpensive photolithographic methods.

References

- [1] L. Juul et al, Optical and Quantum Electronics, DOI 10.1007/s11082-014-0048-3]
- [2] Duffy et al, IEEE Transactions on Microwave Theory and Techniques 49(6):1032–1038 (2001).

The authors acknowledge support from MPNS COST ACTION MP1204 - TERA-MIR Radiation: Materials, Generation, Detection and Applications.

Many Body Approach for the Optical Properties of Dilute Semiconductors

C.I. Oriaku and M.F. Pereira

Materials and Engineering Research Institute, Sheffield Hallam University, UK

Dilute semiconductor materials have a strong potential for impact in the Mid Infrared range with an extra degree of freedom with controllable fundamental gaps and effective masses at both valence and conduction band methods. However, before intersubband designs that can reach the full MIR range or even THz frequencies, the properties of bulk materials must be fully understood. This paper explains previously not clearly understood features in the luminescence spectra of dilute nitrides, bismides and antimonides structures through a combination of many body and inhomogeneous broadening effects, as well as the unexpected influence of strain in samples expected to be relaxed. A seemingly anomalous temperature dependence of the luminescence peak emission is explained and that can have a strong impact in the design of future sources and detectors for the far infrared including interband Mid Infrared and intersubband THz sources. The luminescence is connected to the nonlinear absorption and gain and the simple and accurate expressions presented reduce exactly to Elliott's formula in the low density limit. The level of agreement between the theory and different experimental data clearly demonstrates the power and accuracy of the approach, which can become a very powerful tool to investigate new materials for mid infrared radiation generation and detection, starting from ab initio calculations

The authors acknowledge support from MPNS COST ACTION MP1204 - TERA-MIR Radiation: Materials, Generation, Detection and Applications.

Recent progress on dilute bismide

Shumin Wang

Chalmers University of Technology, Kemivägen 9, Göteborg 41296, Sweden
Shanghai Institute of Microsystem and Information Technology, Chinese Academy of Sciences,
865 Changning Road, Shanghai 200050, China
shumin@chalmers.se

Dilute bismide is a novel class of III-V semiconductor with a number of interesting physical properties such as a large band-gap bowing effect, a large spin-orbit split energy, having strong interaction with valence band of host materials leading to an enhanced valence band offset but less effect on conduction band etc. Research on dilute bismide began from InSbBi with a hope to extend light absorption wavelength beyond 8 μm in late 70s but soon it turned out that it was very difficult to incorporate Bi into InSb [1]. The renaissance appears when high quality GaAsBi with a band-gap bowing of 80 meV/% Bi and strong room temperature photoluminescence was demonstrated in 2003 [2]. Most studies so far have been focused on GaAs(N)Bi. In this talk, I will give a brief review of the history of dilute bismide research with a focus on recent progresses on growth of novel dilute bismide alloys such as GaSbBi [3,4], InAsBi [5], InPBi [6,7] and InAlGaPBi [8,9], as well as dilute bismide optoelectronic devices [10,11].

References

- [1] Oe *et al.*, Jpn J Appl Phys 20, L303 (1981).
- [2] Tixier *et al.*, Appl Phys Lett 82, 2245 (2003).
- [3] Song *et al.*, J Vac Sci Technol 30, 02B114 (2012).
- [4] Rajpalke *et al.*, Appl Phys Lett 103, 142106 (2013).
- [5] Sandall *et al.*, Appl Phys Lett 104, 171109 (2014).
- [6] Wang *et al.*, Nanoscale Res Lett 9, 24 (2014).
- [7] Wang *et al.*, Sci Rep 4, 5449 (2014).
- [8] Yue *et al.*, Appl Phys Exp 8, 041201 (2015).
- [9] Wang *et al.*, Semicond Sci Technol (2015) accepted.
- [10] Ludewig *et al.*, Appl Phys Lett 102, 242115 (2013).
- [11] Fuyuki *et al.*, Appl Phys Exp 7, 082101 (2014).

The author acknowledges support from MPNS COST ACTION MP1204 - TERA-MIR
Radiation: Materials, Generation, Detection and Applications.

Growth and characterization of dilute bismides for terahertz and laser applications

A.Krotkus¹, R. Butkutė¹, V. Pačebutas¹, A. Geižutis¹, P. Ludewig², and K. Volz²

¹Center for Physical Sciences and Technology, A. Gostauto 11, 01180, Vilnius, Lithuania

²Phillips-University Marburg, Germany

arunas.krotkus@ftmc.lt

Recent developments of dilute bismide based device technology at Centre of Physical Sciences and Technology in Vilnius will be discussed. Two types of devices will be presented: photoconductive antennas from (GaIn)(AsBi) for THz Time-domain spectroscopy (TDS) systems activated by 1.5 μm wavelength lasers and Ga(AsBi)/GaAs MQW laser diodes. In the first case it has been found that by simultaneous incorporation of Bi and In into the lattice of GaAs the energy bandgaps as narrow as 0.6 eV can be obtained. Epitaxial layers of quaternary bismide alloy have shorter than 1 ps carrier lifetimes and relatively large dark resistivity evidencing that this material is a good candidate for ultrafast optoelectronics applications. THz-TDS system based on (GaIn)(AsBi) components and Er-doped fiber laser is demonstrated.

SVT-A MBE reactor was used for growing Ga(AsBi)/GaAs QWs. When the growth temperature of 330°C, maximum PL peak wavelength of $\sim 1.36 \mu\text{m}$ was reached; after reducing this temperature to 300°C PL peak was red-shifted to 1.43 μm (corresponding to $\sim 11\%$ Bi in the well region), but the PL intensity became reduced by more than one order of magnitude. P and n-type (Al_{0.4}Ga)As cladding layers were grown by MOVPE at Marburg. 20 μm wide Au/Cr metal stripes were deposited through an opening in the photoresist layer on the top of the epitaxial structure. Room temperature lasing at 1.05 μm was obtained in diodes with up to 6%Bi in the QWs; diodes with 9%Bi have shown the electroluminescence signal peaked at 1.3 μm wavelength.

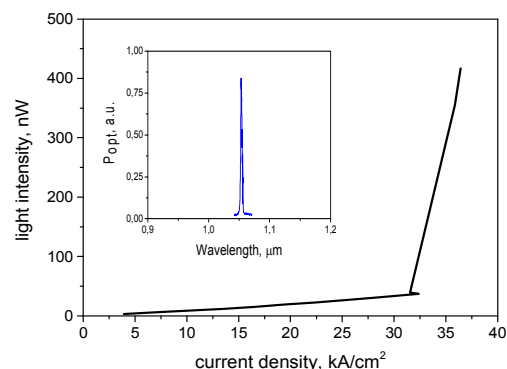

Fig. 1. L-I and spectral characteristics of Ga(AsBi) MQW laser diode at room temperature.

References

[1] R. Butkutė et.al., Electron. Lett., **50**, 1155 (2014).

The authors acknowledge support from MPNS COST ACTION MP1204 - TERA-MIR and from the European Union Framework 7 Project BIANCHO (FP7-257974).

Terahertz Wave Emission and Detection from Single Crystals of High Temperature Superconducting $\text{Bi}_2\text{Sr}_2\text{CaCu}_2\text{O}_{8+\delta}$

L. Ozyuzer¹, Y. Demirhan¹, F. Turkoglu¹, H. Koseoglu¹, T. Semerci¹, H. Alaboz¹,
M. Kurt¹, K. Kadowaki²

¹Department of Physics, Izmir Institute of Technology, *Urla, 35430, Izmir, Turkey*

²University of Tsukuba, *Tsukuba, Japan*

Terahertz (THz) technology is an extremely attractive research field but there is still lack of compact solid state sources. Improving (THz) source efficiency will benefit all application areas, including imaging, spectroscopy, information technology, medical diagnosis etc. The importance of developing passive and active devices which work in either terahertz or millimeter wave frequencies is ever more increasing in this popular field. High voltages across the junctions could be maintained by High-Tc superconductor $\text{Bi}_2\text{Sr}_2\text{CaCu}_2\text{O}_{8+\delta}$ (Bi2212) single crystal composed of superconducting CuO_2 -layers which are coupled through the intrinsic Josephson effect [1] and it holds the potential for very intense, coherent radiation that covers the THz gap. In our recent studies, we have fabricated continuous wave terahertz sources and observed emission powers up to $60 \mu\text{W}$ at frequencies up to 0.85 THz [2-3]. Furthermore we have performed bolometric detection and interferometer measurements. The emission frequency of mesas was determined using a Michelson interferometer setup which also demonstrates polarized emission. Interference patterns of THz radiation from Bi2212 mesas were detected by various detectors such as a liquid helium cooled silicon composite bolometer, a Golay cell and a pyroelectric detector. For the first time, most of the pumped power was extracted as THz emission from a Bi2212 mesa.

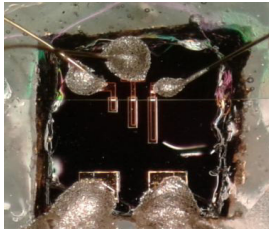

Fig. 1: Triple mesa structures for THz emission detection

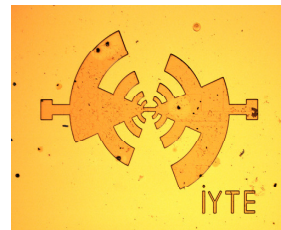

Fig. 2: Log Periodic Antenna for THz

As Bi2212 single crystals are sources of powerful and efficient THz waves, we can also use these crystals for detection purpose. We have fabricated log periodic antenna like bridge structure of a bolometer, which has wide-band characteristics, from thin (100-500 nm) single crystal Bi2212 for high sensitive terahertz radiation detection.

References

[1] R. Kleiner, F. Steinmeyer, G. Kunkel, P. Müller, Phys. Rev. Lett. 68, 2394 (1992).

[2] L. Ozyuzer et al., Science 318, 1291 (2007).

[3] F. Turkoglu, H. Koseoglu, Y. Demirhan, L. Ozyuzer, S. Preu, S. Malzer, Y. Simsek, P. Muller, T. Yamamoto, K. Kadowaki, Supercond. Sci. Technol. 25 125004 (2012).

*This research is supported by Science, Industry and Technology Ministry of Turkey under project number SANTEZ 1386.STZ.2012-1. The author acknowledges support from MPNS COST ACTION MP1204 - TERA-MIR Radiation: Materials, Generation, Detection and Applications.

Deposition of graphene/ graphene-related phases on different substrates by thermal decomposition of acetone

T.I. Milenov

¹⁾*Institute of Electronics- Bulgarian Academy of Sciences, 1784 Sofia, Bulgaria
teddymilenov@abv.bg*

We present results on the deposition of graphene and graphene-related phases by chemical vapour deposition (CVD) method. The source of carbon/carbon containing radicals is thermally decomposed acetone (C_2H_4CO) in Ar main gas flow at different temperatures depending on the substrate used. The deposition of graphene and/or graphene related phases takes place on (001) Si, Cu, Ni, (75 at.% Cu + 25 at.% Ni), Mu-Metal (16 at.% Fe + 77 at.% Ni+ 5 at.% Cu+ 2 at.% Cr) and SS304 (~67 at.% Fe + 9 at.% Ni+ 20 at.% Cr + 2 at.% Mn + 0.8 at.% Si) substrates. The obtained thin films are studied by optical microscopy, X-ray powder diffraction and grazing incidence beam, Raman (Fig.1) and X-ray photoelectron spectroscopies (XPS). We determined the optimal temperature of the CVD process for each substrate for fixed values of the remaining parameters.

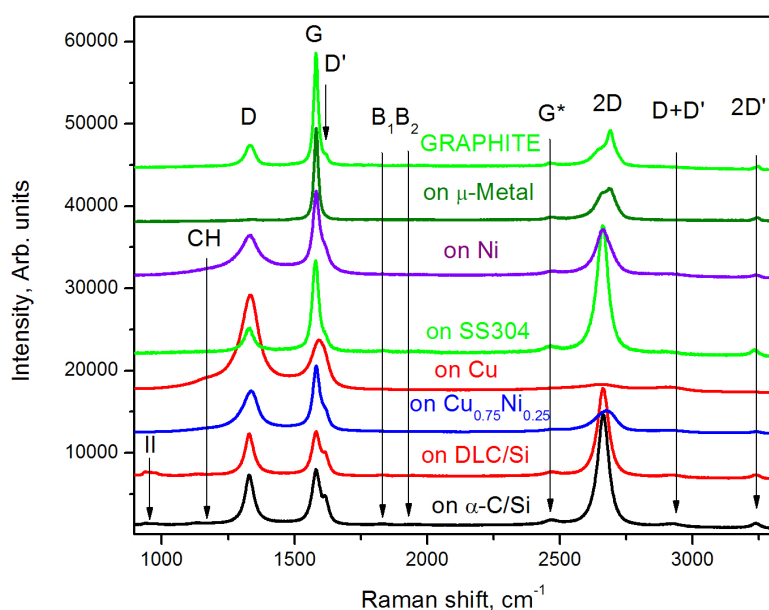

Fig. 1. Raman spectra of graphite and graphene/ graphene- related phases deposited on different substrates.

The author acknowledges support from MPNS COST ACTION MP1204 - TERA-MIR Radiation: Materials, Generation, Detection and Applications.

The analogy and differences between Sub-Tera-Flux Flow Oscillator and Graphene, Semiconductor Superlattices

F. V. Kusmartsev

Department of Physics, Loughborough University, LE11 3TU, UK

F.Kusmartsev@lboro.ac.uk

We present experimental and numerical results for a flux flow oscillator based on superconducting Josephson Junctions[1]. Our computationally efficient theoretical model takes into account Josephson self-coupling of the Flux Flow Oscillator (FFO) and is in a good agreement with our experimental results and previous studies. We consider also topological excitations a semiconductor superlattice (SL) in magnetic field and show analogy between these two considered systems[2,3]. In particular, in a SL made of semiconductors like BN and graphene placed in crossed static electric and magnetic fields, under certain conditions, the inversion of electron population can appear at which the average energy of electrons is above the middle of the mini band and the effective mass of the electron is negative. This is the implementation of the negative effective mass amplifier and generator (NEMAG) in the superlattice. It can result in the amplification and generation of terahertz radiation even in the absence of negative differential conductivity in a similar way as it was described and obtained in the Refs for FFOs[4,1].

References

- [1] D. Gulevich, P.N. Dmitriev, V. P. Koshelets, and F. V. Kusmartsev, NANOSYSTEMS: PHYSICS, CHEMISTRY, MATHEMATICS, 4, 490, (2013).
- [2] A. E. Hramov, et al., Phys. Rev. Lett, 112, 116603 (2014).
- [3] A.V. Shorokhov, et al, JETP Lett., 100, pp. 766–770, (2014).
- [4] V.A. Yampol'skii, et al., Phys. Rev. B75, 014527 (2007).

The author acknowledges support from MPNS COST ACTION MP1204 - TERA-MIR Radiation: Materials, Generation, Detection and Applications.

Graphene-enabled Electrically-Controlled Terahertz Light Modulators

N. Kakenov¹, T. Takan², V.A. Ozkan², O. Balci¹, EO. Polat¹, H. Altan², C. Kocabas¹

¹*Bilkent University Department of Physics, Ankara, Turkey*

²*Middle East Technical University, Department of Physics, Ankara, Turkey*
taylan.takan@metu.edu.tr

We demonstrate a THz light modulator working at reflection mode using large area graphene supercapacitors. Our approach relies on controlling charge distribution on graphene electrodes. We fabricated the device using large area graphene (5x5 cm²) synthesized by chemical vapor deposition on copper foils and transferred on THz transparent PVC with 75 μm width. The other side of PVC was coated with 100 μm gold using a box coater. The device acts as a controllable Salisbury screen. By changing the voltage bias we were able to modulate the THz reflectance through the device with modulation level of ~ 10 dB. A schematic of the experimental set-up used for THz transmission measurements is given in Figure 1c. A VDI Schottky diode based, multiplied mm-wave/THz emitter is used as a tunable frequency signal source. Driven by a voltage-controlled frequency-tunable YIG oscillator, the system can provide a minimum average output power of about 1 mW, in the frequency region of 240-380GHz. The output of the source is amplitude modulated and measured via a Golyay Cell. The output beam was collimated and then, after passing through a silicon wafer which acts as a beam splitter, focused onto the device. The spot diameter was measured to be ~ 3 mm at the device position. The radiation was then collected and focused onto the receiver.

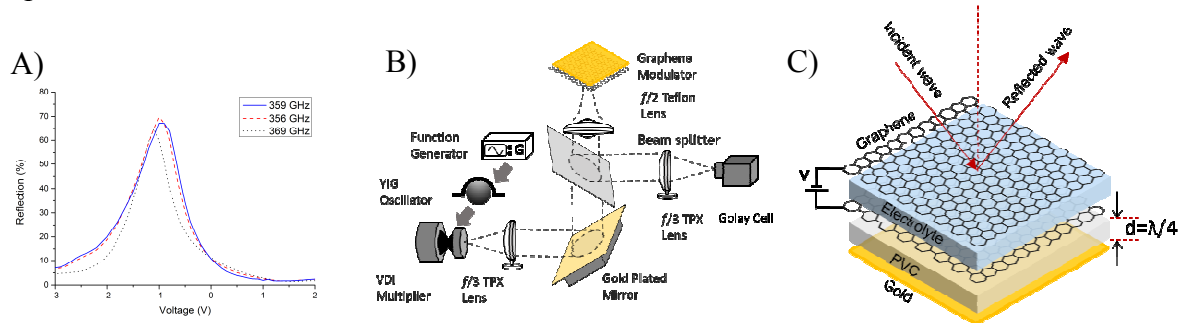

Fig.1 A) Normalized power reflectance with applied bias voltage. B) Schematic of the experimental set-up. C) Schematic drawing of the THz light modulator.

References

- [1] Rahm, M.; Li, J. S.; Padilla, W. J. *J Infrared Millim Te* **2013**, 34, (1), 1-27.
- [2] Sirtori, C.; Barbieri, S.; Colombelli, R. *Nature Photonics* **2013**, 7, (9), 691-701.
- [3] Tonouchi, M. *Nature Photonics* **2007**, 1, (2), 97-105.

The author acknowledges support from MPNS COST ACTION MP1204 - TERA-MIR Radiation: Materials, Generation, Detection and Applications.

Artificial graphene: a useful playground for THz spectroscopy?

L. Nádvořník* and K. Výborný

Institute of Physics, AS CR, v.v.i., Cukrovarnická 10, Prague 162 00, Czech Republic

**nadvl@fzu.cz*

Having its ideological roots in the studies of lateral superlattices in the 90ths [1], the concept of the artificial graphene [2] developed shortly after the experimental discovery of the real graphene in 2004 [3] as a synthesis of these both fields of interest. As it was anticipated theoretically [2], a system governed by the unique behaviour of the massless fermions, typical for the real graphene, might be fabricated by creating a lateral superlattice reflecting graphene-like symmetry on top of a two-dimensional electron system (2DES). Properties of such a structure would be then widely tunable by simply varying the lithographical parameters, doping and by other means during its fabrication. In spite of this promising prediction, the first experimental and further theoretical insights [4,5] revealed that even the real observation of Dirac fermions in these systems is significantly demanding and the experimentalist is forced to work at (or even beyond) the limits of current technologies and experimental tools. This is the reason why the direct observation of the Dirac fermions in the artificial graphene has not been yet performed.

In this contribution, it will be discussed why the THz spectroscopy of Landau levels could be a promising experimental tool as it makes accessible the optical transitions in order of units of meV. Together with the theoretical conclusions, the experimental data of FIR and THz spectroscopy of Landau levels will be commented from the point of view of a 2DES perturbed by a graphene-like potential modulation.

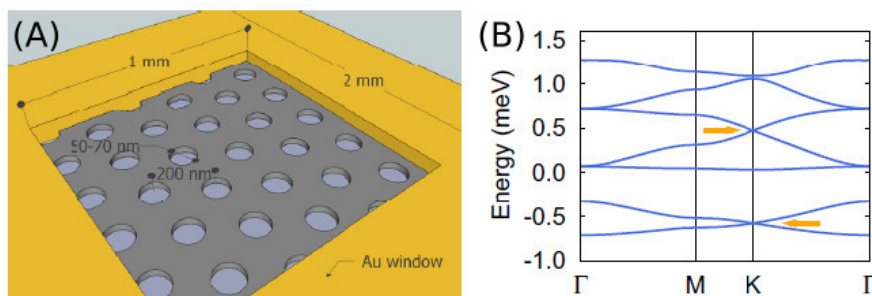

Fig. 1: Concept of artificial graphene. (A) A sketch of the optically probed sample with its antidots array on the surface. (B) The miniband structure calculated for a convenient superlattice constant and the modulation potential. Dirac cones are indicated by arrows.

References

- [1] D. Weiss et al, Europhys. Lett. 8, 179 (1989); A. Soibel et al, Semicond. Sci. Technol. 11, 1756 (1996); C. G. Smith et al, J. Vac. Sci. Tech. B 10, 2904 (1992)
- [2] Ch.-H. Park and S. G. Louie, NanoLett. 1793-1797 (2009)
- [3] K. S. Novoselov et al, Science 306, 666 (2004)
- [4] M. Gibertini et al., Phys. Rev. B 79, 241406 (2009)
- [5] L. Nadvornik et al, New J. Phys 14, 053002 (2011)

Validation of molecules force field parameters using Terahertz spectroscopy

M. Mernea, O. Calborean, D.F. Mihailescu

University of Bucharest, Faculty of Biology, Splaiul Independentei, No 91-95, 050095,
Bucharest, Romania
dan.mihailescu@bio.unibuc.ro

Lipopolysaccharides (LPS), the main constituents of Gram-negative bacteria outer membranes, are highly toxic and can induce septic shock in humans. Here we used THz spectroscopy and molecular modelling in order to validate the CHARMM force field parameters of bacterial lipopolysaccharides (LPS) that we derived in a previous study [1]. The THz spectra of five LPS molecules and of a hydrated LPS monolayer (Fig.1 a-c) were simulated (Fig.1 d,e) and compared to the THz spectrum recorded on LPS molecules dissolved in a chloroform/methanol mixture (Fig.1 f). The agreement between theoretical and experimental results allows us to validate LPS simulation parameters. Future refinement of the parameters should lead to an even better agreement.

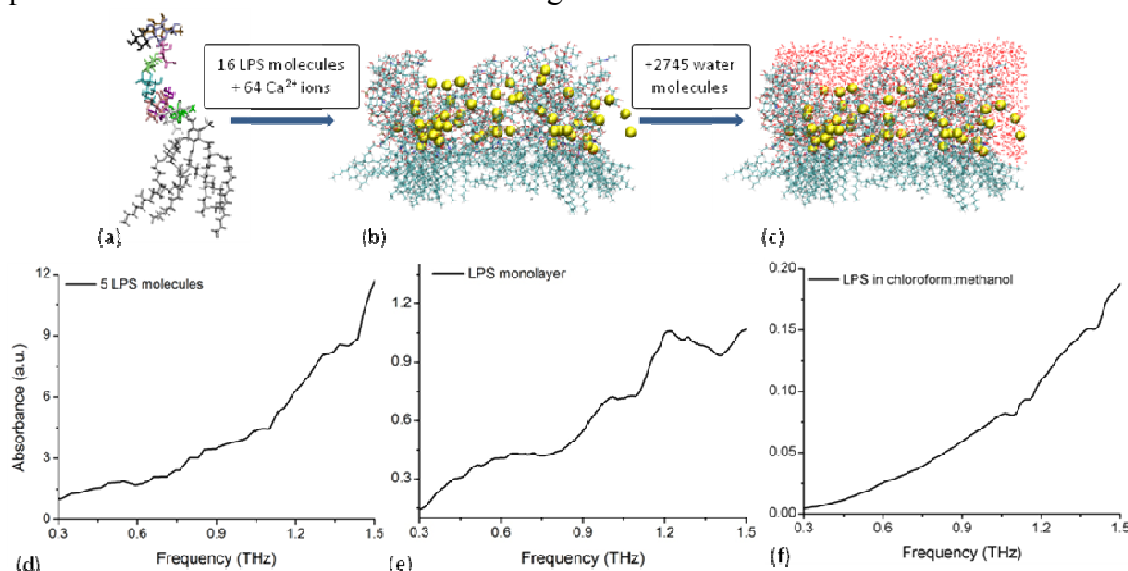

Figure 1. (a) 3D structure of a LPS molecule. (b) A LPS monolayer (in cyan) and the 64 Ca^{2+} ions (in yellow) associated with the monolayer. (c) Hydrated LPS monolayer (water molecules are represented as red dots). (d) Simulated THz spectrum of a single LPS molecule. (e) Simulated THz spectrum of the LPS monolayer. (f) ATR THz spectrum recorded on LPS molecules dissolved in a chloroform/methanol mixture.

References

[1] A. Moraru, I. Svab, D.F. Mihailescu, *Revue Roumaine de Chimie*, 54, 799–805 (2009).

The author acknowledges support from MPNS COST ACTION MP1204 - TERA-MIR Radiation: Materials, Generation, Detection and Applications. Research presented here was financially supported by the Romanian Ministry of Education, Research, Youth and Sport through the “IDEAS” Project 137/2011 and the “PCCA” Project 198/2014.

Terahertz homodyne self-mixing: A new spectroscopic technique - Basics and two-dimensional tomographic imaging applications

T. Mohr¹, S. Breuer, D. Blömer, M. Simonetta, S. Patel, M. Schlosser, A. Deninger, G. Birkel, G. Giuliani and W. Elsässer

¹Technische Universität Darmstadt, Schlossgartenstr. 7, Darmstadt, GER
till.mohr@physik.tu-darmstadt.de

We experimentally demonstrate a novel terahertz spectroscopy concept by combining both continuous-wave terahertz radiation generation and phase-sensitive detection in a single photoconductive antenna (PCA). The optical beat signal of two single-mode lasers impinges on a dc-biased fiber-coupled PCA. Within the Rayleigh length of the terahertz radiation a revolving chopper wheel (RCW) is placed, which back-reflects the radiation onto the PCA, giving rise to an AC photocurrent in the PCA [1].

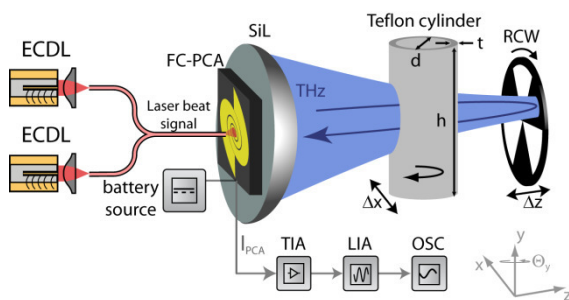

Fig. 1 Schematic of the experimental set-up. ECDL external cavity diode laser; FC-PCA Fiber-coupled photoconductive antenna; SiL silicon lens; RCW revolving chopper wheel; TIA transimpedance amplifier; LIA lock-in amplifier OSC - digital oscilloscope.

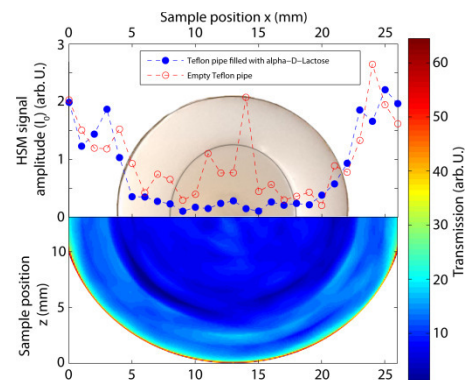

Fig. 2 (Upper part) Top view on the investigated Teflon cylinder and experimentally HSM signal amplitudes I_0 for a sample scan in x-direction for a rotation angle Θ of 0° without (empty circles) and with (filled circles) α -Lactose filling. (Lower part) Two-dimensional image of the Teflon cylinder filled with α -Lactose reconstructed by the inverse radon transformation at 0.539 THz.

This signal is derived theoretically, by the calculation of the total current at the PCA considering the electrical field of the back-reflected radiation and can be expressed by

$$HSM(z) = I_0 \cdot \cos\left(\frac{4\pi}{\lambda} \cdot z\right) \quad (1)$$

where λ is the wavelength of the terahertz field and z represents the displacement of the RCW. As a proof-of-concept application we perform 2D terahertz tomography imaging and reconstruct the 2D image of a hollow-core Teflon cylinder filled with α -lactose. By measuring the homodyne self-mixing signals for the Teflon cylinder at different x-positions and for different rotation angles, we can reconstruct the cylinder and identify its filling by using two different terahertz frequencies of 0.19 and 0.539 THz.

References

[1] T. Mohr, S. Breuer, D. Blömer, M. Simonetta, S. Patek, M. Schlosser, A. Deninger, G. Birkel, G. Giuliani and W. Elsässer, Appl. Phys. Lett., 106 (2015).

The author acknowledges support from MPNS COST ACTION MP1204 - TERA-MIR Radiation: Materials, Generation, Detection and Applications.

Dispersion of carbon nanotubes in melt compounded polypropylene based composites investigated by THz spectroscopy

R. Casini, G. Papari, A. Andreone*

Physics Department, University of Naples "Federico II", Naples, Italy

andreone@unina.it

D. Marrazzo, A. Patti

Department of Chemical, Materials Engineering and Industrial Production, University of Naples "Federico II", Naples, Italy

P. Russo

Institute for Polymers, Composites and Biomaterials, National Research Council, Pozzuoli (Na), Italy

We investigate the use of Terahertz Time Domain Spectroscopy as a tool for the measurement of the index dispersion of multi walled carbon nanotubes in polypropylene based composites. Samples containing 0.5% by volume concentration of not functionalized and functionalized carbon nanotubes are prepared by melt compounding technology. Results indicate that the THz response of the investigated nanocomposites is strongly dependent on the kind of nanotube functionalization, which in turn impacts on the level of dispersion inside the polymer matrix. We show that specific dielectric parameters such as the refractive index and the absorption coefficient measured by THz spectroscopy can be both correlated to the index of dispersion as estimated using a traditional and well established approach based on the analysis of optical microscopy images performed on purpose-prepared nanocomposite slices.

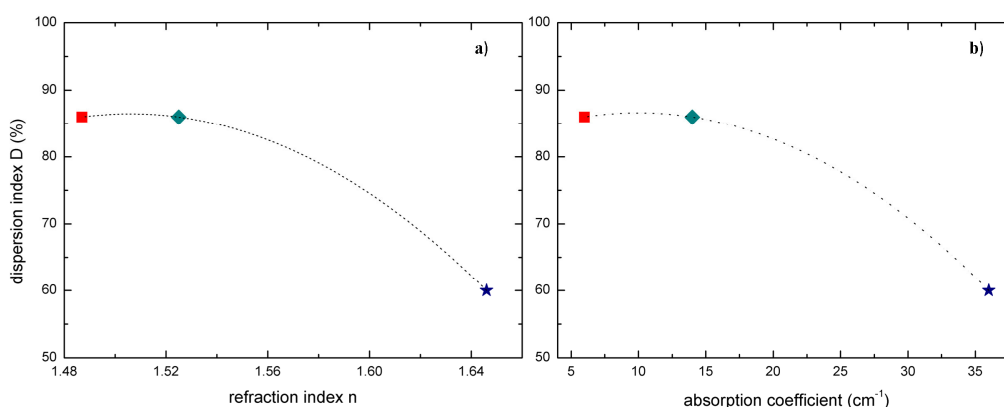

Plot of the degree of dispersion D as estimated using optical microscopy vs (a) refractive index n and (b) absorption coefficient α values measured through THz spectroscopy for the nanocomposites with 0.5% in vol. MWCNT having different functionalization: pristine (■), with amino groups (◆), with carboxyl groups (★). The frequency of investigation is 0.55 THz. The dashed curves represent a guide-to-the-eye only.

The author acknowledges support from MPNS COST ACTION MP1204 - TERA-MIR Radiation: Materials, Generation, Detection and Applications.

THz-TDS investigation of dielectric properties of CaZrO₃.

Ľ. Bača¹, M. Janek^{1,2}, Z. Kováčová¹ and M. Naftaly³

¹ Department of Ceramics, Glass and Cement Technology, Slovak University of Technology, Radlinského 9, SK-81237 Bratislava, Slovakia

² Comenius University, Faculty of Natural Sciences, Department of Physical and Theoretical Chemistry, Mlynská dolina CH1, SK-84215 Bratislava, Slovakia

³ National Physical Laboratory, Hampton Rd, Teddington, Middlesex, TW11 0LW, UK
marian.janek@fns.uniba.sk and mira.naftaly@npl.co.uk

Calcium zirconates (CaZrO₃) are known for their interesting optical, electrical, and physico-chemical properties. The electronic, electro-mechanical, and conductive properties of CaZrO₃ doped with specific trivalent rare earth ions promote upconversion processes, where the absorption of two or more lower-energy photons leads to the emission of a higher energy photon. The upconversion materials are based on the f-f transitions of rare earth dopants, which show rich luminescence spectra consisting of a large number of distinct transition lines. Thus upconverting phosphor materials based on CaZrO₃ can be synthesized which are suitable for diode lasers, display devices, and other photonic applications with excitation in the near infrared (NIR) region.[1] Only a few reports dedicated to dielectric or spectral properties of CaZrO₃ in the far infrared region can be found in the literature. For this reason we have investigated the effect of Er³⁺ and Li⁺ content on 2 mol % Yb³⁺ doped CaZrO₃, which were sintered for 1 hour at two different temperatures, 1300 and 1500 °C.

The preliminary results achieved by the THz-TDS technique in the transmission mode, using femtosecond-laser driven photoconductive emitter and electro-optic detector in the frequency range of about 0.2-3.0 THz are shown in Figure 1. The material absorption as function of refractive index almost doubled when the Er³⁺ content in the material decreased from 5 to 1 mol % (A4 ~ 5 mol %, A8 ~ 2 mol %, A12 ~ 1 mol %), while the refractive index (RI) increased from 3.25 to 3.80. This behaviour is strongly affected by sintering temperature as the ample A12 sintered at 1300°C showed more than 5 times lower absorption and the RI of 3.11. The addition of Li⁺ ions to the structure increased both absorption and RI to 3.72. The X-ray diffraction patterns proved the structural similarity of perovskite materials sintered at different temperatures, however, the higher temperature induced slightly higher crystallinity in the studied samples. The differences in their dielectric behaviour and electronic conductivity may therefore be attributed to the improved crystals order, but better understanding of these systems require a more detailed investigation.

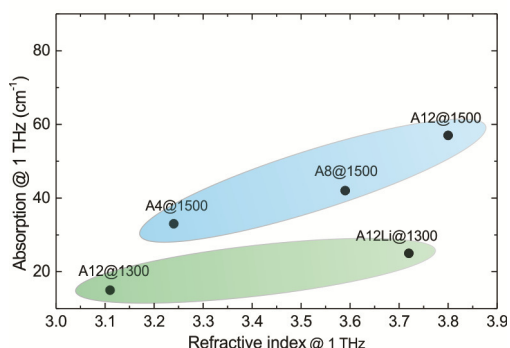

Figure 1. Effect of Er³⁺ and Li⁺ content on Yb³⁺ doped CaZrO₃ absorption properties as function of refractive index of the materials sintered at 1300 and 1500 °C.

References

[1] V. Singh, V. K. Rai and M. Haase, J. Appl. Phys. 112, 063105 (2012).

The authors acknowledge support from MPNS COST ACTION MP1204 - TERA-MIR Radiation: Materials, Generation, Detection and Applications. The financial support of the Slovak Grant Agency for Science VEGA (grant No. 1/0943/13) and of the Slovak Research and Development Agency APVV (grant APVV-0291-11) is greatly appreciated. The project was also supported by Centre for applied research of new materials and technology transfer of STU (ITMS 26240220088). Work at NPL was supported by the National Measurement office of the U.K.

Photonic-based generation of ultra-pure THz radiation

Jesus Palaci, Maria Jose Garcia-Martínez and Á. Ruben Criado

Luz WaveLabs S. L., Avenida Gregorio Peces Barba, 28919 Leganes, Madrid

We report on a photonic system for generation of high quality continuous-wave THz signals. The system consists of an optical frequency comb generator and a mechanism that performs selective mode filtering. Our device surpasses the performance of commercially available mm-wave and sub-THz generation systems, matching and even overcoming those of the best commercially available electronic THz generation systems. Signals with a linewidth at or below 10 Hz are generated for the complete frequency range (60–140 GHz in our experiments) with a resolution in the order of 0.1 Hz at 120 GHz and considerable long-term stability (5 Hz deviation over one hour). Most of these values are limited by the measurement instrumentation accuracy and resolution, thus the actual values of the system could be better than the reported ones. The frequency range can be extended straightforwardly up to the optical comb bandwidth without significant degradation. Our system is compact, robust and reliable, being especially suited for THz photonic local oscillators and high resolution spectroscopy.

Compressive Sensing Imaging and Image Fusion at sub-THz frequency in Transmission Mode

V. A. Özkan, T. Takan, H. Altan

Middle East Technical University, Dumlupınar Bulvarı No: 1, TR-06800 Ankara, Turkey
vedataliozkan@gmail.com

Due to lack of widespread array imaging techniques in THz range, applications are being investigated using compressive sensing (CS). CS has been shown to effectively generate images of objects by manually controlling pixels on the image plane and focusing the light on a single pixel THz detector [1]. The purpose of this work is to reconstruct the image of an object by sampling at a rate below the Nyquist limit and fusing the sub-THz image with a visible image. In the experiment, the imaging is accomplished by obtaining transmission pattern of a sample negative F letter, which is cut from aluminum sheet of 0.05 mm thickness. A Virginia Diode Instruments (VDI) source at 113GHz is used as the sub-THz frequency signal source. Transmitted signals are amplitude modulated via power supply switching and the received signals are measured via a Goly Cell (Tydex TC-1T) and lock-in amplifier. The 10 x 10 random array patterns are fabricated by a 40kHz repetition rate pulsed fiber laser with 0.5mJ average pulse energy and 25 kW peak power per pulse (Fiberlast NanoMark 20W). The pixels have dimensions of 3x3mm.

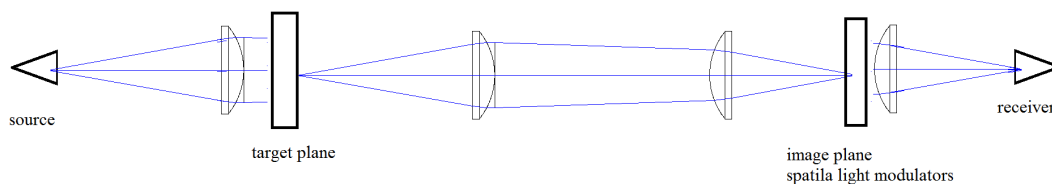

Fig. 1 THz signal is obtained from an yttrium iron garnet oscillator's (YIG oscillator) output, multiplied by VDI Schottky diodes to 113 GHz. Then an F# 3, TPX lens with 50 mm diameter collimates the light. The spatial light modulator and the target are separated by two f#2 lenses to minimize optical sources of error. Finally an F# 2 Teflon lens with 50mm diameter focuses the light on receiver, a Goly cell. The target is an aluminum negative F letter.

The set-up shown in Fig. 1 is used to demonstrate that a highly reflective, metal negative surface can be imaged. To reconstruct the image Total Variation (TV) minimization algorithm is used [2]. To assess the performance of the algorithm the reconstructed image was compared to the simulation of the ideal target. The comparison was done using the χ^2 image quality assessment (IQA) index. Moreover image fusion was assessed using Natural Image Quality Evaluator.

References

- [1] T. Takan, V. A. Özkan, F. İdikut, İ. O. Yıldırım, A. B. Şahin and H. Altan, "Compressive sensing imaging through a drywall barrier at sub-THz and THz frequencies in transmission and reflection modes", Proc. SPIE 9244, Image and Signal Processing for Remote Sensing XX, 92441N (2014)
- [2] L. I. Rudin, S. Osher and E. Fatemi, "Nonlinear total variation based noise removal algorithms" Phys. D 60, 259 (1992)

Radiation: Terahertz, Compressive Sensing, Image fusion

Detection of Far-Infrared Radiation using Glow Discharge Detectors (GDDs)

E. Küçükkeskin, N. Alasgarzade, I. U. Uzun-Kaymak, H. Altan
Department of Physics, Middle East Technical University, Dumlupınar Blv, No:1, 06800
Ankara, Turkey
haltan@metu.edu.tr

The plasma medium which is created inside the GDD enables us to detect a wide wavelength range of differential or modulated EM signals impinging on them [1-2]. The interaction between the plasma and various frequency EM waves are still being investigated and in the terahertz range the interaction mechanism is still not well understood [1]. To understand the interaction better commercially available GDDs were studied using both time-domain and continuous wave mm wave/THz measurement systems. Using a 113GHz Schottky diode multiplied source the detection behaviour of the detector was investigated while the interaction of the GDD structure with the THz field was investigated between 100-1000GHz. The GDD response is similar to other commercially available room temperature mm wave/THz detectors and performs at a fraction of their cost. Using lock-in detection techniques the response was characterized at modulation frequencies up to 100 kHz. Furthermore the orientation of the electrode structure was sensitive to the polarization of the incident field. The polarization sensitive behaviour indicates a strong coupling between the incident and native field in the plasma. These effects were investigated by transmitting a broadband THz pulse through the structure for when the device was on and off. Within the constraints on the maximum modulation frequency of the THz transmitter antenna, certain THz frequencies are attenuated suggesting the electrode structure of the GDD can play a role in the detection. Future work will entail understanding the interaction by using numerical simulations modelling of a similar geometric structure with a glow discharge under modulated EM wave illumination.

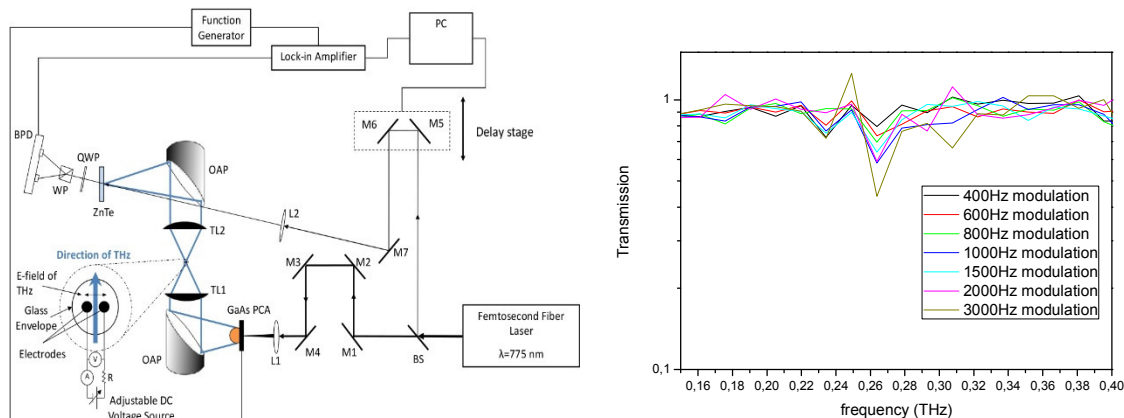

Fig. 1 Various GDDs were studied using a home-built time-domain THz spectrometer. The transmission was seen to be attenuated at certain frequencies (above near 0.27THz) which was observed to increase with modulation of the THz transmitter.

References

- [1] K. Çınar, H. M. Bozaci, and H. Altan, "Characterization of a Glow Discharge Detector with Terahertz Time Domain Spectroscopy," *IEEE Sensors J.*, **13**, 2643-2647 (2013).
- [2] N. S. Kopycka, and N. H. Fahrat, "Video detection of Millimeter Waves with Glow Discharge Tubes: Part I-Physical Description; Part II- Experimental Results," *IEEE Trans. Electron. Devises*, ED-22, 534-548 (1975).

The author acknowledges support from MPNS COST ACTION MP1204 - TERA-MIR Radiation: Materials, Generation, Detection and Applications and The Scientific and Technical Research Council of Turkey (TUBITAK) under grant # 113F321

Rapid-Scan Fiber-Integrated Terahertz Spectrometer for Time-Resolved Measurements

H. Keskin¹, F. Ö. İlday^{2,3}, K. Eken⁴, and B. Şahin⁵, H. Altan¹

¹Department of Physics, Middle East Technical University, Turkey

²Department of Electrical and Electronics Engineering, Bilkent University, Turkey

³Department of Physics, Bilkent University, Turkey

⁴FiberLAST, ODTU Teknokent Galyum Blok Z-3, Turkey

⁵Department of Electrical and Communication Engineering, Yıldırım Beyazıt Uni., Turkey
keskin.hakan@metu.edu.tr

Repetition rate tuning enables the fast acquisition of THz pulse profiles [1]. In other words, by adjusting the time delay between two pulses by tuning repetition rate of a low-timing-jitter ultrafast laser source, the speed of acquisition of the THz transient can be dramatically improved [2]. By using this method we demonstrate a compact and broadband terahertz time domain spectroscopy system (THz-TDS) driven by ytterbium doped fiber laser source. The importance of this method is realized in that Yb-doped fiber lasers can be amplified to sub-milli joule to be used in rapid excite-THz probe experiments. In our previous study we showed that the home-built laser was stable during the repetition rate tuning [2]. Here we demonstrate the obtained THz waveforms during the tuning of the repetition rate. The tuning is done by using a fast moving voice-coil stage which is placed in the oscillator as shown in Fig. 1(a). The obtained THz waveform is shown in Fig. 1(b). With the addition of a third amplified output to the constructed fiber laser future work will investigate the use of the multi-port system in dynamical investigation of materials using excite-probe measurements.

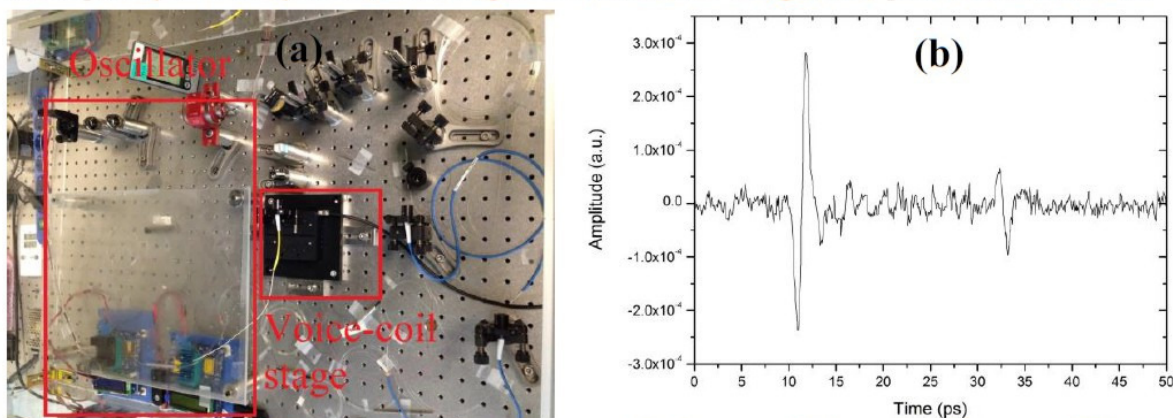

Fig. 1(a) Picture of Yb-doped fiber laser system **(b)** Measured THz pulse using two different ports of Yb-doped fiber laser as THz generation and detection arm

References

- [1] R. Wilk, T. Hochrein, M. Koch, M. Mei, and R. Holzwarth, "Terahertz spectrometer operation by laser repetition frequency tuning," *J. Opt. Soc. Am. B*, **28**(4), 592–595 (2011).
- [2] H. Keskin, H. Altan, S. Yavas, F. O. İlday, K. Eken, and A. B. Şahin, "Development of a rapid-scan fiber-integrated terahertz spectrometer," *Opt. Quantum Electron.*, **46**(4), 495–503 (2014).

The author acknowledges support from MPNS COST ACTION MP1204 - TERA-MIR Radiation: Materials, Generation, Detection and Applications. This project was funded under The Scientific and Technological Research Council of Turkey Grant # 111T748.

Spectroscopy of Mie resonances in single TiO₂ microspheres

Oleg Mitrofanov,^{1,2} Filip Dominec,³ Petr Kužel,³ John L. Reno,^{2,4} Igal Brener,^{2,4}
U-Chan Chung,⁵ Cathy Elissalde,⁵ Mario Maglione,⁵ and Patrick Mounaix⁵

¹ *University College London, London, UK*

² *Center for Integrated Nanotechnologies, Sandia National Laboratories,
Albuquerque, NM, USA*

³ *Academy of Sciences of the Czech Republic, Czech Republic*

⁴ *Sandia National Laboratories, Albuquerque, NM, USA*

⁵ *ICMCB, Univ. Bordeaux, CNRS, France*

⁶ *LOMA, Univ. Bordeaux, CNRS, France*

o.mitrofanov@ucl.ac.uk

Sub-wavelength size dielectric resonators have attracted much interest recently as elements with effective magnetic response that can be used in metamaterials. This magnetic response occurs in a high-permittivity, sub-wavelength size dielectric particle as a result of the lowest order resonance, known as the 1st Mie mode or the magnetic dipole (MD) mode. At THz frequencies, there is a range of high-permittivity materials (with $\epsilon > 100$), which can provide isotropic alternatives to split-ring resonators. Such resonators however present a difficult problem for experimental investigations due to their sub-wavelength size.

We demonstrate a THz near-field method for spectroscopy and mapping of Mie resonances in single sub-wavelength size ($\sim \lambda/10$) resonators. We investigate the magnetic dipole and electric dipole modes in single TiO₂ micro-spheres using THz near-field microscopy and a sub-wavelength aperture probe [1]. We exploit the effect of the resonator on transmission of a plane wave through a sub-wavelength size aperture. The transmission spectrum exhibits clear signatures for the MD as well as electric dipole modes [2]. The experimental results agree with numerical simulations. The spectral signature of the MD mode in this measurement can be described analytically as a Fano resonance. The near-field mapping of the field near the resonator displays the spatial mode signatures and reveals the effect of mode degeneracy lifting in elliptical resonators.

References

[1] A. J. Macfaden et al., Appl. Phys. Lett. 104, 011110 (2014)

[2] O. Mitrofanov et al., Opt. Express 22, 23034 (2014)

The author acknowledges support from MPNS COST ACTION MP1204 - TERA-MIR
Radiation: Materials, Generation, Detection and Applications.

POSTERS

Achieving a negative refractive index in arrays of dielectric rods

Filip Dominec, Christelle Kadlec, Hynek Němec, Petr Kužel and Filip Kadlec

Institute of Physics, Academy of Sciences of the Czech Republic, Na Slovance 2, 18221, Prague 8, Czech Republic
kadlec@fzu.cz

The square array of TM-polarized cylindrical dielectric rods is one of the simplest periodic structures that was studied both as a photonic crystal (PhC) and as a metamaterial (MM) with a possibly negative index of refraction n [2]. Using FDTD simulations and an unambiguous algorithm for refractive index retrieval, we illustrate [1] a qualitative transition between the PhC and MM regimes upon a continuous variation of structure parameters.

In the MM limit, a photonic band with $n < 0$ can occur in an overlap of the regions of negative permittivity ε (due to an electric Mie resonance) and permeability μ (due to a magnetic Mie resonance), (Fig. 1a). Both resonance frequencies depend not only on the rod radius, but also on the unit-cell size a in the way denoted by the thick line in Fig. 1c. For too sparse rods, the regions of $\varepsilon < 0$ and $\mu < 0$ do not overlap. For too dense rods, the circular nodal planes that were characteristic for individual Mie resonances join with those of neighbouring cells, changing their topology to a continuous one, typical e.g. of a 1D PhC. Accordingly, both individual Mie resonances abruptly merge, their resonance peaks disappear and an ordinary (Bragg) forbidden band is formed, (Fig. 1b). The range of frequencies and unit cell sizes required for $n < 0$ are denoted by the black patch in Fig. 1c.

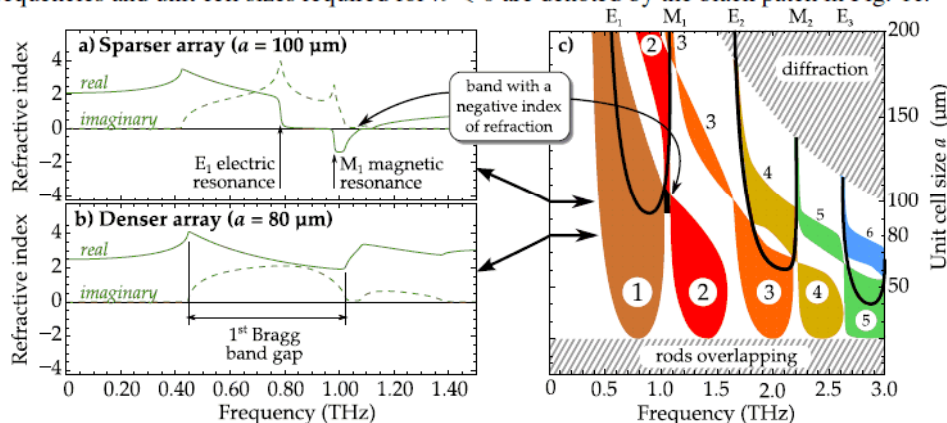

Figure 1: **a)**, **b)** Index of refraction for rods made of a dielectric with $\varepsilon = 100$ and $10 \mu\text{m}$ radius, for two different unit cell sizes $a \in \{100, 80\} \mu\text{m}$, **c)** A continuous scan over $a \in (20, 200) \mu\text{m}$. The forbidden bands are identified by colours and Mie resonances outlined by a thick black curve.

We conclude that an array of dielectric rods can exhibit $n < 0$ in a narrow range of frequencies, however, with requirements for the filling fraction much stricter than previously thought [2]. The dielectric permittivity contrast must be higher than ca. 50, which is possible in the THz range if the rods are made of e.g. titanium dioxide or a ferroelectrics. To our knowledge, there is no dielectric material exhibiting such a high permittivity at the near-infrared or optical frequencies.

The authors acknowledge the support of the Czech Science Foundation under the Grant No. 14-25639S.

References

- [1] F Dominec, C Kadlec, H Němec, F Kadlec, and P Kužel. Metamaterial to photonic crystal transition in arrays of dielectric rods. *Opt. Express*, 22:30492, 2014.
- [2] Didier Felbacq, Brahim Guizal, G Bouchitte, and C Bourel. Resonant homogenization of a dielectric metamaterial. *Microw. Opt. Techn. Let.*, 51(11):2695–2701, 2009.

Mirror coatings for InGaAs/InAlAs/InP mid-IR QCL

P. Karbownik, A. Trajnerowicz, A. Wójcik- Jedlińska, M. Sakowicz,
P. Gutowski, M. Bugajski

Institute of Electron Technology, al Lotnikow 32/46 02-668 Warszaw , Poland
pikarb@ite.waw.pl

This work presents results of work towards manufacturing high reflective (HR) and anti reflective (AR) coatings on InGaAs/InAlAs/InP Quantum Cascade Lasers (QCLs) with sputtering system. The similar technique for mirror coatings was presented in Nguyen work [1]. For HR coatings we used metallic coatings proposed in [2]. In contrast to coatings for GaAs based QCLS [3] one of key step in this technology is surface pretreatment before coating deposition. In the Fig. 1. there is results of LIV measurements for chip with developed coatings.

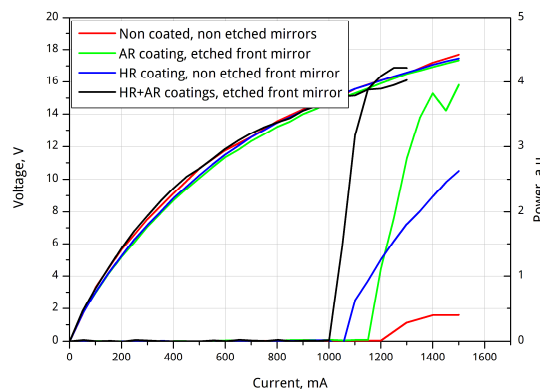

Fig. 1. LIV characteristics of the same laser chip without coatings, with AR coating, HR coating, and HR+AR coatings.

As it can be seen not only coatings has impact on final characteristics but also etching of cleaved mirrors.

References

- [1] J. Nguyen, J. S. Yu, A. Evans, S. Slivken, M. Razeghi, Appl. Phys. Lett. 89, 111113 (2006)
- [2] H. Page, P. Collot, A. de Rossi, V. Ortiz, C. Sirtori, Semicond. Sci. Technol. 17, 1312–1316 (2002)
- [3] Bugajski et al Phys. Status Solidi B, 251, 1144-1157 (2014)

This work was financially supported by the National Center for Research and Development (Poland) grant no. PBS 1/B3/2/2012 (EDEN). Authors acknowledge also support from MPNS COST ACTION MP1204 - TERA-MIR Radiation: Materials, Generation, Detection and Applications.

Optimization of MBE growth of InSb on semi-insulating GaAs substrate for mid-wavelength infrared detectors

A. Ratajczak^{1,2}, R. Weih¹, J. Misiewicz², S. Höfling¹

¹ Technische Physik, Physikalisches Institut and Wilhelm Conrad Röntgen Research Center for Complex Material Systems, Universität Würzburg, Am Hubland, D-97074 Würzburg, DE

² Institute of Physics, Wrocław University of Technology, Wybrzeże Wyspiańskiego 27, 50-370 Wrocław, PL

albert.ratajczak@physik.uni-wuerzburg.de

Mid-wavelength infrared (MWIR) detectors are devices of interest mainly due to their possible application in gas detection or thermal imaging. InSb, due to its small band gap, is a perfect candidate for detection of MWIR radiation in the wavelength range from 3 to 7 μm . Although InSb based MWIR detectors have already been reported [1], the growth of InSb in molecular beam epitaxy (MBE) process still remains a challenge. The main reasons causing problems are the low melting point of InSb (527 $^{\circ}\text{C}$), the low growth temperature, and the big lattice constant, which complicates the growth of heterostructures.

Optimized growth conditions for epitaxy of InSb on semi-insulating (SI) GaAs substrate are presented. A series of samples, each with a 500 nm thick InSb layer on SI GaAs substrate was grown and characterized. The smoothest sample has a root mean square (RMS) roughness of 4.6 \AA measured by atomic force microscope (AFM) (see Fig. 1). It is only about 2.2 times bigger value than RMS roughness of the surface of an epi-ready InSb wafer. High resolution X-ray diffraction (HRXRD) measurements indicate that InSb layers are almost fully relaxed in our samples. The calculated relaxation level is 99.3%.

Based on the growth optimization we were able to grow an InSb $p^+-p^-n^+$ structure on SI GaAs-substrate (see Fig. 1) designed for application as a MWIR detector. Although some more efficient designs for infrared detectors have already been proposed (e.g. cascade infrared detectors [2]), InSb-detectors based on a p-n junction are interesting for several reasons. The efficiency offered by those detectors is sufficient for some applications, the design is simpler and the manufacturing costs are lower compared to more complex structures.

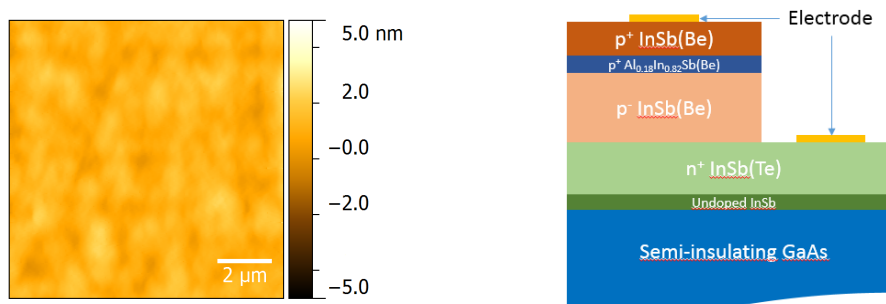

Fig. 1. AFM image of the surface of 500 nm InSb/GaAs (left) and detector structure (right).

References

- [1] N. Kuze et al., Journal of Crystal Growth 301-302, 997 (2007).
- [2] J. V. Li et al., Applied Physics Letters 86, 101102 (2005).

A comparative study of ITO, Ti and Cu metal mesh resonant filters for THz applications

Y. Demirhan, M. Kurt, H. Alaboz, T. Semerci, L. Ozyuzer, M.A. Nebioğlu, T. Takan, H. Altan, C. Sabah

¹Department of Physics, Izmir Institute of Technology, Urla, 35430, Izmir, Turkey

²Department of Physics, Middle East Technical University, Çankaya, 06800, Ankara, Turkey

³Department of Electrical and Electronics Engineering, Middle East Technical University - Northern Cyprus Campus, Güzelyurt, Turkey

Terahertz (THz) radiation is part of the electromagnetic spectrum lying between microwaves and the far-IR. Sensing and imaging using terahertz waves is a rapidly progressing technology which has wide-range applications in different areas such as security, medicine, quality control and etc. The importance of developing passive and active devices which work in terahertz frequencies is ever more increasing in this popular field [1]. One of the most important devices in THz applications is band pass filters, which could be widely applied to imaging, spectroscopy, molecular sensing, security, drug identification, or other systems [2]. Cross-shaped apertures have advantages in fabrication of the band-pass filters. Periodicity G , cross member length K , and cross-member width J determine the performance of these filters. Provided that G is smaller with respect to the wavelength, it is possible to shift the filter profile by linearly scaling the dimensions G , K , and J and this fact very much simplifies the design of resonant meshes. In this study, we report on resonant metal-mesh bandpass filters made up of metal films (typically 100-500 nm thick) perforated with arrays of cross-shaped apertures. Design of the filter structures was created by CST microwave studio program. The layout of the filter design is shown in Fig. 1. We use 2 mm thick quartz as the substrate because of its low loss at THz. ITO, Ti and Cu were chosen as the metallic layer due to their good attachment to the substrate. These films were grown in high vacuum magnetron sputtering system. Terahertz resonant metal-mesh filters were fabricated using the UV photolithography and Ar ion beam etching techniques. After fabrication, the samples were measured using a Bruker Vertex V80 FTIR spectrometer. Transmission measurements have shown center frequencies and bandwidths close to the design predictions as seen in Fig. 2. The measured results showed an insertion loss, which is due to the finite conductivity of the metal films and some loss in the substrate. Finally the created structures were characterized using time-domain THz spectroscopy (THz-TDS) systems. The measurements will be discussed in the light of surface conductivity of deposited films.

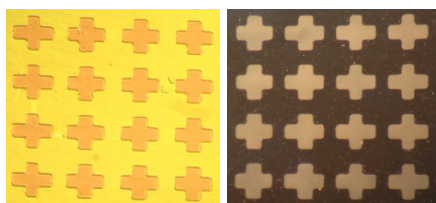

Fig. 1. Optical microscope photograph mesh filters of cross shaped ITO and Ti mesh filters

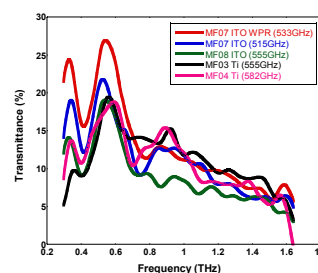

Fig. 2. Transmission measurement of ITO-Ti

**This research is partially supported by TUBITAK (Scientific and Technical Research Council of Turkey) project number 114F091.*

References

- [1] L. Ozyuzer et al., Science 318, 1291 (2007).
- [2] D. W. Porterfield, J. L. Hesler, R. Densing, E. R. Mueller, T. W. Crowe, and R. M. Weikle, Applied Optics 33, (1994).

High temperature operation of Mid-IR type-II InAs/GaSb superlattice photodiodes.

K. Czuba*, J. Jureńczyk, A. Jasik, E. Papis-Polakowska, J. Kaniewski

Institute of Electron Technology, Al. Lotników 32/46, 02-668 Warsaw, Poland

**kczuba@ite.waw.pl*

Presently, there is higher and higher demand for Mid-IR photodetectors as the number of their applications increases very quickly. The most commonly used Mercury-Cadmium-Telluride (MCT) devices will have to be replaced in the near future because of two main reasons. Firstly they approached their physical limits and there is little that can still be improved. Secondly international organizations are restricting usage of mercury, cadmium and tellurium for health and environmental reasons. All of this causes a demand for new group of devices, in which type-II antimonide-based superlattices photodetectors are of great interest. They have potential to outperform MCT or InSb ones, because of stronger suppression of Auger recombination which is a limiting factor in the latter. Especially, since high temperature passive detection is desired to lower production costs and allow for fabrication of more portable devices. In this paper, figures of merit of a series of type-II InAs/GaSb photodiodes were investigated. Each photodetector was designed to operate in MWIR range with cut-off wavelength of $\sim 5 \mu\text{m}$. All measurements were performed in wide range of temperatures (75 K – 300 K), however special attention was paid to results obtained at about 200 K. In these conditions maximum quantum efficiency of $\sim 41\%$ was achieved. Additionally, influence of perimeter-to-area ratio on differential resistance was analysed.

High TCR DC Sputtered VO_x Films for THz Bolometer Applications

H. Alaboz, H. Yuce, G. Aygun, L. Ozyuzer

*Department of Physics Izmir Institute of Technology Gulbahce Campus, Urla TR-35430
Izmir, TURKEY*

hakanalaboz@iyte.edu.tr

Terahertz (THz) range of electromagnetic spectrum still presents a challenge for both electronic and photonic technologies and it has many application areas from security to wireless communications. This kind of applications requires powerful sources, sensitive and fast detectors. We have shown that intrinsic Josephson junctions of superconducting crystal could be used as powerful THz source [1,2]. Cooled THz detectors based on superconducting materials can reach high performance values such as low noise equivalent power (NEP) but they need costly cryogenic equipments. In this study, vanadium oxide (VO_x) thin films are sputtered by dc magnetron sputtering system from room temperature to high temperatures. Vanadium oxide thin films have been used since BST detectors disadvantages were discovered at infrared region and it is clearly the most used material for uncooled detectors now. Low cost manufacturing and acceptable performance values make them perfect candidate for detector technologies. Single crystal VO₂ have high temperature coefficient resistance (TCR) but they have semiconductor metal transitions at around 341 K. Amorphous vanadium oxide films have more stable TCR over wide temperature range. Recently published research shows that resistance value in amorphous vanadium oxide thin films could be reduced with metal doping such as gold [3]. Silicon wafers are used as substrate and their surfaces were oxidized in air ambient. Oxide thickness were measured by spectroscopic ellipsometry since it is important for the support part of the suspended bridge structure. VO_x thin films sputtered with different Au doping conditions to achieve optimum resistance values for bolometer applications. FTIR measurements are performed to confirm that our thin films contain more than one phase. TCR values were also measured and optimized for high TCR and low resistance values. The highest TCR value was measured as -2% /K. CST Microwave studio will be used for finding best antenna structure for 0.6 THz source. These thin films will be used as detector material and antenna structure will pattern by e beam lithography. It's clearly indicated that air bridges are improved THz detectors response time [4]. Suspended vanadium bridge will be created for improving thermal isolation hence it will decrease detector response time.

References

- [1] L. Ozyuzer, A. E. Koshelev, C. Kurter, N. Gopalsami, Q. Li, M. Tachiki, K. Kadowaki, T. Yamamoto, H. Minami, H. Yamaguchi, T. Tachiki, K. E. Gray, W.-K. Kwok, U. Welp, Science 318, 1291 (2007)
- [2] F. Turkoglu, L. Ozyuzer, H. Koseoglu, Y. Demirhan, S. Preu, S. Malzer, Y. Simsek, H. B. Wang, P. Muller, Physica C, 491, 7 (2013)
- [3] M. Smith, C. Ginn, P. Warren, J. Long, D. Panjwani, E. Peale, J. Shelton, Proc. SPIE 9070, 90701Z (2014)
- [4] R. Bagni, E. Giovine, S. Carta, A. Di Gaspare, R. Casini, M. Ortolani, V. Foglietti, F. Evangelisti, A. Notargiocomo, Microelectric Engineering, 110, 470 (2013)

Varying Temperature Surface Reflection and its Effect on the Indoor Terahertz Wireless Communications

A. B. Şahin¹ and H. Altan²

¹*Department of Electrical and Electronics Engineering, Yıldırım Beyazıt Uni., Turkey*

²*Department of Physics, Middle East Technical University, Turkey*
absahin@ybu.edu.tr

Advances in the wireless cellular and network applications also necessitate increased traffic on the communications infrastructure. In order to overcome the capacity overload of the current spectral provisions, service providers are looking at higher frequencies. E and V bands of the millimetre wave spectrum are being utilized for mile range relay links, and higher frequency bands such as 220GHz and 340 GHz regions are being considered for indoor very high data rate applications [1].

A major conundrum in front of indoor Terahertz wireless networking is the effect of the surface reflection: which may be a positive in terms of wider area coverage, and also may be a handicap due to low penetration depths through doors, panels, and such. Indoor surfaces have many different types and textures, and a parameter which may well alter surface reflection coefficients is the varying temperature. Indoor temperature variations are not extreme as the outdoor conditions, yet differentials in excess of 15° to 20° Celcius are normal for most climates throughout seasons.

In this work the effect of the varying temperature surface reflections on the communication signal quality of very high data rate (>1Gb/s) data carrying indoor millimetre wave (>100GHz) transmission is studied. It is observed that data transmission quality is more easily affected by the temperature dependant surface reflections compared to conventional reflection power measurements. Various surfaces such as clear and coated drywall, wood panelling, and plastic materials are investigated. In future work, texture roughness and temperature variation will be explored.

References

- [1] R. Piesiewicz, C. Jansen, D. Mittleman, T. Kleine-Ostmann, M. Koch, T. Kurner, "Scattering Analysis for the Modeling of THz Communication Systems," IEEE Transactions on Antennas and Propagation, vol. 55, iss. 11, 3002—3009, (2007)
- [2] S. Lucyszyn, "Evaluating Surface Impedance Models for Terahertz Frequencies at Room Temperature," PIERS online, vol. 3, no. 4, 554—559, (2007)

This project was funded under The Scientific and Technological Research Council of Turkey Grant # 113E230.

Selected processing aspects of MWIR detectors based on antimonide type II superlattices

J. Jureńczyk*, K. Czuba, A. Jasik, E. Papis-Polakowska, J. Kaniewski
Institute of Electron Technology, Al. Lotników 32/46, 02-668 Warsaw, Poland
**jjurenczyk@ite.waw.pl*

Detectors based on type II InAs/GaSb superlattices operating at mid-IR regime are becoming comparable with well-known and widely used Mercury Cadmium Telluride (MCT) devices. Over last few decades the development of the MCT led to well established processing methods for this material system. Abovementioned new generation material and devices based on it are still under strong investigation. As long as new concepts and structures of antimonide based superlattices are proposed and grown, better, more stable and universal processing steps are needed to meet the arising high demands. Considered material consists of alternating InAs and GaSb thin layers in the growth direction of heterostructure. Its complexity makes basic steps in processing such as surface treatment, etching and passivation challenging. Subsequent procedures in full device processing are described, especially, dry etching procedure which is most critical step in fabrication. Importance of in-situ reflectance oscillations during etching with accuracy below 100 nm are emphasized. Pictures of samples obtained using Nomarski contrast before and after Inductively Coupled Plasma (ICP) etching prove good surface quality achieved in this process. Additionally the influence of combinations of SiO₂, Al₂O₃ with and without organic passivants on the electrical characteristics of photodiode is discussed. Profiles measured using electro-mechanical profilometer after each step are included which help assess of processing correctness.

Influence of Carrier Diffusion on RNGH Instabilities in Semiconductor Lasers

N. Vuković¹, J. Radovanović¹, V. Milanović¹ and D. L. Boiko²

(1) School of Electrical Engineering, University of Belgrade, 11120 Belgrade, Serbia
(2) Centre Suisse d'Electronique et de Microtechnique SA, 2002 Neuchâtel, Switzerland
radovanovic@etf.bg.ac.rs

Experiments [1] evidence that some QCL structures exhibit features of multimode Risken-Nummedal-Graham-Haken (RNGH) instabilities [2,3] at low excess above lasing threshold and hence may provide practical means to produce ps pulses in the MIR spectral range.

We explain low 2nd threshold p_{th2} in QCLs without evoking the assumption from [1] on a built-in saturable absorber and clarify the importance of unipolar diffusion in QCLs and ambipolar diffusion in conventional LDs: without diffusion, p_{th2} would be too low and independent of the lasing wavelength (Fig.1(a) and (b), dashed curves). The diffusion of electrons in the plane of QWs results in $p_{th2}= 1.32$ and 1.04 in long-cavity QCLs ($L=4\text{mm}$) (Fig.1(a), solid curves). Numerical simulations based on travelling wave rate equation model of Ref. [4] show irregular self-pulsations, in agreement with experiment in [1]. Shortening the cavity length down to $L=100\ \mu\text{m}$ increases the second threshold to 2.3-2.5 (vertical dashed lines in Fig.1(a)). Very high p_{th2} in conventional LDs is predicted by the model, attributed to ambipolar diffusion (Fig. 1(b)).

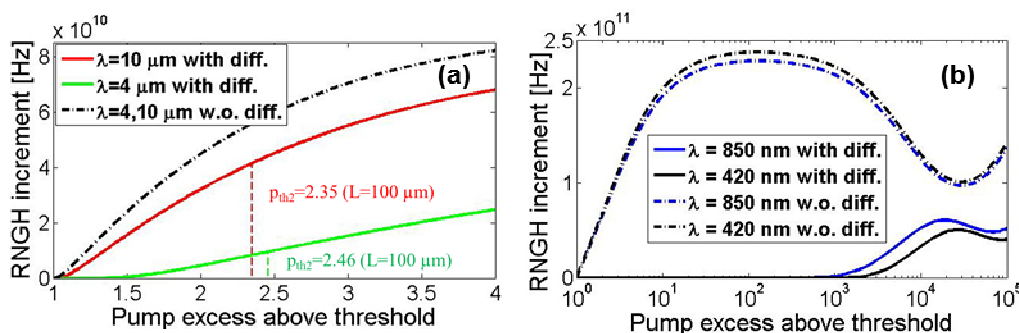

Fig.1 (a) RNGH instability increment vs pump excess above lasing threshold for QCLs ($T_1=1.3$ ps and $T_2=140$ fs) and (b) LDs ($T_1=1$ ns and $T_2=100$ fs) with/without diffusion. Diffusion coefficients are $D=180\ \text{cm}^2/\text{s}$ for QCLs and $D=7$ and $20\ \text{cm}^2/\text{s}$ for GaN and GaAs based LDs.

References

- [1] A. Gordon *et al.*, Phys. Rev. A **77**, 053804, (2008).
- [2] H. Risken and K. Nummedal, J. Appl. Phys. **39**, 4663, (1968).
- [3] R. Graham and H. Haken, Z. Phys. **213**, 420, (1968).
- [4] D. L. Boiko, P. P. Vasil'ev, Opt. Express **20**, 9501, (2012).

The authors acknowledge support from MPNS COST ACTION MP1204 - TERA-MIR Radiation: Materials, Generation, Detection and Applications, COST ACTION BM1205, SNF project FASTIQ and Ministry of Education, Science and Technological Development (Republic of Serbia), ev. no. III 45010.

Spectroscopic characterization of highly Si-doped InAs layers in terahertz emitters

M. Kozub¹, M. Dyksik¹, M. Motyka¹, G. Sęk¹, J. Misiewicz¹
K. Nishisaka², T. Maemoto², S. Sasa²

¹ *Laboratory for Optical Spectroscopy of Nanostructures, Department of Experimental Physics, Wrocław University of Technology, Wybrzeże Wyspiańskiego 27, 50-370 Wrocław, Poland*

² *Nanomaterials Microdevices Research Center, Osaka Institute of Technology, 5-16-1 Omiya, Asahi-ku, 535-8585 Osaka, Japan*

The need for improvement of commonly available terahertz (THz) sources has led to advances in semiconductor surface based generation methods. One approach is to incorporate a heavily doped reflection layer into the sample structure [1]. In these InAs based systems it is critical to use a proper dopant density in order to achieve high enough reflectivity to further increase the emission intensity. However, the latter depends on the plasma frequency characteristic for the given free carrier concentration. According to the Drude-model, at a carrier concentration level of $1 \cdot 10^{19} \text{ cm}^{-3}$, which is often used in the structures of terahertz emitters, the resulting plasma frequency is on the order of 31 THz - far above our samples emitted center frequency. Radiation of frequencies below the plasma frequency is very well reflected, because the electrons in the metal-like material screen the electric field of the electromagnetic wave.

By using spectroscopic techniques we may gain additional insight into the efficacy of employed doping methods. At the origin of the used approach lies the phenomenon of absorption of longitudinal optical modes in the *p*-polarized component of radiation as described by Berreman [2] and later named after him. By utilizing this effect to reflectance measurements [3] we have been able to extract information about carrier concentrations.

In addition, the dependence of the modulated reflectivity spectra in the vicinity of the fundamental energy gap transition of InAs, and its shift in function of the n-type doping concentration has been recorded. The latter, after inclusion of the effects of Burnstein-Moss shift and the gap renormalization, has been used as an independent probe of the free electrons' concentration. Results of both the methods have been compared and confronted with the nominal doping levels determined based on the growth calibration or Hall measurements.

References

- [1] M. Kozub et al., J. Infrared Milli. Terahz Waves **36**:3 (2015)
- [2] D.W. Berreman, Phys. Rev. **130**, 2193-2198 (1966)
- [3] M. Motyka, J. Misiewicz, Appl. Phys. Express **3** 112401 (2010)

Development of the software tools for simulation of quantum well media for radiation amplification in MIR and THz regions

A. Udal¹, R. Reeder¹, G. Valušis², I. Kašalynas², Z. Ikonic³, D. Indjin³

¹ Tallinn University of Technology, Ehitajate tee 5, Tallinn 19086, Estonia andres.udal@ttu.ee

² State Research Center for Physical Sciences and Technology, Savanoriu Ave. 231, Vilnius LT-02300, Lithuania

³ University of Leeds, School of Electronic and Electrical Engineering, Woodhouse Lane LS2 9JT Leeds, UK

In presentation we discuss recent activities on development and application of software tools to simulate the quantum cascade structures [1] on the basis of rate equations approach [2]:

- optimization of the numerical algorithms [1] (incl. problems with reliable solution of the Schrödinger equation in quantum well cascades under the applied field);
- development of a convenient simulator with user-friendly interface and moving toward desktop code with real time reaction (idea of a “student QCL simulator”);
- possibilities to apply idea of the digitized quasiparabolic quantum wells [3] in a modified form for realization of amplification cascades.

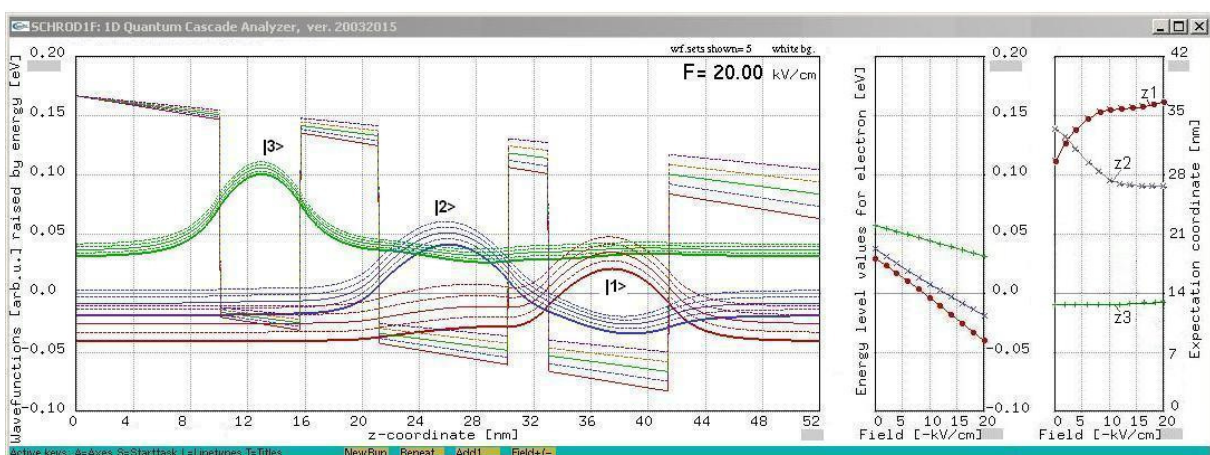

Fig. Screenshot of the developed user-friendly simulator of quantum cascade structures.

References

- [1] R. Reeder, A. Udal, E. Velmre, A. Valavanis, J. Cooper, A. Grier, P. Harrison. Proc. of the 14th Biennial Baltic Electronics Conf. BEC2014, pp. 37-40 (2014).
- [2] P. Harrison, Quantum Wells, Wires and Dots. 3rd ed., Wiley, Chichester, 538p., 2009.
- [3] R. Reeder, Z. Ikonic, P. Harrison, A. Udal, E. Velmre. J. Appl. Phys., vol. 102, No. 7, p. 073715(6 pages), 2007.

The authors acknowledge support from COST ACTION MP1204 - TERA-MIR Radiation: Materials, Generation, Detection and Applications and from COST ACTION BM1205 – European Network for Skin Cancer Imaging using Laser Imaging.

Optical investigation of high contrast grating fabricated by focused-ion beam process

Dominika Urbańczyk¹, Anna Wójcik-Jedlińska¹, Jan Muszalski¹, Adam Łaszcz¹,
Mariusz Płuska¹, Marcin Gębski², Tomasz Czyszanowski, Andrzej Czerwiński,
Maciej Bugajski¹

Institute of Electron Technology, al. Lotników 32/46, 02-668 Warsaw, POLAND

Dept. of Physics, Lodz University of Technology, Wolczańska 219, 90-924 Łódź, POLAND
durbanczyk@ite.waw.pl

High refractive index contrast gratings (HCGs) have drawn great attention for several years. This seemingly simple structure lends itself to extraordinary properties. It has been shown that those planar devices can be designed to have almost 100% reflectivity for surface-normal incidence [1]. This feature, together with strong polarization discrimination and sub-micron thickness of an HCG reflector, made it very interesting candidate for a mirror in VCSELs.

The HCG is single layer photonic structure composed of periodically repeated stripes made of high refractive index material and low refractive index material gaps between them (Fig. 1). It has to be surrounded by low refractive index media. In this work we report results of optical examination of monolithic large scale (100 μm of planar dimension) HCG fabricated using focused ion beam (FIB) technique. The grating has been formed within a thin layer of amorphous silica, deposited on sapphire substrate. It has been designed for maximal reflectivity of 980 nm wavelength. We have investigated optical features of a cavity formed by the HCG combined with a VECSEL-like epitaxial structure. Strong polarisation dependence of the reflectivity spectra of the optical cavity has been observed.

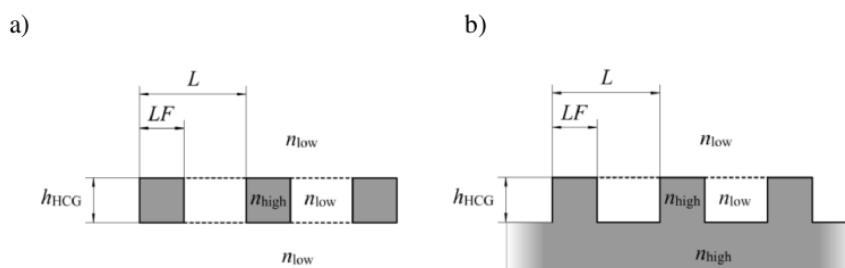

Fig. 1. a) Schematic view of high contrast grating where L - grating period, F - fill factor or duty cycle, h_{HCG} - HCG thickness or etching depth, n_{low} - low refractive index medium, n_{high} - high refractive index medium, b) schematic view of monolithic high contrast grating [2]

References

- [1]. C. F. R. Mateus, M. C. Y. Huang, Y. Deng, A. R. Neureuther, and C. J. Chang-Hasnain, "Ultra-broadband mirror using low index cladded subwavelength grating," *IEEE Photon. Technol. Lett.* 16(2), 518–520 (2004).
- [2] M. Gębski et al. *Proc. SPIE 9372, High Contrast Metastructures IV*, 937206 (27 February 2015) – in print

The author acknowledges support from MPNS COST ACTION MP1204 - TERA-MIR Radiation: Materials, Generation, Detection and Applications.

LT-InP Film For Ewod Technology For THz Applications

L. Sirbu^{1,2}, L. Mihai³, A. Ionescu³, A. Stefan³, A. Baracu⁴, R. Voicu⁴, T. Dascalu³,
R. Muller⁴

1. *D. Ghitu Institute of Electronic Engineering and Nanotechnologies, 3/3, Academiei str., MD-2028 Chisinau, Moldova sirbu_lilian@yahoo.de*
2. *University of Ottawa, Quantum Photonics, 25 Templeton St, Ottawa, ON, K1N 6N5, Canada lsirbu@uottawa.ca*
3. *National Institute for Laser, Plasma and Radiation Physics Laboratory of Solid-State Quantum Electronics, PO Box MG-36, Magurele, 077125, Romania*
4. *National Institute for R&D in Microtechnologies- IMT Bucharest, Erou Iancu Nicolae 126 A str., Bucharest, Romania raluca.muller@imt.ro*

Over the past few years, unprecedented progresses have been made in the area of THz source technologies, which have played an important role in opening up the possibility of using THz waves in many real-world applications. The existent THz sources that are based on transient current effect are made from LT-GaAs semiconductor. As an alternative material it may be LT-InP. The goal of this research is to find the value of thickness of the semiconductor film. From one side we need a material that will able to absorb all femtosecond pulse laser energy of incident IR beam. From another side it follows by idea that the generated THz radiation in proposed film to have to have an small attenuation coefficient at output. After sputtering processes, on top of the films, we detected the indium layer. Therefore we optimized the second technological process for selective etching using HNO₃. The absorption coefficient versus photon energy for InP films were measured at 300 K for three type of thickness, 500, 1000 and 2000 nm, respectively before and after HNO₃ etching. According to the early report of Aspnes and Studna [1983] the thickness of InP films was optimized in order to obtain a high absorption coefficient (α) [1]. The slope of the transmission coefficient vs wavelength is changed after indium layer etching which remained after RF deposition have been optimized. THz-TDS spectra are obtained using a system based on a self-mode locked Ti-Sapphire oscillator (FEMTOLASERS) which emits pulses of 19fs pulse width at a wavelength of 808nm and an average output power of 160mW. We report a surface impedance for the magnetron RF sputtering InP films of ~ 0.57 M Ω compared with 0.6 M Ω for LT-GaAs (PCA 40-05-10-800-x from BATOP Optoelectronics) [2]. The low limit of the impedance at the highest input laser beam fluencies is considered above the threshold of sample damage, which may conclude that the measurement setup can differ from BATOP one.

References

- [1] Aspnes, D. E. and A. A. Studna, *Phys. Rev.* **B27**, 2 (1983) 985-1009
 [2] www.batop.com/products/terahertz/photoconductive-antenna/data-sheet/manual_PCA-40-05-10-800.pdf

The author acknowledges support from MPNS COST ACTION MP1204 - TERA-MIR Radiation: LT-InP, Materials, Generation, and Applications.

Characterization and numerical modeling of holmium-doped optical fibers for fiber lasers at 2.1 μm

J. Cajzl^{a,b}, P. Peterka^a, A. Benda^a, F. Todorov^a, Y. Baravets^{a,c}, O. Podrazký^a,
P. Honzátka^a, I. Kašík^a

^a *Institute of Photonics and Electronics CAS, v. v. i., 182 51 Prague, Czech Republic*

^b *Faculty of Chemical Technology, University of Chemistry and Technology, Prague, 182 51 Prague, Czech Republic*

^c *Faculty of Nuclear Sciences and Physical Engineering, Czech Technical University in Prague, 115 19 Prague, Czech Republic*

cajzl@ufe.cz

Thulium- and holmium-doped optical fiber lasers are attractive high-power laser sources operating in the region around 2 μm [1]. Particularly, they are important for coherent-light generation in a mid-infrared spectral range through nonlinear conversion and supercontinuum generation [2]. In this work we report on the fabrication, characterization and numerical modeling of the holmium-doped silica-based optical fiber. The characterization covers preform and optical fiber refractive index profiles, holmium concentration distribution, spectral attenuation and cutoff wavelength, whereas the special attention was paid to fluorescence lifetime measurement. The fluorescence lifetime of the holmium-doped optical fiber was measured to be 1.22 ms. Using the measured optical fiber parameters together with the comprehensive, spectral and spatial resolved numerical model we present theoretical analysis of optical fiber laser working at around 2.1 μm . The optical fiber length, pump and signal wavelengths and output mirror reflectivity were optimized. The results of numerical modeling were compared to the experimental results of the holmium-doped fiber laser in Fabry-Pérot configuration that was pumped with in-house-built highly stable thulium-doped fiber laser.

References

- [1] P. Peterka, P. Honzátka, and I. Kašík, "Thulium-doped optical fibers and components for fiber lasers in 2 μm spectral range", in Proc. SPIE 9441, 94410B. (December 05, 2014)
<http://dx.doi.org/10.1117/12.2086478>
- [2] J. Swiderski, M. Michalska, and G. Maze, "Mid-IR supercontinuum generation in a ZBLAN fiber pumped by a gain-switched mode-locked Tm-doped fiber laser and amplifier system," Opt. Express 21, 7851-7857 (2013).

The authors acknowledge support from MPNS COST ACTION MP1204 – TERA-MIR Radiation: Materials, Generation, Detection and Applications, and from the Czech Science Foundation under the project No. 14-35256S.

AlSb/InAs_(1-x)Sb_x/AlSb quantum wells used for the high temperature superlinear luminescence in the Near-Mid infrared region

E. Hulicius¹, A. Hospodková¹, J. Pangrác¹, and M. P. Mikhailova²

¹ *Institute of Physics, AS CR, v.v.i., 162 00, Cukrovarnická 10, Prague 6, Czech Republic*

² *Ioffe Phys. Tech. Institute RAS, 194021, Polytekhnicheskaya 26, St. Petersburg, Russian Federation*
hulicius@fzu.cz

We will presented the superlinear electroluminescence (SLEL) of the MOVPE structures based on AlSb/InAs_{1-x}Sb_x/AlSb a deep quantum wells (QWs) grown by MOVPE on n-GaSb:Te substrates. The two different compounds were grown in the active layer: with the higher Sb content in sample A and with the lower Sb content in sample B. Sample A exhibits the better structural parameters.

Dependence of the EL spectra and optical power on the drive current in nano-heterostructures with a deep AlSb/InAs_{1-x}Sb_x/AlSb QW at 77 – 300 K temperature range was measured. Intensive two-band SLEL in the 0.5 - 0.8 eV photon energy range and optical power enhancement with the drive current at room temperature caused by the contribution of the additional electron-hole pairs, generated at AlSb/InAs interface, due to the impact ionization by the electrons heated at the high energy difference between AlSb and the first electron level E_{e1} in the InAsSb QW were found.

Study of the EL temperature dependence at 90 – 300 K range enabled us to define the role of the first and second heavy hole levels in the radiative recombination process. Due to the temperature dependence of valence band offset the EL spectrum revealed radiative transitions from the first electron level E_{e1} to the first hole level in the whole temperature range (90 – 300 K) while the emission band related with the transitions to the second hole level occurred only at $T > 195 - 200$ K.

This work is continuation of our recent paper [1] devoted to the SLEL properties of QWs, but the structure was grown with different type of interfaces between AlSb barrier and InAsSb QW. In our previous work the interfaces were grown as AlAs-like while, results presented here are measured on samples with InSb like interfaces between barriers and QW. We have observed intensive two-band SLEL and we studied the temperature dependence in the range from 77 K to 480 K.

References

[1] M. P. Mikhailova, E. V. Ivanov, L. V. Danilov, K. V. Kalinina, N. D. Stoyanov, G. G. Zegrya, Yu. P. Yakovlev, E. Hulicius, A. Hospodková, J. Pangrác, and M. Zíková, *J. Appl. Phys.* 112, 230108 (2012).

The author acknowledges support from MPNS COST ACTION MP1204 - TERA-MIR Radiation: Materials, Generation, Detection and Applications.

Electro-Mechanical Analysis of a THz Wireless Sensor for Structural Health Monitoring

Marco A. Ribeiro

Department of Information Science and Technology, ISCTE-University of Lisbon, Portugal

Structural Health Monitoring

(SHM) is an hot topic in engineering which can benefit greatly from new THz technologies. Frequency Selective Structures (FSS) can be employed to create compact devices that can be easily integrated into the surface of structures without impairing their functionality and aesthetic appearance, but still allowing their monitoring. In this communication we present a study on the mechanical design of a THz wireless sensor, whose electromagnetic operation in the THz domain was already demonstrated, [1]. The objective of the present study is to characterize the relationship between the applied force and the reflectance/transmittance of the sensor. We performed this study by numerically solving the elasticity equation for devices made of three and six layers – the geometry is shown in Fig. 1a). Fig. 2b) shows the result of one of many numerical simulations performed to determine the compression of the polyethylene layers as a function of the applied force. The data was then integrated with the electromagnetic results of transmittance and reflectance giving rise to the results shown in figures 1c) and 1d), for three and six layers, respectively.

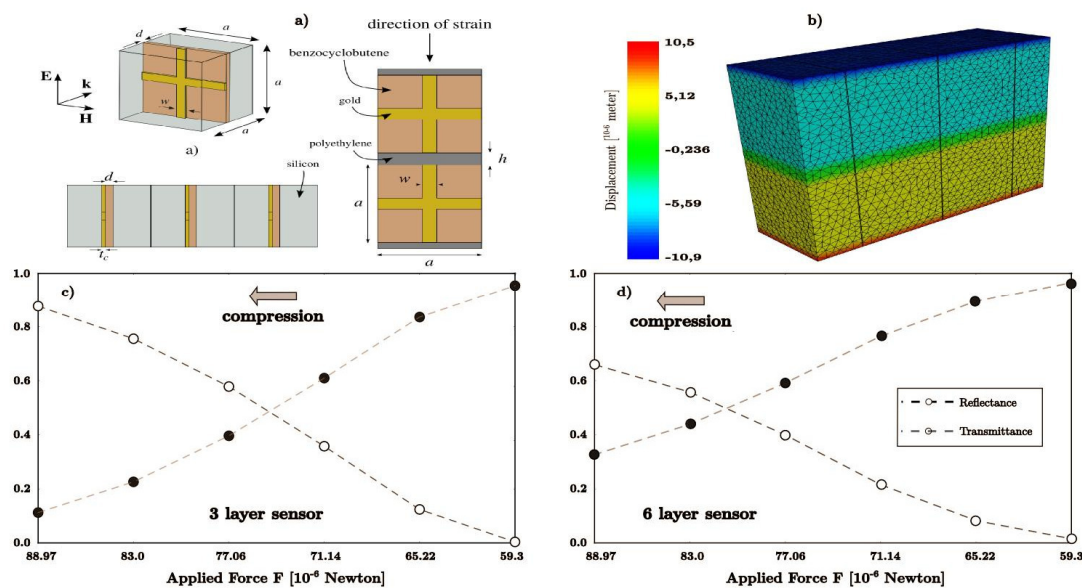

Fig. 1

References

[1] C. Duque and M. Ribeiro, Proceedings of the Loughborough Antennas and Propagation Conference (2013).

The author acknowledges support from MPNS COST ACTION MP1204 - TERA-MIR

Focused Ion Beam (FIB) Post-Processing Impact on Properties of Coupled-Cavity Quantum Cascade Laser Structures

M. Pluska, A. Czerwinski, A. Łaszcz, J. Ratajczak,
K. Pierściński, D. Pierścińska, P. Gutowski, P. Karbownik, M. Bugajski
Institute of Electron Technology, Al. Lotnikow 32/46, 02-668 Warsaw, Poland
mpluska@ite.waw.pl

Coupled-cavity quantum cascade lasers (CC QCLs) were designed and produced with Focused Ion Beam (FIB) to provide single mode operation together with relatively high output power.

The FIB milling is defined by digital scanning patterns, e.g. bitmaps (instead of lithography masks), facilitating modifications. Therefore, FIB technique is a very useful tool for manufacturing prototypes and short series of nanodevices or post-processing customization of individual devices. It serves excellently for producing customized CC QCL devices.

One of methods for manufacturing coupled-cavity lasers from a standard QCL is milling with FIB a gap within its resonator to split it into two unequal, electrically separated while optically coupled laser sections. Single-mode lasing is enabled by independent power supplying of these sections [1].

It is considered that the most important issue in this FIB operation is quality of inner mirrors (within the gap) geometry [2]. Our present investigations showed that electrical properties of the all milled region walls are crucial for proper working of the laser. This is because ion milling can cause high leakage in the structure by short-circuiting of the gap edges.

We recognized that main effect responsible for the leakage is secondary deposition of milled material. For the investigation special test structures were prepared on QCL chips. Small areas of the structure were separated from the rest of structure by milling a trench around them down to the substrate. The trenches were milled for mesa region and outside the mesa with various values of ion beam currents. Current-voltage electrical characteristics of the test structures were registered by probe measurements within the FIB chamber. The results revealed that the leakage current is strongly dependent on ion beam current and especially on the patterning procedure (proposed in the paper). It is important that FIB imaging (even single frame of scan, typically applied during FIB processing) can significantly increase leakage current and should be strictly avoided for proper quality of CC QCLs. The applied measures have led to successful CC QCLs with high optical power and single-mode operation and distinguishable side-mode suppression ratio (SMSR) of 30 dB.

References

- [1] I.M. Ross et al., *Journal of Physics: Conference Series* 26, 215 (2006).
- [2] L. Hvozدارa et al., *Appl. Phys. Lett.* 77, 1077 (2000).

This work was partially supported by the Polish National Centre for Research and Development (NCBR) through project PBS2/A3/15/2013 (PROFIT).

Cathodoluminescence Studies and Focused Ion Beam (FIB) processing of photonic structures

M. Pluska, A. Czerwinski, J. Ratajczak, J. Kącki

Institute of Electron Technology, Al. Lotnikow 32/46, 02-668 Warsaw, Poland
mpluska@ite.waw.pl

Cathodoluminescence (CL) studies in scanning electron microscope are very frequently used to investigate local properties of photonic structures. Nevertheless, in structures with built in electric field (because most of structures contain junctions) spreading of electron beam induced current affects the CL results [1].

Focused Ion Beam (FIB) is widely used in the nanotechnology for prototyping or post-processing of photonic devices [2]. Main advantages of FIB are bitmap-based patterning providing easy designing and changing of patterns and ability to mill materials with spatial resolution in range of single nanometers. Despite such high shaping precision ion beam may damage the milled structure due to amorphization, ion implantation and secondary material deposition of the milled walls. The mentioned side effects deteriorate optical and electrical properties of processed structures.

CL studies performed on FIB-milled special test structures show that CL measurements may be critically deteriorated by the effect of secondary electroluminescence (EL) [3]. This effect can make CL measurement results in fact derived from places much different than intended. In such cases CL results and images may be improper and not related to the scanned region of the photonic structure [2]. The developed technique of CL measurements on FIB-milled photonic structures may be simultaneously used to study damages introduced by FIB processing. The test structures FIB-processed on AlGaAs/GaAs laser heterostructures with 8 nm InGaAs quantum well were used in these experimental studies.

It was revealed that secondary deposition of milled material can cause short circuiting of the laser structure and strongly decrease its performance. Adjusting FIB patterning procedure and sequence can minimize the effect of secondary deposition of milled material, as confirmed by the CL signal. The studies showed also that optimized FIB milling can be used for limitation of the secondary EL responsible for CL-signal deterioration and quenching. FIB technique can be easily used for preparation of these dedicated specimens for the CL measurements with much improved accuracy of results and avoidance of the above mentioned disturbances.

References

- [1] A. Czerwinski et al., Applied Physics Letters 93(4), 041109 (2008).
- [2] Y.K. Kim et al., IEEE J. Sel. Top. Quantum Electron. 11 (6), 1292 (2005).
- [3] M. Pluska et al., Physica B: Condensed Matter 407(15), 2829 (2012).

The author acknowledges support from Polish National Science Centre through the grant 2013/09/B/ST7/04218.

Fe:ZnSe and Dy:PbGa₂S₄ lasers generating radiation in the 4-5 μm spectral region

H. Jelínková¹, M. E. Doroshenko², M. Jelínek¹, J. Šulc¹, M. Němec¹
V. K. Komar³, A. S. Gerasimenko³, V. M. Puzikov⁴, V. V. Badikov⁴

¹ Czech Technical University in Prague, Faculty of Nuclear Sciences and Physical Engineering, Břehová 7, 115 19 Prague 1, Czech Republic; helena.jelinkova@fffi.cvut.cz

² A. M. Prokhorov General Physics Institute, Russian Academy of Sciences, Laser Materials and Technology Research Center, Vavilov Str. 38, 119991 Moscow, Russia

³ Institute for Single Crystals, NAS of Ukraine, 60 Lenin Ave., Kharkiv, 61001 Ukraine

⁴ Kuban State University, May 9th Street 46a, 350040 Krasnodar, Russian Federation

Mid-IR laser radiation in the wavelength range 4 - 5 μm is required for various applications in radars, lidars, or biomedical diagnostics. The promising laser active media for generation in this spectral region are Dy³⁺:PbGa₂S₄ [1] and Fe²⁺-doped materials as ZnSe and Zn_{0.82}Mg_{0.18}Se [2]. In this contribution, output radiation characteristics of these lasers are presented. The Dy³⁺:PbGa₂S₄ laser was coherently pumped by a free-running 1.73 μm Er:YLF laser matching the Dy³⁺:PbGa₂S₄ absorption peak. The electro-optically Q-switched Er:YAG laser at 2.94 μm was used for Fe²⁺-doped laser pumping. Output energy characteristics of Dy³⁺ and Fe²⁺-doped laser are shown in Fig. 1. In the case of Dy³⁺: PbGa₂S₄ laser, maximum output energy of 7 mJ was achieved with the slope efficiency of 8 % and pulse duration of ~ 120 μs. Depending on excitation energy and reflectivity of the cavity mirrors, the laser can generate separate spectral lines at 4.3 and 4.6 μm shown in Fig. 2. The Fe:ZnSe laser generated energy, pulse-duration, and the slope efficiency with respect to the absorbed energy were 1.3 mJ, 120 ns, and 30 %, respectively (Fig. 1). In the non-selective cavity the radiation around 4.48 μm was generated. The Fe:Zn_{0.82}Mg_{0.18}Se laser generated at the wavelength ~ 4.8 μm. All lasers were working steadily at the room temperature without any cooling.

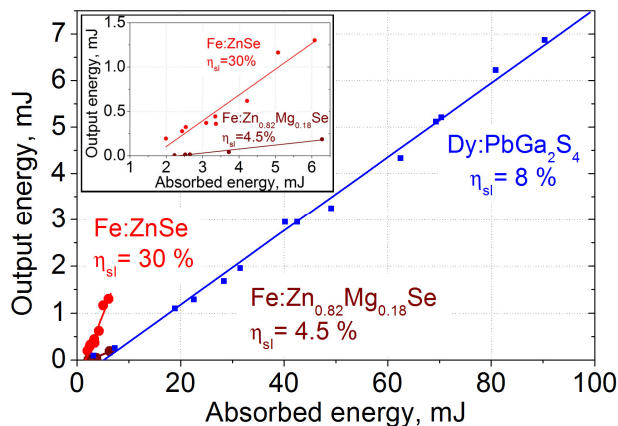

Fig. 1. Output energy characteristics of the Dy:PbGa₂S₄, Fe:ZnSe, and Fe:ZnMgSe lasers.

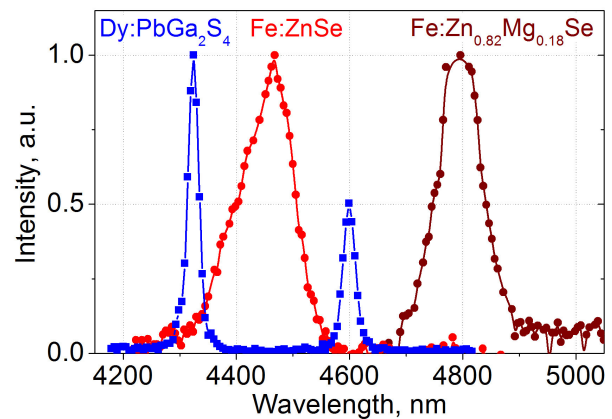

Fig. 2. Generated spectrum of Dy:PbGa₂S₄, Fe:ZnSe, and Fe:ZnMgSe lasers in a spectral non-selective cavity.

The author acknowledges support from the grant RVO 68407700.

References

- [1] T.T. Basiev, M.E. Doroshenko, V.V. Osiko, and D.V. Badikov, OSA TOPS on ASSP, 98, Craig Denman and Irina Sorokina, Eds., OSA, Washington, DC, paper 75 (2005)
- [2] M.E. Doroshenko, H. Jelínková, J. Šulc, M. Jelínek, M. Němec, T.T. Basiev, Y.A. Zagoruiko, N.O. Kovalenko, A.S. Gerasimenko, V.M. Puzikov, Laser Phys. Lett. 9, 301–305 (2012)

Cr:ZnSe laser generating at 2.3 μm pumped by Tm-fiber 1.94 μm laser

M. Jelínek¹, V. Kubeček¹, H. Jelínková¹, M.E. Doroshenko²

¹Czech Technical University in Prague, Faculty of Nuclear Sciences and Physical Engineering, Břehová 7, 115 19 Prague 1, Czech Republic; michal.jelinek@fffi.cvut.cz

²General Physics Institute, Laser Materials and Technology Research Center, Vavilov Str. 38, 119991 Moscow, Russia

The intensive growth of the laser applications in the last decades revealed the interest to generate the laser radiation at the the mid-infrared wavelength region from compact solid-state lasers. Therefore, the active materials as Cr²⁺-doped ZnSe, ZnS, CdSe, CdMnTe etc. are in the focus of investigation [1–2]. The aim of the presented work is to demonstrate operation of a Cr:ZnSe laser pumped by a thulium fiber laser (IPG Photonics Inc.) at the wavelength of 1.94 μm . The pumping radiation was focused into the 5 mm long Cr²⁺:ZnSe active crystal using one CaF₂ lens ($f=100$ mm). In the initial experiment the 15 mm long stable optical resonator was formed by a concave dichroic pumping mirror (HT @ 1.94 μm , HR @ 2.3 μm , $r=150$ mm) and a flat output coupler ($R=95\%$ @ 2.3 μm). The pumping laser was operated in the pulsed regime in order to avoid thermal load fracture of the active crystal. The pulse duration was set to 10 ms with the repetition rate of 10 Hz. Average output power of 70 mW (corresponding to the power amplitude of 0.7 W) was achieved with the slope efficiency of 38 % with respect to the absorbed pumping power. The generated radiation spectrum was centered at the wavelength of 2.26 μm with the FWHM of 10 nm. Further investigation of the influence of output coupler reflectivity as well as output power scaling and wavelength tunability will be presented.

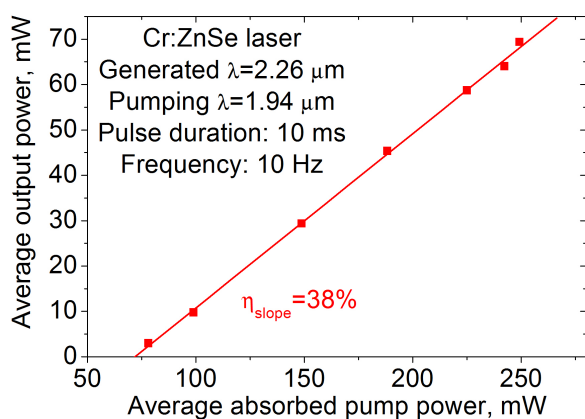

Fig. 1. Cr:ZnSe laser output power.

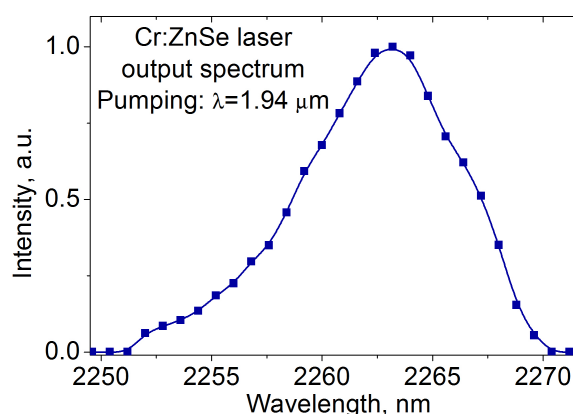

Fig. 2. Cr:ZnSe laser output spectrum.

The authors acknowledge support from the Czech Science Foundation - Project No 102/13/08888S and 15-05360S.

References

- [1] L.D. DeLoach, R.H. Page, G.D.Wilke, S.A. Payne, W.F.Krupke, IEEE JQE 32, 885-895 (1996).
- [2] M.Doroshenko, P.Koranda, H.Jelínková, J.Šulc,T.T. Basiev, V.K.Komar, M.B.Kosmyna, Solid State Lasers and Amplifiers II, Alphan Sennaroglu, Editors, Proceedings of SPIE 6190, 322-329 (2006).

Criogenic effects on cancer stem cells - can we monitor and manipulate them with THz radiation?

A.N. Goltsev, O.A. Diabina, M.V. Ostankov, N.A. Bondarovich,

Institute for Problems of Cryobiology and Cryomedicine of the National Academy of Sciences of Ukraine, Kharkov
cryo@online.kharkov.ua

Cryoablation is widely used in the treatment of oncological diseases [1]. In our studies we have paid special attention to studying the influence of temperature on structural and functional characteristics of cancer stem cells (CSCs), which determine the initiation and metastasis of tumors. We have made a comparative analysis of the single and two-fold freezing on the structural and functional characteristics of CSCs in development dynamics of Ehrlich carcinoma (EC). The cells of EC-7 and EC-14 were subjected to both single and two-fold freeze-thawing in ascitic fluid with no use of cryoprotective agents. The Proliferative potential of post-thaw EC cells was assessed on their doubling time. The cell concentration with CSCs markers: CD44⁺CD24⁻ and CD44^{high} in total EC pool was assessed using monoclonal antibodies to CD44 and CD24 antigen (BD, USA). Single and two-fold cryopreservations have been found to change in a different way the functional status of EC cells and CSCs with CD44⁺CD24⁻ and CD44^{high} phenotype contained in them, depending on the tumor development stage. It has been found that after two-fold freezing the content of EC-7 cells total population reduced to the 7th culturing day in 1.5 times and in 1.8 times to the 14th day compared with a single freezing. Moreover two-fold freezing rendered a manifested suppressive effect on EC-14 aging culture in contrast to the stimulating effect of a single freezing. Our studies indicate that it is essential that each CSCs population responds in a different way to cryopreservation with the development of tumor process. The findings emphasize the attention to the need of correct choice of the terms and number of cryoeffect cycles on malignant neoplasms [2, 3]. We would like to attract the attention of the teams of COST MP1204 for possible joint research to: (i) Investigate the effect of strong THz radiation in the development of cancer stem cells, since short high power bursts of terahertz radiation can damage DNA and also increase the production of proteins that help the cells to repair this damage. (ii) Use THz spectroscopy to follow the development of cancer in stem cells, since cancer cells normally have a higher water content than healthy cells with consequent stronger THz absorption [4,5].

References

1. J.G. Baust J.G. and A.A. Cage, *BJU INT.***95**, 1187-1191 (2005).
2. O.A. Diabina et al, "Freeze-thawing-cycle dependent cryoability of Ehrlich carcinoma stemness-like cells" p.93 *Freezing biological time. 50th Anniversary celebration, Annual scientific conference and AGM, London UK (2014)*
3. A.N. Goltsev et al, *Theoretical and practical aspects of current cryobiology*, 335-340 (2014).
4. L. V. Titova et al, *Biomedical Optics Express*, Vol. 4, Issue 4, pp. 559-568 (2013).
5. Calvin Yu et al, *Quant Imaging Med Surg.* 2:33-45 (2012).

The authors acknowledge support from MPNS COST ACTION MP1204 - TERA-MIR Radiation: Materials, Generation, Detection and Applications.

Title: 3rd Annual Conference of COST Action MP1204
&
6th International Conference on Semiconductor
Mid-IR Materials and Optics SMMO2015

Type of Publication: Book of Abstracts

Submitted: Authors, Co-Authors

Edited by: Filip Todorov

Format: A5

Year of Issue: 2015

Edition: first

Published: Institute of Photonics and Electronics
The Czech Academy of Sciences
Chaberská 57, 18251 Prague 8
Czech Republic
www.ufe.cz

Printed: Tribun EU s.r.o.
Cejl 892/32, 602 00 Brno
Czech Republic

ISBN: 978-80-86269-23-8

Supported by:



www.ufe.cz

WiFi Access for Conference Participants

SSID: **ufe-guest**

_____ - _____



INTERNATIONAL
YEAR OF LIGHT
2015

www.light2015.org
www.roksvetla.cz

ISBN 978-80-86269-23-8

