

# Kybernetika

VOLUME 44 (2008), NUMBER 4

The Journal of the Czech Society for  
Cybernetics and Information Sciences

Published by:

Institute of Information Theory and Automation of the AS CR

## Editorial Office:

Pod Vodárenskou věží 4, 182 08 Praha 8

### Editor-in-Chief:

Milan Mareš

### Managing Editors:

Lucie Fajfrová  
Karel Sladký

## Editorial Board:

Jiří Anděl, Sergej Čelikovský, Marie Demlová, Jan Flusser, Petr Hájek, Vladimír Havlena, Didier Henrion, Yiguang Hong, Zdeněk Hurák, Martin Janžura, Jan Ježek, George Klir, Ivan Kramosil, Tomáš Kroupa, Petr Lachout, Friedrich Liese, Jean-Jacques Loiseau, František Matůš, Radko Mesiar, Jiří Outrata, Jan Seidler, Karel Sladký, Jan Štecha, Olga Štěpánková, Igor Vajda, Jiřina, Vejnarová, Milan Vlach, Miloslav Vošvrda, Pavel Zítek

*Kybernetika* is a bi-monthly international journal dedicated for rapid publication of high-quality, peer-reviewed research articles in fields covered by its title.

*Kybernetika* traditionally publishes research results in the fields of Control Sciences, Information Sciences, System Sciences, Statistical Decision Making, Applied Probability Theory, Random Processes, Fuzziness and Uncertainty Theories, Operations Research and Theoretical Computer Science, as well as in the topics closely related to the above fields.

The Journal has been monitored in the Science Citation Index since 1977 and it is abstracted/indexed in databases of Mathematical Reviews, Zentralblatt für Mathematik, Current Mathematical Publications, Current Contents ISI Engineering and Computing Technology.

---

*Kybernetika*. Volume 44 (2008)

ISSN 0023-5954, MK ČR E 4902.

Published bimonthly by the Institute of Information Theory and Automation of the Academy of Sciences of the Czech Republic, Pod Vodárenskou věží 4, 182 08 Praha 8. — Address of the Editor: P. O. Box 18, 182 08 Prague 8, e-mail: kybernetika@utia.cas.cz. — Printed by PV Press, Pod vrstevnicí 5, 140 00 Prague 4. — Orders and subscriptions should be placed with: MYRIS TRADE Ltd., P. O. Box 2, V Štíhlách 1311, 142 01 Prague 4, Czech Republic, e-mail: myris@myris.cz. — Sole agent for all “western” countries: Kubon & Sagner, P. O. Box 34 01 08, D-8 000 München 34, F.R.G.

Published in September 2008.

© Institute of Information Theory and Automation of the AS CR, Prague 2008.

## A NEW APPROACH TO GENERALIZED CHAOS SYNCHRONIZATION BASED ON THE STABILITY OF THE ERROR SYSTEM

ZHILIANG ZHU, SHUPING LI AND HAI YU

With a chaotic system being divided into linear and nonlinear parts, a new approach is presented to realize generalized chaos synchronization by using feedback control and parameter commutation. Based on a linear transformation, the problem of generalized synchronization (GS) is transformed into the stability problem of the synchronous error system, and an existence condition for GS is derived. Furthermore, the performance of GS can be improved according to the configuration of the GS velocity. Further generalization and appropriation can be acquired without a stability requirement for the chaotic system's linear part. The Lorenz system and a hyperchaotic system are taken for illustration and verification and the results of the simulation indicate that the method is effective.

*Keywords:* chaotic system, generalized synchronization (GS), configuration of poles, synchronous velocity

*AMS Subject Classification:* 93C10, 37N35, 58E25

### 1. INTRODUCTION

Recently, chaos encryption has become an active research topic [3, 4, 11], and chaos synchronization [1, 12] has become an even more important research subject as the foundation of secure communication. At present, the studies [7, 13] of generalized chaos synchronization receive relatively less attention. The existing methods can not be carried out in a system with an unstable linear part and can not be improved according to the configuration of GS velocity. Therefore, an improved approach is developed and presented in this paper to realize better GS of chaotic systems.

### 2. GENERALIZED SYNCHRONIZATION OF CHAOTIC SYSTEMS

Consider two dynamic systems:

$$\dot{x} = f(x) \tag{1}$$

$$\dot{y} = f(y) \tag{2}$$

where  $x = (x_1, \dots, x_n)^T \in \mathbb{R}^n$ ,  $y = (y_1, \dots, y_m)^T \in \mathbb{R}^m$ , and let  $h : \mathbb{R}^n \rightarrow \mathbb{R}^m$  be an arbitrary function. The two systems in (1) and (2) are served as a drive system and a response system, respectively, and  $h(x)$  of  $x$  is used to drive the response system.

**Definition 1.** (Fang [6], Kocarev and Parlitz [9]) It is said that systems of (1) and (2) possess the property of generalized synchronization (GS) between  $x$  and  $y$  if there is a transformation  $H : \mathbb{R}^n \rightarrow \mathbb{R}^m$ , a manifold  $M = \{(x, y) | y = H(x)\}$ , and a subset  $B = B_x \times B_y \subset \mathbb{R}^n \times \mathbb{R}^m$  with  $M \subset B$  such that all trajectories of (1) and (2) with initial conditions  $(x_0, y_0) \subset B$  approach  $M$  as time goes to infinity; that is,  $y = \lim_{t \rightarrow \infty} H(x)$ .

Specially, if  $H$  equals to the identity transformation, this general definition of synchronization coincides with the usual definition of exact synchronization, or identical synchronization (IS).

### 3. CONFIRMATION OF GENERALIZED CHAOS SYNCHRONIZATION

To be specific, system (1) is divided into a linear part and a nonlinear part [10, 11]:

$$\dot{x} = Ax + \Phi(x) \tag{3}$$

where  $A \in \mathbb{R}^{n \times n}$ ,  $\Phi(x) : \mathbb{R}^n \rightarrow \mathbb{R}^n$ , and  $Ax$  is the linear part of  $f(x)$  while  $\Phi(x)$  is the nonlinear part.

According to the drive system (3), a response system can be constructed, as follows [2, 8]:

$$\begin{cases} \dot{x} = Ax + \Phi(x) \\ \dot{y} = Ay + \Delta\Phi(x) \end{cases} \tag{4}$$

where  $\Delta \in \mathbb{R}^{n \times n}$  is a homologous matrix of  $A$ , that is,  $A\Delta = \Delta A$ .

Suppose  $h(x) = \Phi(x)$  in model (4). Then  $\Phi(x)$  can be used to drive the response system, so the response system is controlled by the drive system.

All eigenvalues of  $A$  are supposed to have negative real-parts, which are usually required in a system that can realize the generalized synchronization by using the model (4). It is the so-called stability limit of the system's linear part.

In order to have more applications and improve the velocity of GS, a new approach is presented based on model (4), such that:

$$\lim_{t \rightarrow \infty} \| Py - x - Q \| = 0 \tag{5}$$

where  $P \in \mathbb{R}^{n \times n}$ ,  $Q \in \mathbb{R}^n$ , in which  $P$  and  $Q$  are constant matrices and  $P$  is a full-rank matrix. So we can construct a new model:

$$\begin{cases} \dot{x} = Ax + \Phi(x) \\ \dot{y} = P^{-1}A(Py - Q) + P^{-1}\Phi(x) + P^{-1}BK(x + Q - Py) \end{cases} \tag{6}$$

where  $B \in \mathbb{R}^{n \times w}$ ,  $K \in \mathbb{R}^{w \times n}$ , and both  $B$  and  $K$  are control matrices; moreover,  $(A, B)$  are controllable, that is, the rank of the matrix equals  $n$ .

**Theorem 1.** If all eigenvalues of the matrix  $(A - BK)$  have negative real-parts, viz.  $\text{Re}(\lambda_i(A - BK)) < 0$ ,  $i = 1, 2, \dots, n$ , then the drive-response systems of (6) realize GS and satisfy (5).

*Proof.* Suppose  $e = Py - x - Q$  is the error of GS. Then, from (6), we can find that

$$\begin{aligned} \dot{e} &= P\dot{y} - \dot{x} \\ &= A(Py - Q) + \Phi(x) + BK(x + Q - Py) - (Ax + \Phi(x)) \\ &= A(Py - x - Q) + BK(x + Q - Py) \\ &= (A - BK)(Py - x - Q) \\ &= (A - BK)e \end{aligned}$$

where  $(A - BK)$  is a time-invariant matrix. If  $\text{Re}(\lambda_i(A - BK)) < 0$ ,  $i = 1, 2, \dots, n$ , the system of synchronous error will gradually be stable about zero. Therefore,  $e \rightarrow 0$ , that is,  $\lim_{t \rightarrow \infty} \|Py - x - Q\| = 0$ . Thus, the two systems in (6) realize GS.  $\square$

An immediate consequence of the above theorem is that model (6) can realize generalized chaos synchronization if it satisfies consideration (5).

In modern control theory, if  $(A, B)$  is controllable, all states of the system are controllable and the anticipant position can be configured in the phase plane by choosing appropriate  $B$  and  $K$ . So the anticipant dynamic performance can be gained, that is, the pole configuration can be realized. From (6), we know that the arbitrary pole configuration of  $(A - BK)$  can be realized by choosing appropriate  $B$  and  $K$ , based on the controllable  $(A, B)$ . Suppose the error system is stable about zero ( $e \rightarrow 0$ ). Then, the favorable performance can be realized by choosing different poles to reduce the synchronous time.

The feedback part  $P^{-1}BK(x + Q - Py)$  is fed to the chaotic system in model (6), which changes the linear part of the error system and settles the instability problem of the nonlinear part in the drive system. Moreover, the introduction of  $P^{-1}$  need not satisfy the condition of  $AP^{-1} = P^{-1}A$ . It can just be a full-rank matrix. Therefore, according to different choices of  $P$ , a variety of forms can be constructed. Simultaneously, a wide range of choices of the coefficient matrix and extensive applications of generalized chaos synchronization can be realized.

Furthermore, the problem of GS can be transformed into the stability issue of the synchronous error system, which simplifies the problem of generalized chaos synchronization. The stability of the error system and the GS of chaotic systems can be realized through the configuration of poles, and better performance can be achieved. Because of the universality of the model, this approach can be applied not only to generally chaotic systems but also to hyperchaotic systems, as well as chaotic systems with stable linear part or unstable linear part without the stability limit.

#### 4. GS SIMULATIONS

Based on the above method, the Lorenz system [10] and a hyperchaotic system [5] are taken for simulation and the results indicate that the method is effective and feasible.

### 4.1. The Lorenz system

Lorenz system equation [12] is

$$\begin{cases} \dot{x}_1 = x_2x_3 - ax_1 \\ \dot{x}_2 = b(x_3 - x_2) \\ \dot{x}_3 = cx_2 - x_3 - x_1x_2 \end{cases} \quad (7)$$

where  $a, b$  and  $c$  are all system parameters. When  $a = 8/3, b = 10$  and  $c = 28$ , there is a chaotic attractor in the system.

According to (3), we consider the division of (7) into linear and nonlinear parts, and introduce a variable parameter  $\beta$ .  $A$  and  $\Phi(x)$ , which are the linear coefficient matrix and the nonlinear function, respectively, are given by

$$A = \begin{bmatrix} -a & 0 & 0 \\ \beta & -b & b \\ 0 & c & -1 \end{bmatrix}, \quad \Phi(x) = \begin{bmatrix} x_2x_3 \\ -\beta x_1 \\ -x_1x_2 \end{bmatrix}.$$

The introduction of the variable parameter  $\beta$  has transformed the constant coefficient matrix  $A$  and rectified the function  $\Phi(x)$  used to drive the response system. Moreover, the coupling relation to both systems has been modified. Therefore, different kinds of coefficient  $A$  and the nonlinear function  $\Phi(x)$  can be constructed by choosing different parameters  $\beta$ .

Here, we consider the case of

$$P = \begin{bmatrix} 2 & 0 & 0 \\ 0 & -2 & 0 \\ 0 & 0 & 1 \end{bmatrix}, \quad Q = \begin{bmatrix} 1 \\ 1 \\ 1 \end{bmatrix}.$$

It is easy to verify that  $P$  is a full-rank matrix and clearly  $Q$  is a constant coefficient matrix. If  $\beta = -1$ , the value of  $A$  and the function  $\Phi(x)$  can be obtained as follows:

$$A = \begin{bmatrix} -8/3 & 0 & 0 \\ -1 & -10 & 10 \\ 0 & 28 & -1 \end{bmatrix}, \quad \Phi(x) = \begin{bmatrix} x_2x_3 \\ x_1 \\ -x_1x_2 \end{bmatrix}.$$

In addition, the matrix  $B$  satisfies the condition  $\text{rank}(A, B) = 3$ , so  $B = [ 1 \ 1 \ 0 ]^T$  is set to meet the controllability of  $(A, B)$ .

According to model (6), the set of poles  $J$  is made up of a pair of dominant complex poles and a real pole. For instance,  $J = \{ -3, -0.2 + 0.1i, -0.2 - 0.1i \}$ . According to the values of  $A, B, J$  above, the value of  $K$  can be found, that is  $K = [ -1.0101 \ -9.2566 \ 9.9183 ]$ . Let the initial value  $x_0 = [ 0 \ 0 \ 0.001 ]^T$  in (7), so the initial value of  $y_0 = [ 0 \ 0.001 \ 0 ]^T$  can be obtained. The variable of  $e = [ e_1 \ e_2 \ e_3 ]^T$  is the system error of GS. The simulation results are shown in Figure 1 by using Matlab 6.5.1.

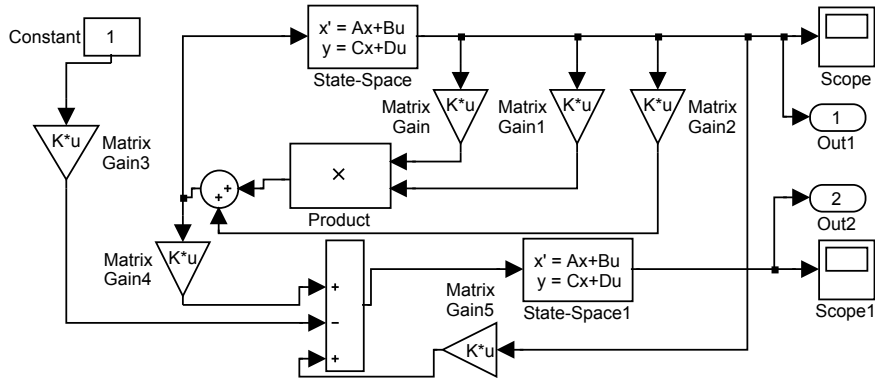

Fig. 1. The module of Lorenz system simulation.

### 4.2. A hyperchaotic system

A hyperchaotic system is [5]:

$$\begin{cases} \dot{x}_1 = ax_1 - x_2 - x_3 \\ \dot{x}_2 = x_1 - bx_2 \\ \dot{x}_3 = 1/\mu(x_1 - cx_3 - x_4) \\ \dot{x}_4 = 1/\varepsilon[x_3 - d(x_4 - 1)l(x_4 - 1)] \end{cases} \quad (8)$$

where  $a, b, c, d, \mu$  and  $\varepsilon$  are all system parameters. The step function  $l(u)$  is defined by  $l(u) = \begin{cases} 0, & u < 0; \\ 1, & u \geq 0. \end{cases}$  When  $a = 0.6, b = 0.05, c = 0.015, d = 10, \mu = 0.3, \varepsilon = 0.33$ , there are two positive Lyapunov exponents,  $\lambda_1 = 0.11, \lambda_2 = 0.06$ , so the system is in the hyperchaotic state.

According to (3), system (8) is divided into linear and nonlinear parts, and the variable parameter  $\beta$  is introduced. Matrix  $A$  and  $\Phi(x)$  are

$$A = \begin{bmatrix} \beta & -1 & -1 & 0 \\ 1 & -b & 0 & 0 \\ 1/\mu & 0 & -c/\mu & -1/\mu \\ 0 & 0 & 1/\varepsilon & 0 \end{bmatrix}, \quad \Phi(x) = \begin{bmatrix} ax_1 - \beta x_1 \\ 0 \\ 0 \\ -d/\varepsilon(x_4 - 1)l(x_4 - 1) \end{bmatrix}.$$

Simultaneously, consider the case of

$$P = \begin{bmatrix} 2 & 0 & 0 & 0 \\ 0 & -2 & 0 & 0 \\ 0 & 0 & 1 & 0 \\ 0 & 0 & 0 & -1 \end{bmatrix}, \quad Q = \begin{bmatrix} 1 \\ 1 \\ 1 \\ 1 \end{bmatrix}$$

and  $\beta = 1, B = [0 \ 0 \ 1 \ 0]^T$ . So the result of  $\text{rank}(A, B) = 4$  and  $(A, B)$  is indeed controllable.

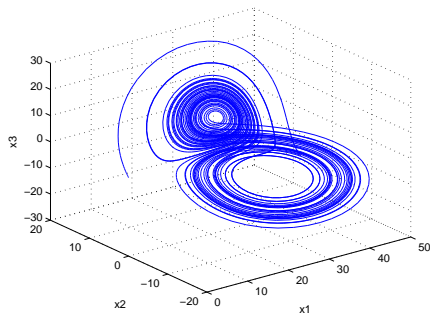

**Fig. 2.** The drive attractor of the Lorenz system.

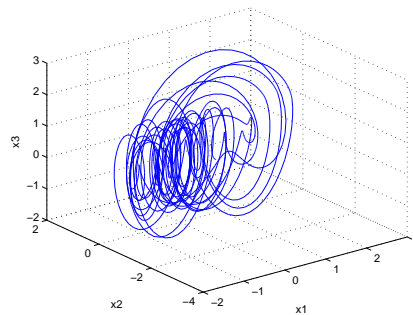

**Fig. 3.** The drive attractor of the hyperchaotic system.

According to model (6), the pole set  $J$  is made up of a pair of dominant complex poles and two real poles. For instance,  $J = \begin{bmatrix} -2 & -1 & -0.2 + 0.1i & -0.2 - 0.1i \end{bmatrix}^T$ , and consequently  $K = \begin{bmatrix} -2.9939 & 3.3989 & 4.3000 & -3.2986 \end{bmatrix}$ . Then, suppose  $x_0 = \begin{bmatrix} 0.1 & 0.34 & -1.024 & 2.034 \end{bmatrix}^T$  and  $y_0 = \begin{bmatrix} 0.21 & -0.43 & 1.024 & 1.034 \end{bmatrix}^T$ . Then  $e = \begin{bmatrix} e_1 & e_2 & e_3 & e_4 \end{bmatrix}^T$  is the error of GS.

### 4.3. Simulation results

Figure 2 to Figure 7 are the simulation results on the computer Pentium-IV with 2.6 GHz CPU and 512 MB memory. Figure 2 and Figure 3 are the drive attractors of the Lorenz system and the hyperchaotic system. Figure 4 and Figure 5 are the response attractors of the Lorenz system and the hyperchaotic system. Figure 6 and Figure 7 are the GS error curves of the Lorenz system and the hyperchaotic system.

From Figure 2 and Figure 5, we can see the obvious differences between the attractors of the drive systems and the attractors of the response systems. However, the GS errors of the Lorenz system approach zero after about 50 s in Figure 6; the GS errors of the hyperchaotic system approach zero after about 30 s in Figure 7.

### 4.4. GS errors with an improved velocity

The study shows that if a system meets the requirements of the stable matrix  $(A-BK)$  and the controllability of  $(A, B)$ , the velocity can be improved by choosing proper poles based on the appropriate matrices  $B$  and  $K$ .

The conditions from Figure 6 and Figure 7 are not changed, except the value of  $J$  which is now chosen as  $J = \begin{bmatrix} -30 & -3 + 0.4i & -3 - 0.4i \end{bmatrix}^T$  for the Lorenz system. By adopting the same  $(A, B, J)$ , the matrix  $K = \begin{bmatrix} -1.1923 & 23.5256 & 13.5788 \end{bmatrix}$  can be obtained. The curve of the GS errors is shown as in Figure 8 when the velocity is improved.

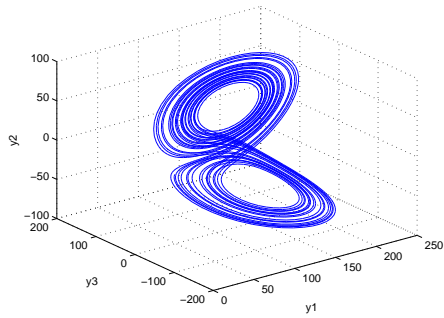

**Fig. 4.** The response attractor of the Lorenz system.

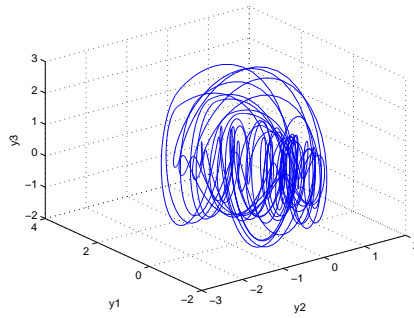

**Fig. 5.** The response attractor of the hyperchaotic system.

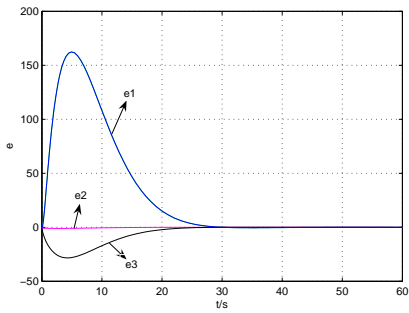

**Fig. 6.** The GS error curve of the Lorenz system.

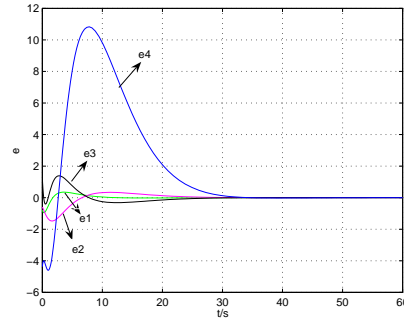

**Fig. 7.** The GS error curve of the hyperchaotic system.

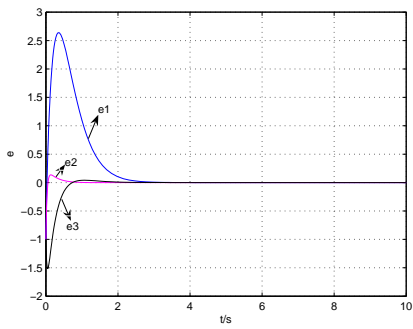

**Fig. 8.** The GS error curve of the Lorenz system when velocity is improved.

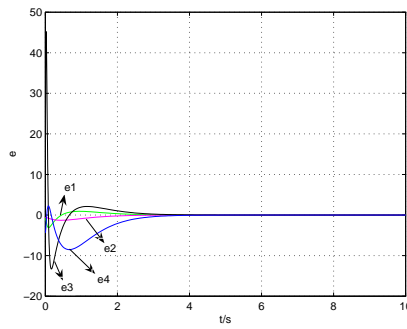

**Fig. 9.** The GS error curve of the hyperchaotic system when velocity is improved.



When the poles of the hyperchaotic system are chosen as  $J = [-50 \ -30 \ -2+0.3i \ -2 - 0.3i]^T$ , the matrix  $K = 10^4 \times [0.4557 \ -1.2609 \ 0.0085 \ 0.2128]$  can be obtained. When the velocity is improved, the GS errors are shown as in Figure 9.

In terms of the experimental data, when  $B$  is determined and the poles of the matrix  $(A - BK)$  are far from the origin, the system GS time will be shortened and the synchronous velocity will be improved. Moreover, if two poles have the same complex values, the effect on the synchronous velocity is insignificant by choosing different real poles, but the effect is remarkable by choosing different complex poles when two poles have the same real parts. When the same dominant complex poles are chosen for the two systems, the synchronous time of the hyperchaotic system is less than that of the Lorenz system.

## 5. CONCLUSION

This paper has proposed a new scheme with the stability of the error system for generalized synchronization. From the applications to two different systems, several conclusions can be drawn as follows:

(1) Feedback has been introduced to chaotic systems, which changes the linear part of the error system of generalized synchronization and solves the instability problem of linear part of the drive system.

(2) The study shows that the method can be applied not only to general chaotic systems but also to hyperchaotic systems, and can be applied to the chaotic systems with stable linear part or unstable linear part, without a stability limit of the drive system's linear part.

(3) The synchronous time can be reduced by configuring proper poles, so the system GS performance can be improved. Furthermore, the problem of GS system can be transformed into the stability problem of the synchronous error system, which extends the applicability of generalized chaos synchronization.

(4) A variety of coefficient matrices can be found according to different needs. So a larger parameter space and more different forms can be realized, which gives more convenience to generalized chaos synchronization.

(Received September 30, 2007.)

## REFERENCES

- 
- [1] L. Carroll and M. Pecora: Synchronizing chaotic circuits. *IEEE Trans. Circuits and Systems* 38 (2001), 4, 453–456.
  - [2] L. O. Chua: Experimental chaos synchronization in Chua's circuit. *Internat. J. Bifurc. Chaos* 2 (2002), 3, 705–708.
  - [3] F. Dachselt and W. Schwarz: Chaos and cryptography. *IEEE Trans. Circuits and Systems, Fundamental Theory and Applications* 48 (2001), 12, 1498–1509.
  - [4] E. M. Elabbasy, H. N. Agiza, and M. M. El-Dessoky: Controlling and synchronization of Rossler system with uncertain parameters. *Internat. J. Nonlinear Sciences and Numerical Simulation* 5 (2005), 2, 171–181.
  - [5] J. Q. Fang: Control and synchronization of chaos in nonlinear systems and prospects for application 2. *Progr. Physics* 16 (1996), 2, 174–176.

- [6] J. Q. Fang: *Mastering Chaos and Development High-tech*. Atomic Energy Press, Beijing, 2002.
- [7] Y. Gao, J. Q. Weng, X. S. Luo et al.: Generalized synchronization of hyperchaotic circuit. *J. Electronics* *6* (2002), 24, 855–959.
- [8] T. Kapitaniak: Experimental synchronization of chaos using continuous control. *Internat. J. Bifurc. Chaos* *4* (2004), 2, 483–488.
- [9] L. Kocarev and U. Parlitz: Generalized synchronization, predictability, and equivalence of unidirectionally coupled dynamical systems. *Phys. Rev. Lett.* *11* (1996), 76, 1816–1819.
- [10] E. N. Lorenz: Deterministic nonperiodic flow. *J. Atmospheric Sci.* *20* (1963), 1, 130–141.
- [11] M. Pecora and L. Carroll: Synchronization in chaotic systems. *Phys. Rev. Lett.* *64* (1990), 8, 821–823.
- [12] M. Pecora and L. Carroll: Driving systems with chaotic signals. *Phys. Rev. A* *44* (2001), 4, 2374–2383.
- [13] T. Yang and L. O. Chua: Generalized synchronization of chaos via linear transformations. *Internat. J. Bifur. Chaos* *9* (1999), 1, 215–219.

*Zhiliang Zhu and Hai Yu, Software College, Northeastern University, Shenyang 110004, China.*

*e-mails: zzl@mail.neu.edu.cn, chn\_yuhai@yahoo.com.cn*

*Shuping Li, College of Information Science and Engineering, Northeastern University, Shenyang 110004, China.*

*e-mail: shupingli0350@163.com*