

Katodoluminiscenční a detekční systémy prezentované na ICEM'15

Petr Schauer a Rudolf Autrata

Laboratoř EM, ÚPT AVČR, Brno



XVth International Congress on Microscopy

**September 1 to 6, 2002, Durban, South
Africa,**

**Contact: Robin Cross, Electron Microscopy Unit,
Rhodes University, South Africa**

E-mail: R.Cross@ru.ac.za

WWW: <http://www.icem15.com/>

(Alternative WWW: <http://www.turners.co.za/icem15/>)

Záběr kongresu

- **Více než 1200 vědeckých delegátů a zástupců vystavovatelů.**
- **Náročný program po dobu 5 dnů.**
- **5 plenárních přednášek.**
- **9 vědeckých sekcí.**
 - 55 vědeckých symposií.
 - 3 technická fóra.
 - 1200 ústních nebo posterových prezentací.
- **Výstava včetně předvádění a demonstrací - 43 firem.**
- **Významný společenský program.**



Vybrané příspěvky

- 1. Microscopy Schemes for Inspanning Photons and Electrons (A. Howie), Cavendish Laboratory, University of Cambridge.**
- 2. Field Emission SEM with a new secondary electron detecting systém (H.Kazumori, A.Yamada, M.Mita, T.Sinzawa, M.Date and Dr.B.Achard), JEOL.**
- 3. Experimental Setup for Cathodoluminescence Spectra Measurement (P. Schauer and R. Autrata), LEM ÚPT Brno.**
- 4. New fast and efficient YAP scintillator for the detection in SEM (R. Autrata and P. Schauer), LEM ÚPT Brno.**
- 5. Influence of Electrode System Geometry on Signal in ESEM Ionisation Detector (V. Romanovský , R. Autrata, J. Jiráček), LEM ÚPT Brno.**
- 6. Area Selective Detector of Low Energy Electrons (Miroslav Horáček) LST ÚPT Brno.**

Experimental Setup for Cathodoluminescence Spectra Measurement



**Petr Schauer
and
Rudolf Autrata**

**Laboratory of Electron Microscopy, Institute
of Scientific Instruments ASCR, Brno, Czech
Republic**

Cooperation

**University of Technology, Brno
Institute of Macromolecular Chemistry ASCR, Prague**

Supported

Grant Agency of the Czech Republic, grant no. GA202/01/0518 (years 2001 to 2003)

Principal questions

- Why cathodoluminescence (CL) spectra are needed?
- Which materials (specimens) do we have to study?
- What experimental setup is easy and useful?
- What is the best specimen chamber arrangement?
- How to separate the noise from the signal at a low signal level?
- How to control an experiment?
- What measurement bus do we have to choose?
- What software can be used?



Why CL spectra measurement

- **Study of scintillators and imaging screens for electron microscopes**
 - properties evaluation
 - study of new materials
 - improvement of the original elements

- **Study of physical properties of various types of materials**
 - promising phosphors
 - semiconductors
 - defective materials
 -



Materials for the study

- **Formerly - scintillators and imaging screens**

- **YAG:Ce³⁺** single crystals and powders
- **YAP:Ce³⁺** single crystals and powders
- **P47** single crystals and powders
- **CaF₂:Eu** single crystals and powders
- **Photocathodes ...**

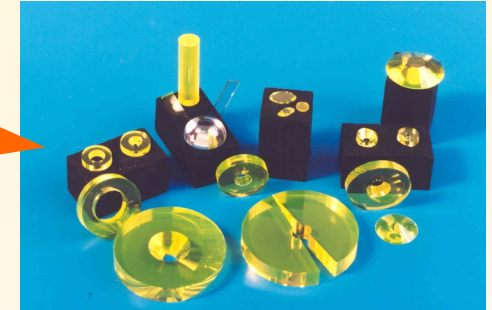

- **Now – polysilylenes**

- silicons with different dimensionality
- very promising bulk (thick layer) material



Experimental setup

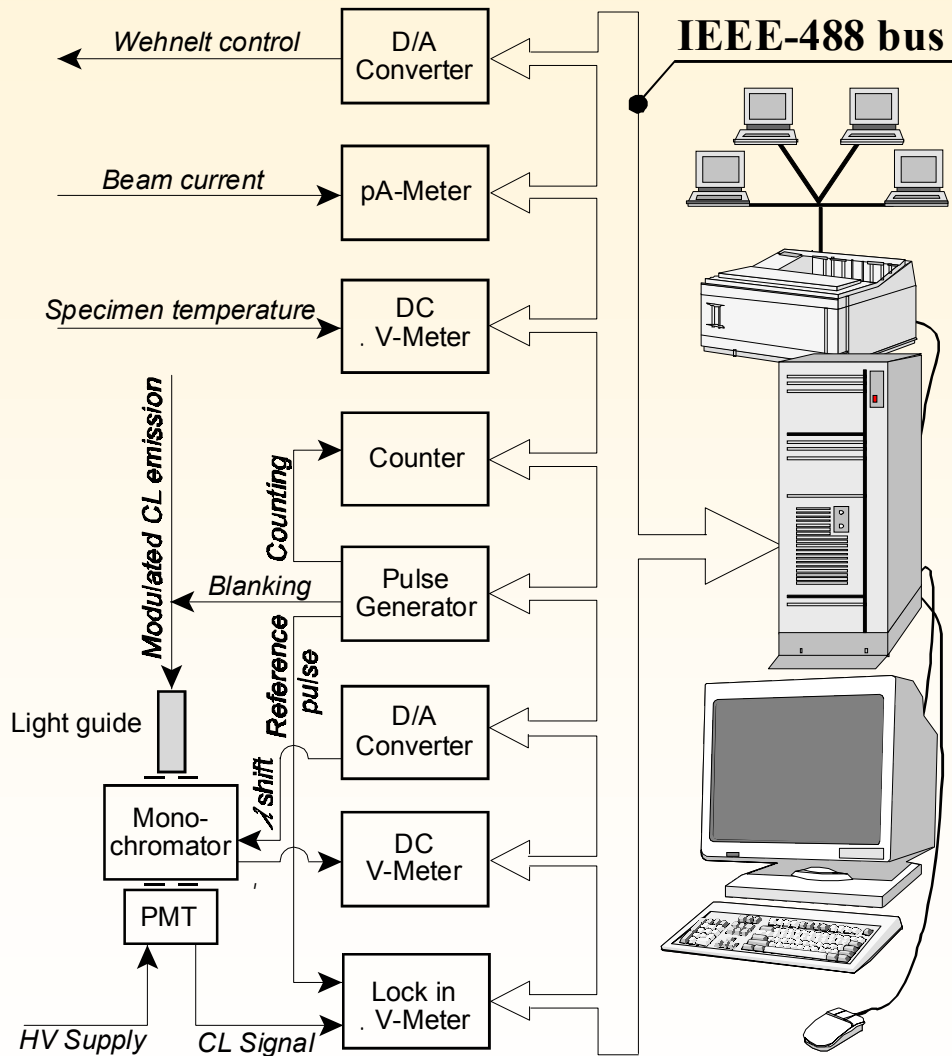

- **Equipment** built in our laboratory
- **Excitation unit** formed by an adapted electron microscope
- Equipped with **electrostatic deflection** system and a **blinking diaphragm**
- Two modes
 - **Continuous mode** - CL efficiency measurement
 - **Pulse mode** - kinetic properties or emission spectra measurement

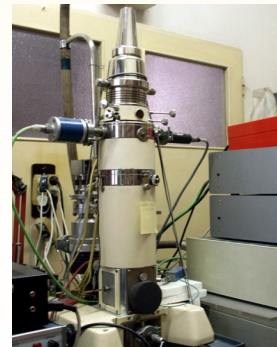

Specimen chamber arrangement

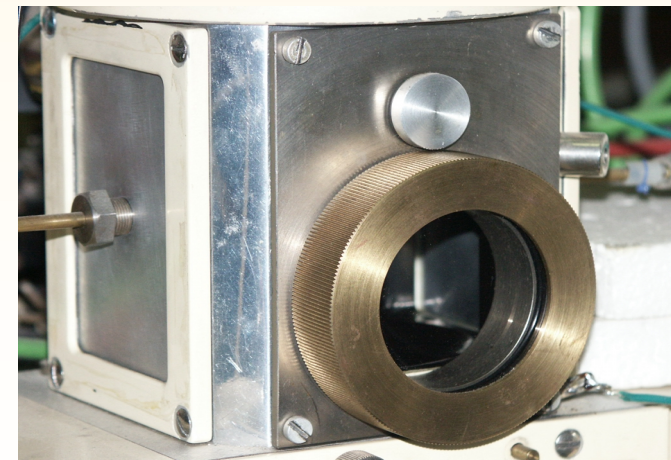
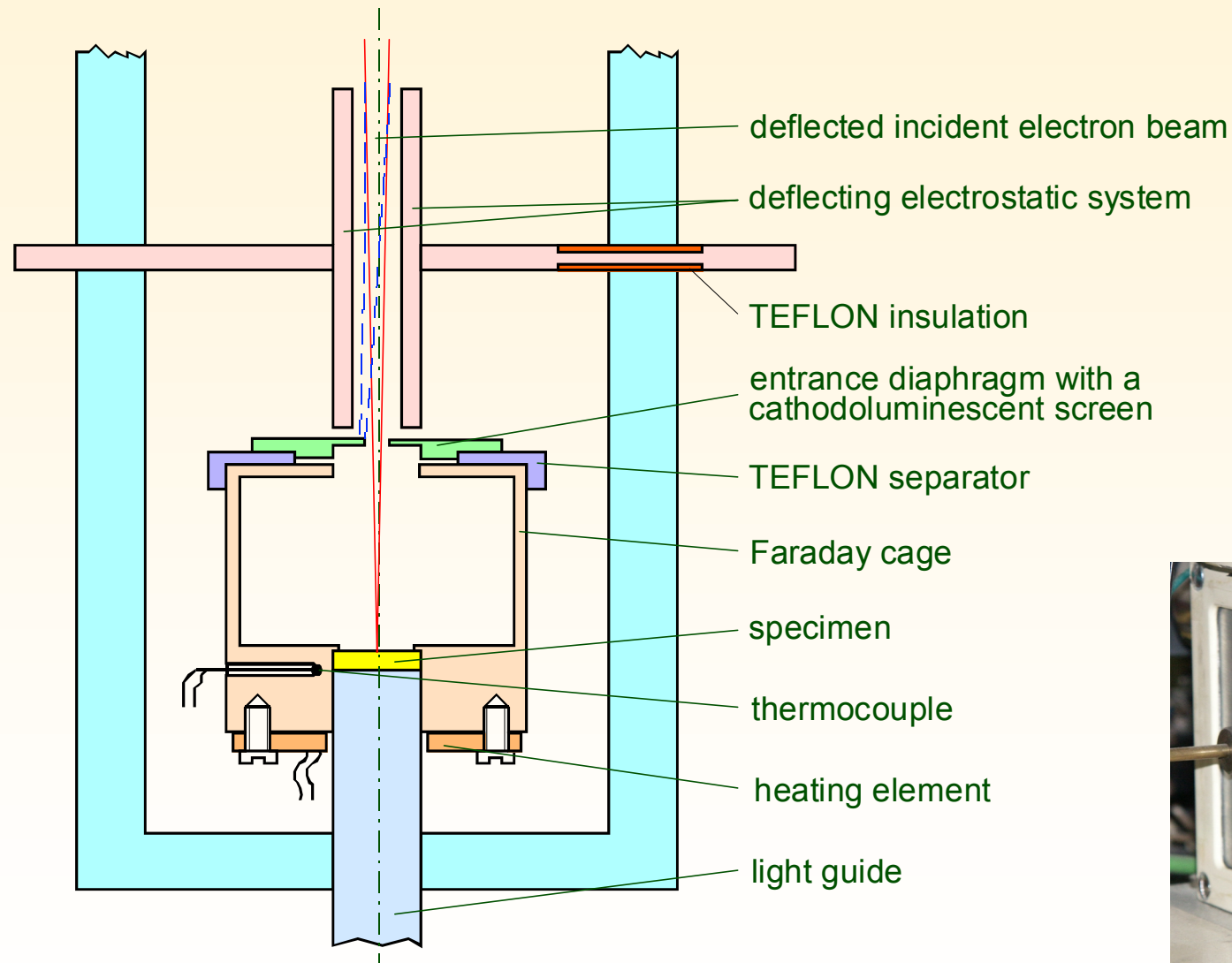

Blanking and λ shift

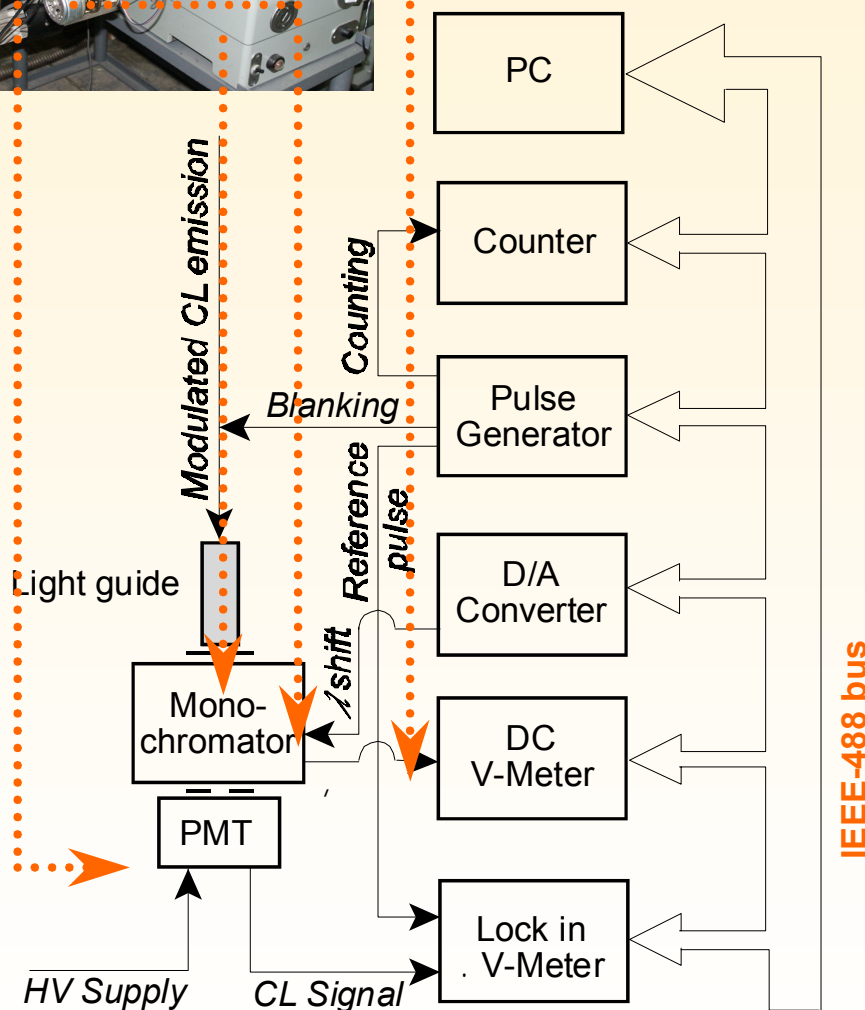
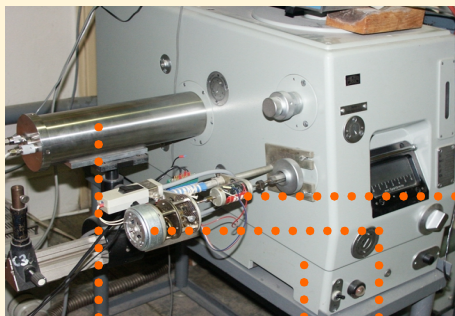

- **Mirror monochromator** Carl Zeiss Jena SPM 2
- **PMT** EMI 9558B at the output slit of the monochromator

- **Synchronous mode** using the modulated beam and a lock-in nanovoltmeter
- **Reference pulse** - triggering output of the beam modulating generator

- **Controllable λ shift** using the D/A converter and a electromotor
- **λ shift grabbed** using a revolution sensor and a voltmeter

- **Instruments controlled** using the IEEE-488 bus and a PC



Control and measurement bus

- Individual instruments connected to the GPIB (general purpose interface bus) - IEEE-488 standard
- Controlled and processed by the PC using the Agilent Technologies 82350A PCI GPIB interface card
- Built-in buffering de-couples GPIB transfers from the PCI bus transfers
- Buffering provides I/O and system performance that is superior to direct memory access (DMA) up to 750 KB/s



GPIB (IEEE-488 interface) formation

- **PCI GPIB card** Agilent 82350A installed in the PCI slot of the PC.
 - Software configurable - compatible with the plug-and-play standard
 - Controlled using Agilent Virtual Instrument Software Architecture (VISA) I/O drivers for Windows 98 - VXI plug&play standard

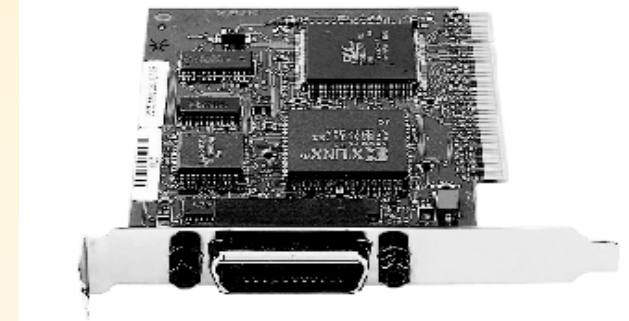

- **GPIB equipped instruments**

- Max. 15 devices



- **GPIB cables** - fully compatible with the IEEE 488.1 mechanical specification.

- Total length = 2 m x number of devices, up to 20 m.
- Max. 3 cable connectors block stacked on top of another to minimize stress.
- Bus extenders allow operation over much greater distance.



I/O configuration & tests

GPIB must be adjusted and tested before it is used with the I/O libraries using

Agilent IO Config – assigns the interface name and logical unit number to the GPIB card, as well as other necessary configuration values for the interface. This information is passed in the parameter string of the function called in the program.

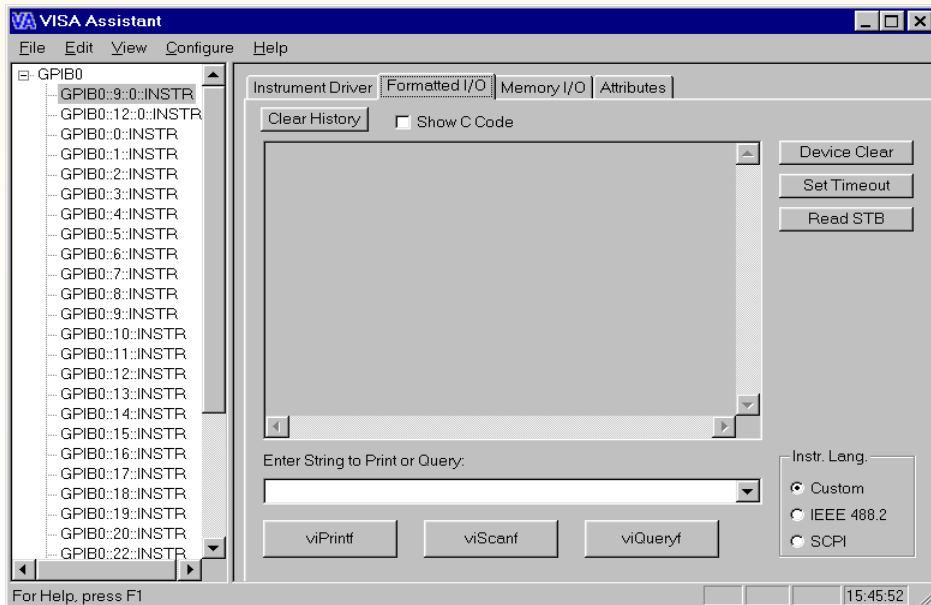
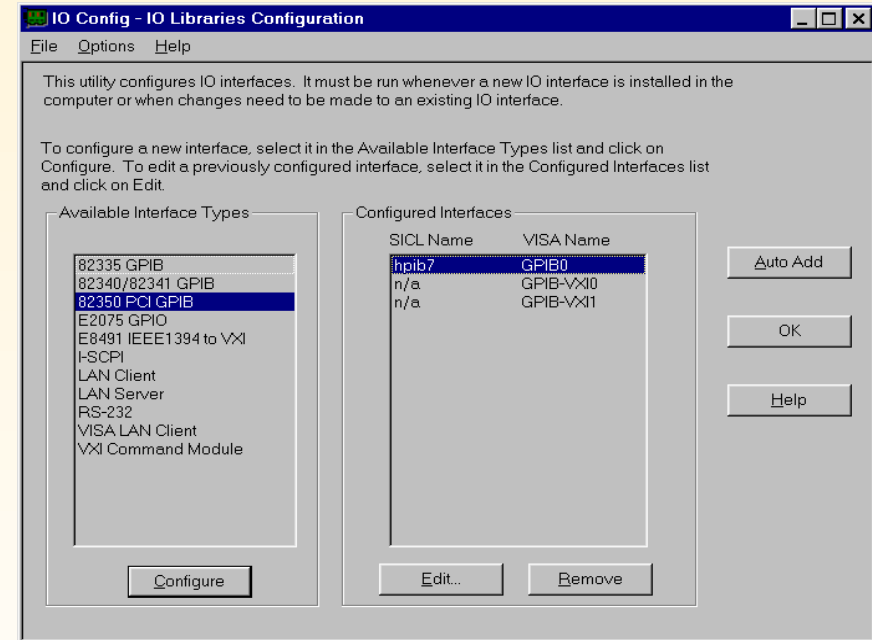

VISA Assistant utilities - enables to test the GPIB. It enables to send/receive strings to/from instruments which support formatted I/O. It also allows us to read and write memory areas, and to describe attributes that are associated with the instruments. ✓

Measurement devices



Agilent 34970A data acquisition switch unit



2x Agilent 34401A multimeters

- **Other IEEE-488 equipped instruments**
 - Metra M1T290 multimeter
 - Metra M1T330 multimeter
 - Metra MT100 multimeter
 - Tesla BM572 D/A converter
- **PC connected to the network**
 - remote operations were available



Measuring and processing software

To control the data flow through the bus we have used:

- **MS Windows 98**
- **Agilent I/O Libraries**
- **The software for the measurement and data processing** - program written in the Borland C++ (using the Agilent IO Libraries). Modules:
 - Wavelength calibration
 - Corrections for the photocathode sensitivity
 - Measurement
 - Processing - emission spectra obtained on line using SPSS SigmaPlot 2001 (version 7.101)



Results of spectra measurements

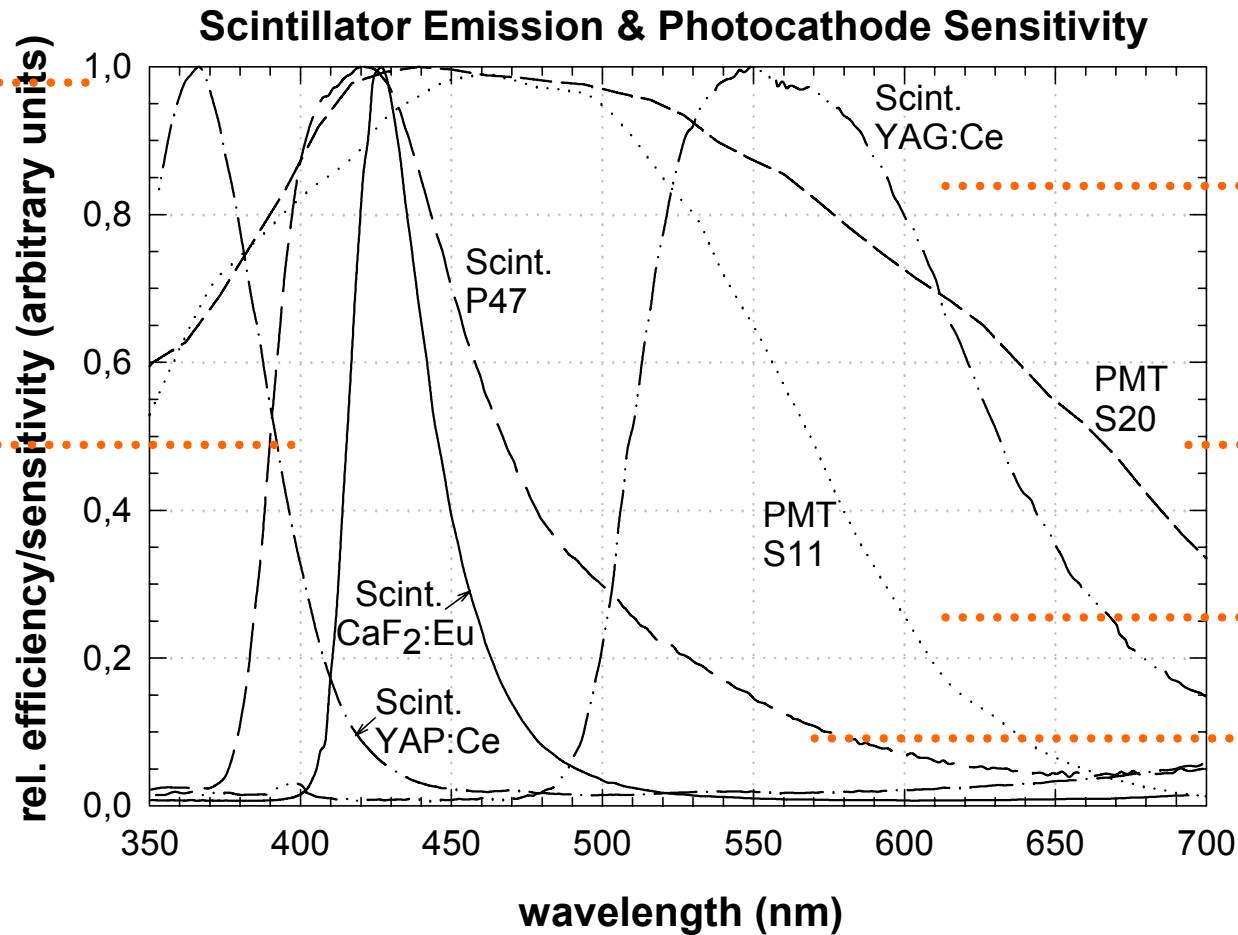
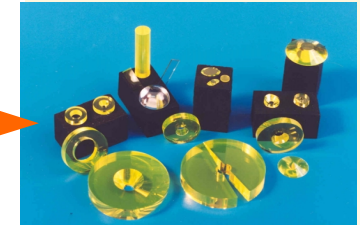

Efficient but relatively slow single crystal

Trialkali photocathode with red/infrared sensitivity

Alkali photocathode with blue-green sensitivity

Very promising fast single crystal with high efficiency

Normalized PMT photocathode sensitivities and CL emission of some scintillators. ✓

Conclusions

- Experimental equipment for the CL spectra measurement is available.
 - Very flexible setup
 - Relatively automatic apparatus
 - Device based on the GPI Bus
 - Configurable interface
 - Controlled by changeable/interchangeable software modules
- The emission spectra can be measured.
- The spectral sensitivities of photocathode can be measured.
- All spectra can be applied for the corrections of other luminescent properties.



New fast and efficient YAP scintillator for the detection in SEM

R. Autrata and P. Schauer

**Institute of Scientific Instruments, Academy of Sciences of the
Czech Republic, Brno, Czech Republic**

New modified organic glass

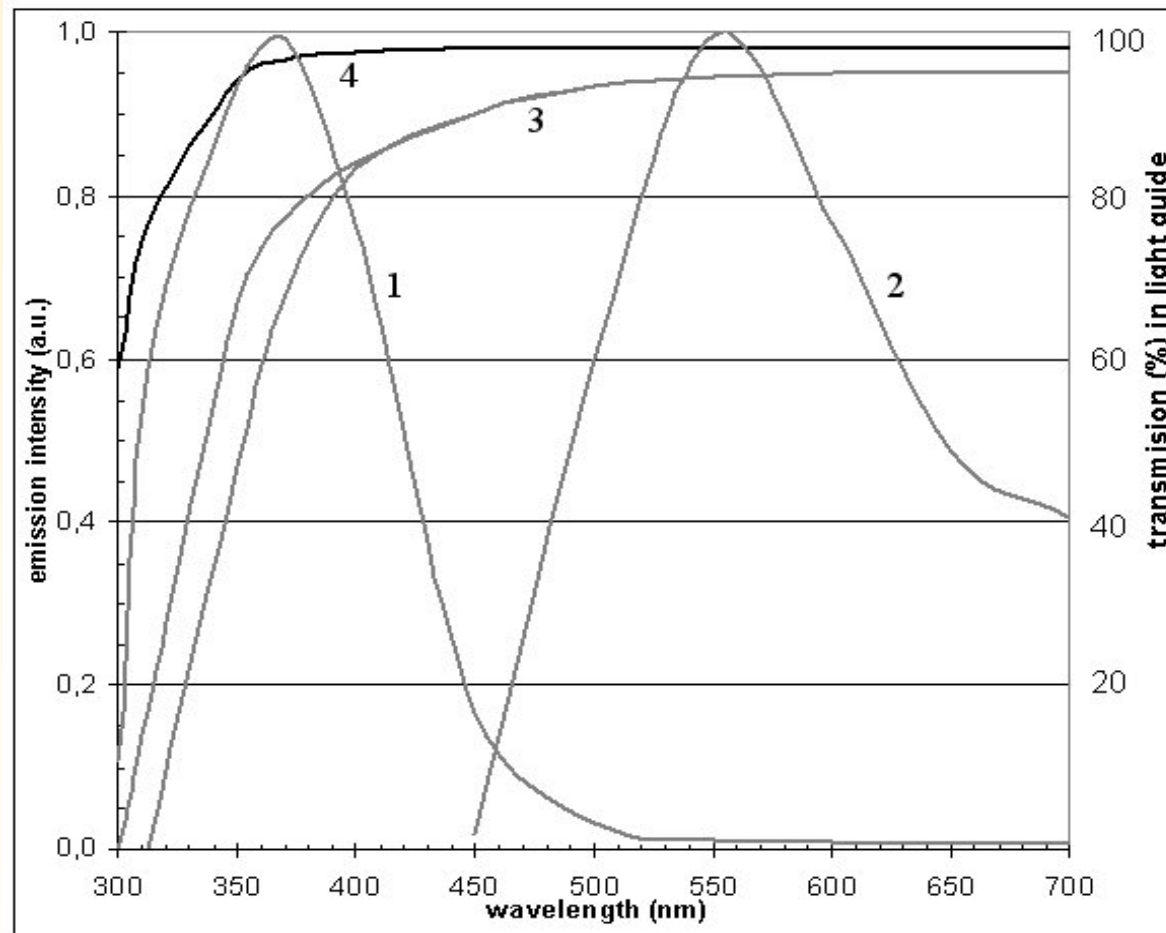

New special light guide material having good transmission at the emission peak of the YAP:Ce has been developed.

This avoids the use of expensive quartz light guides.



Shorted decay time of the YAP:Ce

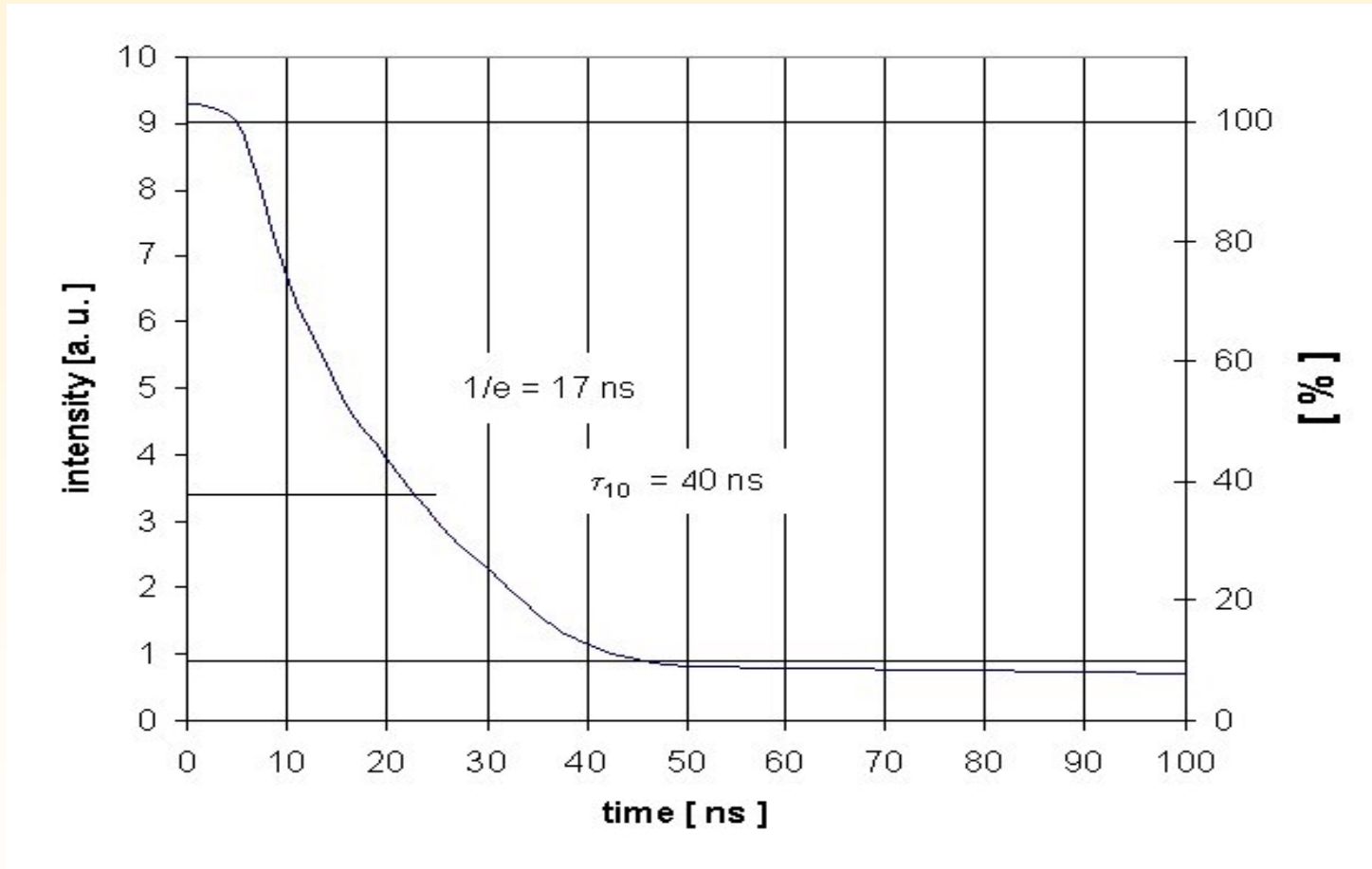

Using the modified technology of the single crystal growing the decay time of the YAP:Ce has been shorted from 30 ns to 17 ns

YAP:Ce microcracks

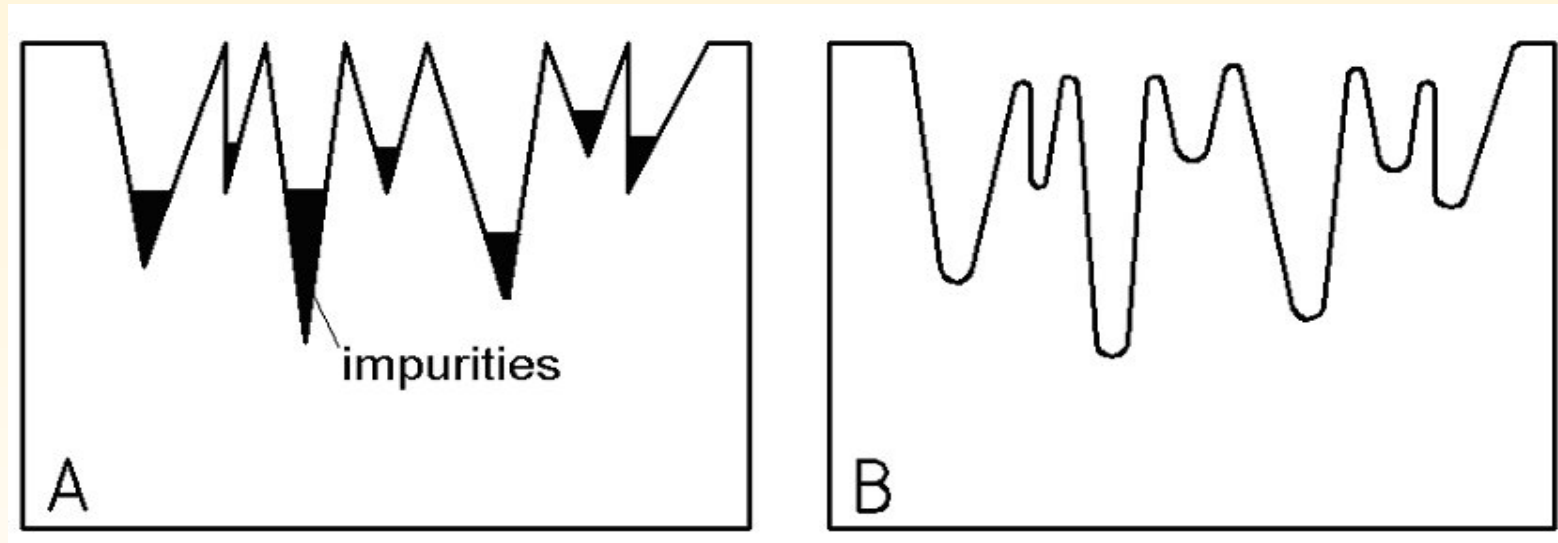

After polishing of the YAP:Ce, impurities remain in the microcracks. They can be removed by washing in a mixture of acids at a suitable temperature. By this treatment the efficiency of the energy conversion is increased.



Field Emission SEM with a New Secondary Electron Detecting System

H.Kazumori, A.Yamada, M.Mita, T.Sinzawa,
M.Date and Dr.B.Achard

JEOL

Conventional Secondary Electron Detection System (normal observation)

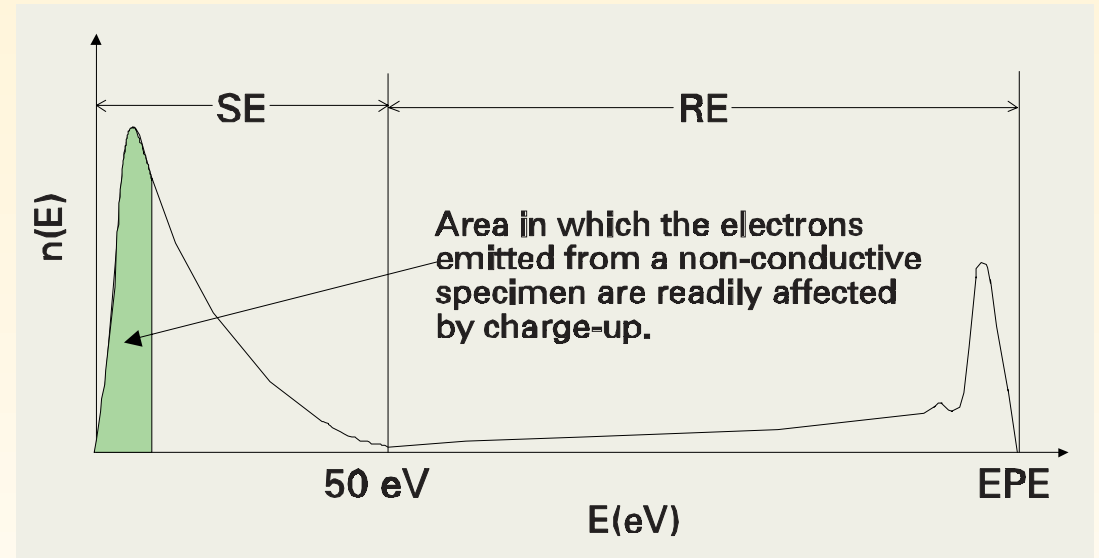
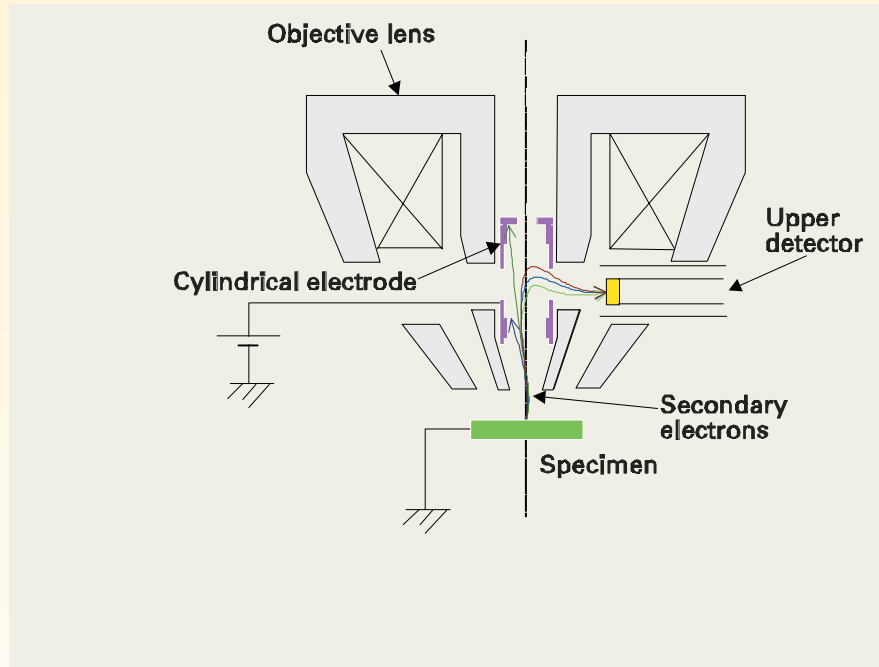

SE detection system normally used to observe an electrically conductive specimen. It shows typical paths of the SE emitted from a specimen at a ground potential. The difference in colour represents the difference in the energy of the emitted electrons. The energy increases going to the left, in the sequence yellow-green, blue, brown, and so on.

A positive voltage of several volts exists at the cylindrical electrode. This voltage suppresses the secondary electron emission when the secondary electrons emitted from the specimen collide with the cylindrical electrode. The upper detector of this system detects a large number of low-energy secondary electrons.



Conventional Secondary Electron Detection System (reflection electrode)

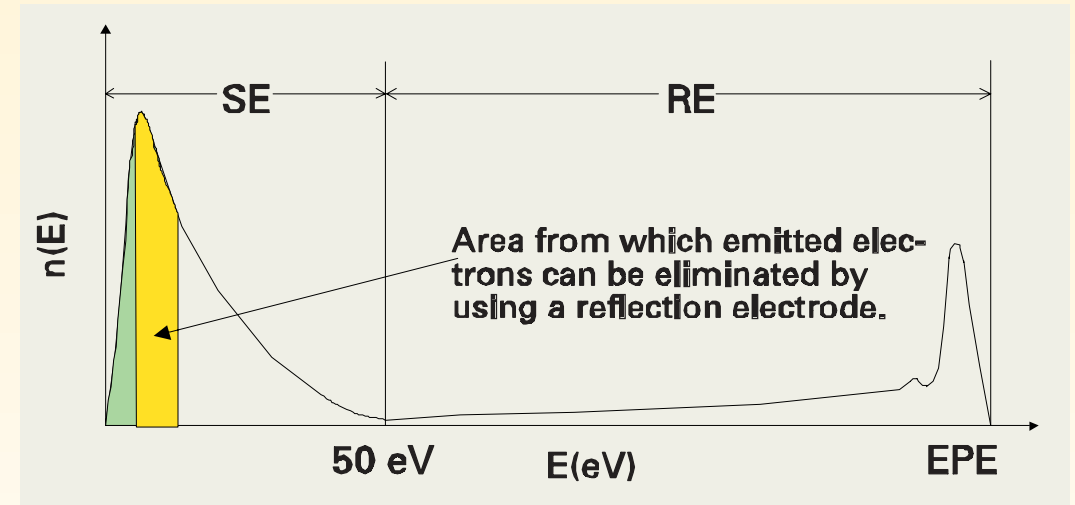
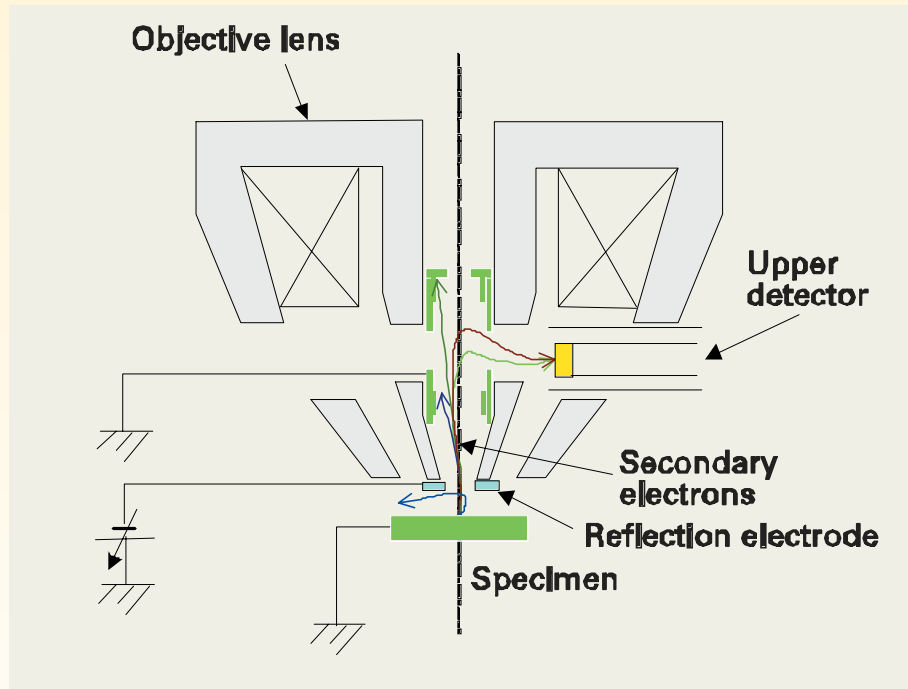

Negative voltage reflection electrode is used to eliminate the influence of charge-up of a non-conductive specimen. The SEs that follow the blue path are removed by the negative voltage electrode. However, SEs that have an energy of 1 eV or less (shown in yellow-green) rise to the upper detector because the trapping force of the magnetic field is larger than that of the electric field for these electrons.

The area from which the emitted electrons can be eliminated by using a reflection electrode is shown in yellow. It is not possible to eliminate the pale green area using a reflection electrode, so the influence of charge-up remains.



New Secondary Electron Detection System (r-filter)

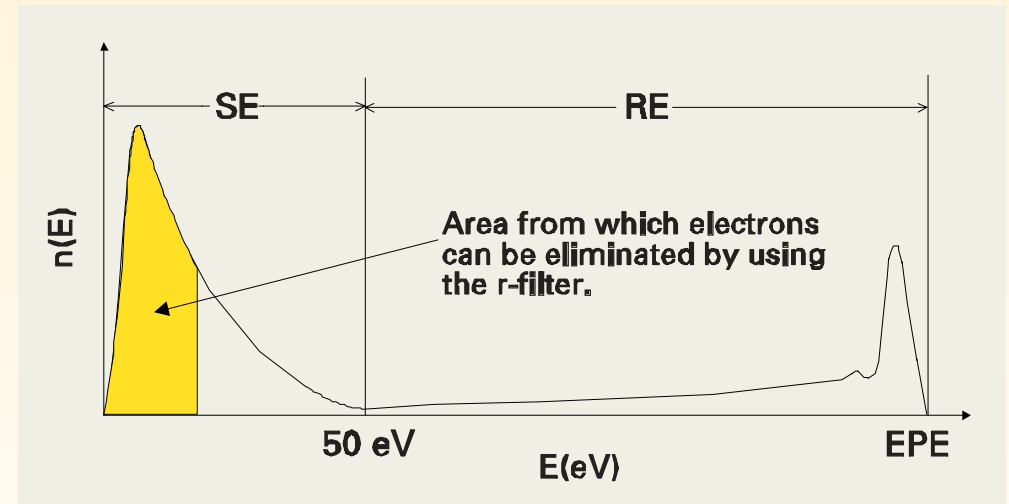
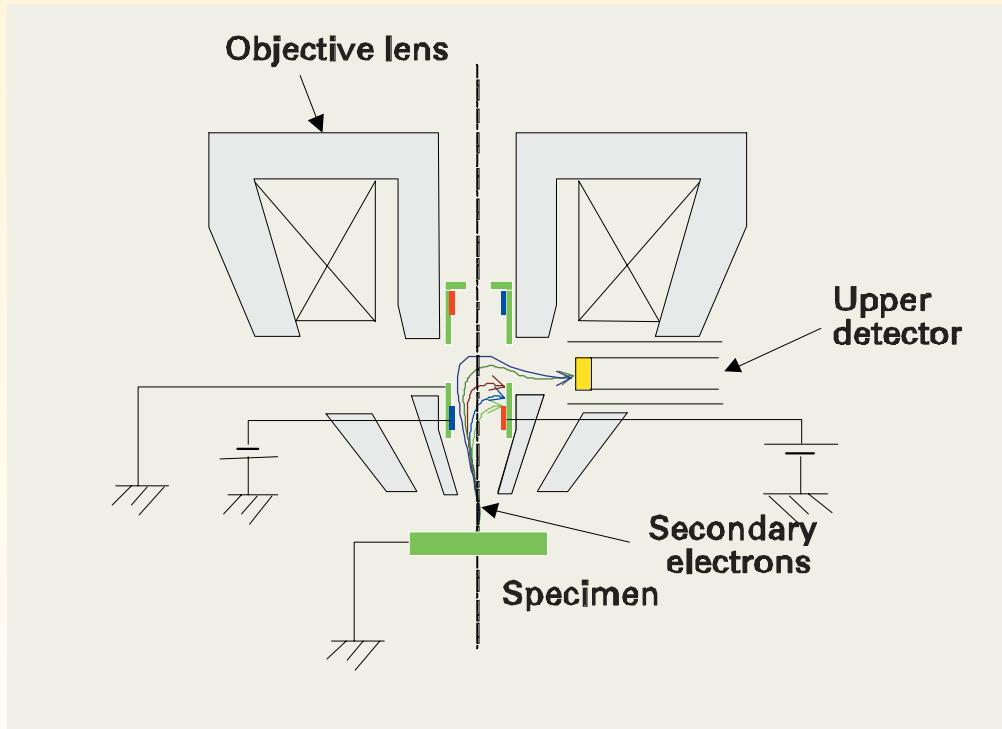

r-filter SE detection system - one of new detection methods used in this FE-SEM. The electrodes shown in red and blue in the figure are at a positive and a negative potential of several tens of volts, respectively. The resulting electric field deflects the SE paths, causing low-energy SEs in particular to collide with the inside wall of the cylindrical electrode to eliminate them.

The area from which electrons can be eliminated by using the r-filter is shown in yellow. The pale green area is included in the yellow area, so the influence of charge-up is adequately removed.



New Secondary Electron Detection System (Gentle Beam)

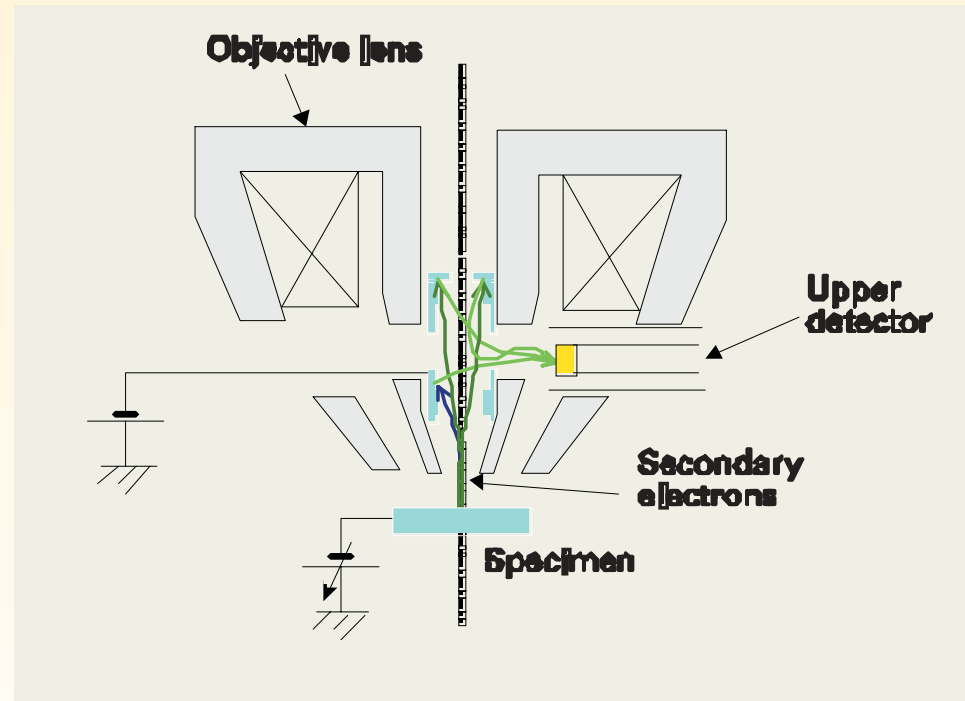

Gentle Beam SE detection system, which utilizes the primary electron-beam retarding method (Retarding method: A method of reducing the energy of the electron beam near the specimen that irradiates the surface of the specimen using a decelerating electric field.).

A negative voltage of about 1 to 2 kV is applied to the specimen. Consequently, the SEs are accelerated by the potential of the specimen, and as a result, SEs emitted at low energy do not exist. The electrons emitted from the specimen collide with the cylindrical electrode shown in pale blue, causing them to be multiplied to be detected by the upper detector.



Comparison of SEM Images

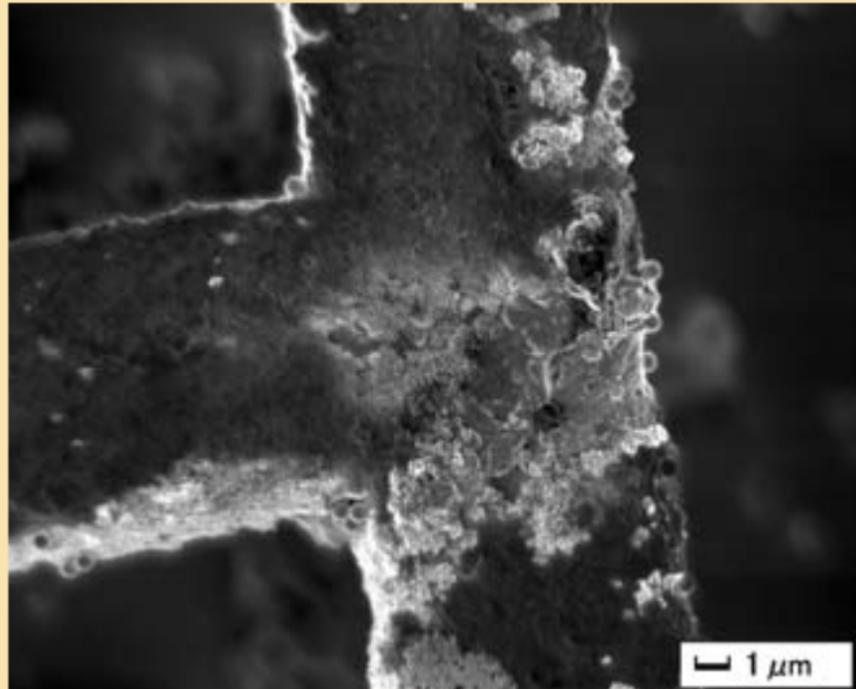

Mode 2: Accelerating voltage 1 kV

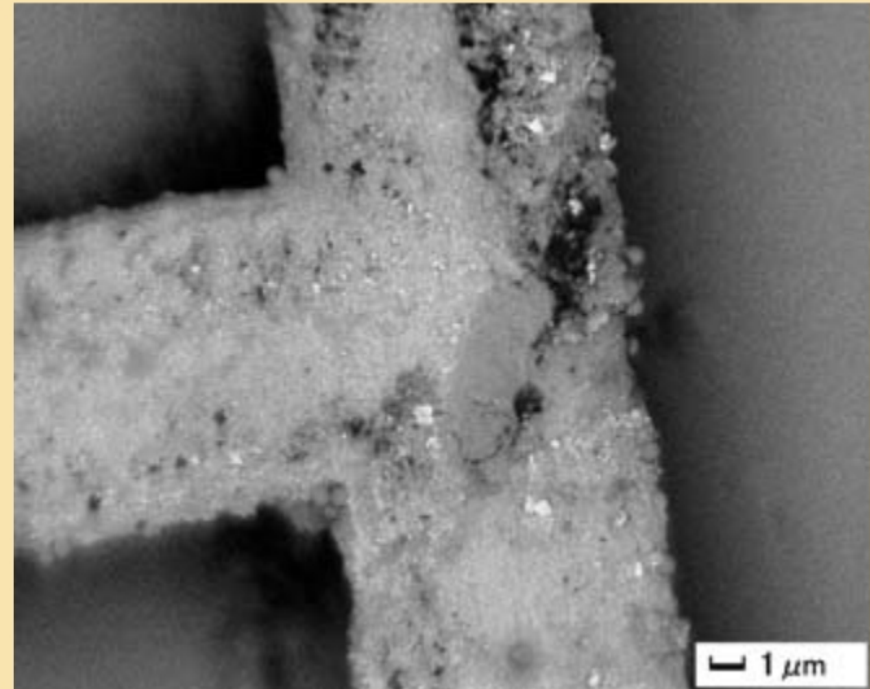

r-filter: Accelerating voltage 1 kV

Image obtained through normal observation (mode 2) (left) and image obtained using a detector with the r-filter (right). Magnification: 5,000



Comparison of SEM Images (contact holes)

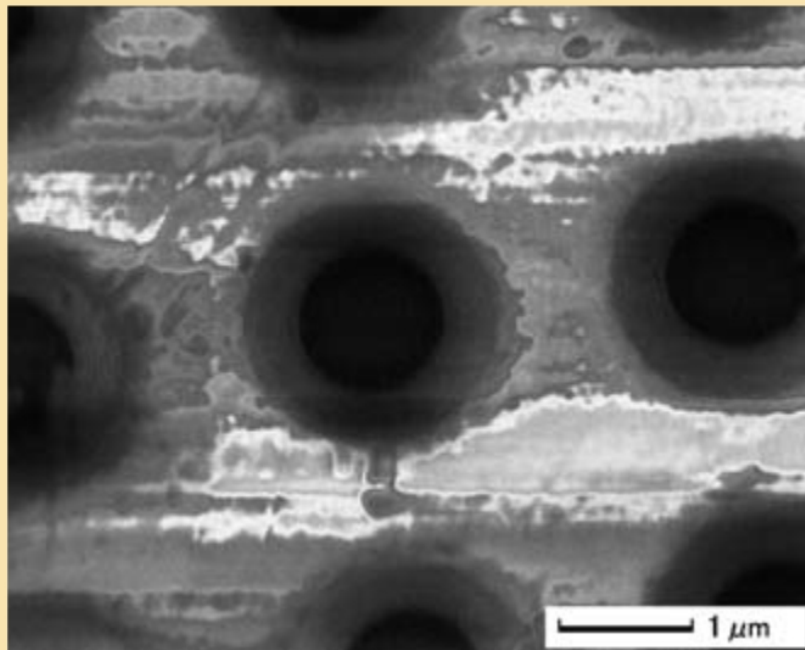

Mode 2: Accelerating voltage 1 kV

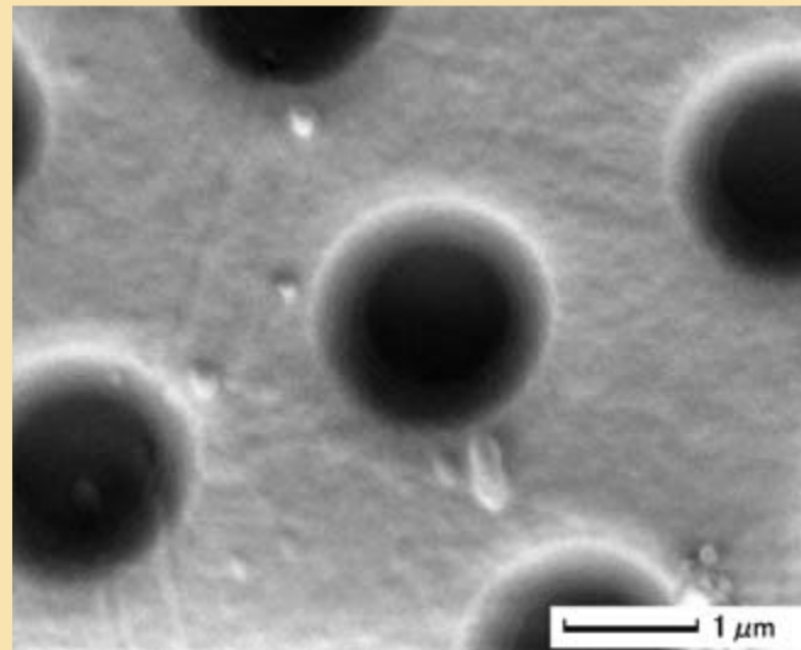

Gentle Beam: Accelerating voltage 0.1 kV

Comparison of SEM images (contact holes): Image obtained through normal observation (mode 2) (left) and image obtained using the Gentle Beam secondary-electron detector (right).

Magnification: 20,000



Comparison of SEM Images (mesh)

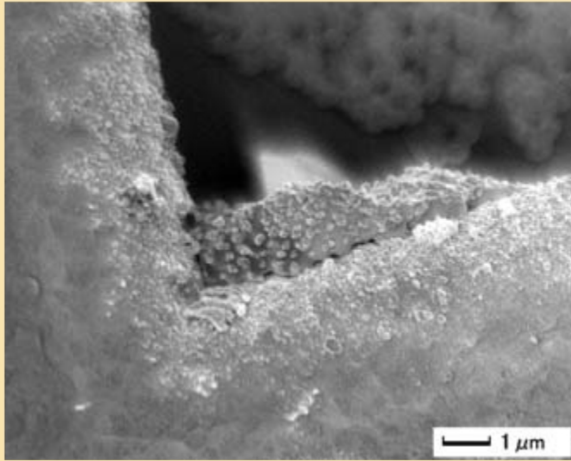

Mode 2: Accelerating voltage 1 kV

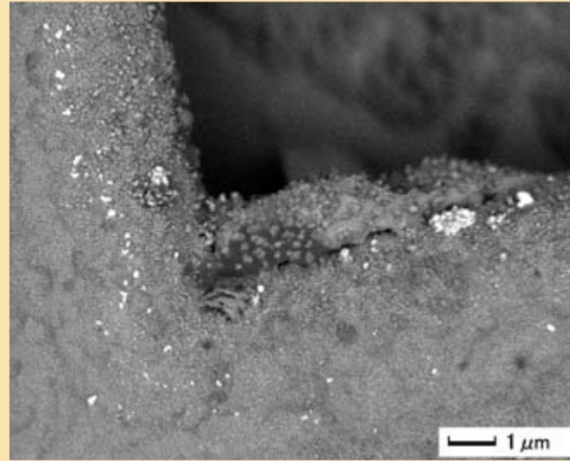

r-filter: Accelerating voltage 1 kV

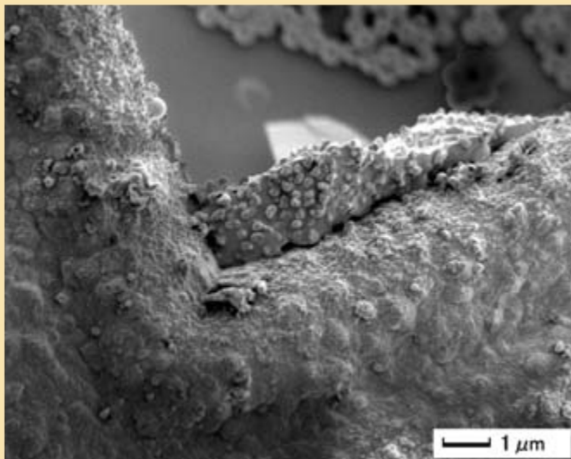

Gentle Beam: Accelerating voltage 0.3 kV

Image obtained through normal observation (mode 2) (top left) and images obtained using the new secondary electron detection systems (top right and bottom). Magnification: 10,000



High Magnification Image (100 000 x)

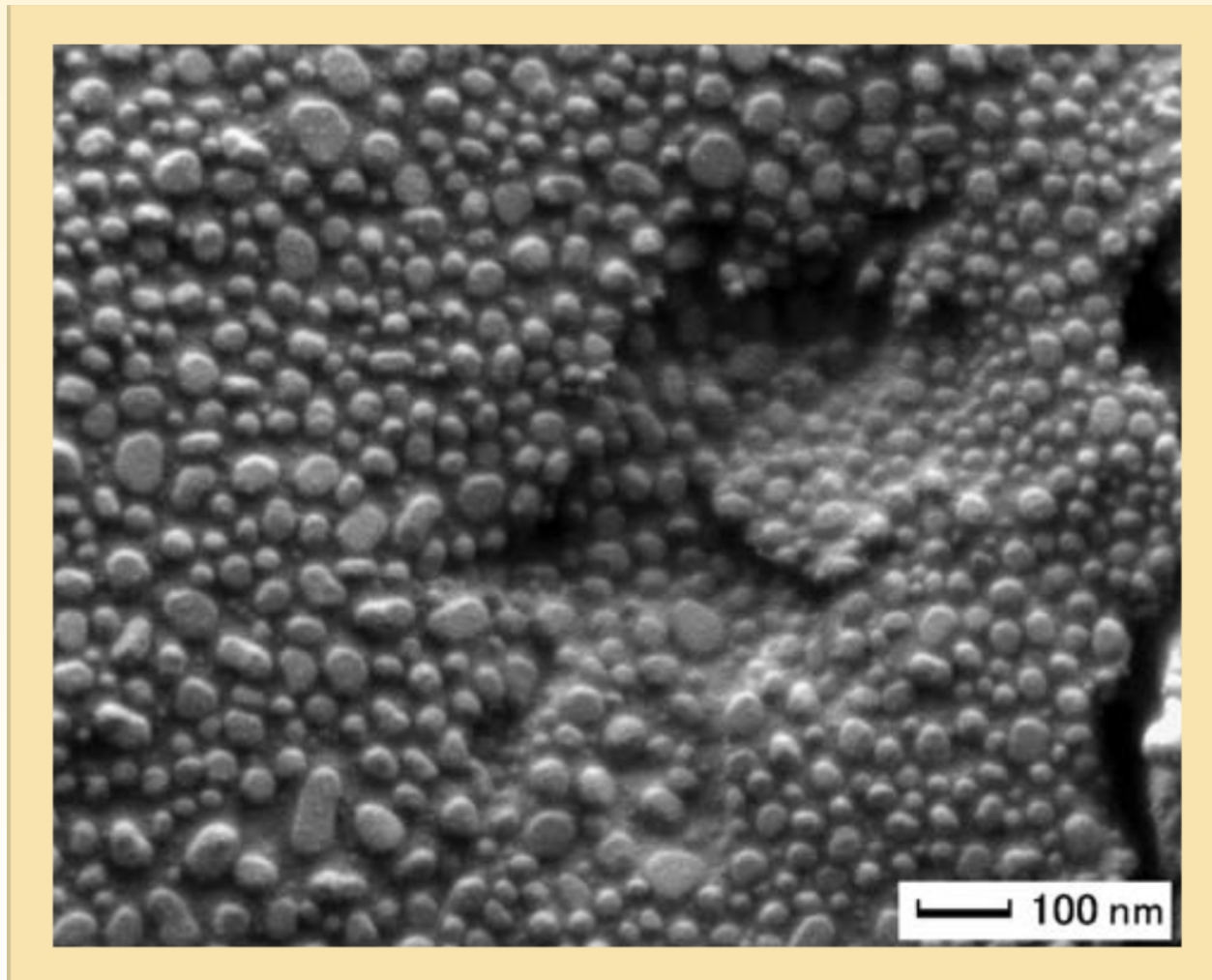

Secondary-electron image of evaporated gold at an accelerating voltage of 100 V.



Summary

- **JSM-7400F - two new SE detection systems (in addition to the conventional detection system)**
 - r-filter
 - Gentle Beam
- **Innovative detection systems make observation of nonconductive specimens possible, by eliminating the influence of charge-up occurring.**
- **New FE-SEM, the JSM-7400F offers clear images even at low accelerating voltages.**





**DĚKUJI VÁM
ZA POZORNOST**

