

**ACADEMY OF SCIENCES OF THE CZECH REPUBLIC
BIOLOGY CENTRE, INSTITUTE OF HYDROBIOLOGY
ČESKÉ BUDĚJOVICE**

47th ANNUAL REPORT

For the Year 2006



ISSN 1210 – 9649

CONTENTS

THE INSTITUTE, SCIENTIFIC COUNCIL	4
INSTITUTE STAFF AND FIELD OF WORK	5
1 INTRODUCTION	8
1.1 Projects	8
1.2 Consultancies	9
1.3 Report on Finances	10
1.4 Presentations of IHB Members at International Conferences	11
1.5 Stays Abroad	12
1.6 Foreign Visitors to Hydrobiological Institute	13
1.7 Students' Theses Finished in 2006	14
2 RESERVOIRS	15
2.1 Regular Monitoring of the Reservoirs Slapy and Římov: Dissolved and Dispersed Substances in 2006	15
2.2 Regular Monitoring of the Reservoirs Slapy and Římov: Microbial Characteristics, Chlorophyll and Zooplankton Biomass in 2006	15
2.3 Regular Monitoring: Fish Stock Composition in the Římov Reservoir in 2006	16
2.4 Changes in Phytoplankton Chlorophyll in the Slapy Reservoir after the Great Flood 2002	18
2.5 The Effect of Extreme Rainfalls on Summer Succession and Vertical Distribution of Phytoplankton in a Lacustrine Part of a Eutrophic Reservoir	20
2.6 Effects of the Cyanobacterial Bloom on Bacterial Growth and Activity	22
2.7 Synergistic and Antagonistic Effects of Viral Lysis and Protistan Grazing on Bacterial Production and Diversity in a Freshwater Reservoir	23
2.8 Local Genetic Differentiation of <i>Daphnia</i> in Deep Canyon-shaped Reservoirs	24
2.9 The Use of Pelagic Habitat by Cyprinids in a Deep Eutrophic Impoundment (Římov Reservoir, Czech Republic)	25
2.10 Spring Events in Pelagic Succession of Two Reservoirs – Climate Effect	26
3 LAKES	29
3.1 Photochemical Source of Metals for Sediments	29
3.2 Element Fluxes in Catchment-Lake Ecosystems Recovering from Acidification	29
3.3 Chlorophyll Content of Plešné Lake Phytoplankton Cells Studied with Image Analysis	30
4 SPECIAL INVESTIGATIONS	33
4.1 Application of the PDMPO Technique in Studying Silica Deposition in Natural Populations of <i>Fragilaria crotonensis</i> in a Eutrophic Reservoir	33
4.2 Modelling Phosphorus Retention in Lakes and Reservoirs	34
4.3 Large scale survey of plant biomass and plant cover by echosounding	34
5 PUBLICATIONS	37

Academy of Sciences of the Czech Republic

BIOLOGY CENTRE,
INSTITUTE OF HYDROBIOLOGY

Na Sádkách 7
CZ-370 05 České Budějovice
Czech Republic

telephone: (+420) 385310262
fax: (+420) 385310248
e-mail: hbu@hbu.cas.cz
<http://www.hbu.cas.cz>

DIRECTOR: Doc. RNDr. Josef Matěna, CSc.

DEPUTY DIRECTOR: Ing. P. Mautschka

SCIENTIFIC SECRETARY: Doc. Ing. J. Kopáček, Ph.D.

SCIENTIFIC COUNCIL:

Chairperson: RNDr. Jaroslav Vrba, CSc.

Members: RNDr. Jakub Borovec, Ph.D.

Doc. Ing. Josef Hejzlar, CSc.

Doc. Ing. Jiří Kopáček, Ph.D.

Doc. RNDr. Jan Kubečka, CSc.

Prof. RNDr. Karel Šimek, CSc.

External Members:

RNDr. Jan Fott, CSc.

Faculty of Science, Charles University, Prague

Doc. RNDr. Jan Helešic, CSc.

Faculty of Science, Masaryk University, Brno

Prof. RNDr. Vladimír Kořínek, CSc.

Faculty of Science, Charles University, Prague

Prof. Ing. Pavel Pitter, DrSc.

Institute of Chemical Technology, Prague

RNDr. Pavel Punčochář, CSc.

Ministry of Agriculture CR, Prague

Consulting External
Members:

RNDr. Juraj Holčík, CSc.

Institute of Zoology, Slovak Academy of Sciences, Bratislava,
Slovakia

Prof. Dr. Arnold Nauwerck

Institute of Limnology, Austrian Academy of Sciences, Mondsee,
Austria

INSTITUTE STAFF AND FIELD OF WORK

(visit www.hbu.cas.cz/staff.php for more information, email addresses and contacts)

SCIENTIFIC STAFF:

Department of Plankton and Fish Ecology:

Doc. RNDr. Jan Kubečka, CSc. (Head)	Fish population dynamics and scientific sonar techniques
Prof. RNDr. Zdeněk Brandl, CSc.	Ecology of predatory Cyclopidae, predatory food relations
RNDr. Martin Čech, Ph.D. (from May)	Fish behaviour in the open water
Ing. Jaroslava Frouzová, Ph.D.	Hydroacoustics and fish behaviour
Mgr. E. Hohausová, Ph.D.	Fish ecology and behaviour
Doc. RNDr. Jaroslav Hrbáček, DrSc. (Scientific Consultant)	Limnology of artificial water bodies, zooplankton, especially <i>Daphnia</i>
RNDr. Jiří Macháček, CSc.	Fish-zooplankton interactions, ecology of <i>Daphnia</i>
Doc. RNDr. Josef Matěna, CSc.	Feeding biology of fish, ecology of chironomids
Mgr. Jiří Peterka, Ph.D. (from May)	Fish foraging
RNDr. Jaromír Sed'a, CSc.	Zooplankton, especially seasonal dynamics of Cladocera and fish-zooplankton interactions
Mgr. Mojmír Vašek, PhD.	Fish feeding and distribution

(see also www.hbu.cas.cz/fishecu)

Department of Aquatic Microbial Ecology:

Prof. RNDr. Karel Šimek, CSc. (Head)	Aquatic microbiology, bacteria-protozoa interactions, bacterial community composition
Mgr. Karel Horňák, Ph.D. (from May)	Bacterioplankton community composition and activity
RNDr. Jan Jezbera, Ph.D. (from May)	Protozoan-bacterial interactions
Mgr. Jitka Jezberová, Ph.D. (December)	Identification of cyanobacterial picoplankton
RNDr. Jaroslava Komárková, CSc.	Plankton primary production, phytoplankton analyses, taxonomy of algae
Prof. Ing. Miroslav Macek, CSc. (11 months UNAM México)	Protozoa-bacteria interactions, freshwater ciliates, biological waste water treatment
RNDr. Jiří Nedoma, CSc.	Microbial biochemistry, image analysis
RNDr. Klára Řeháková, Ph.D.	Phytoplankton analyses, morphological variability of cyanobacteria (genera <i>Anabaena</i> , <i>Aphanizomenon</i>)
RNDr. Věra Straškrábová, DrSc.	Self-purification (BOD), aquatic bacteriology, interactions with phyto- and zooplankton
RNDr. Jaroslav Vrba, CSc.	Aquatic microbiology, extracellular enzyme activity
RNDr. Petr Znachor, Ph.D.	Phytoplankton, autoradiography, microphotography, cyanobacterial bloom ecology

(see also www.fytoplankton.cz)

Department of Hydrochemistry and Ecosystem Modelling:

Doc. Ing. Josef Hejzlar, CSc. (Head)	Reservoir limnology and eutrophication
RNDr. Jakub Borovec, Ph.D.	Reservoir limnology, chemistry of sediments
Mgr. Jiří Kaňa, Ph.D. (from November)	Water and soil chemistry
Doc. Ing. Jiří Kopáček, Ph.D.	Analytical chemistry, soil-water interactions
Ing. Petr Porcal, Ph.D.	Aquatic dissolved organic matter
RNDr. Jiří Žaloudík, CSc.	Soil biochemistry

TECHNICAL STAFF:

Jindra Bučková	Cleaner
Albína Charvátová	Cleaner
Alena Fiktusová	Chemical analyses
Alena Hartmanová (from May)	Bacteriological analyses, cultivation
Ing. Vladimíra Hejzlarová	Chemical analyses
Vladimír Jirák	Building maintenance, electrician
Ing. Jitka Kroupová	Chemical analyses
Marie Kupková	Phytoplankton analyses
Václava Lavičková	Documentalist
Ing. Radka Malá	Bacteriological analyses, cultivation of microbes
Ing. Petr Mautschka	Technical and financial management, computer maintenance, network administration
Mgr. Karel Murtinger	Analytical chemistry
Zdeněk Prachař	Field assistance, zooplankton analyses
Soňa Smrčková, DiS. (from March maternity leave)	Bacteriological analyses, data processing
Dagmar Šrámková	Secretary, accountant
Marie Štojdlová	Biochemical analyses, image analysis
Martina Vožechová	Secretary, laboratory analyses
MUDr. Jana Zemanová	Zooplankton analyses and culture maintenance

Ph.D. STUDENTS:

Mgr. Kateřina Bernardová	Genetics of cyanobacteria
RNDr. Martin Čech (till April)	Fish behaviour in the open water
Mgr. Vladislav Draštík	Fish behaviour and community structure
RNDr. Karel Horňák (till April)	Bacterioplankton community composition and activity
Ing. Jiří Jarošík	Mathematical modelling of reservoirs
RNDr. Jan Jezbera (till April)	Protozoan-bacterial interactions
RNDr. Jitka Jezberová (till November)	Identification of cyanobacterial picoplankton
Mgr. Tomáš Jůza	Fish sampling and community structure
RNDr. Jiří Kaňa (till October)	Water and soil chemistry
Mgr. Vojtěch Kasalický (from October)	Bacterial-algal interactions
Mgr. Michal Kratochvíl	Fish biology
Mgr. Monika Krollová	Macrophyta in reservoirs
RNDr. Jindřich Novák	Fish ethology
RNDr. Jiří Peterka (till April)	Fish foraging
RNDr. Marie Prchalová	Fish behaviour
Mgr. Dagmar Sirová	Benthic cyanobacterial mats
Mgr. Martina Štrojsová	Digestive enzymes of rotifers
RNDr. Alena Štrojsová (till January)	Extracellular phosphatases of phytoplankton
Mgr. Jan Turek (till May)	Hydrology and water chemistry
Mgr. Eliška Zapomělová	Morphology of cyanobacteria

STUDENT HELP:

Jiří Jan, Bc.

Oldřich Jarolím, Bc.

Milan Říha, Bc.

Michal Tušer, Bc.

1 INTRODUCTION

By a resolution of the twenty-seventh session of the Academy Assembly of the AS CR held on 15 December 2005, the Institute of Hydrobiology of the AS CR, was included into the new legislative entity the Biology Centre of the AS CR, together with the Institute of Entomology of the AS CR, Institute of Parasitology of the AS CR, Institute of Plant Molecular Biology of the AS CR, Institute of Soil Biology of the AS CR and the Technical and Administrative Service, as of 1 January 2006.

The basic staff of the institute has remained unchanged in 2006 as well as the research orientation of the institute. Regular long-term monitoring with some special investigations has continued in the Slapy and Římov reservoirs, and so has the research on lakes in the Bohemian Forest and in the Slovakian and Polish High Tatra Mts. Field research has been supplemented by focused laboratory experiments.

The work on the new Institutional Research Plan “Structure, functioning and development of aquatic ecosystems”, approved for the years 2005–2010, continued according the planned schedule.

The “Support Programme for targeted research in the AS CR” continues in the IHB through another project “Limnological basis of sustainable management of reservoirs”, approved for the period 2005–2009.

IHB is responsible for one site in the global LTER (long-term ecological research) and GTOS (global terrestrial observing system) networks - “Reservoirs in the Vltava River Watershed”. The site is registered in the database of TEMS (Terrestrial Ecosystem Monitoring Site) on the website: www.fao.org/gtos/tems.

Close cooperation of the IHB with the Faculty of Biological Sciences, University of South Bohemia, has continued under similar conditions as in preceding years. Institute members have also been actively engaged supervising students’ theses, lecturing and training students at other Faculties (Agriculture and Pedagogical) of the University of South Bohemia and at other Universities (Charles University, Prague, Institute of Chemical Technology, Prague). Five Bc. (B.A.), 5 Mgr. (M.Sc.) and 7 Ph.D. theses supervised by staff members were completed in 2006 (see list on the page 14). Most staff members work part-time for the University of South Bohemia and vice-versa. Students are active in the IHB as student helpers and part-time staff members (see list of staff).

1.1 Projects

Institutional Project, Academy of Sciences of CR

2005–2010 Reg. code AV0Z 60170517 Structure, functioning and development of aquatic ecosystems – Biology Centre AS CR, Institute of Hydrobiology.

Program Support of Targeted Research in the Academy of Sciences of CR

2005–2009 Reg. code 1QS600170504 Limnological basis of sustainable management of reservoirs – J. Matěna.

Projects Sponsored by the Grant Agency of the Academy of Sciences of CR

2003–2006 Reg. code A3017301 Modelling of processes in the system "atmosphere-catchment-reservoir" and their impacts to surface water quality – J. Hejzlar.

2005–2008 Reg. code IAA600170502 Sinusoidal foraging and the role of fish in reservoirs – J. Matěna.

2006–2008 Reg. code IAA600170602, Regulation of extracellular phosphatase activity in different morphotypes of natural bacterioplankton studied at the single-cell level – J. Nedoma.

Projects Sponsored by the Grant Agency of CR

2004–2006 Reg. code 206/04/0190 Local genetic differentiation of *Daphnia* in deep canyon-shaped dam reservoirs – J. Sed'a.

2004–2006 Reg. code 206/04/P092 Large scale survey of plant biomass and plant cover by echosounding – E. Hohausová.

2005–2007 Reg. code 206/05/0007 Changes in bacterioplankton structure and functioning in a reservoir related to single-cell activities of major phylogenetic groups of bacteria – K. Šimek.

2005–2007 Reg. code 206/05/P520 Identification of temporal and spatial arrangement of processes of phosphorus cycling – J. Borovec.

2006–2008 Reg. code 206/06/1371 Patterns and reasons of different pelagic behaviour of perch fry: novel insight into the declared ecological plasticity of a species – M. Čech.

2006–2008 Reg. code 206/06/P418 Seasonal dynamics of food consumption, growth and production of 0+ fish and their impact on zooplankton in a reservoir with a trophic gradient – M. Vašek.

2006–2008 Reg. code 206/06/0462 Competition relationships among dominant species of phytoplankton in the reservoirs – K. Kaštovská.

2006–2008 Reg. code 206/06/0410 Photochemical transformation of metal and phosphorus species in natural waters – J. Kopáček.

Project Sponsored by the Ministry of Education, Youth and Sports CR

2005–2006 (Czech-France project PAI Barrande) Quantification of enzymatic activities at single-cell level using fluorescent labelling and image analysis – J. Nedoma.

European Communities R&D Program 6th Framework

2004–2009 EURO-LIMPACS Integrated Projects to Evaluate the Impacts of Global Change on European Freshwater Ecosystems, EU Contract GOCE-CT-2003-505540 – J. Kopáček (coordinated by University College London).

2004–2009 ALTER-NET A long-term Biodiversity, Ecosystem and Awareness Research Network GOCE-CT-2003-505298 – V. Straškrábová (coordinated by Natural Environment Research Council, UK).

1.2 Consultancies

2006–2007 Survey of Chabařovice reservoir – J. Kubečka – Palivový kombinát (Fuel company) Ústí nad Labem.

2004–2008 Monitoring of populations of protected animals – J. Kubečka – Povodí Vltavy (Vltava river water authority).

2006–2007 Survey of reservoirs Římov, Nýrsko, Žlutice – J. Kubečka – Povodí Vltavy (Vltava river water authority).

1.3 Report on Finances

(in thousands CZK)

INCOME

Balance from preceding year	2918
Support by Academy of Sciences including Priority research programmes	20521
Grants from Grant Agency AS CR	1278
Grants from Grant Agency CR	4496
Foreign grants	2164
Consultancies	1888
Dissaving from the reserve fund	518
TOTAL	33784

EXPENSES

CONSUMABLES

Salaries	12833
Health & social insurance, social funds	4660
Other obligatory insurance of persons and property	192
Energy	733
Gasoline	252
Maintenance of buildings	270
Maintenance of cars and equipment	459
Postage, telephone, internet	164
Books, journals	495
Travelling costs and conference fees	1503
Computing, software	293
Other consumables and small equipment	4312
Others	553
<i>Subtotal</i>	<i>26718</i>

EQUIPMENT

Van VW transporter	1071
Microscope Nikon 90i	1858
Electrophoresis apparatus	296
Lyophilisator ALPHA	283
Image analysis system	645
Irradiance sensor Kipp	133
Labware washer	307
Small echolot with accessories	108
Flowmeter system	101
Winch and stabilizer	150
Others	475
<i>Subtotal</i>	<i>5427</i>

TOTAL	32145
--------------	--------------

BALANCE (the fund for equipment, depreciation)	1192
---	-------------

1.4 Presentations of Institute Members at International Conferences

1st ALTER-Net Summer School, Biodiversity and Ecosystem Services: Ecological and Socio-economic Aspects, Peyresq, France, 2–5 Sep 2006 – V. Straškrabová: Biodiversity in aquatic systems – related to their structure and processes.

1st EIFAC acoustic workshop, Wareham, Dorset, Great Britain, 21–24 Mar – J. Kubečka, J. Frouzová, M. Čech, V. Draštík, M. Tušer, G. Rakowitz: Acoustic assessment of fish stock quantity and behaviour (invited lecture).

5th International Conference on Reservoir Limnology and Water Quality, Brno, Czech Republic 27–31 Aug 2006 – 26 lectures, see the section "Publications" (p. 41) for the list.

ALTER-Net RA 3, Anthropogenic drivers and pressures, metaanalysis group, Grenoble, France, 1–6 Mar 2006 – V. Straškrabová: Climate and aquatic systems – effects on biodiversity.

ALTER-Net RA3 Workshop: Anthropogenic drivers and pressures, Halle/Saale, Germany, 16–19 Jun 2006 – V. Straškrabová: Drivers and pressures in aquatic systems and their effects.

ALTER-Net Workshop WP R3, Impact of the main natural and anthropogenic drivers and pressures on biodiversity, Uppsala, Sweden, 18–21 Sep 2006 – Viera Straškrabová: Review paper on influence of climate change on aquatic systems (invited lecture).

BIOGEOMON 2006, 5th International Symposium on Ecosystem Behaviour, Orono, USA, 18 Jun – 3 Jun 2006 – J. Kopáček, J., S.A. Norton, P. Porcal, and J. Veselý: Photochemical source of aluminium for sediments and its long-term impact on internal phosphorus cycling.

S.A. Norton, K., Coolidge, A., Amirbahman, J. Kopáček & R.J., Bouchard: Speciation of Al, Fe, and P in recent sediment of three Maine lakes, USA.

P. Porcal, A. Amirbahman, J. Kopáček & S.A. Norton: Photochemical release of metal species in stream waters.

Catchment to Coast, 27th International Conference of the Society of Wetland Scientists, Australie, 9–14 Jun 2006 – Eva Hohausová, J. Kubečka, S. Husák, J. Frouzová, M. Tušer, O. Jarolím, L. Pialek: Horizontal echosounding: New approach of detecting biomass of aquatic macrophytes.

Evaluation of the ecological quality of lakes by their fish fauna, Belin, Germany, 1–3 Mar 2006 – J. Kubečka, J. Hejzlar, V. Draštík, M. Prchalová, and M. Říha: Fish stock and Ecological Potential of Reservoirs and lakes in the Czech Republic.

Importance of antropogenic interventions for restoring river habitats, Wien, Austria, 15–17 Jun 2006 – J. Kubečka, J. Frouzová, M. Čech, M. Tušer, E. Hohausová, G. Rakowitz: Fish behaviour and reconstruction of the true size from acoustic records.

Symposium on hydropower, flood control and water abstraction: Implications for fish and fisheries, Mondsee, Austria, 14–17 Jun 2006 – V. Draštík, J. Kubečka, M. Čech, J. Frouzová, M. Tušer: Effect of flow regulation on the distribution of fish abundance and biomass; comparison of cascade and non cascade reservoirs.

M. Hladík, J. Kubečka: Effects of the construction of an artificial reservoir on the fish population in the inflow river.

XI International Symposium on Rotifers, University of Mexico, Mexiko, 11–18 Mar 2006 - M. Štojsová, J. Vrba: Rotifer digestive enzymes: Direct detection using the ELF method.

1.5 Stays & Visits of Institute Members Abroad

- J. Borovec**, *INBO*, Brussels, Belgium, 18–22 Nov (participation at workshop).
- J. Frouzová**, *Biologische Station Neusiedler See*, Illmitz, Prof. Dr. Alois Herzig, Austria, 31 Jul – 7 Aug (hydroacoustic survey); *Konstanz University, Limnological Institute*, Konstanz, Germany, Prof. R. Eckman, 4–7 Dec (consultation on methodology of telemetry and otolite analysis).
- J. Hejzlar**, *Honne Conference Centre*, Biri, Norway, 14–15 March (EU project EUROHARP meeting), *European Regional Centre for ECOHYDROLOGY*, Lodz, Poland, Kinga Krauze, Maciej Zalewski, 10–12 Sep (EU project ALTER-Net meeting - modeling and forecasts)
- E. Hohausová**, *Biologische Station Neusiedler See*, Illmitz, Austria, Prof. Dr. Alois Herzig, 31 Jul – 7 Aug (hydroacoustic survey).
- J. Jezbera**, *Leibniz-Institute of Freshwater Ecology and Inland Fisheries*, Neuglobsow, Germany, Dr. Hans-Peter Grossart, 8–29 Oct (molecular biology methods, sample processing).
- J. Jezberová**, *CNR, Institute for Ecosystem Study*, Sesto Fiorentino, Italy, Dr. Stefano Ventura, 2–19 Jun, (analysis of picoplankton phylogenetic data)
- T. Jůza**, *Biologische Station Neusiedler See*, Illmitz, Austria, Prof. Alois Herzig, 31 Jul – 7 Aug (hydroacoustic survey).
- J. Kaňa**, *Štátné Lesy TATAPu*, Tatranská Lomnice, Slovakia, *TPN Administration*, Zakopané, Poland, 22–28 Sep (sampling of Tatra mountain lakes).
- J. Kopáček**, *Bayerische Landesanstalt für Wald und Forstwirtschaft*, Germany, 7 Sep (field sampling); *Štátné Lesy TATAPu*, Tatranská Lomnice, Slovakia, *TPN Administration*, Zakopané, Poland, 22–28 Sep (sampling of Tatra mountain lakes).
- M. Kratochvíl**, *Mississippi State University, Department of Wildlife and Fisheries*, Mississippi, USA, Prof. L. E. Miranda, 22 Oct – 14 Nov (short term stay).
- J. Kubečka**, *University of Oslo, Department of Physics*, Norway, Dr. Helge Balk, 9–22 Jul (elaboration of the "cross filter" method for sonar data analysis, paper preparation); *Biologische Station Neusiedler See*, Illmitz, Austria, Prof. Alois Herzig, 31 Jul – 7 Aug (hydroacoustic survey).
- J. Nedoma**, *University of Zurich, Limnological Station*, Kilchberg, Switzerland, Prof. Jakob Pernthaler, Dr. Thomas Posch, 18–20 Apr (image analysis); *CNRS, LMGEM: Laboratoire de Microbiologie Géochimie et Ecologie Marines*, Marseille, France, 3–9 Jan, Dr. France Van Wambeke (paper preparation).
- P. Porcal**, *Štátné Lesy TATAPu*, Tatranská Lomnice, Slovakia, *TPN Administration*, Zakopané, Poland, 22–28 Sep (sampling of Tatra mountain lakes).
- M. Prchalová**, *Konstanz University, Limnological Institute*, Konstanz, Germany, Prof. R. Eckman, 4–7 Dec (consultation on methodology of telemetry and otolite analysis).
- M. Říha**, *Swedish Board of Fisheries (Fiskeriverket)*, Goteborg, Dr. Kerstin Holmgren, *Institute of Freshwater Research (Sötvattenslaboratoriet)* Drottningholm, Sweden, 13–21 Jun (debate on European standards on fish sampling); *Konstanz University, Limnological Institute*, Konstanz, Germany, Prof. R. Eckman, 4–7 Dec (consultation on methodology of telemetry and otolite analysis).

- V. Straškrábová**, *Alterra*, Wageningen, Netherland 11–14 Oct (EU-project ALTER-Net Management Group meeting, case study AQUACLIM); *Institut f Natur Besoek*, Brussels, Belgium, 21–24 Nov (EU-project ALTER-Net, WP R2, I2 a R5 workshop); *Corpo Forestale delle Stato*, Roma, Italy, 3–9 Mar (EU-project ALTERnet, RA4, RA6, I4, I3 workshop); *Fakultaet für Forstwissenschaften Buesgenweg*, Goettingen, Germany, 10–13 Jan (EU-project ALTERnet Network Management Group); *Conecofor, Corpoforestale dello stato*, Itály, 7–10 Oct (EU-project ALTERnet, TG2 group, WP R2).
- K. Šimek**, CNRS, Mar. Microb. Ecol. Grp, Villefranche-Sur-Mer, France, Dr. John Dolan, Dr. M. Wienbuaer, 3–14 Apr (preparation of common project PICS, paper preparation).
- M. Štrojsová**, *Bayerische Landesanstalt für Wald und Forstwirtschaft*, Germany, 7 Sep (lake Rachelsee sampling).
- J. Vrba**, *PIK (Potsdam Institut für Klimaforschung)*, Potsdam, Německo, 3–4 Mar 2006 (ALTER-net, E1 core group meeting); *Bayerische Landesanstalt für Wald und Forstwirtschaft*, Germany, 7 Sep (lake Rachelsee sampling); *Gobabeb Training and Research Centre*, Namibia, 11–20 Aug (ILTER Annual Coordinating Committee Meeting).
- P. Znachor**, *Corpo Forestale delle Stato*, Roma, Italy, 3–9 Mar (EU-project ALTERnet, RA4, RA6, I4, I3 workshop).

1.6 Foreign Visitors to Hydrobiological Institute

Gloria naa Dzama Addico, UK, University of Hull, Hull.

Hans-Peter Grossart, Germany, Leibnitz Institute of Freshwater Ecology and Inland Fisheries, Stechlin.

Jeffrey R. Johansen, USA, John Carroll University, University Heights

A.I. Kopylov, D.B. Kosolapov, Russia, Institute for Biology of Inland Waters, Russian Academy of Sciences, Borok.

Karine Leblanc, Veronique Bathaux-Cornet, France, Laboratoire de Microbiologie Géochimie et Ecologie Marines, CNRS, Marseille.

Leandro E. Miranda, USA, Mississippi State University.

Thomas Posch, Switzerland, University of Zurich, Department of Limnology, Kilchberg.

Katharina Schleidt, Minu Ayromlou, Austria, Umweltbundesamt, Wien.

France Van Wambeke, Solange Duhamel, France, Laboratoire de Microbiologie Géochimie et Ecologie Marines, CNRS, Marseille.

Markus G. Weinbauer, France, Station of Zoology, Dept. Microbiol Ecology, Villefranche-sur-mer.

1.7 Students' Theses Finished in 2006

- Ph.D.** **Martin Čech:** Diel vertical migrations, distribution and ontogeny of bathypelagic layer of European perch, *Perca fluviatilis* L. fry in reservoirs (*FBS USB**, supervised by J. Kubečka).
- Karel Horňák:** Diversity and functioning of bacterioplankton assemblages in the Římov reservoir (*FBS USB*, supervised by K. Šimek).
- Jan Jezbera:** Protozoan food preferences studied by means of in situ hybridization techniques (*FBS USB*, supervised by K. Šimek).
- Jitka Jezberová:** Phenotypic diversity and phylogeny of picocyanobacteria in mesotrophic and eutrophic freshwater reservoirs investigated by a cultivation-dependent approach (*FBS USB*, supervised by J. Komárková).
- Jiří Kaňa:** Impact of soil characteristics on water chemistry of acidified mountain lakes in the Bohemian Forest and the Tatra Mountains (*FBS USB*, supervised by J. Kopáček).
- Jiří Peterka:** Feeding selectivity and efficiency of young-of-the-year fish - insights from field data and laboratory experiments (*FBS USB*, supervised by J. Matěna).
- Alena Štrojsová:** Expression of extracellular phosphatases in phytoplankton populations at the single-cell level (*FBS USB*, supervised by J. Vrba).
- Mgr. (M.Sc.) Petr Illek:** Analysis of variability in biomass and species composition of phytoplankton in the Římov reservoir (*FBS USB*, supervised by J. Hejzlar).
- Tomáš Juza:** Sampling of the offshore fry fish communities by trawls (*FBS USB*, supervised by J. Kubečka).
- Kateřina Kolářová:** The genetic structure of *Daphnia galeata* population on vertical profile of Rimov Reservoir (*FBS USB*, supervised by J. Sed'a).
- Michal Kratochvíl:** Spatio-temporal distribution and feeding patterns of young percids (Percidae) in reservoirs with different regimes (*FBS USB*, supervised by J. Matěna).
- Dagmar Sirová:** Extracellular enzyme activities in benthic cyanobacterial mats: comparison between nutrient enriched and control sites in marshes of northern Belize (*FBS USB*, supervised by J. Vrba).
- Bc. (B.A.) Oldřich Jarolím:** Depth distribution of fish in the open water of reservoir (*FBS USB*, supervised by J. Kubečka).
- Pavel Rychtecký:** Methodics used in study of competition relations among species of phytoplankton (*FBS USB*, supervised by J. Komárková).
- Irena Slámová:** Seasonal and spatial dynamics of sexual generation of *Daphnia galeata* in Římov Reservoir (*FBS USB*, supervised by J. Macháček).
- Klára Šámalová:** Retention of Phosphorus and Nitrogen in Reservoirs and Lakes Reservoir. (*FBS USB*, supervised by J. Hejzlar)
- Ondřej Štěrbá:** Importance of macrophytes in the budget of phosphorus in Nýrsko Reservoir (*FBS USB*, supervised by J. Hejzlar).

*) FBS USB = Faculty of Biological Sciences, University of South Bohemia

2 RESERVOIRS

2.1 Regular Monitoring of the Reservoirs Slapy and Římov: Dissolved and Dispersed Substances in 2006

Annual and summer mean concentrations of chemical constituents dissolved and dispersed in the surface layers of the Slapy and Římov reservoirs (Table 1) were obtained by *J. Hejzlar* and *J. Kopáček*. Samples were taken from 0.1 to 0.4 m depth at the deepest points of the reservoirs in three-week intervals, pre-filtered through a 200- μm polyamide sieve to remove large zooplankton, stored in the dark at 4°C, and analysed within 48 h after sampling. Dissolved constituents were analysed in samples filtered through a glass fibre filter with 0.4 μm nominal pore size. Abbreviations in Table 1 are: TON, total organic nitrogen; DON, dissolved organic nitrogen; TN total nitrogen; TP, total phosphorus; TDP, total dissolved phosphorus; COD, chemical oxygen demand; DOC and POC, dissolved and particulate organic carbon, respectively. Summer means: April to September.

Table 1: Mean values of main chemical constituents dissolved and dispersed in the waters of Slapy Reservoir and Římov reservoir in 2006.

VARIABLES	UNIT	MEAN VALUES			
		Slapy		Římov	
		Annual	Summer	Annual	Summer
NO ₃ -N	$\mu\text{g l}^{-1}$	2057	2659	1352	1191
NO ₂ -N	$\mu\text{g l}^{-1}$	22	44	9	12
NH ₄ -N	$\mu\text{g l}^{-1}$	54	84	60	68
TON	$\mu\text{g l}^{-1}$	759	928	509	578
DON	$\mu\text{g l}^{-1}$	627	708	432	454
TN	$\mu\text{g l}^{-1}$	2892	3715	1930	1849
TP	$\mu\text{g l}^{-1}$	57.3	53.4	27.8	21.3
TDP	$\mu\text{g l}^{-1}$	37.2	26.3	16.9	11.2
COD	mg l^{-1}	25.0	26.6	18.1	19.8
DOC	mg l^{-1}	8.09	9.27	5.99	6.97
POC	mg l^{-1}	0.91	1.66	0.51	0.75
Ca ²⁺	mg l^{-1}	17.5	17.8	10.2	9.5
Mg ²⁺	mg l^{-1}	4.8	5.0	2.4	2.2
Na ⁺	mg l^{-1}	8.5	8.0	6.1	5.4
K ⁺	mg l^{-1}	3.7	3.7	2.1	2.0
SO ₄ ²⁻	mg l^{-1}	22.7	24.1	15.1	14.8
Cl ⁻	mg l^{-1}	11.0	10.9	5.9	5.2
Alkalinity (Gran)	meq l^{-1}	0.78	0.69	0.43	0.38
Conductivity at 25°C	$\mu\text{S cm}^{-1}$	203	202	124	114

2.2 Regular Monitoring of the Reservoirs Slapy and Římov: Microbial Characteristics, Chlorophyll and Zooplankton Biomass in 2006

Annual and summer mean concentrations of bacteria, protozoans, microzooplankton, BOD₅ (total and after separating algae by filtration) as well as chlorophyll concentrations in the reservoirs and inflows to Římov Reservoir, and mesozooplankton biomass in the reservoirs,

based on data by *Z. Brandl, J. Komárková, R. Malá, A. Hartmanová, Z. Prachař, J. Sed'a, K. Šimek, M. Štojdlová, V. Straškrábová, M. Štrojsová* and *M. Vožechová* are shown in Table 2.

Table 2: Mean values of microbial characteristics, zooplankton, chlorophyll and BOD in the Slapy and Římov Reservoirs and inflows. "Summer": April to September. Sites: S-Slapy and R-Římov Reservoirs, C-Černá and M-Malše rivers – inflows to Římov Reservoir.

SITE	VARIABLE	LAYER	UNIT	MEAN VALUE		
				Annual	Summer	
S	BOD ₅	0 m	mg l ⁻¹ O ₂	1.97	2.99	
	BOD ₅ filtered	0 m	mg l ⁻¹ O ₂	–	1.78	
	bacteria DAPI	0 m	10 ⁶ ml ⁻¹	3.15	4.87	
	bact. Beef-pept. agar	0 m	CFU ml ⁻¹	330	460	
	het. nanoflag.	0 m	10 ³ ml ⁻¹	1.37	2.28	
	chlorophyll <i>a</i>					
	Total	0–3 m	mg m ⁻³	13.70	27.25	
	>40 μm	0–3 m	mg m ⁻³	9.68	18.87	
	zooplankton biomass, protein N					
	Cladocera herbiv.	0–41m	mg m ⁻²	77.1	128.1	
Copepoda	0–41m	mg m ⁻²	72.5	124.1		
total zooplankton	0–41m	mg m ⁻²	152.8	259.4		
R	BOD ₅	0 m	mg l ⁻¹ O ₂	1.75	1.88	
	BOD ₅ filtered	0 m	mg l ⁻¹ O ₂	–	1.38	
	bacteria DAPI	0 m	10 ⁶ ml ⁻¹	2.26	2.89	
	bact. Beef-pept. agar	0 m	CFU ml ⁻¹	500	520	
	bact. yeast ext. agar	0 m	10 ³ CFU ml ⁻¹	3.3	4.9	
	het. nanoflag.	0 m	10 ³ ml ⁻¹	0.66	0.72	
	Rotifers	0–7 m	per ml	230	365	
	Nauplii	0–7 m	per ml	25	41	
	chlorophyll <i>a</i>					
	total	0–3 m	mg m ⁻³	10.74	20.72	
> 40 μm	0–3 m	mg m ⁻³	4.92	8.82		
zooplankton biomass, protein N						
Cladocera herbiv.	0–40 m	mg m ⁻²	93.0	110.2		
Copepoda	0–40 m	mg m ⁻²	33.5	41.1		
total zooplankton	0–40 m	mg m ⁻²	128.8	154.7		
C	BOD ₅	0 m	mg l ⁻¹ O ₂	1.58	1.34	
	chlorophyll <i>a</i>	0 m	mg m ⁻³	3.98	3.81	
M	BOD ₅	0 m	mg l ⁻¹ O ₂	1.89	1.94	
	chlorophyll <i>a</i>	0 m	mg m ⁻³	5.37	7.62	

2.3 Regular Monitoring: Fish Stock Composition in the Římov Reservoir in 2006

The fish stock of the Římov reservoir was monitored traditionally by night seining. Open water and benthic habitats were also studied by split-beam echosounder, gillnets, pelagic trawl and purse seine. The inshore area was fished quantitatively (Kubečka and Bohm, 1991, Journ. Fish Biol., 38: 935–950). Field work was carried out by *J. Kubečka, J. Čech, V. Drašík, J. Frouzová, T. Jůza, O. Jarolím, M. Kratochvíl, J. Peterka, M. Prchalová, Z. Prachař* and

M. Vašek. Analysis of the catch was done by **M. Říha** and **J. Kubečka**. The composition of the catch is given in Table 3.

Sampling was shifted from August to the first week in September due to high water level in the reservoir in August. The nets used were 50 m and 200 m long and the total area of 1.2 hectares of the inshore area was fished. The estimate of inshore fish biomass was higher compared to previous year with total fish biomass about 109 kg.ha⁻¹. Common bream and roach still remained the most important fish species in the reservoir, representing the bulk in both numbers and biomass. On the other hand, ruffe in relative abundance and pike in relative biomass increased their proportion compared with previous years. But these population fluctuations will probably not markedly affect the stability of cyprinid dominance.

Table 3: Composition of the fish stock of the Římov Reservoir in 2006 according to night shore seining estimate.

Common name	Latin name	Abundance ind ha ⁻¹	Biomass kg ha ⁻¹	% Abundance	% Biomass
Perch	<i>Perca fluviatilis</i>	201.1	10.2	9.81	9.4
Roach	<i>Rutilus rutilus</i>	698.6	31.0	34.1	28.4
Bream	<i>Abramis brama</i>	542.5	33.1	26.5	30.3
Chub	<i>Leuciscus cephalus</i>	0	0	0	0
Rudd	<i>Scardinius erythrophthalmus</i>	6.7	1.07	0.33	0.98
Pike	<i>Esox lucius</i>	17.6	13.3	0.86	12.2
Asp	<i>Aspius aspius</i>	5.89	1.49	0.29	1.37
Dace	<i>Leuciscus leuciscus</i>	40.3	0.78	1.97	0.71
Bleak	<i>Alburnus alburnus</i>	58.46	1.48	2.85	1.36
Ruffe	<i>Gymnocephalus cernuus</i>	394.2	2.83	19.2	2.59
Pikeperch	<i>Stizostedion lucioperca</i>	37.7	2.63	1.84	2.41
Gudgeon	<i>Gobio gobio</i>	5.05	0.05	0.25	0.04
Hybrid	<i>Abramis x Rutilus</i>	31.3	1.21	1.53	1.11
Carp	<i>Cyprinus carpio</i>	6.3	9.69	0.31	8.87
Eel	<i>Anguilla anguilla</i>	0	0	0.00	0
White bream	<i>Blicca bjoerkna</i>	4.2	0.37	0.21	0.34
	Total	2050	109	100	100

M. Říha (riha.milan@centrum.cz) in his master's thesis processed data on the long-term development of the fish stock in the reservoir for the period from 1985 through 2006. The data were derived from night inshore seining only. In the initial part of the period, a highly dynamic and unstable phase with perch dominance, was replaced by a cyprinid dominance phase. The cyprinid phase, dominated by roach and bream, has remained extremely stable from 1988 until the present. The abundance of both species oscillated during the cyprinid phase, but with decreasing amplitude. The proportion of piscivorous fish species has increased slightly but has still remained quite low and is unlikely to influence the population dynamics of the dominant fish species in a significant way. Most likely, the carrying capacity of the reservoir was responsible for the stabilization of abundance and biomass of dominant species. The Shannon-Weaver index of diversity has increased during the succession, mainly due to a greater evenness in number among the species.

2.4 Changes in Phytoplankton Chlorophyll in the Slapy Reservoir after the Great Flood 2002

J. Hrbáček (JHrbacek@seznam.cz) evaluated two data-sets on chlorophyll *a* concentrations measured in Slapy reservoir at the Nebřich field station in 2003–2006 (1) at three week intervals by the IHB staff using the Lorenzen spectrophotometric method, and, in parallel, (2) weekly by J. Hrbáček and colleagues using a fluorometric method. For the latter method, samples were filtered by pressing filtered the water through the filter disc 9 mm in diameter by a syringe pipette. This procedure does not need laboratory equipment. **E. Stuchlík**, **J.Fott** and **L.Nedbalová** (all from Faculty of Natural Sciences, Charles University, Praha) measured fluorimetrically the concentration of chlorophyll extracted by the acetone methanol mixture from these discs. Fig. 1 demonstrates not only a statistically significant increase during the 2003–2006 period but also the shift from a distinct three peak pattern in the first three years to poorly defined three peaks in 2006 as the second peak is represented only by one value.

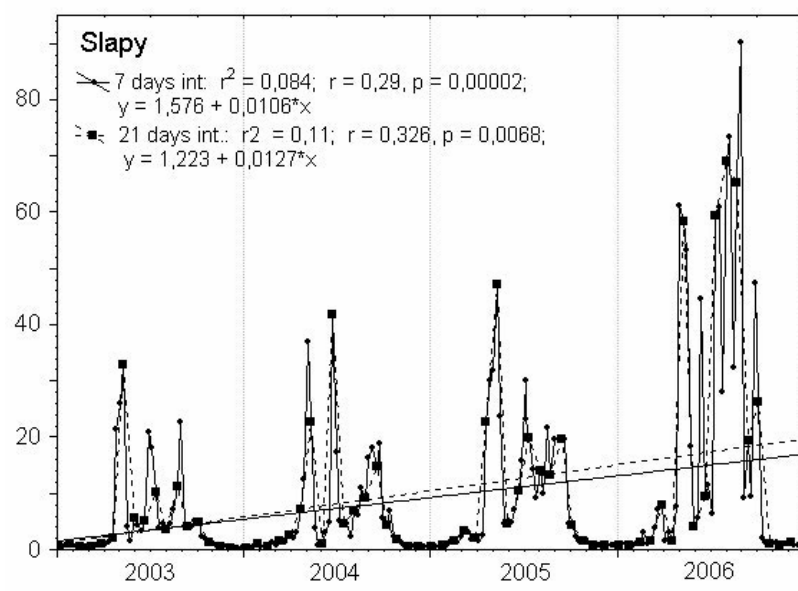

Fig. 1: The course of chlorophyll *a* in the mixed samples 0–4 m from the Slapy reservoir. Small round points and full line represent data sampled at 1 week interval. Square points and dashed line present data in 3 weeks intervals.

The logarithmic transformation of the data (Fig. 2) reveals in greater detail the differences between different years during the cold period of the year. It is broadly accepted that after the autumn destratification the development of algae is controlled mainly by light. In general terms there are only slight year to year differences in the seasonal course of the amount of light reaching the surface of the reservoir. As the observed data are considerably variable from year to year the possible explanation is that either the differences in transparency or the intensity of the mixing of the water column from the surface to the bottom is different in individual periods of the investigated years. The cooling period from around 10th September until around 10th October appears to have the lowest variability. Transparency was reduced by the inflow of turbid river water during the high throughflow of the reservoir cascade from mid-February to the beginning of April 2005, however, the expected response, i.e. low values of chlorophyll, was not observed in this period.

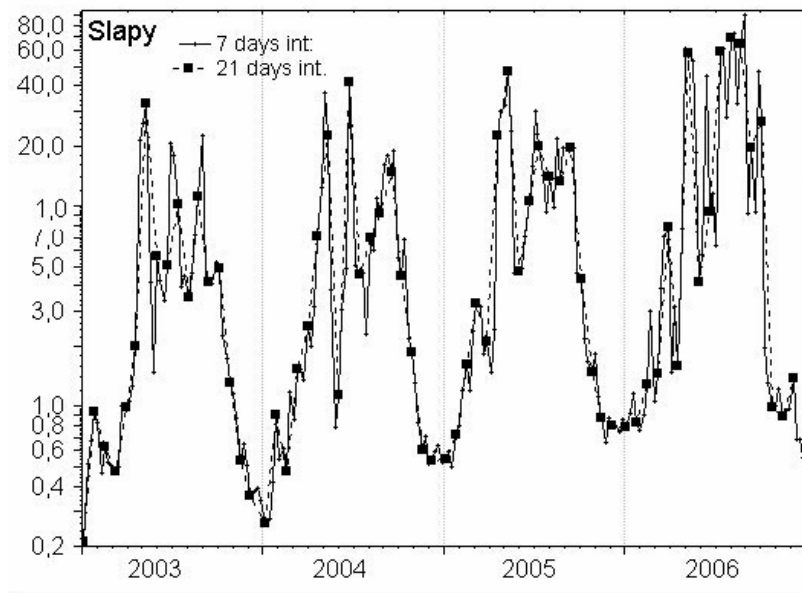

Fig. 2: Logarithmic transformation of the course of chlorophyll *a* in the mixed samples from the depths 0–4 m from the Slapy reservoir.

From the comparison of the two sampling periodicities used it can be seen that sampling density did not influence substantially the general trend of the increase in chlorophyll *a* concentration, as represented by the regression lines in Fig. 1. The sampling density, however, did in some cases affect the relative height of the observed peaks. In 2006 the number of peaks changes from an indistinct three to a distinct two.

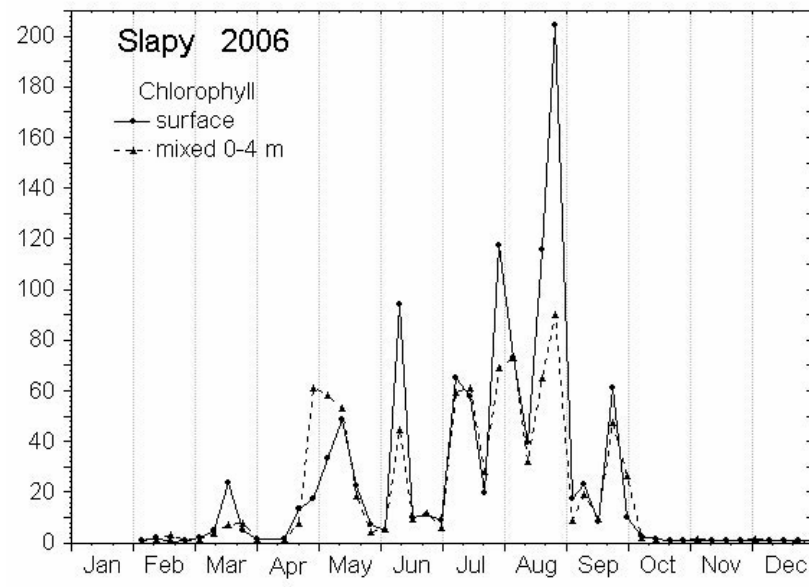

Fig. 3: Comparison of chlorophyll *a* in samples from surface and mixed sample from 0–4 m layer in the Slapy reservoir.

The fluorometric procedure is less time-consuming and therefore enables more measurements. Fig. 3 compares the amount of chlorophyll in the samples from the surface and samples representing the column from the surface to four meters' depth. This comparison shows that during most of the growing season there is more chlorophyll in the surface layers. It also indicates that at the times when the samples were collected (10 30 a.m. or 11 30 a.m. daylight-saving time) the upper four meters were already at least partly stratified.

Figs. 1 and 4 indicate that not only the number of summer high values but also the size distribution of particles does not fully support the PEG model. The smallest particles (<0.10 mm) prevail, as expected, strongly in the spring peak but their amount again increases after the clear water period and remains high in comparison to cold water periods. So it seems that its amount is more limited by light than by the filtration of zooplankton with the exception of the clear water phase. The two summer peaks show a distinct difference in size composition. The possible reason for this difference is not clear. As presented in the Annual Report 2005, there are only two peaks of zooplankton and so there is an increase and decrease of the biomass of the filtratory cladocerans during this period.

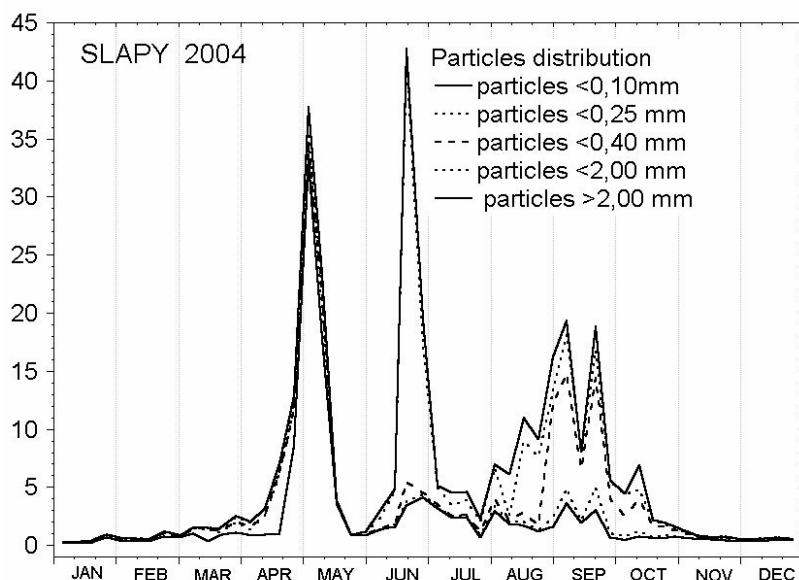

Fig. 4: Size distribution of particles in mixed sample 0–4 m in the Slapy reservoir.

2.5 The Effect of Extreme Rainfalls on Summer Succession and Vertical Distribution of Phytoplankton in a Lacustrine Part of a Eutrophic Reservoir

Over the summer of 2006, *P. Znachor* (znachy@hbu.cas.cz), *E. Zapomělová*, *K. Řeháková*, *J. Nedoma*, *J. Jezberová*, *P. Rychtecký* and *K. Šimek* studied phytoplankton summer succession and vertical distribution in eutrophic Římov Reservoir. A diatom assemblage dominated exclusively by *Fragilaria crotonensis* Kitton was accompanied with minor populations of cryptophytes and/or cyanobacteria. Disturbances in the form of dramatic summer storm events had a crucial impact on phytoplankton succession and its vertical distribution. Two extreme rainfalls (June 29–30, August 7–8) substantially increased flushing rates, yielding fairly short water retention time that disrupted established thermal stratification

(Fig. 5A). The first storm event virtually initiated the development of summer phytoplankton while later in the summer the second storm reversed the phytoplankton succession to the earlier *Fragilaria* dominated stage. Based on three-day intervals, the measurement of vertical profiles of chlorophyll *a* with a submersible fluorescence probe provided evidence that phytoplankton were heterogeneously distributed in the water column for the most of the period studied and formed remarkable subsurface diatom maxima (SDM). SDM were found at various depths (2–6.5 m), which significantly coincided with both euphotic and mixing depths (Fig. 5B).

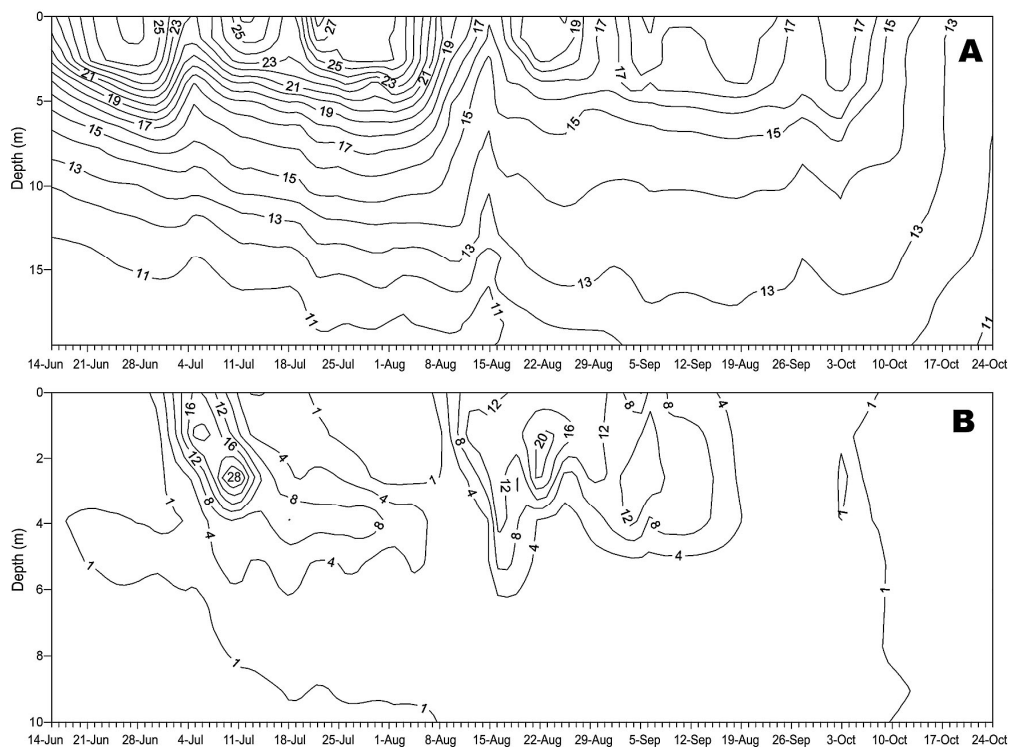

Fig. 5: Vertical variations in water temperature (A) and distribution of diatom chlorophyll *a* (B) over the study period.

At weekly intervals, biogenic silica deposition studied by PDMPO (2-(4-pyridyl)-5{[4-dimethylaminoethyl-aminocarbonyl]-methoxy} phenyl}oxazole) fluorescence was tentatively measured to compare *Fragilaria* growth rates over the season and between the surface and the depths where SDM were located. *Fragilaria* population deposited 20 times more silica at the surface than at the SDM depth. However, only one half of the surface *Fragilaria* population was involved in the silica deposition. At the surface, the maximal rates of silica deposition were measured in samples just after both summer storms. The most important parameters of water chemistry in terms of shaping phytoplankton dynamics and ecology in the reservoir were ambient concentrations of Si and P. When *Fragilaria* dominated the phytoplankton, the amounts of available Si and P in water were significantly correlated ($r^2=0.81$, $p<0.001$). Outliers from the linear relationship were found only in a period when a substantial picocyanobacterial population developed in the reservoir (Fig. 6). Due to their lack of Si requirements, the ambient Si concentration markedly increased while P was depleted to growth limiting levels. Temporal variations in the Si:P ratio therefore illustrate the importance of resource competition in phytoplankton seasonal succession.

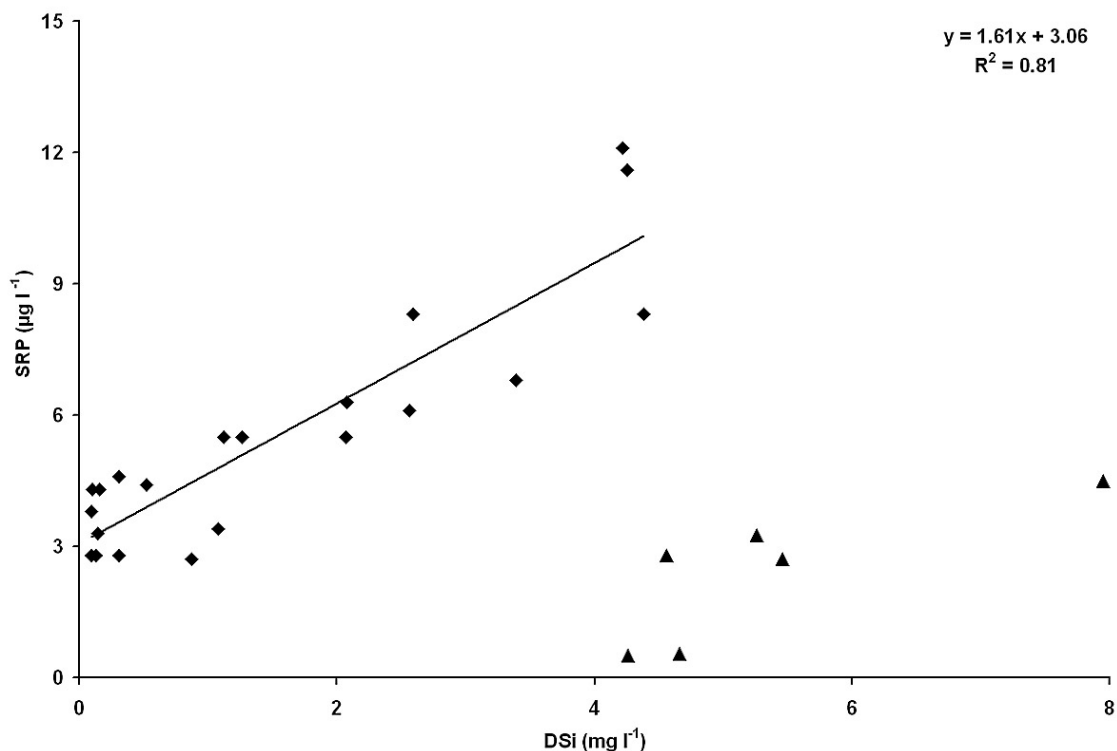

Fig. 6: Linear correlation between ambient SRP and DSi concentrations (pooled data from both depths studied). Triangles indicate samples dominated by picocyanobacteria not included in the correlation.

2.6 Effects of the Cyanobacterial Bloom on Bacterial Growth and Activity

K. Horňák (hornak@hbu.cas.cz) examined changes in the bacterioplankton community composition and activity using fluorescence *in situ* hybridization and microautoradiography. Special attention was paid to the impacts of a cyanobacterial bloom dominated by *Microcystis aeruginosa* and to protistan bacterivory inducing changes in growth and leucine-uptake activity of bacterioplankton in the canyon-shaped Římov reservoir. To alter the resource availability and predation pressure, a manipulation experiment using size-fractionation and dialysis bag techniques, assuring relatively free exchange of resources, was conducted during the summer phytoplankton maximum (18–22 August 2003). Samples collected from two stations (the dam and middle part of the reservoir) were incubated for 4 days as <0.8 µm, <5 µm, and unfiltered size-fractions in dialysis bags *in situ* and in parallel transferred and incubated in the other station (i.e. Dam sample in Middle station and vice versa).

Abundance and growth of total bacterioplankton and of different genotypic groups of bacteria examined decreased significantly in treatments which had been transplanted to station Middle characterised by a heavy cyanobacterial bloom. In contrast, the opposite transfer to station Dam stimulated bacterial growth. Moreover, under comparable levels of protistan grazing at both stations, the percentage and activity of *Betaproteobacteria* and of its R-BT065 subcluster transplanted to station Middle decreased strongly while members of the *Sphingobacteria/Flavobacteria* lineage become a dominant part of the community. *Gammaproteobacteria* accounted for very minor proportions of the total community at both stations but was highly active in leucine incorporation, perhaps stimulated by the bloom

event. The presence of a *Microcystis*-dominated bloom and of enhanced bacterivory thus induced group-specific changes in the genotypic and activity structure of the bacterial community. The results also suggest different sensitivity of bacterial groups to cyanobacterial bloom and document the seasonal and spatial variability of the bacterioplankton assemblage in the Římov reservoir.

2.7 Synergistic and Antagonistic Effects of Viral Lysis and Protistan Grazing on Bacterial Production and Diversity in a Freshwater Reservoir

K. Šimek (ksimek@hbu.cas.cz), **K. Horňák**, **J. Jezbera**, **J. Nedoma** (BC AS CR, Institute of Hydrobiology), and **M. Weinbauer** and **J. R. Dolan** (Station of Zoology, Villefranche-sur-Mer, France) collaborated on processing data gained from the *in situ* experiment dealing with responses in bacterioplankton community composition and dynamics to manipulation-induced changes in the key top-down controlling factors, protistan bacterivory and viral lysis.

We investigated the effects of distinct bacterial mortality factors, viral lysis and heterotrophic nanoflagellates (HNF) bacterivory, on bacterial production, community composition and the development of filamentous *Flectobacillus* populations in a freshwater reservoir. Bacterioplankton communities were subjected to additions of both HNF and viruses together, or HNF and viruses alone, and then incubated *in situ* in dialysis bags. Ribosomal-RNA-targeted probes and denaturing gradient gel electrophoresis (DGGE) were employed to enumerate bacterial groups and assess bacterial community composition. For distinct bacterial groups, mortality or growth stimulation was analyzed by examining bacterial prey ingested in HNF food vacuoles with fluorescence *in situ* hybridization (FISH) and via FISH combined with microautoradiography (MAR-FISH).

We developed a semi-quantitative MAR-FISH-based estimation of relative activities of *Flectobacillus* populations. Bacterial groups vulnerable to HNF predation (mainly clusters of *Betaproteobacteria*), or discriminated against (*Actinobacteria*), were detected. Bacterial lineages most vulnerable to virus-lysis (mainly the *Betaproteobacteria* not targeted by the R-BT065 probe affiliated with the *Polynucleobacter* cluster) were identified by comparing treatments with HNF alone to treatments with HNF and viruses together [1]. Overall, bacterivory by flagellates was associated with reductions in bacterial diversity and increases in viral production while treatments with viruses alone yielded increases in bacterial diversity [2]. Filaments affiliated with the *Flectobacillus* cluster appeared in both treatments with HNF present, but were about twice as abundant, long and active as in incubations with viruses and HNF as compared to HNF alone. Viruses appeared to selectively suppress several bacterial groups, perhaps enhancing substrate availability thus stimulating growth and activity of filamentous *Flectobacillus* [1].

Ecologically important implications for the possible life strategies of distinct bacterioplankton groups subjected to the interplay of mortality sources in the reservoir are discussed in detail in two recently accepted papers:

- [1] Šimek, K., Weinbauer, M.G., Horňák, K., Jezbera, J., Nedoma, J., and Dolan, J.R. 2007. Grazer and virus-induced mortality of bacterioplankton accelerates development of *Flectobacillus* populations in a freshwater community. *Environ. Microbiol.* 9: 789–800.
- [2] Weinbauer, M.G., Horňák, K., Jezbera, J., Nedoma, J., Dolan, J.R., and Šimek, K. 2007. Synergistic and antagonistic effects of viral lysis and protistan grazing on bacterial biomass, production and diversity. *Environ. Microbiol.* 9: 777–788.

2.8 Local Genetic Differentiation of *Daphnia* in Deep Canyon-shaped Reservoirs (2004–2006, project supported by Czech Science Foundation)

This was a collaborative project involving researchers from two Czech institutions, BC AS CR, IHB in České Budějovice and Charles University in Prague. The following people participated in the project: (1) **J. Sed'a** (seda@hbu.cas.cz), **J. Macháček**, **K. Kolářová**, **B. Horová**, **I. Vaníčková**, **J. Kubečka**, **J. Zemanová** and **Z. Prachař** (BC AS CR, Institute of Hydrobiology), (2) **A. Petrušek** and **Š. Ruthová** (Charles University).

The project focused on the spatial distribution and interspecific hybridization of cladocerans of the *Daphnia longispina* complex in long canyon-shaped reservoirs. Three species of the complex occurring in the Czech reservoirs (*D. galeata*, *D. cucullata* a *D. longispina*) hybridize with each other; reliable identification of parental species and hybrid genotypes is possible only by using molecular tools. We used allozyme electrophoresis and DNA restriction analysis in the project, and collaborated on the development of improved protocol for ITS-RFLP. We repeatedly collected five samples from each of eleven studied reservoirs to cover both horizontal and vertical environmental gradients. Three sampling stations per reservoir were selected, one near the river inflow, one in the middle and one close to the dam; at the latter we separately sampled the epi-, meta- and hypolimnion. In accordance with our hypothesis, the taxonomic composition of *Daphnia* and of other crustaceans in the samples was heterogeneous and non-random. For the first time, regular patterns in the horizontal distribution of *Daphnia* parental species and interspecific hybrids were demonstrated within one water body. The most important factors shaping this heterogeneity are probably the intensity of size-selective fish predation and food availability and quality. There were often strong and significant differences in *Daphnia* taxon composition among sampling sites within reservoirs, the between-year variability was an order of magnitude lower.

A genetically differentiated, non-migrating subpopulation of *D. galeata* living in the deep hypolimnion was discovered in Římov reservoir, a locality studied in more details. This subpopulation is probably founded repeatedly by clones favoured under hypolimnetic conditions. Difference in life history between epi- and hypolimnetic *D. galeata* clones were also confirmed in laboratory experiments. In addition, intrapopulation differentiation of *D. galeata* along horizontal and/or vertical axes was observed also within several other reservoirs, mostly long or deep ones. This confirms the importance of spatial separation as the factor promoting the effect of environmental gradients on genetic differentiation.

Publications:

- [1] Sed'a, J., Petrušek, A., Macháček, J., and Šmilauer, P. Spatial distribution of the *Daphnia longispina* species complex and other planktonic crustaceans in the heterogeneous environment of canyon-shaped reservoirs. *Journal of Plankton Research* (in press).
- [2] Sed'a, J., Kolářová, K., Petrušek, A., and Macháček, J. *Daphnia galeata* in the deep hypolimnion: spatial differentiation of a “typical epilimnetic” species. *Hydrobiologia* (in press).
- [3] Macháček, J. and Sed'a, J. 2007. Life history response of *Daphnia galeata* to heterogeneous conditions within a reservoir as determined in cross-designed laboratory experiment. *Aquatic Ecology* 41: 55-66.
- [4] Skage, M., Hobæk, A., Ruthová, Š., Keller, B., Petrušek, A., Sed'a, J., and Spaak, P. Intra-specific rDNA-ITS restriction site variation and an improved protocol to distinguish species and hybrids in the *Daphnia longispina* complex. *Hydrobiologia* (in press).

2.9 The Use of Pelagic Habitat by Cyprinids in a Deep Eutrophic Impoundment (Římov Reservoir, Czech Republic)

(supported by the project of the Grant Agency of the Academy of Sciences of the Czech Republic: *Sinusoidal foraging and the role of fish in reservoirs, 2005–2008*)

M. Vašek (mojmir.vasek@seznam.cz) and **O. Jarolím** analysed the data on the seasonal use of open water habitat by planktivorous fish in the deep moderately eutrophic Římov Reservoir. Data sampling was carried out from April to October 2005 and consisted of gillnetting, hydroacoustics and diet analyses. The day and night acoustic surveys revealed that the majority of pelagic fish were present in the upper 5 m of the water column (Fig. 7).

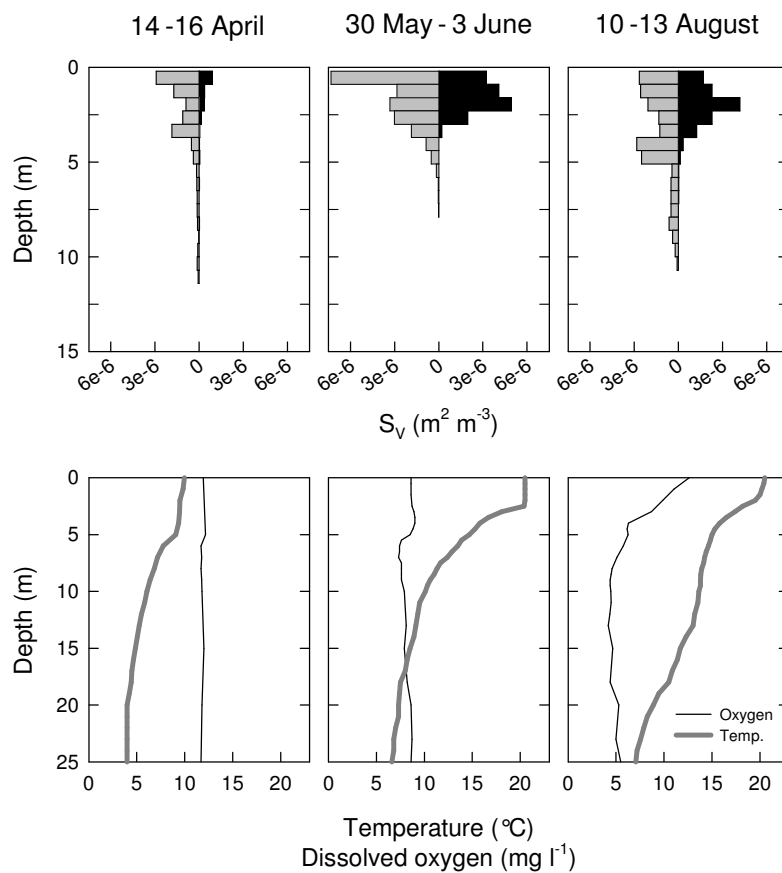

Fig. 7: Vertical distribution of acoustic fish biomass (S_V) during the day (□) and night (■) and temperature and oxygen profiles in the pelagic zone of the Římov Reservoir on three sampling occasions in 2005. No fish echoes were recorded below the depth of 15 m.

The highest gillnet catches of planktivorous fish in epipelagic waters were obtained in May and August. The lowest fish catches were recorded in April and October which resulted in significant positive correlation between the gillnet catch per unit effort and water temperature. The majority of captured fish were adult individuals of three cyprinid species: roach *Rutilus rutilus*, bleak *Alburnus alburnus* and bream *Abramis brama*. In late spring and summer, large cladocerans predominated in the diets of the three cyprinids. In early spring, bream consumed cyclopoid copepods, bleak foraged primarily on terrestrial insects and the gut contents of pelagic roach consisted mainly of littoral food components, algae and detritus. In general, cyprinids used the open water habitat most intensively during the period of increased water temperatures, which coincided with relatively high seasonal availability of cladoceran prey.

2.10 Spring Events in Pelagic Succession of Two Reservoirs - Climate Effect

Based on long-term data sets from reservoirs Slapy and Římov, some aspects of seasonal pelagic succession in relation to climate were elaborated by V. Straškrábová (verastr@hbu.cas.cz), Z. Brandl, J. Komárková, M. Macek, J. Sed'a, K. Šimek, and J. Vrba.

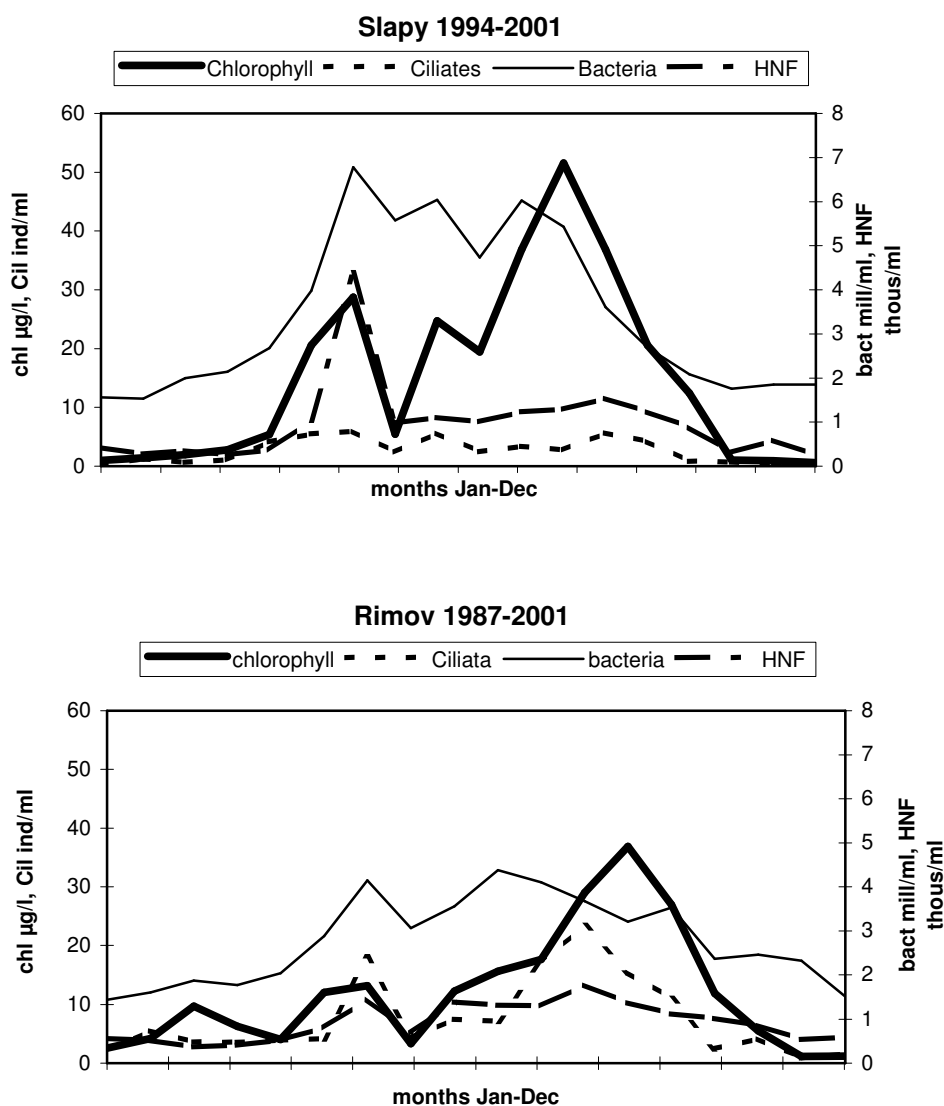

Fig. 8: Average seasonal changes of chlorophyll, bacteria, heterotrophic flagellates and ciliates in Slapy and Římov reservoirs

First, average seasonal changes of pelagic biota (bacteria, heterotrophic flagellates, ciliates, chlorophyll *a*, cladocerans and copepods) were constructed. Before averaging, data from different years were harmonized for a characteristic phase of the seasonal cycle - the clear water phase, i.e. the dates of the minimum chlorophyll *a* concentrations between the vernal and summer peaks were superimposed (Figs. 8 and 9).

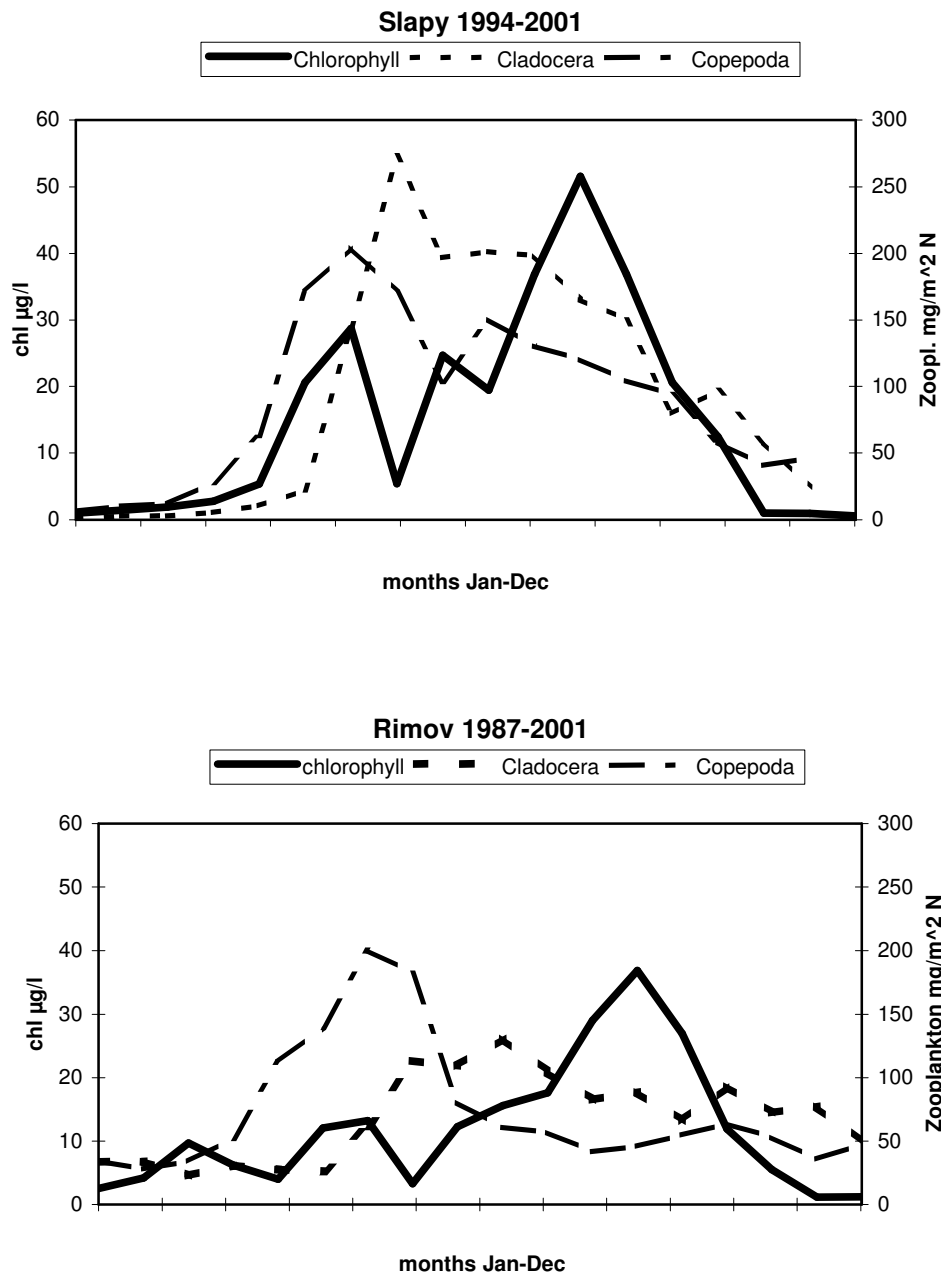

Fig. 9: Average seasonal changes of chlorophyll, cladocerans and copepods in Slapy and Římov reservoirs

Several differences in seasonal succession between the two reservoirs were identified. (i) Chlorophyll peaks, both vernal and summer, were higher in Slapy than in Římov, and so were vernal peak of flagellates and peaks of copepods and cladocerans. (ii) Regularly, a late-winter peak of chlorophyll was observed in Římov under the ice, whereas it was absent in Slapy (not always frozen). In Slapy, copepods grew faster and reached their vernal maxima almost one month earlier than in Římov. (iii) Abundances of ciliates in Slapy were lower than in Římov, and the vernal ciliate peak was absent. Differences under item (i) are well explained by a higher trophicity (higher P concentration - see Table 2, this report) in Slapy reservoir than in Římov. The shorter ice-period in Slapy as well as its higher temperature of water in winter are

due to the inflow from the upper reservoir (in cascade), and, as a consequence, spring overturn proceeds differently and might also be the reason for the earlier emergence of copepods - point (ii). The seasonal pattern of ciliates and copepods indicates that the absence of the vernal ciliate peak in Slapy could be a consequence of grazing activity by these early copepods - point (iii).

Selected characteristics of the spring-to-early-summer development in pelagic food webs were then evaluated for each year of the long-term series: the timing and duration of the vernal chlorophyll peak (up to the clear-water phase), and the timing of the vernal increase of copepods and cladocerans. They were then tested for correlation with the climate proxy - viz. the preceding winter NAO index (North Atlantic Oscillation).

Table 4: Correlation coefficients between winter NAO index, and start (days from January 1) and duration (days) of spring chlorophyll (Chl) peak in reservoirs Slapy (SL) and Římov (RI). DJF – NAO December, January, February, DJFM – NAO December, January, February, March. 25 cases, significance: *** 0.001, ** 0.01, * 0.05, n.s. not significant.

	Chl SL start	Chl SL duration	Chl RI start	Chl RI duration
Average days	99	54	96	49
NAO-DJF	– 0.702 ***	n.s.	– 0.520 *	0.656 ***
NAO-DJFM	– 0.634 **	n.s.	– 0.463 *	0.596 **

The most significant negative correlation was found between NAO-DJF (see Tab. 4) and the timing of the vernal chlorophyll increase in both reservoirs. At high (positive) NAO-DJF indexes the onset of the vernal temperature stratification and of phytoplankton development occurred earlier. However, the effect of the climate proxy was not fully coherent in the two reservoirs. In Římov, the correlation of the onset of phytoplankton development with the NAO index was less significant than in Slapy, and the maximum vernal peaks of chlorophyll and bacteria were lower after a high winter NAO index. On the other hand, the duration of vernal phytoplankton peaks in Římov was significantly positively correlated with the preceding winter NAO index (which means a later occurrence of the clear water phase), whereas there was no such correlation in Slapy.

The onset of copepod increase (emerging from the sediment) and of a later cladoceran development was less significantly correlated with either the winter or the spring (MAM) NAO index as shown in Tab. 5. Cladoceran development showed no significant correlation with NAO in either reservoir. Copepod emergence was significantly negatively correlated with spring NAO index - MAM in Slapy, or winter index including March (DJFM) in Římov.

Table 5: Correlation coefficients between winter NAO index, and start (days from January 1) of vernal copepod (Cop) and cladoceran (Clad) peaks in reservoirs Slapy (SL) and Římov (RI). MAM – NAO March, April, May. 25 cases. Significance as in Table 4.

	Cop SL start	Clad SL start	Cop RI start	Clad RI start
average days	96	132	89	132
NAO - DJF	n.s.	n.s.	n.s.	n.s.
NAO - DJFM	n.s.	n.s.	– 0.551 **	n.s.
NAO - MAM	– 0.545 **	n.s.	– 0.467 *	n.s.

3 LAKES

3.1 Photochemical Source of Metals for Sediments

J. Kopáček (jkopacek@hbu.cas.cz), **P. Porcal**, **M. Marešová** (Faculty of Biological Sciences, University of South Bohemia, České Budějovice), **J. Veselý** (Czech Geological Survey, Prague) and **S. A. Norton** (Department of Earth Sciences, University of Maine, Orono, USA) evaluated a mass budget study of major in-lake Al fluxes, palaeolimnological data on a >10,000 year-old sediment record, and *in situ* photochemical experiments performed at Plešné Lake (Czech Republic). The data suggest that photochemical liberation of organically-bound aluminium (Al) and iron (Fe) by solar radiation is a significant natural source of their ionic species for lakes and subsequent oxyhydroxides for sediments.

The results show that photo-chemically induced transformation of dissolved Al and Fe to solid oxyhydroxides deposited to Plešné Lake sediment dominated (91 and 73%, respectively) their sedimentary flux throughout the pre-industrial era, since soil formation initiated in the catchment. The following sequence of processes occurs: (i) Soil organic acids dissolve and bind metals, and export them from terrestrial to aquatic systems. (ii) Photochemical decomposition of organic-metal complexes liberates a significant portion (~50% in Plešné Lake) of organically-bound Al and Fe as inorganic ions. (iii) The liberated ionic Al and Fe hydrolyse at pH>5, precipitate as oxyhydroxide particles, and settle. We hypothesise that the same Al and Fe transporting process occurs in other lakes and coastal marine areas and is ecologically important because Al and Fe oxyhydroxides can bind trace metals and phosphorus.

3.2 Element Fluxes in Catchment-Lake Ecosystems Recovering from Acidification

J. Kopáček (jkopacek@hbu.cas.cz), **J. Turek**, **J. Hejzlar**, **J. Kaňa**, and **P. Porcal** evaluated fluxes of major ions and nutrients in the catchment-lake ecosystems of two atmospherically acidified lakes (Čertovo and Plešné Lake) in the Bohemian Forest in 2001 through 2005 hydrological years. Čertovo and Plešné Lakes are the most acidified and the most fertile lake, respectively, in the lake district. The lakes are situated in a spruce forest (*Picea abies*) and have steep catchments, with maximum local relieves of 315 and 288 m. Water balance was estimated from precipitation and throughfall amounts, and outflow measured at each lake.

Čertovo Lake: The average water input into and outflow from the catchment-lake ecosystem was 1461 mm and 1271 mm ($40 \text{ l km}^{-2} \text{ s}^{-1}$), respectively, and the water residence time in the lake averaged 662 days. The ecosystem has been recovering from acidification since the late 1980s. Still, however, the Čertovo catchment was an average net source of $23 \text{ mmol m}^{-2} \text{ yr}^{-1}$ of SO_4^{2-} (on a catchment-area basis). Nitrogen saturation of the catchment caused low retention of the deposited inorganic N (23% on average). After a dry summer in 2003 and a cold winter in 2004, the catchment became a net source of inorganic N ($19 \text{ mmol m}^{-2} \text{ yr}^{-1}$). Nitrogen transformations and SO_4^{2-} release were the dominant terrestrial sources of H^+ (81 and $47 \text{ mmol m}^{-2} \text{ yr}^{-1}$, respectively) and the catchment was a net source of $42 \text{ mmol H}^+ \text{ m}^{-2} \text{ yr}^{-1}$. Ionic composition of tributaries showed seasonal variations with most pronounced changes in NO_3^- , base cations, DOC, and ionic Al (Al_i) concentrations.

The in-lake biogeochemical processes reduced the incoming H^+ by ~50% (i.e. neutralised on average $222 \text{ mmol H}^+ \text{ m}^{-2} \text{ yr}^{-1}$, on a lake-area basis). Denitrification, SO_4^{2-} reduction, and photochemical and microbial decomposition of allochthonous organic matter were the most

important in-lake H^+ consuming processes (215, 85, and 122 $\text{mmol } H^+ \text{ m}^{-2} \text{ yr}^{-1}$, respectively), while hydrolysis of Al_i was the dominant H^+ generating process (96 $\text{mmol } H^+ \text{ m}^{-2} \text{ yr}^{-1}$) in Čertovo Lake. Photochemical liberation from organic complexes was an additional in-lake source of Al_i . The net in-lake retention or removal of nutrients (carbon, phosphorus, nitrogen, and silica) varied between 18% and 34% of their inputs.

Plešné Lake: The average water input and output from the catchment-lake ecosystem was 1372 mm and 1157 mm ($37 \text{ l km}^{-2} \text{ s}^{-1}$), respectively, and the water residence time averaged 306 days. The Plešné catchment was an average net source of 25 $\text{mmol } SO_4^{2-} \text{ m}^{-2} \text{ yr}^{-1}$ (on a catchment-area basis). Nitrogen saturation of the catchment caused low retention of the deposited inorganic N (<44% on average) before 2004. Afterwards, the catchment became a net source of 28–32 $\text{mmol } \text{m}^{-2} \text{ yr}^{-1}$ of inorganic N in the form of NO_3^- due to climatic effects (a dry summer in 2003 and a cold winter in 2004) and forest dieback caused by a bark beetle attack in 2004. Nitrogen transformations and SO_4^{2-} release were the dominant terrestrial sources of H^+ (72 and 49 $\text{mmol } \text{m}^{-2} \text{ yr}^{-1}$, respectively) and the catchment was a net source of 24 $\text{mmol } H^+ \text{ m}^{-2} \text{ yr}^{-1}$. Ionic composition of surface inlets showed seasonal variations, with the most pronounced changes in NO_3^- , ionic Al (Al_i), and DOC concentrations, while the composition of subsurface inlets was more stable.

The in-lake biogeochemical processes reduced on average 59% of the incoming H^+ (251 $\text{mmol } H^+ \text{ m}^{-2} \text{ yr}^{-1}$ on a lake-area basis). NO_3^- assimilation and denitrification, photochemical and microbial decomposition of allochthonous organic acids, and SO_4^{2-} reduction in the sediments were the most important aquatic H^+ consuming processes (358, 121, and 59 $\text{mmol } H^+ \text{ m}^{-2} \text{ yr}^{-1}$, respectively), while hydrolysis of Al_i was the dominant in-lake H^+ generating process (233 $\text{mmol } H^+ \text{ m}^{-2} \text{ yr}^{-1}$). Photochemical liberation from organic complexes was an additional in-lake source of Al_i . The net in-lake retention or removal of total phosphorus, total nitrogen, and silica were on average 50%, 27%, and 23%, respectively. The lake was a net source of NH_4^+ due to a cease in nitrification (pH<5) and from NH_4^+ production by dissimilation exceeding its removal by assimilation.

3.3 Chlorophyll Content of Plešné Lake Phytoplankton Cells Studied with Image Analysis

J. Nedoma (nedoma@hbu.cas.cz), evaluated the data and processed the images obtained during a sampling campaign carried out at the small acidified mountain lake Plešné jezero (Plešné Lake) from May to November 2003. Using image analysis, chlorophyll autofluorescence was quantified in single cells of green alga *Monoraphidium dybowskii* and in filaments of cyanobacteria (*Pseudanabaena* sp. and *Limnothrix* sp.) sampled from different depths. Cell chlorophyll autofluorescence was converted to cell chlorophyll content using a conversion factor determined by comparing the total autofluorescence of phytoplankton in a microscope field with spectrophotometrically determined total chlorophyll concentration [1]. The conversion factor did not differ between the epilimnion (0.5 m depth) and the hypolimnion (9 m depth).

Vertical patterns of chlorophyll concentration and of cellular chlorophyll content depended on the water column mixing pattern (Fig. 10): during the period of stable thermal stratification, a metalimnetic peak in total chlorophyll concentration was present and cellular chlorophyll contents in the metalimnion and hypolimnion were notably elevated compared to the surface. Monotonous vertical profiles of both total chlorophyll concentration and cell chlorophyll content were typical for the period of water column overturn. During the

stratification period, hypolimnetic *Monoraphidium* cell chlorophyll content was on average twice as high (maximum difference 2.7-fold) compared to surface values, while in filamentous cyanobacteria, the difference was much higher: six-fold on average, with an 11.6-fold maximum value. There was surprisingly high seasonal variability in cell chlorophyll content in surface (0.5-m depth) samples (Fig. 11) both in *Monoraphidium* (3.2–12.9 $\text{fg } \mu\text{m}^{-3}$) and in cyanobacteria (2.2–13.3 $\text{fg } \mu\text{m}^{-3}$).

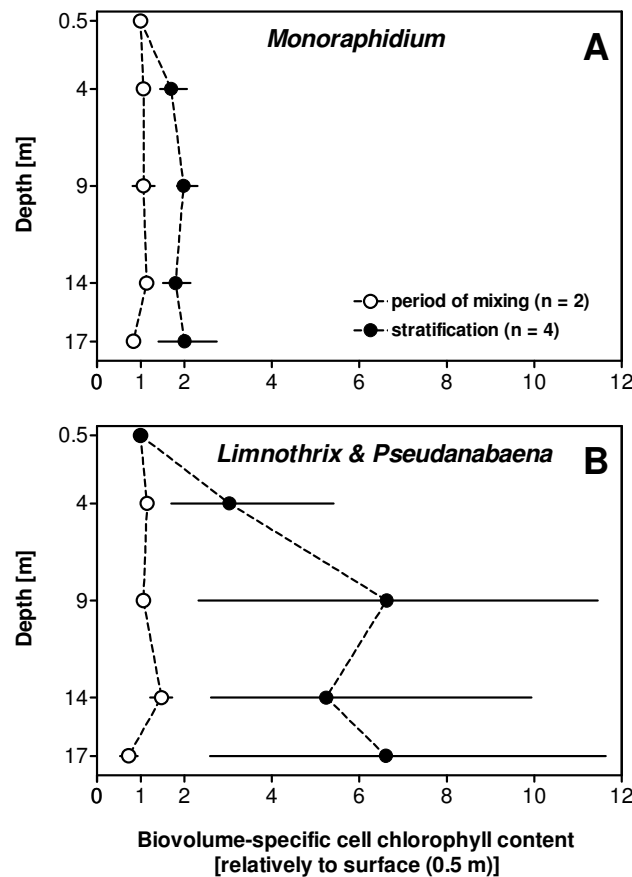

Fig. 10: Depth profiles of cellular chlorophyll in *Monoraphidium dybowskii* (A) and in filamentous cyanobacteria *Limnothrix* sp. and *Pseudanabaena* sp. (B) in Plešné Lake in 2003. The biovolume-specific cellular chlorophyll concentrations [$\text{fg } \mu\text{m}^{-3}$] were estimated with image analysis quantifying chlorophyll autofluorescence at single-cell level. Values at different depths were expressed relatively to the corresponding surface concentrations (equal to 1; see Fig. 12 for absolute values). Symbols represent averages and horizontal lines indicate ranges of values; these were plotted separately for the periods of water column stratification (closed symbols) and of mixing (open symbols).

Besides the well known high flexibility of cyanobacteria in regulating their chlorophyll content, the differential effect of other factors might have contributed to the observed differences in vertical patterns of *Monoraphidium* and cyanobacterial cellular chlorophyll content, e.g. different sedimentation rates and/or photoacclimation kinetics or the fact that *Monoraphidium* was more nutrient limited while cyanobacteria were more light limited. The vertical changes in cellular chlorophyll can be caused by both protection against intensive radiation near the surface and low-light acclimation in deeper strata; the resulting response

may have been, moreover, modulated by the opposing effect of low hypolimnetic temperature.

[1] Nedoma, J. and Nedbalová, L. 2006. Chlorophyll content of Plešné Lake phytoplankton cells studied with image analysis. *Biologia, Bratislava*, 61: 491—498.

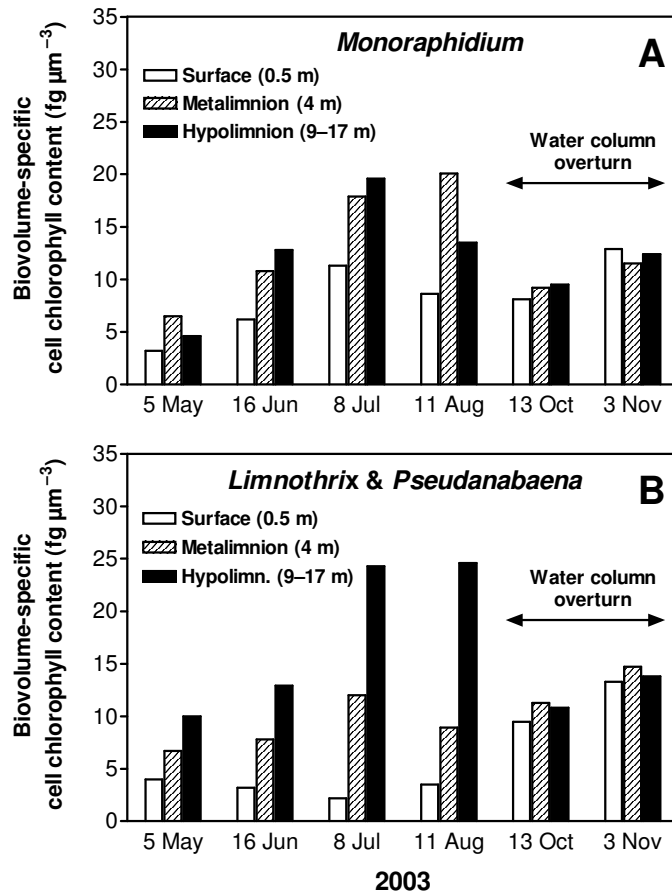

Fig. 11: Seasonal development of biovolume-specific cell chlorophyll content in *Monoraphidium dybowskii* (A) and in filamentous cyanobacteria (*Limnothrix* sp. and *Pseudanabaena* sp.) (B) at surface (0.5 m), in metalimnion (4 m), and in hypolimnion (average of the values measured at 9, 14, and 17 m) of Plešné Lake in 2003.

4 SPECIAL INVESTIGATIONS

4.1 Application of the PDMPO Technique in Studying Silica Deposition in Natural Populations of *Fragilaria crotonensis* in a Eutrophic Reservoir

From July to October 2006 at weekly intervals, *P. Znachor* (znachy@hbu.cas.cz) and *J. Nedoma* measured silica deposition in the summer diatom assemblage at various depths in a eutrophic Římov Reservoir (Czech Republic) using the PDMPO (2-(4-pyridyl)-5{[4-dimethylaminoethyl-aminocarbamyl)-methoxy] phenyl}oxazole) labelling technique. Fluorescence microscopy coupled with image analysis allowed quantifying Si deposition over time and a simple distinction between cells that are actively depositing Si and those that are not (Fig. 12).

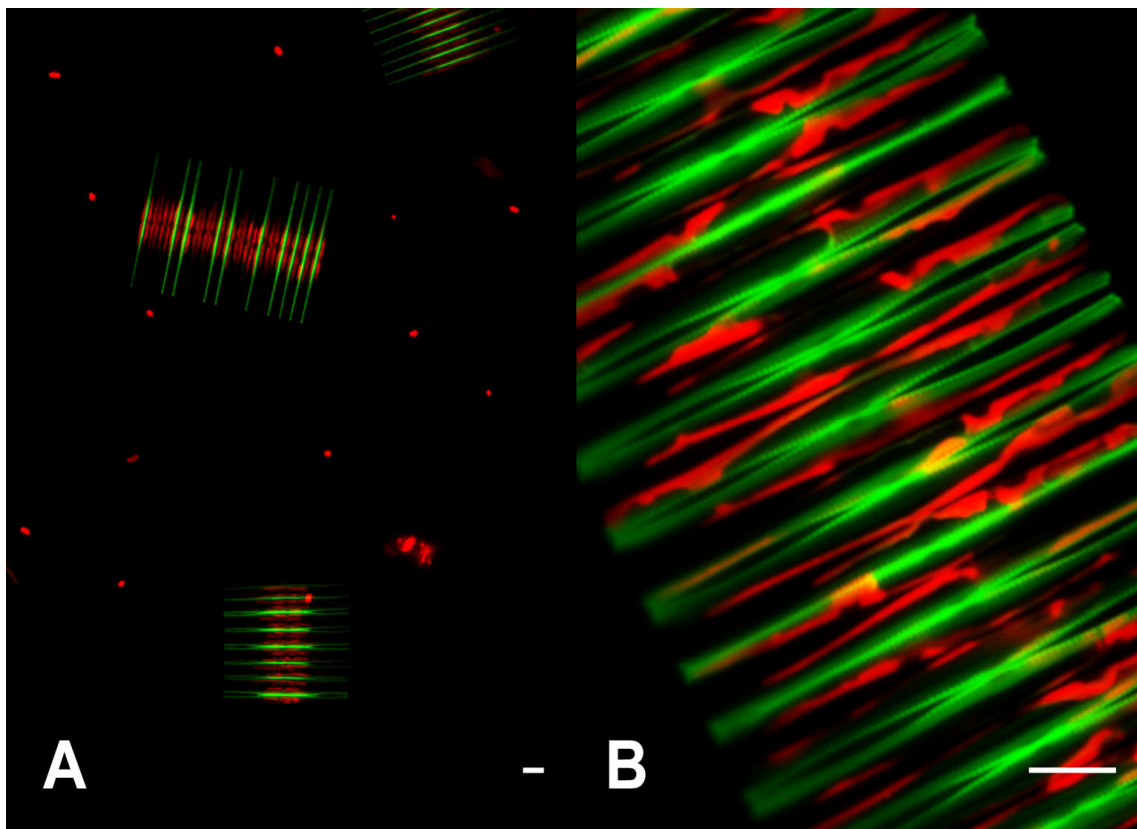

Fig. 12: Composite images of new silica deposition using a PDMPO fluorescence probe (green colour) and chlorophyll a autofluorescence (red colour). Colonies of *Fragilaria crotonensis* in the centre of panel A illustrate that not all cells in a colony are necessarily. Scale bars represent 10 μm .

The diatom assemblage was exclusively dominated by *Fragilaria crotonensis*, which formed pronounced subsurface maxima (2–6.5 m). Concentrations of the main nutrients (Si and P) were low over the whole season. However, at depth the nutrient availability was higher than at the surface. *Fragilaria* silica deposition rates were eight times higher at the surface than at depth. One half of the population was involved in silica deposition at the surface while only 20 % active cells were found at depth. At the surface, silica deposition was limited by phosphorus deficiency; the effect of dissolved Si was not statistically significant. Silica deposition at depth was significantly constrained by low light availability despite the fact that

average light availability at depth was 1% of surface light, which is normally supposed to be sufficient for photosynthesis. This study represents the first attempt to employ the PDMPO technique coupled with quantitative image analysis of PDMPO fluorescence in freshwater ecology. Based on our results, a PDMPO probe appears to be an appropriate proxy for resource limitation studies of natural diatom populations.

4.2 Modelling Phosphorus Retention in Lakes and Reservoirs

J. Hejzlar (hejzlar@hbu.cas.cz) with collaborators from the EUROHARP project (www.euroharp.org) evaluated existing steady-state models for the prediction of the P retention coefficient (R) in lakes and reservoirs. Input data for this evaluation included records from 93 natural lakes and 119 reservoirs situated mainly in the temperate zone. Most of the published models predicted R relatively successfully in lakes but seriously underestimated it in reservoirs. Statistical analysis indicated the main causes of differences in R between lakes and reservoirs: (i) distinct relationships between P sedimentation coefficient, depth, and water residence time; (ii) existence of significant inflow-outflow P concentration gradients in reservoirs.

Two new models of different complexity were developed for estimating R in reservoirs:

$$R = \frac{1.84\sqrt{\tau}}{1 + 1.84\sqrt{\tau}},$$

where τ is water residence time (yr), was derived from the Vollenweider/Larsen and Mercier model by adding a calibrated parameter accounting for spatial P non-homogeneity in the water body, and is applicable to reservoirs but not lakes, and

$$R = 1 - \frac{1.43}{[P_{in}]} \left(\frac{[P_{in}]}{1 + \sqrt{\tau}} \right)^{0.88},$$

where $[P_{in}]$ is volume-weighted P concentration in all inputs to the water body ($\mu\text{g l}^{-1}$), was obtained by re-calibrating the OECD general equation, and is generally applicable to both lakes and reservoirs. These optimised models yield unbiased estimates over a large range of reservoir types.

[1] Hejzlar, J., Šámalová, K., Boers, P., and Kronvang, B. 2006. Modelling phosphorus retention in lakes and reservoirs. *Water, Air & Soil Pollution: Focus*, 6: 487–494.

4.3 Large scale survey of plant biomass and plant cover by echosounding

The year 2006 was the closing year of the postdoctoral grant of the Grant Agency of the Czech Republic (No. 206/04/P092), 2004-2006 “Large-scale survey of plant biomass and plant cover by echosounding” carried out by **E. Hohašová** (ehoh@centrum.cz). The three-year study brought a range of results in the field of echosounding of aquatic macrophytes.

The aim of the project was to study the acoustic features of aquatic macrophytes by underwater acoustics. The goal was to find out whether a scientific echosounder can be successfully used in detection of aquatic macrophytes, in assessing macrophyte biomass and cover, and perhaps in identification of species. We used a SIMRAD EK60 split-beam echosounder with a circular composite transducer throughout the study. Experiments were made with both horizontal and vertical echosounding, when macrophytes were recorded by horizontally or vertically oriented sound beam. The main acoustic features observed in the aquatic plants were S_v (volume backscattering strength) - a measure of intensity of echo-reflection per volume, and shape of the peak of the reflected energy. Relation of these features to the real plant biomass (dry weight) was studied. We studied single plants and small and large patches of plants.

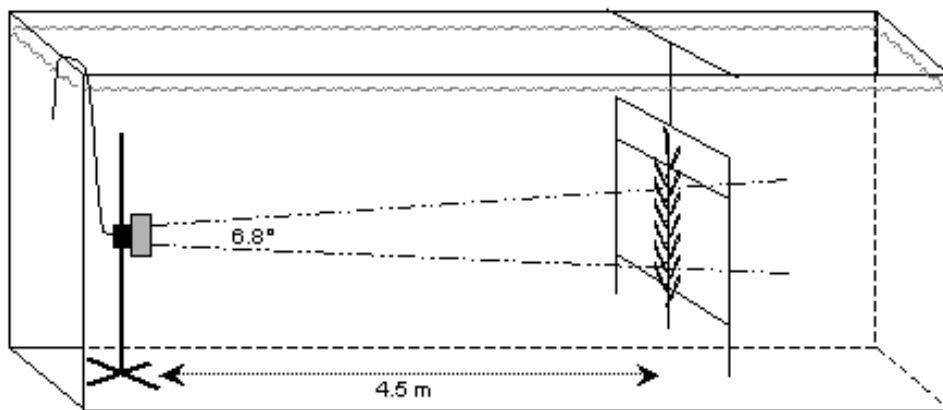

Fig. 13: A diagram view of an experimental set-up of echosounding of aquatic macrophytes in a pool (13x8x2 m). Distance ratios do not reflect the actual ones.

Using horizontal echosounding (sound beam emitted horizontally under water surface, Fig. 13) we experimentally studied three widespread and morphologically different species of aquatic macrophytes: Water persicaria (*Polygonum amphibium* L.), Eurasian watermilfoil (*Myriophyllum spicatum* L.), and Sago pondweed (*Potamogeton pectinatus* L.). All three species were studied in an experimental pool, watermilfoil and pondweed were studied also in situ in the Neusiedlersee in Austria.

All species were well detectable in the sound beam of the scientific echosounder. For all species, we found a positive linear relationship between echo-reflection intensity (S_v) and dry biomass of plants, describing up to 83% of the relationship variability. The slope of the S_v -biomass relationship differed statistically between species. On the other hand, when plotted irrespective to the species biomass, the ranges of S_v values of the different species overlapped, therefore S_v itself was not suitable for species identification (Fig. 14). These results were similar for the experiment and for the lake study. The physiological and/or morphological states of the plants probably influenced the echo-reflection intensity. Differences were found between the study in the lake and the pool experiment, when in the lake the reflected plant echoes were generally stronger than in the experiment. Here, hypotheses on physiology/morphology of plants need to be tested, and further extensive research is desirable.

When studying the shape of the reflected echo, more consistent results were found for single plants of each species than for small or large patches of plants. In the case of patches, their spatial structure may influence the shape of the echo, causing larger variability in the shape width. The echo shape of single plants differed visually between species, but not

statistically, i.e. echo shape was not suitable for species identification. The relationship between the echo shape and weight of plants was not significant at the studied scale of weights of the plants and thus echo shape could not serve as an acoustic measure of real biomass.

In experiments with vertical echosounding (the echosounder emitted the sound vertically into the water from below the water surface toward the bottom) we studied watermilfoil and *Chara hispida*. These experiments were performed in a deep artificial lake in order to reach the desired depth for vertical echosounding. The vertical echosounding showed good detectability of the watermilfoil in the sound beam, and rather limited detectability of *Chara*. The relationship between echo-reflection intensity (S_v) and plant biomass was found very weak for both species though. In the vertical orientation the echo shape was not found to be a suitable descriptive feature of the plants.

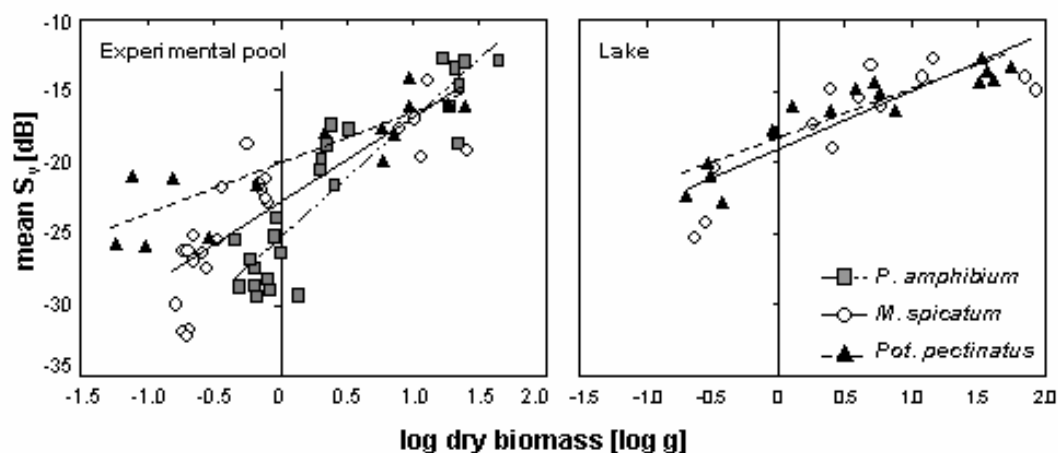

Fig. 14: Scatterplot of mean S_v and dry biomass of recorded plants, with trendlines of linear relationship for Water persicaria *Polygonum amphibium*, Eurasian watermilfoil *Myriophyllum spicatum*, and Sago pondweed *Potamogeton pectinatus*, in the experiment.

The results obtained brought basic information about “acoustic behaviour” of four widespread European species of aquatic macrophytes. They showed good potential in detection of three of the species of macrophytes mainly by horizontal echosounding. This is especially suitable for studies of plant cover and distribution in shallow waters, although yet without the option of species identification. The studies have also laid the groundwork for biomass detection *in situ*. More information can be gained from the following publications:

- [1] Hohausová E., Hejzlar J., Kubečka J., Frouzová J., Tušer M., Peterka J., Říha M., and Mudruňková J. 2006. Limnological importance of macrophytes in a newly recultivated strip-mine lake. A case study of the Chabařovice reservoir. Sborník konference Reservoir Limnology 2006, Brno, 199–201.
- [2] Hohausová E., Kubečka J., Frouzová J., Husák S, and Balk H. 2006 Experimentální hodnocení biomasy vybraných druhů vodních makrofyt horizontální echolokací. Vodárenská biologie, sborník konference, 100–105.
- [3] Hohausová E., Hejzlar J., Kubečka J., Frouzová J., Tušer M., Peterka J., Říha M., and Mudruňková J. 2006. Limnologický význam makrofyt v nově zatápné nádrži: Příklad nádrže Chabařovice. Sborník příspěvků 14. konference České limnologické společnosti. Nečtiny, 96–98.

5 PUBLICATIONS

(visit <http://www.hbu.cas.cz/papers.php> for the Institute bibliography 1993–2006)

(* authors from other institutions, R – review)

A: Papers in International Periodicals

- 1695 Čech, M., Kubečka, J., 2006: Ontogenetic changes in the bathypelagic distribution of European perch fry *Perca fluviatilis* monitored by hydroacoustic methods. *Biologia*, 61 (2): 211–219.
- 1696 Devetter, M.*, Sed'a, J., 2006: Regulation of rotifer community by predation of *Cyclops vicinus* (Copepoda) in the Římov reservoir in spring. *International Review of Hydrobiology*, 91 (1): 101–112.
- 1697 Dierberg, F.E.*, Potts, J.*, Kaštovská, K., 2006: Alterations in the suspended algal abundance, distribution and diversity within a stormwater treatment area in south Florida, USA. *Verhandlungen Internationale Vereinigung für theoretische und angewandte Limnologie*, 29: 2227–2231.
- 1698 Hejzlar, J., Šámalová, K., Boers, P.*, Kronvang, B.*, 2006: Modelling phosphorus retention in lakes and reservoirs. *Water, Air & Soil Pollution: Focus*, 6 (5–6): 487–494.
- 1699 Horňák, K., Jezbera, J., Nedoma, J., Gasol, J.M.*, Šimek, K., 2006: Effects of resource availability and bacterivory on leucine incorporation in different groups of freshwater bacterioplankton, assessed using microautoradiography. *Aquatic Microbial Ecology*, 45 (3): 277–289.
- 1700 Jezbera, J., Horňák, K., Šimek, K., 2006: Prey selectivity of bacterivorous protists in different size fractions of reservoir water amended with nutrients. *Environmental Microbiology*, 8 (8): 1330–1339.
- 1701 Kaňa, J., Kopáček, J., 2006: Impact of soil sorption characteristics and bedrock composition on phosphorus concentrations in two Bohemian Forest lakes. *Water, Air, and Soil Pollution*, 173 (1–4): 243–259.
- 1702 Komárková, J., Nedoma, J., 2006: The CYATAXO Database. *Czech Phycology*, 6: 49–54.
- 1703 Kopáček, J., Borovec, J., Hejzlar, J., Kotorová, I.*, Stuchlík, E.*, Veselý, J.*, 2006: Chemical composition of modern and pre-acidification sediments in the Tatra Mountain lakes. *Biologia*, 61 (Suppl. 18): S65–S76.
- 1704 Kopáček, J., Kaňa, J., Šantrůčková, H.*, 2006: Pools and composition of soils in the alpine zone of the Tatra Mountains. *Biologia*, 61 (Suppl. 18): S35–S49.
- 1705 Kopáček, J., Marešová, M.*, Norton, S.A.*, Porcal, P., Veselý, J.*, 2006: Photochemical source of metals for sediments. *Environmental Science & Technology*, 40 (14): 4455–4459.
- 1706 Kopáček, J., Stuchlík, E.*, Hardekopf, D.*, 2006: Chemical composition of the Tatra Mountain lakes: Recovery from acidification. *Biologia*, 61 (Suppl. 18): S21–S33.
- 1707 Kopáček, J., Turek, J., Hejzlar, J., Kaňa, J., Porcal, P., 2006: Element fluxes in watershed-lake ecosystems recovering from acidification: Plešné Lake, the Bohemian Forest, 2001–2005. *Biologia*, 61 (Suppl. 20): S427–S440.

- 1708 Kopáček, J., Turek, J., Hejzlar, J., Kaňa, J., Porcal, P., 2006: Element fluxes in watershed-lake ecosystems recovering from acidification: Čertovo Lake, the Bohemian Forest, 2001-2005. *Biologia*, 61 (Suppl. 20): S413–S426.
- 1709 Kopáček, J., Vrba, J., 2006: Integrated ecological research of catchment-lake ecosystems in the Bohemian Forest (Central Europe): A preface. *Biologia*, 61 (Suppl. 20): S363–S370.
- 1710 Křeček, J.*, Turek, J., Ljungren, E.*, Stuchlík, E.*, Šporka, F.*, 2006: Hydrological processes in small catchments of mountain headwater lakes: The Tatra Mountains. *Biologia*, 61, (Suppl. 18): S1–S10.
- 1711 Macek, M., Callieri, C.*, Šimek, K., Vázquez, A.L.*, 2006: Seasonal dynamics, composition and feeding patterns of ciliate assemblages in oligotrophic lakes covering a wide pH range. *Archiv für Hydrobiologie*, 166 (2): 261–287.
- 1712 Nedbalová, L.*, Vrba, J., Fott, J.*, Kohout, L.*, Kopáček, J., Macek, M., Soldán, T.*, 2006: Biological recovery of the Bohemian Forest lakes from acidification. *Biologia*, 61 (Suppl. 20): S453–S465.
- 1713 Nedoma, J., García, J.C.*, Comerma, M.*, Šimek, K., Armengol J.*, 2006: Extracellular phosphatases in a Mediterranean reservoir: seasonal, spatial and kinetic heterogeneity. *Freshwater Biology*, 51 (7): 1264–1276.
- 1714 Nedoma, J., Nedbalová, L., 2006: Chlorophyll content of Plešné Lake phytoplankton cells studied with image analysis. *Biologia*, 61 (Suppl. 20): S491–S498.
- 1715 Nedoma, J., Vrba, J., 2006: Specific activity of cell-surface acid phosphatase in different bacterioplankton morphotypes in an acidified mountain lake. *Environmental Microbiology*, 8 (7): 1271–1279.
- 1716 Piscia, R.*, Sed'a, J., Bonacina, C.*, Manca, M.*, 2006: On the presence of *Daphnia galeata* in Lake Orta (N. Italy). *Journal of Limnology* 65 (2): 114–120.
- 1717 Plachno, B.J.*, Adamec, L.*, Lichtscheidl, I.K.*, Peroutka, M.*, Adlassnig, W.*, Vrba, J., 2006: Fluorescence labelling of phosphatase activity in digestive glands of carnivorous plants. *Plant Biology*, 8 (6): 813–820.
- 1718 Pražáková, M.*, Veselý, J.*, Fott, J.*, Majer, V.*, Kopáček, J., 2006: The long-term succession of cladoceran fauna and palaeoclimate forcing: A 14,600-year record from Plešné Lake, the Bohemian Forest. *Biologia*, 61 (Suppl. 20): S387–S399.
- 1719 Prchalová, M., Kubečka, J., Hladík, M., Hohausová, E., Čech, M., Frouzová, J., 2006: Fish habitat preferences in an artificial reservoir system. *Verhandlungen Internationale Vereinigung für theoretische und angewandte Limnologie*, 29 (4): 1890–1894.
- 1720 Prchalová, M., Slavík, O.*, Bartoš, L.*, 2006: Patterns of cyprinid migration through a fishway in relation to light, water temperature and fish circling behaviour. *International Journal of River Basin Management*, 4 (3): 213–218.
- 1721 Prchalová, M., Vetešník, L.*, Slavík, O.*, 2006: Migrations of juvenile and subadult fish through a fishpass during late summer and fall. *Folia Zoologica*, 55 (2): 162–166.
- 1722 Rajaniemi-Wacklin, P.*, Rantala, A.*, Mugnai, M.A.*, Turicchia, S.*, Ventura, S.*, Komárková J., Lepistö, L.*, Sivonen, K.*, 2006: Correspondence between phylogeny and morphology of *Snowella* spp. and *Woronichinia naegeliana*, cyanobacteria commonly occurring in lakes. *Journal of Phycology*, 42 (1): 226–232.

- 1723 Šimek, K., Horňák, K., Jezbera, J., Nedoma, J., Vrba, J., Straškrábová, V., Macek, M., Dolan, J.R.*, Hahn, M.W.*, 2006: Maximum growth rates and possible life strategies of different bacterioplankton groups in relation to phosphorus availability in a freshwater reservoir. *Environmental Microbiology*, 8 (9): 1613–1624.
- 1724 Sirová, D.*, Vrba, J., Rejmánková, E.*, 2006: Extracellular enzyme activities in benthic cyanobacterial mats: comparison between nutrient-enriched and control sites in marshes of northern Belize. *Aquatic Microbial Ecology*, 44 (1): 11–20.
- 1725 Šporka, F.*, Livingstone, D.M.*, Stuchlík, E.*, Turek, J.*, Galas, J.*, 2006: Water temperatures and ice cover in lakes of the Tatra Mountains. *Biologia*, 61, (Suppl. 18): S77–S90.
- 1726 Štrojsová, A., Vrba, J., 2006: Phytoplankton extracellular phosphatases: investigation using the ELF (Enzyme Labelled Fluorescence) technique. *Polish Journal of Ecology*, 54 (4): 715–723.
- 1727 Stuchlík, E.*, Kopáček, J., Fott, J.*, Hořická, Z.*, 2006: Chemical composition of the Tatra Mountain lakes: Response to acidification. *Biologia*, 61 (Suppl. 18): S11–S20.
- 1728 Svoboda, M.*, Kopáček, J., Matějka, K.*, Podrázský, V.*, Sládková, L.*, 2006: Carbon pools in mountain Norway spruce ecosystem in the Bohemian Forest (Czech Republic). *Forestry Journal*, 52 (1–2): 79–87.
- 1729 Svoboda, M.*, Matějka, K.*, Kopáček, J., 2006: Biomass and element pools of selected spruce trees in the catchments of Plešné and Čertovo Lakes in the Šumava Mts. *Journal of Forest Science*, 52 (10): 482–495.
- 1730 Svoboda, M.*, Matějka, K.*, Kopáček, J., 2006: Biomass and element pools of understory vegetation in the catchments of Čertovo Lake and Plešné Lake in the Bohemian Forest. *Biologia*, 61 (Suppl. 20): S509–S521.
- 1731 Svoboda, M.*, Matějka, K.*, Kopáček, J., Žaloudík, J., 2006: Estimation of tree biomass of Norway spruce forest in the Plešné Lake catchment, the Bohemian Forest. *Biologia*, 61 (Suppl. 20): S523–S532.
- 1732 Vašek, M., Kubečka, J., Matěna, J., Sed'a, J., 2006: Distribution and diet of 0+ fish within a canyon-shaped European reservoir in late summer. *International Review of Hydrobiology*, 91 (2): 178–194.
- 1733 Vrba, J., Kopáček, J., Bittl, T., Nedoma, J., Štrojsová, A., Nedbalová, L., Kohout, L.*, Fott, J.*, 2006: A key role of aluminium in phosphorus availability, food web structure, and plankton dynamics in strongly acidified lakes. *Biologia*, 61 (Suppl. 20): S441–S451.
- 1734 Wright, R.F.*, Aherne, J.*, Bishop, K.*, Camarero, L.*, Cosby, B.J.*, Erlandsson, M.*, Evans, C.D.*, Forsius, M.*, Hardekopf, D.W.*, Helliwell, R.*, Hruška, J.*, Jenkins, A.*, Kopáček, J., Moldan, F.*, Posch, M.*, Rogora, M.*, 2006: Modelling the effect of climate change on recovery of acidified freshwaters: Relative sensitivity of individual processes in the MAGIC model. *Science of the Total Environment*, 365 (1–3): 154–166.
- 1735 Znachor, P., Jurczak, T.*, Komárková, J., Jezberová, J., Mankiewicz, J.*, Kaštovská, K., Zapomělová, E.*, 2006: Summer changes in cyanobacterial bloom composition and microcystin concentration in eutrophic Czech reservoirs. *Environmental Toxicology*, 21 (3): 236–243.

B: International Proceedings or Monographs

- 1736 Rakowitz, G.*, Kubečka, J., 2006: Sound propagation in a horizontal bottom aligned beam. In: Jesus, S.M., Rodríguez, O.C. (eds.), Proceedings of the Eighth European Conference on Underwater Acoustics. Carvoeiro, University of Algarve, June 12–15, 2006, ISBN 989–95068–0–X: Vol. 1, pp. 249–254.
- 1737 Straškrábová, V., Cogalniceanu, D.*, Nedoma, J., Parpala, L.*, Postolache, C.*, Tudorancea, C.*, Vadineanu, A.*, Valcu, C.-M.*, Zinevici, V.*, 2006: Bacteria and pelagic food webs in Pristine alpine lakes (Retezat Mountains, Romania). In: Banaduc, D., Sirbu I., Curtean-Banaduc, A. (eds.), Transylvanian Review of Systematical and Ecological Research, Vol. 3, "The Retezat National Park": pp. 1–10.

C: Papers and Books in Czech

- 1738 Borovec, J., Hejzlar, J., 2006: Hodnocení významu sedimentů v nádržích z hlediska vnitřního zatížení fosforem [Evaluation of sediment importance for phosphorus internal load]. In: Maršálek, B., Feldmannová, M., Maršálková, E. (eds.), Sborník konference Cyanobakterie 2006: biologie, toxikologie a management. Brno, May 24–25, 2006, Botanický ústav AV ČR, Průhonice, ISBN 80–86188–22–1: pp. 132–138.
- 1739 Borovec, J., Hendl, O., 2006: Spotřeba kyslíku sedimenty v nádrži Jordán [Sediment oxygen demand in Jordan reservoir]. In: Kalousková, N., Dolejš, P. (eds.), Sborník konference Pitná voda 2006, 8. pokračování konferencí Pitná voda z údolních nádrží. Tábor, June 5–8, 2006, W&ET Team, Č. Budějovice, ISBN 80–239–7113–1: pp. 387–392.
- 1740 Drašík, V., Kubečka, J., Jůza, T., Jarolím, O., Hladík, M., Kratochvíl, M., Prchalová, M., Říha, M., Tušer, M., 2006: Diverzita a prostorová distribuce tohotočného plůdku v nádržích vltavské kaskády [Fish diversity and spatial distribution of YOY fish in Vltava cascade reservoirs]. In: Lusk, S., Lusková, V. (eds.), Biodiverzita ichtyofauny České republiky (VI). Brno, November 8, 2005, Ústav biologie obratlovců AV ČR, ISBN 80–903329–6–X: pp. 29–34.
- 1741 Duras, J.*, Hejzlar, J., Chocholoušková, Z.*, Kučera, T.Č.*, 2006: Vodní nádrže – nové příležitosti pro uplatnění vodních makrofyt (a botaniků) [Water reservoirs – new opportunities for aquatic macrophytes (and botanists)]. Zprávy Čes. Bot. Společ., Praha, 41, Mater. 21: 167–171.
- 1742 Hejzlar, J., 2006: Ekologický potenciál nádrží a kvalita vody [Ecological potential of reservoirs and water quality]. In: Kalousková, N., Dolejš, P. (eds.), Sborník konference Pitná voda 2006, 8. pokračování konferencí Pitná voda z údolních nádrží. Tábor, June 5–8, 2006, W&ET Team, Č. Budějovice, ISBN 80–239–7113–1: pp. 339–344.
- 1743 Hejzlar, J., 2006: Rámcová směrnice vodní politiky EU a kvalita vody v nádržích [EU Water Framework Directive and water quality in reservoirs]. Vodní hospodářství 56 (6): 190–193.
- 1744 Jan, J., Borovec, J., 2006: Nové metody popisu sedimentů, aneb jak na jejich „metabolismus“ [New methods for sediment description – how to their “metabolism”]. In: Kalousková, N., Dolejš, P. (eds.), Sborník konference Pitná voda 2006, 8. pokračování konferencí Pitná voda z údolních nádrží. Tábor, June 5–8, 2006, W&ET Team, Č. Budějovice, ISBN 80–239–7113–1: pp. 393–398.

- 1745 Jůza, T., Kubečka, J., Čech, M., Draštík, V., Jarolím, O., Peterka, J., Vašek, M., 2006: Snímkování pelagických plůdkových společenstev ryb nádrží pomocí tralů [Sampling of the offshore fry fish communities of reservoirs by trawls]. In: Lusk, S., Lusková, V. (eds.), Biodiverzita ichtyofauny České republiky (VI). Brno, November 8, 2005, Ústav biologie obratlovců AV ČR, ISBN 80-903329-6-X: pp. 71-78.
- 1746 Kubečka, J., Čech, M., Říha, M., Jůza, T., Frouzová, J., Draštík, V., Hladík, M., Kratochvíl, M., Prchalová, M., Tušer, M., Vašek M., 2006: Rybí obsádka nádrže Orlík po prvních letech provozu jaderné elektrárny Temelín [Fish stock of the Orlík Reservoir after first years of operation of Temelín Nuclear power plant]. In: Hanslík, E., Miller, B.(eds.), Sborník XIX. konference Radionuklidy a ionizující záření ve vodním hospodářství. Č. Budějovice, May 10-11, 2006, Česká vědeckotechnická vodohospodářská společnost, Praha, ISBN 80-02-01841-9: pp. 85-96.
- 1747 Lexa, M.*, Kvítek, T.*, Hejzlar, J., Fučík, P.*, 2006: Vliv drenážních systémů na koncentrace dusičnanů v povrchových vodách v povodí VN Švihov [Relations among tile drainage systems, waterlogged soils covered by grassland, and nitrate concentrations in brooks of the Švihov (Želivka) drinking water reservoir basin]. Vodní hospodářství 56 (8): 246-250.
- 1748 Matěnová, V.*, Matěna, J., 2006: Obojživelníci [Amphibians]. In: Dudák, V. (ed.) Novohradské hory a Novohradské podhůří - příroda, historie, život. Praha, Baset, ISBN 80-7340-091-X: pp. 221-224.
- 1749 Matěnová, V.*, Matěna, J., 2006: Plazi [Reptiles]. In: Dudák, V. (ed.) Novohradské hory a Novohradské podhůří - příroda, historie, život. Praha, Baset, ISBN 80-7340-091-X: pp. 225-226.
- 1750 Matěnová, V.*, Matěna, J., 2006: Ryby [Fish]. In: Dudák, V. (ed.), Novohradské hory a Novohradské podhůří - příroda, historie, život. Praha, Baset, ISBN 80-7340-091-X: pp. 215-220.
- 1751 Papáček, M.*, Boukal, S.D.*, Matěna, J., Petr, J.*, Soldán, T.*, 2006: Vodní hmyz [Aquatic Insects]. In: Dudák, V. (ed.) Novohradské hory a Novohradské podhůří - příroda, historie, život. Praha, Baset, ISBN 80-7340-091-X: pp. 203-210.
- 1752 Prchalová, M., Kubečka, J., 2006: Změny druhového složení na hloubkovém gradientu kaňonovitých nádrží [Species composition along the vertical gradient in canyon-shaped reservoirs]. In: Lusk, S., Lusková, V. (eds.), Biodiverzita ichtyofauny České republiky (VI). Brno, November 8, 2005, Ústav biologie obratlovců AV ČR, ISBN 80-903329-6-X: pp. 117-124.
- 1753 Prchalová, M., Kubečka, J., Jůza, T., Říha, M., Jarolím O., Tušer, M., Peterka, J., Vašek, M., 2006: Komplexní průzkum rybí obsádky nádrže Želivka, největší vodárenské nádrže v ČR, v letech 2004 a 2005 [Complex assessment of the fish assemblage of the Želivka reservoir, the biggest water supply reservoir in the ČR, in years 2004 and 2005]. In: Vykusová, B. (ed.), IX. česká ichtyologická konference, sborník příspěvků z odborné konference s mezinárodní účastí, Vodňany, May 4-5, 2006. Jihočeská univerzita v Č. Budějovicích, Výzkumný ústav rybářský a hydrobiologický ve Vodňanech, ISBN 80-85887-57-6: pp. 114-118.
- 1754 Soldán, T.*, Černý, R.*, Husák, Š.*, Matěna, J., Matěnová, V.*, Papáček, M.*, Petr, J.*, 2006: Vodní prostředí [Aquatic Environment]. In: Dudák, V. (ed.) Novohradské hory a Novohradské podhůří - příroda, historie, život. Praha, Baset, ISBN 80-7340-091-X: pp. 131-138.

- 1755 Turek, J., Hejzlar, J., Jarošík, J., 2006: Modelování kvality vody v povodí vodárenské nádrže Římov pomocí HSPF: propojení s modelem nádrže CE-QUAL-W2 [HSPF water quality modelling in the catchment of Římov drinking water reservoir: a coupling with the reservoir model CE-QUAL-W2]. In: Kalousková, N., Dolejš, P. (eds.), Sborník konference Pitná voda 2006, 8. pokračování konferencí Pitná voda z údolních nádrží. Tábor, June 5–8, 2006, W&ET Team, Č. Budějovice, ISBN 80–239–7113–1: pp. 345–350.
- 1756 Zapomělová, E., 2006: Ekologie planktonních sinic rodu *Anabaena* – literární přehled [Ecology of planktonic cyanobacteria of the genus *Anabaena* – literary review]. In: Maršálek, B., Feldmannová, M., Maršálková, E. (eds.), Sborník konference Cyanobakterie 2006: biologie, toxikologie a management. Brno, May 24–25, 2006, Botanický ústav AV ČR, Průhonice, ISBN 80–86188–22–1: pp. 13–21.

D: Others

In: Book of Abstracts, 5th International Conference on Reservoir Limnology and Water Quality, Brno, August 27–31, 2006. Biology Centre of the Academy of Sciences of the Czech Republic, Institute of Hydrobiology, České Budějovice; Centre for Cyanobacteria and Their Toxins, Masaryk University Brno. ISBN 80–86188–23–X:

- 1757 Borovec, J., Hejzlar, J., Jan, J.: Phosphorus retention in a stratified reservoir – role of morphology and sediments, pp. 132–135.
- 1758 Devetter, M.*, Sed'a, J.: Competitive relations between rotifers and cladocerans during the spring development in eutrophic reservoir, pp. 78–81.
- 1759 Draštík, V., Kubečka, J., Tušer, M., Jůza, T., Jarolím, O.: Fish distribution in cascade reservoirs: differences and similarities with noncascade reservoirs, p. 97.
- 1760 Hejzlar, J.: Management options to control ecological potential of reservoirs, p. 23.
- 1761 Hohausová, E., Hejzlar, J., Kubečka, J., Frouzová, J., Tušer, M., Peterka, J., Říha, M., Mudruňková, J.: Limnological importance of macrophytes in a newly developing reservoir: A case of Chabařovice reservoir, pp. 199–201.
- 1762 Horňák, K., Jezbera, J., Nedoma, J., Šimek, K.: Decreased activity of free-living reservoir bacterioplankton during summer cyanobacterial bloom, pp. 44–47.
- 1763 Jan, J., Borovec, J.: Sediment changes after Fe and Al treatment – a laboratory study, pp. 243–246.
- 1764 Jezbera, J., Šimek, K., Tundisi, J.G.*: Basic microbiological characteristics of the Broa reservoir (Sao Paulo State, Brazil) – abundance of microbes, bacterial growth and protistan grazing on bacterial production, pp. 57–59.
- 1765 Jezberová, J.: Does the protozoan presence influence colony forming of picocyanobacteria?, 4 pp.
- 1766 Jůza, T., Kubečka, J., Čech, Vašek, M., Peterka, J., Draštík, V., Jarolím, O., Prchalová, M., Kratochvíl, M., Frouzová, J.: Open water fish fry community in late summer, pp. 98–100.
- 1767 Kaštovská, K., Znachor, P., Rychtecký, P.*, Zapomělová, E.: Comparison of suitability of two experimental mesocosms for phytoplankton *in situ* experiments, pp. 180–183.

- 1768 Kratochvíl, M., Matěna, J., Čech, M., Kubečka, J., Sed'a, J.: Vertical distribution and feeding patterns of perciform fry in a shallow, well-mixed reservoir: a 24-hour study, p. 88.
- 1769 Kubečka, J., Frouzová, J., Hladík, M., Čech, M., Hohausová, E., Ketelaars, H.A.M.* , Peterka, J., Vašek, M., Prchalová, M., Draštík, V., Wagenvoort, A.J.*: Fish stock of Biesbosch reservoirs, the Netherlands: valuable fish stock in highly artificial systems, p. 84–87.
- 1770 Macháček, J., Sed'a, J., Kolářová, K., Slámová, I.: The role of vertically stratified environment of a deep dimictic reservoir in the intra-specific diversity of *Daphnia galeata* population, p. 75–77.
- 1771 Musil, J.*, Peterka, J., Policar, T.*, Hamáčková, J.*, Vorlíčková, P.: Potential of piscivory in 0 + perch (*Perca fluviatilis* L.) – a laboratory study of growth response versus the whole - pond experiment, p. 223.
- 1772 Peštová, D.*, Murueta-Figueroa, N.*, Macek, M., Martínez-Pérez, M.E.* , Carmona-Jiménez, J.*: Ciliates and their feeding activity ON APP in a tropical Reservoir Valle de Bravo, pp. 52–54.
- 1773 Peterka, J., Čech, M., Vašek, M., Matěna, J.: Sinusoidal foraging - species specific response to limited foraging opportunities in the epipelagic zone of reservoir, p. 71.
- 1774 Peterka, J., Vašek, M., Matěna, J.: Use of underwater camera for observations of fish occurrence and behaviour in the epipelagic habitat of reservoirs, pp. 224–225.
- 1775 Prchalová, M., Kubečka, J., Jůza, T., Říha, M., Jarolím, O., Tušer, M., Peterka, J., Vašek, M., Čech, M., Frouzová, J., Draštík, V., Hohausová, E., Piálek, L.: Spatial distribution of fish in a canyon-shaped reservoir, p. 101.
- 1776 Říha, M., Kubečka, J., Matěna, J., Hladík, M.: Long-term development of fish populations in Římov reservoir, p. 102.
- 1777 Sed'a, J., Petrusek, A.*, Kolářová, K.*, Macháček, J.: Horizontal and vertical differentiation of *Daphnia galeata* subpopulations in deep and long dam reservoir, pp. 73–74.
- 1778 Šimek, K., Jezbera, J., Hornák, K., Nedoma, J., Hejzlar, J., Straškrábová, V.: Growth rates of major bacterioplankton groups in relation to phosphorus availability in a canyon-shaped reservoir, pp. 40–43.
- 1779 Straškrábová, V., Brandl, Z., Komárková, J., Macek, M., Sed'a, J., Šimek, K., Vrba J.: Climate effeted spring events in pelagic succession of two reservoirs, pp. 55–56.
- 1780 Štrojsová, M.: Population dynamics of rotifers in Římov reservoir, pp. 234–237.
- 1781 Vašek, M., Čech, M., Kubečka, J.: Cyprinid foraging on zooplankton in the open water of a deep European reservoir: seasonal and diel characteristics, p. 70.
- 1782 Znachor, P., Nedoma, J., Hornák, K., Šimek, K., Jezberová, J.: Primary production and glucose uptake of size-fractionated phytoplankton in a eutrophic reservoir, pp. 191–194.

Biology Centre of the Academy of Sciences of the Czech Republic,
INSTITUTE OF HYDROBIOLOGY

47th ANNUAL REPORT
For the Year 2006 - web edition

ISSN 1210 – 9649

44 pages

Edited by Jiří Nedoma
Assistant Editors: N. Johanisová (language revise), V. Lavičková

Published by Biology Centre of the Academy of Sciences of the Czech Republic, v.v.i., Institute of Hydrobiology, České Budějovice (founded 1955 as Hydrobiological Laboratory, Czechoslovak Academy of Sciences, Prague)

Printed in Czech Republic by Typodesign List, České Budějovice

© Biology Centre AS CR, v.v.i, Institute of Hydrobiology, 2007