

# Archaeology and Early Medieval Architecture: Stará Boleslav (Central Bohemia)

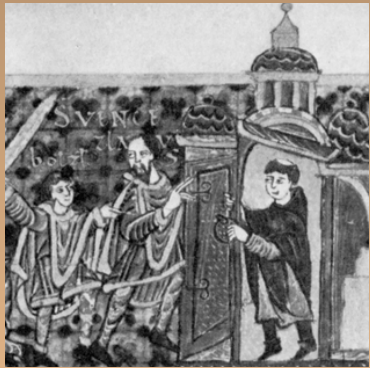

Ivana Boháčová, Institute of Archaeology  
Academie of Sciences of the Czech Republic, Prague, v.v.i.

# 1 Early Medieval ecclesiastic Architecture at Stará Boleslav Stronghold as an Archaeological Research Subject

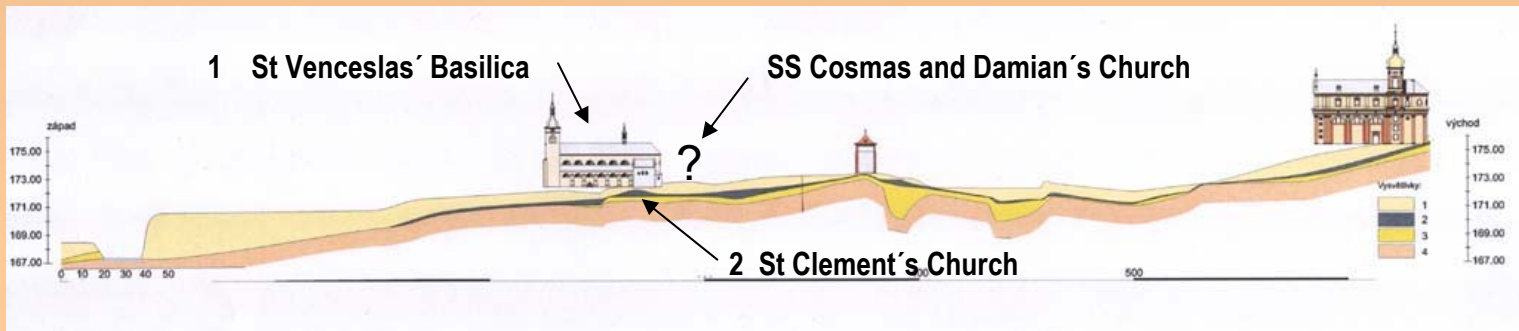
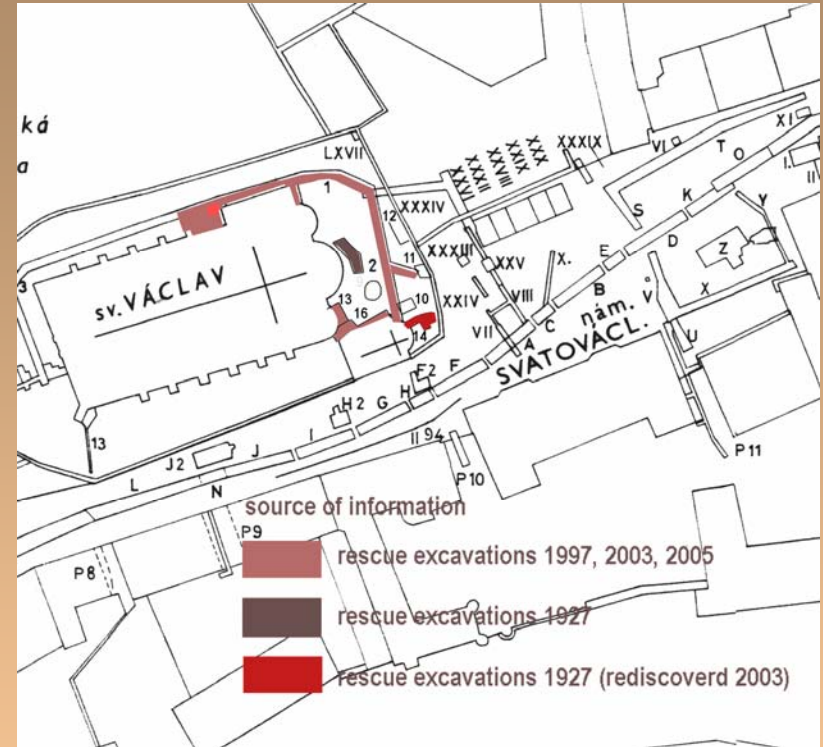



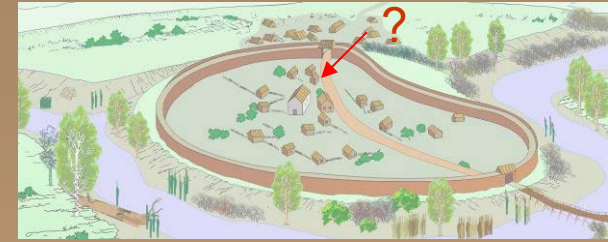

Questions:

- 1 Location and determination of form of the earliest stronghold's Church dedicated to SS Cosmas and Damian (after Kosmas)
- 2 The area of Stará Boleslav canonry founded after the year 1039 by the Duke Břetislav I, its dating, form, development, and functional determination of ecclesiastic buildings in its vicinity
- 3 Presence of other potential Early Medieval ecclesiastic buildings on the core of Přemyslid stronghold, and in its bailey

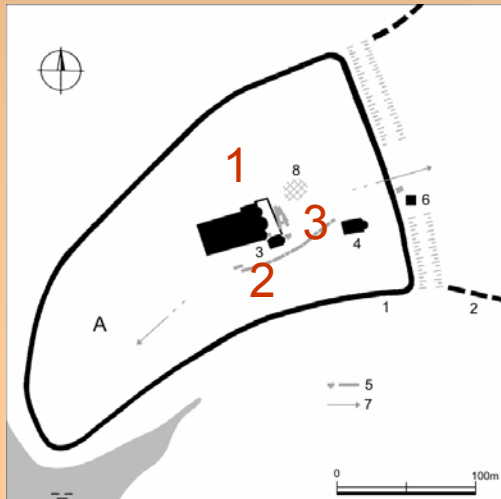

- 1 St Venceslas' Basilica
- 2 St Clement's Church
- 3 Church of uncnoun dedication



# 2 Resources of contemporary archaeological studies

## 2.1 Historical archaeology of the 1st half of the 20th century

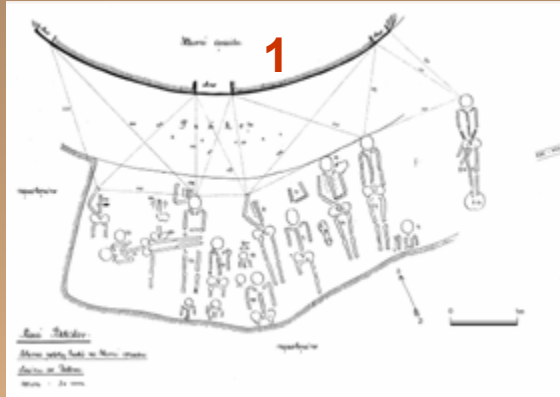
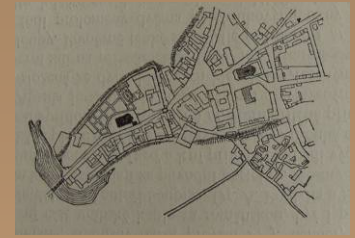

### Böhm, Guth, Buchtela 1927, Guth 1934 (Praha, Budeč, Boleslav)

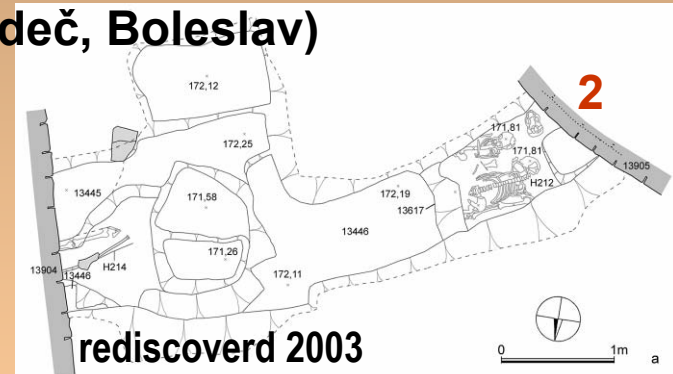
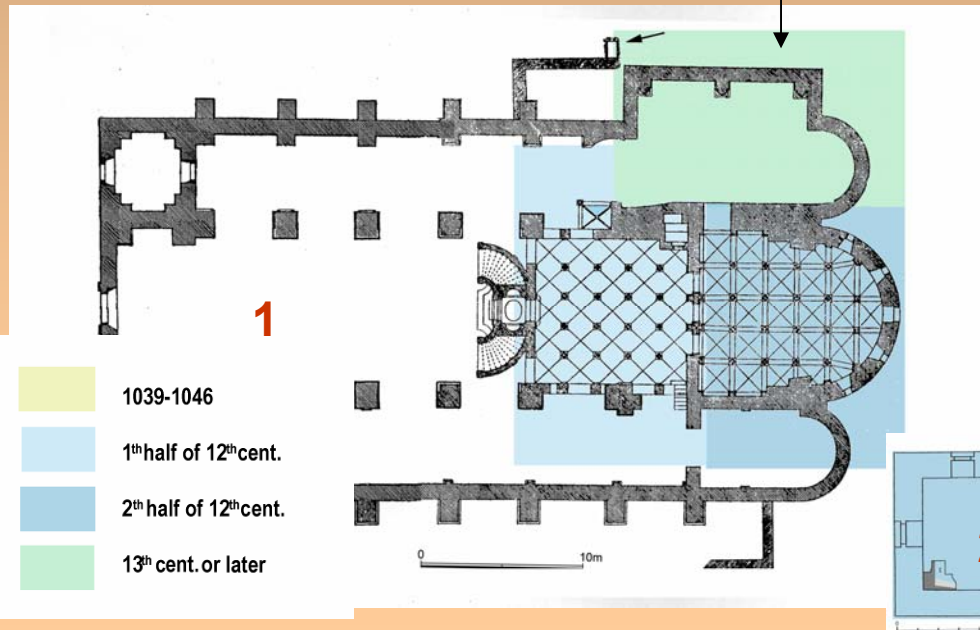



## 2.2 Structural and art-historical survey

K. Guth 1934

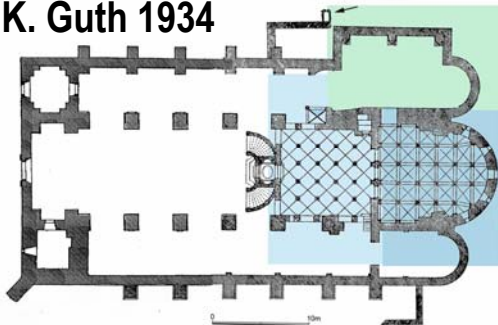

D. Líbal hypothesis I

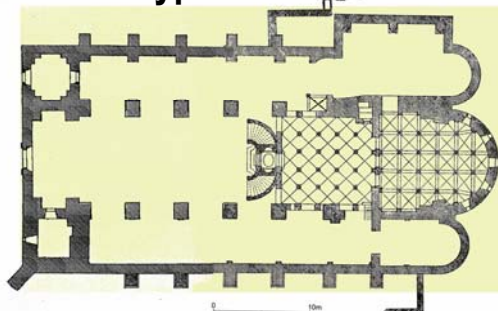

hypothesis II

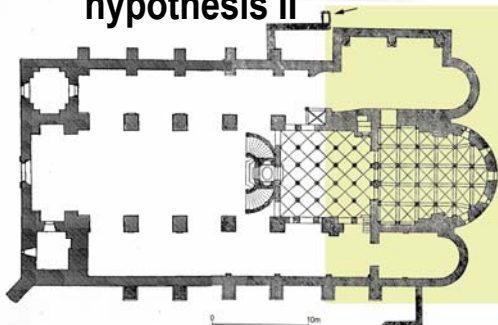

A. Merhautová 1971

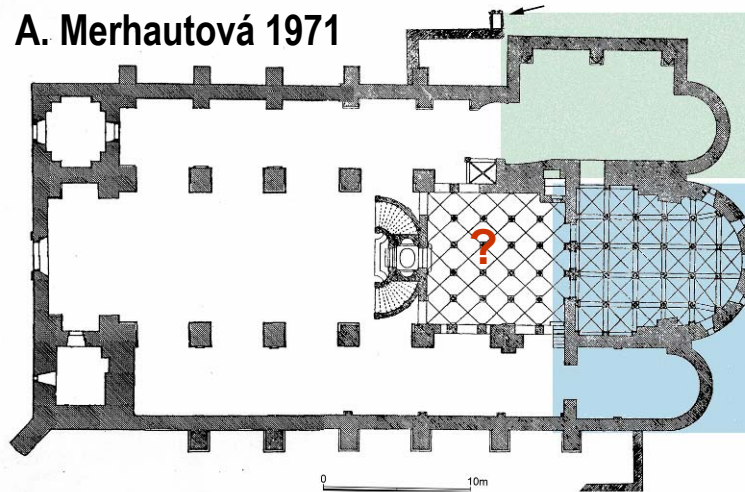

my be in the place  
of a older church?

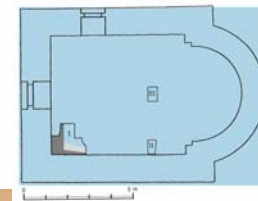

St Venceslas´Basilica - state 1923

- 1039-1046
- 1<sup>st</sup> half of 12<sup>th</sup> cent.
- 2<sup>nd</sup> half of 12<sup>th</sup> cent.
- 13<sup>th</sup> cent. or later

## 2.3 Approach of positivist archeology in the 2<sup>nd</sup> half of the 20<sup>th</sup> century

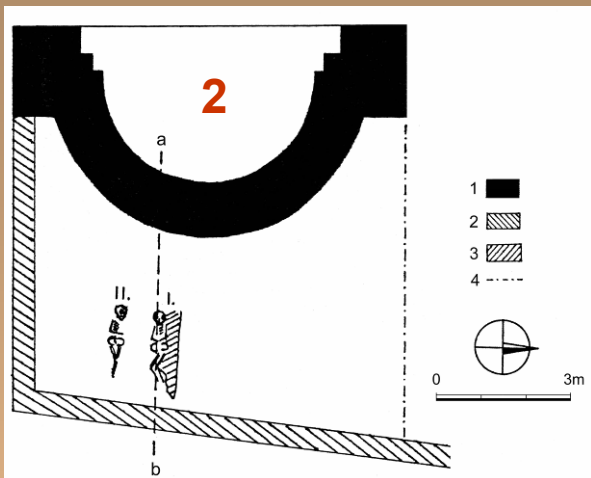

P. Sommer 1977: summary of archaeological data and reconstruction of the stratigraphy from the excavations 1927 (chronology after Böhlm 1927)

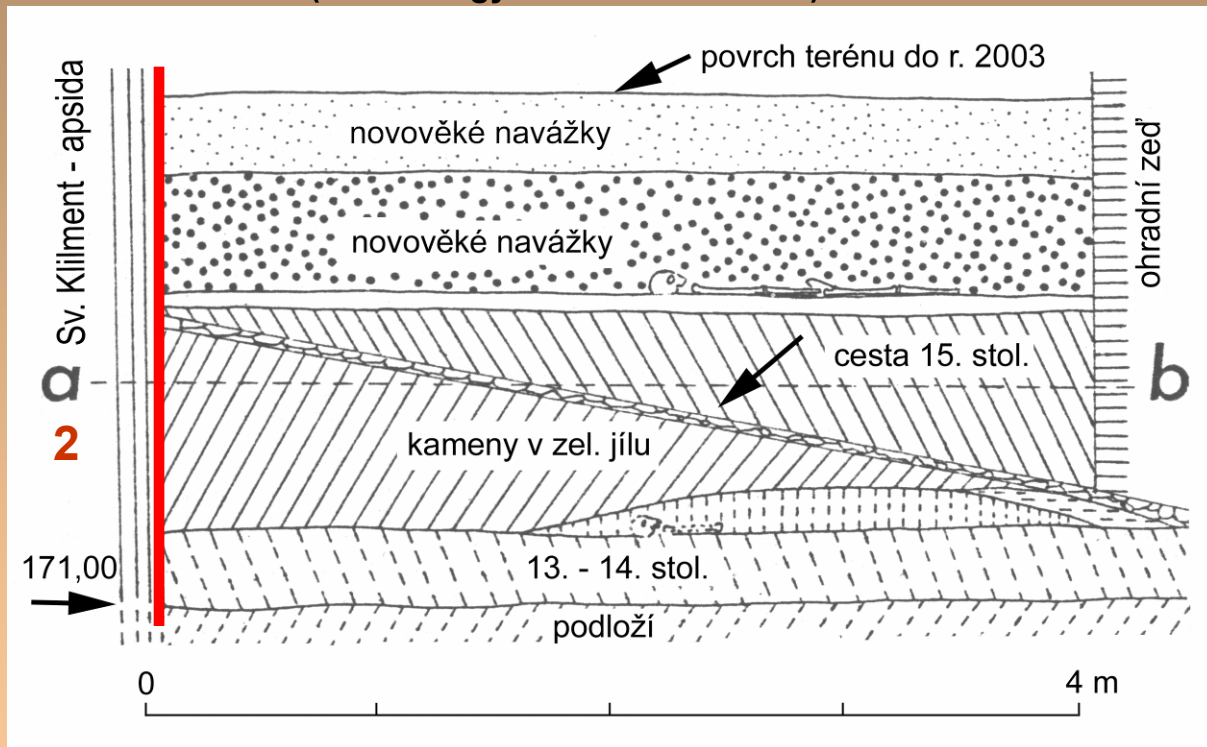

summary of historical events, view of data: J. Sláma 1988



# 3 Rescue excavations of a historical site - 1988-2005

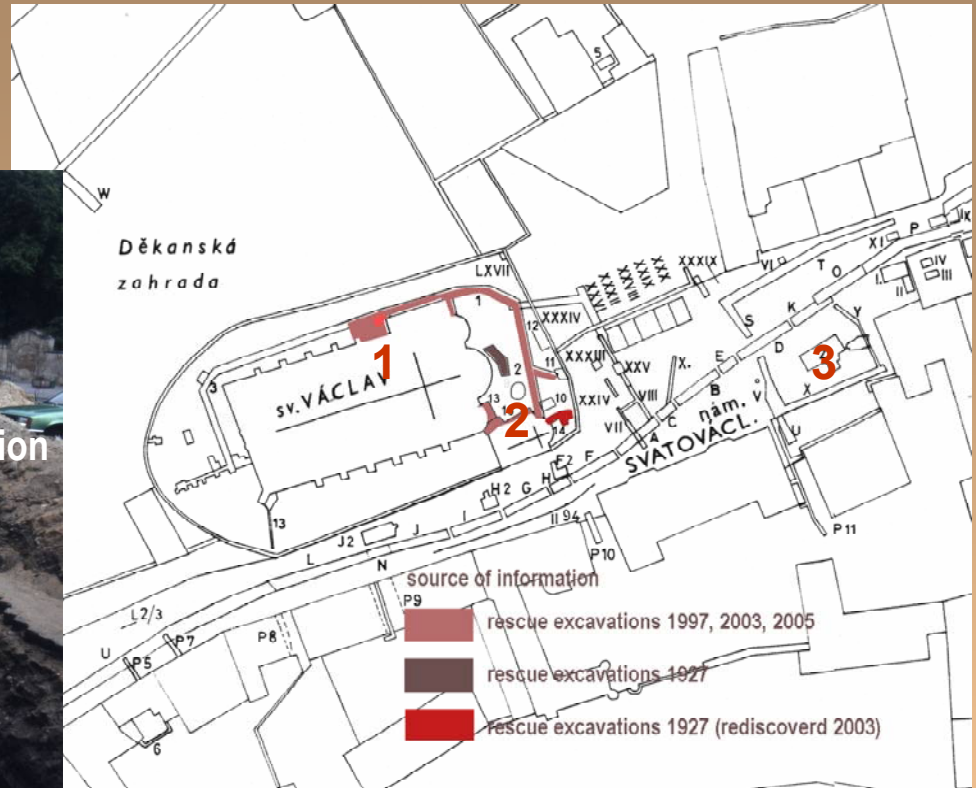
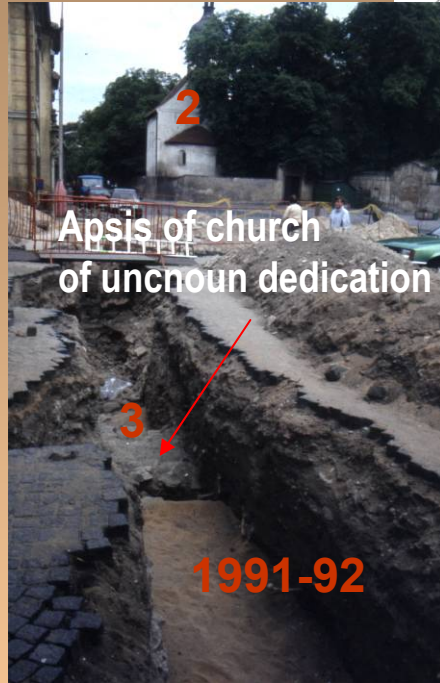

# 3. 2 Early Medieval architecture and its archaeological context

## Results and conclusions

### SS Cosmas and Damian's Church

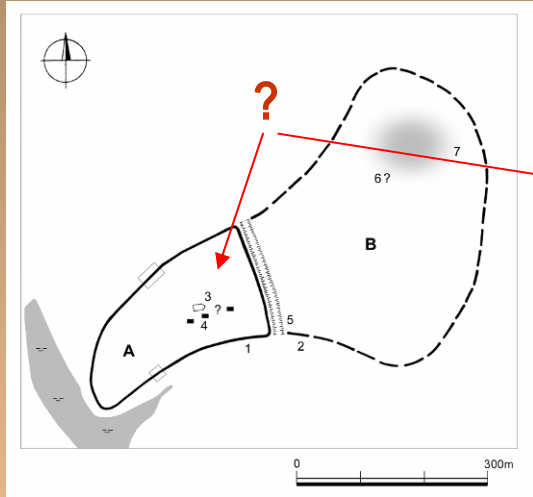

hypothesis of the Church location

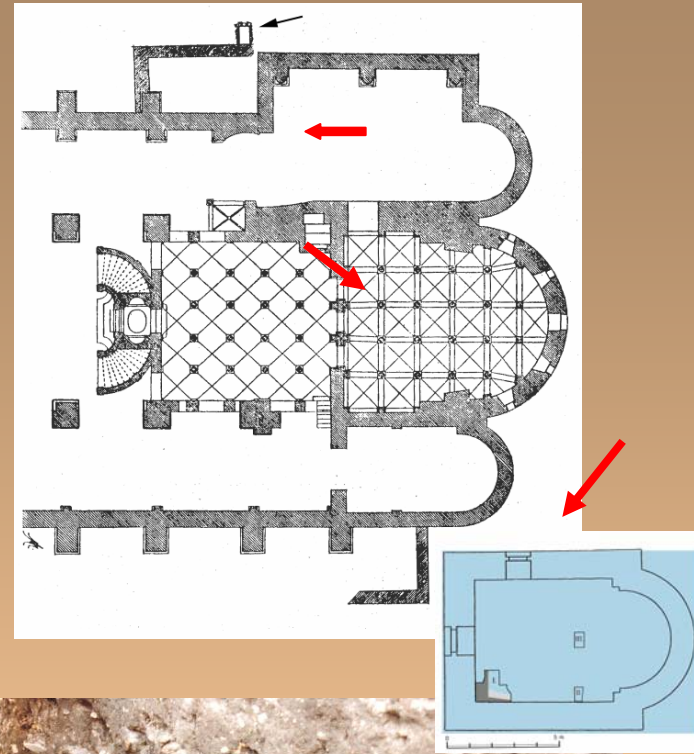

### St Clement's Church

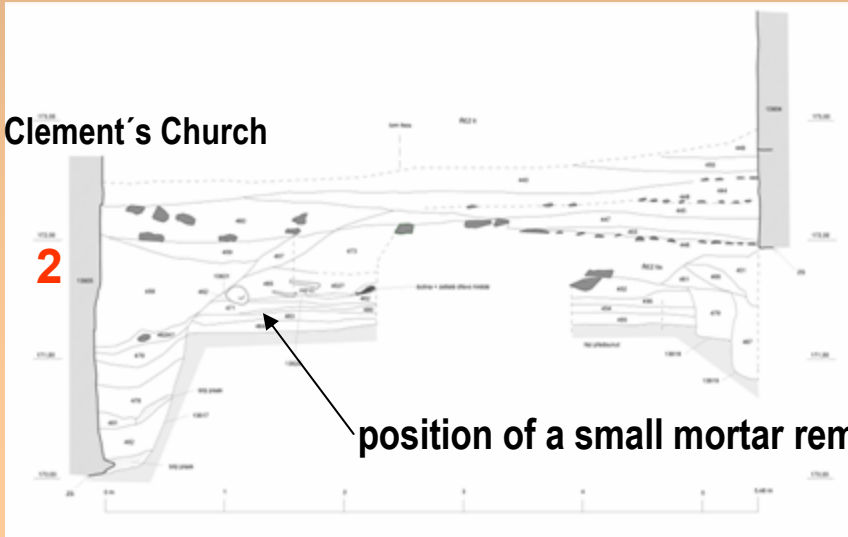



# St Venceslas' Basilica, 1039-1046

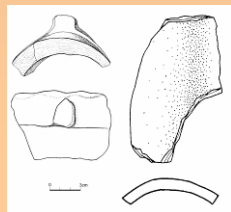

floor tiles type A

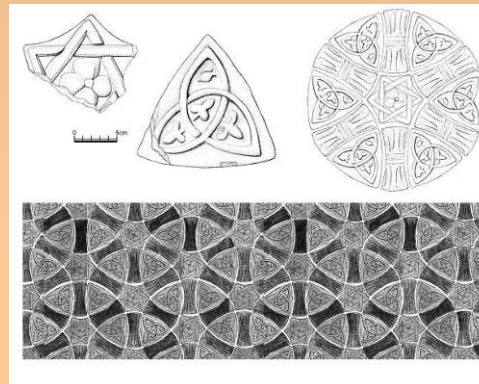
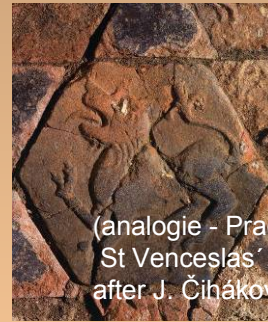
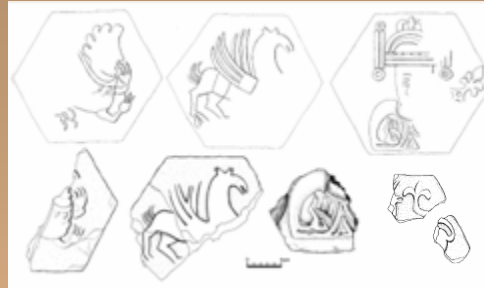

floor tiles type B

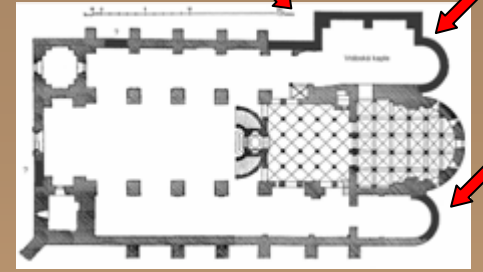

1039-1046



## ... and changes of the settlement area the Early Middle Ages

- the chapter area was divided by stone walls into several areal units
- surface of those units was on some spots hardened by marl gravel, stone chips, pebbles, and by large sandstone blocks

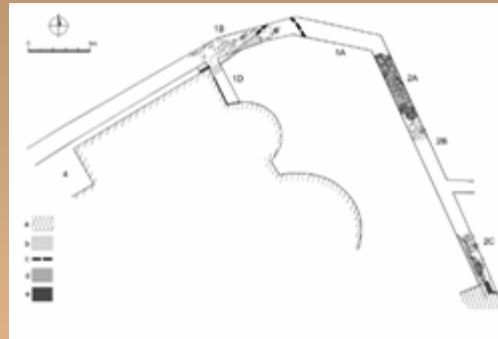
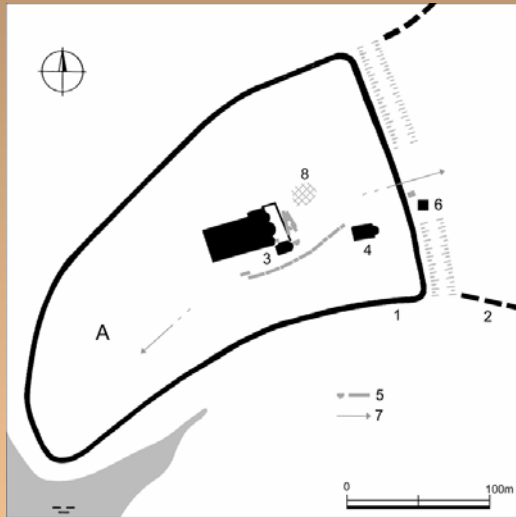



# New sacral buildings after chapter foundation (after 1039-1046)

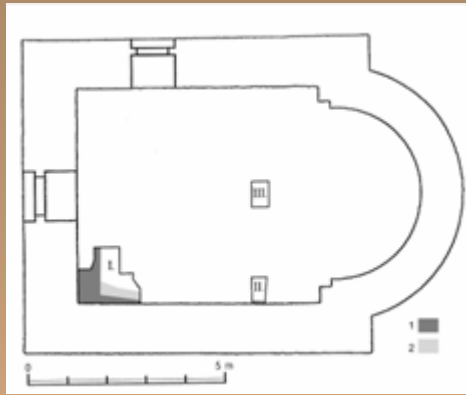

## 3 Church of unknown dedication

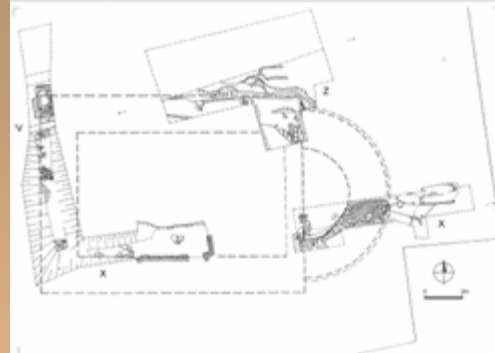

## 2 St Clement's Church







**St Clement's Church:**

**the masonry with reused sandstones**

**the 10<sup>th</sup> century sandstones wall**

**"opere Romano"**





## Summary of knowledge:

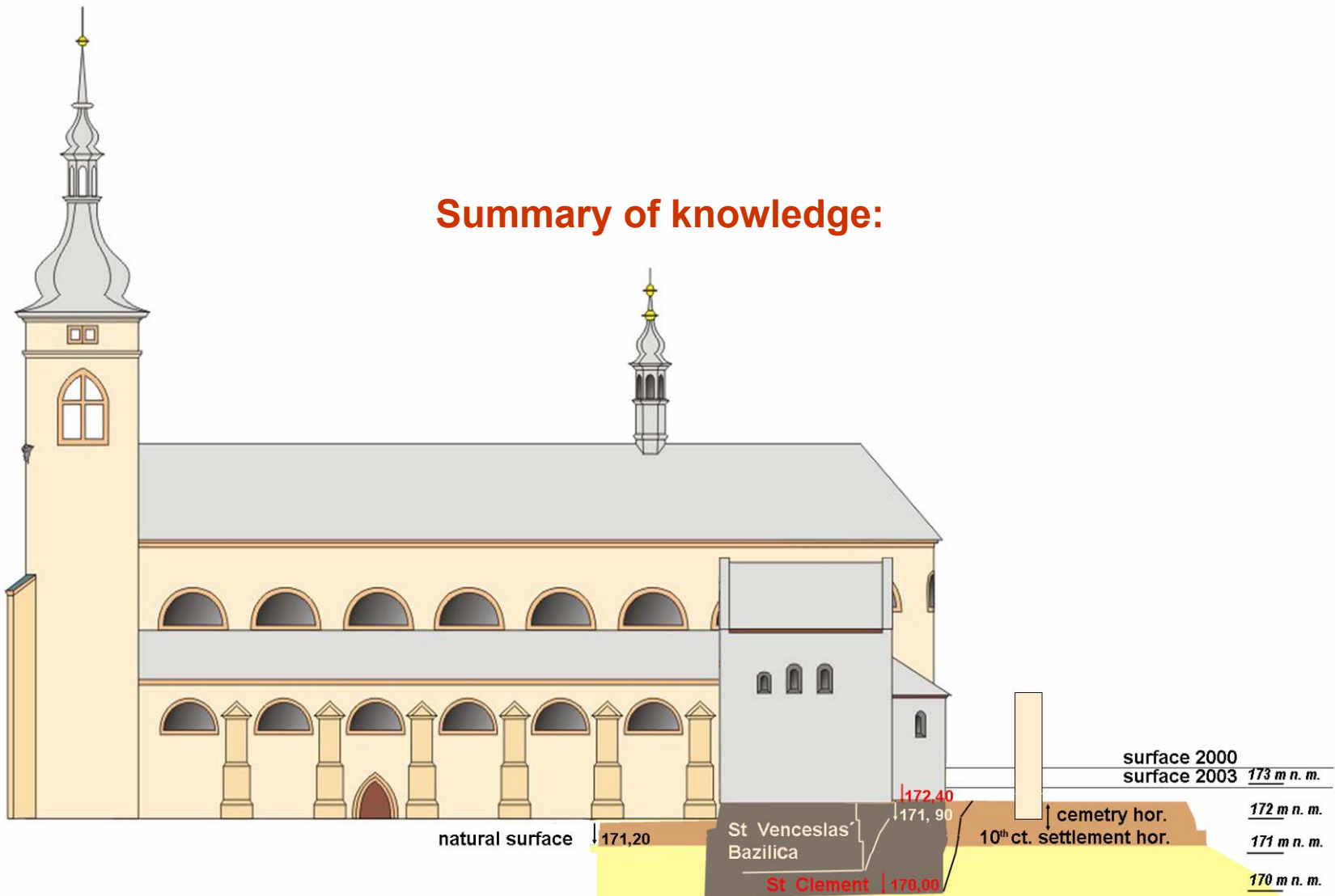

groudnpnan of the Bazilika - 1039-104  
St Clement's Church - first half of 12<sup>th</sup> century?

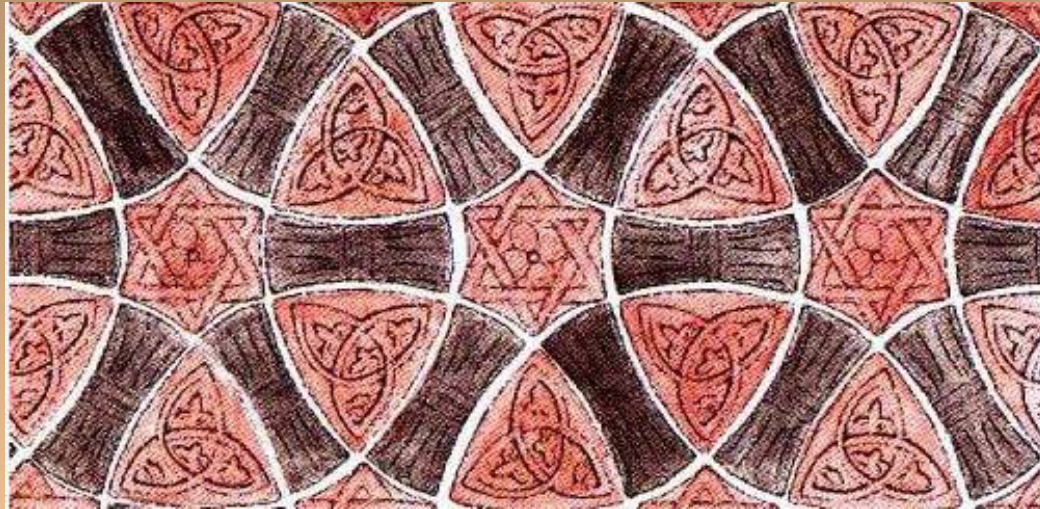

**Thank you for your attention**