



Ústav fyzikální chemie J. Heyrovského, v.v.i.
Akademie věd České republiky



J. Heyrovský 1959

Uhlíkové nanostruktury z pohledu spektroelektrochemie

Ladislav Kavan



Chirality: (n, m)

chiral vector $C_h = na_1 + ma_2$

a_1, a_2 ... unit vectors of the hexagonal structure

→ nanotube definition (n, m)

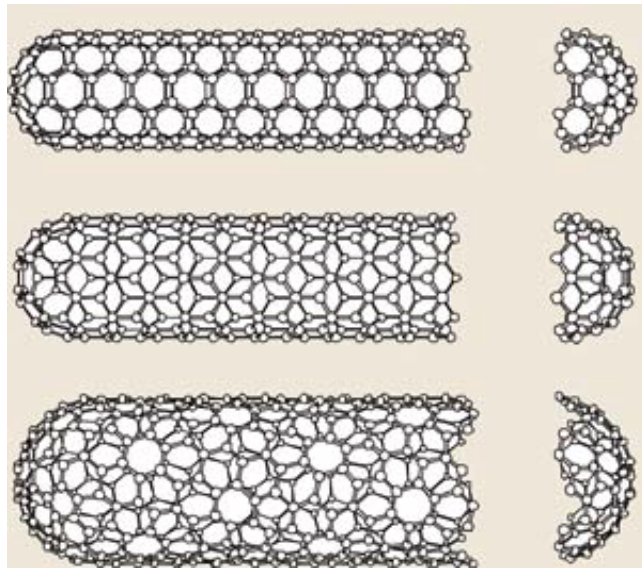

Armchair nT
 $(n=m)$ metal

Zig-zag nT
 $(n-m) = 3i$ metal
 $(n-m) \neq 3i$ semi.

Chiral nT
 $(n-m) = 3i$ metal
 $(n-m) \neq 3i$ semi.

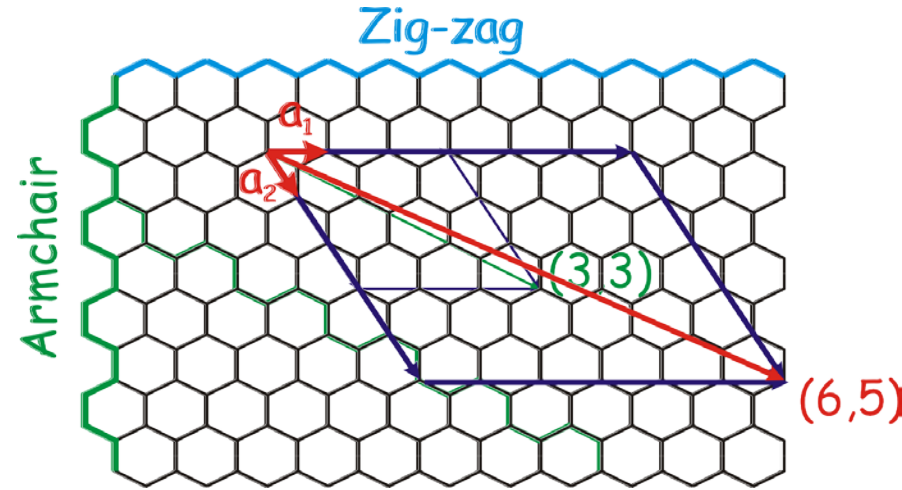

nanotube diameter d_0

$$d_0 = \frac{a_{c-c} \sqrt{3}}{\pi} \sqrt{N}$$

$$a_{c-c} = 1.42 \text{ \AA}$$

$$N = n^2 + nm + m^2$$

Density of states (DOS) in SWCNT

→ Van Hove singularities

$$DOS(E) = \left(\frac{L}{2\pi} \right)^d \int \frac{dk^d \delta(k(E) - k)}{|\nabla_k(E)|}; \nabla_k \rightarrow 0$$

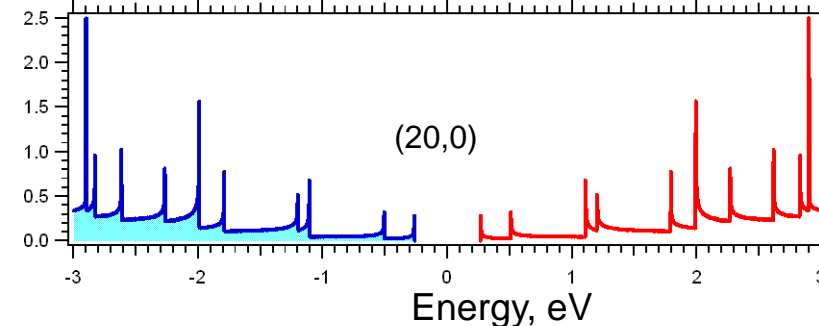
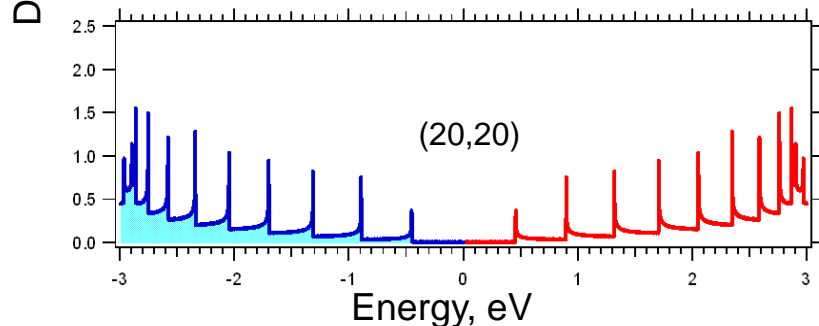
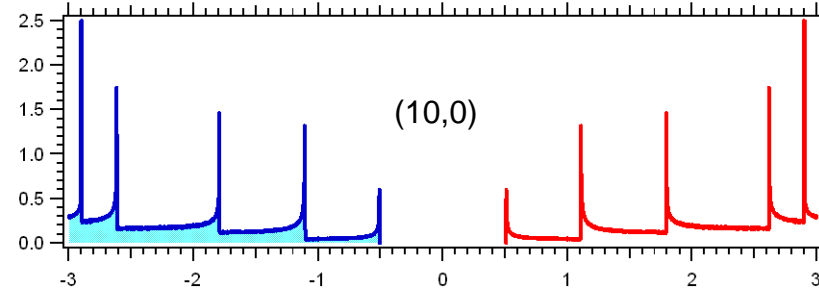
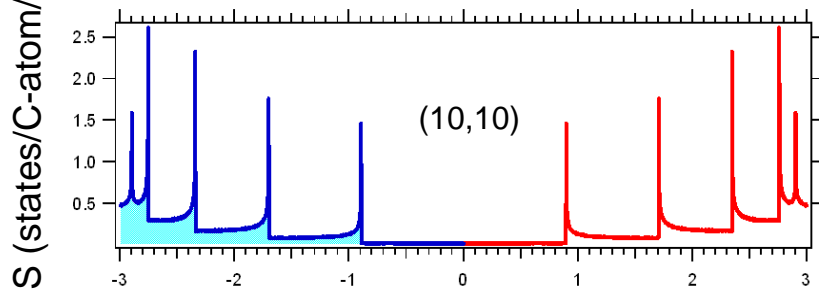
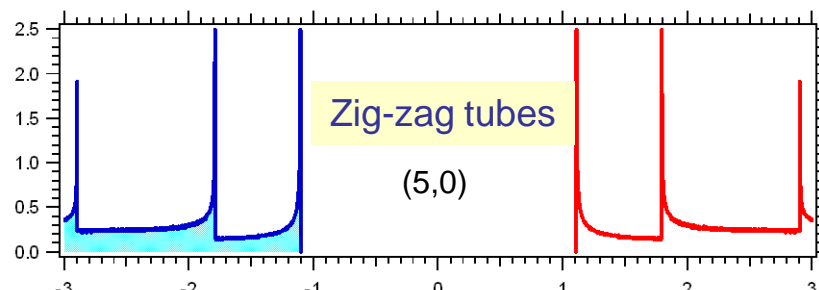
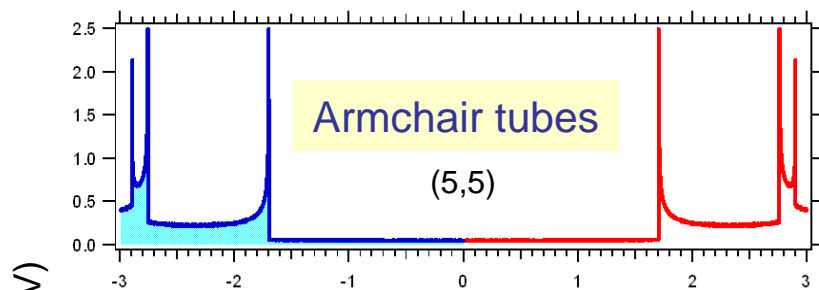

DOS (states/C-atom/eV)

Energy, eV

Energy, eV

ΔE of singularities vs. diameter of SWCNT (“Kataura graph”)

$$\Delta E_{ii} = \frac{2i\chi_0 a_{C-C}}{d} + \delta E$$

$\chi_0 \cong 2.4 - 2.9$ eV (overlap integral)

$a_{C-C} \cong 0.142$ nm

SWCNT $d \approx 1.1-1.4$ nm

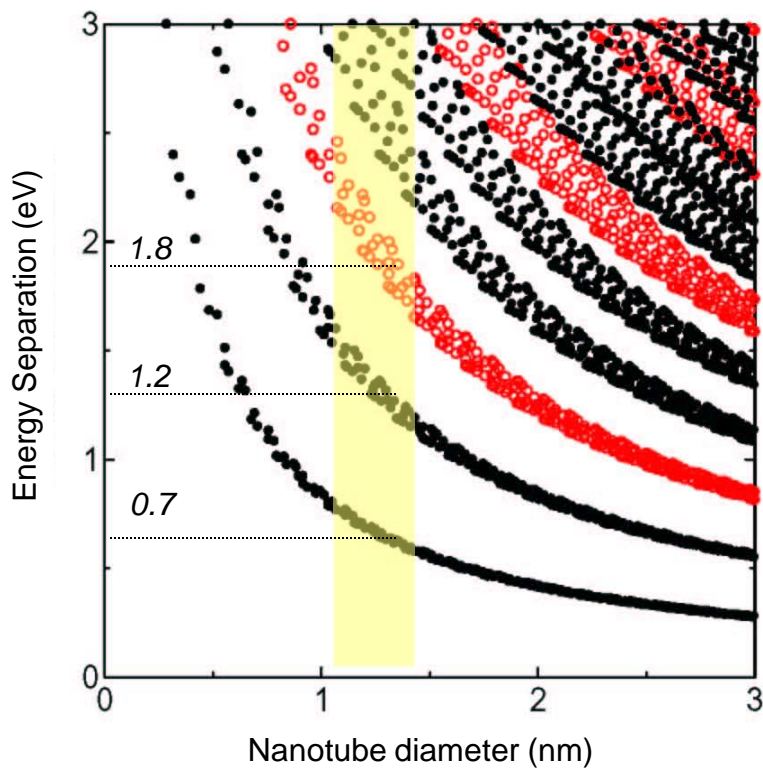

(10,10)

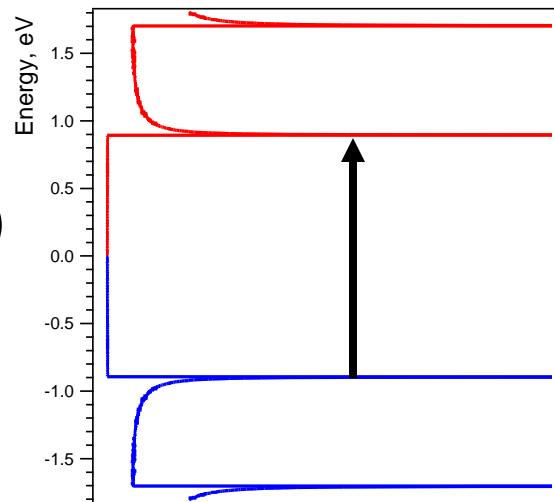

DOS

(11,9)

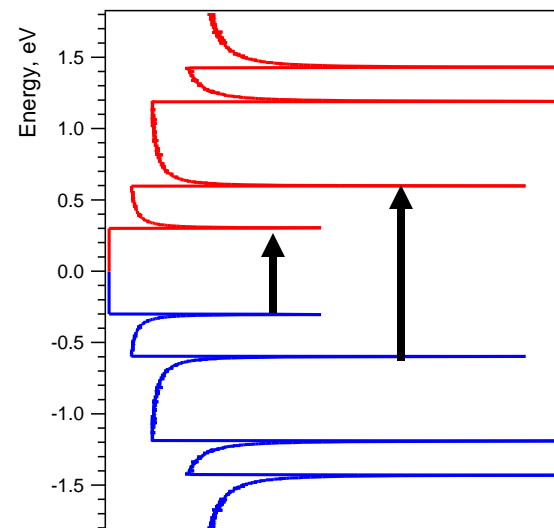

DOS

(n, m) to (40,40)

Vis-NIR spectra on ITO electrode - SWCNT ($0.2\text{ M LiClO}_4 + \text{acetonitrile}$)

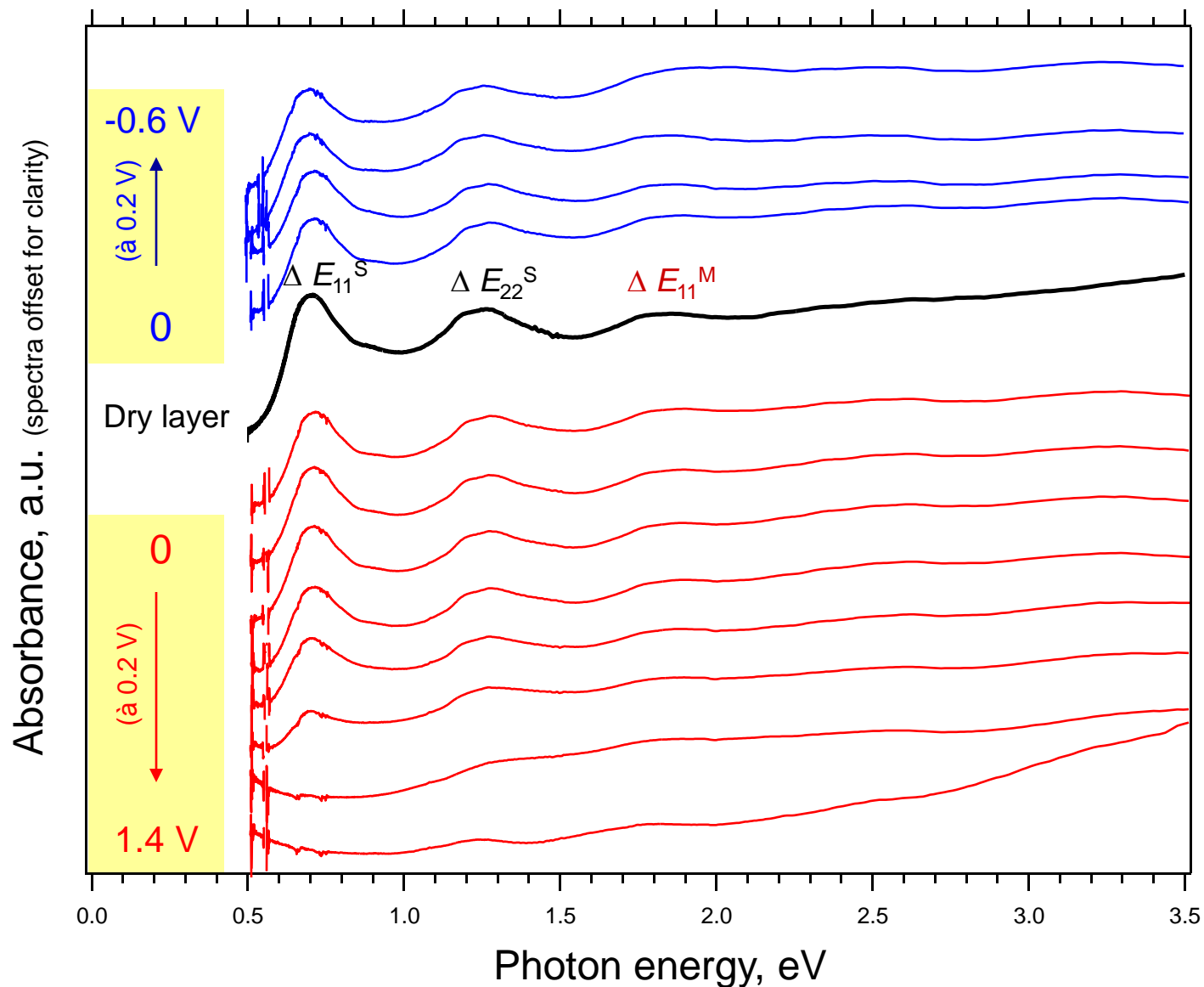
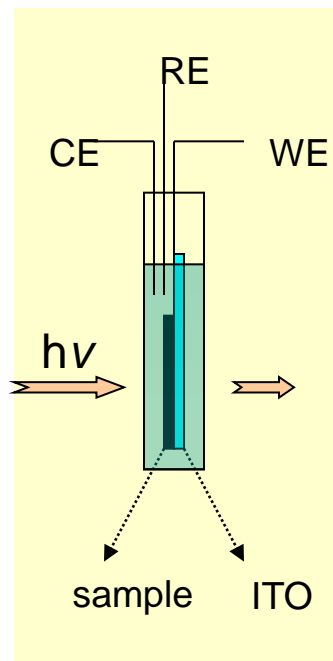

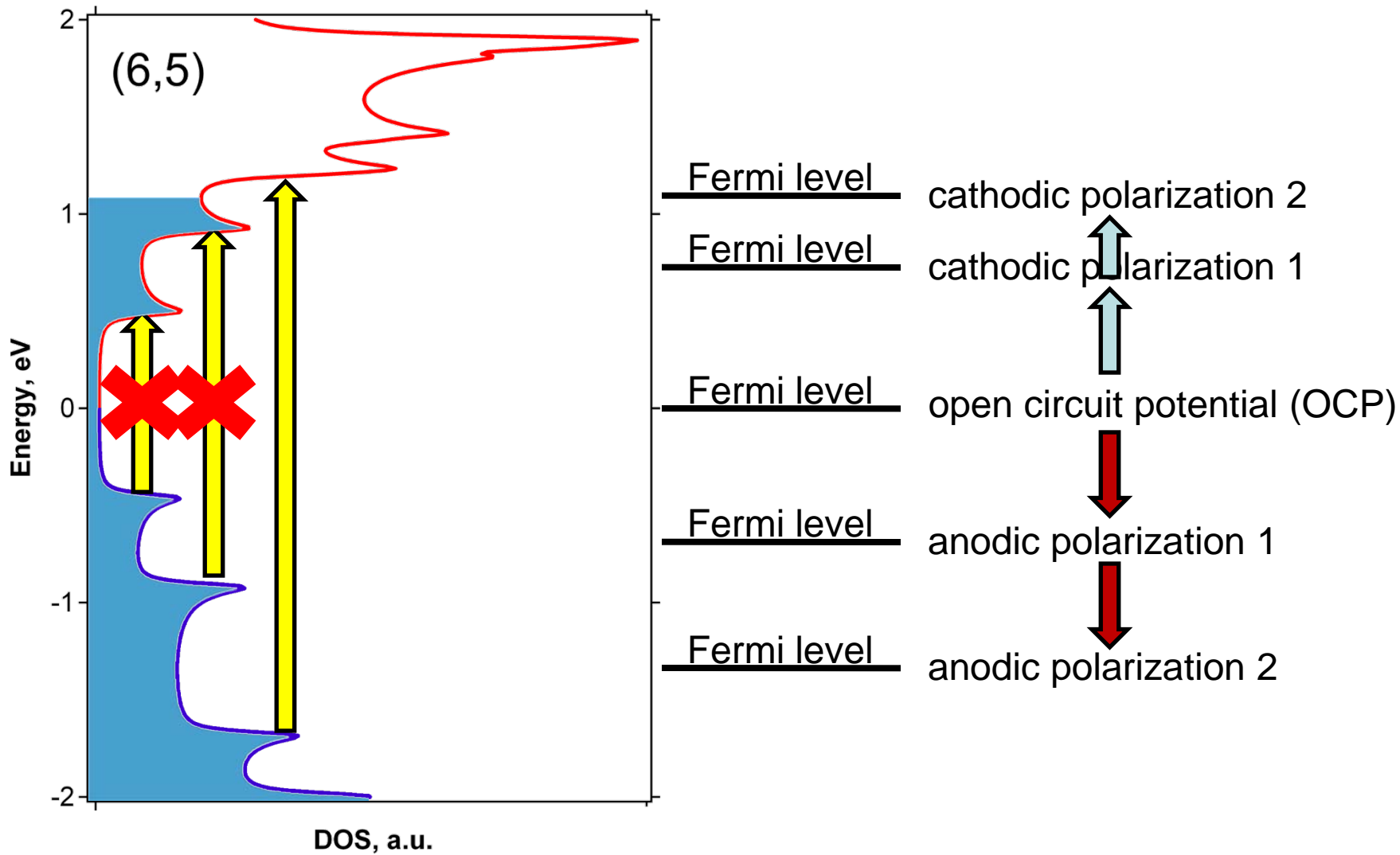

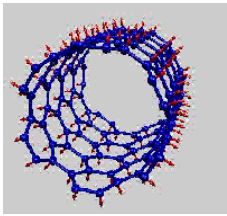

Raman spectrum of SWCNT



C. V. Raman

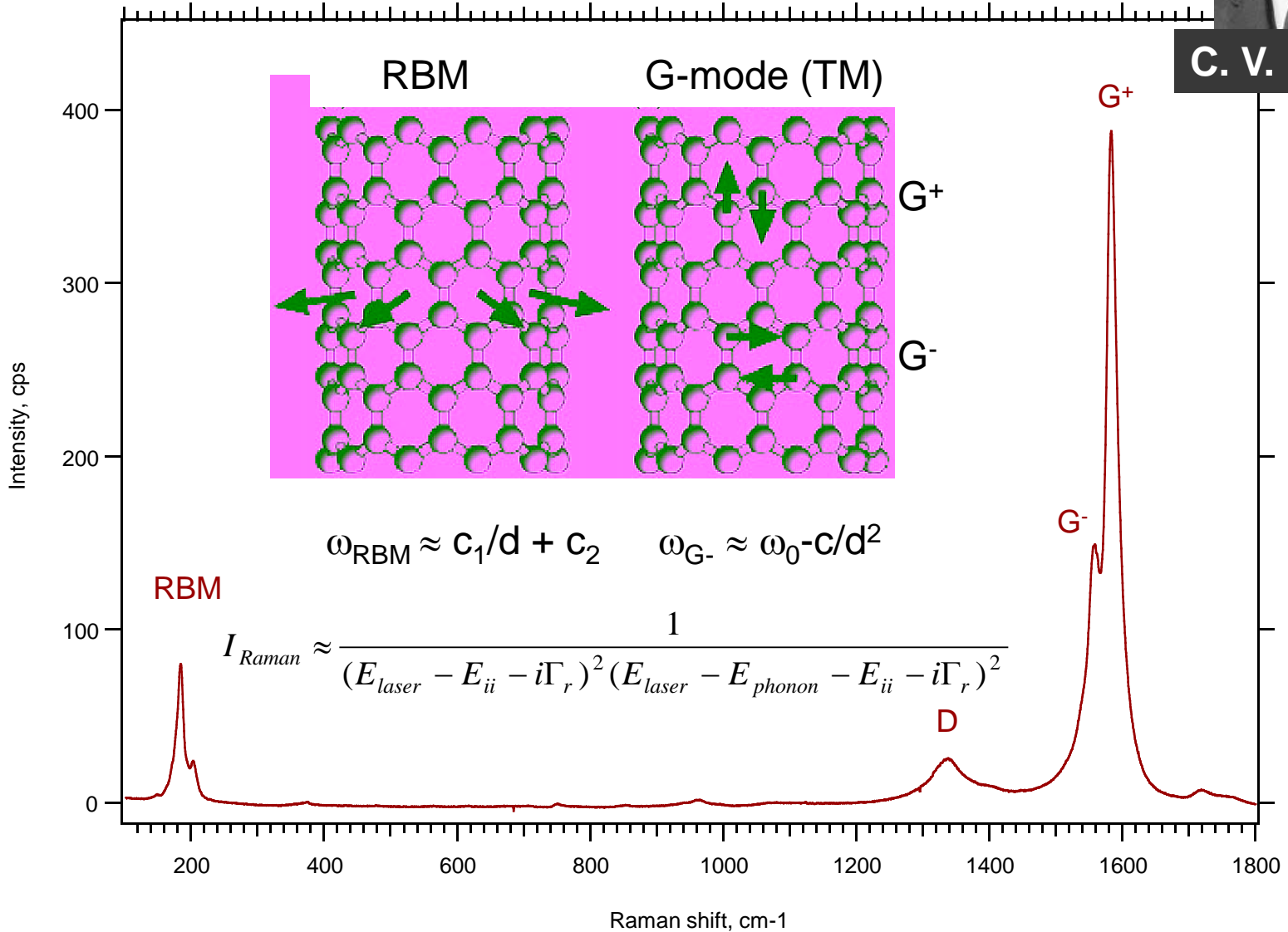

Resonance Raman spectroscopy of SWNT

SWCNT $\varnothing \approx (0.7 - 1.2)$ nm

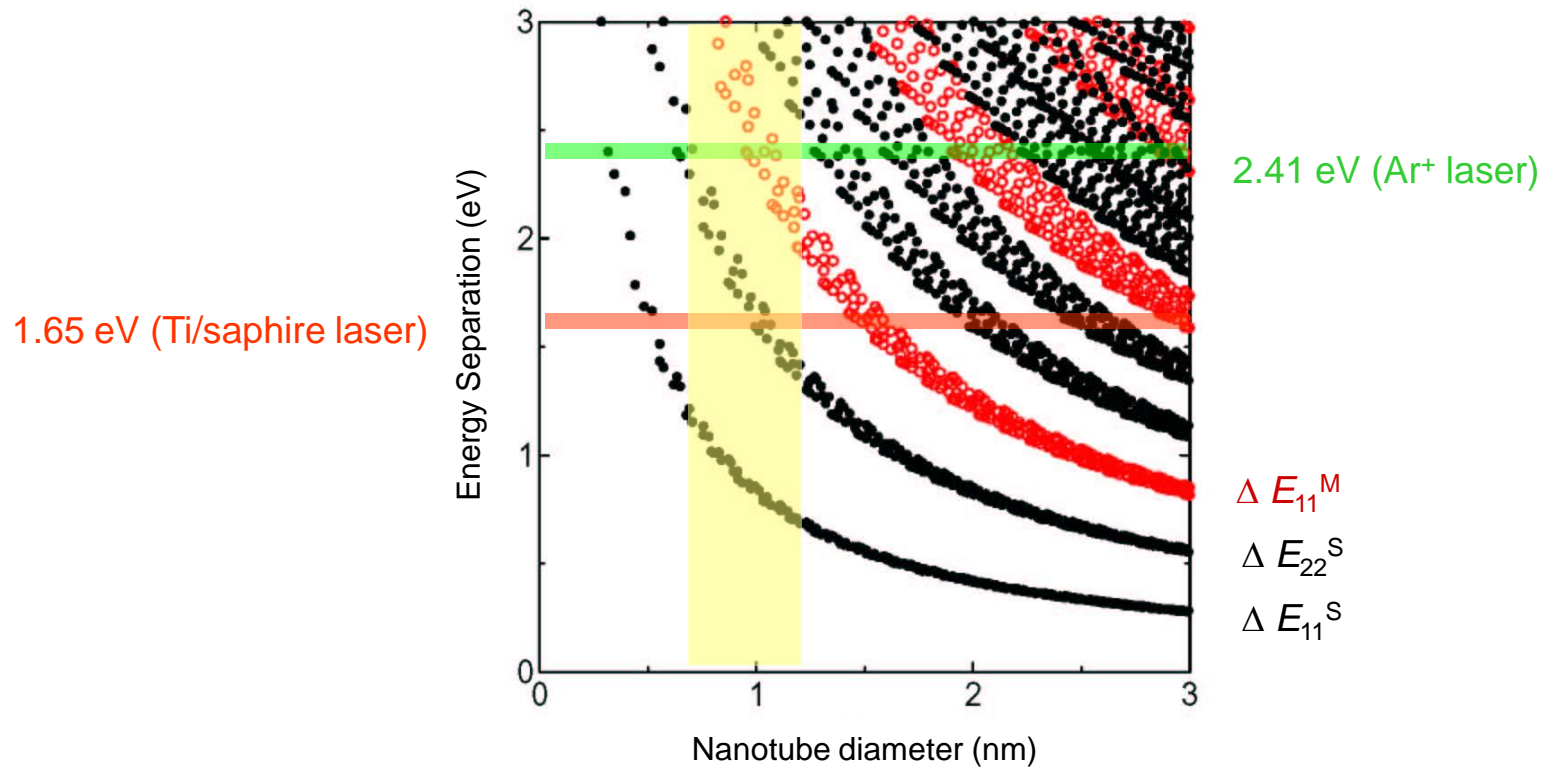

In-situ Raman spectroelectrochemistry

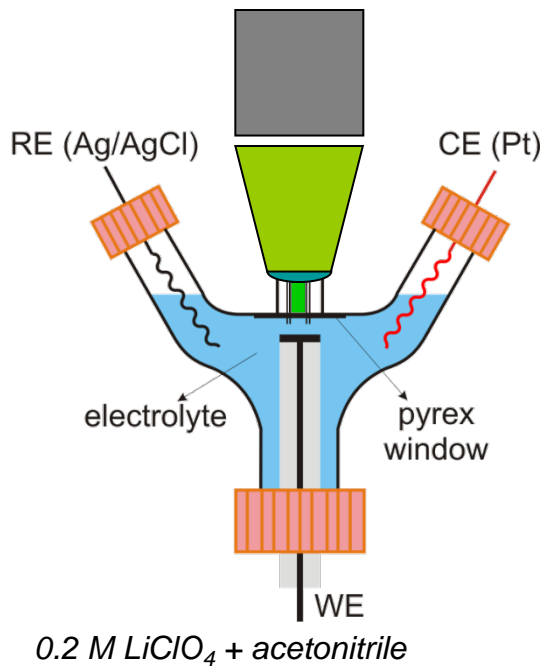

Ar⁺ laser, 514 nm (2.41 eV)

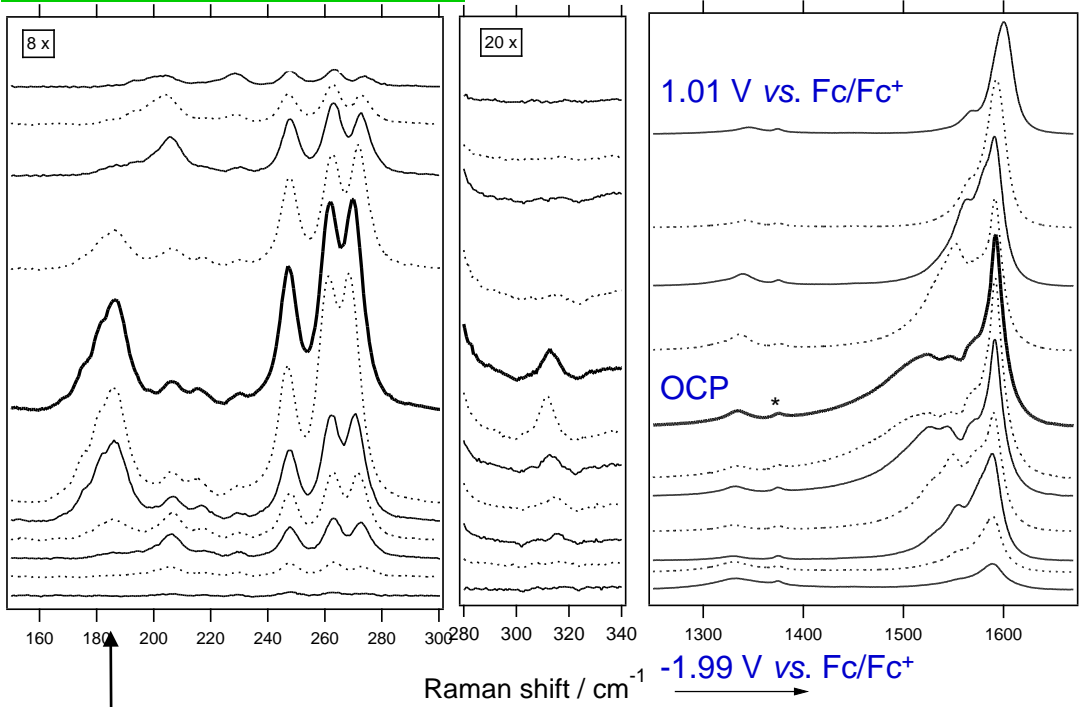

ΔE_{11}^M ; $d \cong 1.2$ nm

ΔE_{22}^S ; $d \cong 0.8$ nm



SWCNT bundles

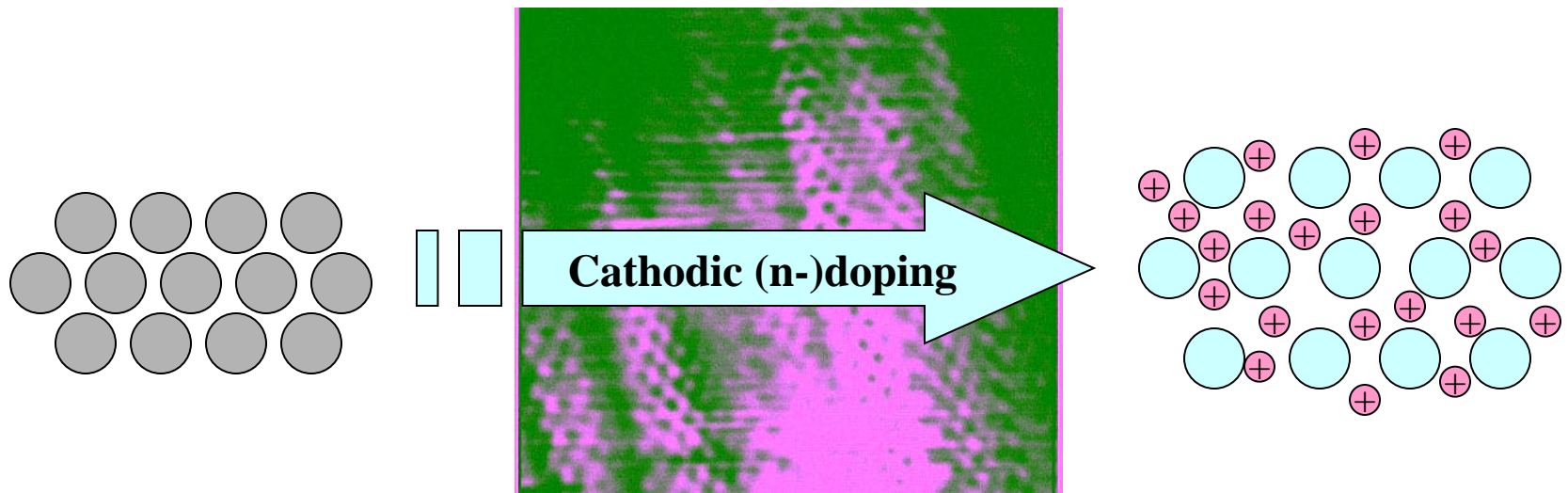

Energy storage: $\oplus = \text{Li}^+$ ($372 \text{ mAh/g} \approx \text{Li}_{1.23}\text{C}_6$) - *Li-ion battery*
 $15\text{-}100 \text{ F/g}$ - *Supercapacitor*

Elchem. H_2 storage: (110 mAh/g ; 0.4%)

Diameter-selective doping (Raman spectroelectrochemistry)

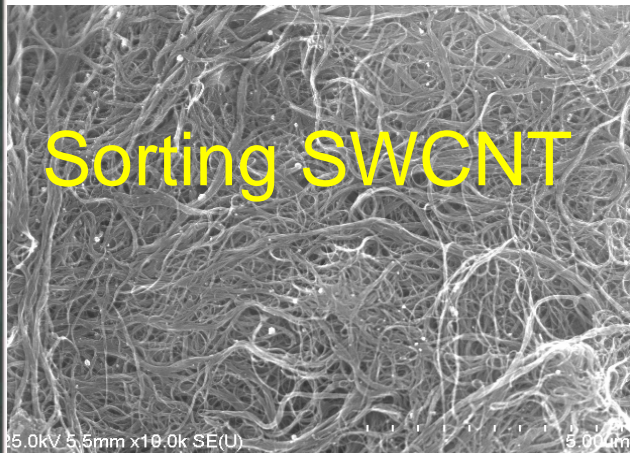
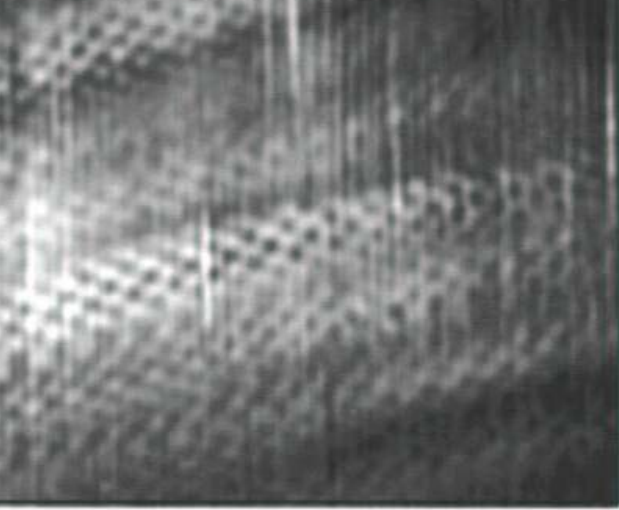

Nanotubes sorted by diameter, twist, electronic type

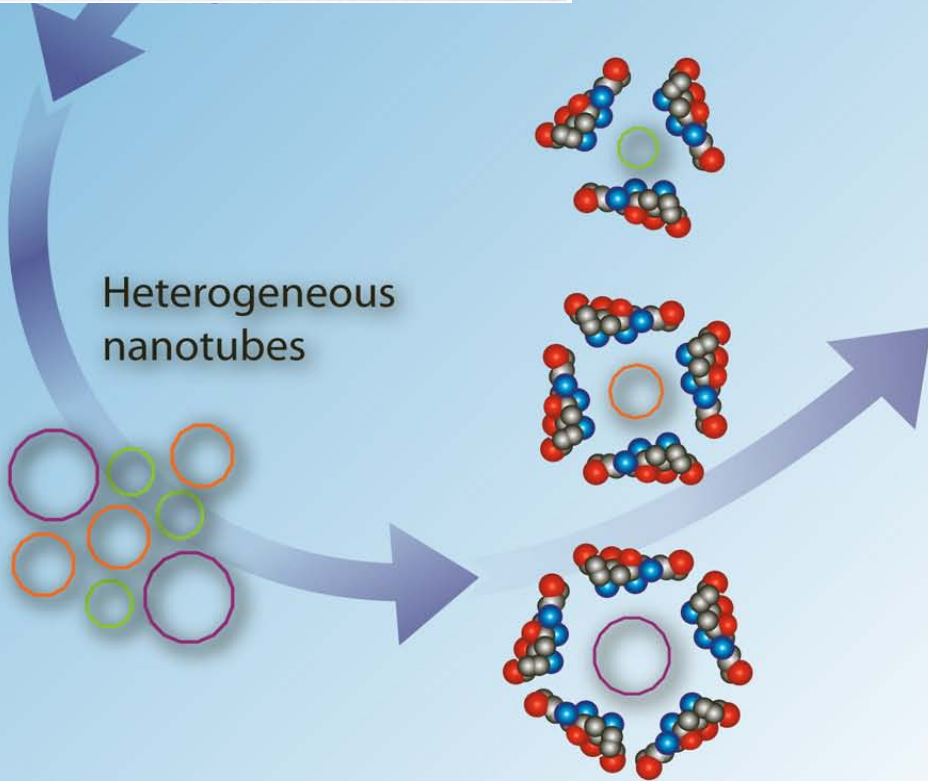
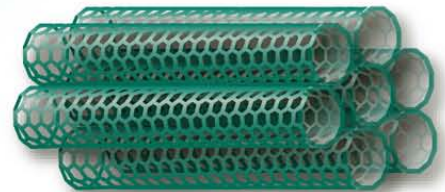
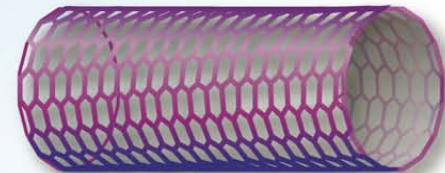

Bundles and aggregates form sediment

Armchair tubes

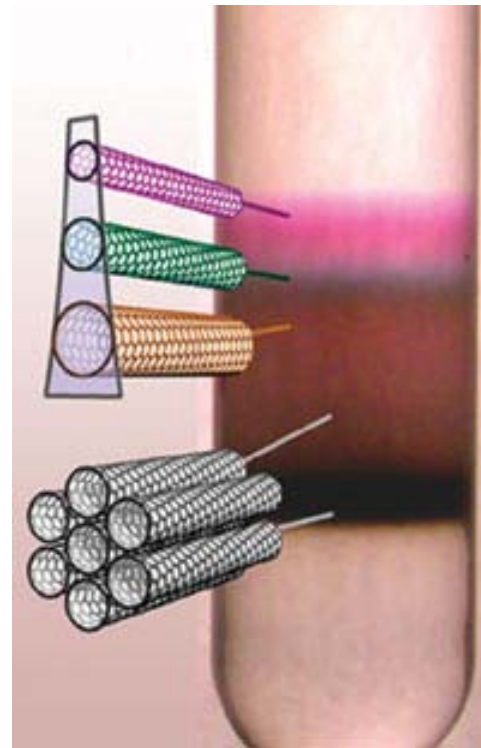
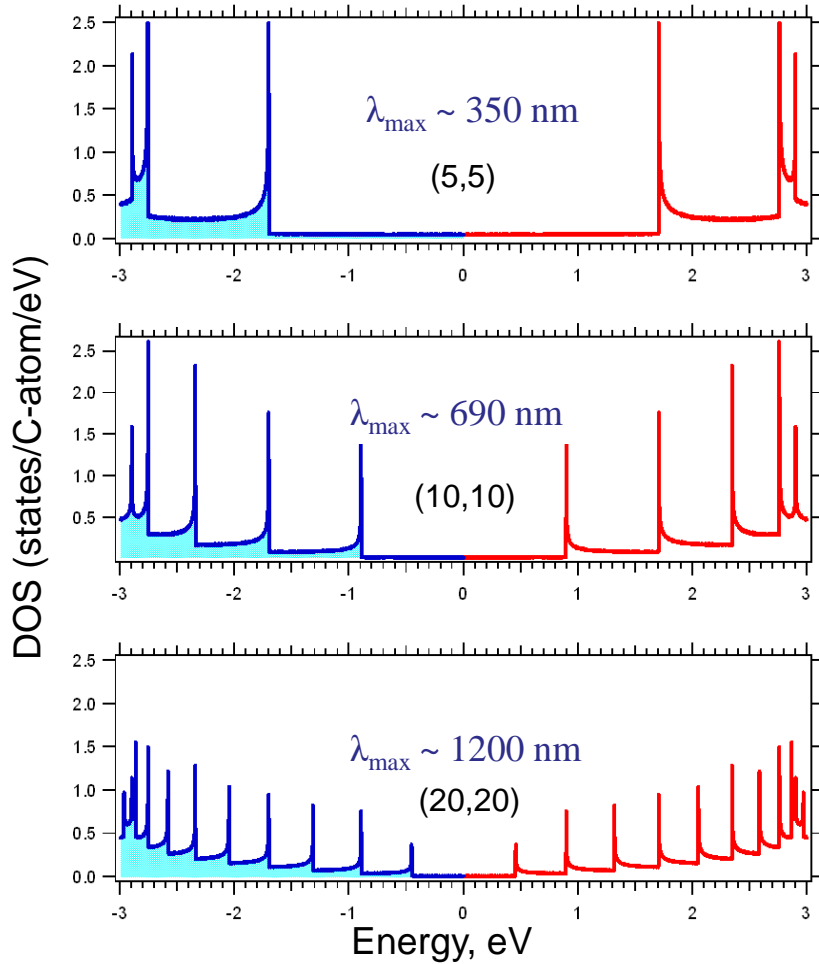

Green & Hersam, *Nature Nanotech.* **4**, 64, (2009)

Formation of fullerene peapod ($C_{60}@SWCNT$)

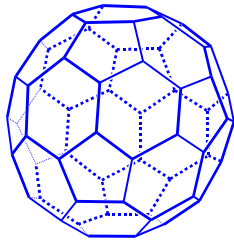

C_{60} (g)

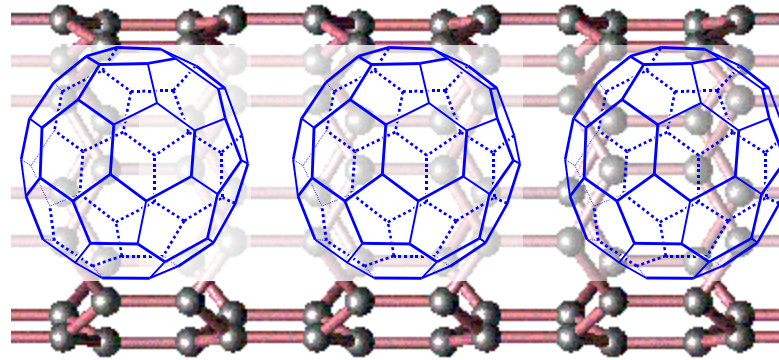

FULLERENE PEAPOD

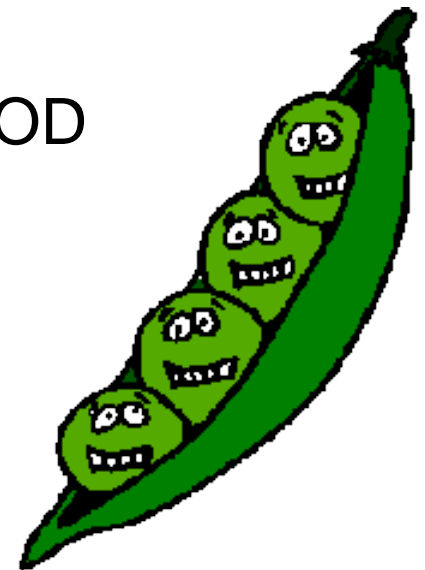
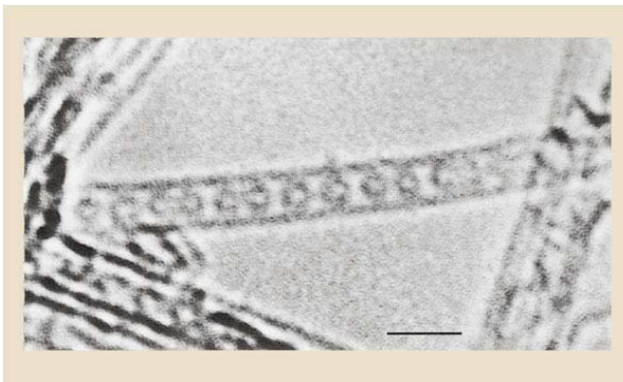

Fullerene peapod C₆₀@SWCNT

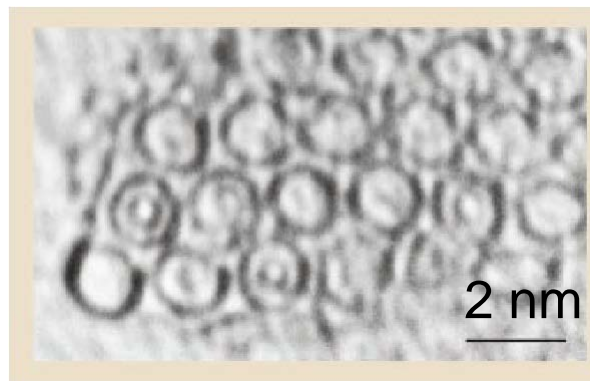
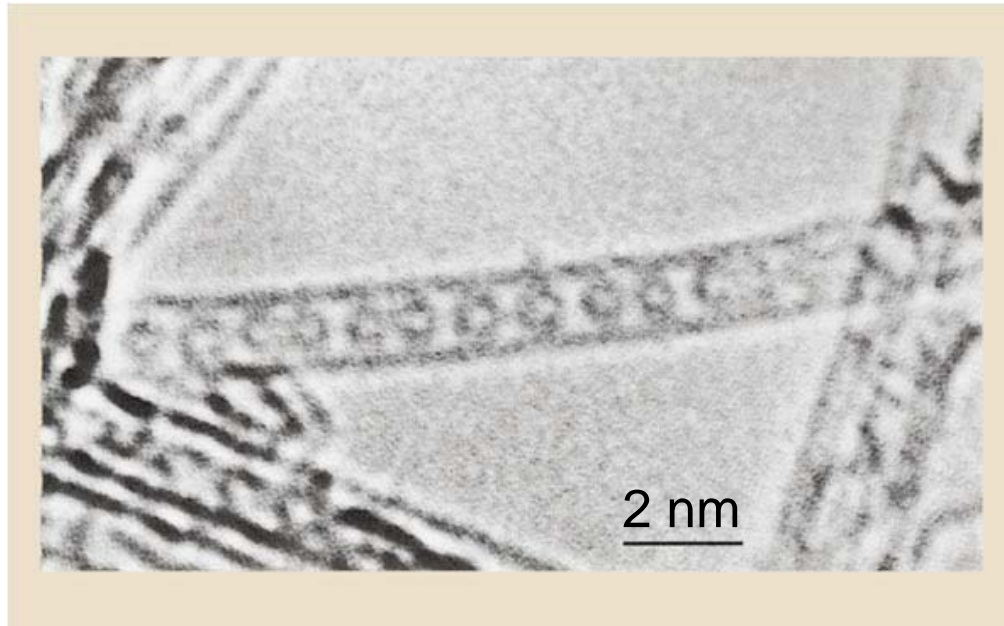

Smith, B.W.; Monthieux, M.; Luzzi, D.E., *Nature* **396**, 323 (1998)

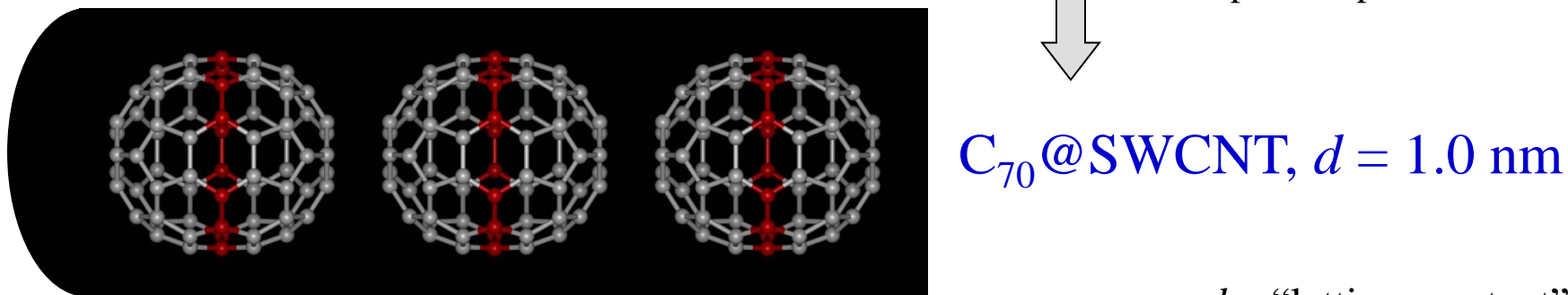
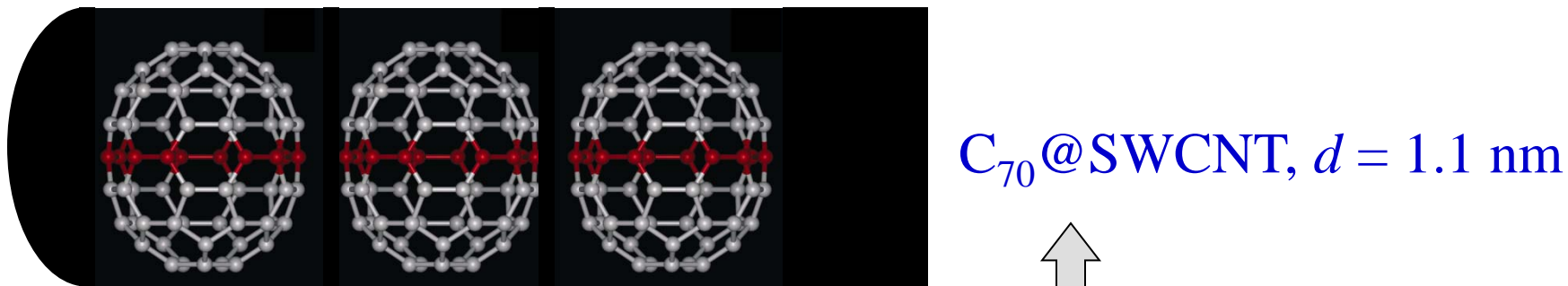
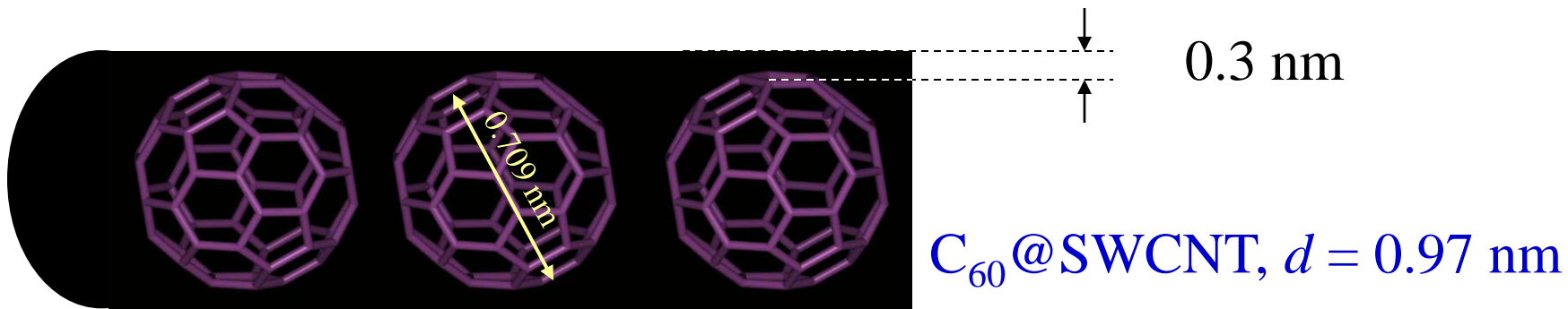

↕
2 allotropic 1-D phases
↕

↑
 d
↑

$d = \text{“lattice constant”}$

Electrochemistry of C₆₀ and SWCNT

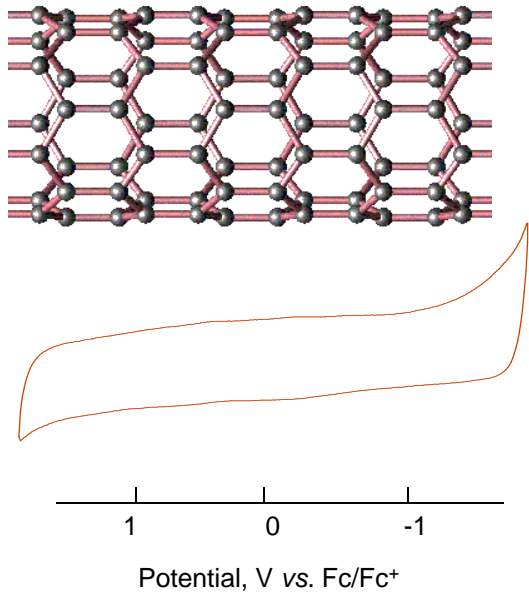
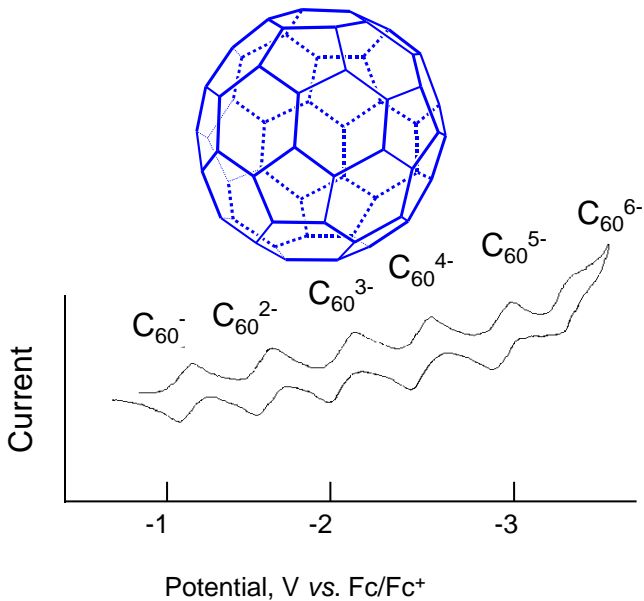

C₆₀ (solution).....CH₃CN/toluene + electrolyte solution (at-10°C)

SWCNT (solid).....CH₃CN + electrolyte solution

Cyclic voltammetry of C₆₀@SWCNT

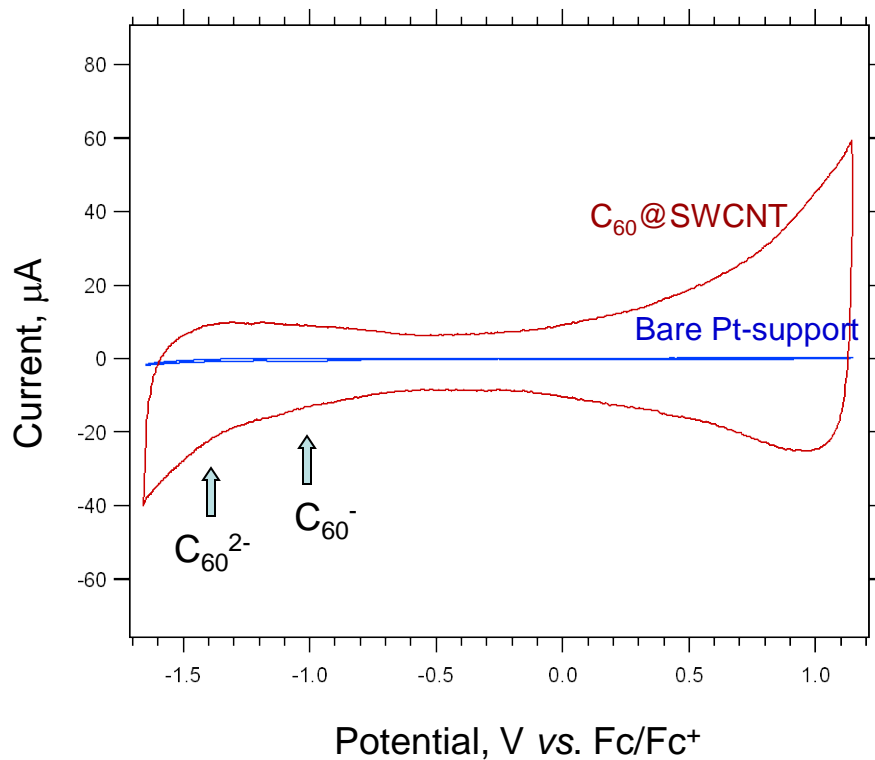

Δf ... number of e⁻/C-atom
 C ... capacitance ≈ 40 F/g

$$\Delta f = \frac{CM_c \Delta U}{F}$$

$\Delta f = 0.005$ e⁻/C-at (found)

$\Delta f = 0.017$ e⁻/C-at (assumed) for C₆₀/C₆₀⁻

Raman spectra of C₆₀ (single crystal) and SWCNT

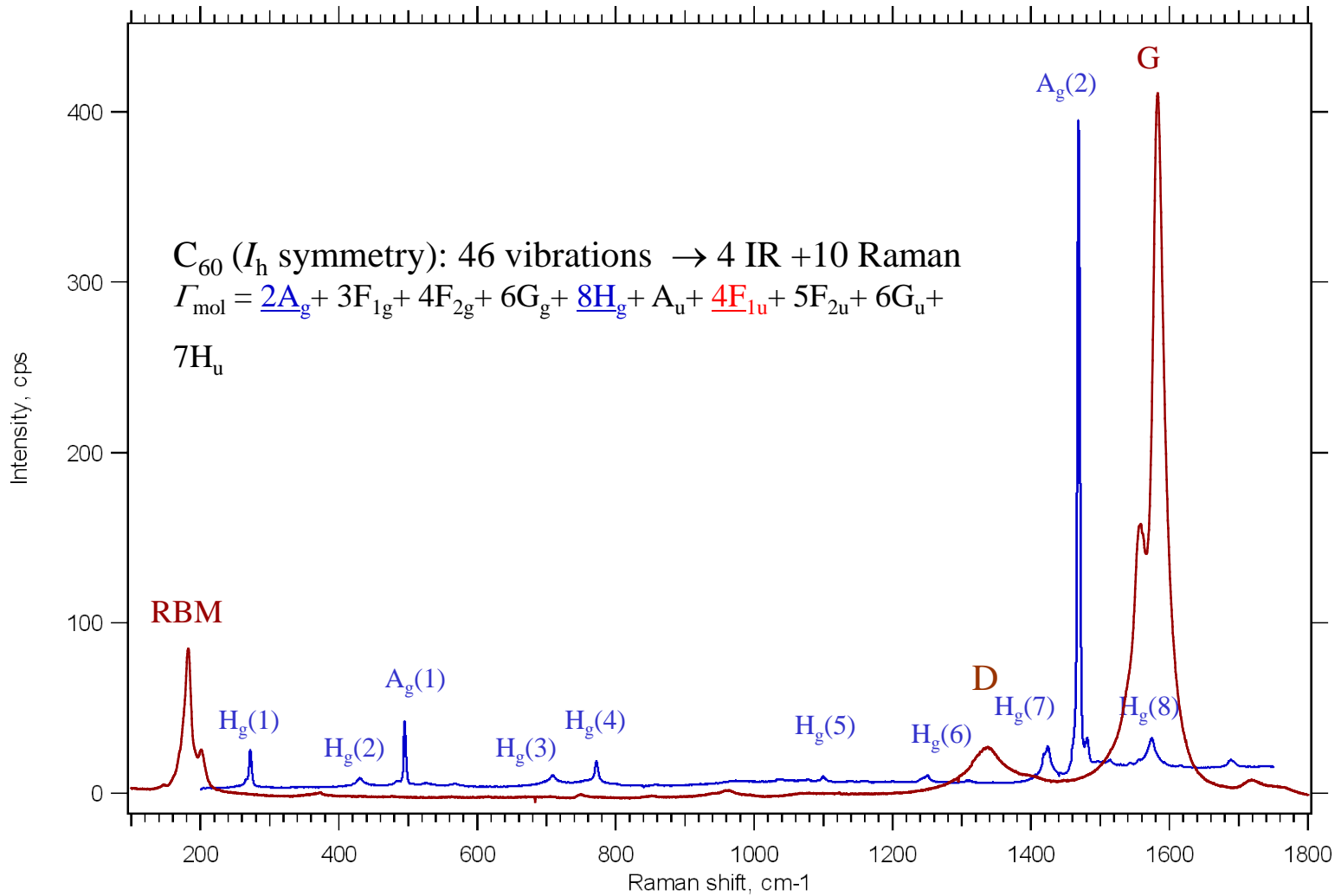

Raman spectra of dry C₆₀@SWCNT $h\nu_{exc} = 2.41 \text{ eV}$ or 2.54 eV

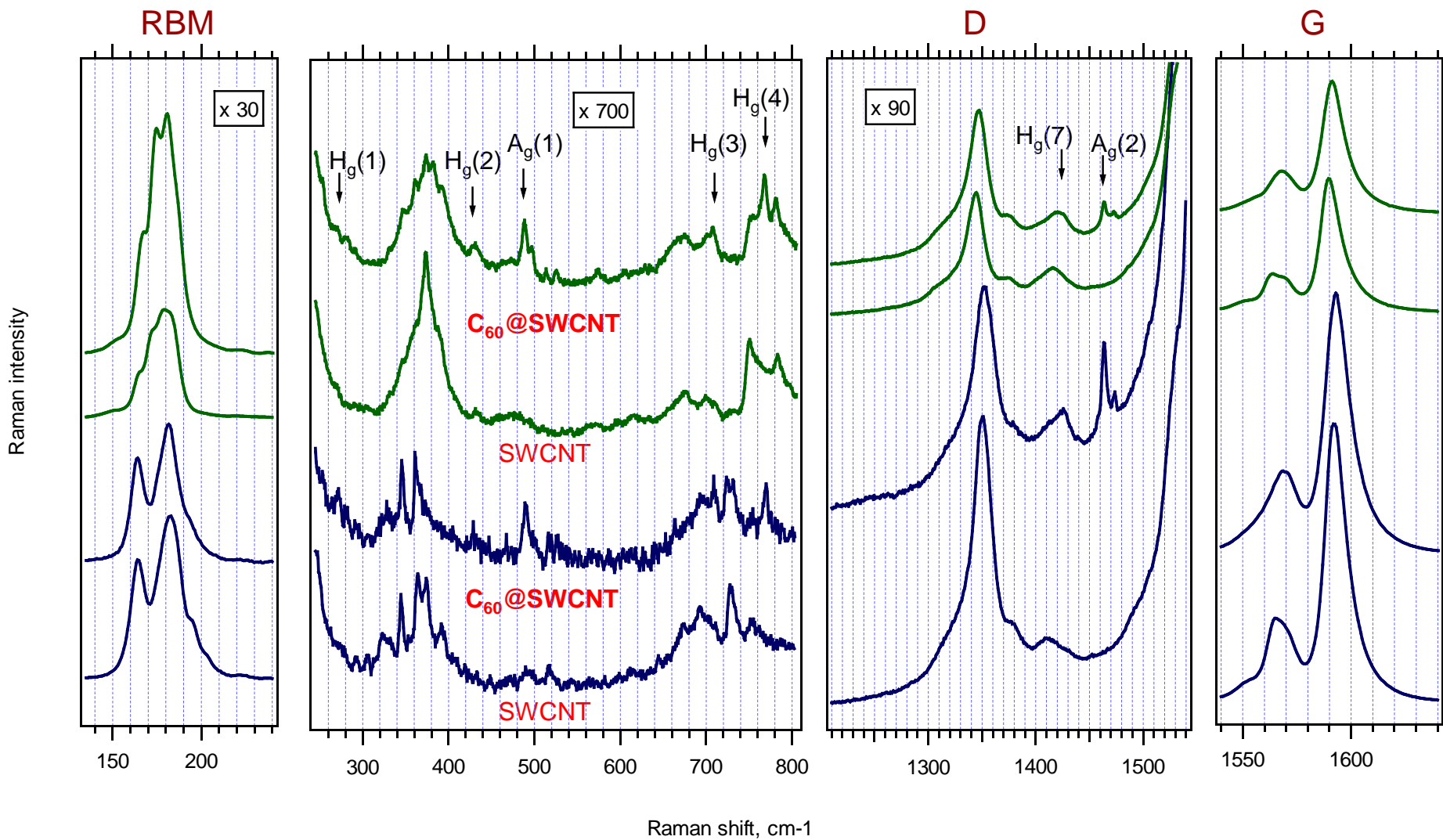

Raman spectra of $C_{70}@SWCNT$ $h\nu_{exc} = 2.41 \text{ eV}$ or 2.54 eV

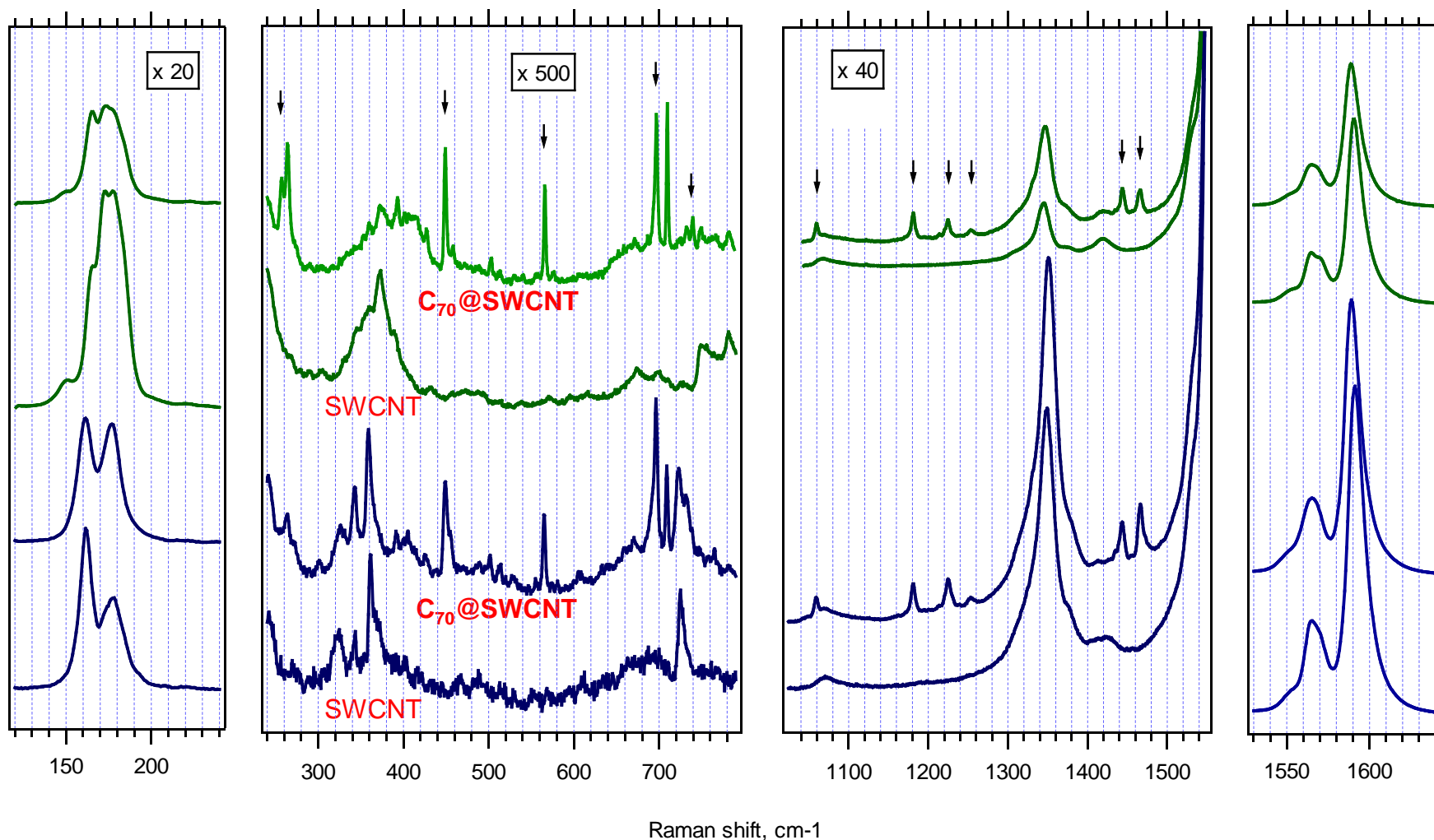

C_{70} (D_{5h} symmetry): 53 Raman active vibrations: $12A_1' + 22E_2' + 19E_1''$

Raman spectroelectrochemistry $C_{60}@SWCNT$ ($h\nu_{exc} = 2.54$ eV)

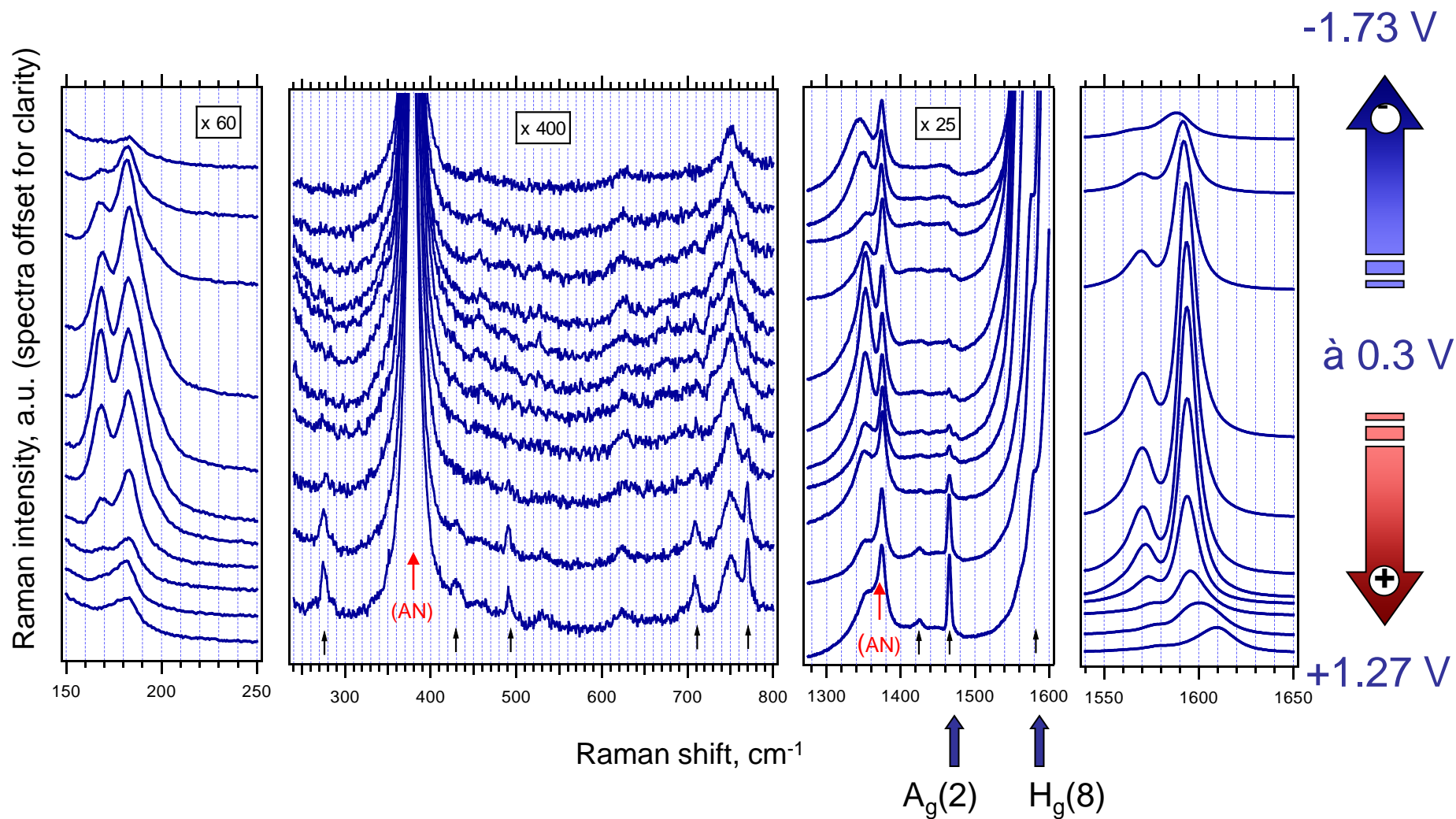

$C_{60}@SWCNT$ film on Pt electrode in 0.2 M $LiClO_4$ + acetonitrile, potentials vs. Fc/Fc^+

Raman spectroelectrochemistry: C₇₀@SWCNT ($h\nu_{exc} = 2.41$ eV)

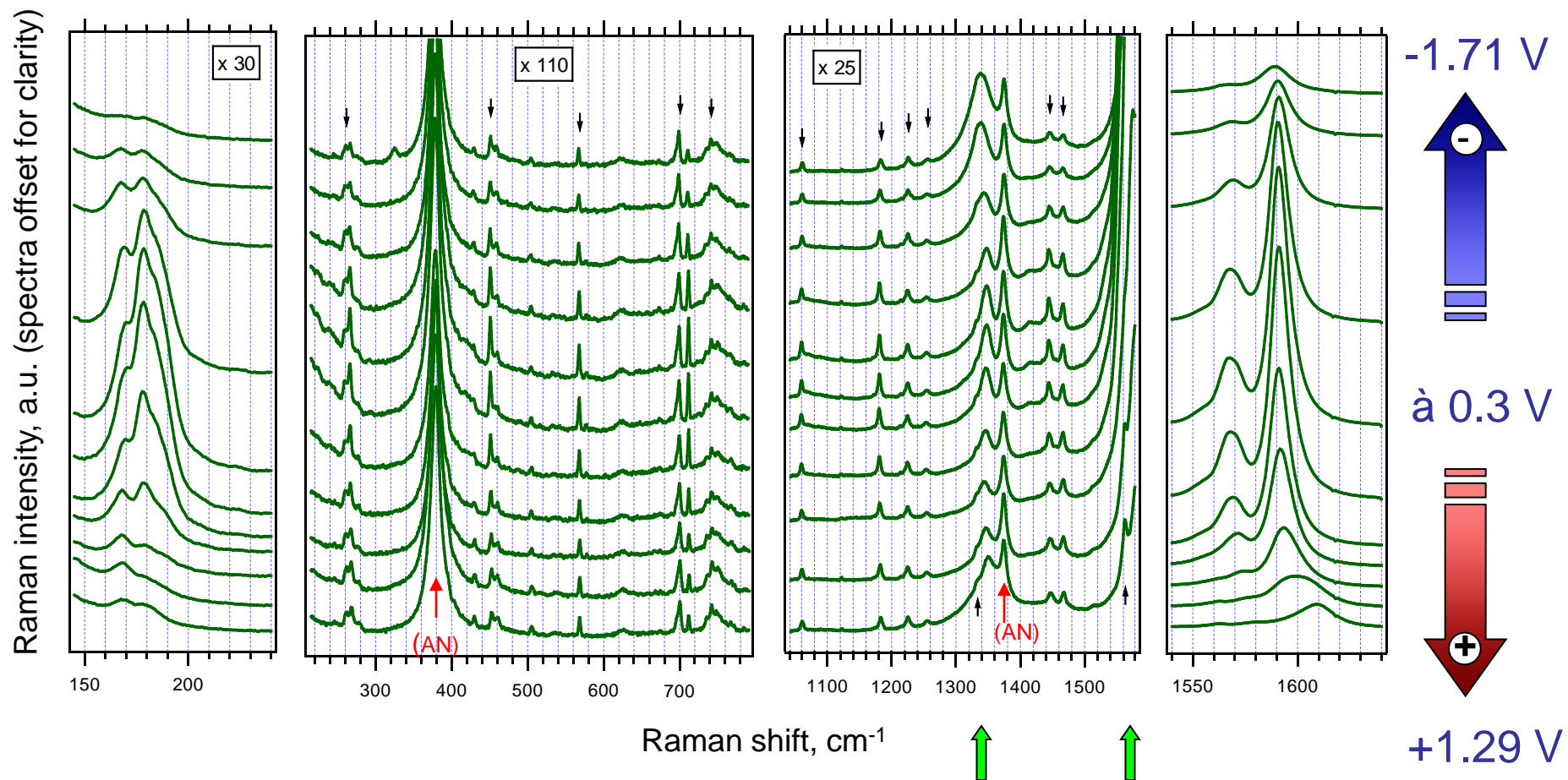

C₇₀@SWCNT film on Pt electrode in 0.2 M LiClO₄ + acetonitrile, potentials vs. Fc/Fc⁺

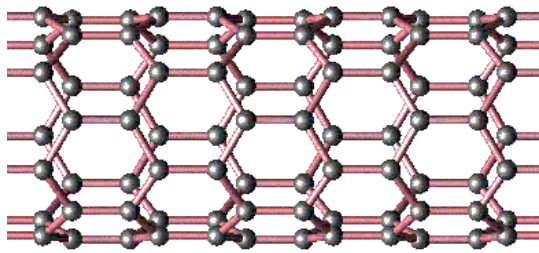

(10,10)

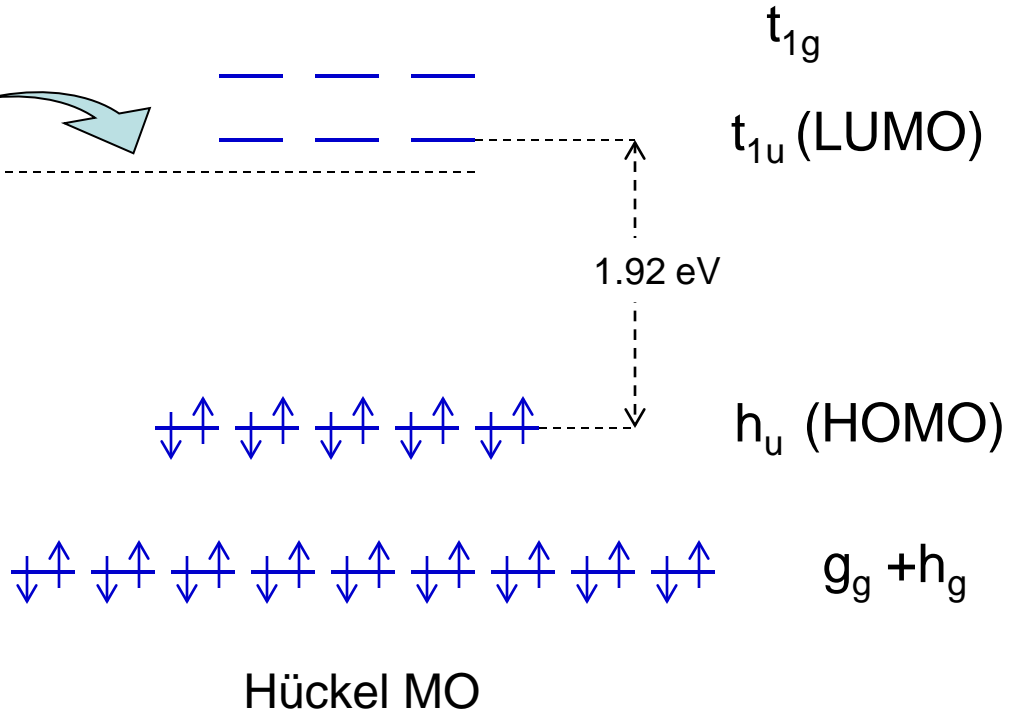
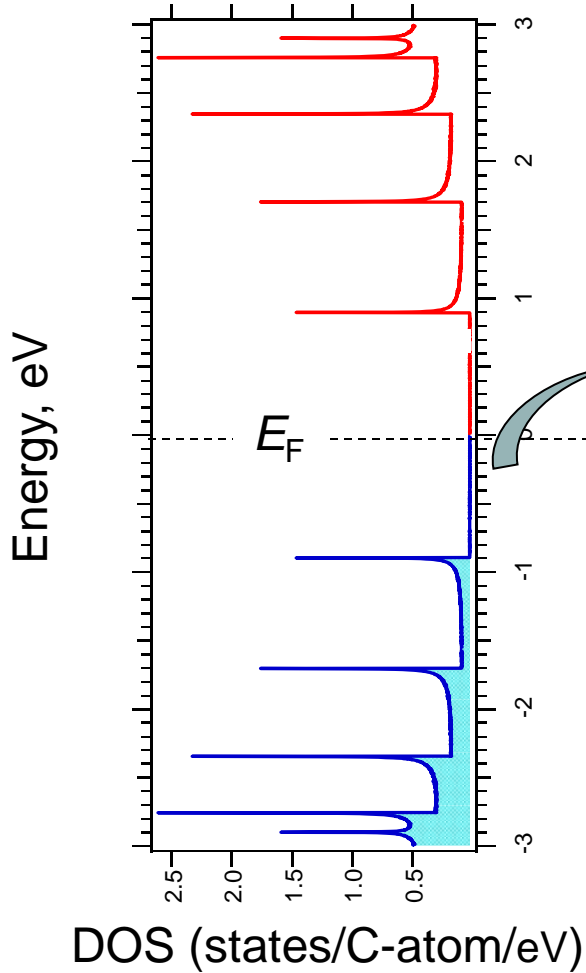
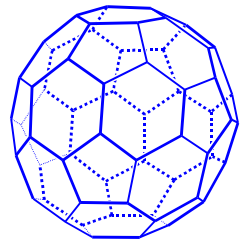

Double walled nanotubes

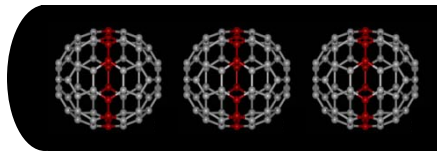

$C_{60}@SWCNT$

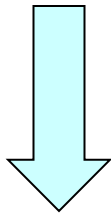

DWCNT

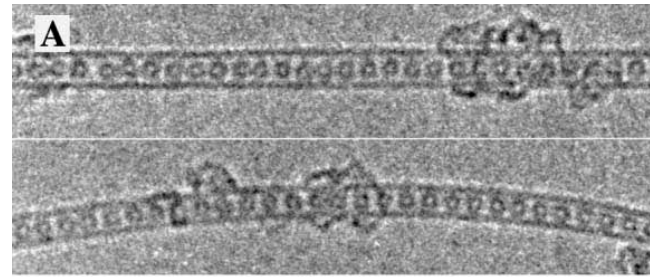
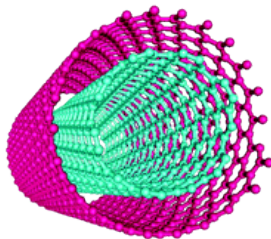

RT

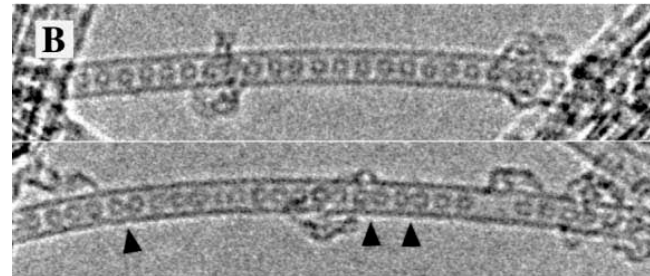

800 °C

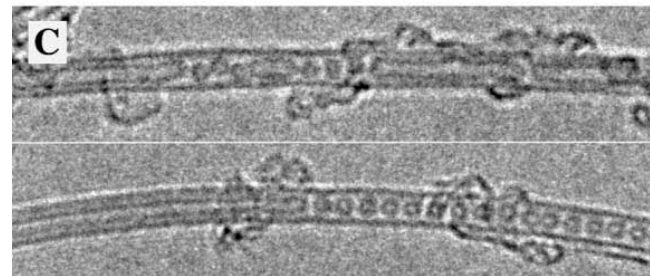

1000 °C

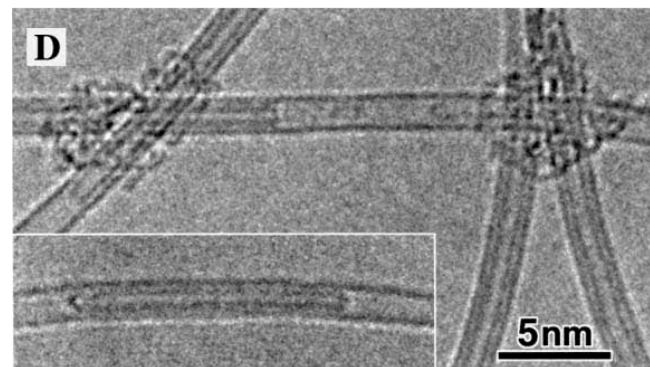

1200 °C

Stone-Wales rearrangement pathway for fusion of fullerenes

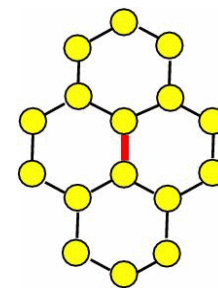

[Hiroshi Ueno, Shuichi Osawa, Eiji Osawa, and Kazuo Takeuchi, Fullerene Science And Technology **6**, 319-338 (1998)]

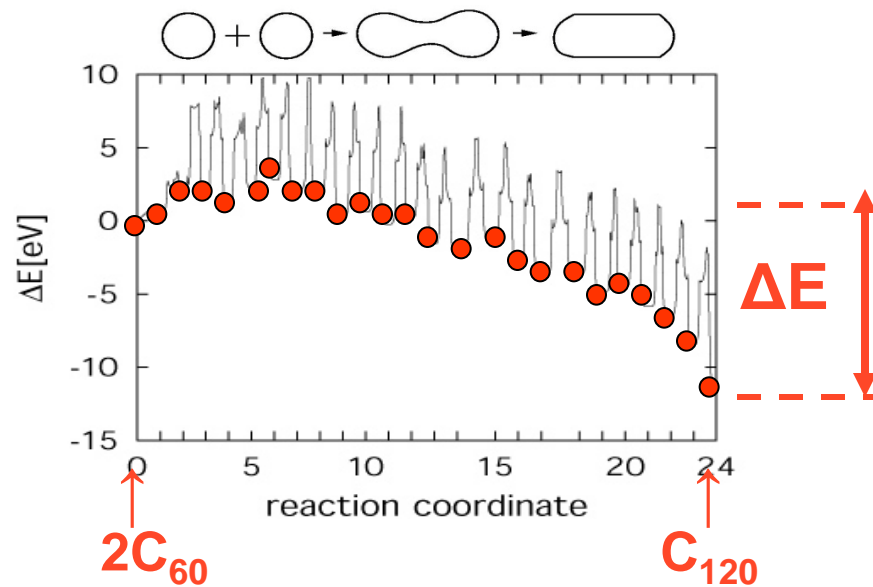
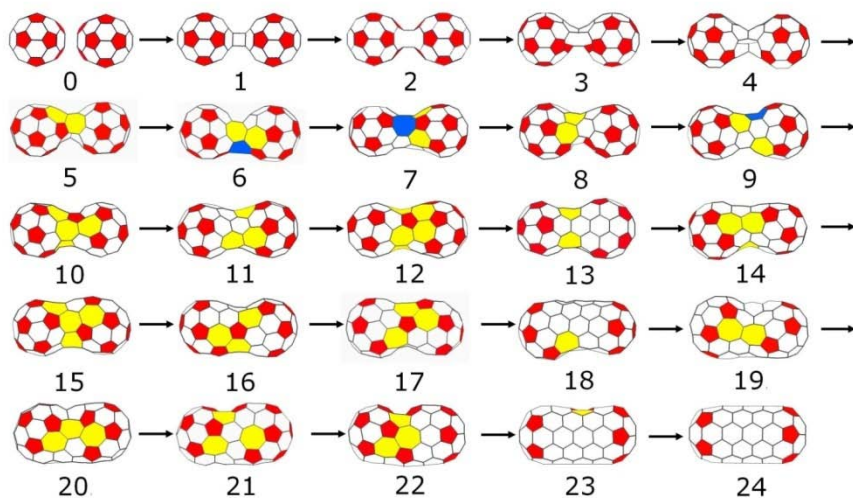

Raman spectra of DWCNT, $h\nu_{\text{exc}} = 1.83 \text{ eV}$

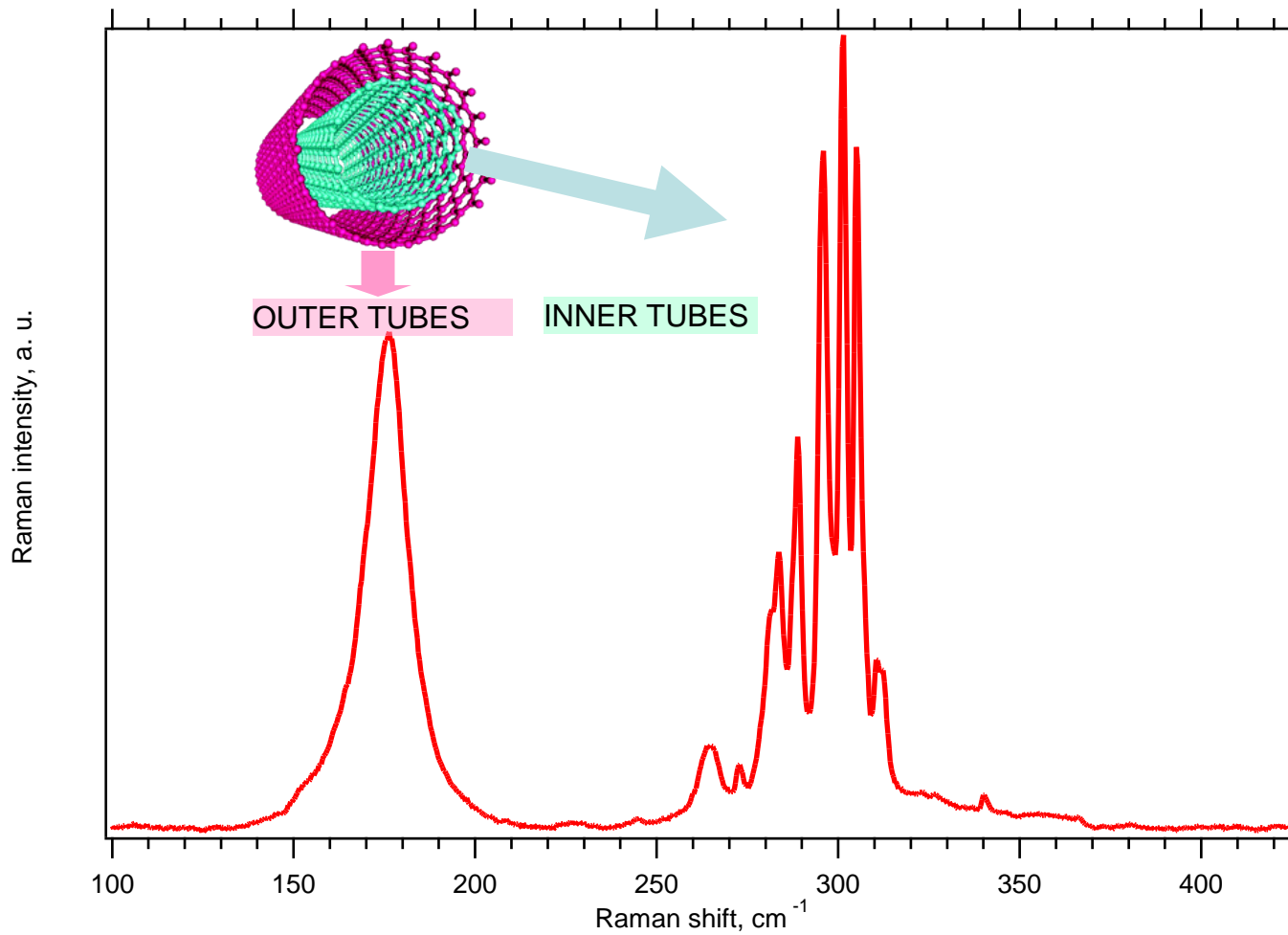

Raman spectra of DWCNT ($\lambda_{\text{exc}} = 676 \text{ nm}$) from peapods $C_{60} - C_{84}$

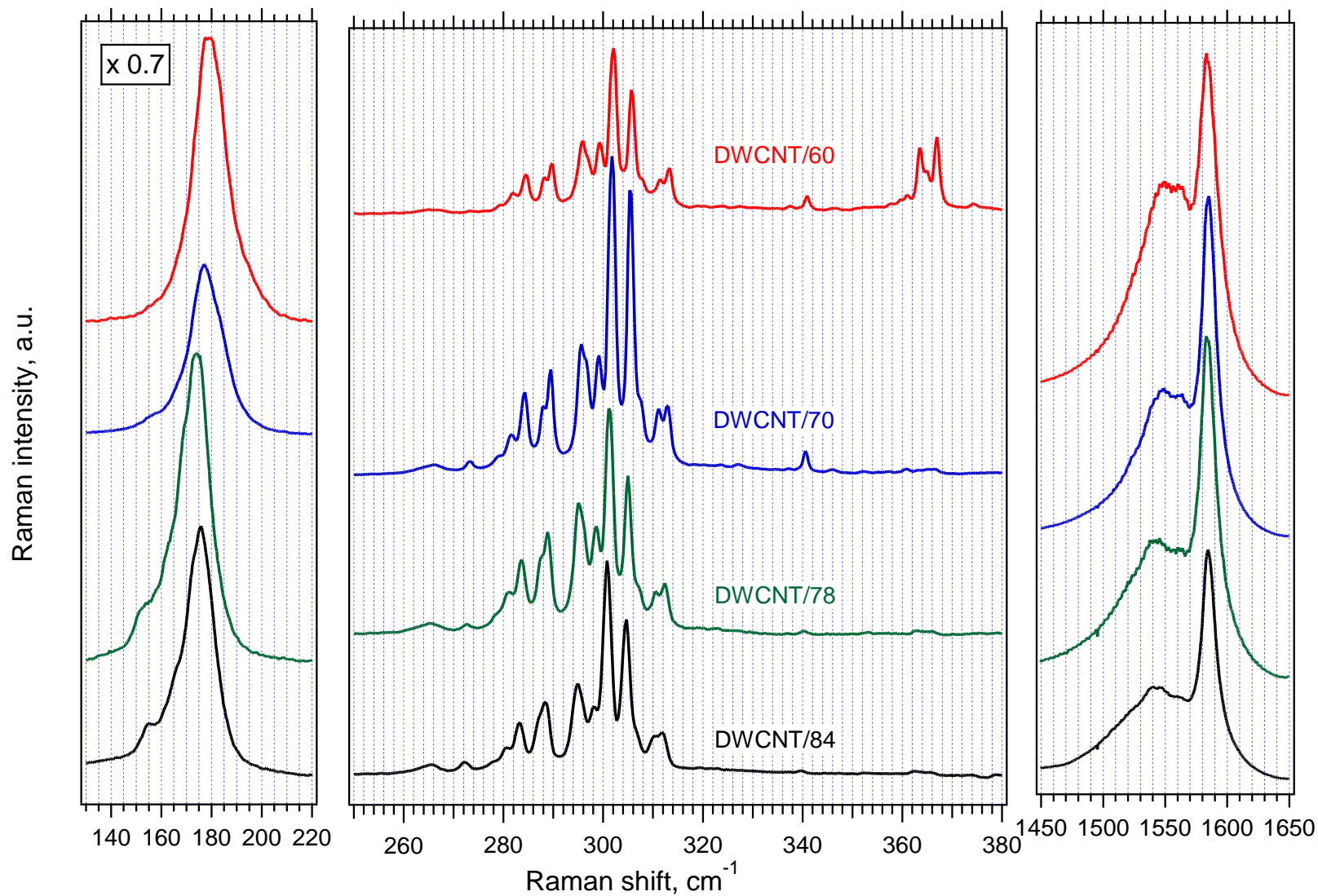

Raman spectroelectrochemistry ($h\nu_{\text{exc}} = 2.41 \text{ eV}$)

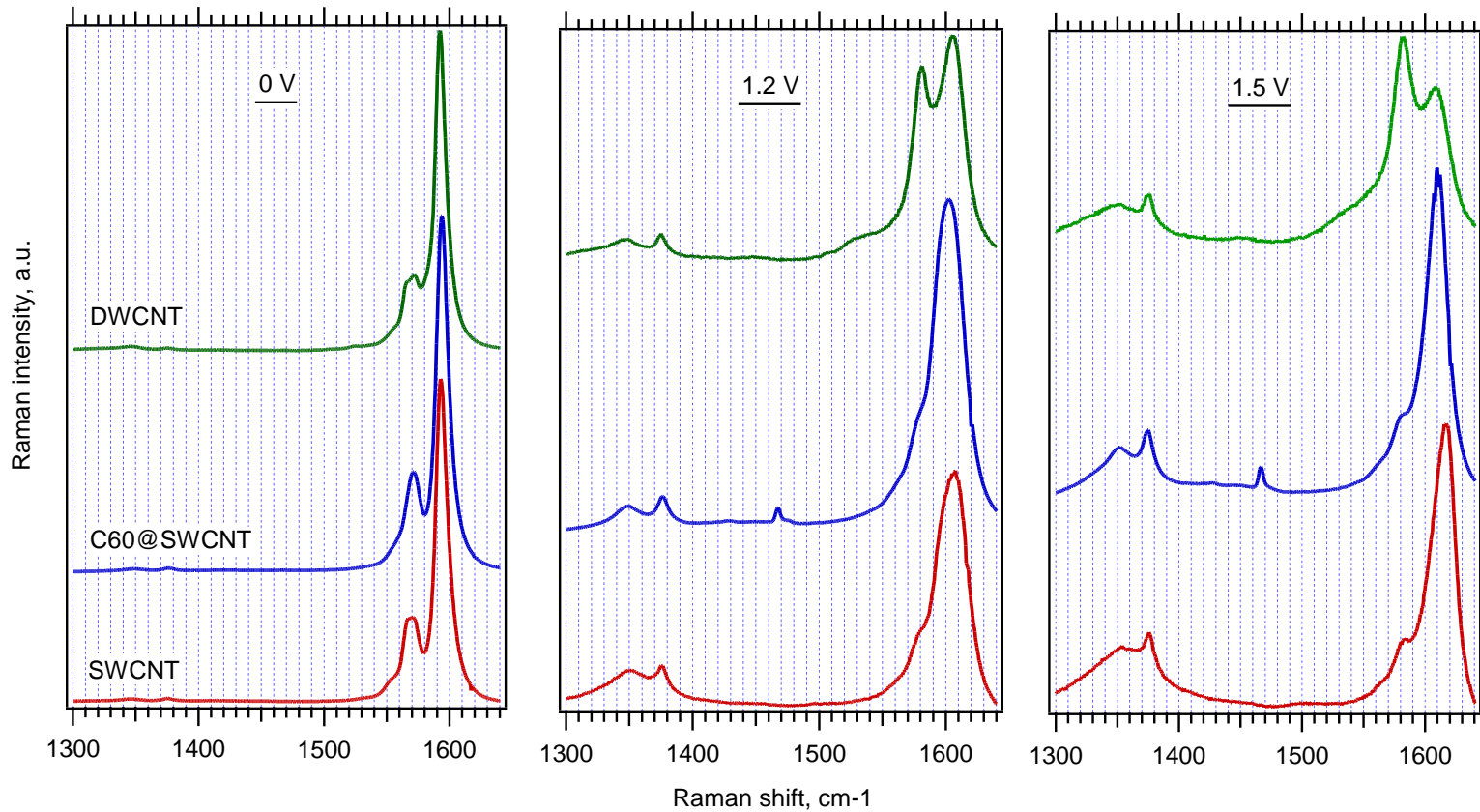

DWCNT film on Pt electrode in 0.1 M LiClO₄ + AN

Raman spectroelectrochemistry DWCNT ($h\nu_{exc} = 1.83 \text{ eV}$)

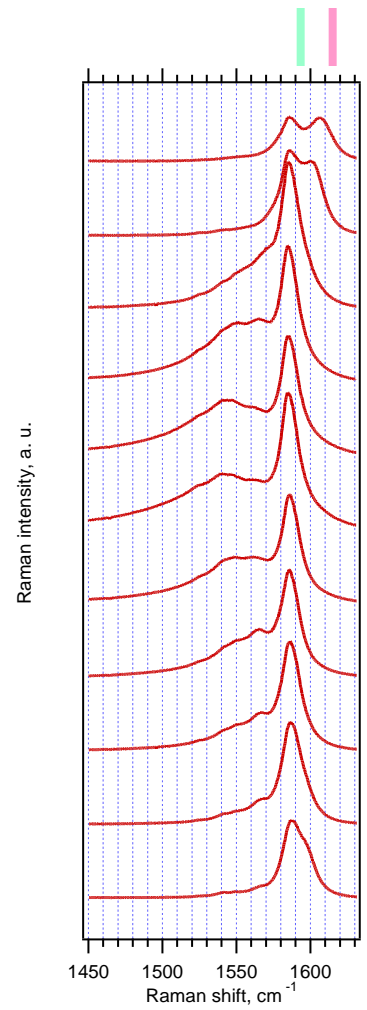
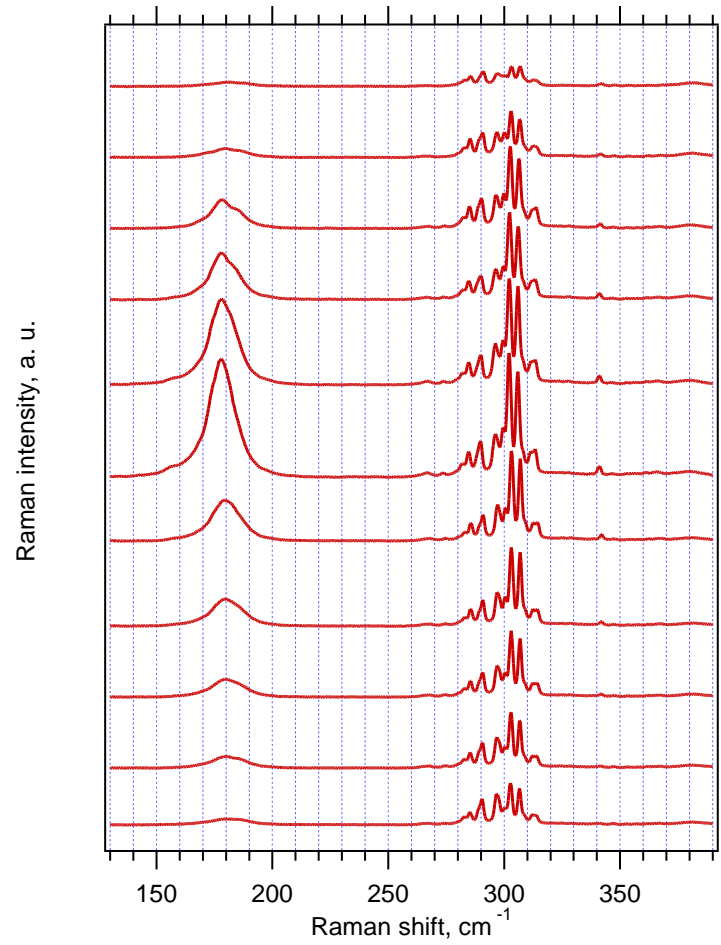
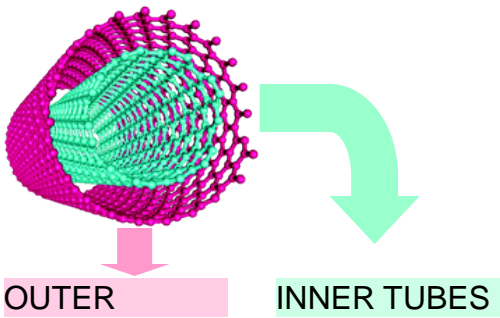

+1.15 V



à 0.3 V

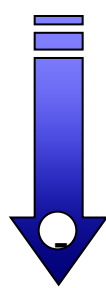

-1.85 V

DWCNT film on Pt electrode in 0.1 M LiClO₄ + AN

^{13}C -labeled graphene and $^{13}\text{C}/^{12}\text{C}$ double layer graphene

Synthesis by CVD: substrate Ni@SiO₂/Si
 CH₄ + H₂; 1000°C, 5 min ^{13}C -CH₄ (Aldrich)
 PMMA transfer to clean SiO₂/Si

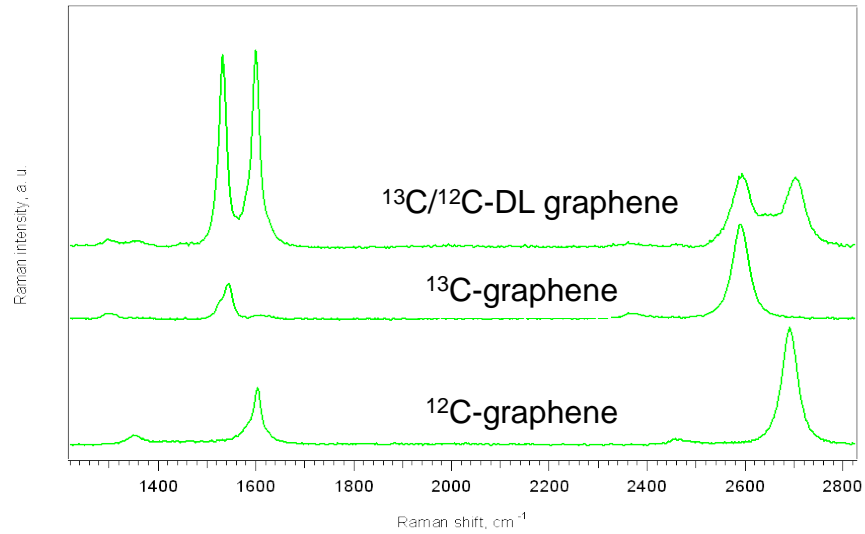
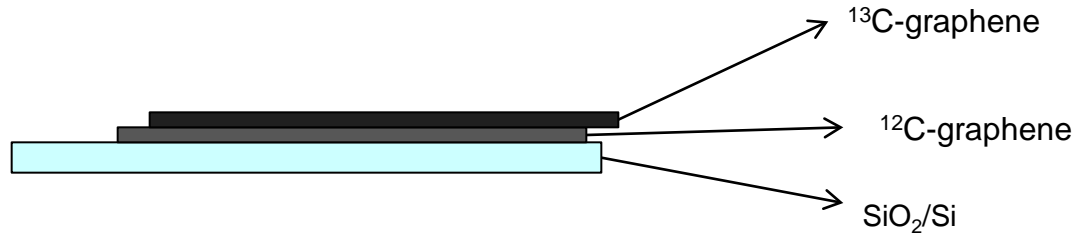
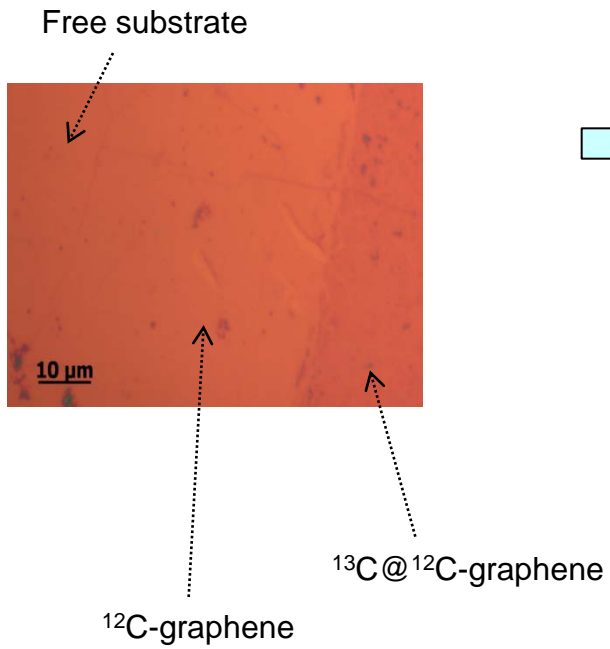

continuum model:
 $(\omega_0 - \omega) / \omega_0 = 1 - [(12 + c_0) / (12 + c)]^{1/2}$
 ω_0 frequency of ^{12}C mode(s)
 ω frequency of ^{13}C mode(s)
 $c_0 = 0.0107$ (natural abundance of ^{13}C)
 $c = 0.99$ (concentration in ^{13}C enriched sample)

Raman spectra of the ^{12}C -graphene, ^{13}C graphene, and $^{13}\text{C}/^{12}\text{C}$ double-layer (^{13}C is on top, ^{12}C at bottom. Excitation: 2.33 eV laser (Nd-YAG).

Spectroelectrochemistry of $^{13}\text{C}/^{12}\text{C}$ double layer graphene

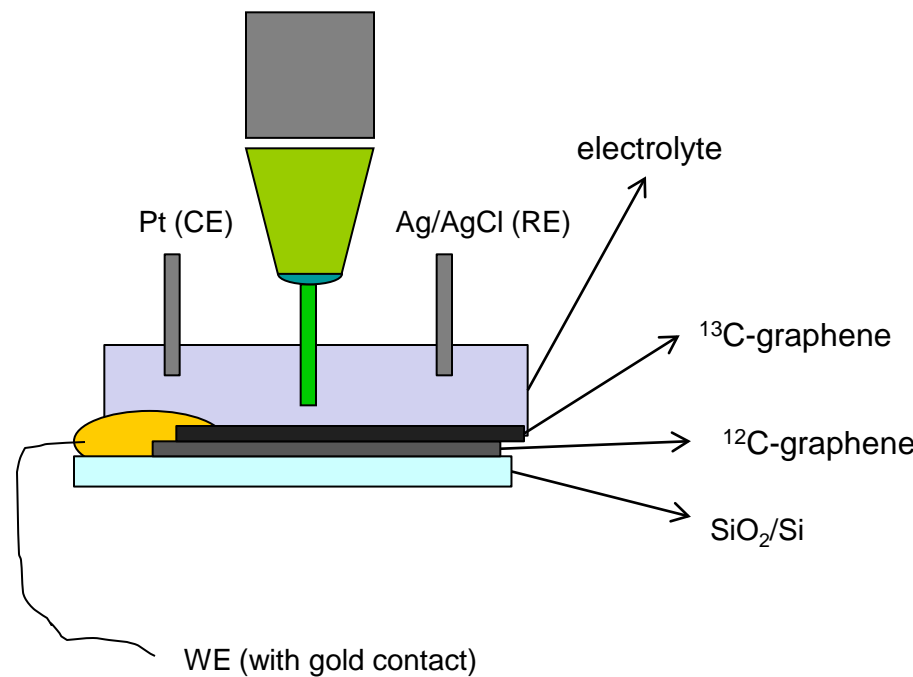
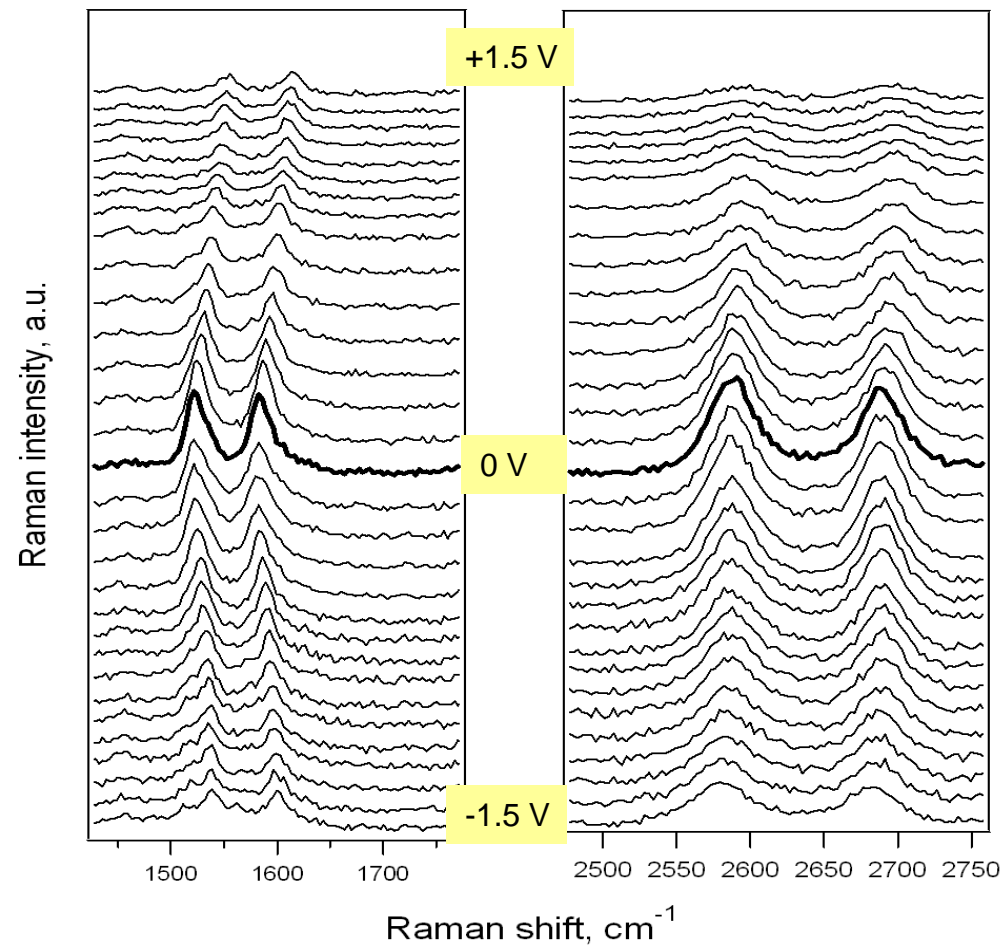

*Raman spectroelectrochemistry (2.33 eV laser excitation energy)
Electrolyte: 0.1 M LiClO₄ dissolved in dry propylenecarbonate/PMMA
Electrode potentials from -1.5 to 1.5 V vs. Ag/Ag⁺ (from bottom to top).*

Spectroelectrochemistry of carbon nanostructures

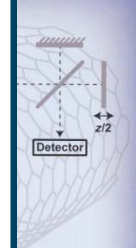
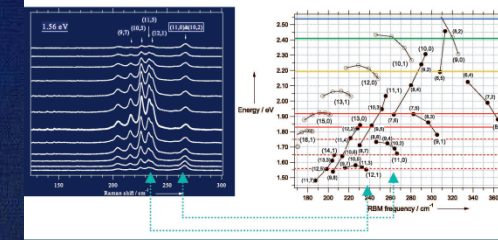
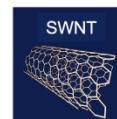
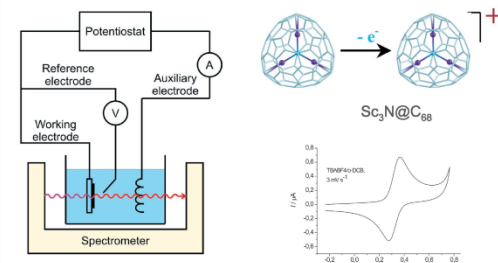

Transform
oscopy

WILEY-VCH
BICENTENNIAL
1807
WILEY
2007
BICENTENNIAL

Spectroelectrochemistry:

- L. Kavan, L. Dunsch, "Spectroelectrochemistry of carbon nanostructures" *ChemPhysChem* **8**, 974-998 (2007).
- L. Kavan, L. Dunsch, "Electrochemistry of Carbon Nanotubes" in (A. Jorio, G. Dresselhaus, M.S. Dresselhaus, Eds.) *Carbon Nanotubes: Advanced Topics in the Synthesis, Structure, Properties and Applications*, Springer, Berlin, 2008, pp. 567-603.
- L. Kavan, L. Dunsch, "Spectroelectrochemistry of carbon nanotubes" *ChemPhysChem* **12**, 47-55 (2011).

1/2011

A Journal of
ChemPubSoc
Europe

Reviews: Hydrogen-Bonded Complexes of Phenylacetylene (G. N. Patwari et al.)
Minireviews: Spectroelectrochemistry of Carbon Nanotubes (L. Kavan and L. Dunsch), Molecular Adsorbates at Bimetallic Surfaces (H. Baltruschat and S. Ernst)

2011
C
IYC 2011
International Year of
CHEMISTRY

WILEY-VCH

www.chemphyschem.org

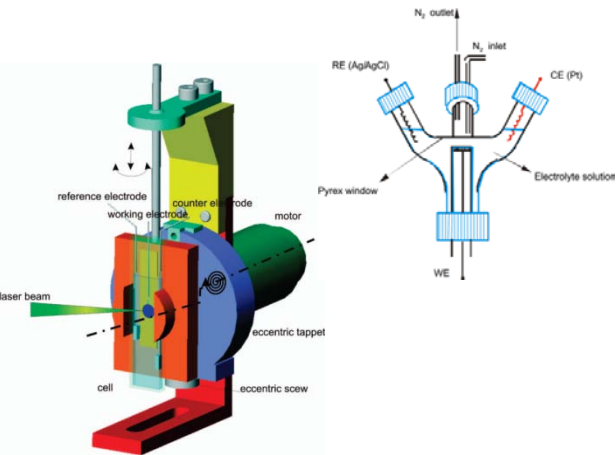

7/2007

Review: Spectroelectrochemistry of Carbon Nanostructures (L. Kavan)
Minireview: Mechanical Properties of Carbon Nanomaterials (T. Hayashi)

TOPICAL ISSUE
Carbon
Nanomaterials

WILEY-VCH
BICENTENNIAL
1807
WILEY
2007
BICENTENNIAL