

Annual Report 2010

**Association
EURATOM / IPP.CR**

INSTITUTE OF PLASMA PHYSICS, v.v.i.
ACADEMY OF SCIENCES OF THE CZECH REPUBLIC

TABLE OF CONTENTS

PREFACE.....	6
I. RESEARCH UNIT.....	7
1. ASSOCIATION EURATOM/IPP.CR.....	7
2. MANPOWER AND BUDGET	9
II. OVERVIEW OF ACTIVITIES.....	11
III. GENERATED INFORMATION AND INTELLECTUAL PROPERTY	31
1. PUBLICATIONS	31
2. INTELLECTUAL PROPERTY	41
IV. REPORTS	42
1. PROVISION OF SUPPORT TO THE ADVANCEMENT OF THE ITER PHYSICS BASIS	42
<i>Role of edge plasma parameters connected with atomic physics in L-H transitions on the</i> <i>COMPASS tokamak</i>	42
<i>Development of U-probe for study of filamentary structures in the COMPASS edge plasmas ..</i>	44
<i>ESEL developments.....</i>	46
<i>EFIT++ development.....</i>	48
<i>Investigation of interactions of perturbation field with plasma.....</i>	50
<i>Magnetic perturbations for runaway electron mitigation.....</i>	52
<i>Erosion, transport and deposition of low-Z wall materials</i>	54
<i>PIC study of plasma fluxes falling in castellated gaps between tiles.....</i>	56
<i>Development of the 3D PIC code for modelling of intersecting gaps.....</i>	58
<i>Combined SPICE2/3DGAP simulations of carbon deposition in divertor gaps.....</i>	60
<i>Edge2d modeling of ponderomotive density depletion in front of the JET LH grill</i>	62
<i>Comparison of fast electron fluxes generated in front of Passive-Active and Fully-Active</i> <i>Multijunction LH antennas in Tore Supra</i>	64
<i>Data analyses for neutron diagnostics at JET using Minimum Fisher Regularisation</i>	66
2. DEVELOPMENT OF PLASMA AUXILIARY SYSTEMS	68
<i>Commissioning of the neutral beam injectors for COMPASS tokamak.....</i>	68
<i>Simulations of secondary electron generation in the tokamak SOL</i>	71
<i>Atomic Beam Probe system for COMPASS</i>	74
<i>Electrostatic Probes in COMPASS.....</i>	76

<i>Re-installation of two reciprocating manipulators for Compass SOL studies</i>	78
<i>Development of millimeter-wave reflectometry methods for the measurement of edge pedestal plasma in tokamak COMPASS</i>	80
<i>Beam Emission Spectroscopy system for COMPASS</i>	82
<i>Minimum Fisher Regularisation in fast tomography</i>	84
<i>Development of fast tomography systems based on fast bolometric and SXR arrays for COMPASS</i>	86
<i>Development of fast tomography system based on photodiode arrays for visible radiation measurements for COMPASS</i>	88
<i>Laser part of the Thomson scattering system</i>	90
<i>Detection of the Thomson scattering signal</i>	92
<i>Data acquisition of the Thomson scattering system</i>	94
<i>COMPASS CODAC system and real time feedback</i>	96
<i>Personnel protection during operation of Thomson scattering laser system</i>	98
3. DEVELOPMENT OF CONCEPT IMPROVEMENTS AND ADVANCES IN FUNDAMENTAL UNDERSTANDING OF FUSION PLASMAS.....	100
<i>EBW heating and current drive simulations for spherical tokamaks</i>	100
<i>EBW simulations for WEGA</i>	102
<i>Detection of EBW emission on COMPASS</i>	103
4. EMERGING TECHNOLOGIES	105
<i>Irradiation tests of ITER candidate Hall sensors using two types of neutron spectra</i>	105
<i>Influence of neutron irradiation on the properties of candidate fusion materials</i>	107
<i>Development of tungsten-based functional gradient materials prepared using powder laser deposition</i>	109
<i>Study of the micro-mechanisms of cleavage fracture of 14% Cr ODS ferritic steels</i>	111
<i>Fatigue of ODS steels at room and high temperatures</i>	113
5. TRAINING AND CAREER DEVELOPMENT	115
<i>Collective training of young engineers and scientists</i>	115
<i>Practical Training on tokamak operation</i>	118
<i>Collaboration with French engineering school ENSAM</i>	119
<i>Collaboration with Czech Universities and FUSENET</i>	121
<i>Undergraduate and postgraduate studies in Fusion Science and Technology</i>	122
6. OTHER ACTIVITIES CONTRIBUTING TO THE EURATOM FUSION PROGRAMME	123
<i>Outreach and Public Information Activities</i>	123
7. COORDINATION, IN THE CONTEXT OF A KEEP-IN-TOUCH ACTIVITY, OF THE MEMBER STATE'S CIVIL RESEARCH ACTIVITIES ON INERTIAL FUSION ENERGY	126
<i>Dense plasma acceleration in LICPA guns</i>	126

V. ADDITIONAL INFORMATION	128
WORK FOR EUROPEAN JOINT UNDERTAKING FOR ITER AND DEVELOPMENT OF FUSION ENERGY (F4E)	128
<i>Conceptual design development of Test Blanket Module's Pb-Li Ancillary System and Tritium Extraction Unit.....</i>	<i>128</i>
<i>In-pile and out-of-pile testing of Primary First Wall mock-ups.....</i>	<i>131</i>

PREFACE

The Association EURATOM/IPP.CR participates in the joint European and worldwide effort in mastering controlled fusion by carrying out relevant plasma physics and technology R&D, including participation in JET and other European devices and activities related to the international fusion experiment ITER. This report summarizes the main activities and achievements of our Association in 2010.

The Association was founded on December 22, 1999 through a contract between the European Atomic Energy Community (EURATOM) represented by the European Commission, and the Institute of Plasma Physics, v. v. i., Academy of Sciences of the Czech Republic (IPP). In the course of time, several other institutions have been included in the Research Unit to contribute to the work programme in physics and technology research:

- Faculty of Mathematics and Physics, Charles University in Prague
- Institute of Physical Chemistry, v. v. i., Academy of Sciences of the Czech Republic
- Faculty of Nuclear Science and Physical Engineering, Czech Technical University
- Nuclear Physics Institute, v. v. i., Academy of Sciences of the Czech Republic
- Nuclear Research Institute in Rez, Plc
- Institute of Applied Mechanics, Brno, Ltd
- Institute of Physics of Materials, v. v. i., Academy of Sciences of the Czech Republic

The total effort expended on the Association's fusion research, measured in person years, as well as the overall 2010 expenditure have slightly decreased, compared to the previous year. This is mostly connected with the progress in the reinstallation of the COMPASS tokamak, as witnessed also by a reduction of the technical staff in favour of physicists. While this report contains also information about the work done for Fusion for Energy (European Joint Undertaking for ITER and Development of Fusion Energy), the related manpower and expenditure is not entered into the totals as this work is not supported through the Contract of Association.

The preferentially supported project "COMPASS to Prague" with a full title "Enabling a programme of ITER relevant plasma studies by transferring and installing COMPASS-D to the Institute of Plasma Physics AS CR, Association EURATOM-IPP.CR" was formally completed in 2010 by the delivery and successful tests of two neutral beam injectors, procured from the renowned Budker Institute of Nuclear Physics of the Russian Academy of Sciences. The two 300 kW injectors will be able to inject beams to the plasma in the same direction (maximising the heating effect), or in opposite directions (balancing the force momentum on the plasma, i.e. keeping the plasma rotation very low). This feature will considerably increase the range of the problems studied. Bringing the machine to a "production stage" will still require a lot of effort from both our staff and our collaborators from other European Associations (HAS, IST, CCFE, INRNE, IPPLM, and others) in the next year but we expect the machine to be ready for physics experiments in the fall of 2011.

Another point to be highlighted is an increased interest of students in fusion research – ten new students have subscribed to the curriculum "Physics and Technology of Thermonuclear Fusion" (Faculty of Nuclear Sciences and Physical Engineering of the Czech Technical University), making a total of 30 students. This gives a hope that we will be able to contribute significantly to the "Generation ITER", so vital for the success of fusion in the coming decades.

Pavol Pavlo
Head of Research Unit
Association EURATOM/IPP.CR

I

RESEARCH UNIT

1 Association EURATOM/IPP.CR

Composition of the Research Unit in 2009

IPP Institute of Plasma Physics, v.v.i.,
Academy of Sciences of the CR
Address: Za Slovankou 3,
182 00 Praha 8, Czech Republic
Tel: +420 286 890 450
Fax: +420 286 586 389
Contact Person: Jan Stöckel
e-mail: stockel@ipp.cas.cz

FMP Faculty of Mathematics and Physics,
Charles University
Address: V Holešovičkách 2,
182 00 Praha 8, Czech Republic
Tel: +420 221 912 305
Fax: +420 221 912 332
Contact person: Milan Tichý
tichy@mbx.troja.mff.cuni.cz

JHIPC J Heyrovský Institute of Physical
Chemistry, v.v.i., Academy of
Sciences of the CR
Address: Dolejškova 3,
182 23 Praha 8, Czech Republic
Tel: +420 266 053 514
Fax: +420 286 582 307
Contact person: Zdeněk Herman
zdenek.herman@jh-inst.cas.cz

FNSPE Faculty of Nuclear Science and
Physical Engineering,
Czech Technical University
Address: Břehová 7,
115 19 Praha 1, Czech Republic
Tel: +420 224 358 296
Fax: +420 222 320 862
Contact person: Vojtěch Svoboda
svoboda@br.fjfi.cvut.cz

NPI Institute of Nuclear Physics, v.v.i.,
Academy of Sciences of the CR
Address: 250 68 Řež, Czech Republic
Tel: +420 266 172 105 (3506)
Fax: +420 220 941 130
Contact person: Pavel Bém
e-mail: bem@ujf.cas.cz

NRI Nuclear Research Institute Plc., Řež
Address: 250 68 Řež, Czech Republic
Tel: +420 266 172 453
Fax: +420 266 172 045
Contact person: Karel Šplíchal
e-mail: spl@ujv.cz

IAM Institute of Applied Mechanics Brno,
Ltd.
Address: Veveří 85,
611 00 Brno, CR
Phone: +420 541 321 291
Fax: +420 541 211 189
Contact person: Lubomír Junek
e-mail: junekl@uam.cz

IPM Institute of Physics of Materials, v.v.i.,
Academy of Sciences of the CR
Address: Žitkova 22, 616 62 Brno,
Czech Republic
Tel: +420 5 322 90 379
Fax: +420 5 412 18 657
Contact person: Tomáš Kruml
e-mail: kruml@ipm.cz

Steering Committee

EURATOM

Yvan Capouet, Unit J4, DG RTD
(Douglas Bartlett, Unit J4, DG RTD, alternate)
Steven Booth, Unit J4, DG RTD
Eduard Rille, Unit J3, DG RTD

Head of Research Unit

Pavol Pavlo

IPP.CR

Ivan Wilhelm (Ministry of Education, Youth and
Sports)
Petr Křenek (Institute of Plasma Physics)
Pavel Chráska (Institute of Plasma Physics)

Secretary of the SC

Jan Mlynář

International Board of Advisors of the Association EURATOM/IPP.CR

Prof. Hardo Bruhns	Chair
Dr. Carlos Hidalgo	CIEMAT, Madrid, Spain
Dr. Jochen Linke	Forschungszentrum Jülich GmbH, Jülich, Germany
Dr. Bernard Saoutic	CEA Cadarache, France
Prof. Fernando Serra	Centro de Fusao Nuclear, Lisboa, Portugal
Dr. Wolfgang Suttrop	Max-Planck-Institut für Plasmaphysik (IPP), Garching, Germany
Dr. Martin Valovič	UKAEA Fusion, Culham Science Centre, United Kingdom
Prof. Guido Van Oost	Ghent University, Gent, Belgium
Dr. Henri Weisen	EPFL, Lausanne, Switzerland
Dr. Sandor Zoletnik	RMKI KFKI, Budapest, Hungary

The Board was established to help with the formulation of scientific program, and to assess the scientific achievements of the Association EURATOM-IPP.CR.

Representatives of the Association IPP.CR in Committees and Bodies

STC - Science and Technology Committee EURATOM

Pavel Chráska Institute of Plasma Physics, Academy of Sciences of the Czech Republic

Consultative Committee for the EURATOM Specific Programme on Nuclear Energy Research – Fusion

Milan Tichý Faculty of Mathematics and Physics, Charles University, Prague
Pavol Pavlo Institute of Plasma Physics, Academy of Sciences of the Czech Republic

EFDA Steering Committee

Pavol Pavlo Institute of Plasma Physics, Academy of Sciences of the Czech Republic
Radomír Pánek Institute of Plasma Physics, Academy of Sciences of the Czech Republic

Governing Board of Fusion for Energy

Pavol Pavlo Institute of Plasma Physics, Academy of Sciences of the Czech Republic
Jan Kysela Nuclear Research Institute pls., Řež

2 Manpower and Budget

Manpower Analysis of the Association EURATOM/IPP.CR in 2010

Institution	STAFF, PY	STAFF, Person					
		Female	Male	Prof.	Non-Prof.	TOTAL	Total, %
IPP	36.90	9	49	48	10	58	88.8
FMP	0.70	0	3	3	0	3	1.7
JHIPC	1.00	0	1	1	0	1	2.4
FNSPE	0.35	0	3	2	1	3	0.8
IPM	2.60	0	9	9	0	9	6.3
NRI*)	0.00	0	0	0	0	0	0.0
NPI*)	0.00	0	0	0	0	0	0.0
IAM*)	0.00	0	0	0	0	0	0.0
TOTAL	41.55	9	65	63	11	74	100.0
Total, %		12.2	87.8	85.1	14.9	100.0	

*) These institutions are now involved in the European fusion programme directly through Fusion for Energy (not under the Contract of Association).

Expenditures in 2010

	Euro
Physics	1 379 689
JET Notifications	0
Operational cost of major facilities	521 202
Coordination, in the context of a keep-in-touch activity, of the Member State's civil research activities on Inertial Fusion Energy	9 241
Sub-total	1 910 132
Large Devices	640 694
Specific Co-operative actions 8.2a	(43 360)
Specific Co-operative actions 8.2b	12 846
JET S/T Task (EFDA Art. 6.3)	0
Fellowship contracts	50 815
Sub-total	63 661
TOTAL	2 614 487
Mobility Actions	82 542



Two neutral beam injectors with 300 kW power arrived to Prague from Novosibirsk, Budker Institute, on the 10th of November, and successfully passed all tests on the 23rd December 2010.



Number of students enrolling fusion courses increases in IPP.CR, as well as their integration into international programmes. Left, tokamak GOLEM which won a FUSENET grant for support of student practica in 2010. Right, students visiting the GOLEM tokamak.

II

OVERVIEW

In accordance with the EFDA planning, the main areas of the research in the Association EURATOM/IPP.CR in 2010 were as follows:

1. Provision of Support to the Advancements of the ITER Physics Basis
2. Development of Plasma Auxiliary Systems
3. Development of Concept Improvements and Advances
in Fundamental Understanding of Fusion Plasmas
4. Emerging technologies

In this part of the 2010 Annual report of the Association EURATOM/IPP.CR the most important results, activities and achievements are briefly summarised. The principal investigators of the tasks are from the Institute of Plasma Physics AS CR, v.v.i., if not stated otherwise. Detailed reports of the main contributions can be found in Part IV. Notice that the decisive part of the Association activities in Physics relies on broad collaboration with other EURATOM Associations. Besides, in Part V we provide information on work in the Association for ITER and F4E.

1. Provision of support to the advancement of the ITER Physics Basis

1.2 Energy and particle confinement/ transport

L-H transition physics

L-H power threshold and ELM control techniques [WP10-TRA-01-04].

Principal Investigator: R. Pánek

The L-H power threshold and ELM control technique can be studied on COMPASS during its operation in the H-mode regime. However, due to necessary changes in the design of power supplies for feedback control of the plasma position revealed during their commissioning, the H-mode is planned to be generated in middle of 2011. Therefore, the study will be performed at the end of 2011.

Role of multi-scale mechanism [WP10-TRA-01-02].

Principal Investigator: J. Horáček

The milestones - design and build optimised two probe heads to sustain high heat flux. reciprocate inside pedestal during L-H transition.- were quite ambitious with the current equipment. In 2010, two BSc thesis were supervised on this topic subtasks. First, "Reinstallation of two reciprocating probes on COMPASS" [11] describes both probes geometry, control and vacuum systems and electronics. Second, we developed a heat conduction model originally suited for designing a reciprocating probe head capable of sustaining high heat fluxes in the pedestal. This model was later used for ITER divertor target tiles temperature calculation [A. Wolff, Bachelor thesis, February 2011, Czech Tech. Uni. FJFI], however, it was found too simplistic for the original purpose. The project continues in 2011 (milestones: heat conduction calculation, PPCF paper on the probe design, material choice, probe head construction). After successful first test in plasma, we expect first measurement in the H-mode pedestal by the end of 2012 with those milestones: construction

of the second probe head, searching for reproducible L-H transition, secure and simultaneous reciprocation movements.

Ref.: [10, 11, 12, 14, 98, 99, 101, 102]

Hysteresis L-H versus H-L transition [WP10-TRA-01-05].

Principal Investigator: M. Hron

The L-H / H-L transition hysteresis should be a part of the H-mode, pedestal, and edge plasma studies planned for experiments on COMPASS in 2010.

The edge plasma, shall be observed by Lithium beam emission spectroscopy, High Resolution Thomson Scattering, microwave reflectometer, and several electrostatic and magnetic probes mounted on reciprocating drives and fixed manipulators.

However, the fast feedback power supply construction became delayed, which disallowed achieving the stable plasma conditions and the H mode transition.

From the necessary diagnostics, the electrostatic and magnetic probes are available. The other required diagnostics will be available in near future: the Lithium beam was tested in the Association HAS and it is being assembled at IPP Prague. The Thomson scattering diagnostic approaches the test operation phase. The microwave reflectometer shall be tested in the Association IST.

Due to the above indicated shortcomings, the programme was not fulfilled. At the present status of the fast feedback power supplies and of the diagnostics development, we expect the H-mode operation and first systematic measurements of the L-H transition phase should be possible during the second half of 2011. However, the related EFDA task has finished.

Pedestal physics

Pedestal width physics [WP10-TRA-01-03].

Principal Investigator: R. Pánek

Preparative work to perform high resolution pedestal measurement has been started. The necessary diagnostics is being finished (HR Thomson Scattering, Beam Emission Spectroscopy, edge reflectometer) and will become operational in 2011. The H-mode will be generated in second half of 2011, which will allow to perform the first measurements.

Role of edge plasma parameters connected with atomic physics in L-H transition on the COMPASS tokamak [WP10-TRA-01-06]

Principal Investigator: V. Weinzettl

The multi-channel system for visible light observations has been designed to be composed from two independent 37-channel observation parts located in the angular port plugs at the same poloidal cross-section. The port plugs has been manufactured and both objectives located inside were successfully tested in the laboratory in 2010. The total field of view of each objective was measured to be of about 110° for a set of 37 fibers ensuring a desired spatial resolution on plasma better than 1 cm. The necessary fiber optics including multi-channel terminations for connections of the objectives and detectors have been purchased and tested in the laboratory. The multichannel detector connected to the amplifier was successfully tested in the laboratory and cross-talks between neighbor channels were estimated. Additionally, the new minispectrometer from Ocean Optics for near UV/visible spectral range and new photomultiplier tubes were purchased in 2010.

Ref.: [52, 89, 90, 91, 97, 106]

*ELM physics & ELM's mitigation***Commissioning and optimization of the RMP system in COMPASS [WP10-TRA-01-04]****Principal Investigator:** R. Pánek

The work on commissioning of $n=2$ RMP coils is in progress. New high current flexible cables have been procured and design of the new reconnection scheme has been proposed. The new power supply for the RMP coils were assumed to be based on the modules used for the fast transistor amplifiers for the plasma positional feedback system provided by IST Lisbon. However, due to unsolvable problems revealed during their tests, the project had to be canceled and new design has been started. This problems delay also manufacturing of power supplies for the RMP coils. Therefore, the construction of these amplifiers is postponed for 2011

Ref.: [64]

*Edge turbulence***Tests and exploitation of Hall probe based systems on tokamak JET (EP2 project) and on stellarator TJ-II [partly WP10-DIA-03-02].****Principal Investigator:** I. Duran

Use of various configurations of flux loops for measurement of magnetic field in fusion devices is inherently limited by the pulsed operation of these machines. A principally new diagnostic method must be developed to complement the magnetic measurements in true steady state regime of operation of fusion reactor. One of the options is the use of diagnostics based on Hall sensors. Two experiments dedicated to testing of various types of Hall probes are being conducted on JET and TJ-II with participation of IPP.CR.

A system of six 3D ex-vessel Hall effect based probe heads, developed by MSL Lviv Ukraine, was successfully commissioned on JET within EP2 project RHP. During the initial several months of operation, this diagnostic showed excellent performance meeting the target requirements. The RHP project is in its concluding stage. Additionally, a combined probe head containing magnetic and electrostatic probes (magnetic part was developed in IPP.CR) was put in operation on TJ-II. Good agreement between the quasi-DC component of the magnetic field, measured by Hall probes, and the theoretical model being used on TJ-II was achieved.

Ref.: [88]

Investigation of the radial particle flux by using direct measurements of V_{pl} and development of the novel method for the fast ion temperature measurements by using Ball-pen probes(BPP) on ASDEX Upgrade and COMPASS [WP10-TRA-05-02].**Principal Investigator:** J. Adámek

We have performed the measurements of the ion temperature and the radial particle flux by using BPP head on ASDEX Upgrade in December 2010. The first part, 4 dedicated shots, were devoted to the ion temperature measurements using the swept BPP with frequency $f=50\text{kHz}$ during L-mode and H-mode discharges. The first data analysis shows the sweeping frequency 50kHz is too low to observe the ion temperature fluctuations during L-mode discharge. However, the radial profile of the T_i gives a reasonable values. The sweeping technique is not suitable for the ELMs investigations, because the plasma potential during ELM event can reach the maximum of the sweeping voltage(+200V). The detailed analysis of the T_i measurements will be presented on 38EPS 2011. The further measurements of the T_i must be performed by three BPPs (triple-BPP) working in DC regime instead of one swept BPP to improve time resolution. The results of the radial particle flux are also expected soon.

The first experimental campaign on tokamak COMPASS were performed during Summer. We have measured the plasma and floating potential with the BPP head from AUG. However, the probe head was fixed during the whole shots. The plasma was not stable and therefore, these results are not yet systematic.

Ref.: [10, 12, 101, 102]

Development of U-probe [WP10-TRA-05-01].

Principal Investigator: K. Kovařík

A complex electrostatic-magnetic probe diagnostics, baptized as ‘U-probe’, is being prepared for measurement of properties of the filamentary structures in the edge plasmas of COMPASS tokamak. Probe will be composed of two identical towers. Each tower will house 3 sets of 3D coils, balanced triple probe and six single Langmuir probes each. The design of the probe is based on that of U-probe used on RFX-mod and uses experience from our combined electromagnetic probe operated at TJ-II [88]. This new COMPASS diagnostic will measure vorticity and longitudinal electric current of the plasma filaments. Analysis of the properties and, particularly, the correlation between filament vorticity and its current is expected to shed light into physics of filamentary structures in the tokamak plasma edge.

Ref.: [88]

ESEL development [WP10-TRA-05-03].

Principal Investigator: J. Seidl

Time evolving cross-field fluxes computed by 2D ESEL model were provided as an input to the parallel code SOLF1D and its behavior was tested under this strong forcing. Parallel transport induced in the SOLF1D as a reaction on the forcing was compared with simplified parallel transport model currently used in ESEL, showing that ESEL strongly underestimates parallel losses of density, which may result in disagreement with experimental observations [67, 110]. Statistical analysis of the parallel response on turbulent fluctuations was done, showing that the steady-state description of parallel transport often used in present-day transport codes may introduce a significant error due to strong nonlinearities of fluctuating quantities [15, 110].

SOLF1D does not compute parallel transport of vorticity, therefore different analytical approximations of vorticity damping were tested in ESEL, showing significant influence on simulated plasma behavior in SOL [12,98]. Moreover, in the regime of low collisionality, the radial fluxes going through the separatrix into the SOL are being overestimated in the ESEL, which indicates that there is some physics missing in the region of closed fieldlines. Since the impact on plasma behavior in SOL may be comparable with inaccuracy caused by underestimated parallel losses of vorticity and temperature, these issues need to be solved first, before final coupling of SOLF1D with ESEL.

By investigating difference in plasma and floating potential in ESEL it was shown [14] that experimental determination of fluctuations of electrical fields by measuring floating potential yields significant error, which was verified also experimentally by direct measurement of fluctuating plasma potential [10,12].

Investigation of behavior of particles with non-negligible Larmor radius in a turbulent field produced by ESEL was started [66].

Ref.: [10, 12, 14, 15, 66, 67, 98, 110]

1.3 MHD stability and plasma control

Development of relevant codes

EFIT++ development [TF-ITM-IMP1].

Principal Investigator: J. Havlíček

The EFIT++ code development carried out by IPP Prague consists of implementation of a computational model to represent the induced currents in the passive structures of the tokamaks. The status of the induced currents model is that the model was implemented into C++ and incorporated into the EFIT++ code. The model is in the testing phase. The comparison of currents computed by this model with previously used INDUCTION module, which is routinely used on MAST in CCFE, shows several discrepancies. Work remains to complete benchmarking against the INDUCTION code, and to optimize its operation. The work planned for the year 2010 was postponed due to unexpected problems in commissioning of COMPASS Fast Amplifiers for plasma position stabilization. The contributor's effort was reallocated to solve the problems. The milestones (1. development of robust operational scenarios of EFIT++ for COMPASS, 2. use reconstructed equilibria to optimize COMPASS vertical plasma position control algorithm) were not fulfilled due to the fact that COMPASS didn't have functional plasma position stabilization. It is supposed that the work on the benchmarking the new induced currents model against the INDUCTION code will be performed in the year 2011.

Modelling of ergodization

Investigation of interactions of perturbation field with plasma.

Principal Investigator: P. Cahyna

The model of perturbation screening has been applied to the JET, MAST and COMPASS cases. For JET and MAST, it was found that screening substantially reduces the strike point splitting observed in the presence of perturbations. This agrees with the fact that the splitting is on JET and MAST observed only in L-mode, not in H-mode where the screening is expected to play a major role. The agreement with the experimental results indicates that a substantial screening is indeed present. For COMPASS, we don't have experimental results yet, but the results of modelling are used to design the divertor probe arrays which we plan to use to detect the divertor footprints. The nonlinear reduced MHD code RMHD is used to predict the screening coefficient. A detailed scan of resonant surface positions for DIII-D data was performed using RMHD and it was found that for most positions the perturbation is screened, except for positions where the total perpendicular velocity of electrons is zero.

In the MAST experiments we however observed that even and odd configurations of the perturbation field produce very different results, while vacuum modelling and our resonant model of screening predict that they should have the same impact. This disagreement points to another mechanism of plasma response. We obtained only one experimental session due to the MAST schedule, so the experiments should be repeated and the effect investigated in more detail next year.

Ref.: [64, 65, 113]

Study of the diffusion of particles in an ergodic layer given by a system of magnetic islands and generation of radial electric field

Principal Investigator: L. Krlín

To estimate the generation of radial electric field, caused by the anomalous diffusion of particles, a new 3D PIC code is prepared.

Since the effect of the ergodic layer on the particles diffusion can be influenced by the edge tokamak electrostatic turbulence potencial, the model of complex effect of the ergodic layer and of the generated turbulent potencial is discussed. There appears regimes, where the effect of the ergodic layer can be shadowed by the turbulent potencial.

Ref.: [52, 53]

Runaway electrons

Magnetic perturbations for runaway electron mitigation.

Principal Investigator: P. Cahyna

We developed a code for runaway electron orbits in the presence of magnetic perturbations. The simulations for JET discharges where the mitigation of runaway electrons was actually attempted showed that the used Error Field Correction Coils (EFCCs) and toroidal field ripple do not cause a diffusion of runaway electrons and thus no effect is expected. This agrees with the negative experimental results.

Ref.: [63, 73, 113]

1.4 Power and particle exhaust, plasma-wall interaction

Interaction of hydrocarbon ions with the first wall elements

Interaction of hydrocarbon ions with the first wall elements [WP10-PWI-04-04]

Principal Investigator: Z. Herman, J Heyrovsky Institute of Physical Chemistry AS CR

Surface-induced interactions of seeding gas projectile ions Ar⁺ and hydrocarbon ions CD₃⁺, CD₄⁺, C₂D₂⁺, C₂D₄⁺, C₂D₅⁺, C₂D₆⁺ with room-temperature (hydrocarbon-covered) surfaces of carbon-fibre-composite (CFC) were investigated over the incident energy range from a few eV up to about 100 eV. With Ar⁺, sputtered hydrocarbon ions and K⁺ and Na⁺ were observed. With the hydrocarbon ions, sputtered ions (including K⁺ and Na⁺) as well as products of fragmentation of the projectile ion and chemical reactions between the projectile ions and surface material were observed.

Ref.: [94]

Modelling of heat loads of divertor plates on ITER

Study of plasma and power fluxes in castellated gaps between tiles [WP10-PWI-04-03]

Principal Investigator: R. Dejarnac

Particle and power fluxes are studied in the vicinity of gaps between divertor tiles using an in-house 2D particle-in-cell code. The effect of changes in the orientation of the gap with respect to the magnetic field direction is studied for optimising the total ion flux falling into the gap and results have been presented in [72]. The power load falling onto the protruding part of a gap edge due to misalignment is also investigated for ITER strong transient plasma conditions and the temporal evolution of the whole monoblock temperature due to this transient, high heat flux is also calculated. The results of the computations show that the power deposited to the protruding edges is lower than the one expected without taking into account particle orbits [72]. Concerning the tile heating, spatial profiles of the power fluxes falling on an ITER divertor tile, as well as the temporal evolution, were taken from [71] and used as input

parameters in an in-house 3D matlab code that calculates the temperature evolution of the entire tile. Two tile materials have been simulated, carbon and tungsten. Results show that the erosion of the tile due to sublimation is not significant in the case of carbon and that the melting temperature is not reached in the case of tungsten for 4MJ ELMs.

Ref.: [71, 72]

Development of the 3D PIC code for modelling of intersecting gaps.

Principal Investigator: M. Komm

The particle-in-cell simulations of gaps between castellated plasma-facing components allow to predict heat loads on divertor tiles in ITER. This topic was already targeted by means of 2D simulations (SPICE2 code) but these required the poloidal and toroidal gaps to be simulated separately. The presence of gap crossings in real PFCs questioned the validity of these results, as important effects were expected to take place there.

In order to simulate plasma behaviour in the vicinity of a gap crossing, a new full 3D3V PIC code SPICE3 had to be developed. Although most of the routines were based on SPICE2 algorithms, the code had to be equipped with new Poisson solver and boundary checking algorithm. Special care had to be taken on optimization of the code, as 3D particle-in-cell simulations are extremely demanding on computing power.

The code was successfully benchmarked against SPICE2 and SPICYL codes and used to simulate the behaviour of the Katsumata probe [46].

The preliminary simulations of gaps revealed presence of electrons in plasma shadow of the poloidal gap, which is in contrary with 2D simulations and a clear consequence of the gap crossing. This has influence on the plasma penetration inside the gap. A hotspot with elevated heat flux was localised near the crossing.

Ref.: [46]

Combined SPICE2/3DGAP simulations of carbon deposition in divertor gaps.

Principal Investigator: M. Komm

Plasma penetration into gaps of castellated plasma-facing components is of interest because of the risk of fuel retention in ITER. Experiments show that carbon can form hydrocarbons layers with significant fuel content, once it is present inside the machine. The layers are deposited in shadowed areas of the vessel, which include gaps between the tiles of PFCs. In order to understand the carbon transport and layer formation, a neutral transport code 3D-GAPS has been developed at Forschungszentrum Juelich. The simulations involve a number of parameters (erosion probability, sticking probability etc), which are not known from experiment. The aim of the simulations is to find a match to experimental results by variation of the unknown parameters.

In order to make the simulations realistic, the distribution of particle flux coming from plasma has to be taken into account. This was simulated by using the 2D particle-in-cell code SPICE2. The simulations allow detailed study of the plasma behaviour in the vicinity of the gaps, namely the amount of particles entering the gap and the depth of plasma penetration. A series of simulations for typical TEXTOR conditions has been performed and the results have been used as input for the 3D-GAPS code [44].

The simulations revealed that plasma behavior can be in two different regimes: potential – and geometry-dominated with distinct profiles of plasma flux falling onto the sides of the gap. The shaped gaps are gaps with modified geometry, which protects the leading edge of the tile from direct plasma flow. A series of simulations with varying amount of shaping has been performed in order to estimate its effectiveness.

Ref.: [44]

1.5 Physics of plasma heating and current drive

Exploration of nonlinear effects near LH and ICRH antennas

Understanding of gas puff ionization effects in the SOL during LH heating, including ponderomotive force effects and SOL generated fast particle effects [WP10-HCD-01-03-05]

Principal Investigator: V. Petržílka

It was found that without taking into account the gas ionization in front of the grill mouth, the computed density in front of the grill can decrease significantly due to the ponderomotive depletion for launched LH powers of about 5 MW (about 20 MW/m²). However, the ponderomotive forces are not strong enough to expel the plasma from in front of the grill mouth, when the direct ionization by the LH wave is taken into account. Only for ponderomotive forces about ten times or more higher, the plasma density would decrease in front of the grill mouth even with the gas puff directly ionized there. Such strong expelling effects could be perhaps provided by locally in front of the grill generated fast electrons, which escape from the grill and create an electric field of charge separation, pushing ions from the locations in front of the grill mouth. The expelling effect of the fast particles needs to be accounted for in future modeling, but the way how to do this is not obvious. As ponderomotive density modulation effects can be less significant, when the direct LH ionization is taken into account, so it means that in conditions when the density increase due to direct LH SOL ionization is strong, the nonlinear high harmonic generation and consequent parasitic LH wave absorption due to non-linear fast electron generation in front of the grill mouth will be weaker. Milestones were reached.

Ref.: [21, 22, 23, 24, 25, 26, 27, 28, 93, 100, 103, 104, 105]

Further analysis and design of, and possibly participation in RFA experiments on Tore Supra, in which the fast particle beams generation in SOL by LH grill was and will be explored

Principal Investigator: V. Petržílka

We suggested experiment with aim to compare the intensity and other characteristics of the fast electron beam (like electron energy distribution and beam radial width) generated in front of the new ITER relevant passive active multijunction (PAM) lower hybrid wave launcher C4 in Tore Supra to what was previously observed with a full active multijunction (FAM) launcher C3 under similar experimental conditions. The comparison should allow estimates of C4 fast beam thermal loads based on previous FAM hot spots observations and on the measurements performed in frame of the proposal. Due mainly to problems of synchronization of the lower hybrid cooling system, much time was lost and only a few discharges were successfully completed. It is especially unfortunate that higher power levels could not be tested (we had planned to fire 2 MW per antenna). This is partly due to the lack of time available to increase the power, but also due to our choice of an unusual discharge scenario for which the antennas had not yet been conditioned. It should be noted that in the past, intense electron beams were observed with C2 firing 1.5 MW, which would be equivalent to 3 MW on C3 or C4. It would be useful to perform a few more shots to compare C3 and C4 in the standard magnetic configuration to guarantee good coupling conditions at high power. Milestones were reached.

Ref.: [21, 22, 23, 24, 25, 26, 27, 28, 93, 100, 103, 104, 105]

1.6 Energetic particle physics

Data analyses for neutron diagnostics at JET using Minimum Fisher Regularisation.

Principal Investigator: J. Mlynář

Completion and publication of the achieved results was in the main focus of the 2010 works. However, we have also achieved a considerable progress in replacement of the MatLab package of inversion algorithms by optimised Python algorithms, including the data acquisition routines and optimisation of the main algorithm. The JET experience in application of the inverse methods in tomography was reported in [6]. Experimental relation between transport parameters and dimensionless quantities were established and a new article on spatial properties of the tritium fuelling evolution put on pinboard. A new field of analyses relevant to the subtask was introduced, in particular studies of fast particle loss mechanisms via activation foils [7].

Ref.: [6, 7, 8]

2. Development of plasma auxiliary systems

2.1 Heating and current drive systems

NBI heating for COMPASS

Principal Investigator: J. Stöckel

Two Neutral Beam Injectors (NBI) will be used for additional plasma heating on the COMPASS tokamak. The beam energy is 40 keV and the total power 2x300 kW. The NBIs were manufactured at the Budker Institute, Novosibirsk, Russian Federation and transported to IPP Prague together with their power supplies. The two injectors were commissioned in IPP Prague *in situ* in the period mid of November – end of December. For the first tests, the NBI's were equipped by additional equipment, such as the pumping, cooling and gas handling systems. The neutral beam was fired into a calorimeter. The first tests show quite promising results. The full energy (40 keV), the expected ion current (12 kA) and an efficiency of neutralization (~70%) were achieved in the pulse length 100 ms. Some modifications of power supplies and prolongation of the beam pulse up to 300 ms will be performed at the beginning of the year 2011.

LHCD for COMPASS

Principal Investigator: V. Fuchs

1) Some properties of LH-generated fast electrons in the SOL. Recent experiments [J. P. Gunn, et al., Radio Frequency Power in Plasmas, AIP Conference Proceedings, Vol. 1187, p.391 (2009)] during lower hybrid (LH) operation on Tore Supra revealed two distinct groups of fast electrons, according to their temporal behavior and radial location. At all radial positions reached by a retarding field analyzer (RFA) mounted at the top of the machine on a reciprocating manipulator, the recorded signal is intermittent, but at the LH grill mouth the fast electron signal has a steady DC component. Away from the grill mouth, only the intermittent signal survives. We have previously advanced the hypothesis [21, 23] that this nature of the fast electrons is associated with edge turbulence – blobs [21, 23] - propagating outward from the last closed flux surface (LCFS) around low field side mid-plane.

2) Simulations of secondary electron generation in the tokamak SOL

The role of secondary electron emission (s.e.e) caused by electron impact on plasma facing components (PFC) was investigated, in order to find an explanation for the systematic discrepancy between calculated and measured sheath characteristics. For the planned work we

used the previously developed quasineutral particle-in-cell code (QPIC) for simulating ion and electron transport along magnetic field lines in the Scrape off Layer (SOL) of the tokamak plasma edge. We introduced electron-electron collisions into QPIC, in order to enforce Maxwellisation of the electron distribution function in absence of interactions. Finally, we compared s.e.e. results from QPIC with results from a “standard” PIC code.

2.2 Plasma diagnostics

Edge plasma diagnostics

Atomic Beam Probe for the COMPASS Tokamak.

Principal Investigator: V. Weinzettl

Both the prototype of the Atomic Beam Probe and necessary vacuum interface were designed, manufactured and installed on the COMPASS tokamak. The prototype detector movable in vertical direction by 10 cm has 24+1 channels (4x5 detector segments, 4 Langmuir probes and one ground). On the air side, signal of each channel is amplified and then collected by the ABP data acquisition. Preliminary measurements without the lithium beam were performed to check level of background signal. The necessary lithium beam was completed and tested in December 2010 and its connection to the tokamak is scheduled in March 2011.

Ref.: [51, 106]

Electrostatic probes in COMPASS: the divertor Langmuir probes and a Tunnel probe for the fixed vertical manipulator.

Principal Investigator: R. Dejarnac

The COMPASS tokamak is planned to host a large set of different electrostatic probes. There is already a set of 39 Langmuir probes (LPs) in the divertor and since September 2010 one of the two reciprocating manipulators has been successfully installed. Those manipulators can hold different types of probe heads, like classical LPs or Ball-pen probes, as at present status, or Tunnel probes, triple probes, Mach probes, etc... in the near future. 2010 was the year of first serious measurements with probes in the divertor and on the manipulator at outboard mid-plane. New electronics for the divertor probes was developed in collaboration with the Bulgarian EURATOM association and it was tested in plasma conditions in COMPASS. From the physics point of view, the obtained data were analysed using the first derivative method to retrieve the electron energy distribution function and the plasma potential. These results were presented at the 24th Symposium on Plasma Physics and Technology in Prague, June 2010 [107] (proceedings to be published in *Atca Technica* journal). Comparative measurements between the different probes have also been performed to follow the not yet controlled plasma column movements. The relative position is coherent for all probe measurements and with the magnetic diagnostics as well. Concerning the future probes for COMPASS, like the Tunnel probe, a massive set of numerical simulations has been done to calibrate the probe. We used our dedicated in-house particle-in-cell code developed in collaboration with CEA Cadarache. Simulations have been compared to a commercial code which is less adapted to this purpose. The analysis of such a large number of simulations is in progress and will continue next year, as well as the final design of the probe.

Ref.: [107]

**Reinstallation of two reciprocating manipulators for Compass SOL studies
[WP08-TGS-01-06]****Principal Investigator:** J. Horáček

The horizontal probe has already successfully operated in plasma.

Due to both installation of NBI heating and COMPASS vacuum chamber cleaning, even though the vertical probe is fully ready, it is still waiting for installation and insertion into plasma.

Ref.: [11, 106]

Active Charge Exchange Recombination Spectroscopy with Heating Neutral Beam on tokamak COMPASS, Concept Design.**Principal Investigator:** V. Piffel

The subtask was cancelled in late 2009 due to financial reasons, however, in this period all significant aspects of potential of CXRS on COMPASS neutral beam were reviewed in high quality BSc thesis of J Krbec [45]. In conclusion, the diagnostics is feasible so that the project may be reconsidered in future.

Ref.: [45]

*Microwave reflectometry***Development of millimeter-wave reflectometry system for the measurement of edge pedestal plasma in tokamak COMPASS.****Principal Investigator:** J. Zajac

The reflectometry system consists of two parts which are developed separately. The first part are the microwave electronics and data acquisition, which will be provided by IPFN/IST. Because of the further delay, the planned term (end of 2010) was forwarded to about half of 2011. The second part are band-combiners and quasi-optical antennas (BCA), which are necessary to transmit and receive all five microwave channels (O-mode K, Ka, U and E frequency bands and one X-mode Ka frequency band). The provider of BCA is the Institute of Radiophysics and Electronics NAS of Ukraine (IRE NASU). This second part of the reflectometry system was delivered in planned term in summer 2010 and is ready for the operation.

Ref.: [40, 41, 106]

*Beam emission spectroscopy***Installation of the BES system on the COMPASS tokamak and first measurements.****Principal Investigator:** V. Weinzettl

The BES diagnostic [106] is under development in the frame of the contract with KFKI, Hungary. In order to enable simultaneous slow and fast BES measurements, it was decided to change the tokamak section for diagnostic beam and BES detection in 2010. The corresponding port plugs were reinstalled in early summer. In autumn, components of the lithium beam were transported to IPP Prague, set together and a Li beam generation was successfully tested (2 mA at 34 keV).

Ref.: [106]

Fast tomography

Minimum Fisher Regularisation in fast tomography

Principal Investigator: J. Mlynář

The designed setup of SXR diagnostics for tomography on COMPASS (under construction, see also WP10-DIA-02) was implemented into the existing Minimum Fisher Regularisation (MFR) code package (in MatLab) including real width of chords and expected magnetic flux surface geometry [43]. Optimised version MFR was also implemented during the planned 4 week mobility stay at Tore Supra and successfully commissioned. Capabilities to analyse fast transport due to magnetic field reconnection was demonstrated. Also at JET, interest in SXR data analyses increased due to the planned ITER-like wall characterisation. Therefore, JET SXR geometry was implemented into the Python version of the MFR algorithm (under development). Validation of the optimised MFR version for future applications on tokamak COMPASS was presented in [112].

Ref.: [6, 43, 112]

Development of fast tomography systems based on fast bolometric and SXR arrays for COMPASS.

Principal Investigator: V. Weinzettl

The tomographic diagnostic system based on multichannel bolometric and SXR arrays was completed and stepwise tested in real discharge conditions on the COMPASS tokamak. The correct grounding scheme was found limiting a strong parasitic signals originating in the tokamak energetics. The first measured signals showed radiation profile and its changes clearly indicate plasma column movements confirmed by magnetic diagnostics.

Ref.: [6, 52, 106]

Development of fast tomography system based on photodiode arrays for visible radiation measurements for COMPASS.

Principal Investigator: D. Naydenkova

The tomographic system has been designed to be composed from two independent 37-channel observation parts located at the same poloidal cross-section. The diagnostic port plugs has been successfully tested in the laboratory together with objectives located inside in 2010. The 35-channel detector connected to the fibre optic end-piece was successfully tested in the laboratory. The cross-talks between neighbour channels were estimated at less than 6%, the difference in light transmittance between channels was measured as approximately 10%. The HR2000+ spectrometer from Ocean Optics for 248-473 nm spectral range was purchased and the first spectra were recorded during tokamak shots in 2010.

Ref.: [52, 89, 90, 91, 97, 106]

Thomson scattering

Laser part of the Thomson scattering system.

Principal Investigator: P. Bílková

The lasers for COMPASS Thomson scattering system were delivered in September 2009. At the beginning of 2010, focusing the reduced energy beam was tested to specify the proper lens focal length [19, 29]. Based on present experience, minor upgrades of the test beam path were proposed.

Complex laser safety system was specified and designed during first half of the year and was installed in autumn.

The laser beam path [19, 29] to the tokamak installation started. Main holder in the tokamak area was installed, vacuum parts manufactured and tested. Temporary triggering system for the first test was proposed.

Ref.: [16, 17, 18, 19, 20, 29, 68, 69, 106]

Detection of the Thomson scattering system

Principal Investigator: P. Bílková

In the last quarter of 2010, remaining 9 spectrometers (polychromators) have been finished including all necessary tests [16, 17]. Problem with drivers for monochromator has been solved so that the experimental setup for spectral calibration was functional before the end of 2010. After the delivery of the core TS collection optics it has been installed. Fibers for both core and edge TS system have been placed into the tokamak area along 20 m long path and tested afterthat. Optical fibers for the core TS system have been assembled into the fiber holder and sharpened.

Ref.: [16, 17, 18, 19, 20, 29, 68, 69, 70, 106]

Data acquisition of the Thomson scattering system.

Principal Investigator: P. Bílková

System of fast ADCs has been tested after the delivery (fast skew measurements, check of required parameters). Labview software has been used to develop number of routines enabling easier and more time efficient setup and basic calibrations during assembly of 29 polychromators for the detection part of the TS system. Routines used on MAST for processing of TS data have been modified for COMPASS needs and tested. Issues for 2011 have been identified - Automatization of the whole data flow, including implementation of H5 saving format and Development of external triggering unit able to combine two external trigger into the one and, in the next step, development of triggering unit able to control lasers itself.

Ref.: [16, 17, 18, 19, 20, 29, 68, 69]

2.4 Real Time Measurement and Control

COMPASS CODAC system and real time feedback.

Principal Investigator: M. Hron

The A/D converters for the CODAC system were installed and commissioned on COMPASS. Function and noise level of individual channels were checked. It was found that the noise level was partly increased by wrong cabling (grounding of the data cables), which was fixed. However, the noise level still remains an issue to be followed. Moreover, the bandwidth of the ADCs is another issue to be followed: increase of the ADCs bandwidth would be highly desirable but must be carefully checked versus the possible noise level.

New 2GSPS ADC system for the Thomson scattering diagnostics was installed. However its implementation to the central system and database was postponed.

An electronic logbook was built and put in operation on COMPASS.

Ref.: [13, 31, 32, 33, 34, 35, 37, 38, 39]

COMPASS interlock system.

Principal Investigator: M. Hron

In the area of machine and personnel protection systems, a priority was given to an extension of the existing personnel protection system. This extension had to cover safety of operation of high-power Nd-YAG lasers used for the diagnostics based on the Thomson scattering effect. The Thomson scattering (TS) diagnostics is being built on COMPASS and a system

protecting the personnel was necessary to allow the test of this diagnostics during last quarter of 2010. Similarly to the general personnel protection system, the TS diagnostic personnel protection is based on an PLC. This system connects locks for the lasers operation, safety contacts on the laser path covers, laboratory doors, etc. Moreover, it must include several modes of operation (experiment, laser alignment, laser tests) thus reaching rather complex requirements to the design.

Ref.: [36]

Developments of new techniques for improved data acquisition and analysis

[WP10-DIA-05-01]

Principal Investigator: M. Hron

Data from each plasma pulse are currently stored in the COMPASS database and they are marked as a single event. Further development of this project was postponed and the priority was given to the fast feedback development. The reason is that without standard and stable tokamak shots the marking the data can not be marked and sorted accordingly to individual discharge events.

Ref.: [43]

3. Development of concept improvements and advances in fundamental understanding of fusion plasmas

3.4 Theory and modelling

AMR code development and benchmarking; EBW heating and current drive simulations for spherical tokamaks.

Principal Investigator: J. Urban

For several years we have been developing and applying a code for simulating electron Bernstein wave physics in tokamaks and stellarators. Our AMR (Antenna, Mode-conversion, Ray-tracing) code has recently been significantly improved and coupled with the LUKE Fokker-Planck code. In particular, AMR now includes various relativistic damping models and the AMR-LUKE two-way interface is very flexible and user-friendly. Besides our institute, the code is used at CRPP Lausanne, CCFE Culham, CEA Cadarache or PPPL.

The electron Bernstein wave (EBW) is typically the only wave in the electron cyclotron (EC) range that can be applied in spherical tokamaks (STs) for heating and current drive. EBWs seem to be the only option that can provide features similar to the EC waves, which are cutoff in STs—i.e., controllable localized heating and current drive that can be utilized for core plasma heating as well as for accurate plasma stabilization. EBW is a quasi-electrostatic wave that must be excited by a properly launched O- or X-mode; its propagation further inside the plasma is strongly influenced by the plasma parameters. These rather awkward properties make its application somewhat more difficult.

We are performing an extensive numerical study of EBW heating and current drive performance in four typical ST plasmas (NSTX L- and H-mode, MAST Upgrade, NHTX). Coupled ray-tracing (AMR) and Fokker-Planck (LUKE) calculations are employed to simulate EBWs of varying frequencies and launch conditions, which are the fundamental EBW parameters that can be chosen and controlled. Our results indicate that an efficient and universal EBW heating and current drive system is indeed viable. In particular, power can be deposited and current reasonably efficiently driven across the whole plasma radius. Such a system could be controlled by a suitably chosen launching antenna vertical position and would also be sufficiently robust.

Ref.: [3, 4, 108, 109]

Power deposition, current drive and ECE in stellarator WEGA.**Principal Investigator:** J. Preinhaelter

At present, WEGA discharges at 0.5 T can be exclusively sustained by electron Bernstein waves (EBWs) via the so called OXB heating scheme [1,2]. Our AMR code has already proved to be a well suited code for EBW physics on WEGA. We therefore applied this code to explain and interpret WEGA experimental results. Very interesting results are obtained during OXB WEGA experiments; extremely high ECE (EBE) temperature, $\sim 10 - 50$ keV (the plasma temperature is expected to be ~ 50 eV) during the OXB phase; sharply peaked ECE spectra around the heating frequency; fast electrons with $T_e \sim 10$ keV detected by X-ray diagnostics with total energy ~ 1 J. We formulated a hypothesis with a suprathermal electron population in the mode conversion region. Only waves whose mode conversion occurs at this layer can interact efficiently with the suprathermals; hence, the radial location of the layer determines the frequency that is absorbed or emitted by the suprathermals. The resulting emission spectrum has a sharp peak around the 28 GHz heating frequency, irrespective of the magnetic field, which is also observed in experiments.

Ref.: [1, 2]

Detection of EBW emission on COMPASS.**Principal Investigator:** J. Preinhaelter

During year 2010 we developed a new apparatus for the absolute calibration of the radiometer in the frequency range 26.5 – 40 GHz (Ka band). Unlike previously used method, this calibration uses the fast semiconductor PIN-switch for the waveguide switching. The new calibration is more accurate and the method was presented on the 18th Topical Conference on High-Temperature Plasma Diagnostics, USA (2010) [9]. Furthermore the radiation characteristics of used antenna and mirror in the Ka band were measured. Because the so far used mirror is quite small for the good quasi-optical characteristics, the new steerable mirror is being manufactured

Ref.: [9]

4. Emerging Technologies

4.1 Development of material science and advanced materials for DEMO

*Irradiation and thermal resistance of Hall probes and plasma facing materials***Development of Hall sensors for use within magnetic diagnostic of fusion reactors [partly WP10-DIA-03-02].****Principal Investigator:** I. Āuran

The first stage of irradiation tests of high temperature resistant semiconductor Hall sensors developed by Association EURATOM IPPLM, Poland was accomplished. The evaluation and testing of samples both from IPPLM and MSL Lviv, Ukraine irradiated in the late 2009 was performed. Publication of previously achieved results was done [86]. Evaluation of metallic Hall sensors for fusion reactor magnetometry proceeded by adopting the design concept based on copper directly bond on ceramic (DBC) substrates (commercially available) with the thin sensitive metallic layer deposited by magnetosputtering. Several samples of DBC substrates were acquired and preparation of sample Hall sensors is underway.

Ref.: [86]

*Development and testing of advanced materials (metals and ceramics)
for future reactor systems*

Irradiation and characterization of fusion-relevant materials.

Principal Investigator: J. Matějčíček

The irradiation was concluded in 2009. Majority of the samples were extracted from the irradiation capsules; some of them still remain enclosed due to complications with the extraction. Samples for thermal conductivity and heat flux characterization were transported to Forschungszentrum Juelich.

For the characterization of electrical properties, a special test rig was developed and built that permits resistivity measurements on active samples in hot cells. The measurement was verified on selected unirradiated samples and a very good agreement with the standard instrument was obtained. First measurements on irradiated stainless steel samples were performed; these showed the necessity of rig modification to ensure contact pressure stability in hot cells. The modification is underway.

Resistivity measurements on ceramic samples were performed in a controlled environment, using a guarded electrode method (ASTM D257-66). A decrease of resistivity several orders of magnitude was observed. Investigation of possible mechanisms is underway. Complex metallographic examination (including porosity, hardness and composition) of the un-irradiated glass-ceramic samples from Politecnico Torino has been performed, characterization of irradiated ones is underway.

As for the remaining samples, transport to Ciemat is under negotiation, pending successful extraction.

Ref.: [30]

**Development of W/Fe functional gradient materials using laser deposition
[WP10-MAT-WWALLOY-01]**

Principal Investigator: J. Matějčíček

Tungsten-steel composites and FGMs are being developed for potential application in plasma-facing components. Characterization includes SEM, EDX and thermal conductivity measurement.

The laser-sprayed layer consists of slightly melted tungsten microgranules immersed in a melted steel substrate. The height of a single layer rises up to 1.3 mm and can be varied by applying different laser-spraying conditions: feeding rate, scanning speed or regime of scanning. Homogenous continuous pore-free sample can be prepared by spraying just one single layer. Second layer (and further layers as well) consists of pure tungsten and it might include pores.

Two types of W powder were used (with power size less than 50 and more than 50 μm) in order to create gradient of W content.

Steel powder was successfully used for intermediate laser-sprayed layer preparation. Thermal conductivity of a single layer samples increases with applying after-treatment by a laser and/or annealing.

As an alternative concept, dense composites and FGM were produced by hot pressing. Plasma spraying with a hybrid torch and inert gas shrouding was initiated; first optimization for tungsten spraying was performed.

*Mechanical properties of advanced materials (metals and ceramics)
for future reactor systems*

Nano-structured ODS Ferritic Steel Development [WP2010- MAT-ODSFS]

Principal Investigator: H. Hadraba, Institute of Physics of Materials AS CR

The high-temperature embrittlement mechanism of the ferritic Fe-(12-14)Cr-(1-3)W-(0.1-0.5)Ti-(0.2-0.4)Y₂O₃ ODS steels is connected to the coarsening of the fine Y- and Ti-rich oxide particles. It was found that the Y-Ti-O particles in MA957 ODS steel coarse at temperatures higher than 900°C. Also the pronounced development of porosity in MA957 ODS steel was observed during annealing at temperatures higher than 900°C. It was also found that the shape of Cr-rich precipitates of M23C₆ type has a major role to the fracture behaviour of the ODS Eurofer'97 steel. There is relatively lack of data about behaviour of "large" precipitates (especially M23C₆ and MX carbides) coarsening and possible porosity development at the temperatures close to the proposed operational temperature (up to 650°C). The aim of this work was to study influence of long-term service embrittlement to the microstructure and impact fracture behaviour of the ODS steel of type MA957.

Low cycle fatigue behaviour of three steels with ultrafine grains and strengthened by fine oxide dispersion is studied at RT, 650°C and 750°C. It is shown that 14Cr ferritic steel produced at the EPFL has the highest strength but shorter fatigue life. 14CR ferritic steel produced in the CEA combines high strength and long fatigue life. The ODS Eurofer has lowest strength and suffers from cyclic softening at RT. The microstructure of as-received steels was studied using TEM. Surface relief formation and fatigue crack nucleation sites were observed by SEM. The differences in the fatigue behaviour are discussed with relation of their microstructure. The high strength of the EPFL steel with the bimodal grain size distribution is attributed to regions composed from very fine grains of 0.34 µm, while the large grains of ~3 µm are the origin of the important reduction of fatigue life due to easier fatigue crack nucleation.

Ref.: [95, 96, 114]

5. Training and career development

5.1 Collective training of young engineers and scientists

Conduct training of two young engineers within EODI and ENTICE projects

Responsible officer: I. Ďuran

IPP.CR participated in two European Fusion Training Scheme (EFTS) projects namely the European Network for Training Ion Cyclotron Engineers (ENTICE) and Engineering of Optical Diagnostics for ITER (EODI). Two young engineers, Alena Křivská for ENTICE and David Šesták for EODI, were hired by IPP Prague for 3 a 2 years periods respectively. Training was conducted in close collaboration with other Associations participating in the projects and also with ITER IT. Training of both trainees was successfully accomplished and they both remain in fusion also after termination of their EFTS contracts. David Šesták obtained permanent contract in IPP Prague and he is strongly involved in COMPASS related engineering activities. Alena Křivská continues her involvement in the field of numerical simulation of ICRH antenna using TOPICA code presently in ENEA Association in Italy under one year long temporal contract.

5.3 Training in laboratory experience, principles of data validation, analyses and interpretation, and presentation of results

International Summer Training Course (SUMTRAIC)

Responsible officer: J. Stöckel

The 8th Summer Training Course (SUMTRAIC 2010) was organized on the COMPASS tokamak in collaboration with the Association EURATOM/HAS in the period 22.8. - 3.9.2010. Before practical training, several introductory lectures have been presented. The Course was attended by 15 students from nine countries. Students were divided to five experimental groups supervised by local and Hungarian supervisors. Four days were devoted to experiments on the COMPASS tokamak, the remaining time was spent by data processing and preparation of presentation at the closing workshop.

Collaboration with the french engineering school "Ecole Nationale Superieure d'Arts et Metiers" (ENSAM).

Responsible officer: R. Dejarnac

In the frame of a collaboration with the Ecole Nationale Superieure des Arts et Metiers (ENSAM), a french engineering school, every year since 2009 we host at IPP Prague a couple of students for their 2nd year internship. Their main work is related to the conception of pieces/diagnostics for the COMPASS tokamak using the CATIA software. In 2010 we hosted two students for a period of 6 months each from the 17th of June to the 17th of December. Their work consisted in making 3D designs and providing technical drawings of several part of the tokamak and its associated diagnostics.

One worked on the design of a new probe to study plasma deposition inside a gap between tile. This probe will be use for dedicated experiments and had to be designed from the scratch. The other student worked on several projects like a telescope for the plasma rotation diagnostic and its supporting frame, a laser diaphragm for Thomson Scattering diagnostic and one part of the tokamak supporting structure.

Both of them also classified several hundreds of old technical drawings from the time when COMPASS was in Culham, UK.

Collaboration with Czech Universities and FUSENET

Responsible officer: J. Mlynář

In 2010 IPP continued in collaboration with Universities, including in particular Faculty of Nuclear Sciences and Physical Engineering (FNSPE) of the Czech Technical University in Prague, and Faculty of Mathematics and Physics (FMP) of the Charles University, both members of the Association EURATOM/IPP.CR. Our experts contributed mainly by giving lectures in several fusion-related courses and by training more than 30 students of all levels (bachelor, master and doctoral). Doctoral thesis by P Cahyna [113] was successfully completed and defended.

We have also devoted time for collaboration on application for Erasmus Mundus doctoral programme FUSION-DC and renewal of the master's fusion programme FUSION-EP with prof G van Oost (Univeristy Ghent). The latter, to which IPP.CR and FNSPE are Associate partners, was later accepted.

Last but not least FUSENET activities in Czech republic were coordinated including the mid-term reporting period in April and participation in the WP7 Review Board.

Ref.: [40, 41, 43, 45, 70,113]

Undergraduate and postgraduate studies in Fusion Science and Technology.

Responsible officer: J. Mlynář

Fusion teaching in the Czech republic in 2010 ran as usual, with about 20 MSc students (in particular at The Faculty of Nuclear Sciences and Physical Engineering - FNSPE, Czech technical university) and approximately same number of doctoral students (mostly registered at FMP, Charles University). Both universities closely collaborate within the Association, including exchange of lecturers and also fusion experts from the IPP Prague. The encouraging news was that application for renewal of the Erasmus Mundus Fusion EP, led by University of Ghent, was successful. In this new application, FNSPE CTU and IPP Prague have joined in as the associate members. Another significant push for the education came from the consortium FUSENET, where the FNSPE CTU applied for grant on upgrading the practica (in particular, the tokamak GOLEM availability) and this application was accepted at the end of the year. From the many activities of the GOLEM tokamak, the first "tokamak global experiments" deserves special mention.

Ref.: [84, 85]

6. Other activities in magnetic confinement fusion

6.1 Public information

Public information in fusion.

Responsible officer: M. Řípa

As predicted, the PI work was less demanding than in 2009 but still very successful. In total, about 20 newspaper articles on fusion were published, based on our pro-active attitude, and about the same number of lectures given. Many excursions visited tokamak COMPASS, about one every second week, and on the two "open days" the total number of visitors approached 500. New web pages including new graphics have been launched and they are updated continuously. The report of feasibility for project "Energy around us" was submitted to the Czech authorities. The project - which applies for European funding - has a significant fusion part. Concerning other Association partners, the role of tokamak GOLEM (former CASTOR, now a practica device in the Czech Technical University) in the Public Information increased substantially, with increasing number of visitors, a very successful "global tokamak experiment" and new web pages.

7. Coordination, in the context of a keep-in-touch activity, of the Member State's civil research activities on Inertial Fusion Energy'

7.1 Scientific Developments

Improve laser radiation coupling to ICF targets..

Principal Investigator: J. Ullschmied

The goal of the collaborative experiments performed by PALS (IPP-CZ) and IPPLM-PL physicists at the PALS infrastructure since November 2009 was to exploit an original highly efficient scheme of dense plasma acceleration referred to as Laser-Induced Cavity pressure Acceleration (LICPA) [54]. It turned out that this method might have a significant impact on designing more efficient ICF systems, being useful also for various non-ICF applications of high-density laser-driven plasma [55]. The results of the preliminary experiments performed

in 2009, having been elaborated till September 2010, have been published in [56-62, 111]. The LICPA experiments continued in the period September 6 – October 29, 2010. The effects of CH-foil thickness, cavity and channel lengths, material of the channel wall (Al, Au), as well as of the laser energy and wavelength (1st and 2nd laser harmonics) on the plasma acceleration were studied by using various complex laser LICPA targets with cylindrical and conical guiding channels. We measured the transported energy and macroscopic plasma parameters (density, velocity, ion current) at the output of the LICPA accelerator. For comparison we repeated each measurement with a similar target without the LICPA cavity, in which case the plasma was accelerated just due to free laser ablation. With the LICPA targets all the key measured parameters (energetic efficiency, plasma velocity, ion current density) were by more than an order of magnitude higher in comparison with the free ablative acceleration case.

Ref.: [54, 55, 56, 57, 58, 59, 60, 61, 62, 111]

7.4 Maintain a watching brief on inertial confinement civil research activities

Inform the wider fusion community of developments in IFE.

Principal Investigator: J. Ullschmied

Since the beginning of the 2010 year the public webpage www.ife-kit.eu has been serving for informing a wider fusion community about developments in IFE. The IFE WG Progress Report 2010 is to be set up from relevant parts of the Progress Reports of individual Associations. No instructions as for the IFE WG Watching Brief were available till the end of 2010.

III

GENERATED INFORMATION
AND INTELLECTUAL PROPERTY

1. Generated information

In this part, the list of 2010 research publications of the Association EURATOM / IPP.CR is presented. For the overview of Public Information activities please refer to the report in Part IV, section 7.

- [1] **Laqua H.P., Chlechowicz E., Glaubitz M., Marsen S., Stange T., Otte M., Preinhaelter J., Urban J., Zhang, D.:** 28 GHz EBW heating, current drive and emission experiments at the WEGA stellarator. *16th Joint Workshop on Electron Cyclotron Emission and Electron Cyclotron Resonance Heating, 12 - 15 April, Sanya, China (2010)*
- [2] **Otte M., Laqua H., Marsen S., Podoba Y., Preinhaelter J., Stange T., Urban J., Wagner F., Zhang D.:** Overdense Plasma Operation in the WEGA Stellarator. *Contributions to Plasma Physics* 50 (2010) 785-789
- [3] **Urban J., Decker J., Preinhaelter J., Taylor G., Vahala G., Vahala L. :** Comparison of EBW heating and current drive simulation models in realistic tokamak conditions. *37th EPS Conference on Plasma Physics, 21 - 25 June, Dublin, Ireland (2010)* P5.191
- [4] **Urban J., Preinhaelter J., Decker J., Peysson Y., Taylor G., Vahala G., Vahala L. :** Prospects for EBW heating and current drive on spherical tori. *16th Joint Workshop on Electron Cyclotron Emission and Electron Cyclotron Resonance Heating, 12 - 15 April, Sanya, China (2010)*
- [5] **Urban J., Stránský M., Fuchs V., Voitsekhovitch I., Valovič M.:** Self-consistent transport simulations of COMPASS operation with optimized NBI. *Plasma Physics and Controlled Fusion* 52 (2010) 045008
- [6] **Mlynar J., Weinzettl V., Bonheure G., Murari A. and JET-EFDA contributors:** Inversion techniques in the Soft X-Ray tomography of fusion plasmas: towards real-time applications. *Fusion Science Technol.* 58 3 (2010) 733
- [7] **Bonheure G., Hult M., González de Orduña R., Hult M., Arnold D., Dombrowski H., Laubenstein M., Wieslander E., Vermaercke P., Murari A., Popovichev S., Mlynar J. and JET EFDA contributors :** Charged Fusion Product Loss Measurements Using Nuclear Activation Analysis. *Proceedings of the 18th High Temperature Plasma Diagnostics, Wildwood, New Jersey, USA, Rev.Sci.Instrum.* 81 10 (2010) 10D331
- [8] **Murari A., Angelone M., Bonheure G., Cecil E., Craciunescu T., Darrow D., Edlington T., Ericsson G., Gatu-Johnson M., Gorini G., Hellesen C., Kiptily V., Mlynar J., Perez von Thun C., Pillon M., Popovichev S., Syme B., Tardocchi M., Zoita V.L. and JET EFDA contributors :** New Developments in the Diagnostics for the Fusion Products on JET in Preparation for ITER. *Proceedings of the 18th High Temperature Plasma Diagnostics, Wildwood, New Jersey, USA, May 2010, Rev.Sci.Instrum.* 81 10 (2010) 10E136
- [9] **Zajac J., Preinhaelter J., Urban J., Žáček F., Šesták D., Nanobashvili S.:** EC-EBW emission diagnostics for the COMPASS tokamak. *18th High Temperature Plasma Diagnostics, Wildwood, New Jersey, USA* to be published in *Rev.Sci.Instrum.* poster H36 / accepted

- [10] **J Horacek, J Adamek, H W Muller, J Seidl, V Rohde, F Mehlmann, C Ionita, A H Nielsen and ASDEX Upgrade Team** : Fast measurement of plasma potential, temperature and density in SOL of ASDEX Upgrade . *Nuclear Fusion* 50 (2010) 105001. doi: 10.1088/0029-5515/50/10/105001
- [11] **Author: Petr Vondráček (supervisor: Jan Horáček)**: Zprovoznění návratové sondy na tokamaku COMPASS (Reinstallation of reciprocating probe on tokamak COMPASS). Bachelor thesis 2010. FJFI ČVUT.
- [12] **J Horacek, J Adamek, H W Muller, J Seidl, V Rohde, F Mehlmann, C Ionita, A H Nielsen and ASDEX Upgrade Team**: Fast measurement of plasma potential, temperature and density in the SOL of ASDEX Upgrade, compared with ESEL simulation. *Abstract and Talk at EFDA TTG + EU-US TTF Meeting. Cordoba, Spain* <http://ocs.ciemat.es/ttg2010abs/pdf/O2.03.pdf>
- [13] **J. Horacek, J. Havlicek, D.F. Valcárcel, R. Beno, V. Weinzettl, F. Janky, M. Hron, R. Panek, I.S. Carvalho, J. Stockel, O. Kudlacek**: Design of plasma position feedback system on tokamak COMPASS, based on basic physics principles. *Abstract submitted to Symposium on Fusion Technology 2010 (Portugal) and Paper to the Journal Fusion Engineering and Design as FUSENGDES-D-10-00126.*
- [14] **Anders H. Nielsen, Wojtek Fundamenski, Odd-Erik Garcia, Eva Havlickova, Mathias Hoffmann, Jan Horacek, Volker Naulin, Jens Juul Rasmussen , Jakub Seidl and Guosheng Xu**: Numerical probe analyze. *Talk at TF-T Culham 14 – 17 February 2010.*
- [15] **E. Havlickova , W.Fundamenski , V. Naulin, A. H. Nielsen, J. Seidl, J. Horacek** : Modelling of steady-state and transient parallel transport in the SOL and consequences of time averaging of plasma parameters in the turbulent SOL. *Abstract, Paper and Poster on the PSI conference, California* <http://fusion.gat.com/conferences/psi2010/>
- [16] **Petra Bílková, Milan Aftanas, Petr Böhm, Vladimír Weinzettl, David Šesták, Radek Melich, Jan Stöckel, Rory Scannell, Mike Walsh**: Design of new Thomson scattering diagnostic system on COMPASS tokamak. *Nuclear Instruments and Methods in Physics Research A* doi:10.1016/j.nima.2010.03.121
- [17] **P.Bilkova, R.Melich, M.Aftanas, P.Böhm, D.Sestak, D.Jares, V.Weinzettl, J.Stöckel, M.Hron, R.Panek, R.Scannell and M.J.Walsh**: Progress of development of Thomson scattering diagnostic system on COMPASS. *Review of Scientific Instruments 18th Topical Conference Proceedings on High-Temperature Plasma Diagnostics (HTPD) RSI-HTPD MS# C10757-D25RR* (paper, accepted)
- [18] **P.Bilkova, M.Aftanas, P.Böhm, R.Melich, D.Sestak, D.Jares, V.Weinzettl, R.Scannell and M.J.Walsh** : Progress of development of Thomson scattering diagnostic system on COMPASS. *18th Topical Conference on High-Temperature Plasma Diagnostics, Wildwood, New Jersey, May 2010* poster D25
- [19] **P.Böhm, P. Bohm, D. Sestak, P. Bilkova, M. Aftanas, V. Weinzettl, M. Hron, R. Panek, L. Baillon, M. R. Dunstan, G. Naylor, M. J. Walsh**: Laser system for high resolution Thomson scattering diagnostics on the COMPASS tokamak . *18th Topical Conference on High-Temperature Plasma Diagnostics, Wildwood, New Jersey, May 2010* poster D21
- [20] **M.Aftanas, P.Bilkova, P.Böhm, V.Weinzettl, R.Scannell, M.Walsh**: Data acquisition system and data processing for the new Thomson scattering system on tokamak COMPASS. *18th Topical Conference on High-Temperature Plasma Diagnostics, Wildwood, New Jersey, May 2010* poster D07

- [21] **Vaclav Petrzilka, Vladimir Fuchs, Jamie Gunn, Nicolas Fedorczak, Annika Ekedahl, Marc Goniche, Julien Hillairet and Pavol Pavlo:** Theory of fast particle generation in front of LH grills. *Invited paper I-23, Proceedings of the Varenna-Lausanne Fusion Theory Conference, Varenna, Italy, August 30 - September 3, 2010* http://varenna-lausanne.epfl.ch/Varenna2010/abstracts/Petrzilka_Varenna10_abstract.pdf
- [22] **V. Petrzilka, G. Corrigan, P. Belo, V. Fuchs, A. Ekedahl, M. Goniche, J. Hillairet, P. Jacquet, J. Mailloux, M.-L. Mayoral, J. Ongena, V. Parail and JET EFDA contributors:** Edge2d modeling of ponderomotive density depletion in front of the JET LH grill. *37th EPS Conference on Plasma Physics, 21 - 25 June, Dublin, Ireland (2010)* P5.178; <http://ocs.ciemat.es/EPS2010PAP/pdf/P5.178.pdf>
- [23] **V. Fuchs, J. P. Gunn, V. Petřilka, N. Fedorczak, A. Ekedahl, M. Goniche, and J. Hillairet:** Some properties of LH-generated fast electrons in the SOL. *37th EPS Conference on Plasma Physics, 21 - 25 June, Dublin, Ireland (2010)* P2.130; <http://ocs.ciemat.es/EPS2010PAP/pdf/P2.130.pdf>
- [24] **P.K. Sharma, M. Goniche, A. Ekedahl, V. Basiuk, J. Decker, D. Mazon, Y. Peysson, J. Achard, C. Balorin, G. Berger-By, S. Brémond, E. Corbel, X. Courtois, E. Delmas2, L. Delpuch, D. Douai, C. Goletto, D. Guilhem, J.P. Gunn, P. Hertout, J. Hillairet, G.T. Hoang, F. Imbeaux, X. Litaudon, R. Magne, P. Mollard, P. Moreau, T. Oosako, S. Poli, M. Preynas, M. Prou, F. Saint Laurent, F. Samaille, B. Saoutic, J. Belo, C. Castaldo, S. Ceccuzzi, R. Cesario, F. Mirizzi, Y. Baranov, K.K. Kirov, J. Mailloux, V. Petrzilka, Y.S. Bae, J. Kim, S. Lee, X. Bai, X. Ding:** Hard X-ray measurements during LHCD experiments with passive active multijunction and fully active multijunction antennas in Tore Supra. *37th EPS Conference on Plasma Physics, 21 - 25 June, Dublin, Ireland (2010)* P5.184; <http://ocs.ciemat.es/EPS2010PAP/pdf/P5.184.pdf>
- [25] **A. Ekedahl, L. Delpuch, M. Goniche, D. Guilhem, J. Hillairet, M. Preynas, P.K. Sharma, J. Achard, Y.S. Bae, X. Bai, C. Balorin, Y. Baranov, V. Basiuk, A. Bécoulet, J. Belo, G. Berger-By, S. Brémond, C. Castaldo, S. Ceccuzzi, R. Cesario, E. Corbel, X. Courtois, J. Decker, E. Delmas, X. Ding, D. Douai, C. Goletto, J.P. Gunn, P. Hertout, G.T. Hoang, F. Imbeaux, J. Kim, K.K. Kirov, S. Lee, X. Litaudon, R. Magne, J. Mailloux, D. Mazon, F. Mirizzi, P. Mollard, P. Moreau, T. Oosako, V. Petrzilka, Y. Peysson, S. Poli, M. Prou, F. Saint-Laurent, F. Samaille, B. Saoutic:** First Experiments with the ITER-Relevant LHCD Launcher in Tore Supra, Oral contribution., *37th EPS Conference on Plasma Physics, 21 - 25 June, Dublin, Ireland (2010)* O4.125; <http://ocs.ciemat.es/EPS2010PAP/pdf/O4.125.pdf>
- [26] **P. Jacquet, L. Colas, M.-L. Mayoral, G. Arnoux, V. Bobkov, M. Brix, A. Czarnecka, D. Dodt, F. Durodie, A. Ekedahl, M. Fursdon, E. Gauthier, M. Goniche, M. Graham, E. Joffrin, E. Lerche, J. Mailloux, I. Monakhov, J. Ongena, V. Petrzilka, A. Korotkov, F. Rimini, A. Sirinelli, D. Frigione, C. Portafaix, V. Riccardo, Z. Vizvary, K.-D. Zastrow, and JET EFDA Contributors:** Heat-loads on JET Plasma Facing Components from ICRF and LH Wave Absorption in the Scrape-Off-Layer. *23rd IAEA Fusion Energy Conference, Daejeon, Republic of Korea, presented EXW/P7-32;* http://www-pub.iaea.org/mtcd/meetings/PDFplus/2010/cn180/cn180_BookOfAbstracts.
- [27] **A. Ekedahl, L. Delpuch, M. Goniche, D. Guilhem, J. Hillairet, M. Preynas, P.K. Sharma, J. Achard, Y.S. Bae, X. Bai, C. Balorin, Y. Baranov, V. Basiuk, A. Bécoulet, J. Belo, G. Berger-By, S. Brémond, C. Castaldo, S. Ceccuzzi, R. Cesario, E. Corbel, X. Courtois, J. Decker, E. Delmas, X. Ding, D. Douai, C. Goletto, J.P. Gunn, P. Hertout, G.T. Hoang, F. Imbeaux, J. Kim, K.K. Kirov, S. Lee, X. Litaudon, R. Magne, J. Mailloux, D. Mazon, F. Mirizzi, P. Mollard, P. Moreau, T. Oosako, V. Petrzilka, Y. Peysson, S. Poli, M. Prou, F. Saint-Laurent, F. Samaille, B. Saoutic:** Validation of the ITER-relevant passive-active-multijunction LHCD launcher on long pulses in Tore Supra. *Nuclear Fusion* 50 (2010) 112002

- [28] **V Petrzilka, G Corrigan, V Fuchs, M Goniche, J Mailloux, V Parail, P Belo, M Brix, A Ekedahl, P Jacquet, M-L Mayoral, J Ongena, C Silva, A Sirinelli, M Stamp, and JET EFDA contributors:** JET SOL ionization at LH wave launching. *Plasma Physics Controlled Fusion* to be submitted to PPCF, on JET pinboard (submitted for clearance)
- [29] **P. Bohm, D. Sestak, P. Bilkova, M. Aftanas, V. Weinzettl, M. Hron, R. Panek, L. Baillon, M. R. Dunstan, G. Naylor, M. J. Walsh:** Laser system for high resolution Thomson scattering diagnostics on the COMPASS tokamak. *Review of Scientific Instruments* DOI: 10.1063/1.3460450
- [30] **Matejcek J., Chraska P.:** Development of advanced coatings for ITER and future fusion devices. *Advances in Science and Technology* Vol. 66 (2010) pp 47-65
- [31] **Havlicek J., Horacek J., Weinzettl V., Hronova O., Naydenkova D., Zajac J.:** Magnetic Diagnostics for Start-up Phase of COMPASS. *WDS'09 Proceedings of Contributed Papers: Part II - Physics of Plasmas and Ionized Media* (eds. J. Safrankova and J. Pavlu), Prague, Matfyzpress (2009) pp. 148-152. (The paper was reported in 2009 as "to be published")
- [32] **Havlicek J., Kudláček O., Janky F., Horáček J., Beňo R., Valcárcel D.F., Fixa J., Brotánková J., Zajac J., Hron M., Pánek R., Cahyna P.:** Status of Magnetic Diagnostics on COMPASS. *WDS'10 Proceedings of Contributed Papers: Part II - Physics of Plasmas and Ionized Media* (eds. J. Safrankova and J. Pavlu), Prague, Matfyzpress, pp. 12-17, 2010.
- [33] **Valcárcel D.F., Neto A., Carvalho I.S., Carvalho B.B., Fernandes H., Sousa J., Janky F., Havlicek J., Beno R., Horacek J., Hron M., Pánek R.:** The COMPASS Tokamak Plasma Control Software Performance. *17th Real-Time Conference, 24-28 May 2010, Lisboa, Portugal*, poster presented, article to be published.
- [34] **Duarte A.S., Santos B., Pereira T., Carvalho B.B., Fernandes H., Neto A., Janky F., Cahyna P., Pisacka J., Hron M.:** FireSignal application Node for subsystem control. *Fusion Engineering and Design* 85 (2010) 496–499, doi:10.1016/j.fusengdes.2010.03.056
- [35] **Carvalho I.S., Valcarcel D.F., Fernandes H., Sousa J., Carvalho B.B., Neto A., Havlicek J., Horacek J., Janky F., Beno R., Hron M., Panek R.:** Dynamic Compensation for COMPASS Tokamak Poloidal Fields. *17th Real-Time Conference, 24-28 May 2010, Lisboa, Portugal*, poster presented.
- [36] **Hron M., Sova J., Siba J., Kovar J., Adamek J., Panek R., Havlicek J., Pisacka J., Mlynar J., Stockel J.:** Interlock system for the COMPASS tokamak. *Fusion Engineering and Design* 85 (2010) 505–508, doi:10.1016/j.fusengdes.2010.03.054
- [37] **Szappanos A., Berta M., Hron M., Panek R., Stöckel J., Tulipán S., Veres G., Weinzettl V., Zoletnik S.:** EDICAM fast video diagnostic installation on the COMPASS tokamak. *Fusion Engineering and Design* 85 (2010) 370–373, doi:10.1016/j.fusengdes.2009.11.001
- [38] **Fernandes H., Sousa J., Carvalho I.S., Valcarcel D.F., Carvalho B.B., Neto A., Duarte A., Santos B., Fortunato J., Pereira T., Alves H., Varandas C.A.F., Beno R., Havlicek J., Janky F., Cahyna P., Horacek J., Hron M., Panek R.:** Plasma Control at Compass - a Vertical Solution. *17th Real-Time Conference, 24-28 May 2010, Lisboa, Portugal*, invited presentation.
- [39] **Valcárcel D.F., Duarte A.S., Neto A., Carvalho I.S., Carvalho B.B., Fernandes H., Sousa J., Sartori F., Janky F., Cahyna P., Hron M., Pánek R.:** Real-time software for the COMPASS tokamak plasma control. *Fusion Engineering and Design* 85 (2010) 470–473, doi:10.1016/j.fusengdes.2010.03.049

- [40] **Vojtěch Lejsek (supervisor: Jaromír Zajac):** Zpracování dat pro mikrovlnnou reflektometrii na tokamacích CASTOR a COMPASS (Data processing for microwave reflectometry on tokamaks CASTOR and COMPASS). *Bachelor thesis 2010. Faculty of Nuclear Sciences and Physical Engineering of the Czech Technical University in Prague (CTU).*
- [41] **Michal Vašulka (supervisor: Jaromír Zajac):** Stavba a provoz reflektometrického systému pro tokamak COMPASS (Construction and operation of the reflectometric system on tokamak COMPASS). *Bachelor thesis 2010. Faculty of Nuclear Sciences and Physical Engineering of the Czech Technical University in Prague (CTU).*
- [42] **Komm M., Adamek J., Pekarek Z., Panek R.:** Particle-In-Cell simulations of the Ball-pen probe. *Contribution to Plasma Physics* accepted
- [43] **Odstrčil M. (supervisor: Mlynář J.):** Tomografie plazmatu na tokamaku COMPASS (Plasma tomography on the COMPASS tokamak). *Bachelor thesis FJFI ČVUT (FNSPE, Czech Technical University in Prague, 2010)*
- [44] **Komm M., Dejarnac, R., Gunn J.P., Kirschner A., Litnovsky A., Matveev D., Pekarek Z.:** PIC simulations for TEXTOR test limiter experiments with shaped and non-shaped gaps. *PPCF* submitted
- [45] **Krbec J. (supervisor: Mlynář J.):** Simulace intenzity čárového vyzařování C5+ při vstříku neutrálního svazku do vysokoteplotního plazmatu (Modelling of C5+ line emission during the energetic neutral beam injection in high temperature plasma). *Bachelor thesis FJFI ČVUT (FNSPE, Czech Technical University in Prague, 2010)*
- [46] **Komm M., Adamek J., Dejarnac R., Gunn J.P., Pekarek Z.:** Transport of electrons in the tunnel of an ion sensitive probe. *PPCF* submitted
- [47] **Matveev D., Kirschner A., Litnovsky A., Komm M., Borodin D., Philipps V., van Oost G., :** Modelling of impurity deposition in gaps of castellated surfaces with the 3DGap code. *PPCF* 52 (2010) 075007
- [48] **Tierens W., Komm M., Stockel J., van Oost G.:** Novel cylindrical probe for measuring ion temperature in magnetized plasmas. *Contrib. to Plasma Physics* accepted
- [49] **Komm M., Pekarek Z., Adamek J.:** PARTICLE-IN-CELL SIMULATIONS OF THE KATSUMATA PROBE. *WDS'10 Proceedings of Contributed Papers* submitted
- [50] **Kocan M., Carpentier-Couchana S., Gunn J.P., Hermann A., Kirk A., Komm M., Muller H.W., Pascal J-Y., Pitts R.A., Rohde V., Tamain P.:** Measurements of ion energies in the tokamak plasma boundary. *J. Nucl. Matter* submitted
- [51] **Hacek P., Weinzettl V., Stockel J., Anda G., Veres G., Zoletnik S., Berta M.:** Atomic Beam Probe Diagnostic for COMPASS Tokamak. *WDS 2010 - Proceedings of Contributed Papers: Part II (eds. J. Safrankova and J. Pavlu)*, f-2, pp. 7-11, Prague, Czech Republic, Matfyzpress, ISBN 978-80-7378-140-8
- [52] **Weinzettl V., Naydenkova D.I., Sestak D., Vlcek J., Mlynar J., Melich R., Jares D., Malot J., Sarychev D., Igochine V.:** Design of multi-range tomographic system for transport studies in tokamak plasmas. *Nuclear Instruments and Methods in Physics Research A* 623 (2010) 806–808, doi:10.1016/j.nima.2010.04.010
- [53] **Kurian M., Krilin L., Cahyna P., Panek R., Stockel J.:** Particle dynamics in RMP ergodic layer under influence of edge plasma turbulence. *24th Symposium on Plasma Physics and Technology, Czech Technical University, Prague 2010, poster, Abstract Programme Book*

- [54] **J. Badziak, S. Borodziuk, T. Pisarczyk, T. Chodukowski, E. Krousky, K. Masek, J. Skala, J. Ullschmied, Yong-Joo Rhee:** Highly efficient acceleration and collimation of high-density plasma using laser-induced cavity pressure. *Appl. Phys. Lett.* 96(2010), Art. No. 251502, doi: 10.1063/1.3457865
- [55] **Ph. Nicolai, C. Stenz, V. Tikhonchuk, A. Kasperczuk, T. Pisarczyk, L. Juha, E. Krousky, K. Masek, M. Pfeifer, K. Rohlena, J. Skala, J. Ullschmied, M. Kalal, D. Klir, J. Kravarik, P. Kubes, K. Rezac, P. Pisarczyk and E. Tabakhoff:** Experimental evidence of multi-material jet formation with lasers. *Physics of Plasmas* 17 (2010) 112903, doi: 10.1063/1.3511774
- [56] **J. Badziak, T. Pisarczyk, T. Chodukowski, A. Kasperczuk, P. Parys, M. Rosinski, J. Wolowski, E. Krousky, J. Krasa, K. Masek, M. Pfeifer, J. Skala, J. Ullschmied, A. Velyhan, L.J. Dhareshwar, N.K. Gupta, Y-J.Rhee, L. Torrasi, P. Pisarczyk:** Formation of a supersonic laser-driven plasma jet in a cylindrical channel. *Physics of Plasmas* 16 (2009) Art. No. 114506, doi: 10.1063/1.3270520
- [57] **A. Kasperczuk, T. Pisarczyk, J. Badziak, S. Borodziuk, T. Chodukowski, N.N. Demchenko, S.Yu. Gus'kov, J. Ullschmied, E. Krousky, K. Masek, M. Pfeifer, K. Rohlena, J. Skala, P. Pisarczyk :** Plastic plasma influence on formation of laser-produced copper plasma jet. *Proc. 37th Conf. on Plasma Physics EPS2010, Dublin, Ireland, 21-25.6. 2010* Vol. 34A, P5.218, ISBN 2-914771-62-2
- [58] **T. Pisarczyk, A. Kasperczuk, J. Badziak, S. Borodziuk, T. Chodukowski, P. Parys, M. Rosinski, J. Wolowski, J. Ullschmied, E. Krousky, K. Masek, M. Pfeifer, K. Rohlena, J. Skala, P. Pisarczyk:** Plasma jet creation by direct and indirect irradiations of conically shaped foils. *Proc. 37th Conf. on Plasma Physics EPS2010, Dublin, Ireland, 21-25.6. 2010* Vol. 34A, P4.226, ISBN 2-914771-62-2
- [59] **A. Kasperczuk, T. Pisarczyk, J. Badziak, S. Borodziuk, T. Chodukowski, P. Parys, J. Ullschmied, E. Krousky, K. Masek, M. Pfeifer, K. Rohlena, J. Skala, P. Pisarczyk:** Interaction of two plasma jets produced successively from Cu target. *Laser and Particle Beams* 28 (2010) 497-504, doi:10.1017/S0263034610000492
- [60] **Kasperczuk, T. Pisarczyk, J. Badziak, S. Borodziuk, T. Chodukowski, S. Yu. Gus'kov, N. N. Demchenko, J. Ullschmied, E. Krousky, K. Masek, M. Pfeifer, K. Rohlena, J. Skala, P. Pisarczyk:** Influence of low atomic number plasma component on the formation of laser-produced plasma jets. *Physics of Plasmas* 17 (2010) 1-6, doi: 10.1063/1.3496046
- [61] **A. Kasperczuk, T. Pisarczyk, J. Badziak, S. Borodziuk, T. Chodukowski, P. Parys, J. Ullschmied, E. Krousky, K. Masek, M. Pfeifer, K. Rohlena, J. Skala, P. Pisarczyk:** Interaction of two Cu plasma jets produced successively from the cylindrically shaped massive target. *ECLIM 2010, Budapest, 6-10 Sept. 2010* Poster 80
- [62] **S. Borodziuk, A. Kasperczuk, T. Pisarczyk, J. Badziak, T. Chodukowski, J. Ullschmied, E. Krousky, K. Masek, M. Pfeifer, K. Rohlena, J. Skala, P. Pisarczyk:** Cavity Pressure Acceleration – an efficient laser-based method of production of high-velocity macroparticles. *ECLIM 2010, Budapest, 6-10 Sept. 2010* Poster 97
- [63] **V. Riccardo, G. Arnoux, P. Cahyna, T.C. Hender, A. Huber, S. Jachmich, V. Kiptily, R. Koslowski, L. Krlin, M. Lehnen, A. Loarte, E. Nardon, R. Paprok, D. Tshakaya and JET EFDA contributors :** JET Disruption Studies in Support of ITER. *Plasma Physics and Controlled Fusion* 52 (2010) 124018

- [64] **P. Cahyna, E. Nardon and JET EFDA contributors:** Model for screening of resonant magnetic perturbations by plasma in a realistic tokamak geometry and its impact on divertor strike points. *19th conference on Plasma Surface Interactions, San Diego, 24-28.5. 2010, poster P1-41, accepted in Journal of Nuclear Materials* doi:10.1016/j.jnucmat.2011.01.117
- [65] **E. Nardon, P. Cahyna, S. Devaux, A. Kirk, A. Alfier, E. De La Luna, G. De Temmerman, P. Denner, T. Eich, T. Gerbaud, D. Harting, S. Jachmich, H.R. Koslowski, Y. Liang, Y. Sun, the MAST team and JET-EFDA contributors:** Strike-point splitting induced by external magnetic perturbations: observations on JET and MAST and associated modelling. *19th conference on Plasma Surface Interactions, San Diego, 24-28.5. 2010, poster P1-43, accepted in Journal of Nuclear Materials* doi:10.1016/j.jnucmat.2010.10.072
- [66] **J. Seidl, L. Krlín:** Simulations of Impurity Transport in Turbulent Plasma in Tokamak Scrape-off Layer. *24th Symposium on Plasma Physics and Technology, Czech Technical University, Prague 2010, poster*
- [67] **E. Havlickova, W. Fundamenski, V. Naulin, A.H. Nielsen, J. Seidl, J. Horacek:** 1D SOL fluid modelling and coupling to turbulence. *Talk at TF-T Culham, 15-17 February 2010*
- [68] **Aftanas M., Bilkova P., Bohm P., Weinzettl V., Hron M., Panek R.:** Measurement of Temperature and Density of Fusion Plasmas on Tokamak COMPASS. *NI Academic & Research Days, Prague, 2010* NI Academic & Research Days, Prague, 2010, oral contribution
- [69] **Aftanas M., Bilkova P., Bohm P., Weinzettl V., Hron M., Panek R., Bongaarts J., Stefan R., Wittassek T., Rumpel M., Sima J., Kaminsky D. :** Measurement of Temperature and Density of Fusion Plasmas on Tokamak COMPASS. *NI Week 2010, Austin, Big Physics Symposium, August 2 2010.* NI Week 2010, Austin, Physics Forum, August 2010, oral contribution (Kaminsky D.)
- [70] **Lenka Kocmanová:** Thomsonův rozptyl na tokamaku COMPASS / Thomson scattering on the COMPASS tokamak. *Bachelor thesis FJFI ČVUT (FNSPE, Czech Technical University in Prague, 2010)* Bachelor thesis FJFI ČVUT (FNSPE, Czech Technical University in Prague, 2010)
- [71] **R. Dejarnac, M. Komm, D. Tskhakaya, J.P. Gunn, Z. Pekarek:** Detailed particle and power fluxes into ITER castellated divertor gaps during ELMs. *IEEE Transactions on Plasma Science* doi:10.1109/TPS.2010.2042620
- [72] **R. Dejarnac, M. Komm, J.P. Gunn, Z. Pekarek:** Effect of misaligned edges and magnetic field orientation on plasma deposition into gaps during ELMs on ITER'. *Journal of Nuclear Materials* Proceedings of the 19th International Conference on Plasma Surface Interactions, San Diego, California (2010). Accepted for publication in *Journal of Nuclear Materials*.
- [73] **P. Cahyna, R. Papřok, V. Riccardo, E. Nardon, L.Krlín, D. Tskhakaya :** Modelling of runaway electron trajectories with magnetic perturbations of the EFCCs. *General Task Force M Meeting, JET 15 March 2010*
- [74] **Kudrna P., Kluson J., Leshkov S., Chichina M., Pickova I., Hubicka Z., Tichý M.:** A Study of Plasma Parameters in Hollow Cathode Plasma Jet in Pulse Regime. *Contrib. Plasma Physics* 50(2010), in print. DOI 10.1002/ctpp.201010150
- [75] **Leshkov S., Kudrna P., Chichina M., Kluson J., Pickova I., Virostko P., Hubicka Z., Tichý M.:** Spatial Distribution of Plasma Parameters in DC-Energized Hollow Cathode Plasma Jet. *Contrib. Plasma Physics* 50(2010), in print. DOI 10.1002/ctpp.201010149

- [76] **Virostko P., Hubicka Z., Cada M. and Tichy M.:** Ion current to a substrate in the pulsed dc hollow cathode plasma jet deposition system. *J. Phys. D: Appl. Phys.* 43 (2010) 124019. doi:10.1088/0022-3727/43/12/124019
- [77] **Dannenmayer K., Mazouffre S., Kudrna P., Tichy M.:** Measurement of plasma properties in the plume far-field of a Hall effect thruster using Langmuir and emissive probes. *International Conference on Plasma Diagnostics, April 12-16, 2010, Pont-à-Mousson, France* poster
- [78] **Kolpaková A., Kudrna P., Kluson J., Picková I., Tichý M.:** A Langmuir Probe Study Of The Cylindrical Magnetron System With Large Length-To-Radius Ratio. *International Conference on Plasma Diagnostics, April 12-16, 2010, Pont-à-Mousson, France* poster
- [79] **Leshkov S., Kudrna P., Chichina M., Kluson J., Picková I., Tichý M.:** Examination Of Plasma Parameters In Dc-Energized Hollow Cathode Plasma Jet System By Langmuir Probe. *International Conference on Plasma Diagnostics, April 12-16, 2010, Pont-à-Mousson, France* poster
- [80] **Hrach R., Hrubý V., Maršálek O., Pekárek Z.:** Computational Study of Probes in Magnetized Plasma. *International Conference on Plasma Diagnostics, April 12-16, 2010, Pont-à-Mousson, France* poster and paper (submitted)
- [81] **Kluson J., Rubovič P., Kudrna P., Leshkov S., Tichý M.:** A study of the gas flow in the low pressure plasma jet sputtering system, . *24th Symposium on Plasma Physics and Technology, Prague, Czech Republic, 14-17 June 2010* poster
- [82] **Hruby V., Pekarek Z., Hrach R.:** Three-dimensional computer simulation of plasma-solid interaction in the presence of magnetic field . *Vacuum* submitted
- [83] **Peterka M., Tichý M., Adámek J.:** Measurement of the plasma potential in cylindrical magnetron by means of a ball-pen probe. *24th Symposium on Plasma Physics and Technology, Prague, Czech Republic, 14-17 June 2010* poster
- [84] **Svoboda V., Pokol G., Refy D., Stockel J., and Vondrasek G.:** Former Tokamak CASTOR becomes remotely controllable GOLEM at the Czech Technical University in Prague . *Proceedings of the 37th EPS Conference on Plasma Physics 2010, Dublin, Ireland* P2.111
- [85] **Markovic T. (supervisor I. Duran):** Magnetic field configurations and their measurement on tokamak GOLEM. *Bachelor thesis* FNSPE, Czech Technical University in Prague, 2010
- [86] **Řuran I., Bolshakova I., Viererbl L., Sentkerestiová J., Holyaka R., Lahodová Z., Bem P.:** Irradiation tests of ITER candidate Hall sensors using two types of neutron spectra. *Review of Scientific Instruments* accepted for publication
- [88] **Kovařík K., Řuran I., Hron M., Hidalgo C., Carralero D., Pedrosa M.A. and TJ-II team:** Advanced probe diagnostics for measurement of electromagnetic properties of turbulent structures at the plasma edge of the TJ-II stellarator. *submitted to Journal of Physics, Conference series*
- [89] **Naydenkova D.I., Weinzettl V., Stockel J., Sestak D., Janky F., Sedlak L.:** Progress in Multi channel Optical System for Visible Plasma Radiation Measurement at COMPASS Tokamak.. *WDS'10 Proceedings of Contributed Papers.* will be published.
- [90] **Naydenkova D., Weinzettl V., Stockel J., Sestak D., Janky F.:** The Optical System for Visible Plasma Radiation Measurements in the COMPASS Tokamak – Design and Testing.. *oral presentation in SPPT 2010, to be published in Acta Technica,* accepted

- [91] **Naydenkova D., Weinzettl V., Stockel J., Sestak D., Janky F.:** The Multichannel System for Visible Plasma Radiation Measurements in the COMPASS Tokamak.. *3rd EFDA Transport Topical Group Meeting combined with 15th EU-US Transport Task Force Meeting*. Cordoba, Spain, September 7 - 10, 2010, poster.
- [92] **Cairns R., A., Fuchs V.:** Calculation of a wave field from ray tracing. *Nuclear Fusion* 50 (2010), 095001
- [93] **Fuchs V., Gunn J. P., Petržílka V., Fedorczak N., Ekedahl A., Goniche M., Hillairet J.:** Recent advances in the study of lower hybrid generated fast electrons in the tokamak SOL . *Invited lecture at the 4th IWSSPP, Kiten, Bulgaria, 5-10 July, 2010*
- [94] **Keim A., Rasul B., Endstrasser N., Scheier P., Märk T.D., Herman Z.:** Interaction of small hydrocarbon ions C1 and C2 with carbon-fiber-composite (CFC) surfaces at room temperature. *Int. J. Mass Spectrom.* submitted
- [95] **Hadraba H., Fournier B., Stratil L., Malaplate J., Rouffié A-L., Wident P., Ziolek L., Béchade J-L. :** Influence of microstructure on impact properties of 9-18%Cr ODS steels for fusion/fission applications. *Journal of Nuclear Materials* in press
- [96] **Hadraba H., Kazimierzak B., Stratil L., Dlouhy I.:** Microstructure and Impact properties of Ferritic ODS ODM401 (14%Cr-ODS of MA957 type). *Journal of Nuclear Materials* in press
- [97] **Author: Olivier Van Hoey (supervisor: G. Van Oost, copromoter: D. Naydenkova):** Visible light measurements on the COMPASS tokamak. *Master thesis 2010*. Faculty of Engineering, Department of Applied Physics, Ghent University.
- [98] **V. Naulin, W. Fundamenski, E. Havlíčková, Chr. Maszl, G. Xu, A.H. Nielsen, J. Juul Rasmussen, R. Schrittwieser, J. Horacek, J. Seidl and JET-EFDA contributors :** Progress in Turbulence Modeling JET SOL and edge phenomena . *Fusion Energy Conference IAEA, Korea* Abstract and presentation THD/P3-03 http://www-pub.iaea.org/mtcd/meetings/PDFplus/2010/cn180/cn180_BookOfAbstracts.pdf
- [99] **H.W. Müller¹, J. Adamek², G.D. Conway¹, J.P. Gunn³, A. Herrmann¹, J. Horacek², C. Ionita⁴, M. Kocan¹, M. Maraschek¹, C. Maszl⁴, F. Mehlmann⁴, B. Nold⁵, V. Rohde¹, R. Schrittwieser⁴, N. Vianello⁶, M. Zuin⁶, and the ASDEX Upgrade Team:** Fluctuations, ELM Filaments and Turbulent Transport in the SOL at the Outer Mid Plane of ASDEX Upgrade. *Fusion Energy Conference IAEA, Korea* Abstract and presentation EXD/P3-23 http://www-pub.iaea.org/mtcd/meetings/PDFplus/2010/cn180/cn180_BookOfAbstracts.pdf
- [100] **A Ekedahl, L Delpech, M Goniche, D Guilhem, M Preynas, PK Sharma, Achard, YS Bae, X Bai, C Balorin, Yu Baranov, V Basiuk, A Bécoulet, J Belo, G Berger-By, S Brémond, C Castaldo, S Ceccuzzi, R Cesario, E Corbel, X Courtois, J Decker, E Delmas, X Ding, D Douai, C Goletto, JP Gunn, P Hertout, GT Hoang, F Imbeaux, KK Kirov, X Litaudon, R Magne, J Mailloux, D Mazon, F Mirizzi, P Mollard, Y Peysson, S Poli, M Prou, P Moreau, T Oosako, V Petržílka, F Saint-Laurent, F Samaille, B Saoutic :** Experimental results with the ITER-relevant LHCD launcher in Tore Supra. *23rd IAEA Fusion Energy Conference, Daejeon, Republic of Korea, presented, paper EXW/P7-05; http://www-pub.iaea.org/mtcd/meetings/PDFplus/2010/cn180/cn180_BookOfAbstracts*
- [101] **J. Adamek, J. Horacek, H.W. Muller, V. Rohde, C. Ionita, R. Schrittwieser, F. Mehlmann, B. Kurzan, J. Stockel, R. Dejarnac, V. Weinzettl, J. Seidl, M. Peterka:** Ball-Pen Probe Measurements in L-Mode and H-Mode on ASDEX Upgrade.. *Contrib. Plasma Phys.* 50, No. 9, 854 – 859 (2010) / DOI 10.1002/ctpp.201010145

- [102] **H.W. Muller, J. Adamek, J. Horacek, C. Ionita, F. Mehlmann, V. Rohde, R. Schrittwieser:** Towards Fast Measurement of the Electron Temperature in the SOL of ASDEX Upgrade Using Swept Langmuir Probes.. *Contrib. Plasma Phys.* 50, No. 9, 847 – 853 (2010) / DOI 10.1002/ctpp.201010144
- [103] **P. Jacquet, L. Colas, M.-L. Mayoral, G. Arnoux, V. Bobkov, M. Brix, A. Czarnecka, D. Dodt, F. Durodie, A. Ekedahl, D. Frigione, M. Fursdon, E. Gauthier, M. Goniche, M. Graham, E. Joffrin, A. Korotkov, E. Lerche, J. Mailloux, I. Monakhov, J. Ongena, V. Petrzilka, C. Portafaix, F. Rimini, A. Sirinelli, V. Riccardo, Z. Vizvary, K.-D. Zastrow, and JET EFDA Contributors:** Heat-loads on JET Plasma Facing Components from ICRF and LH wave absorption in the SOL. *Nuclear Fusion* to be submitted, submitted to JET pinboard for clearance
- [104] **M.Goniche, A.Ekedahl, B.Frincu, J.Hillairet, X.Litaudon, M.Preynas, V. Petržílka, D.Voyer:** Experimental investigation of non-linear coupling of lower hybrid waves on Tore Supra . *Plasma Physics Controlled Fusion*, submitted
- [105] **Vaclav Petrzilka, Vladimir Fuchs, Jamie Gunn, Nicolas Fedorczak, Annika Ekedahl, Marc Goniche, Julien Hillairet and Pavol Pavlo:** Theory of fast particle generation in front of LH grills. *Plasma Physics Controlled Fusion* 53 (2011) 054016 doi: 10.1088/0741-3335/53/5/054016
- [106] **Weinzettl V., Pánek R., Hron M., Stöckel J., Žáček F., Havlíček J., Bílková P., Naydenkova D.I., Háček P., Zajac J., Dejarnac R., Horáček J., Adámek J., Mlynář J., Janky F., Aftanas M., Böhm P., Brotánková J., Šesták D., Ďuran I., Melich R., Jareš D., Ghosh J., Anda G., Veres G., Szappanos A., Zoletnik S., Berta M., Shevchenko V.F., Scannell R., Walsh M., Müller H.W., Igochine V., Silva A., Manso M., Gomes R., Popov Tsv., Sarychev D., Kiselov V.K., Nanobashvili S.:** Overview of the COMPASS diagnostics. *Fusion Engineering and Design*, in press, doi:10.1016/j.fusengdes.2010.12.024
- [107] **P. Ivanova , Tsv. K. Popov, M. Dimitrova, E. Benova, T. Bogdanov, J. Stöckel, R. Dejarnac :** Precise evaluation of the plasma potential in COMPASS tokamak divertor area . *Symposium on Plasma Physics and Technology 2010*, invited oral presentation
- [108] **J. Urban, J. Decker, J. Preinhaelter, G. Taylor, G. Vahala and L. Vahala:** Key Aspects of EBW Heating and Current Drive in Tokamaks . *Bulletin of the American Physical Society* BP9.00077 (Abstract ID: BAPS.2010.DPP.BP9.77
- [109] **R. Raman , J-W. Ahn , J. Allain , R. Andre , R. Bastasz , D. Battaglia ,P Beiersdorfer , M. Bell , R. Bell , E. Belova , J. Berkery , R. Betti , J. Bialek ,, T. Bigelow , M. Bitter , J. Boedo , P. Bonoli , A. Boozer , A. Bortolon , D. Brennan , J. Breslau , R. Buttery , J. Canik , G. Caravelli , C. Chang , N.A. Crocker , D. Darrow , B. Davis , L. Delgado-Aparicio , A. Diallo , S. Ding , D. D’Ippolito , C. Domier , W. Dorland , S. Ethier , T. Evans , J. Ferron , M. Finkenthal , J. Foley , R. Fonck , R. Frazin , E. Fredrickson , G. Fu , D. Gates , S. Gerhardt , A. Glasser , N. Gorelenkov , T. Gray , Y. Guo , W. Guttenfelder , T. Hahm , R. Harvey , A. Hassanein , W. Heidbrink , K. Hill , Y. Hirooka , E.B. Hooper , J. Hosea , B. Hu , D. Humphreys , K. Indireskumar , F. Jaeger , T. Jarboe , S. Jardin , M. Jaworski , R. Kaita , J. Kallman , O. Katsuro-Hopkins , S. Kaye , C. Kessel , J. Kim , E. Kolemen , S. Krashennnikov , S. Kubota , H. Kugel , R. LaHaye , L. Lao , B. LeBlanc , W. Lee , K. Lee , J. Leuer , F. Levinton , Y. Liang , D. Liu, N. Luhmann Jr. , R. Maingi , R. Majeski , J. Manickam , D. Mansfield , R. Maqueda , E. Mazzucato , A. McLean , D. McCune , B. McGeehan , G. McKee , S. Medley , J. Menard , M. Menon , H. Meyer , D. Mikkelsen , G. Miloshevsky , D. Mueller , T. Munsat , J. Myra , B. Nelson , N. Nishino , R. Nygren , M. Ono , T. Osborne , H. Park , J. Park , S. Paul , W. Peebles , B. Penafior , C. Phillips , A. Pigarov , M. Podesta , J. Preinhaelter , Y. Ren , H. Reimerdes , G. Rewoldt , P. Ross , C. Rowley , E. Ruskov, D. Russell , D. Ruzic**

- 2, P. Ryan , S.A. Sabbagh , M. Schaffer , E. Schuster , F. Scotti , K. Shaing , V. Shevchenko , K. Shinohara , V. Sizyuk , C.H. Skinner , A. Smirnov , D. Smith 2, P. Snyder , W. Solomon , A. Sontag , V. Soukhanovskii , T. Stoltzfus-Dueck , D. Stotler , B. Stratton , D. Stutman , H. Takahashi , Y. Takase , N. Tamura , X. Tang , G. Taylor , C. Taylor , K. Tritz , D. Tsarouhas , M. Umansky , J. Urban , E. Uterberg , M. Walker , W. Wampler , W. Wang , J. Whaley , R. White , J. Wilgen , R. Wilson , K.L. Wong , J. Wright , Z. Xia , D. Youchison , G. Yu , H. Yuh , L. Zakharov , D. Zemlyanov , G. Zimmer , S.J. Zweben : OVERVIEW OF PHYSICS RESULTS FROM NSTX . *23rd IAEA Fusion Energy Conference, Contributed papers* http://www-pub.iaea.org/MTCD/Meetings/PDFplus/2010/cn180/cn180_papers/ov_2-4.pdf
- [110] Havlickova E., Fundamenski W., Naulin V., Nielsen A.H., Zagorski R., Seidl J., Horacek J.: Steady-state and time-dependent modelling of parallel transport in the scrape-off layer. *Plasma Physics and Controlled Fusion* accepted for publication
- [111] A. Kasperczuk, T. Pisarczyk, T. Chodukowski, Z. Kalinowska, P. Parys, J. Ullschmied, E. Krouskey, M. Pfeifer, J. Skala, D. Klir, J. Kravarik, P. Kubes, K. Rezac, P. Pisarczyk: Interaction of Cu and plastic plasmas as a method of forming laser produced Cu plasma streams. *submitted 17.12.2010 to Appl. Phys. Lett.*
- [112] Mlynar J., Weinzettl V., Odstrcil M.: Progress in rapid tomography for the COMPASS tokamak. *52nd Annual Meeting of the APS Division of Plasma Physics, Bulletin of the American Physical Society* 55 15 (2010) GP9.0073
- [113] Cahyna P.: Diffusion of particles from tokamak by stochastization of magnetic field lines. *Doctoral thesis* MFF UK (Faculty of Mathematics and Physics, Charles University Prague, 2010)
- [114] Kuběna I., Kruml T., Spätig P., Baluc N., Oksiuta Z., Petrevec M., Obrtlík K., Polák J. : Fatigue behaviour of ODS ferritic-martensitic Eurofer steel . *Procedia Engineering* 2 (2010) 717

2. Intellectual property

No intellectual property was reported to be generated in the Association EURATOM/IPP.CR in 2010.

Regarding the intention from 2008 to file a patent „**The construction of the ball-pen probe (BPP) head for the direct measurements of the plasma potential on fusion devices with magnetic confinement**“ announced by Dr Jiri Adamek, IPP, the proposal was still under investigation of the Patent office at the end of 2010. The subject of the patent is a novel and so far unpublished solution of this type of probe consisting in an additional carbon shield used in order to protect the front part of the boron nitride of the BPP from the radiation and also heat flux.

1. Provision of support to the advancement of the ITER Physics Basis

Role of edge plasma parameters connected with atomic physics in L-H transition on the COMPASS tokamak

V. Weinzettl, D. Naydenkova, R. Melich, D. Jares

Uncertainties in the L-H transition power threshold scaling are probably caused by edge and wall conditions. Underlying physics is partially linked with atomic processes in the edge plasma. The COMPASS tokamak is being equipped with a multi-channel system for visible light observations of the core/edge plasma from two poloidal angles. This system, when equipped with an appropriate interference filter, will allow performing a simple profile reconstruction of the spectrally resolved emission.

The multi-channel system for visible light observations has been designed to be composed from two independent 37-channel observation parts located in the angular port plugs at the same poloidal cross-section. The port plugs has been manufactured and both newly developed and constructed wide-angle objectives located inside the plugs were successfully tested in the laboratory in 2010. The total field of view of each objective was measured to be of about 110° for a set of 37 fibers ensuring a desired spatial resolution on plasma better than 1 cm.

Light from objectives will be trasfered to detectors using custom-made fiber optics including multi-channel terminations. The multichannel detector, S4114-35Q by Hamamatsu, connected to the amplifier was tested in the laboratory and cross-talks between neighbor channels were



Fig.1: Laboratory tests on the completed integrated spectroscopic port plug. The objective consisting of the vacuum and atmospheric parts is connected to the fiber optics.

estimated. Currently, the detectors equipped with amplifiers and corresponding data acquisitions are being transferred to their final positions.

Hydrogen and impurity emission and its evolution during tokamak discharges can be measured using interference filters (inserted into the objectives) with transmittance in the ranges of interest. The effective ionic charge Z_{eff} can be evaluated from measured bremsstrahlung radiation in the line free region, here it is slightly above 520 nm, using known plasma density and temperature profiles.

Two impurity survey spectrometers, HR 2000+ from Ocean Optics, can be used together with the multi-channel detector and registrate the most intensive spectral lines in the ranges of 247-472 nm and 457-663 nm with temporal resolution higher than 1 ms.

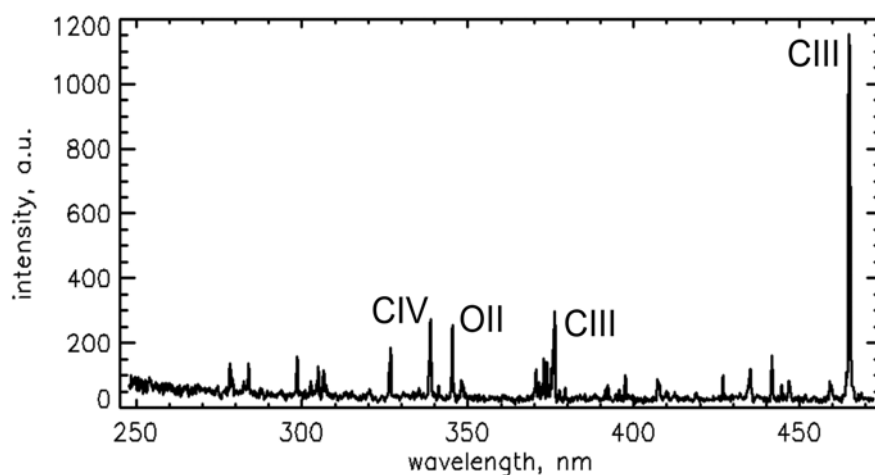

Fig.2: Near UV/visible light spectrum of the tokamak discharge #994.

References:

- [1] V. Weinzettl, et al.: Design of multi-range tomographic system for transport studies in tokamak plasmas. *Nuclear Instruments and Methods in Physics Research A* 623 (2010) 806–808, doi:10.1016/j.nima.2010.04.010
- [2] D. Naydenkova, et al.: "Progress in Multi channel Optical System for Visible Plasma Radiation Measurement at COMPASS Tokamak", WDS 2010 - Proceedings of Contributed Papers: Part II (eds. J. Safrankova and J. Pavlu), f-2, pp. 18-21, Prague, Czech Republic, Matfyzpress, ISBN 978-80-7378-140-8
- [3] D. Naydenkova, et al.: The Multichannel System for Visible Plasma Radiation Measurements in the COMPASS Tokamak. Poster on 3rd EFDA Transport Topical Group Meeting combined with 15th EU-US Transport Task Force Meeting. Cordoba, Spain, September 7 - 10, 2010.
- [4] O. Van Hoey (supervisor: G. Van Oost, copromoter: D. Naydenkova): Visible light measurements on the COMPASS tokamak. Master thesis 2010. Faculty of Engineering, Department of Applied Physics, Ghent University.
- [5] V. Weinzettl, et al.: Overview of the COMPASS diagnostics. *Fusion Engineering and Design*, in press, doi:10.1016/j.fusengdes.2010.12.024
- [6] D. Naydenkova, et al.: The Optical System for Visible Plasma Radiation Measurements in the COMPASS Tokamak – Design and Testing. Accepted to be published in *Acta Technica*.

Development of U-probe for study of filamentary structures in the COMPASS edge plasmas

K. Kovařík, J. Stöckel, I. Ďuran

In collaboration with:

E. Martines, M. Spolaore, N. Vianello, Association EURATOM-ENEA

C. Hidalgo, M. A. Pedrosa, D. Carralero, Association EURATOM-CIEMAT

J. Brotánková, Institute of Plasma Research, Bhat, Gandhinagar, Gujarat, India

A complex probe diagnostic combining arrays of Langmuir probes and magnetic coils, baptized as ‘U-probe’, is being prepared for measurement of electromagnetic properties of the filamentary structures in the edge plasmas of COMPASS tokamak. Two identical towers will house 3 sets of 3D coils, balanced triple probe and six single Langmuir probes each. The design of the probe is based on that of U-probe used on RFX-mod. This new COMPASS diagnostic will measure vorticity and longitudinal electric current of the plasma filaments. Analysis of correlation between filament vorticity and its current is expected to shed light into physics of filamentary structures in the tokamak plasma edge.

Achievement of understanding and certain level of control over the processes taking place in the edge plasmas of tokamaks are believed to be one of the key prerequisites for successful use of these devices for power production purposes. The main transport mechanism in this plasma region is of anomalous origin via various turbulence structures. On different types and scales of devices, there are observed filamentary structures that are flowing radially out from the plasma and carry out large amount of particles and energy. Such filamentary structures are called blobs (for the L-mode regime). To get better insight into mechanism of formation, growth, propagation etc. of such structures, we will measure filament vorticity and electric current along the filament in a ‘single point’ of space with a high temporal resolution. Similar measurement was already performed on RFX-mod in Padova and they are also prepared on TJ-II stellarator in Madrid. For the first time on tokamak, our U-probe on COMPASS is an attempt to find correlation between the filament vorticity and current.

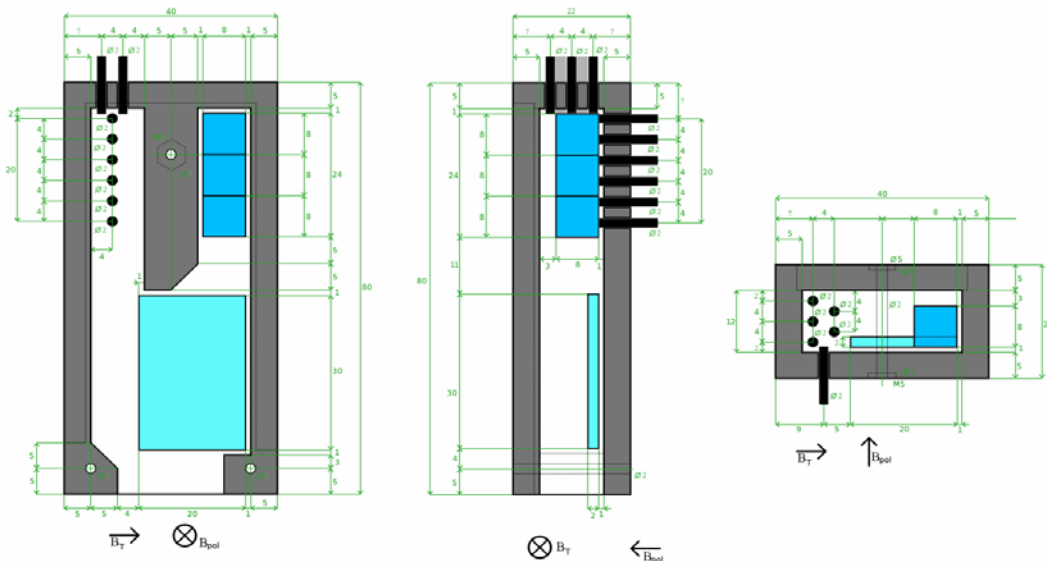

Fig. 1. Overall cross-sections of one tower of the U-probe.

Left – poloidal cross-section, middle – toroidal cross-section, right – radial cross-section.

Black – Langmuir probes, blue – 3D sets of coils, turquoise – reconnection plate for coils wires.

The conceptual design of the U-probe was prepared in 2010. All the parts of the probe head were designed, see Fig. 1. The U-probe is composed from two towers aligned in toroidal direction. Each tower is housed in casing made of two pieces of boron nitride, the bottom coffin and the covering lid. Space inside the coffin is divided into segments for coils and Langmuir probes. Coils will be wound as three triplets for each tower, each allowing to measure full vector of magnetic induction in its center. The outer shape of each coil triplet will be a cube with size about 10x10x10 mm. All coils are designed to have a good frequency response up to 500 kHz at minimum. Langmuir tips will be graphite rods 2 mm in diameter and they will be about 10 mm long, i.e. length about 5 mm will be exposed to the plasma. All the Langmuir tips will be divided into 2 groups. Balanced triple probe will be placed at the top side of each tower and the array of six tips will be arranged at the poloidal side for vorticity measurement.

Two towers are important for housing of two rows of the 3D coil sets to determine current density via $j = 1/\mu_0 \text{rot}B$. Moreover, the second tower could be used to assess effect of the black mass of the tower itself and consequent influence of the measured parameters by the U-probe. At last but not least, correlation of the electrostatic signals allow us to establish the poloidal and radial velocities of the blobs.

We have performed simulations of surface temperature of the probe head and Langmuir tips in dependence on edge plasma parameters and consequent thermal loads. These simulations showed that the surface temperature of the probe head (Boron Nitride) will not exceed 500 deg. Celsius for densities up to $5 \times 10^{19} \text{ m}^{-3}$ and electron temperatures up to 30 eV, Fig. 2.

We prepared design of mounting of the graphite Langmuir probe tips allowing their simple exchange, e.g. in case of damage. The carbon tips will be screwed on a screw (or in female screw) fixed on printed circuit with high thermal conductivity. The printed circuit will be manufactured from AlN substrates with directly bond 120 μm thick copper layer by etching.

We also prepared the first draft of the probe manipulator. It will house both towers and all the sensors inside aligned to the magnetic field. This implies the mounting structure will allow changing of the inclination and also rotation of the probe head on a shot to shot basis. Moreover, we need to protect the probe during discharges with higher densities and temperatures especially during H-mode. Therefore, radial movement of the probe head have to be allowed inside the vacuum chamber. We plan to finalize the design and start manufacturing of the probe in the first half of 2011 heading for the first experiments on COMPASS tokamak till the end of 2011.

References:

- [1] K. Kovarik et al.: Advanced probe diagnostics for measurement of electromagnetic properties of turbulent structures at the plasma edge of the TJ-II stellarator. *submitted to Journal of Physics, Conference series*

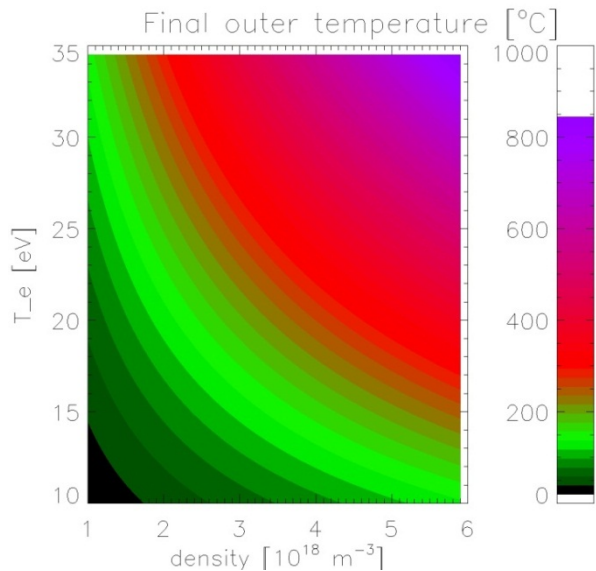

Fig. 2. Outer temperature of the boron nitride casing after 500ms discharge with given parameters.

ESEL development

J. Seidl, E. Havlíčková, J. Horáček

In collaboration with:

A. H. Nielsen, Association EURATOM-Risø

W. Fundamenski, Association EURATOM-CCFE

Our work was focused on study of assumptions made on parallel plasma transport in two-dimensional edge turbulent code ESEL [1,2]. We used one-dimensional fluid code SOLF1D [3] to study plasma transport along magnetic field-lines in the scrape-off layer (SOL) and compare it with simple analytical model that is currently used in ESEL code. Since SOLF1D does not include parallel transport of vorticity, we tested also two different models of parallel vorticity transport and compared their results with experimental Langmuir probe measurements.

Previously, the ESEL model has been compared with experimental measurements on TCV [1,2,4] and JET [2], showing reasonable agreement for high-collisionality regime on TCV, however revealing some discrepancies for lower parallel collisionality v_{ei}^* on JET. This indicates that simple analytical model approximating parallel plasma losses that is currently used in ESEL [2] is not sufficient and needs to be improved.

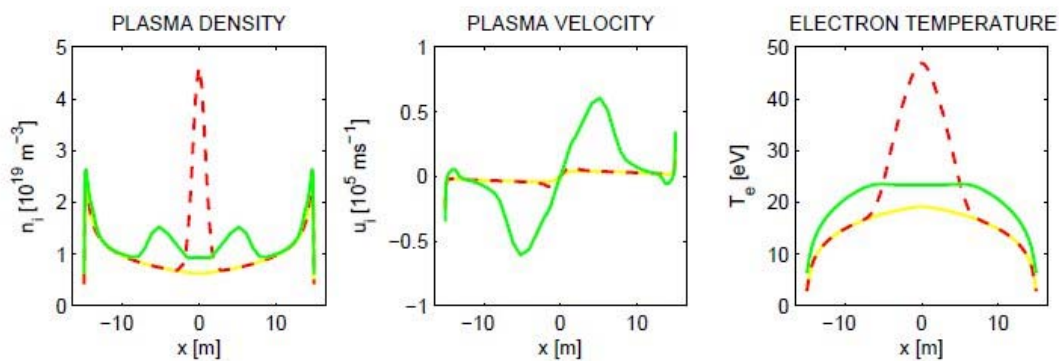

Fig. 1. Transport of a single blob along magnetic field-line. The blob was approximated by step-function in time $t=0 \mu\text{s}$ with realistic amplitude (4.5×10^{19}) and duration ($1 \mu\text{s}$) according to ESEL model. Profile of density (left) plasma velocity (middle) and electron temperature (right) is shown in three different times: steady state before the event ($t=-5 \mu\text{s}$; yellow), maximum density and temperature just after the event ($t=1 \mu\text{s}$; red) and after the event ($t=45 \mu\text{s}$; green)

First part of our study was focused on analysis of parallel transport modelled by fluid code SOLF1D. SOLF1D is one-dimensional code that does not include interchange turbulent drive and therefore ESEL provided time-dependent cross-field fluxes as a forcing for SOLF1D. The resulting transport along magnetic field-lines exhibit different nature and time scales for transport of energy and plasma density, as shown on Fig. 1. Results of SOLF1D show that though damping of both energy as well density in ESEL is underestimated on average, estimation of density losses by simple subsonic advection is burdened by significantly higher error (of an order of magnitude) than losses of temperature approximated by Spitzer-Härm diffusion. This corresponds with results from ESEL comparison with JET data [2].

Some authors propose [5] that characteristic time of parallel loss of vorticity in SOL could be proportional to Alfvén velocity rather than to ion sound speed that is currently used in ESEL. We have tested both assumptions for simulation of plasma with high collisionality $v_{ei}^* \sim 100$. The damping with characteristic time scale given by ion sound speed, that is the model routinely used in ESEL, produces turbulent structures distinctively elongated in poloidal direction near the last closed flux surface (LCFS) due to large shear of poloidal velocities (v_p) in this region. The shape of the structures then

transforms to circular in the far SOL (see Fig. 2). This is in accordance with experimental observations in the SOL of JET [6]. For typical tokamak SOL conditions Alfvén velocity is 50-200 larger than ion sound speed and therefore it causes substantial loss of momentum. Then, there does not develop almost any shear of v_p in the SOL and shear of v_p near the LCFS is significantly lower than in the previous case. As a result, the structures released to the SOL transform from circular-shaped to poloidally elongated in the far SOL (Fig. 2), which is in contradiction with the experiment. That is an indication that model of vorticity losses by Alfvén speed is not suitable for SOL modelling using ESEL, at least for high v_{ei}^* conditions.

Comparison of ESEL simulation with experimental measurements from ASDEX Upgrade gives ambiguous results. Radial profiles of density are significantly flatter in simulation than in experiment, while the profile of temperature shows reasonable agreement, as both expected from comparison with SOLF1D modelling. On the other hand radial particle flux through LCFS is significantly larger in the simulation than in experiment, which indicates that transport barrier established in the simulation is weak and the ESEL model is missing some important physics in this region. Imposing stronger transport barrier by additional external forcing added to simulation shows great impact on density profiles, now giving a reasonable agreement with experimental observations. Therefore, we see this as an additional source of error beyond underestimated parallel losses, both competing for explanation of discrepancies previously found between experiment and simulation. The degree of their influence should be compared in the future.

References:

- [1] O.E. Garcia, et al., *Plasma Physics and Controlled Fusion* 48 (2006) L1
- [2] W. Fundamenski, et al., *Nuclear Fusion* 47 (2007) 417
- [3] E. Havlíčková, PhD. thesis, Charles University (2009)
- [4] O.E. Garcia, et al., *Nuclear Fusion* 47 (2007) 667
- [5] Krasheninnikov, et al., *Physics of Plasmas* 15 (2008) 055909
- [6] G.S. Xu, et al., *Nuclear Fusion* 49 (2009) 092002

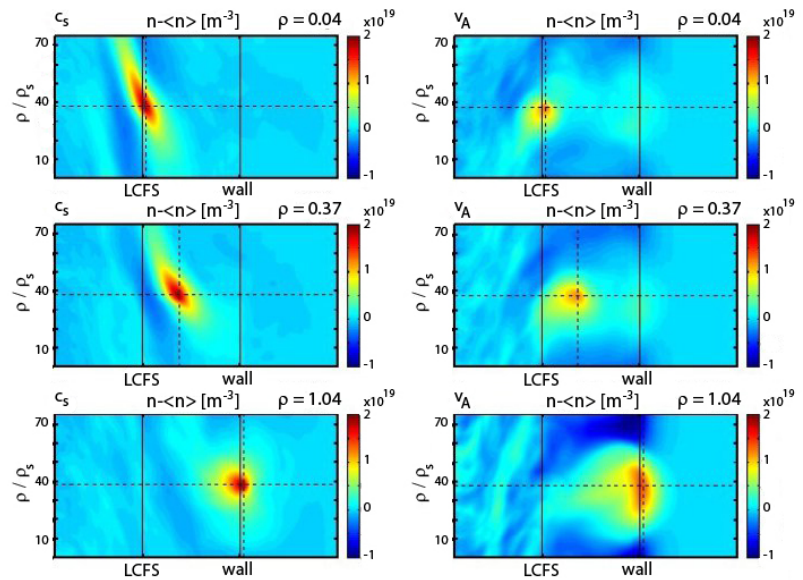

Fig. 2. Conditionally averaged density signal in a 2D domain at three different radial positions in the SOL. Two different parallel velocities are used: c_s (left) and $v_A \sim 80c_s$ (right). The averaging condition is chosen as $(n - \langle n \rangle) > 2\sigma_n$.

EFIT++ development

J. Havlicek

In collaboration with:

L. Appel, EURATOM/CCFE Fusion Association, United Kingdom

The EFIT++ code development carried out by IPP Prague consists of implementation of a computational model to represent the induced currents in the passive structures of the tokamaks. These may be coil cases and the vessel or other structural elements. The modelling is restricted to axisymmetric currents as the EFIT++ code is itself assuming axisymmetry. The model is written entirely in C++ as a consistent set of objects utilizing freeware scientific libraries such as GSL.

All data structures necessary for actual computation of induced currents (matrices of self- and mutual inductances) were prepared. During the year 2009 the development of the model continued by coding and testing of C++ method "computeInducedCurrents" which wraps all previously prepared structures into one working model usable within the EFIT++ to compute currents in the passive structures.

The first (inactive) version of the induced currents model was incorporated into the EFIT++ code and a number of options to control the model were added into the xml input file.

An extended validation of the new induced currents model against existing INDUCTION code was performed.

There is a number of fundamental differences between these two codes although the computed induced currents should be similar. The INDUCTION code is written in Fortran language while new model is written in C++ language. The induced currents model is based on the model described in the article of G.J. McArdle and D. Taylor [1]. The new code uses a variable transformation, which allows to avoid numerical differentiation of the PF coils currents and the plasma current. The new model also uses eigenvalue decomposition to separate the variables in the set of the ODEs describing the induced currents.

The validation of the new model against the INDUCTION shows that there is a number of differences between the results from these codes that still need some work to resolve. At present

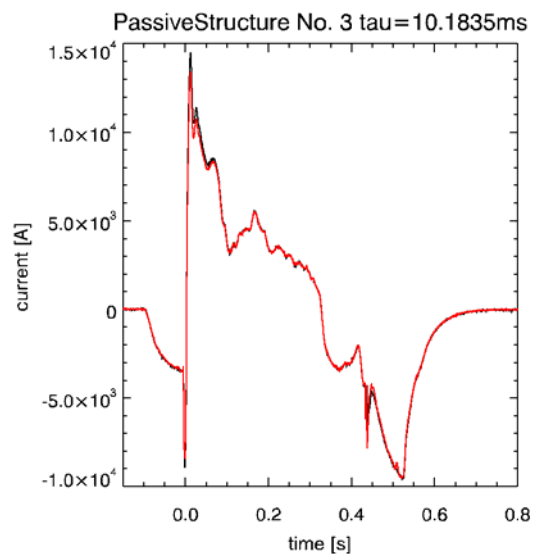

Fig. 1. Computed current in the MAST passive structure located on the LFS. Black: INDUCTION, red: new model.

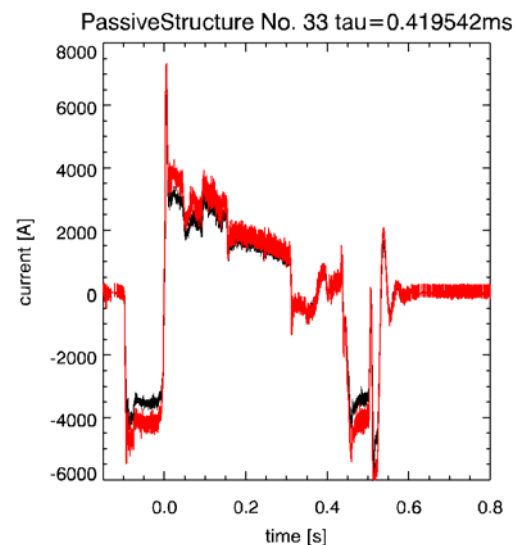

Fig. 2. Computed current in the MAST passive structure located on the HFS. Black: INDUCTION, red: new model.

the status of the validation is this:

- 1) It has been shown that the mutual and self couplings in the INDUCTION code are computed incorrectly. This may result in non-negligible errors of mutual couplings for closely located coils of finite area.
- 2) It was found out that there is a significant difference between the new code and INDUCTION in the level of the induced currents noise. The MAST induced currents computed by the INDUCTION module showed much smaller noise than the new induced currents model (~10% noise to signal ratio). This is because of the smoothing scheme applied in INDUCTION that is not present in the new induced currents model.
- 3) A bug was found and fixed in the new induced currents model code. An implicit integration scheme was incorrectly implemented.

There are still several issues remaining to be solved before the new model can be declared ready for use. These issues are:

- 1) There are small (<1%) spikes in computed induced currents in the new induced currents model every time after new PF coils currents are supplied to the code. These spikes are unphysical and must be removed by finding and repairing the reason for them in the new code.
- 2) There is a huge difference (~10%) in the computed induced currents between the two codes during plasma breakdown and during plasma collapse at the end of the plasma ramp-down phase (Fig. 2).
- 3) There is a significant difference during plasma current ramp-up and ramp-down phase. It was found that this difference is present only when plasma current is used during computation of the induced currents. Therefore the problem is in the addition of the plasma current influence to the induced currents

The work planned for the year 2010 (resolution of the aforementioned issues and exploitation of the EFIT++ for COMPASS operation) was postponed due to unexpected problems in commissioning of COMPASS Fast Amplifiers for plasma position stabilization. The contributor's effort was reallocated to solve the problems. The milestones (1. development of robust operational scenarios of efit++ for COMPASS, 2. use reconstructed equilibria to optimize COMPASS vertical plasma position control algorithm) were not fulfilled due to the fact that COMPASS didn't have functional plasma position stabilization.

It is supposed that the work on the benchmarking the new induced currents model against the INDUCTION code will be performed in the year 2011.

References:

- [1] G.J. McArdle and D. Taylor, *Fusion Engineering and Design*, 83 (2008) 188

Investigation of interactions of perturbation field with plasma

P. Cahyna

In collaboration with:

M. Becoulet, E. Nardon, G. Huysmans, Association EURATOM-CEA

A. Kirk, Association EURATOM-CCFE

There are theoretical reasons indicating that the magnetic perturbations used to suppress ELMs on DIII-D may be substantially modified by the plasma response. This may be the explanation of very different results obtained on DIII-D and MAST. One way by which the plasma modifies the field is the appearance of screening currents. We have developed a model of the screening field and found that screening may be manifested in a modification of divertor strike point shapes.

Resonant magnetic perturbations by external coils are a promising method for ELM control. In order to elucidate the mechanism of this still very poorly understood method the actual magnetic field inside the plasma has to be known. The vacuum field of the coils can be substantially modified by the plasma response, which may screen the perturbation field by inducing eddy currents on the rational surfaces. Bifurcated equilibrium states may exist: a state where the perturbation is almost completely screened at the rational surface, and a state where the rotation is locally stopped and the perturbation is close to its vacuum value. The latter is called penetration of the perturbation.

One significant aspect of resonant magnetic perturbations is the destruction of the magnetic separatrix which is replaced by two surfaces - the stable and unstable invariant manifolds of the X-point. Inside those manifolds are field lines which reach the plasma core. The intersections of the manifolds with the divertor delimit areas where high heat flux arrives from the plasma to the divertor plates. Those areas form characteristic spiralling patterns, called divertor footprints. One may ask what is the influence of the plasma response to the RMPs on the divertor footprints. Using a code which represents the assumed screening currents on rational surfaces, we demonstrated that the footprints may be significantly modified. We did the calculations of footprints for the cases of MAST and JET and compared with the experimental results. The calculations show reduction of footprints (Fig. 1) under the assumed screening (expected in H-mode due to the pedestal pressure gradient), which agrees with the experimental observations showing footprints only in L-mode in both MAST and JET [1].

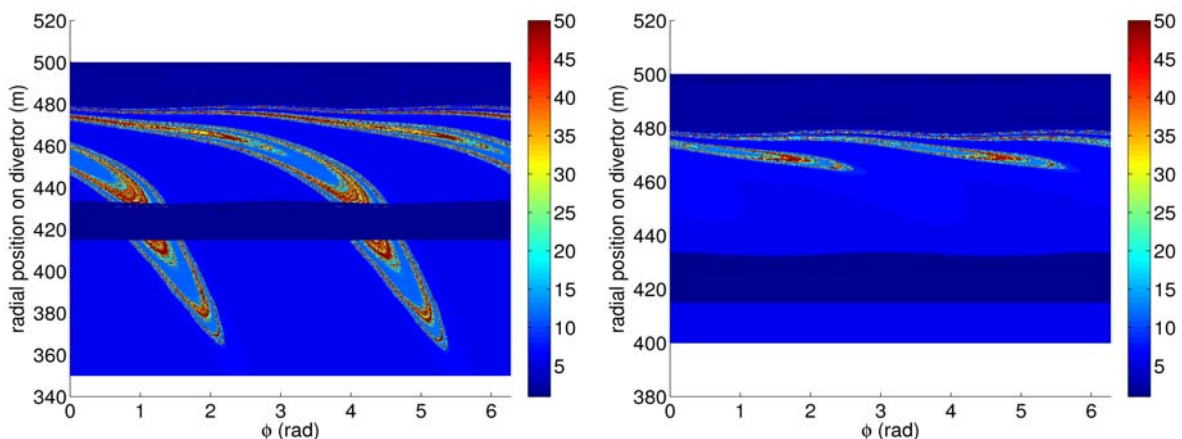

Fig. 1. Footprints at the HFS strike point of JET for an ELM mitigation experiment, predicted for the vacuum perturbation field (left) and screened field (right).

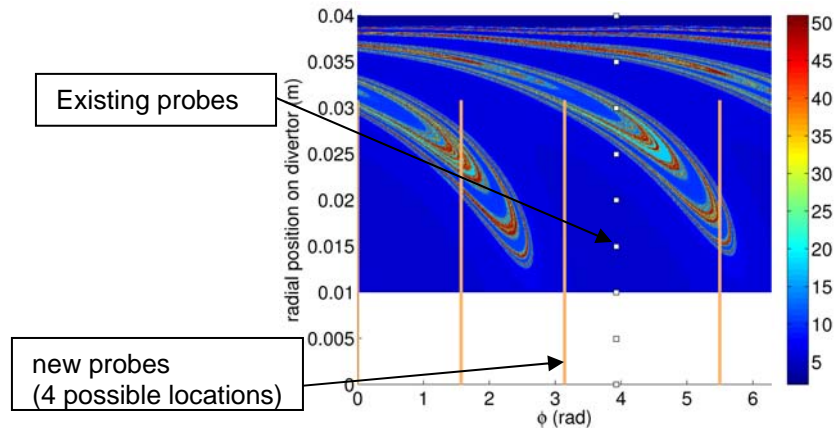

Fig. 2. Footprints at the HFS strike point of COMPASS, with the location of the existing divertor probes and the possible positions of the planned probe arrays.

We are using similar calculations for COMPASS for the design of new divertor probe arrays which will be used to detect the footprint structure (Fig. 2).

The aforementioned results were obtained using an assumption of complete screening on a range of magnetic surfaces. Ideally, the screening would be obtained self-consistently by a model of the plasma. For this purpose we are using the code RMHD by G. Huysmans and M. Becoulet. It is a reduced MHD model using an approximation where the plasma is treated as a straight cylinder with a circular cross-section. This approximation makes possible to separate the problem into independent poloidal harmonics in addition to toroidal harmonics, which makes the code very fast. The latter fact requires the use of a hybrid approach: we simulate the plasma response with RMHD and the resulting screening factors are used as an input to the model of screening currents, which operates in the realistic geometry and can predict the footprints. We developed the methods for coupling the two codes and tested them on DIII-D data.

The sensitivity of divertor footprints to screening is explained by the fact that the footprints are correlated with the resonant perturbation modes at the edge, which also produce magnetic islands and field line stochasticity, and are suppressed by the screening, which itself is sensitive only to the resonant components. The footprint length and field line stochasticity should thus depend only on the resonant components of the perturbation, regardless of the presence of screening. Limitations of this theory may be shown by recent MAST experiments, where similar resonant perturbation strength was obtained or even and odd parity perturbation coil configurations and the results were very different. We got only part of one experimental day for this experiment, so it is not yet clear if this result is due to the difference in resonant component which was still present or to another mechanism such as coupling to MHD modes [2], and this research will need to be continued.

References:

- [1] E. Nardon, P. Cahyna, S. Devaux et al., *Journal of Nuclear Materials* (2011) doi:10.1016/j.jnucmat.2010.10.072
- [2] Y.Q. Liu, A. Kirk, E. Nardon, *Physics of Plasmas* 17 (2010) 122502

Magnetic perturbations for runaway electron mitigation

P. Cahyna, R. Papřok

In collaboration with:

V. Riccardo, D. Howell, Association EURATOM-CCFE

We developed a code for runaway electron orbits in the presence of magnetic perturbations. The simulations for JET discharges where the mitigation of runaway electrons was actually attempted showed that the used Error Field Correction Coils (EFCCs) and toroidal field ripple do not cause a diffusion of runaway electrons and thus no effect is expected. This agrees with the negative experimental results.

The electron collision frequency and the drag on the moving electron caused by the collisions decrease with the electron's velocity. When the electron is being accelerated by the electric field, above a certain critical velocity the drag drops below the accelerating electric force and the electron velocity increases more and more, eventually to relativistic energies. Such electrons are called runaway electrons (REs). They are occurring especially during a disruption. During the current quench phase of the disruption the plasma current decays and its significant portion may be converted to runaways. When the beam of runaways eventually hits the wall, it may cause a localized damage to the plasma-facing components.

Runaway beam formation may be prevented by enhanced diffusion. In ITER the dominant source of runaways will be the avalanche mechanism, where new runaways are produced by collision of existing ones with slower electrons. One mechanism for enhancing their losses are magnetic perturbations [1]. If the trajectories of REs become chaotic as a result of the perturbations, the REs eventually hit the wall and can't induce further secondary REs, so the avalanche is suppressed.

The magnetic perturbation technique was tested on JET using the perturbation field of the EFCCs (Error Field Correction Coils). Experiments have not shown any impact of the EFCCs on REs [2] despite positive results from other tokamaks [3]. In order to explain the JET experimental results we performed simulations of the RE trajectories in the field of the JET EFCCs and the TF ripple. The REs were modelled as single test particles (without interactions with other particles) moving in the field of the EFCCs and the plasma. The total field was obtained as a superposition of those two. We did the simulations for energies in the range of RE energies in JET disruptions: 5 MeV, 10 MeV and 20 MeV, for several configurations of the EFCCs corresponding to the experiments and several plasma equilibria (due to the uncertainty in determining the plasma current profile during a disruption). All results are similar: the Poincaré plots show regular surfaces, with islands which are however too narrow to overlap (representative results are shown in Fig.1). No stochastic diffusion was observed. This result may explain the absence of any effect in experiments. Another type of magnetic perturbation is the toroidal field variation (ripple), caused by the discrete nature of the toroidal field coils. Theoretical arguments show that RE trajectories can be influenced by the ripple [4]. RE control was attempted using the ripple introduced by the JET toroidal field coils. However the ripple is too weak for the theoretically envisaged mechanism to cause a diffusion of REs [2]. The experimental results are in agreement: no effect on REs was observed [2]. We performed also simulations of RE trajectories in the ripple field and results were similar to those with the EFCCs and in agreement with the experiment: no diffusion of REs was observed.

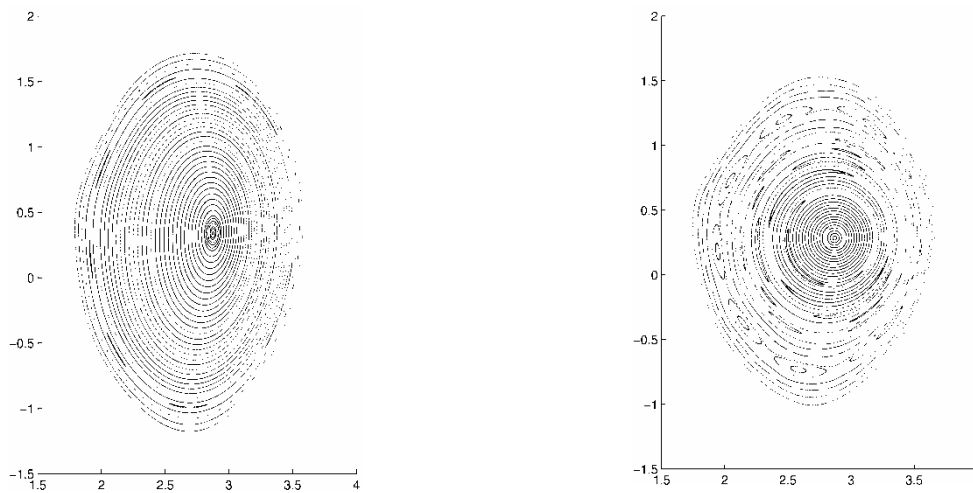

Fig. 1 Poincaré plots of runaway trajectories for the $n=1$ configuration of all the four EFCCs, 1.3 kA current, flat current equilibrium (left) and peaked current equilibrium (right), JET shot #75352.

References:

- [1] P. Helander, L.-G. Eriksson, F. Andersson, *Physics of Plasmas* 7 (2000) 4106
- [2] Riccardo, V., et al. (2010). *Plasma Phys. Control. Fusion* 52 (2010) 124018
- [3] Lehnen, M., et al. *Phys. Rev. Lett.* 100 (2008) 255003
- [4] Rax, J., et al. New ideas in tokamak confinement, chap. Runaway dynamics in tokamaks, p.154. American Institute of Physics, 1992.

**Erosion, Transport and Deposition of Low-Z Wall Materials
(WP10-PWI-04)**
**Modeling and Measuring of Chemical Erosion of Low Z-materials in
Tokamaks for Plasma at Low Temperatures Including the Impact of
Seeding Gases
(WP10-PWI-04-04)**

Z. Herman

J. Heyrovský Institute of Physical Chemistry, Academy of Sciences of the CR

In collaboration with:

Institute for Ion and Applied Physics, University of Innsbruck, Innsbruck, Association EURATOM-ÖAW, Austria (Research Groups of Prof. T. D. Märk and Prof. P. Scheier.)

Studies are aimed at interaction of seeding gas ions like Ar^+ or N_2^+ and C1, C2 hydrocarbon ions with surfaces of carbon or modified carbon and Be or modified Be to obtain information on sputtering of ions, chemical reactions and projectile ion dissociation at surfaces, energy transfer and ion survival in collisions with surfaces.

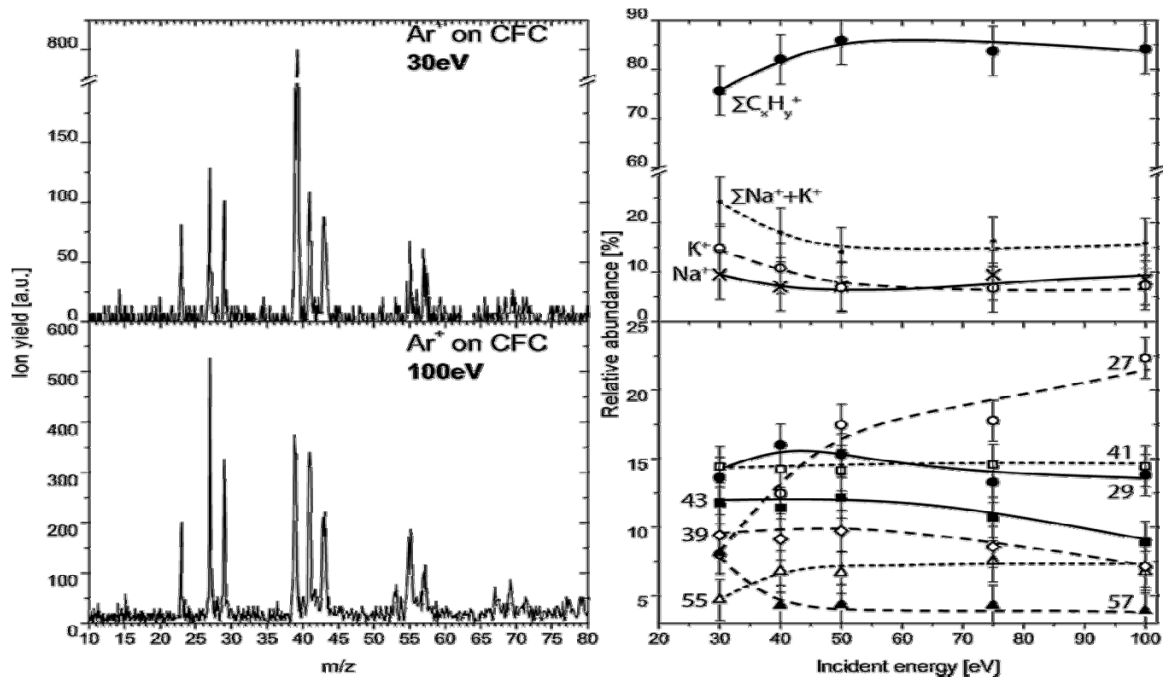

Fig. 1. Product ions from collisions of Ar^+ with room temperature CFC surface. Left: mass spectra, incident energy 30 eV and 100 eV. Right: Rel. abundance of the sum of all land specific sputtered hydrocarbon ions, and K^+ and Na^+ as a function of incident energy of Ar^+ .

1. Interaction of seeding gas ions Ar^+ and hydrocarbon ions with carbon-fibre-composite (CFC) surfaces kept at room temperature.

Surface-induced interactions of projectile ions Ar^+ and hydrocarbon ions CD_3^+ , CD_4^+ , $C_2D_2^+$, $C_2D_4^+$, $C_2D_5^+$, $C_2D_6^+$ with room-temperature (hydrocarbon-covered) surfaces of carbon-fibre-composite (CFC) were investigated over the incident energy range of the projectile ions from a few eV up to about 100 eV using a special beam-surface tandem mass spectrometer BESTOF. Mass spectra of the product ions and their dependence on the incident energy (ERMS, energy resolved mass spectra) of the projectiles were obtained.

Mass spectra obtained with the projectile ion Ar^+ (Fig. 1) contained only sputtered ions from the surface material, namely alkali ions K^+ and Na^+ and the usual ions characterizing sputtering of surface hydrocarbons.

The results obtained with hydrocarbon ion projectiles showed that the extent of fragmentation of the incident molecular ions and their chemical reactions at surfaces (in case of radical cations) were similar to the interactions of these ions with room temperature carbon (HOPG) surfaces (see Fig. 2 for collisions of CD_3^+ and Fig. 3 for other hydrocarbon ions).

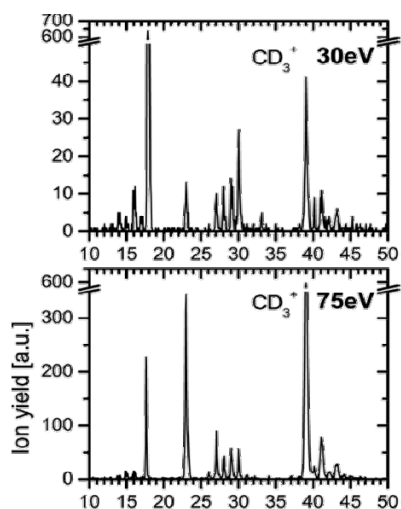

They indicate that the hydrocarbon coverage of the surfaces primarily determines both the energy transfer at surface and its chemical reactivity. The only substantial difference was in that the mass spectra contained a significant amount of sputtered alkali ions K^+ (m/z 39) and Na^+ (m/z 23), most probably contaminants of the CFC material from the process of their production.

Fig. 2. Mass spectra of product ions from collisions of CD_3^+ of incident energy 30 eV and 75 eV with a room-temperature CFC surface.

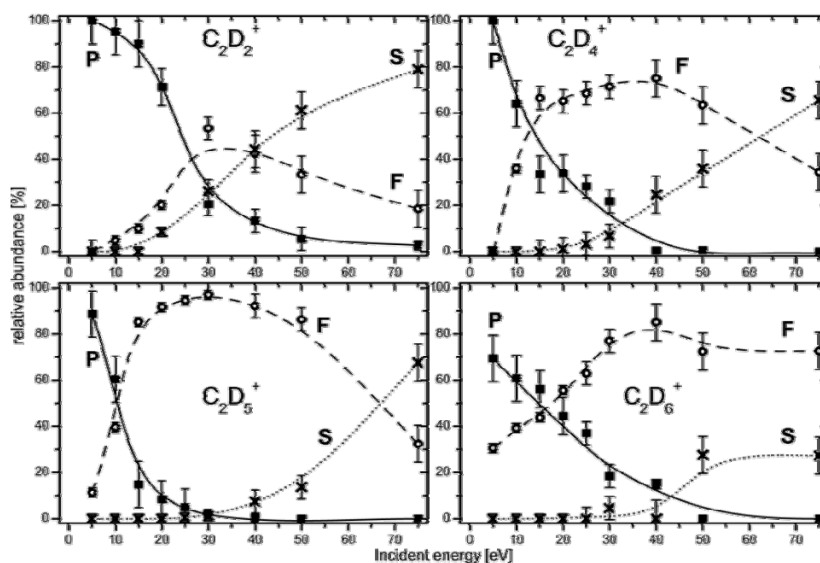

Fig.3. ERMS curves of product ions from collisions of C_2D_2^+ , C_2D_4^+ , C_2D_5^+ , and C_2D_6^+ with a room-temperature CFC surface. P - inelastically scattered undissociated projectile ions (full squares, full line), F - sum of all fragment ions (open points, dashed), S - sum of all sputtered ions (crosses, dotted).

References

- [1] A. Keim, B. Rasul, N. Endstrasser, P. Scheier, T.D. Märk, Z. Herman: „Interaction of small hydrocarbon ions C1 and C2 with carbon-fiber-composite (CFC) surfaces at room temperature”. Int. J. Mass Spectrom. (accepted).

PIC Study of Plasma Fluxes falling in Castellated Gaps between Tiles

R. Dejarnac, M. Komm, J. Horacek, R. Panek, J. Stockel

In collaboration with:

J. P. Gunn, Association EURATOM-CEA Cadarache, St Paul-lez-Durance, France.

D. Tskhakaya, Association EURATOM-OAW, Innsbruck, Austria.

A. Wolff, Czech Technical University in Prague, Czech Republic.

Particle and power fluxes are studied in the vicinity of gaps between divertor tiles using a in-house 2D particle-in-cell code. The effect of changes in the orientation of the gap with respect to the magnetic field direction is studied for optimising the total ion flux falling into the gap. The power load falling onto the protruding part of a gap edge due to misalignment is also investigated for ITER strong transient plasma conditions and the temporal evolution of the whole monoblock temperature due this transient, high heat flux is also calculated.

Results presented in this report comes from our 2D PIC code (SPICE) that has already been used to perform studies in similar geometry [1,2,3,4].

First of all, particle fluxes inside a gap between tiles are investigated as a function of the field line orientation with respect to the gap direction. We know from previous studies that the plasma is deposited only on one side of the gap for both poloidal (PG) and toroidal (TG) gap orientations. Here, we are interested in the plasma deposition inside a gap when its orientation is changed from a TG to a PG. Surprisingly the total amount of particles inside an entire gap does not remain constant when we change the orientation of the gap. Fig. 1 shows the total particles deposited in a gap as a function of α_{scan} , the orientation of the field line with respect to the gap. An angle of $\alpha_{scan} = 0^\circ$ corresponds to a TG and $\alpha_{scan} = 90^\circ$ corresponds to a PG. The dashed line (blue) represents the integral of the particle flux along one gap side and the dot-dashed line (red) to the integral of the particle flux along the other gap side. The black curve is the sum of these two values and represents the total deposition in the whole gap.

We can see that the plasma is deposited gradually from one side to the other as a function of the angle but that the total number of particles in the gap is not conserved. We observe a minimum in the total deposition curve for $\alpha_{scan} = 45^\circ$. This is due to the formation of a relative, positive bump on the potential drop at the gap entrance which operates like a gate and deflects a fraction of the incoming ions to the next tile, preventing them to enter the gap. However, the price gained in the particle deposition inside gaps by tilting the field lines by 45° might be lost with the effort in shaping (all) the tiles in order to protect not only PGs but also TG edges. This might be a (too) huge effort for the reward.

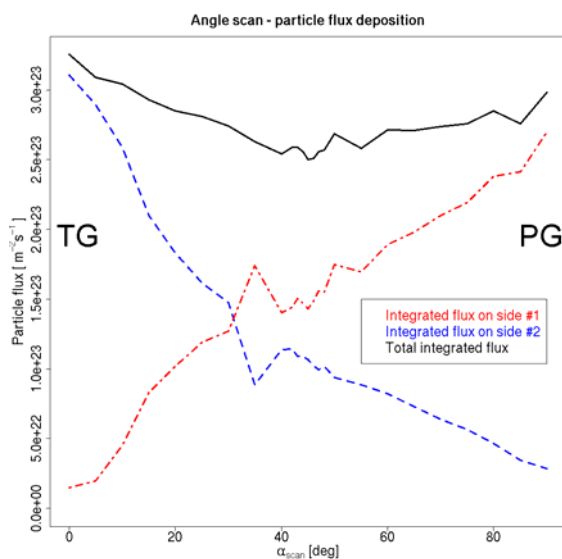
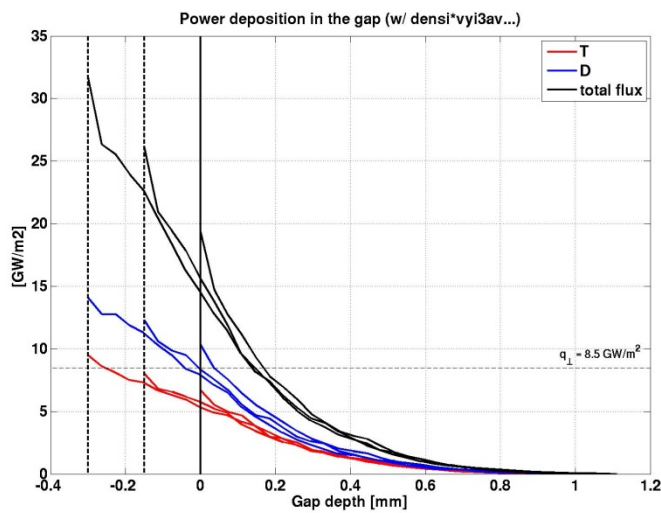

Figure 1: Integrated particle flux of side #1 (blue --) and side #2 (red -.) of a gap as a function of the orientation of the field lines with respect to the gap. The total integrated flux is shown in black (-).

Power fluxes impinging on the gaps between misaligned edges of 2 consecutive tiles during high, transient plasma conditions (ELM) have been evaluated. The results of the computations show that the power deposited to the protruding edges is lower than the one expected without taking into account particle orbits. Fig. 2 shows the power deposition profiles in a 1 mm PG calculated by SPICE for 3 misalignments ($b = 0, 0.15$ & 0.30 mm) for ITER ELMy conditions. We observe a deposition only on one side of the gap and a higher flux deposition with increasing misalignment b , which is coherent. However, due to the misalignment and the glancing field line angle, the side of the monoblock which is protruding is now almost normal to the magnetic field lines and we would expect a power flux closer to the parallel flux ($q = 150$ GW/m² for those plasma conditions). This is not the case and we observe that the power flux falling on the larger misalignment of 0.30 mm has an absolute value 5 times lower.



This feature can be explained by a Larmor radius effect. For those strong plasma conditions we have Larmor radii of the ions considerably larger than the misalignment and the power needs to be spread over distance covering at least two Larmor radii to reach the maximal value (i.e. parallel flux).

Figure 2: Power deposition profiles in a PG for ITER ELMy conditions and 3 misalignments ($b = 0, 0.15$ & 0.30 mm) with an equal mixture of D and T.

This result is more optimistic than the expected one without taking into account particle orbits, even if the absolute values are still high from the material point of view. These values represent estimates for the case of transient events and thus does not depend on the presence of active cooling or not, therefore they could be used to estimate transient melting of the edges.

Finally, the temporal evolution of the tile temperature during an ELM in ITER has been calculated using temporal and spatial profiles in [4] as input parameters for a in-house 3D matlab code. This code solves the Fick's law to calculate the temperature evolution in the entire tile. The code has been benchmarked against an analytical solution and the calculations have been made for two tile materials, carbon and tungsten, for 4MJ ELMs. Results show that the erosion of the tile due to sublimation is not significant in the case of carbon and that the melting temperature is not reached in the case of tungsten.

References:

- [1] R. Dejarnac and J.P. Gunn, J. Nucl. Mater. **363-365** (2007) pp. 560-564.
- [2] R. Dejarnac et al., J. Nucl. Mater. **382** (2008) pp. 31-34.
- [3] R. Dejarnac et al., J. Nucl. Mater. **390-391** (2009) pp. 818-821.
- [4] R. Dejarnac et al., IEEE Transactions on Plasma Science, vol. **38**, no. 4, April 2010.

Development of the 3D PIC code for modelling of intersecting gaps

M. Komm, R. Dejarnac

In collaboration with:

J. Gunn, Association EURATOM-CEA Cadarache, France

D. Tskhakaya, Association ÖAW-EURATOM Innsbruck, Austria

The particle-in-cell simulations of gaps between castellated plasma-facing components allow to predict heat loads on divertor tiles in ITER. This topic was already targeted by means of 2D simulations (SPICE2 code) but these required the poloidal and toroidal gaps to be simulated separately. The presence of gap crossings in real PFCs questioned the validity of these results, as important effects were expected to take place there.

In order to simulate plasma behaviour in the vicinity of a gap crossing, a new full 3D3V PIC code SPICE3 had to be developed. Although most of the routines were based on SPICE2 algorithms, the code had to be equipped with new Poisson solver and boundary checking algorithm. Special care had to be taken on optimization of the code, as 3D particle-in-cell simulations are extremely demanding on computing power.

The code was successfully benchmarked against SPICE2 and SPICYL codes and used to simulate the behaviour of the Katsumata probe.

The preliminary simulations of gaps revealed presence of electrons in plasma shadow of the poloidal gap, which is in contrary with 2D simulations and a clear consequence of the gap crossing. This has influence on the plasma penetration inside the gap. A hotspot with elevated heat flux was localised near the crossing.

The heat loads acting on ITER plasma-facing components are of interest because of engineering limits related to tile materials [1]. Localized elevated head loads could lead to a damage of the tiles, shortening its life time. In order to withstand thermal stresses, the tiles have to be castellated – split into small blocks separated by gaps. While the top surface of tiles has oblique angle with respect to the magnetic field, spreading the heat load over a large surface, the leading edges of the poloidal gaps are almost perpendicular to the incoming flux.

In order to predict the distribution of heat loads in the vicinity of the gaps, a series of numerical simulations has been performed by using the SPICE2 code, both for steady state plasma conditions [2] and during ELMs [3]. The SPICE2 code is a Cartesian particle-in-cell code, which allows to follow trajectories of individual particles in a self-consistent electric field (the magnetic field is assumed static). The simulations of poloidal gaps have revealed that there is a typical positive potential structure, which forms close to the gap entrance. This structure acts a a barrier for ions, preventing them from penetrating deep into the gap. The structure is also responsible for a zone of elevated heat and particle flux on the plasma-wetted side of the gap.

The 2D simulations assume infinite length of the gap, while real PFCs have finite dimensions and the gaps are intersecting in crossings. In order to investigate the role of the crossings, a full 3D PIC code had to be developed. The particle-in-cell method is highly demanding on computational power in general, and the 3D simulations have only been made possible due to improvement of available hardware in the past decade. The SPICE3 code is an extension of SPICE2, with some new algorithms required for 3D calculations. The most important one is a new fast multigrid poisson solver, which only takes ~5% of the iteration time. The boundary checking routine had also been redesigned in order to prevent particles from crossing corners

of the tiles. The code went through detailed optimization, which resulted in a speed up 1.7x comparing to the initial version. Further optimization is still expected in future.

The SPICE3 code was first used to simulate infinite gaps, which allowed benchmarking against SPICE2. Once the agreement was verified, preliminary simulation of the crossings has been carried out. The simulated plasma parameters were: $n=2.10^{18} \text{ m}^{-3}$, $T_e=25 \text{ eV}$, $T_i=50 \text{ eV}$, $B=2 \text{ T}$. The gap was 0.5 mm wide and the magnetic field had inclination of 20 degrees with respect to the top tile surface. While these conditions are not too far from plasmas in contemporary machines, they are far from conditions expected in ITER. The preliminary simulation was however useful to identify mechanisms related to the crossings.

The simulations showed presence of electrons inside the plasma shadow of the poloidal gaps, which is in contrary with the results of the 2D code. The electrons are pushed inside the poloidal gap at the gap crossing, as the potential structure, which form near gap entrance, gives rise to an ExB drift in the direction parallel to the gap. Once the electrons enter the plasma shadow, the positive space charge is balanced, which leads to reduction of the potential structure. This has an impact on ion penetration into the gap. The potential structure repels ions and as such acts as a barrier, preventing them from flowing deep into the gap. When the structure is reduced, ion flux along the gap sides decays exponentially as showed in Fig. 1.

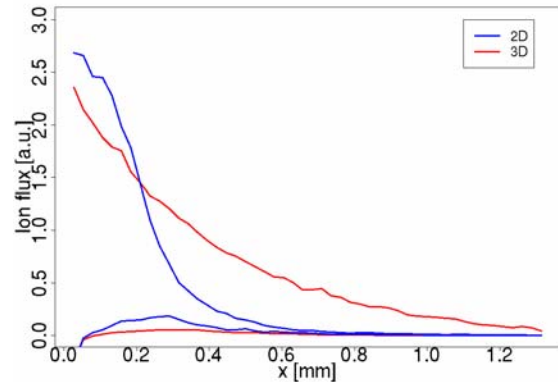

Fig.1: Distribution of ion fluxes simulated by the 2D code (blue) and 3D code (red)

The combination of plasma flow, which dominates the poloidal gaps, and the ExB drift, which plays an important role in the toroidal gaps creates a hotspot with elevated particle and heat flux. This hotspot is located in the toroidal gap close to the crossing and the heat flux is cca 70% percent higher comparing to 2D simulation results.

References:

- [1] T. Loarer, *J. of Nucl. Mater.*, 390-391, 20-28, 2009.
- [2] R. Dejarnac and J.P. Gunn, *J. Nucl. Mater.*, 363-365, 560-564, 2007.
- [3] R. Dejarnac, M. Komm, J.P. Gunn, R. Panek, *J. Nucl. Mat.*, 818-821 (2009),390-391

Combined SPICE2/3DGAP simulations of carbon deposition in divertor gaps

M. Komm, R. Dejarnac

In collaboration with:

D. Matveev, Trilateral Euregio Cluster, Ghent University, Belgium

A. Kirschner, Trilateral Euregio Cluster, FZK Jülich, Germany

Plasma penetration into gaps of castellated plasma-facing components is of high interest because of the risk of fuel retention in ITER. Experiments show that carbon can form hydrocarbons layers, with significant fuel content once it is present inside the machine. The layers are deposited in shadowed areas of the vessel, which include gaps between the tiles of PFCs. In order to understand the carbon transport and layer formation, a neutral transport code 3D-GAPS has been developed at Forschungszentrum Jülich. The simulations involve a number of parameters (erosion probability, sticking probability etc), which are not known from experiment. The aim of the simulations is to find a match to experimental results by variation of these parameters.

In order to make the simulations realistic, the distribution of particle flux coming from plasma has to be taken into account. This was simulated by using the 2D particle-in-cell code SPICE2. The simulations allow detailed study of the plasma behaviour in the vicinity of the gaps, namely the amount of particles entering the gap and the depth of plasma penetration. A series of simulations for typical TEXTOR conditions has been performed and the results have been used as input for the 3D-GAPS code.

The simulations revealed that plasma behavior can be in two different regimes: potential – and geometry-dominated with distinct profiles of plasma flux falling onto the sides of the gap.

The shaped gaps are gaps with modified geometry, which protects the leading edge of the tile from direct plasma flow. A series of simulations with varying amount of shaping has been performed In order to estimate its effectiveness.

Fuel retention in nuclear fusion devices is a subject of intensive research, especially because of implications for ITER and future reactors, which will operate with tritium. For safety reasons, the amount of tritium inside the ITER vessel is restricted to approximately 1 kg, and so its accumulation leads to a limitation of the number of discharges which can be performed before the safety limit is reached. Current experiments show that the fraction of retained fuel varies between 2 - 20 percent depending on the machine and method used for analysis. The plasma facing components (PFCs) have to be castellated - split into small blocks separated by gaps, in order to withstand thermal stresses caused by plasma heat loads and induced currents. Measurements at DIII-D show that up to 40% of the retained fuel can be trapped in gaps between PFCs. Moreover, gaps are difficult to access by cleaning methods, so minimizing the deposition there is of high interest. Studies of the deuterium retention inside the gaps were performed at the TEXTOR tokamak with the so-called test limiter. The test-limiter has regular rectangular gaps as well as shaped gaps, where the leading edge of the gap is hidden from direct plasma flux. Such shaping is expected to reduce in-gap deposition.

In order to understand plasma behaviour in the vicinity of the poloidal gaps, a series of simulations has been carried out using the Cartesian 2D PIC code SPICE2. The simulations revealed that due to the difference in Larmor radii of ions and electrons, there is a positive space charge near the entrance of the gap, which leads to a formation of a typical positive potential structure. This structure acts as a barrier for ions, preventing them from flowing

deep into the gap. The size of this structure (maximum of the potential of the structure) is a function of the Debye length.

Shaped gaps are gaps with modified geometry, where the top surface of the tile is inclined so that the leading edge of the gap is protected from direct plasma influx. Poloidal gaps with pronounced shaping ($H = 3$ mm) were simulated by SPICE2 to replicate the geometry of the TEXTOR experiment. However, such shaping is not ITER relevant, as the inclination of the magnetic field with respect to the top tile surface is 40 degrees (ITER tiles should have inclination 1 – 4 degrees). The purpose for such exaggerated shaping was to demonstrate the effects, which are connected with the modified geometry. The simulations show indeed a well developed potential structure in plasma shadow, which protects the leading edge. However, the plasma is diverted by the structure towards the plasma shadowed side of the gap, which receives high particle flux.

The scan in H was performed in order to investigate the influence of shaping on plasma behaviour. It was observed, that for more ITER relevant shaping ($H = 0.2$) the flux profiles already resemble to the unshaped case.

The results of SPICE2 simulations were used as input for the 3D-GAPS code. The neutral transport simulations resulted in a good match of deposited carbon profile on gap sides, however experimental data show high deposition at the bottom of the gap, an unexpected phenomena, which was not replicated by simulations. This disagreement has not yet been explained, however there are indications that it may have been caused by the occurrence of off-normal events during the experimental campaign.

Edge2d modeling of ponderomotive density depletion in front of the JET LH grill

V. Petržílka, V. Fuchs, P. Pavlo

In collaboration with:

G. Corrigan, P. Jacquet, J. Mailloux, M.-L. Mayoral, V. Parail, Assoc. EURATOM-UKAEA, Culham Science Centre, Abingdon, OXON OX14 3DB, UK

P. Belo, Association Euratom-IST, Centro de Fusao Nuclear, Lisboa, Portugal

M. Goniche, A. Ekedahl, J. Hillairet, CEA, IRFM, 13108 Saint Paul-lez-Durance, France

J. Ongena, Plasma Physics Laboratory, RMA, Brussels

At low Scrape-off-Layer (SOL) density n_{SOL} , a gas puff is frequently applied at lower hybrid (LH) heating at JET, in order to increase the LH density and to decrease the reflection coefficient R . However, in absence of a sufficient amount of the neutral gas in front of the grill, the observed reflection coefficient R of the grill can increase as a function of the LH power PLH . This R increase is caused by a decrease of the SOL density n_{SOL} just in front of the grill mouth. Similar effects observed on ASDEX [1] and recently on Tore Supra [2] were explained by expulsion of the plasma from the grill mouth along magnetic field B -lines by ponderomotive forces of the launched LH wave [1,3].

In order to explore the ponderomotive force effects on JET, the EDGE2D code was now modified in order to include the ponderomotive forces: In the momentum equation for the electron fluid, a net force [1, 3] acting on electrons due to the LH field gradient was included in EDGE2D. In the figures, we show results for the JET shot #66972.

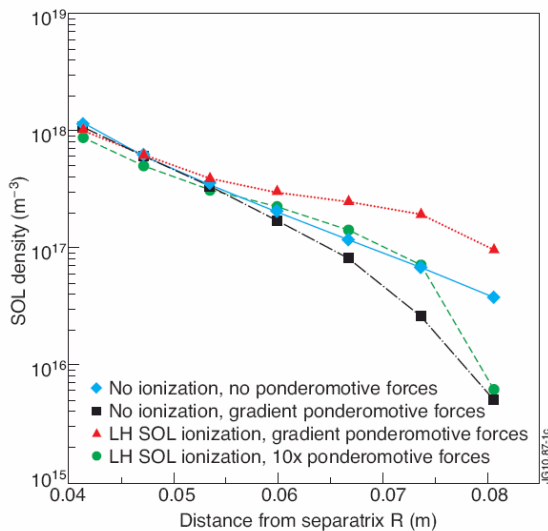

Fig. 1. Density depletion due to ponderomotive forces, no gas puff.

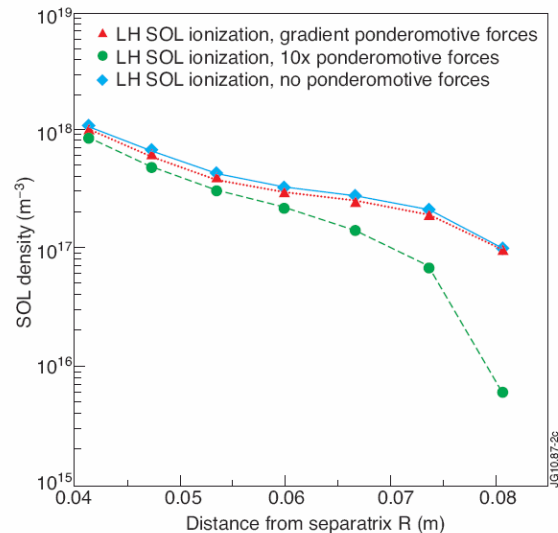

Fig. 2. Density depletion, ponderomotive forces, ionization, no gas puff.

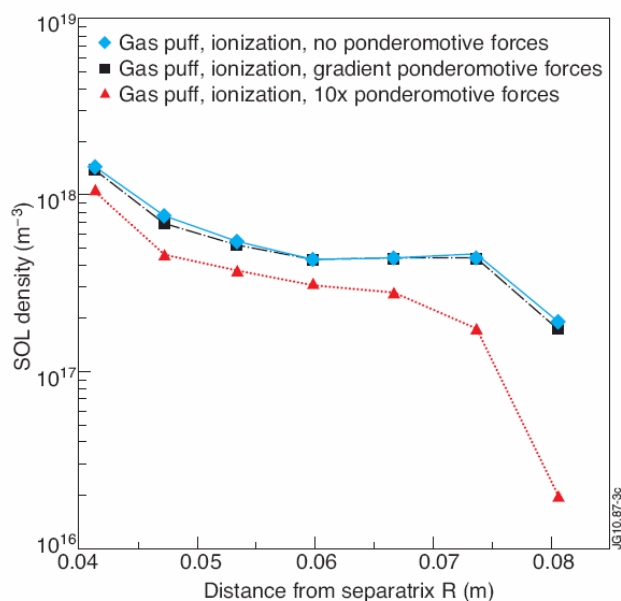

Fig. 3. Effects of the gas puff

Conclusion: (i) Without taking into account the gas ionization in front of the grill mouth, the computed density in front of the grill can decrease significantly due to the ponderomotive depletion for launched LH powers of about 5 MW (about 20 MW/m²). (ii) The ponderomotive forces are not strong enough to expel the plasma from in front of the grill mouth, when the direct ionization by the LH wave is taken into account. (iii) For ponderomotive forces about ten times higher, the plasma density would decrease in front of the grill mouth even with the gas puff directly ionized there. Such strong expelling effects could be perhaps provided by locally in front of the grill generated fast electrons, which escape from the grill and create an electric field of charge separation, pushing ions from the locations in front of the grill mouth [5]. The expelling effect of the fast particles needs to be accounted for in future modeling, but the way how to do this is not obvious.

References:

- [1] V. Petrzilka et al., Nuclear Fusion 31 (1991) no. 9, 1758.
- [2] A. Ekedahl et al., Proc. 18th Topical Conf. on RF Power in Plasmas, Gent (2009). AIP Conf. Proc. 1187 (2009) 407.
- [3] V. Petrzilka et al., J. Plasma Phys. 30 (1983) 211; R. Klima, Soviet Phys. JETP 23 (1966) 534.
- [4] M. Goniche et al., Plasma Phys. Control. Fusion 51 (2009) 044002.
- [5] V. Petrzilka et al., 18th IAEA Conference, Sorrento 2000, paper CN-77/EXP4/07.

Comparison of fast electron fluxes generated in front of Passive-Active and Fully-Active Multijunction LH antennas in Tore Supra

V. Petržílka, V. Fuchs, P. Pavlo

In collaboration with:

J. Gunn, A. Ekedahl, L. Delpech, M. Goniche, M. Kubic, J.-Y. Pascal, CEA, IRFM, 13108 Saint Paul-lez-Durance, France

A Retarding Field Analyzer (RFA) was used during lower hybrid (LH) current drive experiments in the Tore Supra tokamak to characterize the supra-thermal particles emanating from the region in front of the C4 Lower Hybrid (LH) Passive-Active-Multijunction (PAM) grill [1]. This work is continuation of our previous measurements on Fully-Active-Multijunction (FAM) launchers [2]. The RFA collects electrons that flow along field lines from the outboard side of the tokamak. The measurements were performed when wave-guide rows of the C4 launcher were magnetically connected to the RFA.

The RFA is mounted on a vertically reciprocating probe drive, situated on top of the torus. The analyzer is biased to collect only supra-thermal electrons with energy greater than 200 eV. Measurements of the full two dimensional spatial distribution of supra-thermal electron flux in the LH hot spots were performed up to the C4 launched power of 1.9 MW. Similarly as for the FAM grills, the beam is several cm radially wide [3]. The beam further then several mm radially from the grill mouth is generated only for C4 powers greater than a threshold value. The beam was probed during controlled scans of injected power and SOL density. The PAM grill generates lower supra-thermal electron fluxes than the FAM grill for identical SOL plasma conditions, as illustrated in Fig. 1 for RFA time averaged collector currents in case of launchers C3 and C4 firing into the same plasma. It is especially unfortunate that higher power levels could not be tested (we had planned to fire 2 MW per antenna). This is partly due to the lack of time available to increase the power, but also due to our choice of an unusual discharge scenario for which the antennas had not yet been conditioned. It should be noted that in the past, intense electron beams were observed with C2 firing 1.5 MW, which would be equivalent to 3 MW on C3 or C4.

An unexpected result is that the edge of the electron beam appears 22 ± 1 mm in front of the nominal position of C3 and 17 ± 1 mm in front of C4, which means the the probe did not systematically fully penetrate the beam as we had anticipated. In most of the previous measurements, the beam edge lay at most 15 ± 1 cm in front of the C2 grill. Perhaps the larger discrepancy is related to the unusually deep grill positions that were used in this experiment. The uncertainty is the sum of uncertainties of the probe position on top of the machine, errors in the magnetic reconstruction, and uncertainties in the position of the antennas. Regardless of the absolute values of the discrepancies, we can conclude that C3 is 5 mm closer to the plasma than C4 for identical nominal positions, confirming observations of hot spots made with the infrared cameras. It would be useful to perform a few more shots to compare C3 and C4 in the standard magnetic configuration to guarantee good coupling conditions at high power.

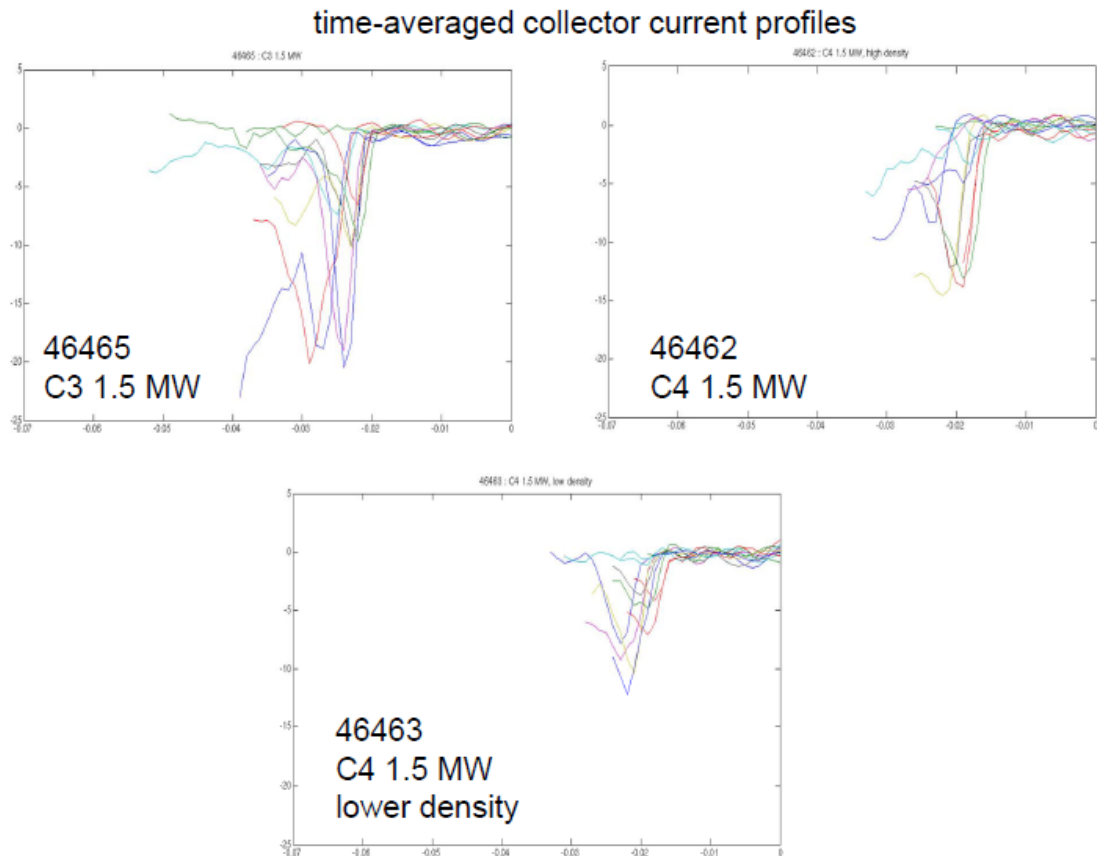

Fig. 1. Time averaged collector currents in μA as a function of the distance from the grill.

References:

- [1] A. Ekedahl, et al., Nuclear Fusion 50 (2010) 112002 (5pp); doi:10.1088/0029-5515/50/11/112002
- [2] J.P. Gunn, et al., J. Nucl. Mat. (2009), doi:10.1016/j.jnucmat. 2009.01.232
- [3] V. Petrzilka et al., *Plasma Physics Controlled Fusion*, accepted for publication

Data analyses for neutron diagnostics at JET using Minimum Fisher Regularisation

J. Mlynář

In collaboration with:

G. Bonheure, Association EURATOM-Etat Belge, ERM/KMS, Brussels, Belgium

A. Murari, Association EURATOM-ENEA, Consorzio RFX, Padova, Italy

S. Popovichev, Association EURATOM-CCFE, Culham Science Centre, Abingdon, UK
and JET EFDA contributors

Previous work [1] demonstrated clearly that tomography based on Minimum Fisher Regularisation (MFR) can substantially contribute to tritium transport studies, when combined with the ratio method and applied on the Neutron profile monitor data. However, the scientific work aimed at data analyses in the neutron diagnostics at JET was rather constrained in 2010 by major JET shutdown due to complete refurbishment of the inner wall of the machine. As planned, completion and publication of the achieved results was in the main focus of the 2010 works, but we also managed to considerably refurbish the software.

In close connection to the task, a review oral presentation on the tomography methods including Minimum Fisher Regularisation (see Fig. 1) was presented on the 6th Workshop on Fusion Data Processing, Validation and Analyses, Madrid, January 25-27 and later published in [2]. After this work, we continued in data analyses from previous campaigns (2007 – 2009) and in software development in view of planned JET campaigns.

Data analyses were in particular linked to the request to continue studies of spatial characteristics of fuel transport shortly after tritium puff in JET plasmas by parallel analyses of D-T (14 MeV) and D-D (2.5 MeV) neutrons. This work was linked to our previous studies [1], [3]. We demonstrated in 2010 that some spatial asymmetries are visible both in tomography and in raw data. Besides, experimental relation between transport parameters and dimensionless quantities were established. The parallel diffusion proved difficult to estimate but probably too fast to explain the observed behaviour, so that other mechanisms (in particular, beam-neutral gas fusion) were proposed. The corresponding publication was finalised but is still under discussion at JET. Selected results of the studies were presented in invited lecture [4] and we also proposed a new promising application of MFR unfolding in the activation experiments [5].

In view of the planned JET campaigns, significant progress was achieved by partial reprogramming of the MatLab routines to the Python environment. At the same time, the core algorithm was further optimised to achieve higher speed. Notice that the Minimum Fisher Regularisation (MFR) package of algorithms is rather extensive, allowing for a rich set-up of constraints and a-priori information. This includes, in particular, preferential smoothing along magnetic flux surfaces (see Fig.1), real width of viewing chords, rapid multi-frame version or zero border condition in tomography, and the L-curve calculation which allows for automatic set-up of the smoothing factor. Installation of the new Python codes that were developed in 2010 at home laboratory into the JET Fedora operation system proved difficult due to obsolete capabilities of Python under Fedora. We had to install 6 Python libraries locally and ask for one library (suitesparse) to be installed directly in the root by the JET network administrator. We also managed to test the data access from the Python environment. Eventually, both the MFR tomography and MFR unfolding computations were run successfully under Python, however, the user interface (ideally GUI), the code optimisation, some of the advanced features and graphics output development, plus extensive testing remains to be done in 2011 as foreseen in the planning.

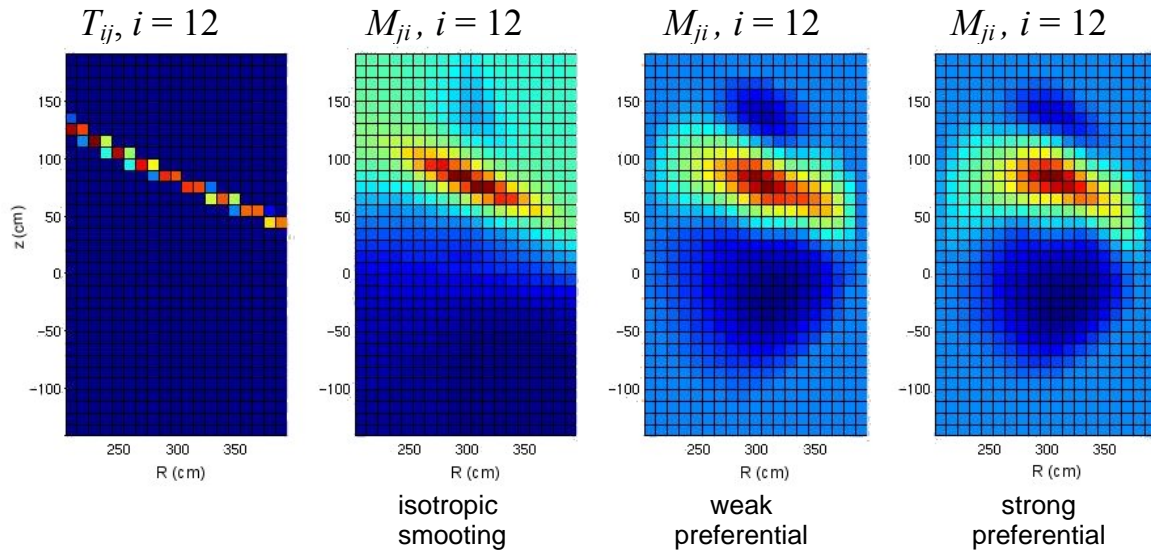

Fig. 1. As part of the calculations for [2], the geometric and the reconstruction matrix of MFR tomography at JET were studied with respect to the method of smoothing. Preferential smoothing along magnetic flux surfaces considerably improves the MFR performance.

Let us also note that the task of reprogramming inversion codes from MatLab to a different system environment (Python) would be normally beyond available working time, however, thanks to the grant support of the Czech Grant Agency we could hire two students who successfully did major part of the work under their summer contract, with a foreseen completion of the works in summer 2011. In general, Python proved to be much less user-oriented environment in comparison to MatLab, which will be missed at JET.

According to the JET operation schedule there is little space for new interesting data in fusion neutrons in campaigns C28-C29 (2011-2012). Therefore it is proposed to temporarily move our interest at JET to rapid tomographic analyses of Soft X-ray measurements, which deserve increased attention due to the new Be-W first wall at JET. As this proposal was welcome by JET task force leaders, we decided to redirect part of our efforts already in 2010 to address this new option, in particular the Python code was extended by implementing the Soft X-ray set-up geometry and data acquisition. It is expected that the neutron diagnostic analyses will regain very high priority in campaigns following C29.

References:

- [1] Bonheure G. et al., Neutron profiles and fuel ratio nT/nD measurements in JET ELMY H-mode plasmas with tritium puff, Nucl Fusion **46** (2006) 725
- [2] Mlynar J., Weinzettl V., Bonheure G., Murari A.: Inversion techniques in the Soft X-Ray tomography of fusion plasmas: towards real-time applications. Fusion Science and Technology **58** 3 (2010) 733
- [3] Mlynar J., G. Bonheure, A. Murari, S. Popovichev and JET EFDA contributors, Experimental studies of spatial characteristics of tritium transport at JET, 36th EPS Plasma Physics Conference, Sofia, July 2009, ECA Vol 33E, P-2.154 (2009)
- [4] Murari A., et al.: New Developments in the Diagnostics for the Fusion Products on JET in Preparation for ITER. Review of Scientific Instruments **81** 10 (2010) 10E136
- [5] Bonheure G. et al.: Charged fusion product loss measurements using nuclear activation. Review of Scientific Instruments **81** 10 (2010) 10D331

2. Development of plasma auxiliary systems

Commissioning of the neutral beam injectors for COMPASS tokamak

J Stöckel

In collaboration with:

A.A. Ivanov, P. Deichuli, V. Kolgomorov, Budker Institute, Novosibirsk, Russian Federation

Two Neutral Beam Injectors (NBI) will be used for additional plasma heating on the COMPASS tokamak. The beam energy is 40 keV and the total power 2x300 kW. The NBIs were manufactured at the Budker Institute, Novosibirsk, Russian Federation and transported to IPP Prague together with their power supplies. The two injectors were commissioned in IPP Prague of situ in the period mid of November – end of December. For the first tests, the NBI's were equipped by additional equipment, such as the pumping, cooling and gas handling systems. The neutral beam was fired into a calorimeter. The first tests show quite promising results. The full energy (40 keV), the expected ion current (12 kA) and an efficiency of neutralization (~70%) were achieved in the pulse length 100 ms. Some modifications of power supplies and prolongation of the beam pulse up to 300 ms will be performed at the beginning of the year 2011.

The two Neutral Beam Injectors (NBIs) were manufactured at the Budker Institute of Nuclear Physics (BINP), Novosibirsk, Russian Federation. Figure 1 shows the engineering drawing of the final version in scale, where key elements of the equipment are seen.

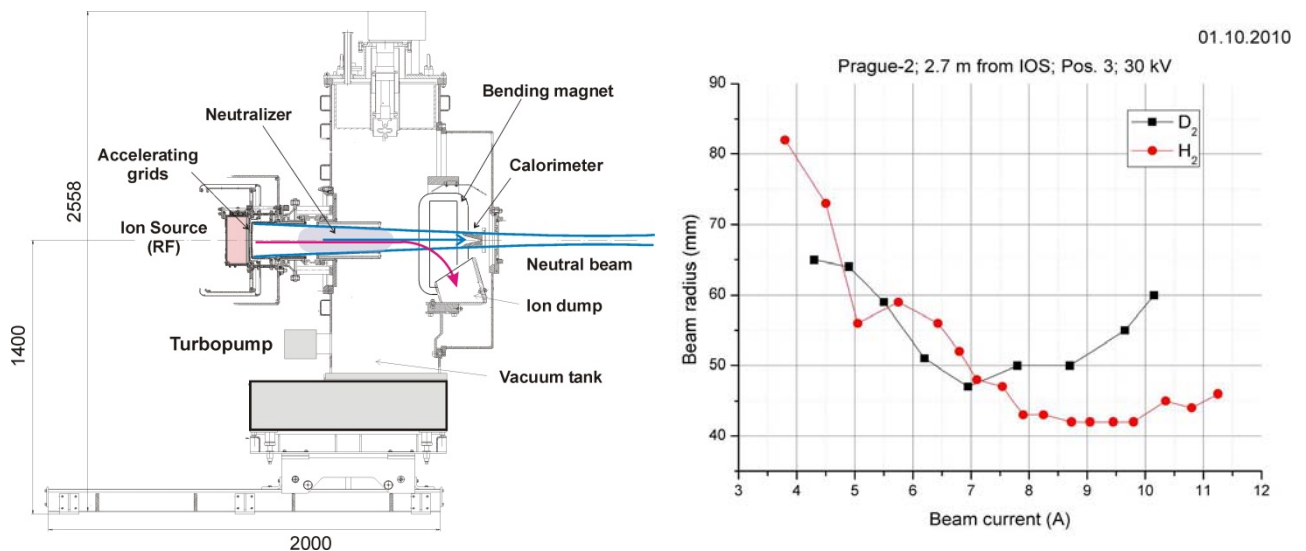

Fig. 1. Left: Engineering drawing of the Neutral beam injectors. Right: Beam radius versus the beam current as measured at BINP.

The NBI's were tested at BINP and the full beam power was achieved with the pulse length 300 ms with power supplies and the test bed of the manufacturer. An example of the dependence of the beam radius on the beam current is shown in the right panel of Fig. 1. The

composition of the neutral beam was measured by spectroscopy from the Doppler shift of Ha line. It was found that 70% of beam atoms have full energy, 23% has one half energy and 5% has one third of energy. Impurities are less than 2%.

The NBI's were transported to IPP Prague together with power supplies at the end of October 2010. The NBI's were commissioned outside the tokamak area, at the ground floor of the COMPASS building, close to the final position of their power supplies. Fifteen experts from BINP were involved in assembling of the NBI's and of the power supplies.

- Power supplies (PS) were assembled and connected to the fly-wheel generators of the COMPASS via a transformer. It was demonstrated that both the PS systems work together as expected.
- Vacuum system consists of two pumping systems. The dry turbo-molecular pumps (one for each NBI) for pre-vacuum and four cryo panels (two for each NBI). The cryo panels are cooled to 4 K by cryo coolers (SUMIMOTO 4K-1.5W closed refrigerator system SRDK415D-F50H). The cryo-panels require pre-cooling by liquid nitrogen (consumption is 200 liters/24 hours/infectior). The pumping speed of the cryo-pump is 100 000 l/s.
- Cooling system for an active cooling of various elements the NBIs by de-mineralized water from the existing station was completed.
- Gas-handling system: to inject the working gas into the injector was purchased. Tests were performed with H₂.

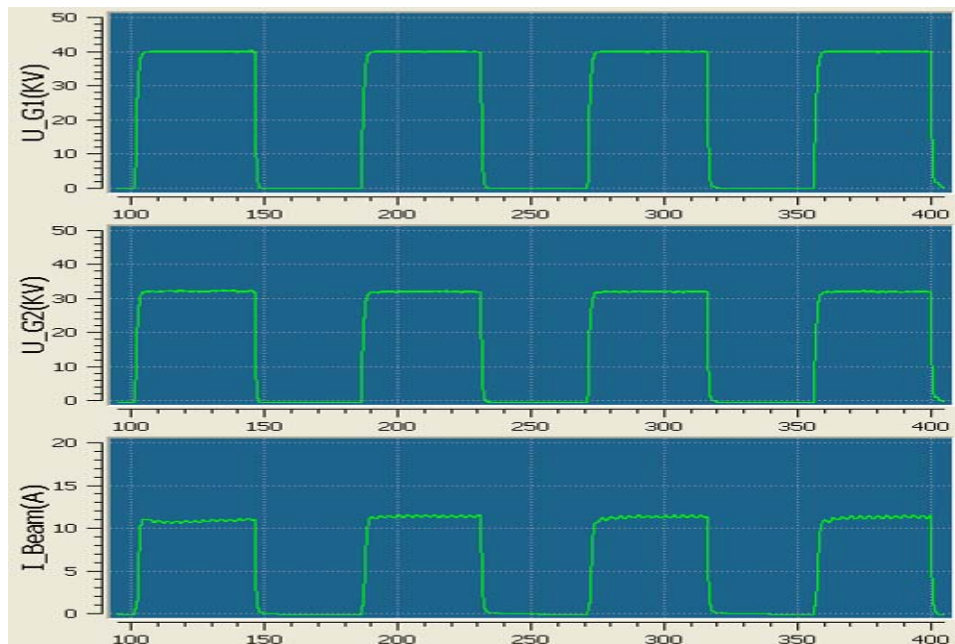

Fig. 2. Temporal evolution of the accelerating voltages, applied on the grid. No.1 (top panel), on the grid No.2 (mid panel) and the extracted ion current (bottom panel). The accelerating voltage is modulated so that the active part of the shot is 160 ms.

The beam was fired in the movable calorimeter inside the vacuum tank (shown in Fig.1), which can sustain the full power only for ~ 100 ms. Therefore, only the pulse length ~ 100 ms was used during the tests. It was found that both NBI's deliver the total ion current up to 12.5 Amps at 40 keV. It is also found that the gas flow injected into the ion source is sufficient to fill the neutralizer and reach efficiency of the neutralization about $\eta \sim 70\%$. Consequently, the neutral beam power, $P = E_b * I_{ion} * \eta \sim 350$ kW, was achieved. This is by $\sim 16\%$ more than the required value. However, some power losses in the beam duct connecting the NBI and the tokamak vessel are expected. But, they are estimated to be less than 10 %.

The performance of the NBI in the regime with the beam modulation is demonstrated in Fig. 2. It is evident that the full discharge length (300 ms) is achieved.

As the next step, the NBI's will be moved to tokamak area and located close to their final position. The neutral beam will shoot into a bigger calorimeter, allowing accept the full power (300 KW) for the designed pulse length (300 ms). This calorimeter will be provided by the BINP. Furthermore, three existing tangential ports of the COMPASS vessel, envisaged for the neutral beam injection, will be cut and new, broader ones will be welded. These actions are planned for the 1st quarter of 2011. Connection of both NBI's to the COMPASS tokamak is planned for the summer shut down. First injection of the neutral beam is envisaged at the end of September 2011.

Simulations of secondary electron generation in the tokamak SOL

V. Fuchs

In collaboration with:

J. P. Gunn, CEA, IRFM, F-13108 Saint-Paul-lez-Durance, France

The role of secondary electron emission (s.e.e) caused by electron impact on plasma facing components (PFC) was investigated, in order to find an explanation for the systematic discrepancy between calculated and measured sheath characteristics. For the planned work we used the previously developed quasineutral particle-in-cell code (QPIC) for simulating ion and electron transport along magnetic field lines in the Scrape off Layer (SOL) of the tokamak plasma edge. We introduced electron-electron collisions into QPIC, in order to enforce Maxwellisation of the electron distribution function in absence of interactions. Finally, we compared s.e.e. results from QPIC with results from a “standard” PIC code.

This work is a continuation of our previous QPIC development efforts. Those included an extension of the code to a SOL configuration with non-floating walls allowing a non-zero SOL current, and later a first attempt at including the effect of secondary electrons. First results were reported at the 2007 EPS conference [1]. We now added the effect of electron-electron collisions in order to approach more realistic plasma conditions, and we also carry out simulations with a standard PIC code. The PIC code simulations allow multiple secondary events, which we so far were not able to handle with the QPIC code.

We principally address the persistent problem in the interpretation of probe data, which is the inconsistency between theoretical calculations of fast electron distributions, that should give extremely large sheath potentials (\sim kV), and measurements which only give 0-100 V. The reason might be indeed due to secondary emission - the s.e.e. coefficient is of the order of 1 for energies in the 400 eV and higher range. That means that fast electrons do not contribute to the net electrical current, while only the thermal ones do. So instead of a very large potential drop with a very energetic electron flux reflected from the sheath back towards the SOL (what we get now), we would expect to have a reasonable potential drop with cold electrons sent back into the SOL.

The QPIC electron-electron collision model code includes Monte-Carlo particle exchange with the SOL background plasma. A similar model is adopted for electron-electron collisions, only the exchange is “local” with a thermal Maxwellian. In our normalized variables the collision frequency is the usual $\nu^* = \text{connection length}/\text{mean free path} = \nu_{\text{coll}} t_{\text{bounce}}$, which is effectively the number of collisions per ion transit time.

Our kinetic treatment of secondary electron emission is based on the semi-empirical form for s.e.e. coefficient δ from [2]. We retained the probabilistic meaning of the δ -coefficient by working with time – rather than ensemble – averages, adopting an electron-by-electron Monte-Carlo technique. This is done as follows. Take a particular electron which has reached the material target. (i.e. we assume that its energy exceeds in magnitude the self-consistent wall potential). This electron is characterized by its energy E and the corresponding δ in Eq. (1) or Fig. 1. We furthermore assign the electron a uniformly distributed random number RAND from the interval (0,1). For the sake of illustration, let us consider the following simple emission algorithm: if the s.e.e probability is high enough, i.e. if $\delta > 1$ or $\text{RAND} < \delta <$

1, then a secondary electron is emitted and the wall global charge is unchanged. If, however, $\delta < \text{RAND}$, then secondary emission does not occur and the wall charge state changes as the incident electron neutralizes one of the incident ions. In the long run, for N primary electrons in the energy range $(E, E+\Delta E)$, this algorithm clearly generates $N\delta(E)$ secondary electrons.

In the QPIC code we limit s.e.e. by intermediate values of δ such that no more than one secondary electron can be emitted. This has far-reaching consequences for the QPIC code and simulation, which thereby remains relatively simple to modify and execute. The essential simplification, as was already mentioned, is that a single electron emission event does not change the wall charge state. Hence the ion wall charge throughout the simulation only depends on ions reaching the walls. The only complication which can arise (and occasionally it does) is that with many secondary events we might in a particular time step run out of electrons capable of maintaining global wall charge balance since the corresponding primary electrons do not contribute to neutralizing the wall ion charge. In QPIC we have therefore only dealt with single secondary events and discontinued secondary electron production when in a time step the number of secondary events plus wall ion charge exceeds the number of electrons incoming to the target. This condition is of course unnecessary in the PIC code treatment of s.e.e., and there we observed formation of a charge double layer when secondary electron production becomes too strong. Selected results are given for illustration in Table I below, where QPIC and PIC results are compared.

	δ_{\max}	V_{wL}/T_{e0}	JLi	JLe	QLe	JLsec	QLsec	Jenet
QPIC	0	-0.23	0.26	0.26	0.21			0.26
PIC	0		0.26	0.26	0.43			
QPIC	0.25	-0.18	0.26	0.31	0.22	0.05	0.02	0.26
PIC	0.25		0.26	0.31	0.44	0.05	0.01	
QPIC	0.5	-0.17	0.26	0.37	0.24	0.11	0.04	0.26
PIC	0.5		0.26	0.36	0.45	0.10	0.01	
QPIC	0.75	-0.16	0.26	0.46	0.27	0.20	0.07	0.26
PIC	0.75		0.26	0.43	0.46	0.17	0.02	
QPIC	1	-0.14	0.26	0.60	0.31	0.34	0.11	0.26
PIC	1		0.26	0.51	0.48	0.25	0.03	
QPIC	1.2	-0.13	0.26	0.77	0.36	0.51	0.15	0.26
PIC	1.2		0.26	0.60	0.49	0.34	0.03	
QPIC	1.4	-0.10	0.26	1.02	0.41	0.83	0.19	0.26
PIC	1.4		0.26	0.71	0.52	0.45	0.04	
QPIC	1.6	-0.03	0.26	1.41	0.33	1.13	0.13	0.24
PIC	1.6		0.26	0.85	0.54	0.60	0.05	

Table I Shown are some results from 8 selected QPIC and PIC simulations, as a function of the maximum s.e.e. probability δ_{\max} . The plasma conditions are for a usual Tore Supra SOL: $T_{e0}=T_{i0}=50$ eV, $n=5 \times 10^{17}$ $1/m^3$; initial number of QPIC particles per cell = 5000 ions, 5000 electrons; zero background drift velocity; $E_{\max}=300$ eV. The subscript "L" refers to the left wall. There is left-right symmetry.

The wall potential V_{wL} , as well as the currents JL and powers QL, given in Table I are time-averages taken over the period when the simulation has reached equilibrium. The simulation is allowed to run for 4 ion transit times. The currents are normalized to $qn_e c_B$, the powers to $0.5 qn_e c_B^2$, where c_B is the Bohm speed $c_B = \sqrt{qTe/m_i}$. JLsec and QLsec are respectively the emitted secondary electron current and power. The net electron current $J_{\text{Lenet}} = J_{\text{Le}} - J_{\text{Lsec}}$ must equal the ion current JLi. We note the progressive decrease of wall potential V_{wL} with increasing s.e.e. probability d_{\max} .

The Fig. 1a below gives an indication of the effect of collisions. Obvious is the effect of rapid saturation as ν^* is allowed to become non-zero, and the strong effect of collisions on the magnitude of the wall potential. The next Fig. 1b then indicates formation of a double layer.

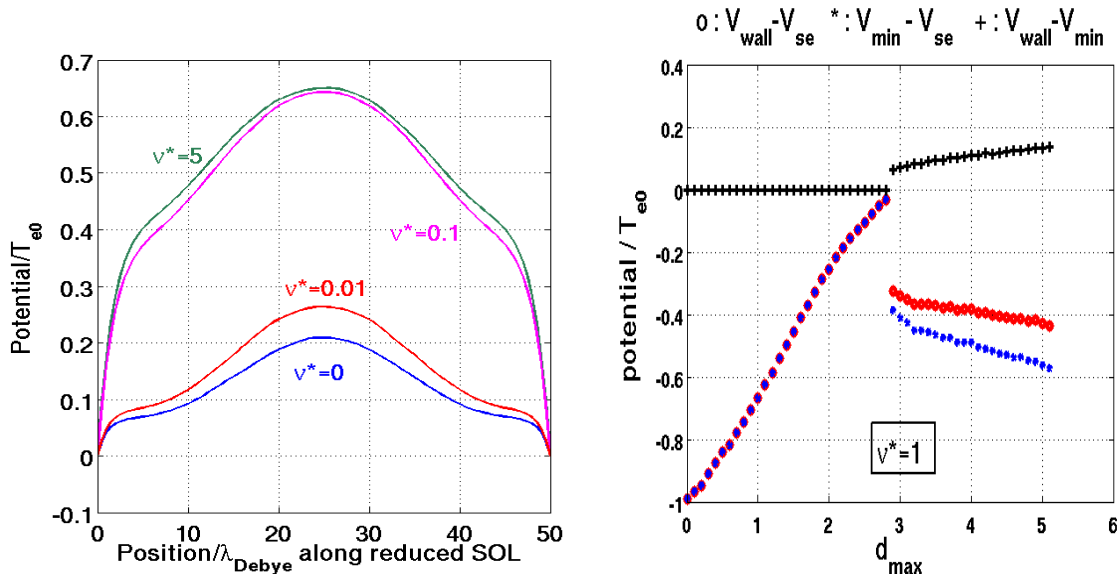

Fig. 1 Left: The potential calculated from the PIC code, as function of position along reduced SOL for several values of collision frequency ν^* . Right: The value of potential V as function of δ_{max} at selected positions along the sheath. “se” signifies sheath edge, We note just below $\delta_{\text{max}}=3$ the sharp transition to a current double layer, signifying that the number of incoming electrons is no longer sufficient to neutralize the positive charge building up as more secondary electrons are emitted.

In conclusion, we introduced electron-electron collisions and secondary electron production into the QPIC code, carried out necessary code modifications and debugging, and obtained some first exploratory results. The main difficulties with introducing secondary electrons have been identified, some of which (e.g. multiple secondary events) will be dealt with in QPIC in the continuation of this project. Likewise, the effect of collisions on various quantities of interest will be studied in more detail.

References:

- [1] V. Fuchs and J. P. Gunn, *Quasi-neutral simulations of tokamak scrape-off layer currents*, 34th EPS Conf. On Plasma Physics and Controlled Fusion, Warsaw, 2-6 July, 2007
- [2] E. W. Thomas, *Supp. Nucl. Fusion* **1** (1991) 79.

Atomic Beam Probe system for COMPASS

V. Weinzettl, P. Hacek, J. Krbec

In collaboration with:

M. Berta, G. Veres, G. Anda, S. Tulipan, T. Ilkei, D. Dunai, D. Nagy, A. Bencze, S. Zoletnik,
Association EURATOM – HAS

The new Atomic Beam Probe (ABP) diagnostic for edge current measurements by collecting the ions stemming from diagnostic beam ionization on the COMPASS tokamak is under development in collaboration with the Association EURATOM – HAS and covered by the EFDA task No. WP08-TGS-01a-02 (III-3-a). The ABP system consists of the Li beam injector and the detection part based on a two dimensional array of ion collectors.

Atomic beam probe (ABP) is an innovatory diagnostic for measurement of poloidal magnetic field changes and thus plasma current fluctuations in the plasma edge. It is planned to be an extension of the beam emission spectroscopy system by collecting the lithium ions stemming from beam ionisation. In the first approximation, ionisation is proportional to the local plasma density. The poloidal magnetic field moves the ions toroidally. Therefore, the two-dimensional poloidal-toroidal measurement of the ion current in the exit port reveals information on both the density and magnetic field profiles, thereby also on the edge current profile. The knowledge of temporal evolution of current density in the plasma pedestal/edge region provides important information for edge plasma stability calculations. The neutral lithium beam will pass through a diaphragm and its diameter will be reduced to few millimeters.

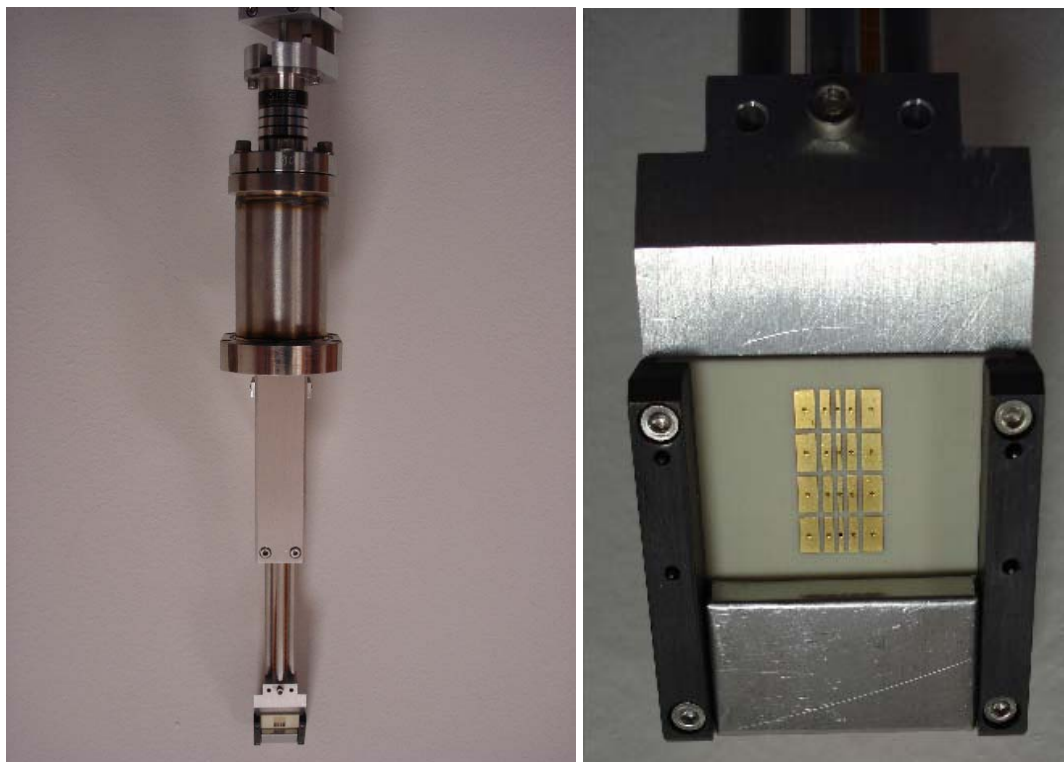

Fig.1: The Atomic Beam Probe prototype. The holder equipped with the ABP measuring head is on the left, a detail of the segmented ABP prototype head can be seen on the right picture.

To detect the lithium ions, a two-dimensional segmented multichannel system (the prototype contains 4x5 detector segments plus 4 Langmuir probes) will be used. It will provide a direct measurement of the ion current. The size of one detector segment in toroidal direction is planned to be about 0.5 mm. According to the relative movement of the ion trace on detector, the toroidal resolution will be in range of a few 0.1 mm corresponding to a 10 kA perturbation current (less than 10% of total plasma current). The detector signal ($\sim\mu\text{A}$) can be easily amplified at 1MHz bandwidth for the fast fluctuation measurement .

Preliminary measurements with ABP but without the lithium beam were performed to check level of background signal. The necessary lithium beam was completed and tested in December 2010 and its connection to the tokamak is scheduled in March 2011.

References:

- [1] P. Hacek, et al.: Atomic Beam Probe Diagnostic for COMPASS Tokamak. *WDS 2010 - Proceedings of Contributed Papers: Part II* (eds. J. Safrankova and J. Pavlu), f-2, pp.7-11, Prague, Czech Republic, Matfyzpress, ISBN 978-80-7378-140-8
- [2] V. Weinzettl, et al.: Overview of the COMPASS diagnostics. *Fusion Engineering and Design*, in press, doi:10.1016/j.fusengdes.2010.12.024

Electrostatic Probes in COMPASS

R. Dejarnac, J. Stockel, M. Komm

In collaboration with:

Tsv. Popov, Sofia University, Association EURATOM-INRNE, Bulgaria.

J. P. Gunn, Association EURATOM-CEA Cadarache, France.

The COMPASS tokamak is planned to host a large set of different electrostatic probes. There is already a set of 39 Langmuir probes (LPs) in the divertor and since September 2010 one of the two reciprocating manipulators has been successfully installed. Those manipulators can hold different types of probe heads, like classical LPs or Ball-pen probes (BPPs), as at present status, or Tunnel probes, triple probes, Mach probes, etc... in the near future. New electronics for the divertor probes was developed in collaboration with the Bulgarian EURATOM association and it was tested in plasma conditions in COMPASS. Using the first derivative method, the electron energy distribution function was retrieved. Comparative measurements between the different probes has also been performed to follow the not yet controlled plasma column movements. The relative position is coherent for all probe measurements and with the magnetic diagnostics as well. Concerning the future probes for COMPASS, like the Tunnel probe, a massive set of numerical simulations has been done to calibrate the probe. We used our dedicated in-house particle-in-cell code developed in collaboration with CEA Cadarache. Simulations have been compared to a commercial code which is less adapted to this purpose. The analysis of such a large number of simulations is in progress.

In the frame of our collaboration with the Bulgarian EURATOM association on COMPASS probes, new electronic boards have been developed and are now routinely running on COMPASS for the divertor probes signals collection. This allows to reduce considerably the noise by using filters with different frequencies. Raw signal of the temporal current profile measured by a swept divertor probe can be seen in Fig. 1 (left panel). The several branches of these I-V characteristics have been analysed by the 1st derivative method to retrieve the electron energy distribution function and the plasma potential. As an example, we can see on the right panel of Fig. 1 those quantities for the 1st branch of the signal in the left panel. The distribution is bi-Maxwellian with a temperature for the bulk electrons of 10 eV and for the small fraction of supra-thermal electrons, the temperature is 21 eV. These results have been published in [1].

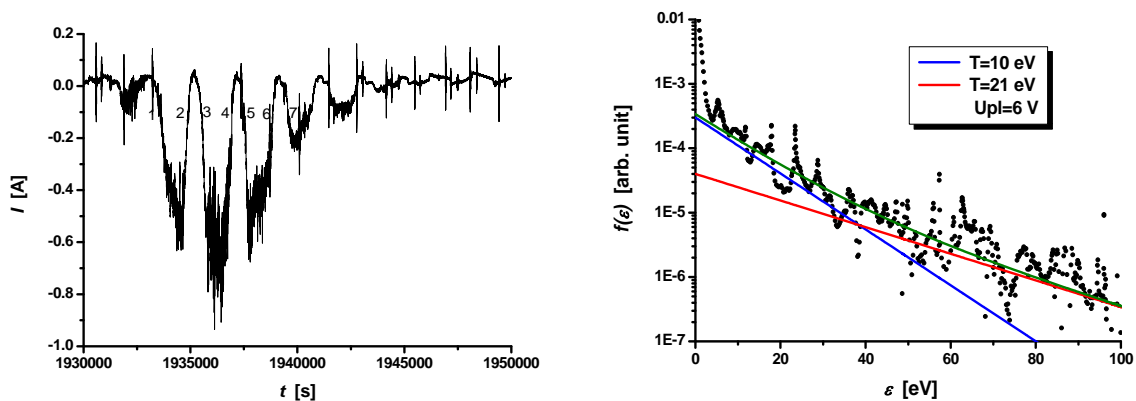
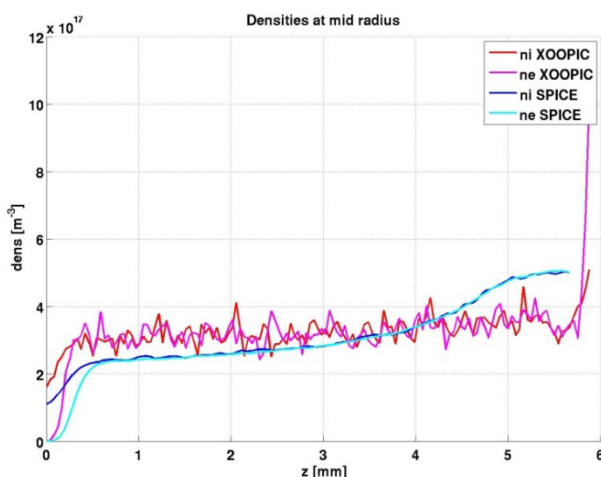

Figure 1: Temporal evolution of the current measured by a COMPASS divertor LP with swept voltage (left) using the new electronics and EEDF with bi-Maxwellian distribution (right) of the first I-V characteristic from left panel.

Comparisons between the divertor probes and the LPs/BPP installed on the probe head of the horizontal manipulator have been performed. Due to a technical problem, the probe head could not be biased and was working in floating potential mode (V_f). It has to be noted that the BPP can give the temporal electron temperature (T_e) profiles and its fluctuations in floating mode [2], but the classical LPs cannot. The BPPs results give values of the same order than the swept divertor LPs within error bars. Using the different signal from the different probe: V_f for manipulator LPs, T_e for both BPPs and divertor LPs, we could follow the relative plasma column position in time (according to the amplitude of the collected signals) since the probes are at fixed positions. The horizontal manipulator was not reciprocating for its first test in COMPASS and was used at fixed position. The plasma column was not controlled at that time and it was moving randomly, so it was one of our objectives to measure the plasma position inside the chamber. Comparisons between the several probes show good agreement with each other as well as a good agreement with the magnetic reconstruction diagnostic.

We would like to add a Tunnel probe to COMPASS set of electrostatic probes. For this, we need not only to design the probe but to calibrate it using numerical simulations. In collaboration with the French EURATOM association (CEA) we have been developing for several years a 2D particle-in-cell code (SPICE) [3] for this purpose. The code has been benchmarked and a comparison with the commercial code XOOPIC has been performed. The main difference between the codes comes from the different input particle velocity distribution functions, XOOPIC uses only Maxwellian distributions whilst SPICE uses arbitrary, realistic distributions from a 1D model of the entire scrape-off layer region. Moreover, we have developed dedicated diagnostics that calculates the fluxes falling onto surfaces of interest. The results are of course coherent but different and we believe more realistic. The density profiles along the 6 mm long tunnel calculated by the different codes are presented in Fig. 2. We see a strong numerical sheath at the plasma side for XOOPIC profiles,



whilst SPICE profiles do not have such a strong artificial sheath and the profiles are less scattered. This confirms the benefit of writing our own code. A set of intense simulations (1582!) has been performed for the Tunnel probe calibration. The analysis of such large number of simulations has been unfortunately postponed to next year as well as the design/construction of the probe itself.

Figure 2: Ion and electron density profiles in the tunnel probe in the cylinder axis direction at mid-radius calculated by our in-house PIC code, SPICE, and by the commercial XOOPIC.

References:

- [1] P. Ivanova et al., Proceedings of the 24th Symposium on Plasma Physics and Technology in Prague (June 2010), to be published in Acta Technica journal.
- [2] J. Adamek et al., Contrib. Plasma Phys. **50**, No. 9 (2009) 854-859.
- [3] R. Dejarnac et al., J. of Nucl. Mater. **382** (2008) 31-34.

Re-installation of two reciprocating manipulators for Compass SOL studies [WP08-TGS-01-06]

J. Horáček, J. Strnad, M. Boušek, D. Šesták, J. Adámek, J. Vlček, P. Vondráček, P. Cahyna,
L. Havlík, M. Šatava, V. Weinzettl, R. Pánek, J. Stöckel, T. Momtaz

In collaboration with:

T. Popov, Sofia University, Association EURATOM-INRNE, Bulgaria

In 2010 we finished installation of two reciprocating probes on the COMPASS tokamak. The vertical probe was originally built in UCSD California [1] (and reconstructed at CRPP EPFL Switzerland).

The horizontal was built for Compass-D in Culham (GB). Both probes penetrate into the edge plasma within ~ 0.1 s to obtain radial profiles of direct plasma potential, electron density and temperature, plasma parallel flow and fluxes towards the wall, with resolution up to 1 microsecond and 2-4mm. The Top manipulator (Fig. 2) penetrates vertically and contains 5 probes, the low-field side probe moves horizontally and contains up to 18 probes (Fig. 1). Both probes are driven by pneumatic pistons at Helium pressure of 6 atmospheres, reaching thus 1.5m/s and acceleration up to 4x the gravity. Detail description of both probes has been summarized in Bachelor thesis [2] (especially the control system) and in journal [3]. First measurements of edge plasma parameters were summarized in Master thesis [4].



Fig. 1: Photograph of horizontal probe head inside the COMPASS vacuum chamber.



Fig. 2: The vertical probe during installation on the top port of COMPASS.

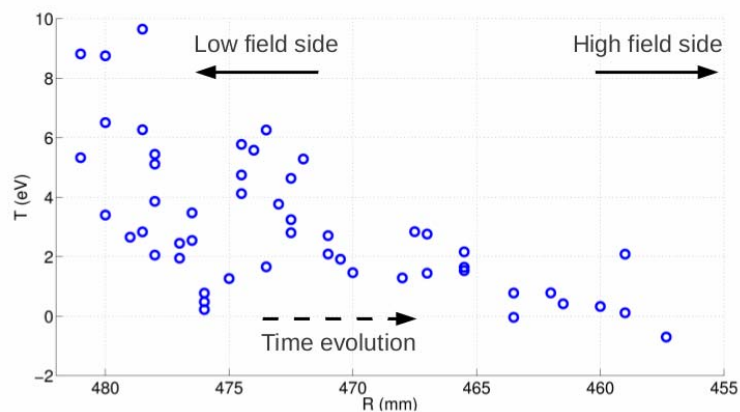

Fig. 3: Radial profile of plasma electron temperature measured by the horizontal probe [4].

References:

- [1] J.A. Boedo et al. Review of Scientific Instruments, 69(7):2663, 1998
- [2] P. Vondracek. Bachelor thesis. Czech Technical University, 2010
- [3] Weinzettl V., et al: Overview of the COMPASS diagnostics. Fusion Engineering and Design, doi:10.1016/j.fusengdes.2010.12.024
- [4] G. Cieters, Msc. Thesis, University of Gent, Belgium, Faculty of Engineering , "Electrical Probe Measurements n the COMPASS Tokamak ", 2011

Development of millimeter-wave reflectometry methods for the measurement of edge pedestal plasma in tokamak COMPASS

J.Zajac, F.Zacek, J. Vlcek

In collaboration with:

M. Manso, A. Silva, P. Varela, L. Meneses, L. Cupido, Association EURATOM - Instituto Superior Technico / Instituto de Plasmas e Fusão Nuclear, Lisbon

V. Kiseliiov, Institute of Radiophysics and Electronics-Dep. of Quasioptics, Kharkov, Ukraine

The reflectometry system for Compass was mainly designed to perform the relevant plasma density profile measurements in the pedestal region. Five individual reflectometers are supposed to measure the plasma density profile which correspondes to the frequency range 18-90 GHz. The additional requirement is using of the reflectometers as well as an experimental diagnostics for studies of the plasma turbulence.

The reflectometry systems will be developed in the following three phases:

A) Density Profile Systems – K & Ka bands, 3 channels

B) Turbulence/Correlations – K & Ka bands, 2 channels

C) Density Profile Systems + Turbulence/Correlations – U & E bands, 2 + 2 channels

The phases A+B, which involves three reflectometers of the K and Ka bands, is realized in the frame of EFDA Task WP08-TGS-01-06: Role of turbulence and long-range correlations during the development of edge transport barriers.

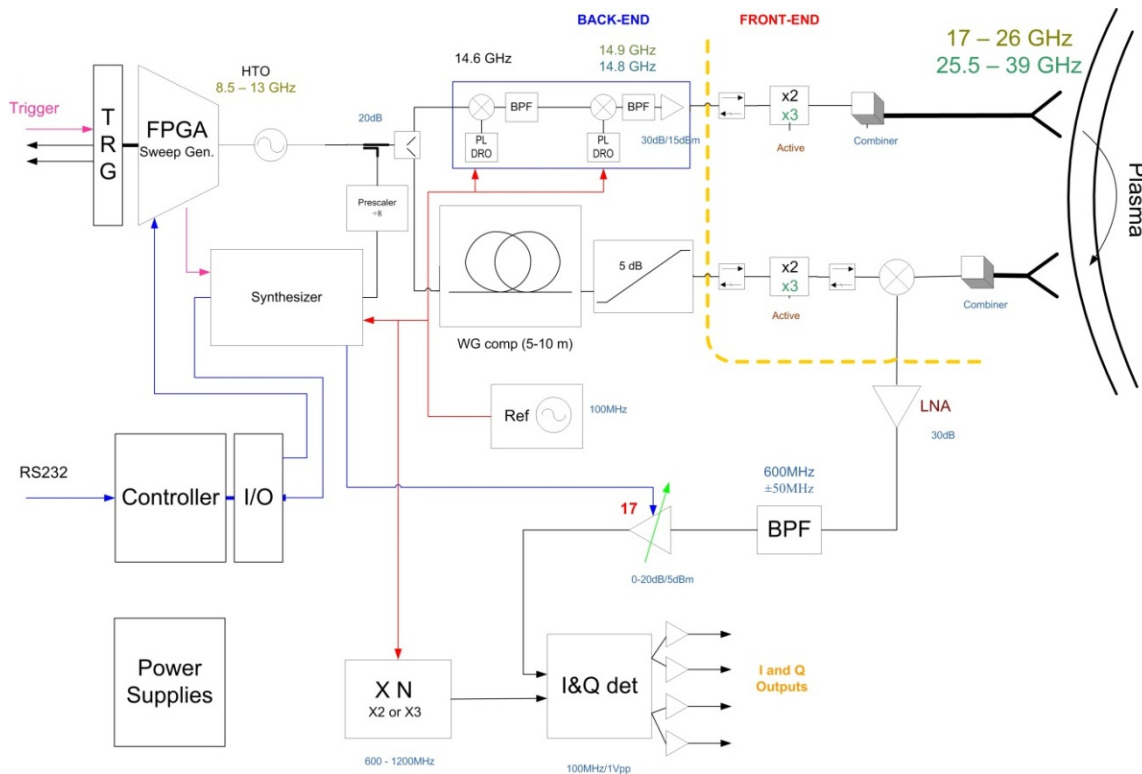

Fig. 1. The new hybrid arrangement of transmitters and receivers

The reflectometry system consists of two parts which are developed separately. The first part are the microwave electronics and data acquisition, which will be provided by IPFN/IST. Because of the further delay, the planned term (end of 2010) was forwarded to about half of 2011. The second part are band-combiners and quasi-optical antennas (BCA), which are necessary to transmit and receive all five microwave channels (O-mode K, Ka, U and E frequency bands and one X-mode Ka frequency band). The provider of BCA is the Institute of Radiophysics and Electronics NAS of Ukraine (IRE NASU). This second part of the reflectometry system was delivered in planned term in summer 2010 and is ready for the operation.

The manufacturing of the microwave electronics and data acquisition for K and Ka band reflectometers in IPFN/IST has been in progress so far, the predicted delay will be at least of about half a year. The architecture of the microwave transmitters and receivers was progressively changed during the development. The original design consisted of the separate systems: for the density profile measurement the fast homodyne reflectometers and for the turbulence measurement the frequency-synthesizers. The new arrangement of transmitters / receivers uses the advanced ultra fast frequency-synthesizers, which meet the demands of both purposes. The density profile measurement (the sweeping-frequency regime) will be interleaved with the fast hopping fixed frequency measurements of plasma turbulences during the same discharge. This new hybrid configuration will be introduced for the first time. The advantage of the hybrid configuration is the reduction of numbers of reflectometers from originally planned 3+2 to 3 only. The schematic of the new arrangement is in Fig. 1.

In 2009/2010 the band-combiners and antennas (BCA) were manufactured in IRE NASU (Kharkov, Ukraine). The final delivery testing passed in July 2010 in Kharkov under the supervision of IPP and IPFN/IST participants. The BCA was approved for the reflectometry system operation. The dismantled equipment was delivered to Prague in August 2010. It was installed on the support structure – see picture on Fig. 2. The functionality of the vacuum window and the protective shutter was checked on the tokamak. It turned out the necessity of the mechanical changes of the shutter.



Fig. 2. Picture of the built-up BCA on the support structure

Beam Emission Spectroscopy system for COMPASS

V. Weinzettl, P. Hacek, J. Krbec

In collaboration with:

G. Veres, M. Berta, G. Anda, S. Tulipan, T. Ilkei, D. Dunai, D. Nagy, A. Bencze, S. Zoletnik,
Association EURATOM – HAS

The new Beam Emission Spectroscopy (BES) diagnostic for edge density measurements on the COMPASS tokamak is under development by the Association EURATOM – HAS in a framework of the bilateral agreement between IPP Prague and KFKI RMKI. The BES system consists of the Li beam injector and the detection part based on an array of avalanche photo diodes and a fast camera allowing both density profile and density fluctuation measurements.

Beam Emission Spectroscopy (BES) using accelerated neutral particle beams became a routine technique for the determination of electron density profiles in fusion plasmas. The method is based on the fact that light emission from the neutral beam penetrating the plasma depends on plasma parameters. In the case of certain beam species, e.g. Li, Na, sensitivity on the electron temperature is small, thus the electron density profile primarily determines the beam light emission. In the neutral beam system developed for the COMPASS tokamak, lithium ions will be emitted constantly during the tokamak discharge (with current of mA) by a resistively heated solid ion emitter, accelerated to energies up to 100 keV and focused by ion optics. Deflection plates will be used to deflect the beam trajectory (with frequency up to 400 kHz) in the plasma or to target it outside into a Faraday cup, which will allow for a background noise measurement. Lithium ions will be neutralised via charge exchange by passing through a chamber with sodium vapour. The standard beam diameter for BES measurement will be 1-2 cm, maximal beam divergence is estimated to 1-2 mrad. When injected into plasma, the lithium atoms are collisionally excited and ionised. The excited neutral atoms return to the ground state by emitting radiation with characteristic wavelengths (670.8 nm for 2p – 2s transition), which will be detected by a CCD camera for slow (~10 ms) and by avalanche photodiodes for fast (~ μ s) measurement. Fast measurement will allow us to observe the density fluctuations.

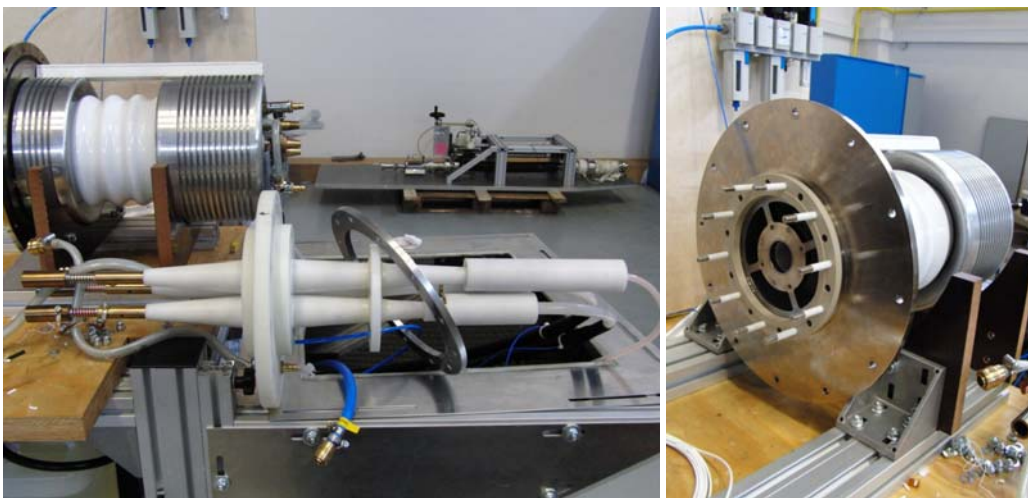

Fig.1: The high-voltage part of the Li beam.

The detection system measures the beam radiation along multiple lines of sight. The light detected in a measurement channel originates from the crossing point of the beam and the line of sight. If the beam is scanned up and down using deflection plates, the whole two-dimensional density profile can be recovered, although not on a rectangular grid of points. The spatial resolution of density measurement will be 1-2 cm.

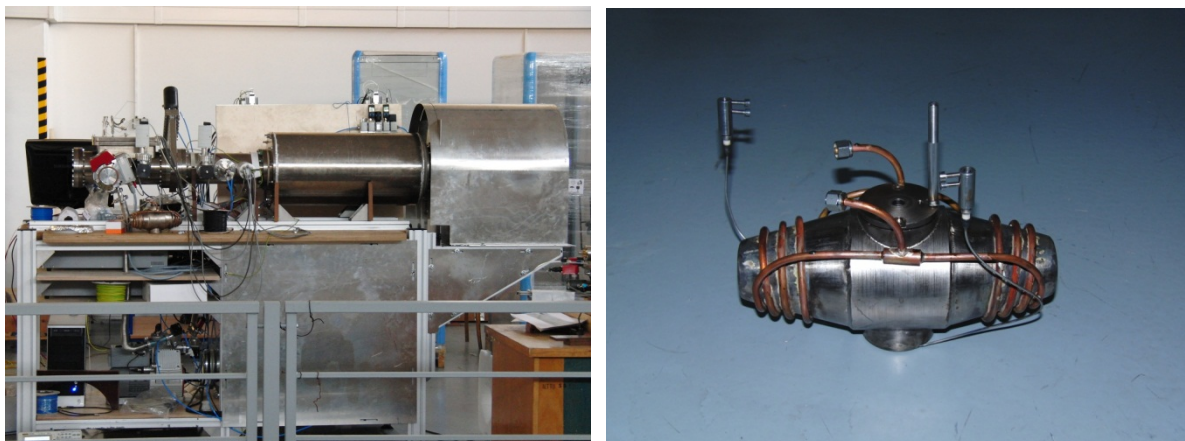

Fig.2: The completed Li beam for the beam diagnostics (BES and ABP) on the COMPASS tokamak (left)
On the right picture, the sodium neutralizer is shown in detail.

In 2010 it was decided to change an installation section for diagnostic beam and BES detection in order to enable simultaneous slow and fast BES measurements (accessibility of the observation port 1/16 VLC for fast measurements). The corresponding port plugs were reinstalled in early summer. Later, the optics equipped with the new CCD camera were placed to a new position. In autumn, components of the lithium beam were transported to IPP Prague, set together, see Fig.1 and Fig. 2, and a Li beam generation was successfully tested reaching up to 2 mA at 34 kV, see Fig.3.

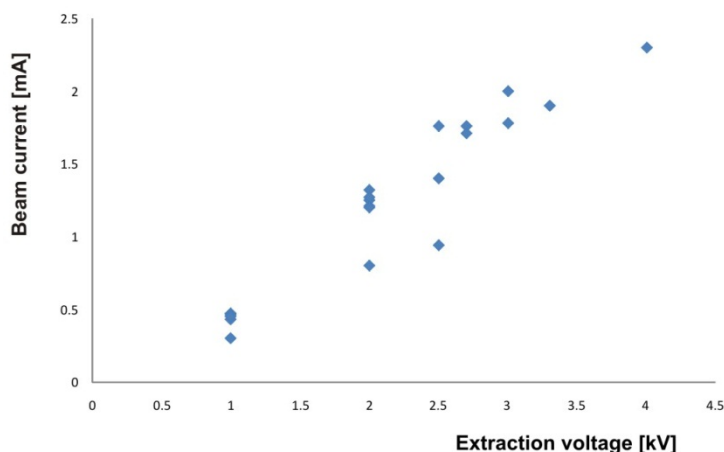

Fig.3: The first tests of the Li beam. Dependence of beam current on extraction voltage

References:

- [1] V. Weinzettl, et al.: Overview of the COMPASS diagnostics. *Fusion Engineering and Design*, in press, doi:10.1016/j.fusengdes.2010.12.024

Minimum Fisher Regularisation in fast tomography

J. Mlynář, T. Odstrčil, V. Weinzettl

In collaboration with:

D. Mazon, D. Vezinet, Association EURATOM – CEA Cadarache, France

B. Alper, C. Giroud, Association EURATOM – CCFE, UK

In 2010, the potential of fast tomography for real time control was reviewed in ref. [1]. In this paper it is concluded that performance of the regularization methods is promising. Therefore, the designed setup of SXR diagnostics for tomography on COMPASS was implemented into the existing Minimum Fisher Regularisation (MFR) code package (in MatLab) including real width of chords and expected magnetic flux surface geometry. The MFR code was optimised for rapid data processing, in prospect of real time applications, and tested in detail [2,3].

During the subsequent 4 week mobility stay in Cadarache, the optimized MFR code was implemented at TORE SUPRA. In CEA Cadarache, the scientific programme concerning applications of SXR data in real-time control is similar to IPP.CR, however more advanced due to the existing diagnostics, see Fig 1. Very high computing speed of newly installed MFR was achieved (tens of millisecond per one frame reconstruction) which proved the tomography potential for real-time applications. A GUI interface for a user-friendly visual check-up of the SXR raw data control was also programmed. Although quite straightforward, the implementation tasks presented the most time demanding work.

Both previously available and the newly installed data analysis algorithms at CEA proved to provide very similar results if run under similar conditions. However, the newly installed MFR features several options that had not been available at TORE SUPRA and that considerably improved the performance, in particular (i) preferential smoothing along magnetic flux surfaces (ii) finite width of the diagnostic chords (iii) rapid (matrix) reconstruction of several timeframes and (iv) zero border condition.

Based on the above results and similarities in the research programme on COMPASS and TORE SUPRA we agreed that further co-operation would be efficient in ongoing data analyses, their physical interpretation and development of real-time applications of SXR diagnostics, based on remote collaboration combined with short scientific visits. We also strongly propose to foster exchange of involved students in order to enhance their working experience.

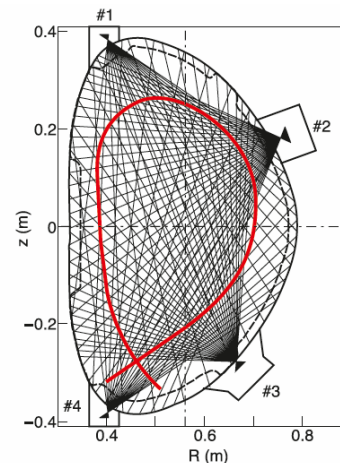
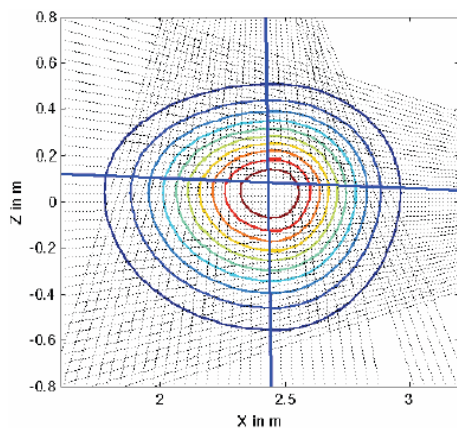

Fig. 1. Chords of SXR diagnostics at TORE SUPRA Fig. 2 Planned SXR diagnostics setup at COMPASS

Concerning the MFR implementation for the SXR system of the COMPASS tokamak (under construction, see Fig. 2 and the next report), the corresponding response (geometric) matrix was derived and the code tested on realistic phantom functions, see [2]. In particular the option of preferential smoothing along the flux surfaces was in focus. The effects of both stochastic and systematic errors were studied for several phantom functions, as well as the stability of the reconstruction with respect to the „free” parameters (e.g. the expected data errors). Importance of correct estimate of the expected errors was presented in [3]. Its underestimation by 1% clearly led to overfitting, higher estimate to oversmoothing. Besides, robustness of the code with respect to statistical errors was studied, see fig. 3. In these tests, MFR proved to perform well.

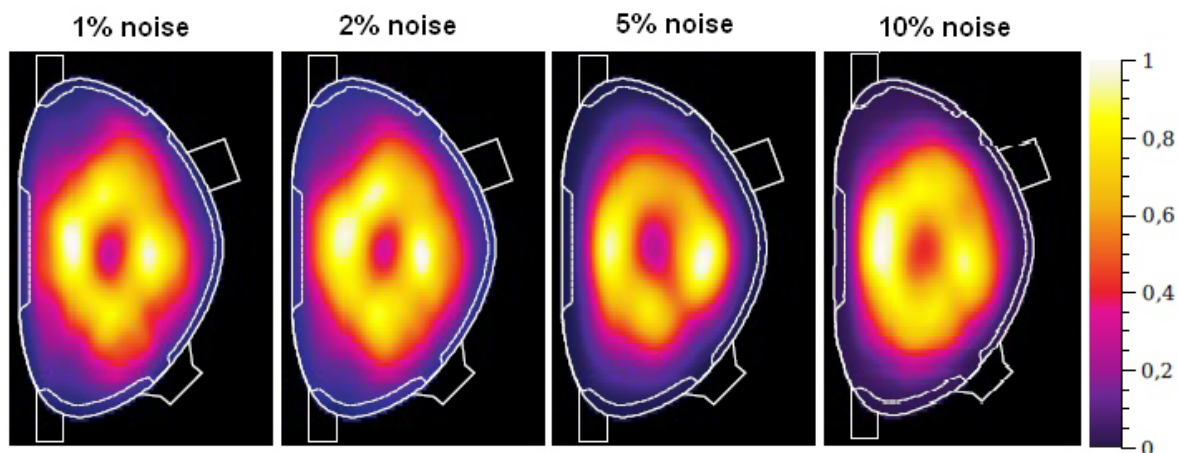

Fig. 3. Reconstruction from the synthetic data with a different level of the random noise. The expected errors are in all frames identical to the noise level.

References:

- [1] Mlynar J., Weinzettl V., Bonheure G., Murari A.: Inversion techniques in the Soft X-Ray tomography of fusion plasmas: towards real-time applications. *Fusion Science and Technology* **58** 3 (2010) 733
- [2] Odstrčil M. (supervisor: Mlynář J.): Tomografie plazmatu na tokamaku COMPASS (Plasma tomography on the COMPASS tokamak). *Bachelor thesis* FJFI ČVUT (FNSPE, Czech Technical University in Prague, 2010)
- [3] Mlynar J., Weinzettl V., Odstrcil M.: Progress in rapid tomography for the COMPASS tokamak. *52nd Annual Meeting of the APS Division of Plasma Physics, Bulletin of the American Physical Society* **55** 15 (2010) GP9.0073

Development of fast tomography systems based on fast bolometric and SXR arrays for COMPASS

V. Weinzettl

In collaboration with:

V. Igochine, Association EURATOM-IPP, IPP Garching, Germany

D. Sarychev, ITP RRC "Kurchatov Institute", Moscow, Russia

The tomographic diagnostic system based on multichannel fast bolometric (AXUV) and SXR arrays was completed and stepwise tested in real discharge conditions on the COMPASS tokamak. The correct grounding scheme was found limiting a strong parasitic signals originating in the tokamak energetics. The first measured signals showed radiation profile and its changes clearly indicate plasma column movements confirmed by magnetic diagnostics.

A basic functionality of the first complex port plug containing both fast bolometric and AXUV semiconductor arrays was successfully demonstrated under real plasma conditions on the COMPASS tokamak in 2009. In 2010, denoising of the detection system took place fighting with a strong parasitic signals originating in the tokamak energetics. In parallel, the signal amplifier itself was slightly modified with the aim to decrease its sensitivity to surrounding environment, see Fig.1. The procedure results in signal-to-noise ratio of about 100:1 and the noise well below 20 mV.

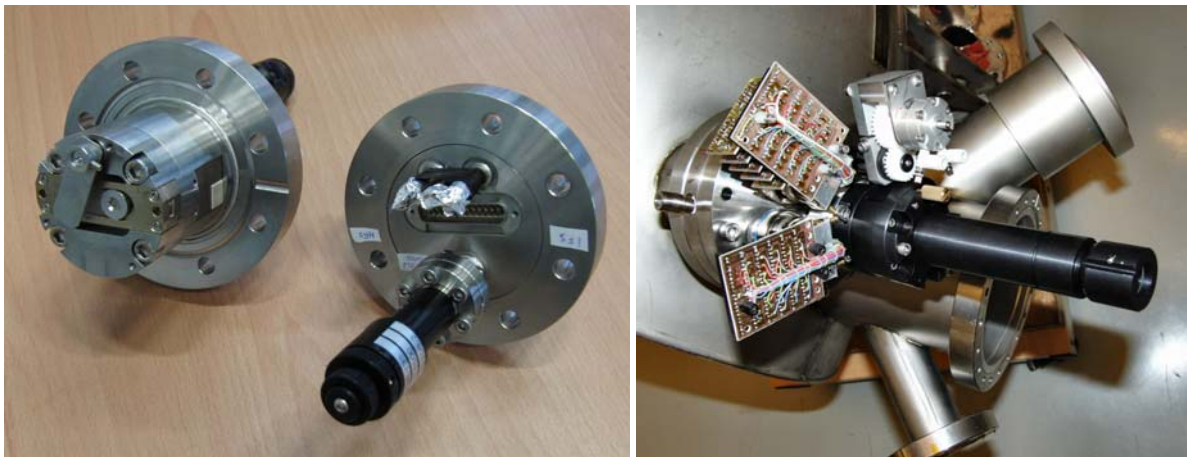

Fig. 1. Completed vertical port plugs with fast bolometers(left). Tests of placement of the new version of the fast bolometric and SXR amplifiers (angular ports) together with the shutter system and the visible light objective on the model of the COMPASS tokamak (right).

Surprisingly, it was found that few detection channels sometimes show a signal of the opposite polarity than expected. Because the detectors are very close to the plasma edge, a possible interaction of strong UV radiation with the detector surface can probably cause an emission of the secondary electrons from the surface. This feature was investigated by a stepwise closure of the shutter and by a grounded and biased additional grid installed in front of the detector surface.

In October 2010, the first vertical port plug containing one bolometric array was successfully installed and tested. Measured signals show radiation profile and its changes clearly indicate plasma column movements confirmed by magnetic diagnostics, see Fig. 2.

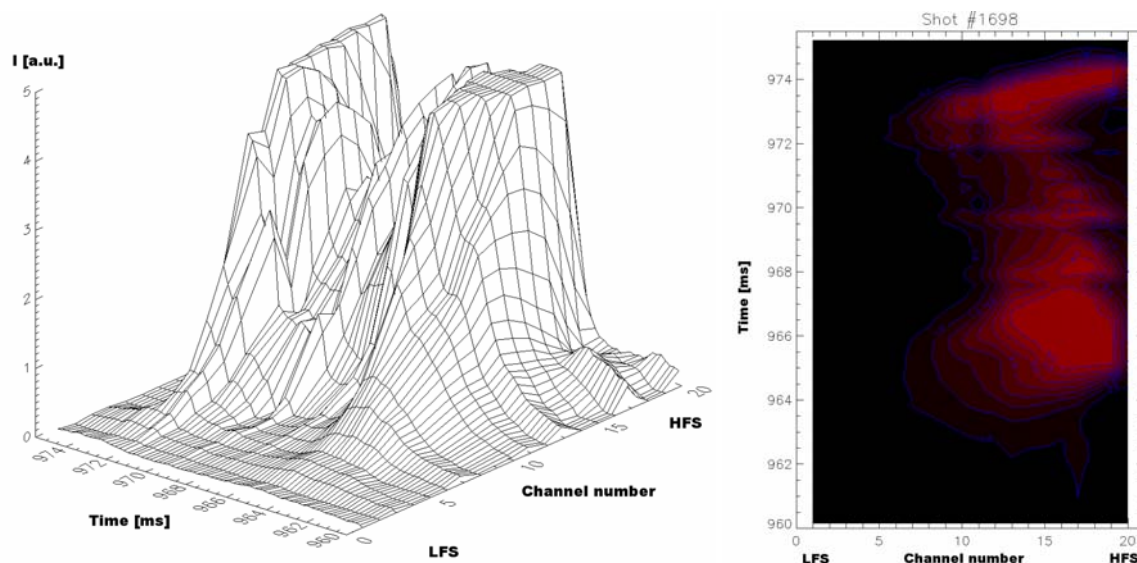

Fig. 2. Measured bolometric signals from the top view on the plasma column in shot #1698. The surface plot on the left shows a quickly changing radial profile of plasma radiation in an unstabilized plasma discharge. The contour plot of the same quantities on the right clearly indicates changes in radial plasma position.

Installation of all four port plugs on the tokamak is scheduled in March 2011 due to planned cleaning procedures of the tokamak vessel starting from the beginning of the year.

References:

- [1] V. Weinzettl, et al.: Design of multi-range tomographic system for transport studies in tokamak plasmas. *Nuclear Instruments and Methods in Physics Research A* 623 (2010) 806–808, doi:10.1016/j.nima.2010.04.010
- [2] V. Weinzettl, et al.: Overview of the COMPASS diagnostics. *Fusion Engineering and Design*, in press, doi:10.1016/j.fusengdes.2010.12.024
- [3] J. Mlynar, et al.: Inversion Techniques in the Soft-X-Ray Tomography of Fusion Plasmas: Toward Real-Time Applications, *Fusion Science and Technology*, Vol. 58, Number 3, November 2010, p. 733-741
- [4] J. Mlynar, V. Weinzettl, M. Odstreil: "Progress in rapid tomography for the COMPASS tokamak", 52nd Annual Meeting of the APS Division of Plasma Physics, Chicago, USA, November 8–12, 2010; *Bulletin of the American Physical Society*, Vol. 55, No. 15, 2010, GP9.0073

Development of fast tomography system based on photodiode arrays for visible radiation measurements for COMPASS

V. Weinzettl, D. Naydenkova, D. Šesták, J. Vlček, R. Melich, D. Jareš

Multichannel multirange spectroscopic diagnostics have been built to address aims of the new scientific program of COMPASS focused on H-mode physics and pedestal investigations. This diagnostic allows tomographic reconstructions with a time resolution at a few microseconds range and a spatial resolution less than 1 cm in the pedestal region.

The optical part of the system, designed and manufactured in the Department of Optical Diagnostics of IPP in Turnov, allows collecting of radiation from 114° field of view. Radiation is measured by two 35-channel silicon detectors using a fast amplifier. The two stage 70-channels amplifier with amplification ratio $\approx 5 \cdot 10^5$ V/A was designed and manufactured in our laboratory for a signal registration in the range of 0-5 V. Level of noise after amplification of detector signal was registered as 2 mV. Temporal resolution of the amplifier is currently given by filtration capacitors, and therefore limited approximately to 1 MHz. The connectors between the optical cables and the detectors were designed as a part of the amplifier's box with a possibility to optimize the fibres endpiece position relatively to detectors in the arrays.

Two sets of measurements were realized to check alignment of the detection part. Non-uniformity of light registration by the detector array was tested and estimated as approximately 5%. Tests of transmittance of light by each channel were done to estimate precision of fibre end-connector spacing and its alignment to array detection surface and to evaluate level of signal overlapping between neighbour channels (see Fig. 1). It is also possible to see an asymmetry between left and right neighbouring channels as a result of finite precision of the alignment of fibre end-piece and detector array. For several channels we received a level of overlapping a bit different from its average level caused by inaccuracy of individual fibre position. The average overlapping is better than 6%.

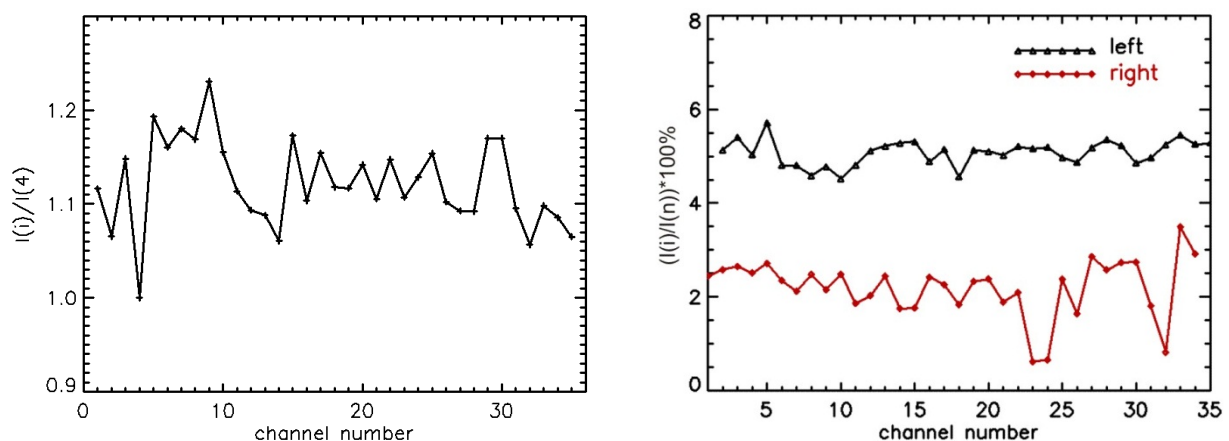

Fig. 1. Left: Light intensities of i -th channel normalized to 4th channel. Right: Overlapping of neighbouring channels. Red curve is signal from the right neighbouring channel and black one is overlapping signal from the left one.

References:

- [1] Weinzettl V., Naydenkova D.I., Sestak D., Vlcek J., Mlynar J., Melich R., Jares D., Malot J., Sarychev D., Igochine V.: Design of multi-range tomographic system for transport studies in tokamak plasmas. *Nuclear Instruments and Methods in Physics Research A* 623 (2010) 806–808, doi:10.1016/j.nima.2010.04.010.
- [2] Naydenkova D.I., Weinzettl V., Stockel J., Sestak D., Janky F., Sedlak L.: Progress in Multi channel Optical System for Visible Plasma Radiation Measurement at COMPASS Tokamak. *WDS'10 Proceedings of Contributed Papers. Part II - Physics of Plasmas and Ionized Media*, ISBN 978-80-7378-140-8, pp. 18–21.
- [3] Naydenkova D., Weinzettl V., Stockel J., Sestak D., Janky F.: The Optical System for Visible Plasma Radiation Measurements in the COMPASS Tokamak – Design and Testing., *accepted to be published in Acta Technica*.
- [4] Naydenkova D., Weinzettl V., Stockel J., Sestak D., Janky F.: The Multichannel System for Visible Plasma Radiation Measurements in the COMPASS Tokamak. *3rd EFDA Transport Topical Group Meeting combined with 15th EU-US Transport Task Force Meeting*. Cordoba, Spain, September 7 - 10, 2010, poster.
- [5] Olivier Van Hoey (supervisor: G. Van Oost, copromoter: D. Naydenkova): Visible light measurements on the COMPASS tokamak. *Master thesis 2010*. Faculty of Engineering, Department of Applied Physics, Ghent University.
- [6] Weinzettl V., Pánek R., Hron M., Stöckel J., Žáček F., Havlíček J., Bílková P., Naydenkova D.I., Háček P., Zajac J., Dejarnac R., Horáček J., Adámek J., Mlynář J., Janky F., Aftanas M., Böhm P., Brotánková J., Šesták D., Ďuran I., Melich R., Jareš D., Ghosh J., Anda G., Veres G., Szappanos A., Zoletnik S., Berta M., Shevchenko V.F., Scannell R., Walsh M., Müller H.W., Igochine V., Silva A., Manso M., Gomes R., Popov Tsv., Sarychev D., Kiselov V.K., Nanobashvili S.: Overview of the COMPASS diagnostics. *Fusion Engineering and Design*, in press, doi:10.1016/j.fusengdes.2010.12.024.

Laser part of the Thomson scattering system

P. Böhm, P. Bílková, M. Aftanas

In collaboration with:

R. Scannell, G. Naylor, M. Dunstan, Association EURATOM-CCFE

M. Walsh, ITER

The lasers for COMPASS Thomson scattering (TS) system were delivered in September 2009, the installation and basic tests were performed by the end of the year 2009, using a test beam path of 20 m length, to simulate the beam path to the tokamak. Laser beam path installation continued in this year, preparations for the first TS tests were carried out.

In the beginning of 2010, focusing the reduced energy beam was tested to specify the proper lens focal length (Fig. 1) [1]. Based on present experience, minor upgrades of the test beam path were proposed.

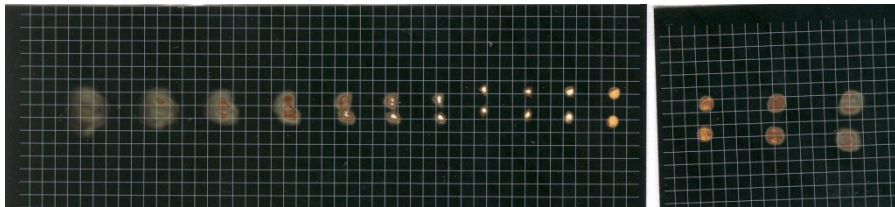

Fig. 1 – Beam spots of the focused laser beam

Complex laser safety system was specified and designed during first half of the year and was installed in autumn [4]. The system is based on programmable logic controller (PLC), which is programmed by Workswell company. The electronics and control panels are installed and are ready for the first tests on site to be performed by the end of September. The system can control laser covers and doors, other parts of laser system, like shutters, are being installed subsequently. The system is under tests, minor changes will be made.

The laser beam path to the tokamak installation started [1]. The main part, movable mirror and lens holder above the tokamak, was installed in August. Three mirrors on the tokamak area walls will be installed soon, including beam covering pipes.

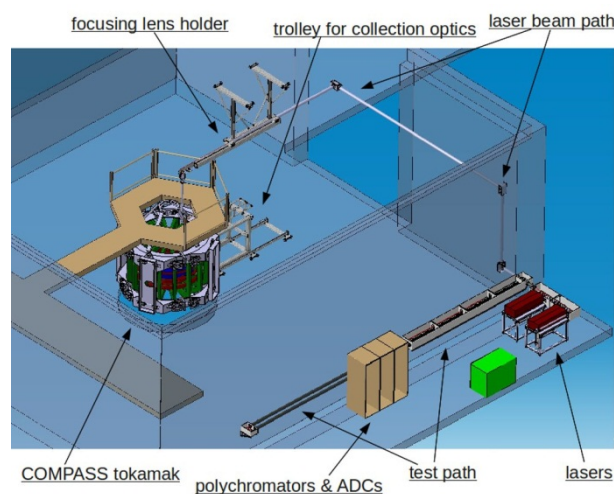

Fig. 2 – Laser beam path design [1]

The vacuum part of the laser was manufactured (Fig. 3). Beam dump and its vacuum chamber (Fig. 4) were ready, input Brewster window and its angle adaptor were prepared in the beginning of September, vacuum pump was delivered and tested. Vacuum pipes and stray light reducing diaphragms were manufactured and blackened. Beam dump chamber support structure was assembled. Vacuum part of the beam path installation and subsequent laser alignment into the tokamak vessel was planned in the end of the year, but was postponed to the early 2011 because of NBI installation.

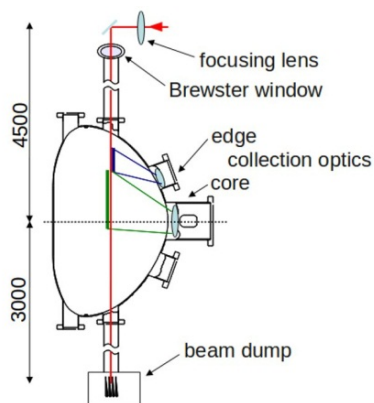

Fig. 3 – Vacuum part of the laser beam path [1]

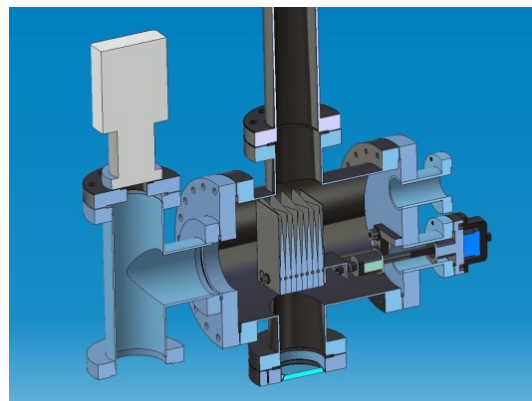

Fig. 4 – Laser beam dump vacuum chamber [1]

To trigger the data acquisition and synchronise it with the lasers, a simple solution was proposed for the first test. The lasers are controlled by their internal controller and trigger output on the laser power supply can be used for the ADCs.

References:

- [1] P. Bohm, D. Sestak, P. Bilkova, M. Aftanas, V. Weinzettl, M. Hron, R. Panek, L. Baillon, M. R. Dunstan, G. Naylor, M. J. Walsh: Laser system for high resolution Thomson scattering diagnostics on the COMPASS tokamak, *Review of Scientific Instruments* 81 10 (2010) 10D511-10D511
- [2] P. Bilkova, R. Melich, M. Aftanas, P. Böhm, D. Sestak, D. Jares, V. Weinzettl, J. Stöckel, M. Hron, R. Panek, R. Scannell and M. J. Walsh: Progress of development of Thomson scattering diagnostic system on COMPASS, *Review of Scientific Instruments* 81 10 (2010) 10D531-10D531
- [3] Petra Bílková, Milan Aftanas, Petr Böhm, Vladimír Weinzettl, David Šesták, Radek Melich, Jan Stöckel, Rory Scannell, Mike Walsh: Design of new Thomson scattering diagnostic system on COMPASS tokamak, *Nuclear Instruments and Methods in Physics Research A* doi:10.1016/j.nima.2010.03.121
- [4] P. Böhm, M. Hron, J. Kovář, J. Sova, M. Aftanas, P. Bílková, M. J. Walsh: Personnel protection during the operation of Thomson scattering laser system on COMPASS tokamak, *Fusion Engineering and Design* doi:10.1016/j.fusengdes.2011.02.073

Detection of the Thomson scattering signal

*Petra Bílková, Radek Melich, Milan Aftanas, Petr Böhm,
David Šesták, Daniel Jareš, Momtas Tadros*

In collaboration with:

M.J. Walsh, ITER Organization, Route de Vinon-sur-Verdon, 13115, St. Paul-lez-Durance, France

Rory Scannell, Graham Naylor, Martin Dunstan, Association EURATOM-CCFE, Culham Science Centre, Abingdon, Oxfordshire, OX14 3DB, United Kingdom

The detection part of the core Thomson scattering (TS) system on COMPASS consisting of collection lenses, fibre backplane, bundles of optical fibres, polychromators and related mechanical supporting structures has been finished in 2010 year and was ready to be used during experiment. The detection part of the edge TS system was ready excepting the edge objective. Description of work performed during 2010 on the core TS system follows.

Polychromators

During 2010 year, a complex of 29 polychromators has been assembled from scratch, tested and default settings applied. Particularly, optical elements (lenses, mirrors and spectral filters) have been assembled, aligned and necessary focuses performed. Then Avalanche photodiodes have been added-up. Electronic PCB boards have been connected to optical chassis. Finally, default settings of PCB boards have been setup (potentiometer settings, gain set, zero and offset zero set). Each polychromator has been tested then. Spectral calibration has been performed. Details can be found in [1], [2].

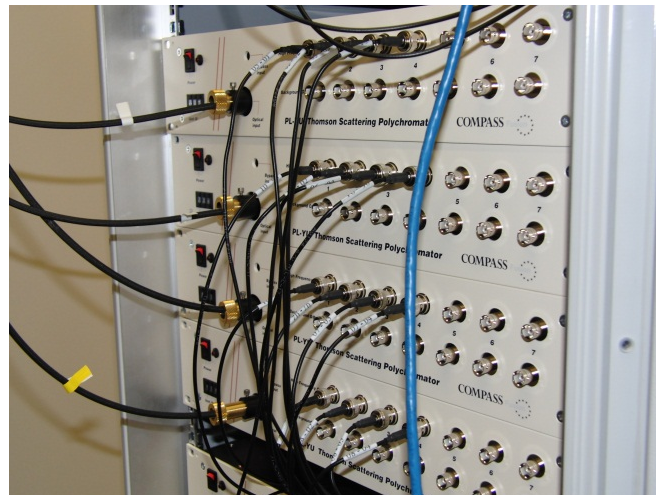

Fig. 1. Polychromators used for the core TS diagnostic system on COMPASS

Optical fibres

Bundles of optical fibres for both core and edge TS diagnostic systems have been placed into the tokamak area. Each bundle has two arms, one 20 m and the other 33 m long. Both arms are connected at the polychromator side. There are 28 fibre bundles taking signals from 56 spatial points in a plasma and 2 split fibre bundles aimed to check laser alignment with respect to fibre backplane; these split fibres allow to process signals from 2 more spatial points. After the placement all fibre bundles have been tested again.

Mechanical support for collection lenses and fibre backplane

A trolley manufactured to support lenses and fibre holders has been finished and placed into the tokamak area.

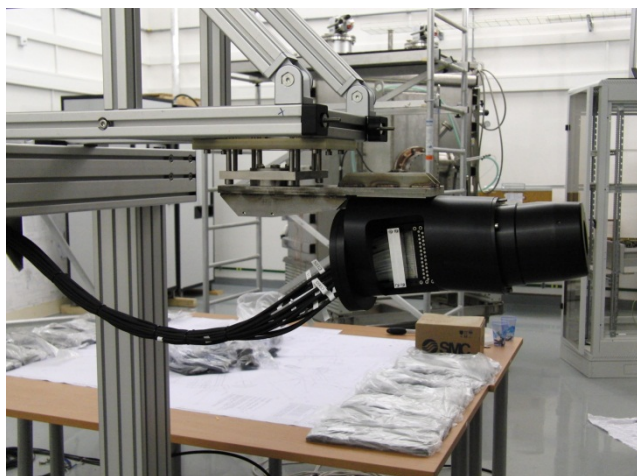

Fig. 2. Trolley holding the core TS objective



Fig. 3. The core COMPASS TS objective

Collection optics

The whole objective for the core TS system including fibre holder has been fixed on a trolley. Alignment of the optics and fibers with respect to a laser beam has been done by illuminating the fiber inputs from the polychromator side (20 m apart from tokamak) and placing each of optical fibers individually into the optimal position so that it created sharp image at an image plane. Position of the image plane should correspond to a position of laser beam in a plasma. The distance between image plane and fibre inputs has been adapted (using ZEMAX simulations) considering a fact that laser light fall into the IR region while we are checking sharpness of the image in the VIS region.

Detection part of the core TS system has been ready to measure scattered signals before the end of 2010. Measurement of scattered signal has been postponed to the first quarter of 2011 due to a delay in assembling the laser beam path in the tokamak area.

References:

- [1] Bilkova, P., Melich, R., Aftanas, M., Böhm, P., Sestak, D., Jares, D., et al. (2010). Progress of development of Thomson scattering diagnostic system on COMPASS. *Review of Scientific Instruments*, 81(10), 10D531. doi: 10.1063/1.3494378.
- [2] Bílková, P., Aftanas, Milan, Böhm, Petr, Weinzettl, Vladimír, Šesták, D., Melich, Radek, et al. (2010). Design of new Thomson scattering diagnostic system on COMPASS tokamak. *Nuclear Instruments and Methods in Physics Research Section A: Accelerators, Spectrometers, Detectors and Associated Equipment*, 623(2), 656-659. doi: 10.1016/j.nima.2010.03.121.

Data acquisition of the Thomson scattering system

Milan Aftanas, Petr Böhm, Petra Bílková

In collaboration with:

M.J. Walsh, ITER Organization, Route de Vinon-sur-Verdon, 13115, St. Paul-lez-Durance, France

Rory Scannell, Graham Naylor, Martin Dunstan, Association EURATOM-CCFE, Culham Science Centre, Abingdon, Oxfordshire, OX14 3DB, United Kingdom

The data acquisition part of the Thomson scattering system has been tested, existing codes for both controlling the analog digital converters and data processing have been modified and tested. Strategy for triggering unit development has been discussed.

The both fast and slow Analog-to-Digital Convertors (ADC) for Thomson Scattering (TS) system were delivered in the end of year 2009. In 2010 the fast digitizers have been tested, skew measurements were performed (Fig 1.) and ADC's are ready to be tightly synchronized with the reference clock by the phase-locked-loop technology. The data acquisition will be triggered by the laser pulses and thus the laser timing is for now the limiting factor of the real-time TS on COMPASS.

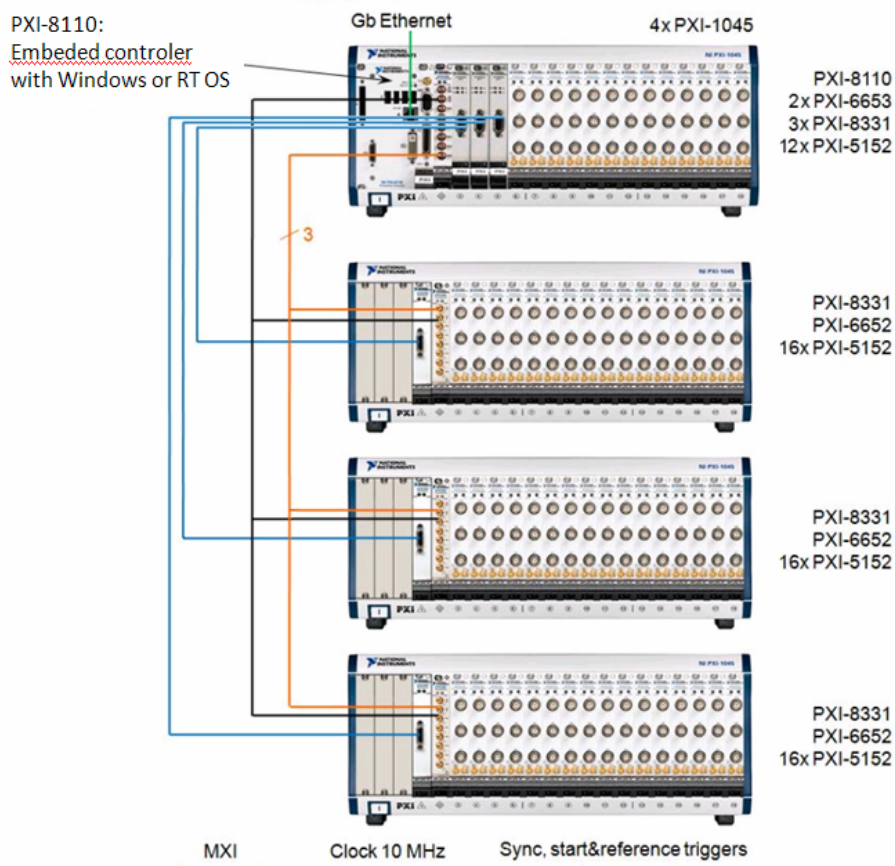

Fig 1 Layout of the DAQ TS Compass system

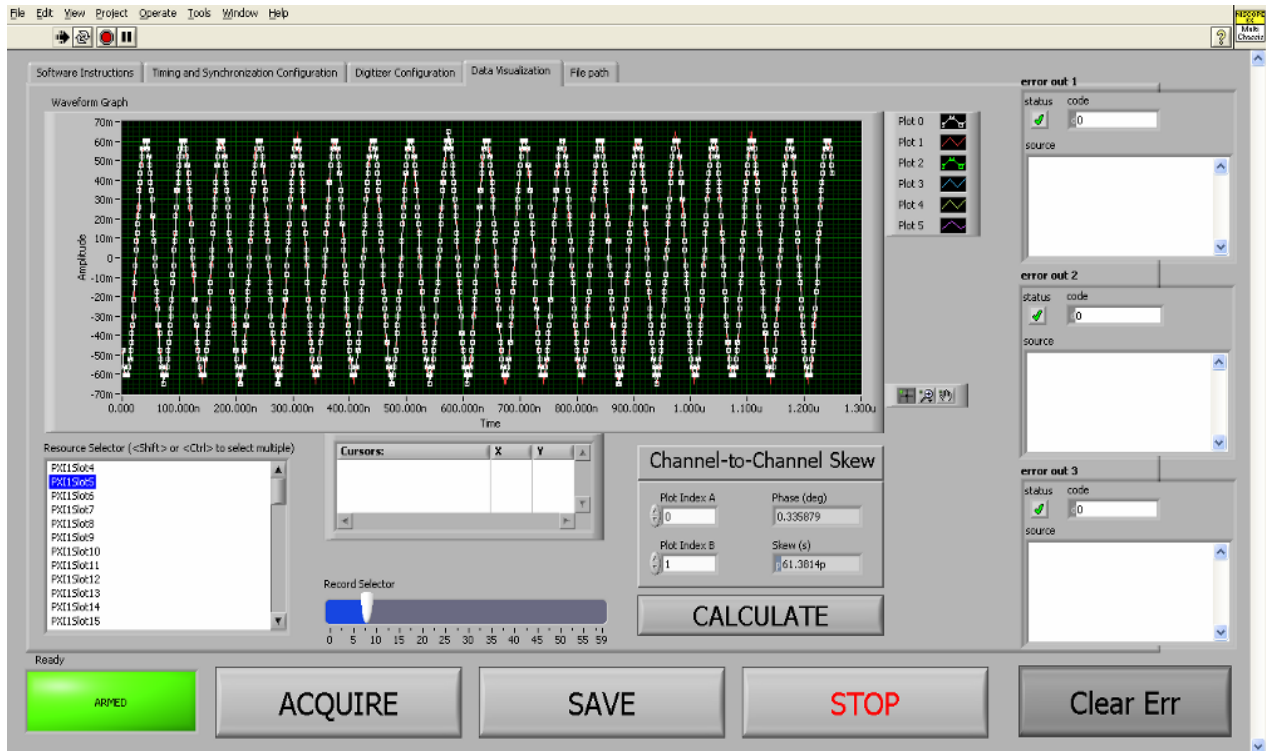

Fig. 2. Skew test in progress. Measured inter-channel skew was below 100 ps.

Basic programme to control and synchronize the fast digitizers was delivered by the manufacturer. This program has been modified during the first half of the year 2010 with to respect COMPASS needs and triggering functionality to external signal was add. The data structure of the system was developed and prepared for usage (calibration files, settings files) and IDL routines for basic TS data analysis (determination of electron temperature profiles) prepared.

Routines for automatization of electrical set-up were created and were used for setting the proper values of electric circuit (temperature compazation, offset, etc.). Routine for spectral calibration were finished at the end of the year 2010 and are fully used for calibration of the polychromators. These routines are able to substract offset and measure also power spectrum of the white light source.

References:

- [1] Bilkova, P., Melich, R, Aftanas, M, Böhm, P, Sestak, D., Jares, D., et al. (2010). Progress of development of Thomson scattering diagnostic system on COMPASS. The Review of scientific instruments, 81(10), 10D531. doi: 10.1063/1.3494378.
- [2] Bílková, P., Aftanas, Milan, Böhm, Petr, Weinzettl, Vladimír, Šesták, D., Melich, Radek, et al. (2010). Design of new Thomson scattering diagnostic system on COMPASS tokamak. Nuclear Instruments and Methods in Physics Research Section A: Accelerators, Spectrometers, Detectors and Associated Equipment, 623(2), 656-659. doi: 10.1016/j.nima.2010.03.121.
- [3] M. Aftanas, P. Bilkova, P. Bohm, V. Weinzettl, J. Stockel, M. Hron, R. Panek, R. Scannell, M. Walsh: Data acquisition system and data processing for the New Thomson scattering system on the COMPASS tokamak, Week of Doctoral Students, Faculty of Mathematics and Physics, Charles University, May 2010.

COMPASS CODAC system and real time feedback

*M. Hron, M. Aftanas, R. Beno, P. Cahyna, J. Havlicek, J. Horacek, F. Janky, R. Panek,
J. Pisacka, V. Weinzettl*

In collaboration with:

I.S. Carvalho, D.F. Valcárcel, H. Fernandes, B.B. Carvalho, J. Sousa, A. Duarte, Association EURATOM-IST, Lisbon, Portugal

M. Berta, S. Tulipán, G. Veres, Association EURATOM-HAS, Budapest, Hungary

This report comprises the current status of the COMPASS control, data acquisition, and communication system, including issues related to the real time feedback. Here, the data acquisition, plasma and machine operation control, and real-time feedback are described.

Data Acquisition

A basic set of 448 A/D converters for standard diagnostics based on an ATCA system [1], was installed and commissioned for use on COMPASS. The ADCs run at 2MS/s and they can cover the whole discharge of 1s duration. Moreover, channels used for the real-time feedback can be down-sampled before entering the data processing loop. The system is controlled through the central CODAC interface FireSignal (see last section). During the commissioning, it was found the bandwidth of the ADCs is an issue to be followed: increase of the ADCs bandwidth would be highly desirable but must be carefully checked versus the possible noise level.

Further, 116 channels of fast 2 GS/s A/D converters were put in operation for the Thomson scattering laser diagnostics. The system allows to sample multiple time windows during each plasma discharge, each time window has typically several tens of nanoseconds to cover the laser pulse duration. At the moment, the control of this system is done in LabView.

Plasma Control and Real-time Feedback

A new control system based on an ATCA real-time system with a multi-core x86 processor has been built. It makes use of two software components: the BaseLib2 and the MARTe (Multithreaded Application Real-Time executor) real-time frameworks. The BaseLib2 framework is a generic real-time library with optimized objects for the implementation of real-time algorithms. This allowed to build a library of modules that process the acquired data and execute control algorithms. Thus, the control software is implemented on top of the MARTe [2, 3] attaining control cycles as short as 50 μ s, with a jitter of less than 1.5 μ s. The controlled parameters, important for the plasma performance are divided in two control cycles: slow at 500 μ s and fast at 50 μ s.

In the first phase, a digital PID controller was implemented for the slow 500 μ s cycle, including the plasma current and position. The vertical instability and horizontal equilibrium are controlled with the faster 50 μ s cycle PID controllers. The shaping magnetic field remains pre-programmed at present. The system was designed to be as modular as possible, by breaking the functional requirements of the control system into several independent and specialized modules. This splitting enabled to tune the execution of each system part and to use the modules in a variety of applications with different time constraints [4].

To derive the control algorithm for vertical plasma position feedback, first the poloidal magnetic fields are computed. Thus, linear relation for the vertical forces is obtained using data from four (or more) magnetic coils together with algorithm for real-time plasma position [5,6]. Then, the resulting equations determine the vertical plasma dynamics [7].

The operation of the fast feedback power supply [8] was tested during 2010 and the original design had to be modified in order to protect the transistors in the amplifier. However, at last tests some of the transistors were still damaged. Therefore, new connections were made to be able to diagnose the amplifier in details and to find the problem. The results of this study let us to major design changes that will be implemented in the first quarter of 2011.

Operation Control

Within the real-time control, the integration in Control, Data Acquisition, and Communication (CODAC) systems becomes an important issue. This implies not only a connection to a main central coordination system, but also communication with related diagnostics and actuators. Therefore, the control requires non-ambiguous user-interface for configuration of the hardware devices. With that aim, a highly generic system called FireSignal [9] has been developed. Among the main features it allows remote hardware configuration, shot launching, data sharing between connected users and experiment monitoring. The system is fully distributed: the hardware driver nodes, clients, and servers are independent from each other. They may run on different operating systems, and can be programmed in different languages. All the communication is provided through the Common Object Request Broker Architecture (CORBA) protocol.

Database, data viewers, and the security system can be changed easily and adapted to the machine's needs. Every hardware is described in eXtensible Markup Language (XML) and with this information Graphical User Interfaces (GUI) are automatically built. Thus, any type of hardware device can be integrated in the system as long as it is described in XML and the respective driver is developed. Currently Python and Java generic drivers are used; however, any modern programming language can be used to develop these drivers. The data storage and indexing are time stamp event-based. Nodes are responsible for tagging the acquired samples with the absolute time stamps and to react to the events.

Finally, a FireSignal subsystem was developed and installed for the control of the vacuum, gas injection, and baking. These tasks are performed by dsPIC micro-controllers that receive commands from a hub computer and send information regarding the status of the operation. Communications runs on a serial RS-232 link via fibre optics. A Java-based GUI for control and monitoring of the subsystem was developed and installed in the hub computer [10].

References:

- [1] D.F. Valcárcel, et al., *Fusion Eng. Des.* 84 (2009), Issue 7-11, 1901-1904, doi:10.1016/j.fusengdes.2008.12.011
- [2] A. C. Neto et al., *IEEE Transactions on Nuclear Science* 57 (2010) 479–486.
- [3] D.F.Valcárcel, et al., *Fusion Eng. Des.* 85 (2010) 470–473, doi:10.1016/j.fusengdes.2010.03.049
- [4] D.F.Valcárcel, et al., *17th Real-Time Conference, 24-28 May 2010, Lisboa, Portugal*
- [5] J. Havlicek, et al., *Proceedings of WDS'09* (2009) 148-152.
- [6] J. Havlicek, et al., *Proceedings of WDS'10* (2010) 12–17.
- [7] J. Horacek, et al., *26th SOFT, 27 September – 1 October 2010, Porto, Portugal*
- [8] I.S. Carvalho, et al., *17th Real-Time Conference, 24-28 May 2010, Lisboa, Portugal*
- [9] A. Neto, et al., *Fusion Eng. Des.* 82 (2007), 1359-1364, doi:10.1016/j.fusengdes.2007.02.016
- [10] A.S. Duarte, et al., *Fusion Eng. Des.* 85 (2010), 496–499, doi:10.1016/j.fusengdes.2010.03.056

Personnel protection during operation of Thomson scattering laser system

P. Bohm, M. Hron, J. Kovar, J. Sova, M. Zvolanek, M. Aftanas, P. Bilkova, R. Panek

In collaboration with:

M. J. Walsh, EURATOM/CCFE Fusion Association, Culham Science Centre, Abingdon, UK

Recently installed Thomson scattering diagnostic on COMPASS tokamak facilitates two high power lasers, the presented protection system ensures laser safety of the personnel. Protection covers three areas – laser laboratory, spectrometer laboratory and tokamak hall. Laser protection system inputs are controlling covering of the laser beam path, entrance doors, beam shutters and laser cooling. Six regimes are defined for the protection system, covering all operation of the laser system, including laser service and low power beam alignment. Hardware implementation of the protection is based on PLC. The system is controlled via PCs with a touch screen. Connection to the COMPASS personnel protection system is described.

Thomson scattering diagnostic (TS) [1] uses a laser system that comprises of two Nd:YAG lasers, 1.5 J pulse energy and 30 Hz repetition rate each [2]. Laser wavelength is 1064 nm, in the invisible infra-red spectra. Therefore the lasers require a dedicated protection system like eg. on MAST [3]. For COMPASS, several regimes of the safety system were defined to cover the alignment of the line using a HeNe laser (class 2) as well as the operation of the high power Nd:YAG laser (class 4) in case of

1. standard measurements during the experiments,
2. beam alignment in the test path,
3. beam alignment in the experimental hall, etc.

The safety system is based on a PLC (Programmable Logical Controller) which handles the inputs from the laser path covers, doors, tokamak hall shutters, etc. and which allows the high power laser operation at given conditions. The operator interface is built using a touch panel where the operating personnel can request individual regimes of the operation.

The design of the protection system is based on a modular PLC system Foxtrot made by Teco. The protection system includes a central unit, supply source and 17 remote digital input and output modules. Central PLC includes a 32-bit RISC processor, Ethernet and CIB interface, several digital inputs and relay outputs on one board. The logical inputs originate on switches which control the enclosure of the box covers, doors in laboratories, locks, etc. (see Fig. 1).

The controller output is connected to a security lock of the high-power lasers. In such a way, the operation of the lasers is blocked as long as all the conditions are not fulfilled. The PLC operates in a loop: after an initialization, the PLC reads the inputs, performs the main code run, and sets the outputs, then returns to reading the inputs and so on. The cycle time is 100 ms.

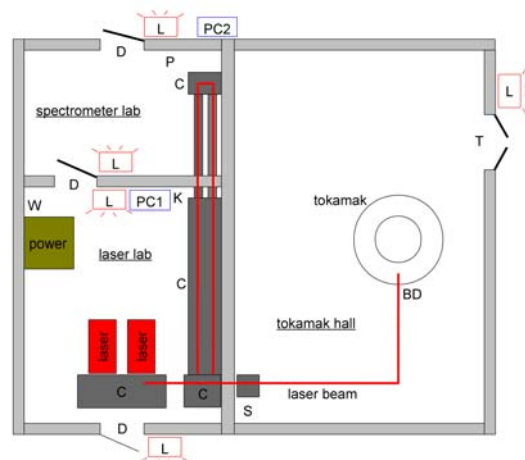

Fig. 1. Layout of key elements of the TSP system: C – box covers, D – door contacts, L – warning lights, PC1,2 – control PC, P – push button to confirm spectrometer laboratory check, W – cooling water flow, K – operators keys, S – beam shutter, BD – beam dump

The requirements for several regimes of operation of the laser system result into six states of TS protection system to cover all situations during TS diagnostic operation. For each situation there is an unique regime of the protection system. E.g. the Nd:YAG lasers can be aligned and serviced under regime “test path - laser room”, keeping the spectrometer laboratory accessible. If longer optical distance is requested for the alignment, regime “test path – spectrometer room” prevents unauthorized staff from entering the both laboratories.

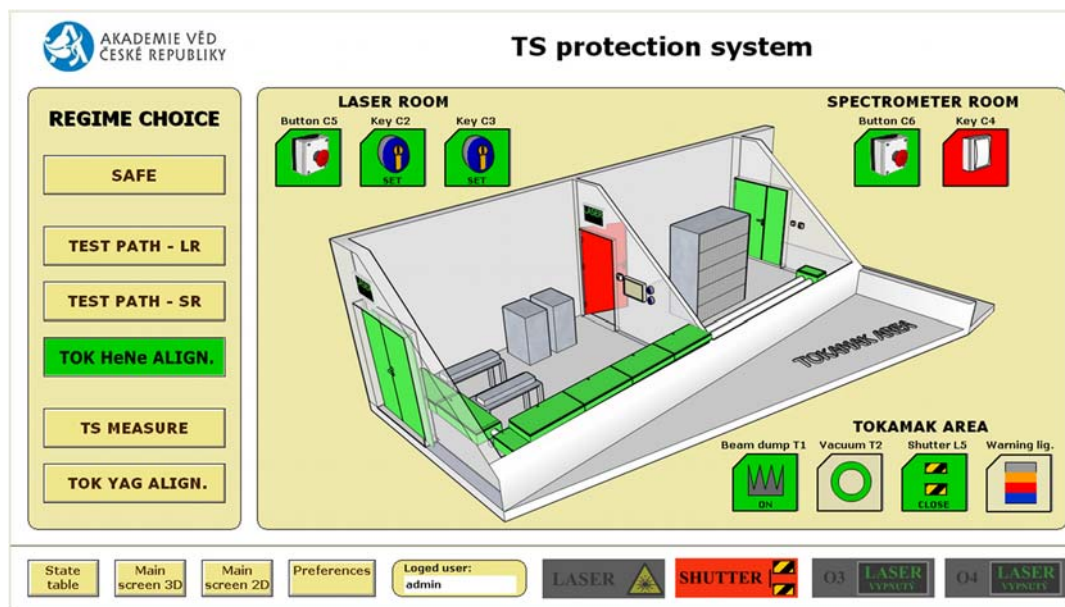

Fig. 2. Visualization screen for the operator interface (example for the HeNe laser alignment regime).

The visualization runs on two PCs – in the laser laboratory and at the entrance, outside of laser laboratory. The PCs visualize the states of the system and its individual components. The transition between each two states is based on information obtained from sensors connected to the PLC. Information from sensors is used to compare the actual state of physical elements (shutter, doors, laser cover etc.) with the requirements for the transition between states. Visualization software is written in Reliance [4], which is one of the developmental environment for PLC programming according to current standards in the industry. Fig. 2 shows a screen shot for case of the HeNe laser alignment as an example.

This system is an extension of the personnel protection system used during the tokamak operation [5]. Details of the personnel protection during the operation of the Thomson scattering laser system are described in [6].

References:

- [1] P. Bílková, et al., *Nucl. Instr. and Meth A* (2010), doi:10.1016/j.nima.2010.03.121
- [2] P. Bohm, et al., *Rev. Sci. Instr.*, doi: 10.1063/1.3460450
- [3] R. Scannell, et al., *Rev. Sci. Instrum.* 79, 10E730 (2008)
- [4] Reliance, www.reliance.cz
- [5] M. Hron, et al., *Fusion Eng. Des.* 85(2010) 505-508, doi:10.1016/j.fusengdes.2010.03.054
- [6] P. Bohm, et al., *Fusion Eng. Des.* (2011), doi:10.1016/j.fusengdes.2011.02.073

3. Development of concept improvements and advances in fundamental understanding of fusion plasmas

EBW heating and current drive simulations for spherical tokamaks

J. Urban, J. Preinhaelter

In collaboration with:

J. Decker, Y. Peysson Association EURATOM-CEA Cadarache, France

V. Shevchenko Association EURATOM-CCFE, Culham, UK

G. Taylor Princeton Plasma Physics Laboratory, NJ, USA

L. Vahala Old Dominion University, Norfolk, VA, USA

G. Vahala College of William & Mary, Williamsburg, VA, USA

By means of coupled ray-tracing and Fokker-Planck simulations, we have thoroughly investigated electron Bernstein wave heating and current drive prospects for spherical tokamaks, particularly for four typical present and prospect plasmas: NSTX L- and H-mode, MAST Upgrade and NHTX. For the first time, a simple analytic formula for the O-X conversion efficiency of a Gaussian beam is derived from 1D plane wave theory. This formula supports our choice of the Rayleigh range as the antenna beam principal parameter that is fixed for all simulated cases.

Figures 1 and 2 show our current drive efficiency results for NSTX L-mode and for MAST Upgrade. In general, on an extensive set of EBW launch scenarios with varying frequency, vertical antenna position and toroidal injection angle, we show that EBWs can be absorbed at almost arbitrary radius and that EBWs can drive current with efficiencies comparable to electron cyclotron O- or X-modes. Moreover, the efficiency does not change with radius, while typically X- and O-modes' efficiency decrease with radius. Best results in terms of efficiency and flexibility are achieved in NSTX plasmas, where the electron cyclotron frequency radial profiles are monotonous. In general, normalized current drive efficiencies $|\zeta|$ on the order of 0.3 – 0.4 are feasible for all target plasmas, absolute efficiencies then depend on the plasma parameters as $\eta \equiv I_{\text{RF}} / P_0 \cong 0.31\zeta T_e / R_0 n_e$, where the units are A/W for η , keV for T_e , m for R_0 and 10^{19} m^{-3} for n_e .

For EBWs, only initial N_{\parallel} sign can be chosen at will, while further evolution is determined by the wave frequency, the vertical launch position and by the plasma parameters. We have shown how different vertical launch position influences the N_{\parallel} spectrum and consequently the current drive efficiency. However, there seems to be no general correlation between the current drive efficiency and the N_{\parallel} spectrum and its width. This result is rather surprising.

Input power scans have been performed to investigate the quasilinear effects. Increasing power generally leads to either lower or similar current drive efficiency, although contrary results exist. Higher power also causes the wave absorption to occur further in the propagation direction, which can either be towards the axis if the absorption occurs on the outboard side or away from the axis in the opposite case. An important factor is the effective ion charge, which determines the electron-ion collisionality and significantly affects the current drive efficiency. Minor effect of Z_{eff} on the driven current location can be observed, which is caused by changing the plasma quasilinear response.

The sensitivity of the EBW heating and current drive to changes in plasma parameters has been investigated. It has been shown that the EBW performance is rather robust. Neither the current drive efficiency nor the radial location changes significantly when the electron temperature or density changes moderately. Larger sensitivity is observed for magnetic field changes, especially the (dominant) toroidal field.

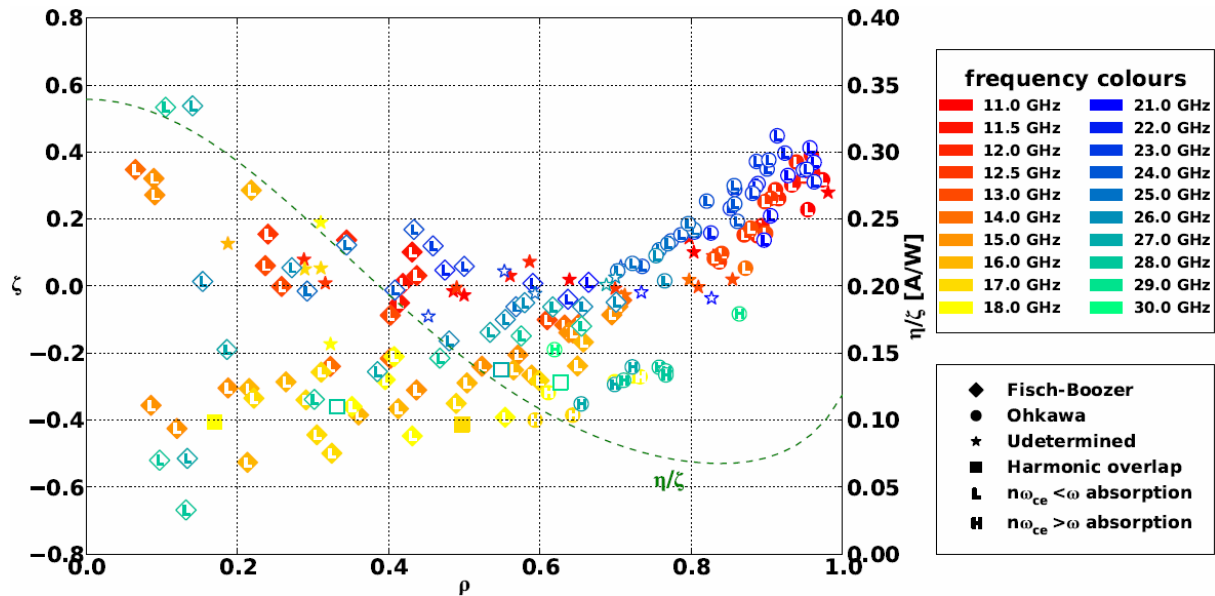

Fig. 1. Normalized current drive efficiency ζ (symbols) and η / ζ conversion factor (dashed line) versus ρ , NSTX L-mode first (full symbols) and second (open symbols) harmonics, different frequencies and vertical launch positions, 1 MW incident power.

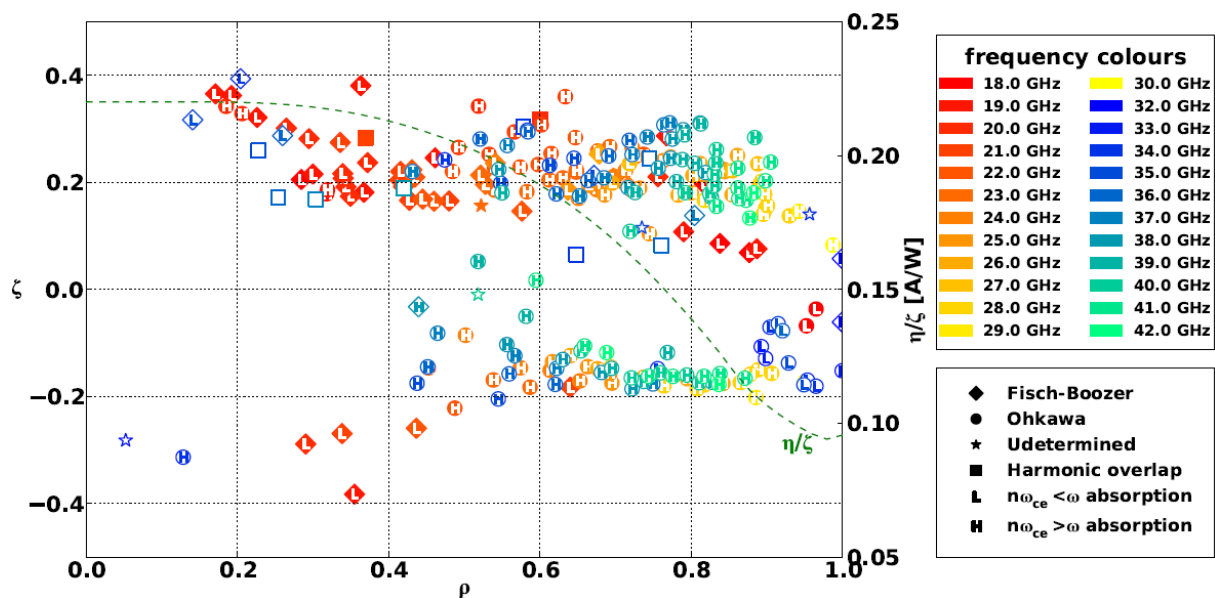

Fig. 2. Same as Fig. 1 but for MAST Upgrade.

EBW simulations for WEGA

J. Preinhaelter, J. Urban

In collaboration with:

H.P. Laqua, Max Planck Institute of Plasma Physics, Greifswald

The WEGA stellarator proved again to be an excellent test bed for microwave applications in magnetic confinement fusion research. Its recent ability to operate at 0.5 T magnetic field with plasmas fully sustained by electron cyclotron waves has opened an interesting new research area. In particular, WEGA discharges can be exclusively sustained by electron Bernstein waves (EBWs) via the so called OXB heating scheme. Our AMR code has already proved to be a well suited code for EBW physics on WEGA. We therefore applied this code to explain and interpret WEGA experimental results.

The OXB antenna features a steerable mirror, which can be used to inject the O-mode waves in negative or positive optimum OXB angles. Very interesting results are obtained during OXB WEGA experiments; extremely high ECE (EBE) temperature, $\sim 10 - 50$ keV (the plasma temperature is expected to be ~ 50 eV) during the OXB phase; sharply peaked ECE spectra around the heating frequency; fast electrons with $T_e \sim 10$ keV detected by X-ray diagnostics with total energy ~ 1 J.

This motivated us to formulate a hypothesis with a suprathermal electron population in the mode conversion region. Such a model is shown in Fig. 1, where the background bulk electron density is plotted along with a thin suprathermal electron layer. The temperature was finally assumed to be 20 keV, the energy content for the particular case of Fig. 4 is 1.4 J, in agreement with the experimental value. Only waves whose mode conversion occurs at this layer can interact efficiently with the suprathermals; hence, the radial location of the layer determines the frequency that is absorbed or emitted by the suprathermals. The resulting emission spectrum is shown in Fig. 2, which feature a sharp peak around the 28 GHz heating frequency, irrespective of the magnetic field, which is also observed in experiments. Moreover, the suprathermal layer is semi-transparent, enabling a partial central absorption with absorbed power profiles dependent on the external magnetic field.

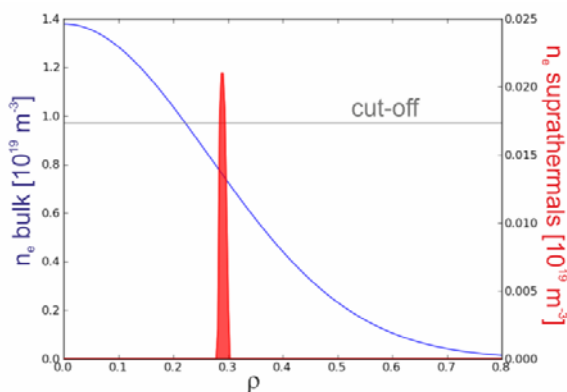

Fig. 1. Model bulk electron density with a suprathermal electron layer at the mode conversion region.

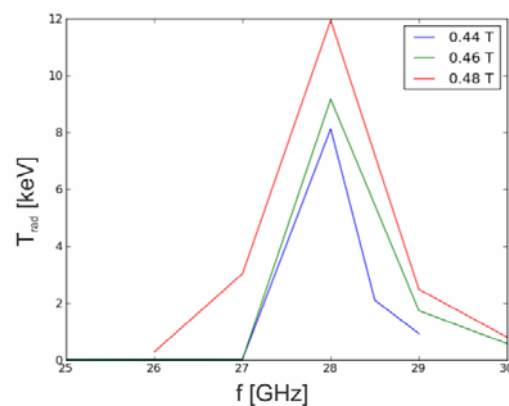

Fig 2. Simulated electron Bernstein wave Emission spectrum using suprathermal electron layer profiles from Fig. 1 and various external magnetic fields.

References:

- [1] J. Preinhaelter et al., *Plasma Phys. Control. Fusion* **51** (2009) 125008

Detection of EBW emission on COMPASS

J. Preinhaelter, J. Urban, J. Zajac, F. Žáček

In collaboration with:

S. Nanobashvili, Andronikashvili Institute of Physics, Tbilisi, Georgia

A newly developed method was used for the more accurate absolute calibration of the radiometer in the Ka band.

During year 2010 we developed a new apparatus for the absolute calibration of the radiometer in the frequency range 26.5 – 40 GHz (Ka band). Unlike previously used method, this calibration uses the fast semiconductor PIN-switch for the waveguide switching, see Figs. 1 and 2. The new calibration is more accurate and the method was presented on the 18th Topical Conference on High-Temperature Plasma Diagnostics, USA (2010) [1]. Furthermore the radiation characteristics of used antenna and mirror in the Ka band were measured. The method and results was also presented in [1]. An example of the measured E-field radiation pattern is in Fig. 3. Because the so far used mirror is quite small for the good quasi-optical characteristics, the new steerable mirror is being manufactured.

The radiometer was used for the measurement of the plasma radiation temperature (see Fig. 4), beside other during the Summer School on Experimental Plasma Physics [2]. The first harmonic O-mode radiation was used. So far, the plasma conditions in Compass tokamak have not made possible the experimental study of the EBW emission – this will be likely possible in 2011.

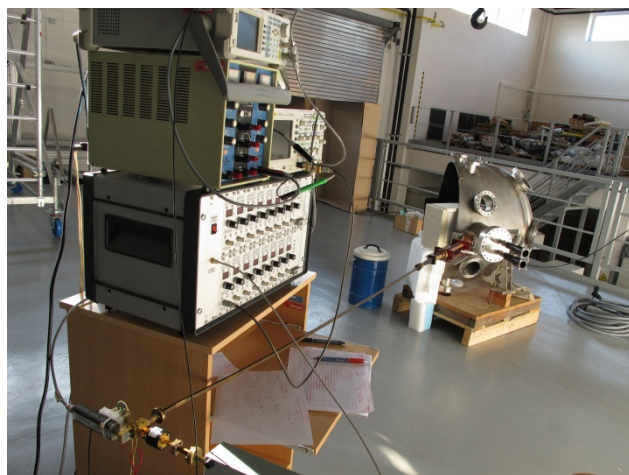

Fig. 1. Calibration of the radiometer by the newly developed method.

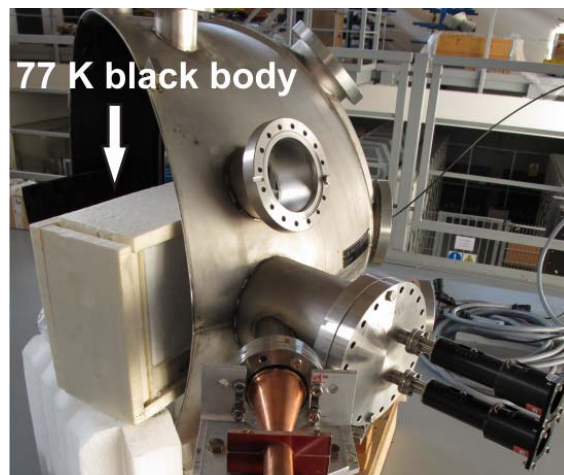

Fig. 2. Detail of the calibration apparatus.

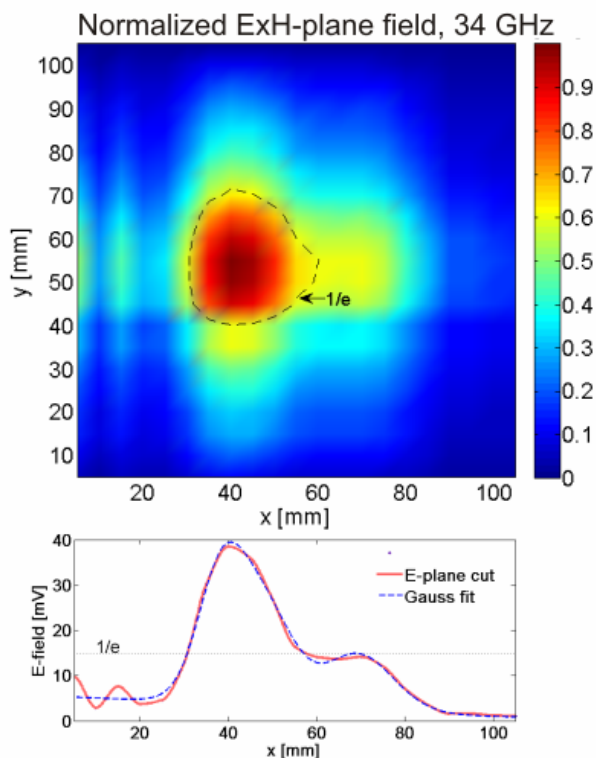

Fig 3. Crossection of the measured radiation pattern in front of the mirror placed in tokamak vessel, 2-D (top) and 1-D (bottom), the main lobe is above the $1/e$ level

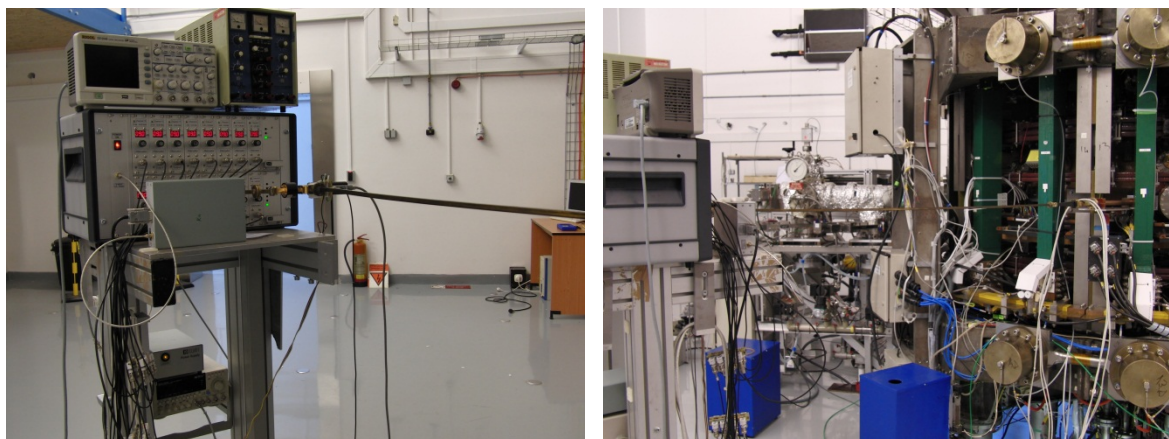

Fig. 4. Measurement of the radiation temperature on Compass tokamak

References:

- [1] Zajac J., Preinhaelter J., Urban J., Žáček F., Šesták D., Nanobashvili S.: Electron cyclotron-electron Bernstein wave emission diagnostics for the COMPASS tokamak, Proceedings of the 18th topical conference on high-temperature plasma diagnostics, Wilwood, New Jersey, USA, , 2010, Rev. Sci. Instrum. 81, 10D911 (2010)
- [2] SUMTRAIC 2010 Prague, 8th International Summer School on Experimental Plasma Physics, http://www.rmki.kfki.hu/plasma/sumtraic_2010/ /see also subpart 5 of this AR.

4. Emerging Technologies

Irradiation tests of ITER candidate Hall sensors using two types of neutron spectra

I. Ďuran, L. Viererbl, J. Sentkerestiová, Z. Lahodová, P. Bém

In collaboration with:

I. Bolshakova, R. Holyaka, Magnetic Sensors Laboratory, Lviv Polytechnic National University, Lviv, Ukraine

We performed irradiation tests of InSb based Hall sensors at two irradiation facilities with two distinct types of neutron spectra. One was fission reactor neutron spectrum with significant presence of thermal neutrons, while another one was purely fast neutron field. Total neutron fluence of the order of 10^{16} cm^{-2} was accumulated in both cases leading to significant drop of Hall sensor sensitivity in case of fission reactor spectrum while stable performance was observed at purely fast neutron spectrum. This finding suggests that performance of this particular type of Hall sensors is governed dominantly by transmutation. Additionally, it further stresses the need to test ITER candidate Hall sensors under neutron flux with ITER relevant spectrum.

Hall sensors, along with micromechanical magnetometers, are presently the two most promising concepts for ITER ex-vessel steady state magnetic diagnostic [1]. Implementation of Hall sensors in ITER environment requires their compatibility with temperature of at least $220 \text{ }^\circ\text{C}$ and with the total life time neutron fluence between $6.4 \times 10^{15} \text{ cm}^{-2}$ and $1.3 \times 10^{18} \text{ cm}^{-2}$ depending on poloidal location of each sensor. Such sensors are not available on commercial basis and as a result, special developments are needed. The Hall sensors based on InSb with a main doping agent being tin showed a most promising performance in terms of stability under neutron irradiation during previous experiments [2]. There are two main processes affecting the stability of InSb based Hall sensors under neutron irradiation. First, the thermal neutrons cause mainly transmutation of the sensing material leading to the additional nuclear doping of the semiconductor. The dominant nuclear reaction here is transmutation of Indium into tin, while tin acts as donor in InSb increasing the free charge carrier density and, as a result, decreasing sensitivity of the Hall sensor. On the other hand, fast neutrons cause mainly structural damage of the sensing material creating defects in crystal lattice, which are dominantly of acceptor nature. As a result, they effectively decrease the free charge carrier density within InSb semiconductor and, consequently, they lead to increase of sensitivity of Hall sensor.

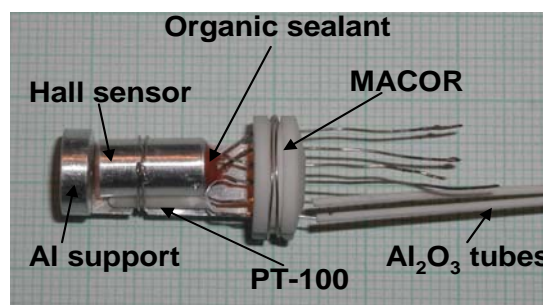

Fig. 1. Hall sensor sample mounted on aluminium support structure together with PT-100 thermometer.

The four samples of Hall sensors with the specified maximum survival temperature of 200°C were delivered by Magnetic Sensor Laboratory, Lviv Polytechnic National University, Lviv, Ukraine (MSL) for irradiation tests. All sensors were based on the similar sensing material i.e. solid solution of InAs and InSb ($\text{InAs}_x\text{Sb}_{1-x}$) with the main doping element being tin. The

sensors were prepared to cancel out as much as possible two competitive irradiation effects which modify sensors' sensitivity. Each of the sensors was fixed on an aluminum support structure together with wound PT-100 thermo-resistor and/or K type thermocouple in thermal contact with the sensor's casing, see figure 1. This assembly was mounted within an irradiation head which provides radiation independent calibration magnetic field of approximately five militesla.

Irradiation experiments were performed at the LVR-15 fission reactor and the U-120M cyclotron. The LVR-15 is a 10 MW light-water moderated and cooled tank nuclear reactor with forced cooling operated by Nuclear Research Institute, plc., Řež, Czech Republic. It provides maximum fluence rate of $3 \times 10^{14} \text{ cm}^{-2}\text{s}^{-1}$ within the reactor core. The cyclotron U-120M accelerates protons (10-25 MeV), deuterons (10-20 MeV), ^3He (17-53 MeV), and alpha particles (20-40 MeV) with currents up to a few μA . We irradiated the single Hall sensor at high energy neutron target station NG2. NG2 beam facility provides white-spectrum neutron fields ($E < 35 \text{ MeV}$) with the fluence rate up to $3 \times 10^{11} \text{ cm}^{-2}\text{s}^{-1}$ exploiting $\text{Be}(d, xn)$ reaction.

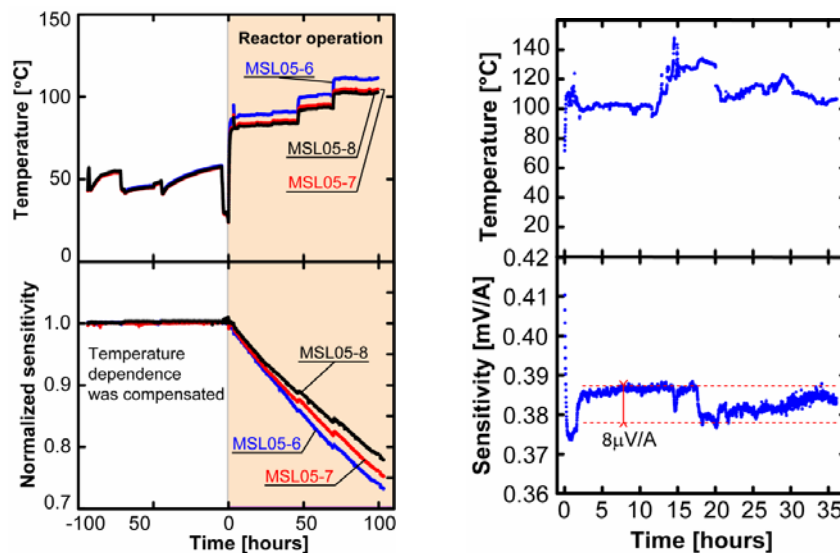

Fig. 2. Temporal evolution of temperature (upper panels) and Hall sensor sensitivity (lower panels) in the course of irradiation at reactor LVR-15 (left panels) and at cyclotron U-120M (right panels).

Temporal evolutions of data recorded during the both irradiation experiments are summarized within figure 2, left panel – LVR-15, right panel – U-120M. Temperature of the sensors in the course of irradiation is plotted in the upper panels while, their sensitivity is plotted in bottom panels. Total neutron fluence accumulated in both cases was of the order of 10^{16} cm^{-2} exceeding the total expected ITER life time fluence at low field side locations for steady state magnetic sensors which is $6.4 \times 10^{15} \text{ cm}^{-2}$. Significant decay of sensitivity by about 30% was observed for the sensors after exposure to the neutron flux with fission reactor spectrum while no change of sensor properties was seen when it was exposed to the fast neutron field at U-120M cyclotron. This suggests that the transmutation is a dominant process affecting performance of these sensors. Knowledge of expected neutron spectrum at particular location of each steady state magnetic probe head on ITER is important to identify optimum initial parameters of Hall sensors for each location to ensure their stable performance.

References:

- [1] R. Chavan, et al., *Fusion Engineering and Design* 84 (2009) 295-299.
- [2] I. Bolshakova et al., *Sensor Letters* 5 (2007) 283-288.

Influence of neutron irradiation on the properties of candidate fusion materials

J. Matějček

In collaboration with:

J. Sedláček, Czech Technical University, Prague, Czech Republic

L. Viererbl, Nuclear Research Institute, Řež, Czech Republic

M. Roedig, Forschungszentrum Juelich, Germany

IPP participates in a broader project "Materials and Components for Nuclear Reactors", led by the Nuclear Research Institute, Řež. The goal is to investigate the changes in candidate fusion materials properties after neutron irradiation. Particular focus is placed on plasma sprayed coatings (tungsten, copper, stainless steel, alumina) and other bulk materials with potential application in ITER, DEMO or other fusion devices. The material features studied include structural changes, thermal and electrical properties and behavior under heat flux.

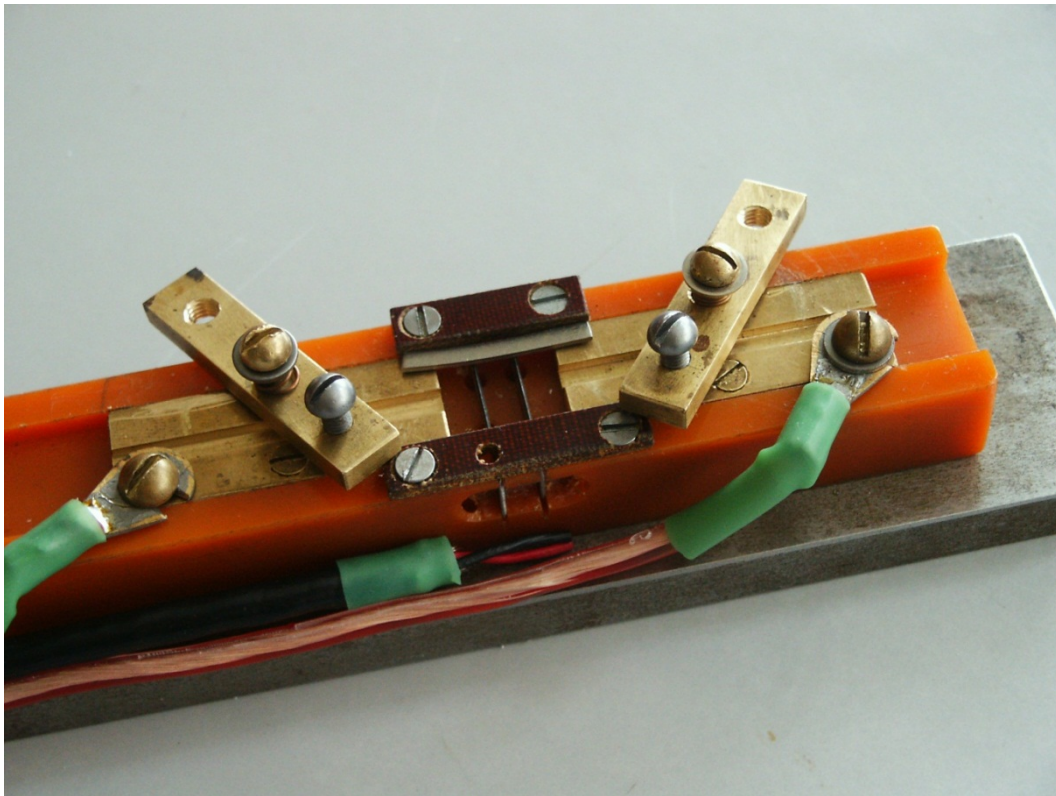

Fig. 1. Test rig for measurement of resistivity of irradiated metallic samples in hot cells

Post-irradiation experiments

The irradiation was concluded in 2009. Majority of the samples were extracted from the irradiation capsules; some of them still remain enclosed due to complications with the extraction. Samples for thermal conductivity and heat flux characterization were transported to Forschungszentrum Juelich.

For the characterization of electrical properties, a special test rig was developed and built that permits resistivity measurements on active samples in hot cells (see fig.). The measurement was verified on selected unirradiated samples and a very good agreement with the standard instrument was obtained. First measurements on irradiated stainless steel samples were performed; these showed the necessity of rig modification to ensure contact pressure stability in hot cells. The modification is underway.

Resistivity measurements on ceramic samples were performed in a controlled environment, using a guarded electrode method (ASTM D257-66). A decrease of resistivity several orders of magnitude was observed. Investigation of possible mechanisms is underway.

Complex metallographic examination (including porosity, hardness and composition) of the un-irradiated glass-ceramic samples from Politecnico Torino has been performed, characterization of irradiated ones is underway.

As for the remaining samples, transport to Ciemat is under negotiation, pending successful extraction.

Development of tungsten-based functional gradient materials prepared using powder laser deposition.

H. Boldyryeva, J. Matějček

In collaboration with:

P. Ambrož, Czech Technical University in Prague (ČVUT), Prague, Czech Republic

Tungsten-based functional gradient materials have potential application as a heat-protection armor, e.g. in fusion reactor components. This study is focused on processing of tungsten-steel functionally graded materials (FGMs) by laser deposition and their characterization. Various processing conditions are also employed.

Laser deposition experiments were performed in collaboration with Czech Technical University in Prague. Scanning speed (200 mm/min), powder feed rate and supplying Ar gas pressure (1 Bar) were kept stable.

Experiments with a different scanning speed and different regimes of scanning were done previously. As a result, homogeneous, non-porous (at least on a micro-level) and continuous single sprayed layer could be prepared. The thickness of a single layer is limited and under our optimal preparation conditions could be increased up to slightly over 1 mm. As shown on Fig. 1, further spraying of second and third layers on top of the first single layer results in drastic porosity increase, in a range of tens of micrometers. EDX measurements show that the top layer consists of pure tungsten.

Next step experiments aimed to increase layer thickness, minimize the porosity and to produce multilayered samples with controlled gradient structure. To investigate both types of layering sequences, stainless steel powder was employed for an intermediate layer between two tungsten containing layers. Fig. 2 shows cross-sectional SEM image of a sample consisting of four layers. First and last layers were prepared by laser spraying of tungsten powder (50-90 μm size) and for second and third layers steel powder (100-140 μm size) was used. EDX analysis shows that darker spots in the third layer (fig.2) contain a higher amount of oxygen than the rest of steel layer. That could be explained by partial oxidizing of surface of the second steel layer during its cooldown.

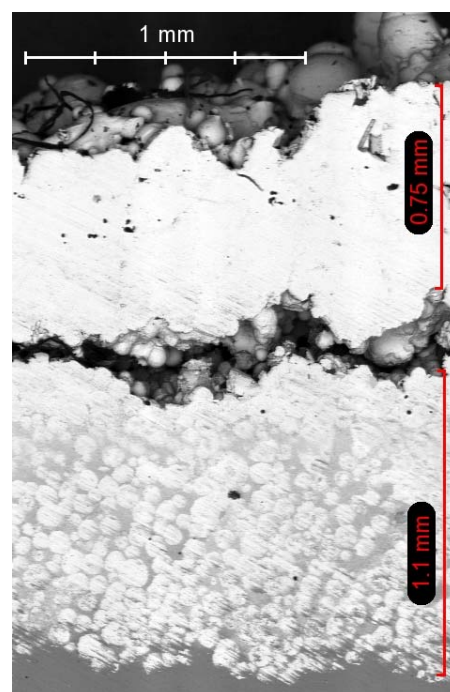

Fig. 1. Cross-sectional SEM image of sample consisting of two layers prepared by powder laser spraying. White indicates tungsten, gray – steel.

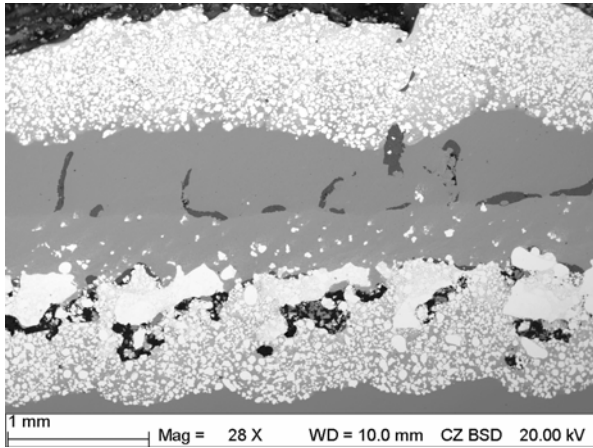

Fig. 2. Cross-sectional SEM image of sample consisting of 4 layers prepared by laser spraying of tungsten (1st and 4th layers) and steel (2nd and 3rd layers).

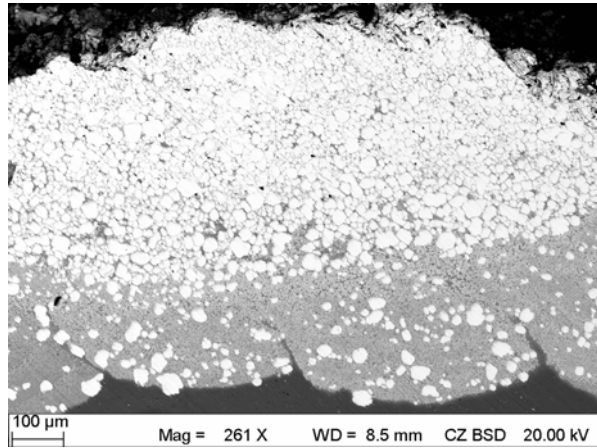

Fig. 3. Cross-sectional SEM image of sample consisting of two layers prepared by laser spraying of tungsten powder with a different grain size.

Tungsten powder of two different sizes was used for another experiment. The result is shown on Fig. 3. First layer was prepared from tungsten powder with size less than 50 μm, second layer with size 50-90 μm. EDX measurement shows a gradient of tungsten concentration (see Fig. 4).

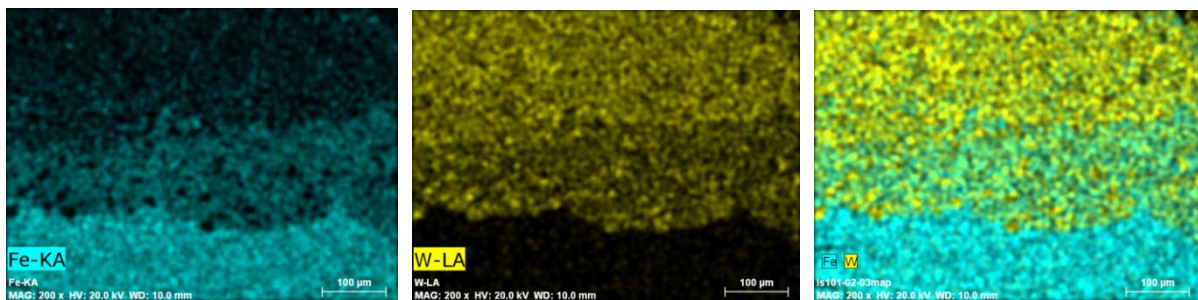

Fig. 4. EDX analysis of sample consisted of two layers prepared by laser spraying of tungsten powder with a different size.

Further processing options/modifications, such as laser post-treatment and the use of different combinations of tungsten and steel powder are underway.

Alternative processing concepts are also considered. Hot pressing was used to form homogeneous stainless steel/tungsten composites as well as FGM. High density composites were produced; characterization of their structure, homogeneity and thermal properties is underway. Plasma spraying as a technology offering a large area coverage capability was initiated. First experiments with a hybrid (water-argon) plasma torch, with and without argon shrouding, were performed with tungsten. Spraying of stainless steel, composites and FGMs is planned for the beginning of 2011. Comparison of various aspects of these technologies and layer properties will also be made.

Study of the micro-mechanisms of cleavage fracture of 14% Cr ODS ferritic steels

H. Hadraba, Institute of Physics of Materials AS CR

In collaboration with:

B. Fournier, CEA Saclay, France

The high-temperature embrittlement mechanism of the ferritic Fe-(12-14)Cr-(1-3)W-(0.1-0.5)Ti-(0.2-0.4)Y₂O₃ ODS steels is connected to the coarsening of the fine Y- and Ti-rich oxide particles. It was found that the Y-Ti-O particles in MA957 ODS steel coarsen at temperatures higher than 900°C.

The ODS steel ODM401 steel of nominal composition (wt.%) Fe-14Cr-0.9Ti-0.3Mo-0.25Y₂O₃ was produced by mechanical alloying process analogous to the fabrication process of the MA957 steel [1]. Commercially available atomized iron powder, ferrochrome powder, ferrotitanium powder, molybdenum powder and yttria powder were mixed in exact proportions and order and own processed in high energy ball mills for 24 hours in air atmosphere. A rod of diameter 30 mm was hot-extruded at 1150°C from the alloyed powder. Except straightening, no additional treatment of the as-extruded bar was done. Mini-Charpy KLST specimens of 3 × 4 mm cross section and length of 27 mm were machined according to the DIN 50115 standard. The length of the specimens was oriented in uniaxial direction. An instrumented impact testing of specimen prepared was conducted in the temperature region between -180°C to +24°C according to the standards EN 10045-1, ISO 148 and EN ISO 14556 by means of instrumented impact pendulum with capacity of 15 J released with velocity 3.85 m s⁻¹. The long-term high temperature annealing of the model ODM 401 steel has been realised in the air atmosphere at 650°C for 1.000 hours.

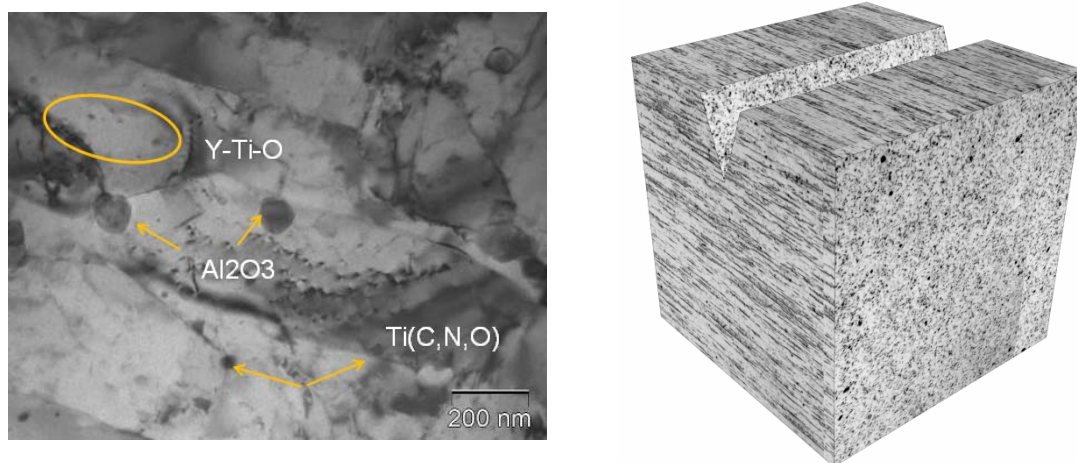

Fig. 1. Microstructure (left) and 3D reconstruction of texture of ODM401 (right) steel (notch orientation regarding to the texture is indicated).

The microstructure and 3D reconstruction of texture of the ODM401 steel are given in the Fig. 1. The microstructure of the steel consists of “cigar” shaped grains oriented in the extrusion direction. The microstructure of as-extruded steel has grains elongated in the uniaxial direction by ratio about 1:5 - 1:10. The steel contains also high amount of pore-chains (so called „alumina stringers“) of diameter up to 2 μm and length up to 100 μm [2]. The two populations of Y-Ti-O particles sizes were found in the microstructure of size about 10-20 nm and 2-3 nm. Besides the Y-Ti-O the yttria nano particles, the microstructure of the

steel contains Ti-C-O particles in size up to 80 nm, Ti-C-N particles in size up to 250 nm and Al-O particles in size up to 400 nm (see Fig. 1). The KLST Charpy specimens taken were oriented in longitudinal axis (axis parallel with extrusion direction) and the fracture planes were perpendicular to the extrusion direction. The notch of KLST Charpy specimens is indicated in the 3D reconstruction of the texture (see Fig.1). The impact energy temperature dependence of the steel is given in Fig. 2. The lower shelf energy (LSE) region of the impact energy was about 0.5 J and upper shelf energy (USE) region was about 10.5 J. The ductile to brittle transition temperature (DBTT) evaluated as a midway between LSE and USE was about -110°C .

The 3D reconstruction of the typical fracture surfaces of the steel is given in the Fig. 2. The uniaxially elongated grains led to the crack deviation along the grains and/or the grains boundaries. Brittle fracture of the steel fractured at LSE was formed by cleavage micro mechanism. Ductile fracture of samples broken at USE was formed by dimple (microvoid coalescence) micro-mechanism. The fracture surfaces contained also high amount of cracks oriented perpendicularly to the fracture surface. These cracks probably come from delamination of textured grains. In contrast to the common ferritic steels the fracture surface of the ODS steels samples fractured between LSE and USE contained no exactly separated areas fractured by brittle and ductile fracture. The outstanding embrittlement of the steel after long-time high temperature annealing was found (see Fig. 2). The lower shelf energy (LSE) region of the impact energy was about 0.5 J, upper shelf energy (USE) region was about 9 J and DBTT was about -60°C . The impact energy transition curve was after thermal ageing shifted towards higher temperatures and towards lower energies by about 50°C and 1.5 J respectively.

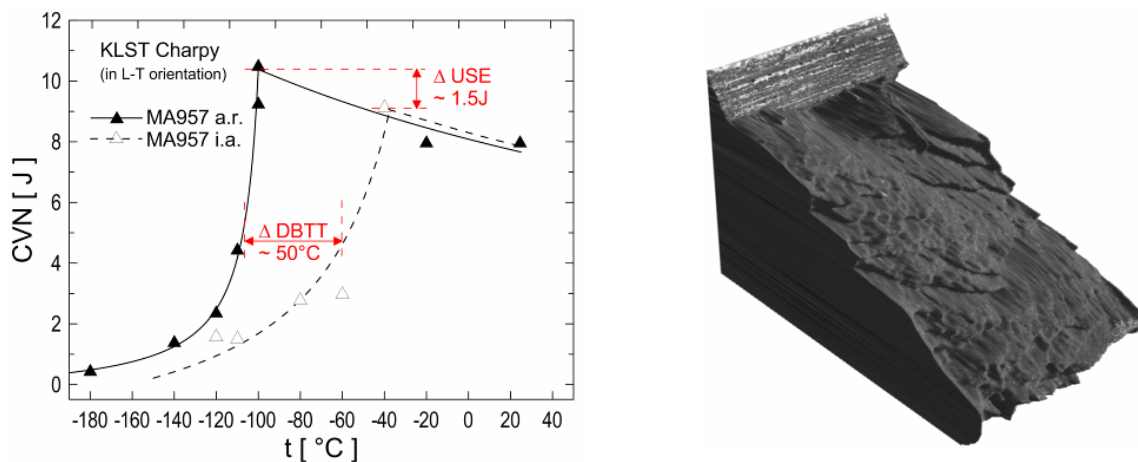

Fig. 2. Temperature dependence of the impact energy of the ODM 401 steel (left) and the 3D reconstruction of fracture surface of the steel in as-extruded state tested near DBTT at -120°C (right).

References:

- [1] J.J. Fischer, U.S. Patent 4,075,010, issued 21 February 1978.
- [2] H. Hadraba, B. Kazimierzak, L. Stratil, I. Dlouhy: Microstructure and Impact Properties of Ferritic ODS ODM401 (14%Cr-ODS of MA957 type). Journal of Nuclear Materials doi:10.1016/j.jnucmat.2011.01.066.

Fatigue of ODS steels at room and high temperatures

*T. Kruml, I. Kuběna, J. Polák
Institute of Physics of Materials AS CR, v.v.i.*

In collaboration with:

B. Fournier, Association EURATOM-CEA Saclay, France

N. Baluc, Association EURATOM-EPFL Lausanne, Switzerland

Low cycle fatigue behaviour of three steels with ultrafine grains and strengthened by fine oxide dispersion is studied at RT, 650°C and 750°C. It is shown that 14Cr ferritic steel produced at the EPFL has the highest strength but shorter fatigue life.

Three different steels strengthened by oxide dispersion were investigated:

- ODS Eurofer, tempered ferritic-martensitic steel;
- ODS ferritic steel produced at the CEA in 2008, (ferritic CEA);
- ODS ferritic steel produced at the EPFL in 2008 (ferritic EPFL);

Their cyclic properties are compared, when possible, with the RAFM Eurofer 97 steel without oxide dispersion.

All three ODS steels were prepared by the powder metallurgy route. The amount of Y_2O_3 particles was the same for all ODS steels, equal to 0.3 wt.%. The three ODS steels were prepared using the powder metallurgy route. The first steps, identical for the three materials, included the mechanical alloying of materials powder with oxide particles and consolidation of the powders by hot isostatic pressing. The subsequent treatment of the ODS steels is summarized in Table 1.

material	ODS Eurofer	ODS ferritic 14Cr CEA steel	ODS ferritic 14Cr EPFL steel
preparation	hot rolling into plates austenitization (1100 °C) air-cooling, tempering	hot extrusion into bars annealing (1050 °C) air-cooling	annealing (1000 °C) air-cooling
resulting microstructure	tempered ferritic-martensitic	ferritic, elongated grains, 0.49 μm in transverse diameter	ferritic, bimodal grain size distribution, diameter 0.34 μm + 3 μm

Table 1. Thermo-mechanical treatment of the ODS steels

The yield stress $\sigma_{0.2}$ at 0.2% of plastic strain was measured during the first half loop of a cyclic test. The measured values are summarized in Table 3.

$\sigma_{0.2}$ [MPa]	RT	650°C	750°C
ODS Eurofer	1020	380	190
ODS ferritic CEA	960	440	
ODS ferritic EPFL	1070	480	300

Table 2. Yield stresses at three testing temperatures.

The diameter of the miniaturised cylindrical specimen was 2 mm with gauge length of 7.6 mm and a special extensometer was used to measure strain. Ceramic rods ensured the contact measurement of strain at high temperatures. MTS 810 servohydraulic machine was used for symmetrical tension-compression cycling with constant strain amplitude ($R_\epsilon = -1$) and

constant strain rate of $2 \cdot 10^{-4} \text{ s}^{-1}$. Temperature was measured and controlled by three thermocouples placed in grips and close to the specimen.

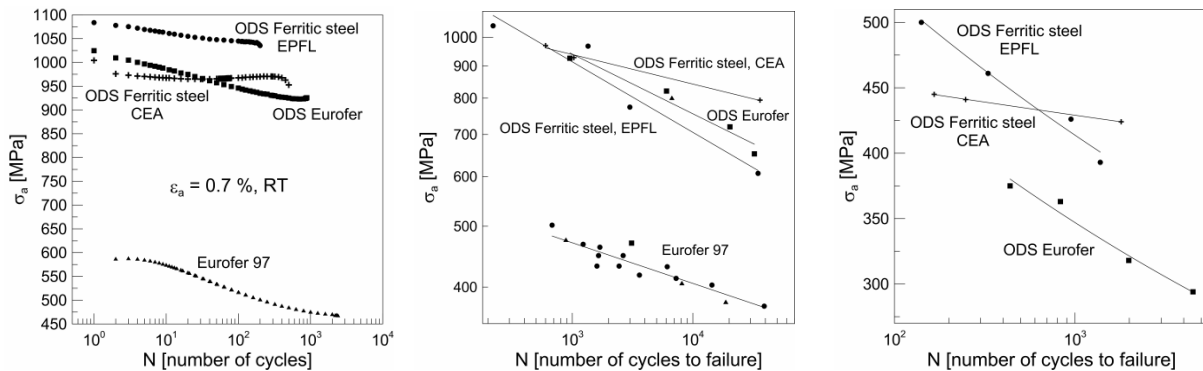

Fig. 1. Cyclic hardening/softening curve (a), S-N curves at RT (b) and 650°C (c).

The comparison of the evolution of stress amplitude σ_a with number of cycles at RT for the four steels is shown for $\epsilon_a = 0.7\%$ in Fig. 1a. The effect of the presence of the oxide dispersion is very apparent. The stress level is almost doubled for Eurofer steel with oxide particles in comparison with the Eurofer 97 variant. S-N curves at RT and 650°C are plotted in Fig. 1b and 1c. Stress amplitude at the half life is used. The increase of the fatigue life due to oxide dispersion is evident. The ODS ferritic CEA steel shows the longest lifetime at both temperatures at low loading levels. In the contrary, the lifetime of the ferritic EPFL steel which possesses the highest strength is reduced due to the behaviour of large grains. The rough surface relief is developed in largest grains in the EPFL steel (Fig. 2 a) while no such surface roughening due to the fatigue loading is observed in the CEA steel variant. The surface relief facilitates the fatigue crack nucleation and early growth and is thus the reason for substantial fatigue life reduction of the EPFL steel.

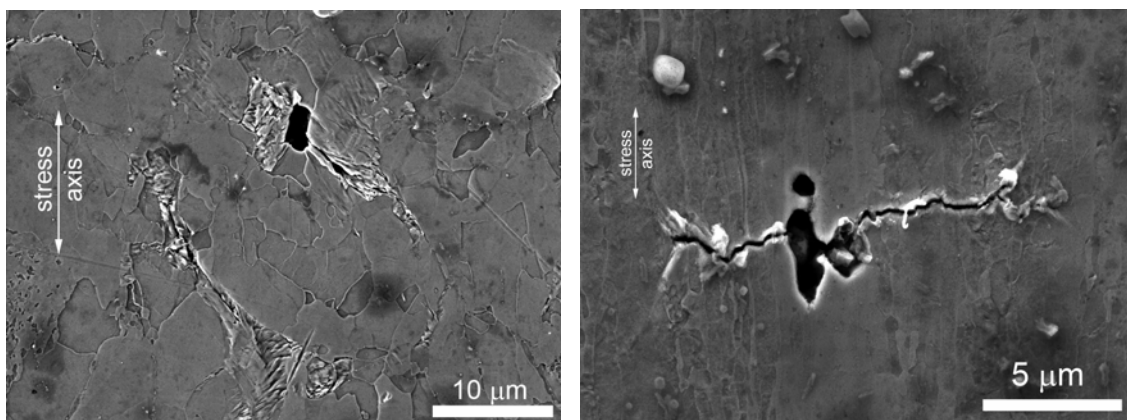

Fig. 2. Surface relief formed due to the cyclic loading in the EPFL ferritic steel (a) and fatigue crack nucleation in pores in the CEA steel (b).

References:

- [1] I. Kuběna, T. Kruml, B. Fournier, J. Polák, Low Cycle Fatigue Behaviour of ODS Steels for Nuclear Application, *Key Eng Materials* 465 (2011), 556
- [2] I. Kuběna, et al., Fatigue behaviour of ODS ferritic-martensitic Eurofer steel, *Procedia Engineering* 2 (2010) 717

5. Training and career development

Collective training of young engineers and scientists

I. Ďuran, A. Křivská, D. Šesták, J. Zajac, J. Stöckel, V. Weinzettl, P. Bílková, J. Rataj

In collaboration with:

J.-M. Noterdaeme, Association EURATOM IPP Garching, Germany

W. Biel, Association EURATOM- FZJ Julich, Germany

IPP.CR participated in two European Fusion Training Scheme (EFTS) projects namely the European Network for Training Ion Cyclotron Engineers (EnTicE) and Engineering of Optical Diagnostics for ITER (EODI). Two young engineers, Alena Křivská for EnTicE and David Šesták for EODI, were hired by IPP Prague for 3 a 2 years periods respectively. Training was conducted in close collaboration with other Associations participating in the projects and also with ITER IT. Training of both trainees was successfully accomplished and they both remain in fusion also after termination of their EFTS contracts. David Šesták obtained permanent contract in IPP Prague and he is strongly involved in COMPASS related engineering activities. Alena Křivská continues her involvement in the field of numerical simulation of ICRH antenna using TOPICA code presently in ENEA Association in Italy under one year long temporal contract.

EnTicE proposal was prepared by a consortium of eight institutions, namely IPP Garching Germany, UKAEA Culham United Kingdom, CEA Cadarache France, ERM-KMS Brusel Belgium, Politecnico di Torino Italy, University of Turin Italy, Spinner GmbH Germany, and IPP Prague Czech Republic. Jean-Marie Noterdaeme from IPP Garching was appointed to be the coordinator of the project. The aim of the EnTicE training program was to develop the engineering capabilities required to design, procure, operate and maintain the ITER Ion Cyclotron Resonance Frequency (ICRF) antenna, as well as to contribute to the fast track programme by enhancing the attractiveness and readiness of ICRF to provide a reliable heating system.

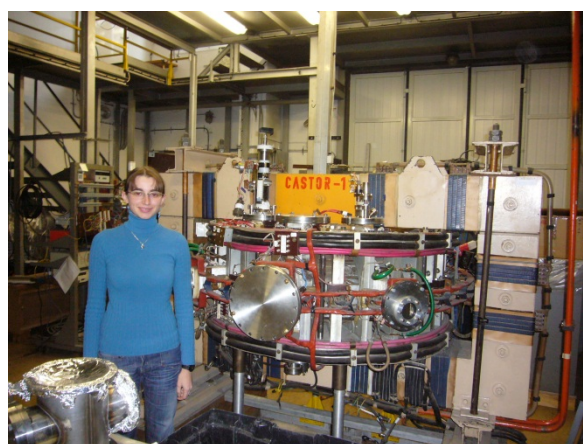

Fig. 1. Left panel - EnTicE trainees and their supervisors during EnTicE meeting in IPP Prague, Czech Republic 11 April 2008. Right panel – Alena Křivská during her training in basic aspects of tokamak technology and operation at CASTOR tokamak in IPP Prague.

Within the frame of **EnTicE**, IPP Prague concluded a 3 years long employment contract with a young engineer Alena Křivská. During her training programme, she spend its introductory part at the Institute of Plasma Physics AS CR in Prague where she got familiar with basic aspects of tokamak physics and some particular issues in fusion technology related to ICRH [1]. Further, she spent fifteen months long secondment at IPP Garching, where she learnt how ICRH technology is applied in tokamak environment and she performed simulations of AUG ICRH antenna with TOPICA and HFSS code [2,3]. In February 2009, she spend three weeks at Politecnico di Torino in Torino, where she strengthened her knowledge in using TOPICA code.

In April 2009 Ms A Křivská worked one month at Spinner company, where she simulated high-power components with CST Microwave studio. In June 2009, she started her ten months long secondment at UKAEA Culham, UK where powerful ICRF heating system is installed on JET tokamak, having many features similar to the envisaged ITER ICRF system. She participated in RF heating experiments on JET and she simulated and proposed optimization of four-port junction design of ITER antenna with CST Microwave studio. The training of Alena Křivská was successfully concluded in March 2010. Presently, she continues her work in the field of numerical simulation of ICRH antenna using TOPICA code in ENEA Association, Italy under one year long temporal contract.

The second proposal with IPP.CR involvement was entitled Engineering of Optical Diagnostics for ITER (**EODI**). This project was undertaken by seven institutions, namely: IPP Julich Germany, FOM Rijnhuizen Netherlands, UKAEA Culham United Kingdom, CEA Cadarache France, IPP Garching Germany, RISØ Denmark, and IPP Prague Czech Republic. Wolfgang Biel from IPP Julich was selected to act as the coordinator of the project. The aim of the **EODI** was to train eight new engineers on technological issues related to the ITER optical diagnostics particularly Charge Exchange Recombination Spectroscopy (CXRS), Infrared (IR), Thomson scattering LIDAR, X-ray, and Fast ion Collective Thomson Scattering systems.

Within the frame of **EODI**, IPP Prague concluded a 2 years long employment contract with a young engineer David Šesták. During his training program, he joined several design activities associated with the project of reinstallation of COMPASS tokamak in IPP Prague. At the initial stage, the main aim was to get David Šesták acquainted with basics of tokamak construction and to enhance his proficiency in CATIA V5 via involvement in several practical tasks associated mainly with design of new optical diagnostics for COMPASS. Following that, David Šesták worked directly for ITER IT for 3 months under supervision of Chris Walker. He focused on design study of possible support structures located in ITER interspace. Main emphasis was on Equatorial port plug 10 where LIDAR system should be settled. The main purpose of this support structure (frame) is to hold all diagnostic equipment in the area between port flange and concrete building. This frame should be robust structure which can survive in the environment of interspace (high radiation during campaign, vibrations, magnetic field fluxes, different temperatures between baking and operation, etc.). He finished the design study which is being evaluated by ITER team. In the second half of his training period, David Šesták returned back to various COMPASS engineering issues with the main emphasis on COMPASS optical diagnostic systems i.e. design of Thomson scattering system and multispectral diagnostic port-plug [4] containing diagnostic elements to measure visible plasma radiation from 400 nm to 800 nm, soft X-rays, and also a complex set of bolometer arrays. The training of David Šesták was successfully concluded in February 2010. He obtained permanent follow up contract in IPP Prague and he is presently strongly involved in COMPASS related engineering activities.

References:

- [1] J. Zajac et al., *Fusion Engineering and Design* 84 (2009) 2020-2024.
- [2] I. Zammuto, et al., *Fusion Engineering and Design* 84 (2009) 2031-2036.
- [3] V. Bobkov et al., *Nucl. Fusion* 50 (2010) 035004 (11pp).
- [4] D. Šesták et al., *Fusion Engineering and Design* 84 (2009) 1755-1758.

Practical Training on tokamak operation

*J Stockel, R Dejarnac, J Havlíček, J Horáček, M Hron, D Naydenková,
R Pánek, V Weinzettl, J Zajac*

In collaboration with:

G. Veres, M. Berta, Association EURATOM-HAS, Hungary

The 8th Summer Training Course (SUMTRAIC 2010) was organized on the COMPASS tokamak in collaboration with the Association EURATOM/HAS in the period 22.8. - 3.9.2010. Before practical training, several introductory lectures have been presented. The Course was attended by 15 students from nine countries. Students were divided to five experimental groups supervised by local and Hungarian supervisors. Four days were devoted to experiments on the COMPASS tokamak, the remaining time was spent by data processing and preparation of presentation at the closing workshop.

The summer school SUMTRAIC 2010 is focused to teach participants all important aspects of experimental work on tokamaks, i.e. planning of experiment, performing experiment, processing of experimental data, discussion of achieved results within a experimental group, preparing of the presentation and present results at the closing workshop.

The SUMTRAIC is organized as follows: First day of the school is devoted to introductory lectures explaining basic features of the COMPASS tokamak (infrastructure, available diagnostics, data acquisition system, software for data processing,) followed by a tour around the tokamak. Then, the participants are divided into 4 experimental groups. Each group is supervised by two senior scientists.

Experimental groups:

1. Magnetic diagnostics (Loop voltage, plasma current, plasma position,
2. Optical diagnostics (visible spectroscopy, evolution of selected spectral lines, fast camera. ...)
3. Microwave diagnostics (interferometer, ECR radiation)
4. Probe diagnostics (measurements of I-V characteristics of divertor probe array, fluctuation measurements with the reciprocating probe)

Majority of experiments will be performed on the COMPASS tokamak at IPP Prague in seven half – day experimental campaigns. One day is reserved to performing experiment on the GOLEM tokamak at the Czech technical University in Prague. The remaining time is reserved to processing of experimental data and discussion of achieved results within the experimental group and with supervisors. Finally, each experimental group prepares a presentation on the achieved results. The closing workshop is organized the last day of the school, where representatives of each experimental group present the results. The best presentation is honored.

Collaboration with French engineering school ENSAM

R. Dejarnac

In collaboration with:

A. Barbedette-Green, A. Stewart, Ecole Nationale Supérieure des Arts et Métiers, France

In the frame of a collaboration with the Ecole Nationale Supérieure des Arts et Métiers (ENSAM), a French engineering school, every year since 2009 we host at IPP Prague a couple of students for their 2nd year internship. Their main work is related to the conception of pieces/diagnostics for the COMPASS tokamak using the CATIA software. In 2010 we hosted two students for a period of 6 months each from the 17th of June to the 17th of December. Their work consisted in making 3D designs and providing technical drawings of several part of the tokamak and its associated diagnostics. A more detailed description of their tasks is presented in the text. Both of them also classified several hundreds of old technical drawings from the time when COMPASS was in Culham, UK.

One student worked on the design of a new probe to study plasma deposition inside a gap between tiles. This probe will be use for dedicated experiments and had to be designed from the scratch. Measurements will be compared to particle-in-cell calculations as it was previously done [1]. This time, the experiments are planned to be in a larger and more

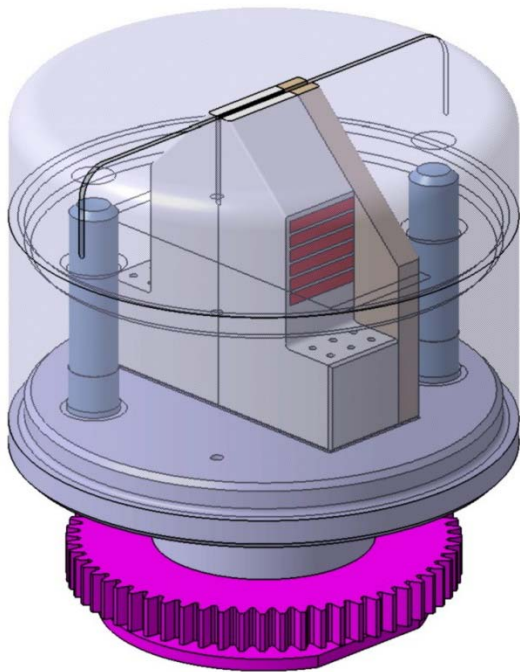

Fig. 1. 3D view of a probe dedicated to plasma deposition study into a gap between tiles

is presented on Fig. 2. For the reader to have an idea of the size, this piece has dimensions $\sim 200 \times 60 \times 30$ cm. A work on the COMPASS plasma rotation diagnostic was also achieved with the design of the telescope that will collect the light from the plasma and its beam path (Fig. 3) and its supporting structure (Fig. 4) with associated mirrors and prisms.

powerful tokamak, therefore the probe should satisfy a list of precise specifications. The student had to interact with the physicist who had the idea of the probe but no technical knowledge (design, material specifications, machining techniques, etc...) and tokamak engineers who gave technical limitations. This was a full time project and his skills allow the success of this project. The final 3D drawing of the probe is presented on Fig. 1. The size of the object is couple of cm in diameter and in height.

The second student worked on several projects at IPP Prague. All were already running at that time and all pieces designed are related to the COMPASS tokamak and its associated diagnostics. One of them was to draw in 3D an already existing piece of COMPASS: the supporting structure of the tokamak itself that prevents the magnetic field coils from shaking and also keep the whole tokamak together. This ring segment drawing

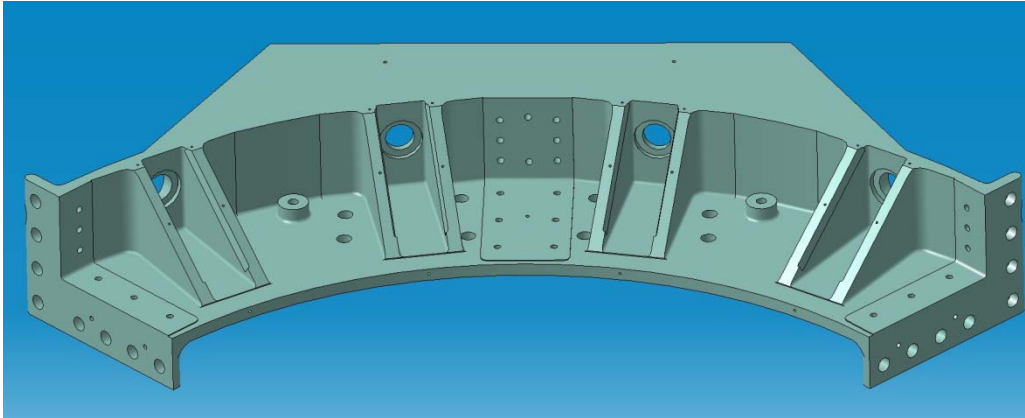

Fig. 2. 3D view of a section of the COMPASS supporting structure.

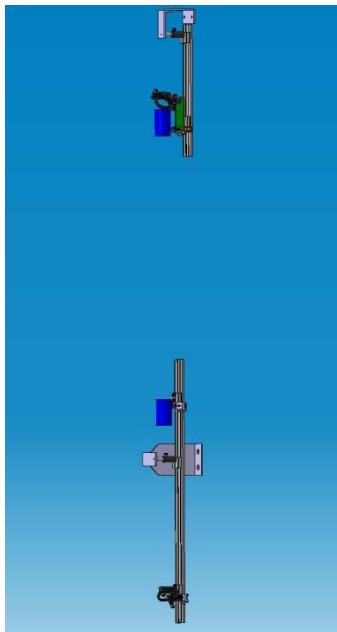

Fig. 3. 3D view of the telescope for COMPASS plasma rotation diagnostic

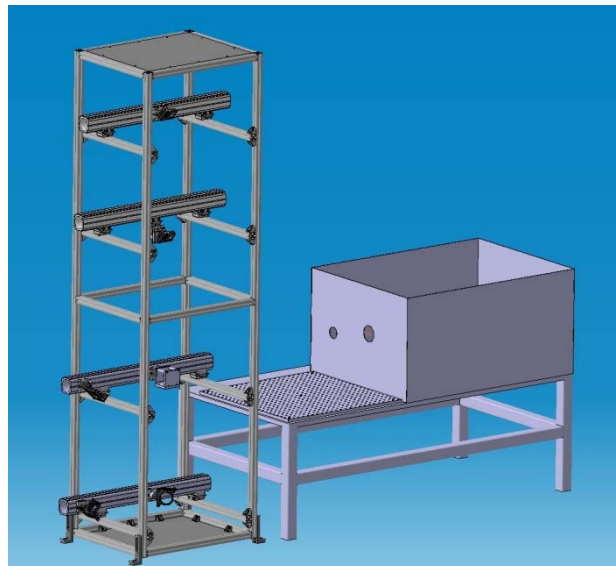

Fig.4. 3D view of the supporting structure for the COMPASS telescope that will be used for plasma rotation measurements.

Concerning the dimensions, the telescope has a height of ~ 2 m and the supporting structure is $\sim 210 \times 60 \times 40$ cm. Moreover, a diaphragm for the laser used in the Thomson Scattering diagnostic was also designed. The aim of this diaphragm is to stop parasitic reflections that can occur in the laser path and thus to reduce the noise. All the designs were made using the CATIA® software. Except the ring segment (already existing) and the diaphragm, that was already built in 2010, all the pieces described here and designed by the ENSAM students are under construction to be implemented on COMPASS in 2011.

Finally, the 2 students did not do only computer assisted conception but classified several hundreds of COMPASS technical drawings we inherited from the time when the tokamak was in Culham. This classified database will be the basis of future collaboration with ENSAM students for our aim to have the complete COMPASS tokamak and its associated diagnostics drawn in 3D electronic files.

References:

[1] R. Dejanac et al., J. of Nucl. Mater. **382** (2008) 31-34.

Collaboration with Czech Universities and FUSENET

J. Mlynář, J. Stöckel, I. Ďuran, R. Pánek, F. Žáček

In collaboration with:

The FUSENET partners coordinated by TU/e, Eindhoven, The Netherlands

In 2010 IPP Prague continued in collaboration with Universities, including in particular Faculty of Nuclear Sciences and Physical Engineering (FNSPE) of the Czech Technical University in Prague, and Faculty of Mathematics and Physics (FMP) of the Charles University, both members of the Association EURATOM/IPP.CR. In total, a record number of 19 undergraduate and 15 postgraduate students participated in research at tokamak COMPASS. Our experts also organised three courses in the summer term (Introduction to fusion, Technology of fusion facilities, Practica) and two in the winter term (Tokamak physics, Seminars) and contributed with lectures to several other courses (including Technology of thermonuclear fusion and Plasma diagnostics). In total, approx.. 300 hours were taught by scientists of the tokamak department, IPP Prague in 2010.

In February, IPP organised with FNSPE the second winter course on fusion. Five bachelor theses were finalised at COMPASS and successfully passed the state examinations. One doctoral thesis sponsored by the Faculty of Mathematics and Physics, Charles University (FMP) was successfully completed at the COMPASS tokamak [1]. Due to conflict with other FMP programmes, the foreseen course for doctoral studies did not take place this year. Instead we devoted the time for collaboration on application for Erasmus Mundus doctoral programme FUSION-D and renewal of the master's fusion programme FUSION-EP with prof G van Oost (Univeristy Ghent). The latter, to which IPP.CR and FNSPE are Associate partners, was later accepted.

Record number of students led to increased activities in teaching, in particular in the Tokamak physics course, Seminars and Practica. Seven fusion related seminars were organized by the Tokamak department, including seminar on the European research infrastructure ELI (sited in the Czech republic), on Plasma modeling by Prof. P Kulhánek from the Czech Technical University and on Opportunities in EU education by Prof G van Oost (Ghent University) and a colloquium in the large lecture hall of the Technical University by Dr Pavel Sunka, former IPP director and one of the doyens of the Czech fusion research. Besides, a course on Plasma physics for the Department of theoretical physics of the Faculty of mathematics and physics, Charles university was considerably revamped and read weekly.

FUSENET activities in Czech republic were continued at IPP including the mid-term reporting period in April. IPP Prague is involved in particular in Work Package 5 (coordination of Summer Schools). In 2010, the SUMTRAIC summer school (see separate report) received a financial support from FUSENET. Besides, in 2010 the IPP contribution to FUSENET even increased by 0.25 ppm due to our participation in WP7 Review Board which evaluated applications for support of practica.

References:

- [1] Cahyna P.: Diffusion of particles from tokamak by stochastization of magnetic field lines. *Doctoral thesis*. MFF UK (Faculty of Mathematics and Physics, Charles University Prague, 2010)

Undergraduate and postgraduate studies in Fusion Science and Technology

J. Mlynář, V. Svoboda, D. Břeň, M. Tichý

In collaboration with:

The FUSENET partners coordinated by TU/e, Eindhoven, The Netherlands

Prof. Rainer Hippler, EMA University, Greifswald

Billy Huang, CCFE, UK

Exchange of experience in teaching and in improving the effectiveness of teaching continues. At FNSPE (Czech Technical Univ.), the curriculum "Physics and Technology of Thermonuclear Fusion" successfully continued with approx. 20 students (total over 3 years) and for the first year included practica on operation of the educational tokamak GOLEM. The operation includes possibility of remote participation including full remote control of the facility.

For example, the tokamak discharges were run remotely by fusion students from their winter school. On 14th January 2010, the first overseas remote operation was run from Costa Rica, in March 2010, the first complete remote practica were run from Budapest for 4 Hungarian students. The remote operation on GOLEM was also demonstrated at the EPS conference [1] and the SOFT conference [2]. At the EPS its significance for training of students was also detailed in the FUSENET session. Later in the year, the GOLEM tokamak in collaboration with the HAS association won significant financial support in the Work Package 7 call by FUSENET. The grant will allow for increased accessibility and availability of the GOLEM tokamak to students. Following successful contribution of the GOLEM tokamak to the SUMTRAIC summer training course, the machine ran on 1st December 2010 so called "tokamak global experiment" [3] with a very enthusiastic remote participation from several countries .

FNSPE (as well as IPP Prague) also participated in the call for renewal of the Erasmus Fusion EP (European joint Masters programme) which was later accepted.

FMP (Charles Univ.) continued in particular in doctoral education. Prof. Milan Tichý participated as a lecturer in the Summer school on Plasma Physics entitled "Plasma Applications in Material Science" that has been organized by Prof. Rainer Hippler of the Ernst-Moritz University in Greifswald, FRG in the period 16.8.2010-27.8.2010. This summer school aimed at promoting the basics of plasma physics in a compact training course. The Summer school was financed through the ERASMUS-IP project, principal investigator and organiser was again Prof. Rainer Hippler, EMA University, Greifswald, FRG. In this summer school participated about 27 students from FRG, Poland, Sweden and Czech Republic [4].

References:

- [1] Svoboda V., Pokol G., Refy D., Stockel J., and Vondrasek G.: Former Tokamak CASTOR becomes remotely controllable GOLEM at the Czech Technical University in Prague . *Proceedings of the 37th EPS Conference on Plasma Physics 2010, Dublin, Ireland* P2.111
- [2] Svoboda V., Huang B., Mlynář J., Pokol G.I., Stöckel J., Vondrášek G.: Multi-mode remote participation on the GOLEM tokamak. *Proc. Of 26th Symposium on Fusion Technology 2010, Porto, Portugal, submitted to Fusion Engineering and Design*
- [3] ITER Newline 156 (2010) , <http://www.iter.org/newsline/156/512>
- [4] <http://www.physik.uni-greifswald.de/pams2010/>

6. Other activities contributing to the EURATOM fusion programme

Outreach and Public Information Activities

Milan Řípa, Jan Mlynář

As predicted, the PI work was less demanding than in 2009 but still very rewarding. Pro-active PI practices were developed, hands-on experiments introduced into public lectures, and we have given priority to teachers, high-school and University lectures and media. In total, about 30 newspaper articles on fusion were published, and about 18 lectures given. 28 excursions visited COMPASS tokamak, not taking into account the two "open days" when the total number of visitors approached 300. The educational GOLEM tokamak at FNSPE, as a brand new highlight, attracted about 20 groups of visitors, in particular from high schools.



Contents of the web page of the COMPASS tokamak [1] considerably improved in both Czech and English versions. At present, it shows up-to-date information on the facility, its publication activities, profiles of scientist, latest news and several downloadable public information articles on fusion (separately in Czech and in English). Besides, a brand new graphics solution of the webpage has been developed and launched on our Association webpage, see [2]. Also the GOLEM tokamak has got a revamped website [3]. Besides, the GOLEM tokamak ran a very successful "Tokamak Global Experiment" [4] on the 1st December 2010 which was covered e.g. by CCFE news and by ITER Newslines [5].

In 2010, our Institute was also a key partner in the project "Energy around us". The project aims at foundation of a new permanent exhibition on future energy sources, with fusion as one of the major highlight.

Our PI responsible participated in the "SciCom" (Science Communication) conference that was hosted by the University of West Bohemia in Pilsen on 26th November, and also in the conference on "NPP Temelin completion – an opportunity for the Czech industry" in Brono on 15th September 2010. This allowed us to share information on fusion research and developments with the two important target groups. Two major public lectures in the main buildings of the Academy of Sciences were given within the Week of Science and Technology (see photo). Our Association provided the Czech version of fusion brochures to the Fusion Expo in Bratislava, Slovakia in January 2011 and the Institute of Plasma Physics, Prague will be listed as a partner of this exposition.



For a non-exhaustive list of publications and public lectures of our Association in 2010 see below.

List of radio broadcasts:

Radek Pánek: Interview with redactor Šafaříková for Nula-jednička programme, September 27 2010

Radek Pánek: Interview with redactor Šafaříková for Meteor programme, December 18 2010

List of published PI articles: (in Czech, if not stated otherwise)

Milan Řípa: The best coconuts will go into tokamak, Lidové noviny, January 5 2010, p. 31

Milan Řípa: How ITER is constructing and paying, Technický týdeník, **58**(2010), 2, p. 16

Milan Řípa: From Gamble to Science, Technický týdeník, **58**(2010), 3, p. 16

Milan Řípa: Nuclear collaboration: ITER, CERN and...Airbus, Technický týdeník, **58**(2010), 4, p. 15

Milan Řípa: Nuclear Train in tokamak?, Technický týdeník, **58**(2010), 5, p. 13

Milan Řípa: Sun has suggested the fusion of light atom nuclei as the source of inexhaustible and the cleanest energy, All for Power, **4**(2010), 1, pp. 72 to 78

Milan Řípa: Termonuclear levitation, Technický týdeník, **58**(2010), 6, p. 4

Milan Řípa: Central solenoid in ITER tokamak, Technický týdeník, **58**(2010), 8, p. 10

Milan Řípa: „All the world has heard this TASS message..“ Technický týdeník, **58**(2010), 11, p. 10

Milan Řípa: „ITER as alive“, 3pól (třípól), **3** (2010) elektronick magazine, <http://www.tretipol.cz/index.asp?clanek&show&801>, June 2010, pp. 18 to 19

Milan Řípa: Some problems during tritium manufacturing for ITER tokamak, Technický týdeník, **58**(2010), 11, p. 20

Milan Řípa: Broader Approach – Europe and Japan in thermonuclear fusion together, Technický týdeník, **58**(2010), 15, p. 5

Milan Řípa: Renewable resources and controlled thermonuclear fusion, **60** (2010), 7, pp 421 to 424

Milan Řípa: Big Z axiom, Technický týdeník, **58**(2010), 20, p. 11

Milan Řípa: Excuse me, Mr Alane Edgar!, Technický týdeník, **58**(2010), 21, p. 29

Milan Řípa: KTM – the first tokamak in Middle Asia, Technický týdeník, **58**(2010), 22, p. 31

Milan Řípa: Unexpected child of Penthouse father, EKONOM, **54**(2010), 44, pp. 60 to 61

Milan Řípa: Ilja Muromec by viva aqua poured, Technický týdeník, **58**(2010), 24, p. 28

Jan Mlynář: Principles of the thermonuclear reactor ITER, Rozhledy matematicko-fyzikální, 85 4(2010) p. 19

Milan Řípa: A bit of the Sun fired on the Earth, Vision, 2010, 4, pp. 34 to 35

List of Lectures: 15

Milan Řípa: „The best of Fusion or else ITER is a way...“, lecture for Gymnasium Turnov, March 26 2010, 9:00 h.

Milan Řípa: „The best of Fusion or else ITER is a way...“, lecture for primary school Strakonice, April 9 2010

Milan Řípa: „Energy security“, lecture for Technical School Zlín, April 15 2010, 10:00 h.

Milan Řípa: „The best of Fusion or else ITER is a way...“, lecture for Technical School Zlín, 15th April 2010, 11:30 h.

Milan Řípa: „The best of Fusion or else ITER is a way...“, lecture for Gymnasium Žďár/Sázavou, April 29 2010, 9:00 h.

Milan Řípa: „The best of Fusion or else ITER is a way...“, lecture for Gymnasium Eliška Krásnohorská, Praha 4, May 11 2010, 8:00 h.

Milan Řípa: „The best of Fusion or else ITER is a way...“, lecture for Gymnasium Joachim Barrand, Beroun, May 13 2010, 8:45 h

- Milan Řípa:** „European Collaboration in fusion popularization“, lecture for Optical diagnostics departement, IPP ASCR, Turnov, June 10 2010, 9:00 h.
- Milan Řípa:** „Plasma helps people.“ lecture for Gymnasium Mladá Boleslav Palackého, Mladá Boleslav, June 11 2010, 8:00 h
- Milan Řípa:** „The best of Fusion or else ITER is a way...“, lecture for Gymnasium Mladá Boleslav Palackého, Mladá Boleslav, June 11 2010
- Milan Řípa:** „Plasma helps to people.“ lecture for Gymnasium Joachim Barrand, Beroun, May 13 2010, 10:00 h
- Jan Stöckel:** „Thermonuclear fusion“ lecture for the University of West Bohemia, May 13 2010
- Milan Řípa:** „Introductory lecture.“ lecture for Gymnasium Prosek , IPP Prague, May 17 2010, 12:30 h
- Milan Řípa:** „European Collaboration in fusion popularization“, lecture – seminar in the frame of course „Physics and technology of thermonuclear fusion“, IPP Prague, May 18
- Jan Mlynář:** “Nuclear energy – a powerful option”, high school in Žďár nad Sázavou, September 9th
- Milan Řípa:** Renewable resources and controlled thermonuclear fusion, public lecture in the frame of The week of science and technology, AS CR, Praha Národní 3, Little Hall, 2nd November
- Jan Mlynář:** ITER, the world of science, technology and hope. Public lecture in the frame of The week of science and technology, AS CR, Praha Národní 3, Main Hall, 3rd November
- Milan Řípa:** „The best of fusion or ITER is the way...“, a lecture for high school, Týn nad Vltavou, 2nd December

List of Posters: 2

- Milan Řípa:** poster of IPP AS CR, v.v.i. 2010
- Milan Řípa:** poster of the Asociation EURATOM-IPP.CR 2010

References:

- [1] <http://www.ipp.cas.cz/Tokamak/>
- [2] <http://www.ipp.cas.cz/Tokamak/euratom/index.php/en/compass-general-information>
- [3] <http://golem.fjfi.cvut.cz/>
- [4] <http://www.tokamakglobal.com/>
- [5] Launch of the world’s first global tokamak experiment, ITER Newslite #156 (December 2010) <http://www.iter.org/newslite/156/512>

7. Coordination, in the context of a keep-in-touch activity, of the Member State's civil research activities on Inertial Fusion Energy

Dense plasma acceleration in LICPA guns

Jiří Ullschmied, Eduard Krouský, Miroslav Pfeifer, Jiří Skála, Roman Dudžák

In collaboration with:

J. Badziak, S. Borodziuk, A. Kasperczuk, T. Pisarczyk, T. Chodukowski, Association EURATOM-IPPLM, Warsaw, Poland

Yong-Joo Rhee, KAERI, Daejeon, Republic of Korea

Dense plasma acceleration in the LICPA (Laser Induced Cavity Pressure Acceleration) guns was investigated at the PALS facility in collaboration with Polish physicists from IPPLM, Warsaw in the last quarter of the year 2010. By using various complex laser LICPA targets with an entrance cavity and cylindrical or conical guiding channels we studied in detail the dependence of output plasma parameters on the target foil thickness, cavity size and channel lengths, material of the channel wall (Al, Au), and on the laser energy and wavelength. We made also comparative measurements with similar targets but without the entrance cavity. The experiments have shown that the LICPA technique leads to substantial increase of all the key parameters (energetic efficiency, plasma velocity, ion current density), by more than an order of magnitude in comparison with those found in free ablative plasma acceleration case.

The LICPA technique was developed on the base of successful experiments with the so-called reversed acceleration scheme (RAS) and Cavity Pressure Acceleration (CPA) technique proposed by Polish physicists from IPPLM, Warsaw, and validated at the PALS facility in 2009 [1,2]. The CPA method proved its usefulness at accelerating macroparticles (in fact dense plasma objects) to extremely high energies, with the acceleration efficiency far exceeding that achieved up to now by using standard ablative acceleration schemes. It takes advantage of the accumulated pressure of the hot plasma produced and in a tiny cavity by a focused high-power laser beam entering the cavity through a small hole. The next step was the design of a LICPA gun [3]. In the LICPA gun the plasma projectile is produced by laser irradiation of an ablator (CH₂ or CD₂ foil) placed in a cavity and accelerated by the pressure accumulated in it. A distinctive feature of the LICPA gun is a guiding channel, which plays a role similar to that of a barrel in a conventional cannon. In particular, it prevents pressure from escaping the cavity, The arrangement allows for acceleration of the projectile for a long time and, moreover, it makes it possible to collimate and compress the accelerated plasma [4].

Various LICPA guns of different geometry of the entrance cavity and different shapes (cylindrical or conical) of the guiding channel were used in the Polish-Czech collaborative experiments conducted at the PALS facility at the end of the year 2010. Their aim was to investigate in detail the acceleration process and compare the efficiency of plasma acceleration in LICPA guns with that achievable by means of the free ablative acceleration. A focused high power beam at the 1st and 3rd harmonic frequency of the PALS sub-nanosecond iodine laser (pulse duration ~300 ps) was used for irradiation of the targets, the laser energy being varied in the range 100 J – 500 J and 100 J – 350 J, respectively. For the focal spot radius of 40 μm (at the target cavity entrance plane) the focused laser intensity at the ablator target reached values in between 5×10^{14} – 2×10^{16} W/cm².

The laser targets were designed and fabricated at IPPLM in Warsaw. The scheme of experimental arrangement with LICPA guns is shown in Fig.1. The entrance cavity and guiding channel walls were made of gold. The ablator targets were thin CH₂ or CD₂ foils of different shape. A massive removable Al plate closed the end of the cylindrical or conical guiding channel. The volume of the crater produced in the Al plate by the accelerated plasma was exploited as a measure of the transported energy. Removing the Al plate made it possible to probe the output plasma and to measure its parameters. The plasma electron density and macroscopic velocity were measured by a three-frame laser interferometer/shadowgraph, and the ion fluxes by ion collectors. Fast x-ray and neutron detectors registered hard x-ray and neutron radiation of the hot plasma.

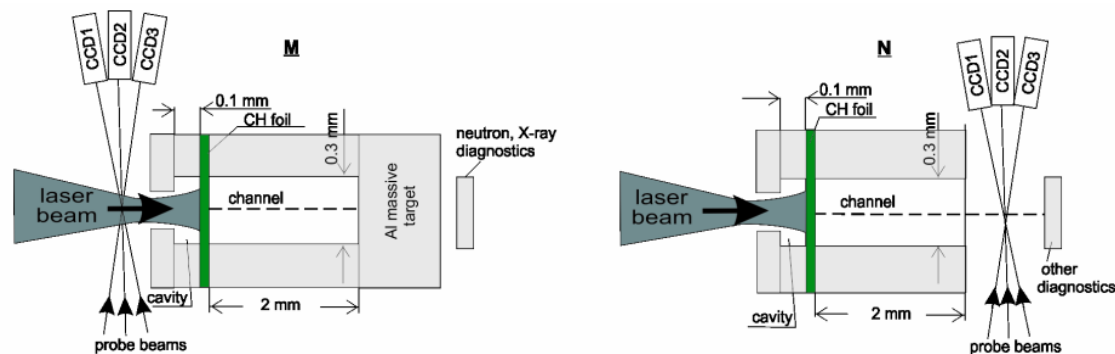

Fig. 1. Schematic of the LICPA experiments. M: Measurements of the front plasma and transported energy, N: Measurements of the output plasma parameters (by Jan Badziak, IPPLM Warsaw).

In order to compare the LICPA with the free ablative plasma acceleration each measurement was repeated with targets in which the entrance cavity in front of the ablator target was removed.

Processing of the collected numerous experimental data is still in progress, nevertheless a preliminary analysis of them already shows that the dense plasma velocity at the output of LICPA guns can be as high as 200 – 300 km/s, the ion current density at a distance of 30 cm from the LICPA gun mouth reaching up to ~ 5 A/cm², which is about 10 times higher than that measured in the free ablative acceleration case. The plasma produced by LICPA guns with CD₂ ablaters, designed for fusion-relevant applications, radiates neutrons already at laser intensities of 10^{15} W/cm², while no neutrons were observed in the other cases even at laser intensities exceeding 10^{16} W/cm².

In general, the experiments performed at PALS show that the energetic efficiency of dense plasma acceleration in the LICPA guns, both in the cylindrical and conical (fusion-relevant) configuration, is at least by an order of magnitude higher than that achievable when using the standard ablative acceleration scheme. These results are rather promising from the point of view of both technological and ICF applications of LICPA guns.

References:

- [1] S. Borodziuk, A. Kasperczuk, T. Pisarczyk, J. Ullschmied et al., *Appl. Phys. Lett.* 93 (2008) 101502
- [2] S. Borodziuk, A. Kasperczuk, T. Pisarczyk et al., *Appl. Phys. Letters* 95, 231501 (2009)
- [3] J. Badziak, S. Borodziuk, T. Pisarczyk et al., *Appl. Phys. Lett.* 96 (26), Art. No. 251502 (2010), doi: 10.1063/1.3457865
- [4] J. Badziak, T. Pisarczyk, T. Chodukowski et al., *J. Phys.: Conf. Ser.* 244 (2010) 022023, doi: 10.1088/1742-6596/244/2/022023

V

ADDITIONAL INFORMATION

Work for the European Joint Undertaking for ITER and development of Fusion for Energy (F4E)

Conceptual design development of Test Blanket Module's Pb-Li Ancillary System and Tritium Extraction Unit

O.Zlamal, L. Kosek, Centrum Výzkumu Řež, s.r.o.

In collaboration with:

P. Hajek, O. Frybort, Ústav jaderného výzkumu Řež, a.s., Řež, Czech Republic

L.V. Boccaccini, J.F. Salavy, O. Bede, P. Sardain, M. Utili, TBM-Consortium of Associates, Karlsruher Institut für Technologie, Karlsruhe, Germany

I. Ricapito, Y. Poitevin, Fusion for Energy, Barcelona, Spain

Ústav jaderného výzkumu Řež, a.s. (UJV Rez) and its subsidiaries, including Centrum Výzkumu Řež s.r.o. (CV Rez), are founding members of the TBM-Consortium of Associates (TBM-CA), where similar research bodies from Germany, Hungary, France, Italy and Spain are gathered in order to join forces and resources for development of ITER's Test Blanket Module (TBM). The first grant awarded to TBM-CA by Fusion For Energy (F4E) was F4E-2008-GRT-09 (PNS-TBM), focused on reaching of conceptual design and technology development of first TBM systems.

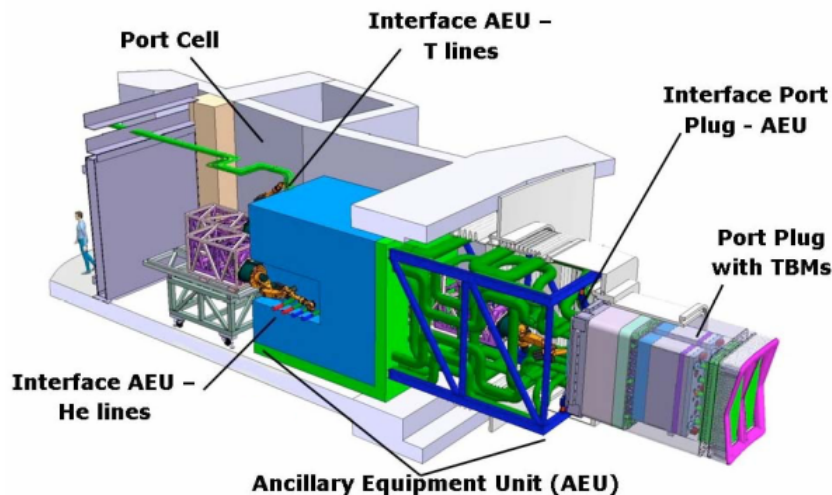

Fig. 1: Overview of Test Blanket Module and its supporting system in one of ITER Ports.

TBM-CA was established in late 2008, when six EURATOM Associates and Research Units formed consortium for development of European TBM programme under governance of F4E. At the beginning, France was represented by CEA, Spain by CIEMAT, Italy by ENEA, Germany by FZK, Hungary by RMKI and the Czech Republic by UJV. Due to reorganisation

of certain institutions within TBM-CA, UJV was replaced by its subsidiary CV Rez and FZK was replaced by KIT.

TBM-CA first grant, which was received from F4E, was F4E-2008-GRT-09 (PNS-TBM), with general objective to reach a level of design, technology development and management that follows:

- Validating most of the 2009-2010 milestones identified by the ITER STAC (establishing of TBM quality management system, delivering of TBMs system conceptual design, delivering of TBM Preliminary Safety Reports)
- Implementing the European TBMs project strategy and choices (classification of TBM systems with respect to French/European regulations, defining a common generic steel box for all examined concepts, issuing of documents for future needs with clear specification of their envisioned work plan, etc.)

Detailed description can be found in [1].

Latest European fusion research efforts, reflected in F4E-2008-GRT-09 (PNS-TBM), are aimed on development of two reference breeder concepts for DEMO reactor specifications, that will be tested in ITER in form of TBM: the Helium-Cooled Lithium-Lead (HCLL) concept which uses the Lithium-Lead as both breeder and neutron multiplier, and the Helium-Cooled Pebble-Bed (HCPB) concept which features lithium ceramic pebbles as breeder and beryllium pebbles as neutron multiplier. Both concepts are using the pressurized helium technology for heat extraction (8 MPa, inlet/outlet temperature 300/500°C) and a Reduced Activation Ferritic Martensitic (RAFM) steel as structural material, the EUROFER.

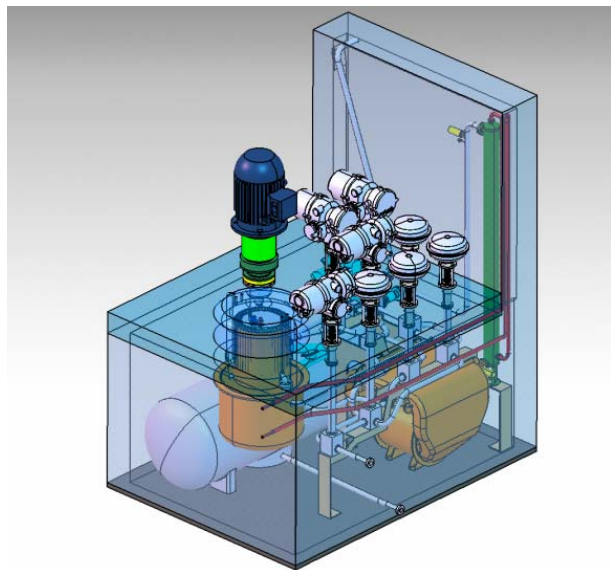

Fig. 2: CV Rez's conceptual design of PbLi AS with TEU and transparent shielding.

CV Rez was in frame of GRT-09 grant awarded with leadership of PbLi Loop Group, under HCLL TBM Design and Specifications Division (Division 2). PbLi Loop Group goals were to produce design of the PbLi Loop, to verify and qualify PbLi Loop design, to manufacture PbLi Loop and to install PbLi Loop in the ITER facility, as given in [2]. In particular, CV Rez was assigned with two tasks out of 32, which grant GRT-09 consist of:

- T05-2: Design of the Tritium Extractor Unit (TEU) for the HCLL Tritium Extraction System (TES);
- T08: Design of the Pb-Li Ancillary System (PbLi AS).

In course of 2010 the CV Rez in cooperation with UJV and Institute of Chemical Technology, Prague (ICT, also known as VŠCHT in Czech), under funding of the Ministry of Education, Youth and Sports (MEYS, also known as MŠMT in Czech), successfully developed CATIA conceptual design of both PbLi AS and TEU and subsequently produced all related documents:

- Preliminary engineering design and analyses,
- Integration in ITER plant,
- Interfaces and requirements to ITER,

- Measurement and instrumentation plan,
- Draft of operation manual,
- Maintenance plan,
- Chapters to Design Description Document open to be shared with other ITER parties,
- Status report on future needs,
- Proposal for technical work plan.

Summary of performed work from GRT-09 is provided in Final Report of the grant [3].

Successful cooperation among all industrial and research partners within TBM-CA and between TBM-CA and F4E lead to TBM-CA's interest and bidding for another F4E grant contracts within research area of European TBM development.

References:

- [1] Technical Specification: Design and development of the European Test Blanket Modules (TBM) Systems ("TBM08G1"), F4E, 2008
- [2] L.V. Boccaccini, J.F. Salavy: PROJECT MANAGEMENT – Organisation of work, PLS-2008.001, TBM Consortium of Associates, 2008
- [3] L.V. Boccaccini, J.F. Salavy: Final Contract Report by the TBM Consortium of Associates for Grant Agreement F4E-2008-GRT-009-01, Document-Ref.-No.:TBM-GAP-080091-RD-0001, TBM-CA, 2011.

In-pile and out-of-pile testing of Primary First Wall mock-ups

T.Klabik, O.Zlamal, V.Masarik, Centrum Výzkumu Řež, s.r.o.

In collaboration with:

B.Bellin, F. Zacchia, Fusion for Energy, Barcelona, Spain

Year 2010 was marked by extensive cooperation between Barcelona-based Fusion For Energy (F4E) and Centrum Výzkumu Řež, s.r.o. (CV Rez), which took over all fusion-related projects from NRI's Reactor Services Division. BESTH device, set in Beryllium Lab, finished out-of-pile thermal fatigue testing of Be armored mock-ups from various producers with outstanding results and CV Rez started negotiate life-time testing of EU fabricated mock-ups for F4E, which was commenced on February 2011. Programme of the in-pile testing of Be armoured mock-ups successfully finished its out-of-pile evaluation phase and proceeded to preparation of irradiation in LVR-15 research reactor.

After successful ending of out-of-pile thermal fatigue testing of Beryllium coated PFW (Primary First Wall) mock-ups, fabricated by 5 international producers, it was concluded that in all cases mock-ups were able to pass the qualification criteria evaluated on results of ultrasonic non-destructive tests (NDT). Ultrasonic NDT were required to be carried out before and after fatigue testing of each mock-up and served as main measure for identification of detachment of Beryllium tiles from mock-ups. Although some discontinuities were identified, overall consideration of testing conditions lead to recognition of flawless performance of certain mock-ups. Taking in account very strict test requirements (12 000 cycles with 0.625 MW/m² heat flux), reaching such results without any single and clear failure is considered as a success for both tested mock-ups and testing device.

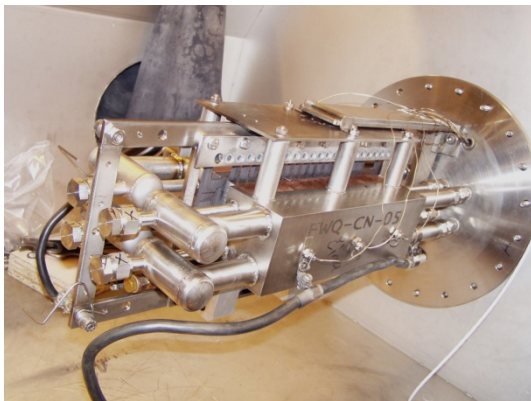

Fig. 1: Last thermal fatigue testing campaign in BESTH device with China-made and EU-made PFW mock-ups.

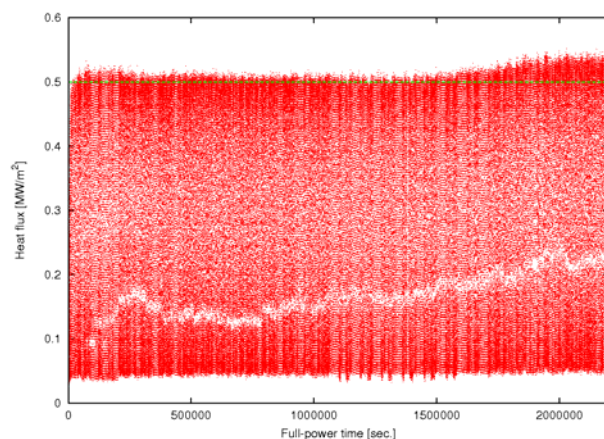

Fig. 2: Heat flux record during 5000 cycles long out-of-pile test of TW3 rig.

The BESTH device is a graphite panel-equipped heating furnace, where required heat flux is generated by resistance electric heating of graphite panel. Tested mock-ups are set parallel to panel, with Be-clad side facing panel, and cooled by independent cooling water circuit. More detailed description is given in [1].

After completion of thermal fatigue tests, lift-time test of EU mock-ups were proposed by F4E. Its goal is to determine number of cycles EU mock-up can withstand before

development of Beryllium detachment occurs. Life-time test was negotiated and already commenced, with first goal to reach 30 000 cycles.

Parallel to out-of-pile thermal fatigue tests and boosting from its successful realization, the in-pile testing task of PFW in TW3 irradiation rig is prepared. Its technical background is similar to BESTH device, with only one significant difference: tested mock-ups are not set in parallel but in series to the heating panel; detailed description of TW3 rig is provided in [2]. TW3 irradiation rig is planned to be inserted into the LVR-15 research reactor, but before out-of-pile screening tests needed to be carried out. Two out-of-pile tests were done by end of 2010, one 1000 cycles long, second 5000 cycles long – both served for verification and improvement of rig's design, as referred in [3]. The in-pile test is premeditated for Q2/2011.



Fig 3: Final design modifications on TW3 irradiation rig before last out-of-pile test; same design will be used for in-pile testing.

Technical specification of the TW3 rig test resembles requirements for BESTH device's tests: cyclic thermal fatigue of tested mock-ups with 0.5 MW/m^2 in length of 20 000 cycles. Aside from thermal requirements, 0.6 dpa neutron dose is envisioned to be accumulated during irradiation in LVR-15 research reactor.

Both BESTH device and TW3 rig are designed to test and verify durability of Hot Isostatic Pressing (HIP) joint between Beryllium tiles (serving as armour) and CuCrZr alloy heat sink on the tested mock-ups during high heat flux cycling, simulating normal operation conditions of ITER. Due to small dimensions of mock-ups, electric input in magnitude of only tens of kW is needed to generate heat flux in range of $0.5\text{-}0.6 \text{ MW/m}^2$.

Mock-ups irradiated in TW3 rig receive additional heat flux from nuclear heating of themselves and supporting steel construction, where approx. 2.5 W/g is generated by gamma radiation. Similar radiation heating is induced also in Beryllium, CuCrZr alloy and graphite, used as fabrication material for heating panel.

References:

- [1] T. Klabík, O. Zlámál, V. Masařík: Description of Thermal Fatigue Testing Equipment for Be Coated Primary First Wall Mock-ups, UJV – 13213, 2009
- [2] T. Klabík, O. Zlámál, P. Hájek, J. Zmítková: TW3-TVB-INPILE: In-pile thermal testing device for Primary First Wall Mock-ups with Be cladding - Part I: Preparation of the test rig, UJV – Z 2678, 2009
- [3] O. Zlámál, T. Klabík, P. Mühlbauer, B. Bellin: TW3-TVB-INPILE: In-pile thermal testing device for Primary First Wall Mock-ups with Be cladding - Part II: Out-of-pile 1000 cycles test run, UJV – Z 2817, 2010