



**Proceedings of the
8th International Students Conference
“Modern Analytical Chemistry”**

Prague, 24–25 September 2012

Edited by Karel Nesměrák

Charles University in Prague, Faculty of Science
Prague 2012



*Proceedings of the
8th International Students Conference
“Modern Analytical Chemistry”*



**Proceedings of the
8th International Students Conference
“Modern Analytical Chemistry”**

Prague, 24–25 September 2012

Edited by Karel Nesměrák

Charles University in Prague, Faculty of Science
Prague 2012

CATALOGUING-IN-PUBLICATION – NATIONAL LIBRARY OF THE CZECH REPUBLIC
KATALOGIZACE V KNIZE – NÁRODNÍ KNIHOVNA ČR

Modern Analytical Chemistry (2012 : Praha, Česko)
Proceedings of the 8th International Students Conference
“Modern Analytical Chemistry” : Prague, 24–25 September 2012 /
edited by Karel Nesměrák. – 1st ed. – Prague : Charles
University in Prague, Faculty of Science, 2012. – 104 s.
ISBN 978-80-7444-017-5

543

- analytical chemistry
- proceedings of conferences
- analytická chemie
- sborníky konferencí

543 – Analytical chemistry [10]

543 – Analytická chemie [10]

The Proceedings publication was supported by the research project
MSM0021620857 of the Ministry of Education of the Czech Republic.

The electronic version of the Proceedings is available at the conference webpage:
<http://www.natur.cuni.cz/isc-mac/>

© Charles University in Prague, Faculty of Science, 2012.

ISBN 978-80-7444-017-5

Preface

Dear friends and colleagues,

Welcome to the 8th International Students Conference “Modern Analytical Chemistry”. We are pleased that more than thirty young scientists from four countries attend the conference. We hope that the conference, like in previous years, will be interesting, challenging, and successful event. It will become a platform for the presentation of new scientific results and will show the further directions of research in the field of analytical chemistry. We are convinced that the conference offers many possibilities for improvement of the presentation skills, provides the floor for discussion and exchange of experiences and opinions, and helps to master the English language to all the participants.

The AP Czech, HPST, Quinta Analytica, and Shimadzu companies are cordially thanked, not only for their kind financial sponsorship, but for their continuous support and cooperation in many of our other activities.

We wish you success in the presentation of your contributions, vivid discussions with the audience and your colleagues, pleasant social encounters and nice stay in the city of Prague.

Prof. RNDr. Věra Pacáková, CSc.

RNDr. Karel Nesměrák, Ph.D.

Sponzors

The organizers of 8th International Students Conference “Modern Analytical Chemistry” gratefully acknowledges the generous sponsorship of following companies:



<http://www.apczech.cz/>



<http://www.hpst.cz/>



<http://www.quinta.cz/>



<http://www.shimadzu.cz/>

Programme

The conference is held at the Institute of Chemistry, Faculty of Science, Charles University in Prague (Hlavova 8, 128 43 Prague 2) in the main lecture hall (Brauner's Lecture Theatre). Oral presentations are twenty minutes including discussion and speakers are asked to download their Power Point presentation on the local computer in the lecture hall before the start of the session. The coffee breaks are held in the lecture hall.

Monday, September 24, 2012

- 8:30–9:00 **Registration of participants**
- 9:00–9:20 **Opening ceremony, welcoming address**
- Session 1** • chairperson: Michal Tatarkovič
- 9:20–9:40 Dziubakiewicz E.: *Influence of charge distribution on electrophoretic separation of bacterial cells* (p. 11)
- 9:40–10:00 Pažitná A.: *The enantiomer distribution of major chiral volatile organic compounds in Slovak monofloral honeys* (p. 13)
- 10:00–10:20 Krejčová Z.: *Voltammetric DNA biosensor for the detection of DNA damage caused by nitrated polycyclic aromatic hydrocarbons* (p. 16)
- 10:20–10:40 Čížková A.: *Single-drop microextraction method application to essential oils analysis in real samples of herbal tea* (p. 19)
- 10:20–11:00 **Coffee Break**
- Session 2** • chairperson: Magda Staňková
- 11:00–11:20 Bursová M.: *Preconcentration of aromatic and polyaromatic amines with bell-shaped extraction device assisted liquid-liquid microextraction* (p. 21)
- 11:20–11:40 Liebherr R.B.: *Analysis of individual enzyme molecules in femtoliter arrays* (p. 24)
- 11:40–12:00 Prchal V.: *Use of alkanethiol self-assembled monolayer modified electrodes in voltammetric analysis* (p. 28)
- 12:00–12:20 Hengerics Szabó A.: *Analysis of breath volatiles by inside needle capillary adsorption trap-gas chromatography* (p. 33)
- 12:20–13:20 **Lunch**

Session 3 • chairperson: Miroslava Bursová

- 13:20–13:40 Pomastowski P.: *Influence of heterogeneity biocolloids surface on their electrophoretic separation* (p. 36)
- 13:40–14:00 Markechová D.: *Fluorescence spectroscopy combined with parallel factor analysis for determination of geographical origin of juniper-flavoured spirit drinks* (p. 38)
- 14:00–14:20 Zavázalová J.: *Utilization of boron-doped diamond thin film electrode in electroanalysis of selected derivatives of amino derivatives of polycyclic aromatic hydrocarbons* (p. 41)
- 14:20–14:40 Staňková M.: *Effect of crosslinking monomer on the efficiency of polymethacrylate monolithic columns* (p. 45)

14:40–15:00 **Coffee Break****Session 4** • chairperson: Natalia Denderz

- 15:00–15:20 Kozlík P.: *Study of separation of selected pteridines in hydrophilic interaction liquid chromatography* (p. 47)
- 15:20–15:40 Sedlmeier A.: *Surface modification of upconverting luminescent nanoparticles for bioconjugation* (p. 49)
- 15:40–16:00 Walczak J.: *SPME-LC/MSⁿ for the analysis of selected biologically active compounds* (p. 53)

16:00–16:30 **Sponsors' presentations**17:00 **Get-Together Party****Tuesday, September 25, 2012****Session 5** • chairperson: Petr Kozlík

- 9:20–9:40 Denderz N.: *Temperature effect on the sorption selectivity of some phenolic acids on molecularly imprinted stationary phases* (p. 55)
- 9:40–10:00 Jačková M.: *Functionalized dendrimer stationary phases on silica gel for ion chromatography* (p. 58)
- 10:00–10:20 Klusáčková M.: *Electrocatalytic oxidation of unsaturated hydrocarbons mediated by phthalocyanine derivate* (p. 60)
- 10:20–10:40 Tatarkovič M.: *Chiroptical spectroscopy of human blood plasma in clinical diagnosis* (p. 63)
- 10:40–11:00 **Coffee Break**

Session 6 • chairperson: Pawel Pomastowski

- 11:00–11:20 Mark J.: *Fast non-aqueous capillary electrophoresis in short capillaries with amperometric end-column detection* (p. 65)
- 11:20–11:40 Dendisová M.: *Spectroelectrochemical study of 4-aminobenzene-thiol adsorbed on gold, silver and copper nanostructured surfaces* (p. 67)
- 11:40–12:00 Novotný V.: *Voltammetric determination of Fomesafen and Fluorodifen in drinking water and river water* (p. 72)
- 12:00–12:20 Grzywiński D.: *Determination of mycotoxins by micro-SPE coupled on-line with micro-HPLC/LIF* (p. 77)

12:20–13:20 **Lunch****Session 7** • chairperson: Jonas Mark

- 13:20–13:40 Krasulová J.: *Analytical methods used in the studies on chemical ecology of termites* (p. 79)
- 13:40–14:00 Novosad L.: *Analytical capabilities of plasma pencil in atomic emission spectrometry* (p. 82)
- 14:00–14:20 Rumlová T.: *New types of carbon composite film electrodes based on various metal substrates for determination of genotoxic environmental pollutants* (p. 84)
- 14:20–14:40 Němcová V.: *HPLC-UV method for the determination of genotoxic 4-nitroindane in the mixture of selected nitrated polycyclic aromatic hydrocarbons* (p. 87)

14:40–15:00 **Coffee Break****Session 8** • chairperson: Alexandra Hengerics Szabó

- 15:00–15:20 Rybínová M.: *Determination of selenium using photochemical volatile compounds generation coupled with atomic absorption spectrometry detection* (p. 89)
- 15:20–15:40 Podolec P.: *Determination of sevoflurane and hexafluoroisopropanol from plasma by GC-MS/MS* (p. 93)
- 15:40–16:00 Vojta J.: *New capillary monolithic column for isocratic separation of small molecules* (p. 96)

16:00–16:10 **Closing Ceremony**

Contributions

Influence of Charge Distribution on Electrophoretic Separation of Bacterial Cells

EWELINA DZIUBAKIEWICZ, BOGUSŁAW BUSZEWSKI

*Department of Environmental Chemistry and Bioanalytics, Faculty of Chemistry,
Nicolaus Copernicus University
Gagarin Str. 7, 87-100 Torun, Poland, ✉ ewelina.dziubakiewicz@gmail.com*

Keywords

bacterial cell

electrophoresis

physicochemical surface characteristics

Microorganisms are biocolloids that can change their surface properties based on interactions with each other and the surrounding environment. This change in surface characteristics dictate how bacterial cells may interact when forming aggregates and/or adhesion of bacterial cells. These phenomena are relatively complicated problem because no comprehensive theory describing every aspect of bacterial cells interaction has been created yet. Explanation of the mechanism forming aggregates and biofilms is very important also during electrophoretic separation.

The cell wall of bacteria is composed mainly of proteins, phospholipids, teichoic acid, teichuronic acid and lipopolysaccharides. These macromolecules contribute to bacterial surface charge due to the ionization of proton-active functional groups, such as carboxyl, phosphate, amino or hydroxyl groups and the adsorption of the ions from the solution.

In this work physicochemical surface characteristics of bacteria were measured to establish their role in bacterial adhesion and aggregation on the basis on electrophoretic behavior of different clinical strains of Gram-positive and Gram-negative bacteria. Properties of bacterial cell wall surfaces were investigated by the combination of electrochemical and spectroscopic techniques allow to obtain

concentration and protonation/deprotonation of the specific functional groups on the microorganism cell surface.

The results obtained help understand the electrophoretic separation behavior and allow to obtain more information about the charge on the surface of bacterial cell. Furthermore they are useful for describing the fundamental mechanisms involved in bacterial aggregation and adhesion to solid surfaces.

Acknowledgments

This work was supported by the National Science Centre (Narodowe Centrum Nauki, abbr. NCN, Warsaw, Poland) Grant No. NN204 369040.

The Enantiomer Distribution of Major Chiral Volatile Organic Compounds in Slovak Monofloral honeys

ALEXANDRA PAŽITNÁ, IVAN ŠPÁNIK, JANA DŽÚROVÁ

Institute of Analytical Chemistry, Faculty of Chemical and Food Technology, Slovak University of Technology, Radlinského 9, SK-812 37 Bratislava, Slovak Republic, ✉ ivan.spanik@stuba.sk

Keywords

honey

multidimensional gas chromatography

volatile organic compounds

Honey is one of the most important natural products that are used in food industry, in cosmetics and in medicine. One can distinguish between monofloral and polyfloral honeys. Monofloral honey is usually more appreciated, since it primarily originates from the nectar of one type of flower. Monofloral honeys differ in taste, flavor as well as in color depending on properties of primary nectar sources.

A volatile organic compound in honey is a mixture of different components containing various chemical functional groups that are usually present at low concentration levels. There are several ways how to extract volatile organic compound from honey. The most popular is solid phase microextraction (SPME). This technique can be easily automated, but optimization of working conditions (type of SPME fibres, sorption temperature, sorption time and desorption temperature) requires more time. Currently, it is mostly used for characterization of honey volatile organic compound profiles [1–4].

Many organic compounds present in honey are chiral, so they can exist as two enantiomers. The determination of enantiomer composition of chiral compounds can be used for evaluation of adulteration and manipulation with non-food commodities or for distinguishing between natural and synthetic compounds. Chiral compounds occur in the nature as a pure enantiomers or mixture of

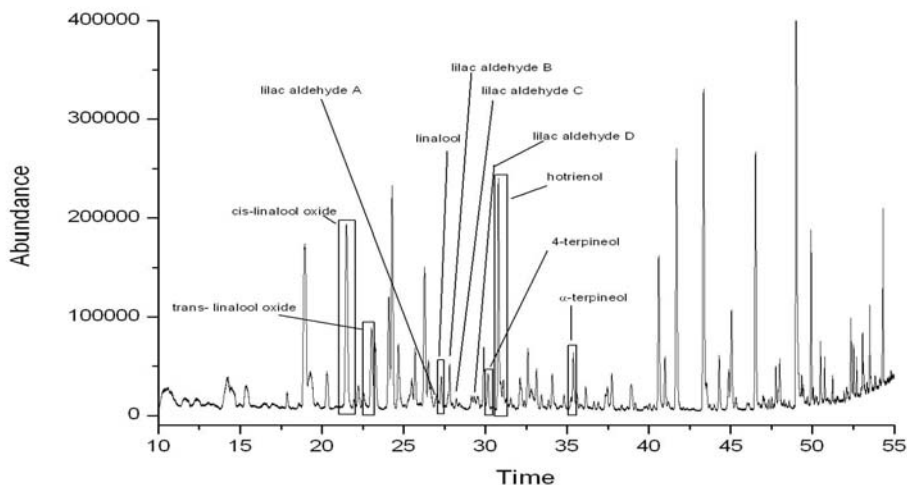

Fig. 1. GC-MS chromatogram of honey sample with marked compounds for which the enantiomer ratio was determined.

enantiomers with specific ratio. Any changes in these ratios may indicate manipulation with products or addition of synthetically produced chemicals.

In this work, the distribution of enantiomers of selected chiral volatile organic compounds in 45 monofloral honey samples was studied by GC. The volatile organic compounds were extracted from Slovakian rapeseed, acacia, sunflower basswood and raspberry honeys by solid phase microextraction followed by GC-MS analysis. Afterwards, chiral compounds present at higher concentration level were selected from more than 230 organic compounds found in studied honey samples for determination of their enantiomer ratios. It was found that one dimensional GC with chiral stationary phases shows excellent efficiency towards enantiomer separations; however resolved enantiomers often coelute with another non-chiral or already separated enantiomer of another organic compound. Thus, two dimensional GC with two independent thermostats was used to determine correct enantiomer ratios. Finally, the enantiomer ratios of linalool, *cis*- and *trans*-linalool oxides, hotrienol and four isomers of lilac aldehydes were determined. It was found, that distribution of enantiomers in honey samples partially depends on their botanical origin. The significant differences in enantiomer ratios of lilac aldehyde isomer B and hotrienol were observed for acacia honey that allows us to distinguish this type of honey from other ones.

Significantly different enantiomer ratio of *cis*-linalool oxide was found for sunflower honeys.

Acknowledgments

This work was supported by the project VEGA n. 1/0972/12 and by project Separation of enantiomers in food matrices by multidimensional gas chromatography – Program to support young researchers.

References

- [1] Kaskoniene V., Venskutonis P.R., Ceksteryte V.: *Food Chem.* **111** (2008), 988–997.
- [2] Soria A. C., Martinez-Castro I., Sanz J.: *J. Sep. Sci.* **26** (2003), 793–801.
- [3] Soria A.C., Sanz J., Martinez-Castro I.: *Eur. Food Res. Technol.* **228** (2009), 579–590.
- [4] Plutowska B., Chmiel T., Dymerski T., Wardencki W.: *Food Chem.* **126** (2011), 1288–1298.

Voltammetric DNA Biosensor for the Detection of DNA Damage Caused by Nitrated Polycyclic Aromatic Hydrocarbons

ZUZANA KREJČOVÁ, VLASTIMIL VYSKOČIL, JIŘÍ BAREK

Department of Analytical Chemistry, Faculty of Science, Charles University in Prague, Hlavova 2030/8, 128 43 Prague 2, Czech Republic, ✉ krejco11@natur.cuni.cz

Keywords

DNA biosensor
hanging mercury drop electrode
nitrated polycyclic aromatic hydrocarbons
2-nitrofluorene
voltammetry

Nitrated polycyclic aromatic hydrocarbons (NPAHs) are derivatives of polycyclic aromatic hydrocarbons, which contain two or more fused aromatic rings made of carbon and hydrogen atoms. Nitrated polycyclic aromatic hydrocarbons originate primarily as direct or indirect products of incomplete combustion, only a few NPAHs are produced industrially. Nitrated polycyclic aromatic hydrocarbons have been detected in the emissions of kerosene heaters, fuel gas and LPG burners used for heating and cooking at home, as well as in the fumes of cooking oils [1].

Nitrated polycyclic aromatic hydrocarbons administered by various routes are rapidly absorbed and metabolized. Many bacteria reduce NPAHs to mutagenic amino derivatives of polycyclic aromatic hydrocarbons. Nitroreduction by intestinal microflora plays a major role in the metabolism of NPAHs in mammals [2].

Although the genotoxic effects of the NPAHs are already well known more than 30 years, an electrochemical *in vitro* research on their interactions with DNA was realized quite recently [3]. Electrochemical analysis of DNA offers a number of approaches in DNA damage detection as well as in sensing of DNA damaging agents in the environment. Adenine and cytosine residues in DNA produce

reduction signals, while guanine residues yield anodic signals due to oxidation of the guanine reduction product. For the detection of these signals, voltammetric techniques with a hanging mercury drop electrode are used most frequently. By the observation of the changes in the intensity of such signals, the measure of DNA damage can be determined. Moreover, on the basis of the shift in the potential of voltammetric peaks of the analyte with the concentration of DNA present in the incubation solution, the type of damaging binding to DNA can be estimated [4].

In this contribution, 2-nitrofluorene has been chosen as a model representative of NPAHs. The interaction of 2-nitrofluorene with a double-stranded calf thymus DNA has been studied using the hanging mercury drop electrode as an electrochemical sensor. Two types of DNA damage were investigated and electrochemically detected: The DNA damage caused (*i*) by the direct interaction with 2-nitrofluorene and (*ii*) by short-lived radicals generated by the electrochemical reduction of the nitro group in 2-nitrofluorene. After reductive activation of 2-nitrofluorene, the oxidative DNA damage induced by the reactive species was evaluated from the height of cathodic peak of cytosine and adenine using cyclic voltammetry. The electrochemical reduction of 2-nitrofluorene (during the first 4-electron reduction step of nitro group reduction to hydroxyl-amino group) generates short-lived radicals that interact with DNA causing damage [5].

For the study of direct interaction, two approaches of DNA damage detection were used: Utilization of the signals of 2-nitrofluorene interacting with DNA non-covalently (*i*) using hanging mercury drop electrode (DNA titration technique) and (*ii*) at the DNA modified hanging mercury drop electrode after DNA incubation, right at the electrode surface using adsorptive transfer stripping technique. At the titration technique, DNA was preincubated with 2-nitrofluorene and, subsequently, the interaction was studied by means of differential pulse voltammetry. Using both detection techniques, the differences in the electrochemical behaviors of the 2-nitrofluorene molecules in the absence and presence of DNA were quite obvious. Direct interaction of DNA with 2-nitrofluorene results in the formation of a DNA–2-nitrofluorene complex. The mutual interaction was interpreted as an intercalation between the DNA base pairs. By addition of DNA, the peak of 2-nitrofluorene decreased and shifted toward the less negative potentials [6].

Acknowledgments

Financial support of this work, provided by The Ministry of Education, Youth and Sports of the Czech Republic (Project MSM 0021620857), by the Charles University in Prague (Project UNCE 2012/44 and SVV 2012-263204), is gratefully acknowledged.

References

- [1] World Health Organization: *Selected Nitro- and Nitro-Oxy-Polycyclic Aromatic Hydrocarbons*. <http://www.inchem.org/documents/ehc/ehc/ehc229.htm>, accessed 25.6.2012.
- [2] Möller L., Lax I., Eriksson L. C.: *Environ. Health Persp.* **101** (1993), 309–315.
- [3] Vyskočil V., Labuda J., Barek J.: *Anal. Bioanal. Chem.* **397** (2010), 233–241.
- [4] Paleček E., Wang J., Scheller F.: *Electrochemistry of Nucleic Acids and Proteins*. Amsterdam, Elsevier 2005.
- [5] Tocher J.: *Gen. Pharmacol.* **28** (1997), 485–487.
- [6] Fojta M.: *Electroanalysis* **14** (2002), 1449–1463.

Single-Drop Microextraction Method Application to Essential Oils Analysis in Real Samples of Herbal Tea

ANDREA ČÍŽKOVÁ, MARTIN ADAM, KAREL VENTURA

*Department of Analytical Chemistry, Faculty of Chemical Technology, University of Pardubice,
Studentská 573, 532 10 Pardubice, Czech Republic, ✉ andrea.cizkova@seznam.cz*

Keywords

essential oils

herbal beverages

single drop microextraction

Practical application of single-drop microextraction method is documented. This was realised in direct immersion mode (DI-SDME) for analysis of the essential oils components in soft drinks. There were ten samples of herbal tea and five ice tea samples analysed. Results were compared with the values obtained by a hydro-distillation method. All extracts were analysed by gas chromatography with flame ionization detector. Also an optimization of the beverage (tea) preparation and sensoric evaluation of selected herbal teas were performed.

For the DI-SDME method the simplified validation procedure was performed. Limits of detection and limits of quantification were evaluated together with repeatability and linearity tests. Repeatability was performed via intra-day (one day) and inter-day (one week) assays. The values of RSD (relative standard deviations) ranged from 0.40 to 12.71% for intra-day and from 1.55 to 14.96% for inter-day repeatability.

Optimization of the beverages preparation was also realised. Portion of the sample (1, 2, 3, 4, 5, 7 and 9 g), water temperature (50, 70, 90 and 100 °C), extraction time (3, 5, 10, 30 and 60 minutes) and sample volume used for analysis (6, 8, 10, 12 and 15 mL) were tested. Suitable conditions were found as follows: 4.0 g of herbal sample was transfused with 250 mL of boiled tap water pre-cooled to 90 °C. After 10 minutes the infusion was filtered and tempered to laboratory temperature (approx. 25 °C).

Sensory analysis of herbal tea was done as well. Five herbal tea samples were selected. It was Slim line, Immunostim, Digestion, Sleep and nerves and Lipton Alps. Clarity, colour, smell, taste and overall impression of all tea were assessed. Tasters did not know in advance what kind of herbal tea is evaluated. The best rated herbal tea (i.e. Digestion tea) was voted according to obtained results. That tea was then prepared at various temperatures and at different embedding leaching time. As a five types of preparation procedure the extraction temperature 70 °C for time 10 and 20 min, temperature 90 °C for 5 and 20 min and 5 min at 100 °C were selected. Top rated tea was prepared with 90 °C water at leaching time 5 min.

Fifteen samples of soft drinks were analysed (ten samples of herbal tea and five samples of ice tea) by DI-SDME method. Essential oils were extracted into the organic solvent drop immersed under the surface of liquid sample. Microdrop of the extraction solvent was pushed to the point of the sloping microsyringe needle. The obtained extracts were analysed by gas chromatography with flame ionization detector. Extraction phase was moved into the GC injection port at split ratio 1:10 at temperature 250 °C. Detector temperature was maintained at 250 °C and inlet column pressure was set to 50 kPa. Nitrogen was used as carrier gas and capillary column SLB-5ms (30 m × 0.32 mm, 1 µm film thickness) was used for separation. Column temperature program was as follows: 0–6 min at 80 °C and then increased by 6 °C/min to the final temperature 250 °C. To determine the qualitative and quantitative composition of herbal ice tea samples the standard addition method was used.

Preconcentration of Aromatic and Polyaromatic Amines with Bell-shaped Extraction Device Assisted Liquid-Liquid Microextraction

MIROSLAVA BURSOVÁ, RADOMÍR ČABALA

Department of Analytical Chemistry, Faculty of Science, Charles University in Prague, Albertov 6, 128 43 Prague 2, Czech Republic, ✉ bursova.mirka@seznam.cz

Keywords

aromatic and polyaromatic amines
bell-shaped extraction device assisted liquid-liquid microextraction
GC-MS
response surface method

The objective of the presented work is a preconcentration of selected aromatic and polyaromatic amines by a new extraction technique called 'bell-shaped extraction device assisted liquid-liquid microextraction' [1]. Afterwards, the extracted analytes have been determined by GC-MS.

Aromatic and polyaromatic amines are widely occurring in the nature and are substances of concern due to their toxicity and persistence in the environment. They are also useful industrial chemicals (pesticides, explosives, epoxy polymers, etc.) and highly toxic to human, some of them are classified as carcinogens. Owing to their high solubility in water, they can easily permeate through soil and contaminate groundwater [2].

Extraction method called bell-shaped extraction device assisted liquid-liquid microextraction was used for a preconcentration of aromatic and polyaromatic amines. The principle of the technique is an application of a special bell-shaped extraction device (Fig. 1) which allows application and withdrawal of very small volume of the extracting solvent (50–300 μL). An intense mixing of the aqueous sample creates distinct vortex on which surface the extraction solvent floats

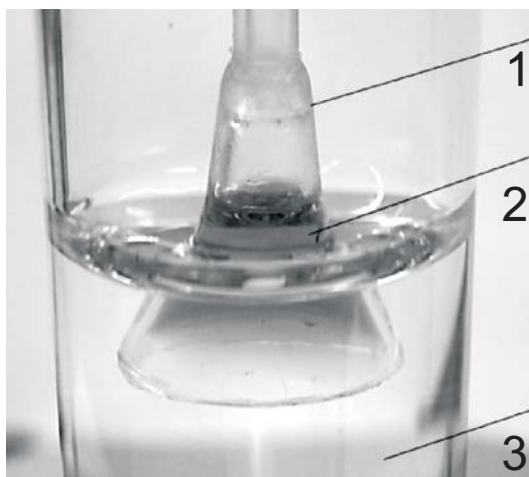

Fig. 1. The bell-shaped extraction device in glass vial: (1) bell-shaped extraction device, (2) organic phase, (3) aqueous phase.

without escaping from the interior of bell-shaped extraction device. After the extraction, bell-shaped extraction device provides an easy withdrawal of the extraction solvent by microsyringe. The important condition is application of organic solvent lighter than water.

The microextraction procedure was optimized with the response surface method [3]. The aim of response surface method is finding of a polynomial model equation, which describes the dependence of the defined response on the selected experimental parameters, in this case-the extraction time, the volume and type of solvent, the ionic strength (sodium chloride), the stirring rate and the diameter of extraction vial. The sum of the relative peak areas and the sum of the absolute peak areas of all analytes were used as the analytical response. The statistical software Minitab 16 was used for optimization of the microextraction method.

The optimal conditions were found as follows: the extraction time 30 min, the volume of toluene 170 μL , stirring rate 986 rpm, no addition of NaCl and the diameter of vial 1.9 cm. The enrichment factors of aromatic and polyaromatic amines were in range of 50–100, comparable with other microextraction techniques like single drop micro extraction or hollow fiber liquid-liquid microextraction.

The bell-shaped extraction device and the bell-shaped extraction device liquid-liquid microextraction methods were patented in Industrial Property Office in Czech Republic for commercial applications.

Acknowledgments

Financial support from the Grant Agency of Charles University in Prague (GA UK-21210), the Ministry of Education, Youth and Sports of the Czech Republic, project MSM 0021620857 and SVV 2012-265201 is gratefully acknowledged.

References

- [1] Čabala R., Bursová M.: *J. Chromatogr. A* **1230** (2012), 24–29.
- [2] Reddy-Noone, Jain A., Verma K.K.: *Talanta* **73** (2007), 684–691.
- [3] Bezerra M.A., Santelli R.E., Oliveira E.P., Villar L.S., Escalera L.A.: *Talanta* **76** (2008), 965–977.

Analysis of Individual Enzyme Molecules in Femtoliter Arrays

RAPHAELA B. LIEBHERR, FRANZISKA C. VOGL, HANS H. GORRIS

Institute of Analytical Chemistry, Chemo- and Biosensors, University of Regensburg, Universitätsstraße 31, 930 53 Regensburg, Germany, ✉ Raphaela.Liebherr@chemie.uni-r.de

Keywords

enzymes
femtoliter arrays
luminescence
microscopy
single-molecule studies

Traditionally, enzymatic processes are studied on a macroscopic scale. Whereas conventional bulk phase experiments reflect the mean performance of a total population they omit the contribution of individual molecules. The development of new technologies for enzyme studies at the single-molecule level has profoundly extended the knowledge of enzyme mechanisms. Apparently identical enzyme molecules have been observed to possess distinct and different turnover rates due to varying molecular conformations and posttranslational modifications [1].

A useful method to isolate and exploit single enzyme molecules is to enclose them individually in the reaction chambers of a high-density array of 50 000 femtoliter (fL) wells, embedded in a fused silica slide (Fig. 1). The dilute enzyme solution is combined with an excess of the substrate and enclosed in the array. On the basis of Poisson statistics an appropriate enzyme concentration is calculated to maximize the number of fL chambers that contain a single enzyme molecule only [2]. Poisson distribution

$$P_{\mu}(v) = e^{-\mu} \frac{\mu^v}{v!} \quad (1)$$

where v is the number of enzyme molecules enclosed in one reaction chamber, and μ is the mean number of enzyme molecules per chamber.

Fig. 1. TEM image of a high-density femtoliter array of 50 000 wells etched into the surface of a fused silica slide.

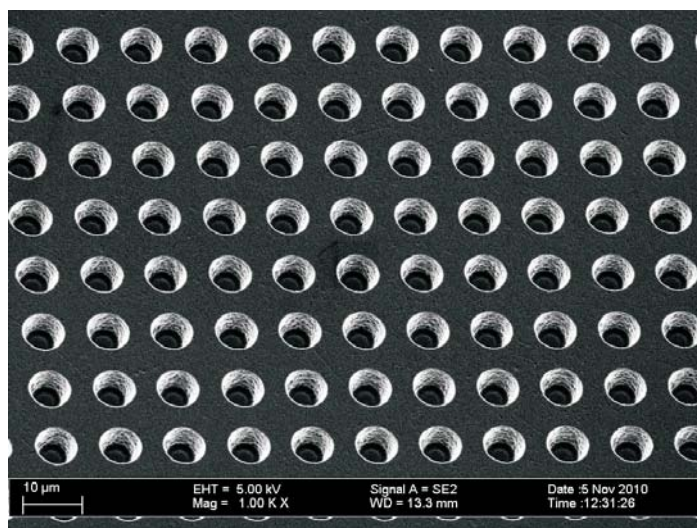

The enzyme activity is usually monitored through a fluorogenic reaction. Within a small reaction chamber a single enzyme molecule can generate a high local concentration of fluorescent product, sufficient to yield a detectable fluorescence signal that can be read out by fluorescence microscopy.

In the directed enzyme evolution, the amino-acid sequence of an established enzyme, the wildtype, is altered by point mutations. The evolved enzymes are then screened for new substrate specificities. Whereas the wildtype enzyme shows the highest enzyme activity for the substrate A, the evolved enzyme is intended to finally show the highest turnover rate for substrate B. Within the directed evolution process enzyme species are formed that display some activity for both substrates A and B. Those, so called generalists, are similar to the primordial enzymes which possessed a high metabolic flexibility hence a broad substrate specificity to compensate for the low gene content of ancient cells (cf. patchwork hypothesis) [3, 4]. According to the patchwork hypothesis, generalists should show a broad substrate specificity, hence a broad distribution of different and distinct activities in their enzyme population.

Single enzyme studies in femtoliter arrays provide the opportunity to verify this assumption by investigating both the enzyme activities of the generalists and the wildtype enzymes. The respective enzyme as well as a fluorogenic substrate is enclosed in the femtoliter array, where the substrate is cleaved, yielding a fluorescent product. The increasing fluorescence intensities are plotted against the detection time and from the linear part of the curve the turnover rate of the individual enzyme molecules can be determined.

From the standard deviation and the median of the recorded enzyme activities the coefficient of variation c_v for the wildtype and the evolved variant can be calculated

$$c_v = \frac{\sigma}{|\mu|} \quad (2)$$

To support the patchwork hypothesis the generalist should show a higher coefficient of variation hence a broader distribution of different and distinct activities in its enzyme population than the wildtype enzyme.



Fig. 2. Detection of the activity of single enzyme molecules in femtoliter arrays.

Femtoliter scale technologies give the opportunity to develop new forms of bioanalytical assays to replace antiquated, elaborate or expensive methods. One example is the invention of a novel, ultra-sensitive protease assay for the endopeptidase renin with the potential to replace current state of the art analytic methods for renin detection like radioimmunoassays or FRET-assays [5, 6].

Renin is a monomeric endopeptidase that initiates the renin-angiotensin cascade. It specifically cleaves the N-terminal part of the glycoprotein angiotensinogen, resulting in the decapeptide angiotensin I which is further processed to the octapeptide angiotensin II. Angiotensin II induces vasoconstriction, renal sodium and water retention, which leads to elevated blood pressure [7].

Protease analysis on the macroscopic scale relies on the conventional analogue read-out mode at which the substrate conversion in the entire reaction volume is monitored. In contrast, single molecule measurements operate with a digital read-out mode, wherein all chambers with active protease molecules are counted. Renin analysis in the reaction chambers of a femtoliter array hence enables the reduction of the limit of detection. Additionally, femtoliter scale technologies allow for renin detection without surface attachment, reducing steric hindrance [8].

The ambition for the novel renin assay within a femtoliter array is to reduce the limit of detection of renin in raw blood samples and thus to facilitate the diagnostics of renin. For this purpose angiotensin I responsive antibodies are immobilized on the surface of the femtoliter wells. The blood raw extract containing renin together with the substrate angiotensinogen is then enclosed in the reaction chambers. After cleavage the angiotensin I decapeptide will be bound by the immobilized antibodies. Subsequently, the wells are treated with fluorophore-labeled angiotensin I. The labeled and the non-labeled decapeptides compete for the antibody binding sites resulting in a sensitive competitive immunoassay.

References

- [1] Rissin D.M., Gorris H.H., Walt D.R.: *J. Am. Chem. Soc.* **130** (2008), 5349–5353.
- [2] Gorris H.H., Rissin D.M., Walt D.R.: *Proc. Natl. Acad. Sci. USA* **104** (2007), 17680–17685.
- [3] Ycas M.: *J. Theor. Biol.* **44** (1974), 145–160.
- [4] Jensen R.A.: *Annu. Rev. Microbiol.* **30** (1976), 409–425.
- [5] Castrop H., Hocherl K., Kurtz A., Schweda F., Todorov V., Wagner C.: *Physiol. Rev.* **90** (2010), 607–673.
- [6] Gorris H.H., Bade S., Röckendorf N., Albers E., Schmidt M.A., Franek M., Frey A.: *Anal. Chem.* **81** (2009), 1580–1586.
- [7] Gorris H.H.: *J. Med. Chem.*, accepted June, 2012.
- [8] Gorris H.H., Walt D.R.: *Angew. Chem. Int. Ed.* **49** (2008), 3880–3895.

Use of Alkanethiol Self-Assembled Monolayer Modified Electrodes in Voltammetric Analysis

VÍT PRCHAL, VLASTIMIL VYSKOČIL, JIŘÍ BAREK

UNESCO Laboratory of Environmental Electrochemistry, Department of Analytical Chemistry, Faculty of Science, Charles University in Prague, Hlavova 2030/8, 128 43 Prague 2, The Czech Republic, ✉ prchal@natur.cuni.cz

Keywords

hanging mercury drop electrode
self-assembled monolayer
square-wave voltammetry

With stricter legislation in many countries around the world the need for new analytical methods for determinations of various pollutants arises. Those methods should be preferably sensitive, cheap, fast, easy to perform and without the need for complex instrumentation. Using modern electroanalytical methods are perfect approach in such case. The main goal of this project is to develop novel method for simultaneous determination of various nitrated compounds (pesticides and explosives) using voltammetric techniques. Electrochemical peaks of these compounds frequently overlap – thus the determination is not always possible or is not accurate enough. The workaround for such cases is utilizing electrodes with chemically modified surface. This self-assembled monolayer (SAM) significantly changes sensitivity of the electrode towards different analytes, differentiating the signals (by means of peak potential shift and/or change of peak current). In theory such SAM works as a sieve that changes the accessibility of the electrode surface for different analytes.

To investigate this behavior, two similar substances (with overlapping electrochemical signals) were selected: 1-nitrobenzene, and 1,3-dinitrobenzene (99% and 97% respectively, supplied by Sigma-Aldrich). The SAMs investigated were formed by ethanethiol, octanethiol and octadecanethiol (97%, 98.5%, and 98%

respectively, Sigma-Aldrich). Stock solutions of all these substances (concentration of 1×10^{-3} mol L⁻¹) were prepared by dissolving these in pure methanol. Voltammetric measurements were performed using a Metrohm 663 VA stand with hanging mercury drop electrode (HMDE) controlled by Autolab PGstat 10 potentiostat connected to three-electrode system: HMDE working electrode, Ag/AgCl (3 mol L⁻¹) reference electrode with platinum wire auxiliary electrode. All measurements were recorded using Ecochemie NOVA 1.8 software. For voltammetric measurements square-wave voltammetry was used with following parameters [1]: frequency 15 Hz, amplitude -25 mV and step potential -4.05 mV. Supporting electrolyte always consisted of 5 mL Britton-Robinson buffer solution of given pH, 4 mL of pure methanol, and 1 mL of stock solution of analyte. The SAMs were prepared by immersing the mercury drop into alkanethiol solution for given time and then rinsed in pure methanol. After these two steps electrode was ready for voltammetric analysis [2].

It was found that the voltammetric signals of the model substances move linearly in the range of pH = 2 to pH = 8 on bare electrode. First the substances were measured on bare HMDE (see Fig. 1). Measurements were then performed in strongly acidic pH = 2.0 and neutral pH = 7.0. In this range the peaks of both

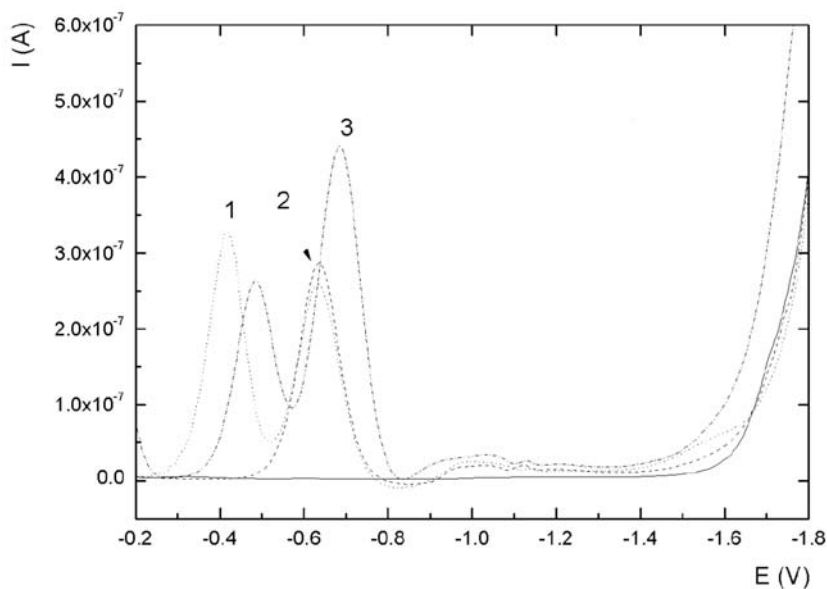

Fig. 1. Square-wave voltammograms of 1-nitrobenzene and 1,3-dinitrobenzene on unmodified HMDE at pH* = 7,0. Peaks of both substances are overlapping: (1) 1,3-dinitrobenzene, (2) 1-nitrobenzene, (3) the mixture of both. The black line represents blank signal of the supporting electrolyte.

substances overlap. First, the SAM modified HMDE was examined using all three SAM forming agents – to find out if the time of the immersion of the electrode has some significant effect on the voltammetric signal. The SAM formed by ethanethiol and octanethiol shown sharp desorption peaks (values of -0.3 V for ethanethiol to -0.65 V for octanethiol), overlapping the signals of the studied compounds (for ethanethiol desorption occurs even before the signals of the studied substances). Thus these two SAMs formed by those agents were not thoroughly investigated further. Octadecanethiol shown some better behaviour, since the desorption occurs in way more negative potential values not affecting the signals of the studied compounds. It was found out that the desorption potential is dependent on the pH (shifts towards more negative potentials with increasing pH), and also (and more importantly) on the chain length of the modification agent used – with increasing length of the alkyl chain the desorption potential rapidly increases. Though during octadecanethiol measurements a new peak was observed at potential of -0.6 V.

The dependency of the peak current on the time of immersion of the HMDE was investigated. Three voltammetric scans were performed with immersion time of 15 s, 60 s and 300 s. The peak current increased non-linearly with time elapsed, with latter two to such extent that this new peak could interfere with the studied compounds. Hence for further measurements the immersion time of 15 s was selected. Then the dependency of concentration of the modification agent on the peak current was investigated results show that the concentration in the range of 1×10^{-3} mol L⁻¹ to 1×10^{-6} mol L⁻¹ has a little effect so the SAM is always formed, not depending on the concentration SAM forming agent.

Then the voltammeteric measurements on HMDE modified with octadecanethiol in the presence of studied compounds were carried out (Fig. 2). Most important fact is that all voltammetric peaks were shifted towards more negative potentials by -0.2 V the reduction of the analytes on the electrode surface is more difficult (higher potential of the HDME is needed for reduction to occur). 1-nitrobenzene shown interesting results – this substance normally shows one reduction peak though in presence on the modified HMDE it presented with two peaks. Possible explanation – there is another electrode process underway, which is not yet fully understood.

This fundamental study evaluated usage of the alkanethiol SAMs created on surface of hanging mercury drop electrode – with potential application for

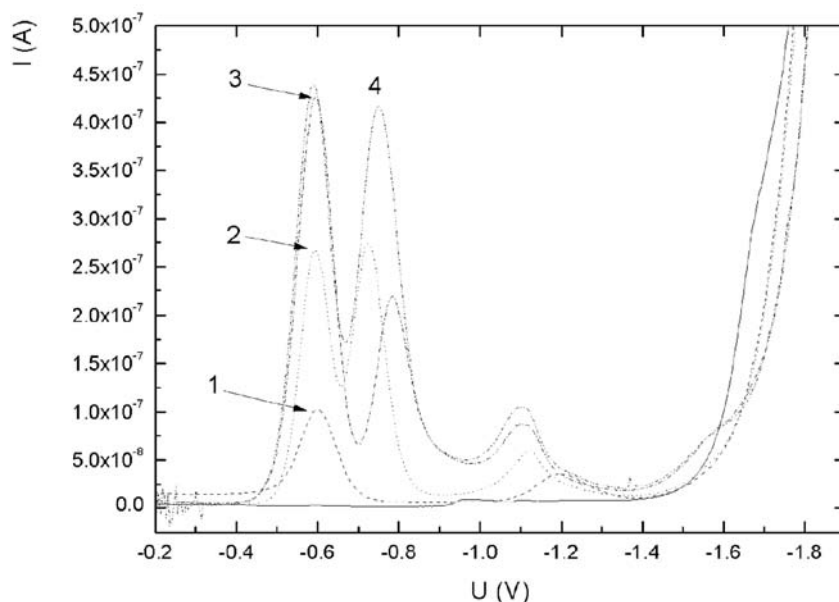

Fig. 2. Square-wave voltammograms of model substances on HMDE modified with 1-octadecanethiol at $\text{pH}^* = 7,0$, mod. time 15 s. Electrochemical signal of self-assembled monolayer itself overlaps with the signal of model substances: (1) supporting electrolyte on modified HMDE, (2) 1-nitrobenzene, (3) 1,3-dinitrobenzene, (4) the mixture of both (black line represents the signal of blank on unmodified electrode). Most important fact shown here is the peak potential shift of all substances towards more negative values (approx. $-0,2 \text{ V}$) compared to unmodified HMDE.

determination of industrially important nitrated organic compounds. Aliphatic alkanethiols alter the signal of the model substances significantly, though with limited future usage (due to desorptions of the SAM itself). Different concentrations of the SAM forming substances do not affect the creation of the SAM – it is always formed in the presence of such compound. The future development of the novel method is either by using different thiols (e.g., hydroxy terminated) or by using different working electrodes – like solid gold electrodes (which show intense extension of the potential window when modified with SAMs) [3], or mercury meniscus modified silver solid amalgam electrode.

Acknowledgments

Financial support by The Ministry of Education, Youth and Sports of the Czech Republic (Project MSM 0021620857), by the Charles University in Prague (Projects UNCE 2012/44 and SVV 2012-265201), and The Grant Agency of the Czech Republic (Project P206/12/G151) is gratefully acknowledged.

References

- [1] Bozic R. G., West A. C., Levicky R.: *Sensor Actuat. B-Chem.* **133** (2008), 509–515.
- [2] Buoninsegni T., Herrero R., Moncelli M. R.: *J. Electroanal. Chem.* **452** (1998), 33–42.
- [3] Carrillo I., Quintana M. C., Esteva A. M., Hernández L., Hernández P.: *Electroanalysis* **20** (2008), 2614–2620.

Analysis of Breath Volatiles by Inside Needle Capillary Adsorption Trap-Gas Chromatography (INCAT-GC)

ALEXANDRA HENGERICS SZABÓ^a, PETER PODOLEC^a, RÓBERT KUBINEC^a,
VICTOR G. BEREZKIN^b

^a *Institute of Chemistry, Faculty of Natural Sciences, Comenius University,
Mlynská dolina CH-2, 842 15 Bratislava, Slovakia, ✉ szaboova@fns.uniba.sk*

^b *A. V. Topchiev Institute of Petrochemical Synthesis, Russian Academy of Science,
Leninsky Prosp. 29, 119991 Moscow, Russia*

Keywords

exhaled breath

GC-MS

INCAT

solventless extraction

The aim of this work was to develop a new solventless microextraction technique, which in combination with GC-MS can be used for analysis of volatile organic metabolites in exhaled breath samples.

Volatile organic compounds have been proposed to be contained in exhaled breath, their concentration pattern serving for identification of lung carcinoma, breast carcinoma and rejection of foreign tissue after heart transplant rejection or other human diseases. Exhaled breath analysis as a clinical tool requires reliable identification and quantification of the ppb–ppt concentrations present and proper understanding of the basic biochemical mechanisms that generate these trace components [1].

The changing concentration of most trace gases in the breath represents the main problem of determination. The reproducibility of measurements is difficult at such low concentrations. Due to the low concentration of substances in exhaled breath sometimes preconcentration is needed before the analysis to increase the amount of volatile organic compounds in the sample [2, 3]. There are many techniques available for preconcentration, such as adsorption of the analytes and

their subsequent thermal desorption and determination by gas chromatography-mass spectrometry. Adsorbents in adsorption devices must be chosen carefully to avoid the memory effect and the breakthrough of the analytes. Organic polymers, activated carbon, various types of graphitized carbon blacks and carbon molecular sieves are used for preconcentration of organic compounds present in human exhaled breath. High humidity of the exhaled breath samples can complicate the sampling to a great extent. These methodological problems are partially solved by improving sampling and analytical techniques [4].

The most frequent method used for exhaled breath analysis is GC-MS. Different ways of preconcentration of exhaled breath samples and subsequent GC-MS analysis represent a reliable and sensitive method for volatile organic compounds analysis. First results suggest that GC-MS can be a useful tool in the future for the diagnosis of various diseases [5]. Gas chromatography-mass spectrometry and GC with tandem MS (GC-MS/MS) in hyphenation with off-line sample collection of relatively large amounts of samples and preconcentration are sufficiently sensitive for the analysis of compounds present in human breath at ppt concentration levels [6].

We developed a device suitable for the sampling of exhaled breath, what contains a wide range of volatile organic compounds. A newly designed three-layered needle capillary adsorption trap device packed with Chromosorb W coated with 20% methyl silicone OV-1, Carbopack X and Carboxen 1000, as sorbent materials inside the full volume of stainless steel needle was used for sampling, preconcentration and injection of volatile analytes from breath samples into the gas chromatograph.

Exhaled breath samples were collected into inert Tedlar bags. Active sampling method was used by drawing a constant sample volume through the pump into the INCAT (Inside Needle Capillary Adsorption Trap) device, where analytes were trapped by the sorbents. An injection port with a modified metal liner was used to desorb analytes trapped in the needle trap device.

The possibility of using the developed technique for the analysis of volatile organic compounds in exhaled breath was tested. Concentration of substances in ambient air, working environment, consumed food and beverages may affect the determination of some endogenous molecules.

The main advantages of INCAT device compared to other solventless extraction methods are robustness of the device, simplicity and the possibility of sampling substances with a wide range of volatility and polarity.

Acknowledgments

This publication is the result of the project implementations: 'Amplification of the Centre of Excellence on Green Chemistry Methods and Processes (CEGreenII)' ITMS: 26240120025 supported by the Research & Development Operational Programme funded by the ERDF. Work was also supported by the Slovak Research and Development Agency under the contract Nos. APVV-0416-10, and APVV-0665-10.

References

- [1] Amann A., Španěl P., Smith D.: *Mini Rev. Med. Chem.* **7** (2007), 115–129.
- [2] Di Francesco F., Fuoco R., Trivella M.G., Ceccarini A.: *Microchem. J.* **79** (2005), 405–410.
- [3] Libardoni M., Stevens P.T., Waite J.H., Sacks R.: *J. Chromatogr. B* **842** (2006), 13–21.
- [4] Ochiai N., Takino M., Daishima S., Cardin D.B.: *J. Chromatogr. B* **762** (2001), 67–75.
- [5] Buszewski B., Keszy M., Ligor T., Amann A.: *Biomed. Chromatogr.* **21** (2007), 553–566.
- [6] Chambers S.T., Syhre M., Murdoch D.R., McCartin F., Epton M.J.: *Med. Mycol.* **47** (2009), 468–476.

Influence of Heterogeneity Biocolloids Surface on Their Electrophoretic Separation

PAWEŁ POMASTOWSKI, EWELINA DZIUBAKIEWICZ, BOGUSŁAW BUSZEWSKI

*Department of Environmental Chemistry and Bioanalytics, Faculty of Chemistry,
Nicolaus Copernicus University
Gagarin Str. 7, 87-100 Torun, Poland, ✉ pawel_pomastowski@wp.pl*

Keywords

biocolloid
potentiometric titration
yeast
zeta potential
zone capillary electrophoresis

Most microorganisms are species pathogenic to humans, animals. Modern microbiological analysis in hospitals, medical centers based on a time-consuming inoculation methods by which it is possible to make the necessary antibiograms. There are diagnostic microbiological laboratories, which for the identification of pathogenic fungi by using the PCR technique. An alternative to time consuming and expensive methods for the identification of microorganisms can become a cheap and fast electrophoretic analysis of microorganisms. Characterization of the surface microorganisms – which are biocolloids – is necessary to understand, yet unclear, their behavior during electrophoretic analysis. Knowledge of the functional groups responsible for the aggregation and adhesion to the surface allowed understand the mechanism of electrophoretic separation and surface modifications to improve the selectivity of the separation process. The aim of this study was the identification and participation the dominant functional groups on the surface of *Saccharomyces cerevisia*, the modification of surface functional groups in order to eliminate the adhesion to the surface of the capillary wall and optimization of conditions for the electrophoretic analysis of the yeast.

Acknowledgments

This work was supported by the National Science Centre (Narodowe Centrum Nauki, abbr. NCN, Poland) Grants No. N N204 369040, N N204 369440, and CHEMO-KOP no. 02/2011.

Fluorescence Spectroscopy Combined with Parallel Factor Analysis (PARAFAC) for Determination of Geographical Origin of Juniper-Flavoured Spirit Drinks

DIANA MARKECHOVÁ, PAVEL MÁJEK, JANA SÁDECKÁ

Institute of Analytical Chemistry, Faculty of Chemical and Food Technology, Slovak University of Technology, Radlinského 9, SK-812 37 Bratislava, Slovakia, ✉ diana.markechova@stuba.sk

Keywords

beverage

fluorescence

juniper drinks

parallel factor analysis

The composition of juniper-flavoured spirit drinks is influenced by many factors related to the specific production area: origin of ethyl alcohol, *Juniperus* species and spirit making practices. For this reason, there is a need for a rapid method for determining the geographical origin of products to protect regional designations and reassure consumers. Although juniper-flavoured spirit drinks are well known and widely consumed (gin is the most popular), there are only few studies on their volatile/semivolatile composition and sensory profiles available. Recently, information about the sensory profile of four London Dry Gins and two gins with geographical indications was presented. In addition, the sensory results were in agreement with the composition of gin volatile fraction obtained by headspace-solid phase microextraction coupled with gas chromatography/mass spectrometry. Only limited data on the nonvolatile (aromatic) components of leaves, twigs, and berries of juniper are reported to date. Eugenol, methoxyeugenol, totarol, flavonoids, biflavonoids, coumarins, and chlorophyll are the best known aromatic molecules in juniper berries. These components are also possible fluo-

rescent molecules in juniper-flavoured spirit drinks. Indeed totarol was determined in commercial distilled gins recently.

This study suggests the use of fluorescence spectroscopy combined with parallel factor analysis (PARAFAC) for distinguishing between commercial samples of juniper-flavoured spirit drinks. Distillates of different geographical indications included drinks produced in Belgium, Czech Republic, Germany, Slovakia and UK. The other samples were Slovak commercial brands of 'juniper-flavoured spirit drinks'. Fluorescence spectra were recorded using a Perkin-Elmer LS 50 Luminescence spectrometer equipped with a Xenon lamp. Samples were placed in 10 mm × 10 mm × 45 mm quartz cell. Excitation and emission slits were both set at 5 nm. The spectrometer was interfaced to a computer supplied with FL Data Manager Software (Perkin-Elmer) for spectral acquisition and data processing. Fluorescence emission spectra were recorded from 250 to 700 nm (increment 0.5 nm), repeatedly, at excitation wavelengths from 200 to 500 nm, spaced by 5 nm interval in the excitation domain. Thus it was possible to record one fluorescence excitation–emission matrix, i.e. set of emission spectra recorded at several excitation wavelengths, for each sample. Excitation–emission matrixes were plotted using Windows-based software OriginPro 7.5 (OriginLab, USA, 2002).

Parallel factor analysis is a commonly used method for modeling fluorescence excitation-emission data. The fluorescence signals X are decomposed into F tri-linear components according to the number of fluorophores present in the samples

$$x_{ijk} = \sum_{f=1}^F a_{if} b_{jf} c_{kf} + e_{ijk} \quad (1)$$

where x_{ijk} is the intensity of the measured light for sample i at emission wavelength j and excitation wavelength k and e_{ijk} is the error term. The i -th score for the f -th component is denoted by a_{if} and is related to the concentration of fluorophore f in sample i ; b_{jf} and c_{kf} represent the j -th and k -th matrix element of the f -th emission and excitation loading, respectively. Microsoft Office Excel 2003, Statistica version 7.0 (StatSoft, USA, 2004), MATLAB version 7.0 (The MathWorks Inc., USA, 2005) and The N-way toolbox for MATLAB were used for statistical analysis. No pre-processing of the data was used in PARAFAC. Parallel factor analysis models of fluorescence landscapes were estimated with one to four components. Based on split-half experiments and investigation of the residuals, the PARAFAC model

with three components was considered optimal, i.e. three different fluorescence phenomena were found present in the spirits in this investigation. The model explained 99.6% of the variation within the dataset, with variation explained by each component decreasing sequentially from component 1 to component 3. Relatively high residual errors remained at low excitation wavelengths ($\lambda_{\text{ex}} < 240 \text{ nm}$), however, this characteristic do not necessarily invalidate a model.

This study shows that juniper-flavoured spirit drinks can be distinguished using differences in their fluorescence spectra. Differentiation between samples is in part possible by visual inspection of the spectra however it is accomplished by multivariate data analysis methods more easy. Although the molecular species responsible for the observed spectral features are unknown, pattern recognition techniques applied to a spectral dataset allow information applicable to obtaining a satisfactory differentiation of the juniper spirits according to their geographical origin. Thus fluorescence spectroscopy offers a promising approach for the authentication of juniper-flavoured spirit drinks as no sample preparation is required, and data acquisition and analysis are relatively simple.

Acknowledgements

This research was supported by the Scientific Grant Agency of the Ministry of Education of Slovak Republic and the Slovak Academy of Sciences VEGA No 1/0182/11.

Utilization of Boron-Doped Diamond Thin Film Electrode in Electroanalysis of Selected Derivatives of Amino Derivatives of Polycyclic Aromatic Hydrocarbons

JAROSLAVA ZAVÁZALOVÁ, JIŘÍ BAREK, KAROLINA PECKOVÁ

UNESCO Laboratory of Environmental Electrochemistry, Department of Analytical Chemistry, Faculty of Science, Charles University in Prague, Hlavova 8, 128 43 Prague 2, Czech Republic, ✉ jaroslava.zavazalova@natur.cuni.cz

Keywords

aminobiphenyls
aminonaphthalenes
amperometry
boron-doped diamond film electrode
voltammetry

Aminobiphenyls and aminonaphthalenes belong to aminoderivatives of polycyclic aromatic hydrocarbons, significant pollutants of working and living environment. Aminoderivatives of polycyclic aromatic hydrocarbons may have carcinogenic, mutagenic, and teratogenic effects. 4-aminobiphenyl and 2-aminonaphthalene are proven human carcinogens [1], for 1-aminonaphthalene mutagenic effects have been verified [2].

In general, amino group at aromatic skeleton can easily undergo electrochemical oxidation; therefore modern electroanalytical detection methods represent a suitable tool for monitoring of aminoderivatives of polycyclic aromatic hydrocarbons in various environmental and biological matrices. Boron-doped diamond thin film is a popular electrode material with favorable mechanical and electrochemical properties, such as wide potential window in cathodic and anodic region, mechanical and chemical stability, low residual current and biocompatibility [3, 4]. Since its introduction in electroanalysis in 1992 [3] it has been

successfully employed in electroanalysis of oxidizable and reducible pharmaceuticals, agrochemicals, environmental pollutants including aminoderivatives of polycyclic aromatic hydrocarbons [5, 6] and nitrated polycyclic aromatic hydrocarbons [7], and other biologically active organic compounds [4].

In this study, a differential pulse voltammetric method was optimized for the determination of 2-aminobiphenyl, 4-aminobiphenyl, 1-aminonaphthalene, and 2-aminonaphthalene using anodically oxidized boron-doped diamond electrode. Further, submicromolar limits of determination were obtained for amperometric detection of these analytes at boron-doped diamond film electrode in wall-jet arrangement after their separation using HPLC on a reversed phase.

The 1×10^{-4} mol L⁻¹ stock solutions of 2-aminobiphenyl, 4-aminobiphenyl (both Sigma-Aldrich, 97%), 1-aminonaphthalene (Sigma-Aldrich, 98%), and 1-aminonaphthalene (Sigma-Aldrich, 95%) were prepared by dissolving of exact mass of each compound in deionized water (Millipore Q-plus System, Millipore, USA). Britton-Robinson buffers were prepared by mixing a solution of phosphoric, acetic and boric acid (concentration of each 0.04 mol L⁻¹) with an appropriate amount of 0.2 mol L⁻¹ sodium hydroxide solution (all p.a., Lach-Ner, Czech Republic). Acetonitrile (HPLC grade, Merck, Germany) was used as the organic part of the mobile phase. The aqueous part of the mobile phase was phosphate buffer consisting of 0.01 mol L⁻¹ disodium hydrogen phosphate (p.a., Lachema, Czech Republic), its pH was adjusted by the addition of concentrated phosphoric acid (p.a., Lach-Ner, Czech Republic).

Voltammetric measurements were carried out using a computer controlled EcoTribo Polarograph with Polar Pro software (version 5.1, Polaro-Sensors, Czech Republic). Differential pulse voltammetry (DPV) with a pulse height of +50 mV, pulse width of 100 ms and scan rate of 20 mV s⁻¹ were used. For HPLC (gradient pump BETA 10, degasser DG 3014 on-line, SAPPHIRE UV-VIS detector, all ECOM, Czech Republic) with amperometric detection (potentiostat ADLC 2, Laboratorní přístroje, Czech Republic), the column LichroCART[®] 125-4 Purospher[®]STAR RP-18e (5 μm) (Merck, Germany), mobile phase consisting of acetonitrile and 0.01 mol L⁻¹ phosphate buffer pH = 3.0 (40:60, v/v), and detection potential +1.0 V were used. All measurements were performed in a three-electrode arrangement, using a silver chloride reference electrode (Ag|AgCl, 3 mol L⁻¹ KCl) and a platinum wire auxiliary electrode (both Monokrystaly Turnov, Czech Republic). A boron doped diamond microcrystalline film electrode (prepared at Michigan State

University, East Lansing, USA) with active geometric area of 12.6 mm² in disc arrangement was used as the working electrode in both, voltammetric and amperometric detection modes [7].

Firstly, differential pulse voltammetry was used for the investigation of passivation of electrode surface in the presence of 1-aminonaphthalene, 2-aminonaphthalene, 2-aminobiphenyl, for 4-aminobiphenyl and to study the influence of pH on signals of these analytes. The problem with passivation of electrode surface in the presence of aminonaphthalenes was visualized by consecutive decrease of their peak heights at repetitive DP voltammograms and solved by applying an activation program consisting of stirring and applying the potential of +2.4 V for 15 s on working electrode in measured solution. The influence of pH on signals of analytes was measured in the media of Britton-Robinson buffer pH = 2.0–12.0. The optimal pH of Britton-Robinson buffer is 7.0 for 1-aminonaphthalene, 2-aminonaphthalene, and 2-aminobiphenyl, and pH = 9.0 for 4-aminobiphenyl. Limits of determination were obtained in the range from 0.25 μmol L⁻¹ for 4-aminobiphenyl to 2.96 μmol L⁻¹ for 1-aminonaphthalene using these optimum conditions.

Further, an attempt was made to use DPV for simultaneous determination of studied analytes. It succeeded only in the case that the difference of peaks potentials of particular analytes was higher than ca 150 mV, e.g., for the pair of 2-aminobiphenyl and 4-aminobiphenyl using Britton-Robinson buffer pH = 12.0 as supporting electrolyte. Parameters of calibration dependencies of 2-aminobiphenyl for changing concentration of 2-aminobiphenyl and constant concentration of 4-aminobiphenyl and vice versa with micromolar detection limits were obtained.

The boron-doped diamond film electrode in 'wall-jet' arrangement was also employed for amperometric determination of studied analytes in HPLC with electrochemical detection. Their separation was completed in 11 minutes. The optimum detection potential +1.0 V was chosen on the basis of the highest signal-to-background ratio evaluated from hydrodynamic voltammograms. Concentration dependencies were linear in the concentration range from 0.02 to 10 μmol L⁻¹ and limits of determination were obtained in the range from 0.06 μmol L⁻¹ for 2-aminonaphthalene to 0.20 μmol L⁻¹ for 2-aminobiphenyl. Practical applicability of the proposed methods will be demonstrated on the determination of mixtures of aminobiphenyls and aminonaphthalenes in the dye

sunset yellow (E 110) after their preliminary separation and preconcentration using solid-phase extraction.

Acknowledgments

The research was supported by the Ministry of Education, Youth and Sports of the Czech Republic (Project MSM 0021620857), Charles University in Prague (Project SVV 2012-265201), and Grant Agency of the Czech Republic (Project P206/12/G151). JZ thanks to the Faculty of Science, Charles University in Prague (project STARS) for financial support.

References

- [1] IARC Working Group on the Evaluation of Carcinogenic Risks to Humans: *Some Aromatic Amines, Organic Dyes, and Related Exposures*. (IARC Monographs on the Evaluation of Carcinogenic Risks to Humans, vol. 99). Lyon, IARC 2010.
- [2] Cheung Y., Lewis D. F. V., Ridd T. I., Gray T. J. B., Ioannides C.: *Toxicology* **118** (1997), 115–127.
- [3] Fujishima A., Einaga Y., Rao T. N., Tryk D. A.: *Diamond Electrochemistry*. Amsterdam, Elsevier 2005.
- [4] Peckova K., Musilova J., Barek J.: *Crit. Rev. Anal. Chem.* **39** (2009), 148–172.
- [5] Barek J., Jandova K., Peckova K., Zima J.: *Talanta* **74** (2007), 421–426.
- [6] Maixnerová L., Barek J., Pecková K.: *Electroanalysis* **24** (2012), 649–658.
- [7] Cizek K., Barek J., Fischer J., Peckova K., Zima J.: *Electroanalysis* **19** (2007), 1295–1299.

Effect of Crosslinking Monomer on the Efficiency of Polymethacrylate Monolithic Columns

MAGDA STAŇKOVÁ, PAVEL JANDERA, JIŘÍ URBAN, VERONIKA ŠKEŘÍKOVÁ

Department of Analytical Chemistry, Faculty of Chemical Technology, University of Pardubice, Studentska 573, 532 10 Pardubice, Czech Republic, ✉ magda.stankova@student.upce.cz

Keywords

capillary columns

liquid chromatography

low-molecular compounds

organic polymer monolith

two-dimensional chromatography

Miniaturization in liquid chromatography with micro-bore or capillary chromatographic columns allows lower volumes of mobile phases, and of samples to be used. Monolithic stationary phases formed by a single piece of highly porous material are very suitable for miniaturization.

Organic polymer monolithic columns in capillary or micro-bore format can be prepared by *in-situ* polymerization in a fused silica capillary. The polymerization mixture generally contains a crosslinking monomer, a functional monomer, porogen solvents and an initiator of radical polymerization. Optimization of composition of the individual components in the polymerization mixture allows straightforward control of hydrodynamic and separation properties of columns such as porosity, efficiency, and selectivity.

Separation of low-molecular compounds on organic polymer monolithic columns has been not as easy to achieve as with silicagel monolithic columns because of relatively low efficiency of polymethacrylate or polystyrene monolithic columns prepared in traditional way. The objection of the present work was increasing the efficiency of separation of low molecular compounds by varying the chemistry of crosslinking monomers with two methacrylate units.

The generic polymerization mixture contained lauryl methacrylate as functional monomer with ethylene dimethacrylate as a crosslinking monomer. The crosslinker was replaced by dimethacrylates with longer alkyl or oxyethylene chains between the two end methacrylate units. These columns have been optimized for application in reversed-phase chromatography.

Because the separation of highly polar compounds in reversed-phase chromatography is very difficult, hydrophobic lauryl methacrylate monomer was replaced by zwitterionic *N,N*-dimethyl-*N*-metacryloxyethyl-*N*-(3-sulfopropyl)-ammonium betaine functional monomer for hydrophilic interaction chromatography, where polar compounds provide sufficient retention. The optimized column afford very fast isocratic separation of low-molecular non-polar and polar compounds in less than two minutes and show efficiencies of 70 000 theoretical plates/meter.

The result of this work confirmed significant effect of the length and chemistry of the chain in the crosslinking monomer on the efficiency of polymethacrylate capillary columns and importance of its optimization to obtain suitable pore morphology enabling fast and efficient isocratic separations of low molecular compounds.

The optimized columns have been tested for reversed-phase and hydrophilic interaction separations of complex mixture of flavones and phenolic acids in one-dimensional and comprehensive two-dimensional liquid chromatography.

Acknowledgments

The financial support of GACR project P206/12/0398 is gratefully acknowledged.

Study of Separation of Selected Pteridines in Hydrophilic Interaction Liquid Chromatography

PETR KOZLÍK, ZUZANA BOSÁKOVÁ

Department of Analytical Chemistry, Faculty of Science, Charles University in Prague, Albertov 6, 128 43 Prague 2, Czech Republic, ✉ kozlipet@centrum.cz

Keywords

hydrophilic interaction liquid chromatography
mass spectrometry
pteridines

Hydrophilic interaction liquid chromatography (HILIC) is a technique that has attracted increasing attention since it offers an alternative approach for separation of highly polar compounds. The primary retention mechanism in HILIC is believed to be analyte partitioning between the bulk eluent and the water-rich layer that is partially immobilized on the surface of the stationary phase [1]. The other suggested mechanism involves ionic, hydrogen-bonding, hydrophobic and hydrophilic interactions [2–5]. The predominant retention mechanism in HILIC separation is not unequivocal and it can differ when different analytes and/or different stationary and mobile phases are applied [6].

Pteridines or pterins represent one of the families of pigmentary colours of insect cuticle but some of them are also important eye pigments. They produce a variety of colours, ranging from white (leucopterin), or red (erythropterin) over yellow (xanthopterin) to fluorescent blue under ultraviolet light (biopterin). In addition, pteridines are important metabolically as co-factors of enzymes associated with growth and differentiation; they may act as controlling agents in these processes [7]. According to their structure it seems that they could be separated in HILIC mode.

The main aim of this study was testing retention properties and separation of selected pteridines, namely leucopterin, isoxanthopterin, xanthopterin,

biopterin, neopterin and erythropterin on two different stationary phases: Atlantis HILIC Silica (Waters, 4.6×150 mm, 3 μm) and ZIC®-HILIC (Merck, 4.6×150 mm, 3.5 μm). The effects of the ratio of organic and aqueous parts of mobile phase, buffer pH and concentration on retention and separation of pteridines were investigated. Model designed by SnyderSoczewinski [8] was used for an indication whether partitioning or adsorption is the dominating retention mechanism. Tandem mass spectrometry was used as a selectivity and sensitivity detector. Mass spectrometric detection was performed in reaction monitoring mode where the precursor and product ions were selected for each analyte individually. Based on the obtained results, it can be concluded that Atlantis HILIC Silica column is not suitable for separation of studied analytes. On the other hand, ZIC®-HILIC column provided sufficient retention and selectivity for separation of selected pteridines (results will be included in presentation).

Acknowledgments

The financial support of the Grant Agency of Charles University in Prague, SVV 2012-265201, the Ministry of Education, Youth and Sports of the Czech Republic, project MSM0021620857, the Grant Agency of the Czech Republic project P505/11/1459 as well as the Norwegian Financial Mechanism, project CZ0116, is gratefully acknowledged.

References

- [1] Alpert A.J.: *J. Chromatogr. A* **499** (1990), 177–196.
- [2] Berthod A., Chang S.S.C., Kullman J.P.S., Armstrong D.W.: *Talanta* **47** (1998), 1001–1012.
- [3] McCalley D.V., Neue U.D.: *J. Chromatogr. A* **1192** (2008), 225–229.
- [4] Buszewski B., Bocian S., Dziubakiewicz E.: *J. Sep. Sci.* **33** (2010), 1529–1537.
- [5] Jandera J., Urban J., Škeříková V., Langmaier P., Kubíčková R., Planeta J.: *J. Chromatogr. A* **1217** (2010), 22–33.
- [6] Hao Z., Xiao B., Weng N.: *J. Sep. Sci.* **31** (2008), 1449–1464.
- [7] Porcar M., Bel Y., Socha R., Němec V., Ferré J.: *J. Chromatogr.* **724** (1996), 193–197.
- [8] Snyder L.R., Poppe H.: *J. Chromatogr.* **184** (1980), 363–414.

Surface Modification of Upconverting Luminescent Nanoparticles (UCLNPs) for Bioconjugation

ANDREAS SEDLMEIER, STEFAN WILHELM, HANS H. GORRIS

*Institute of Analytical Chemistry, Chemo- and Biosensors, University of Regensburg,
Universitätsstraße 31, 930 53 Regensburg, Germany,*

✉ Andreas.Sedlmeier@chemie.uni-regensburg.de

Keywords

capsid
encapsulation
nanoparticles
upconversion
virus-like particles

Fluorescence and phosphorescence are based on the absorption of photons with short wavelengths and the emission of photons with a longer wavelength (Stokes processes). Anti-Stokes processes, by contrast, are characterized by short-wavelength emission after long-wavelength excitation. The process of photon upconversion (UC), as an example, includes the sequential absorption of two or more photons (mostly near infrared) and the emission at shorter wavelength (VIS). The population of the emitting state occurs solely over metastable, discrete energy levels with a relative high efficiency compared to simultaneous two-photon absorption and second-harmonic generation, two other Anti-Stokes processes [1, 2].

Several characteristics of upconversion emphasize their suitability for biological applications. There are at least two emission peaks suitable for referenced measurements, i.e. measurements are independent of excitation power and there is no need for an additional reference material, UCLNPs are non-toxic unlike heavy metal-containing quantum dots, and do not photobleach unlike organic fluorophores. Also, excitation using near infrared instead of ultraviolet or visible results

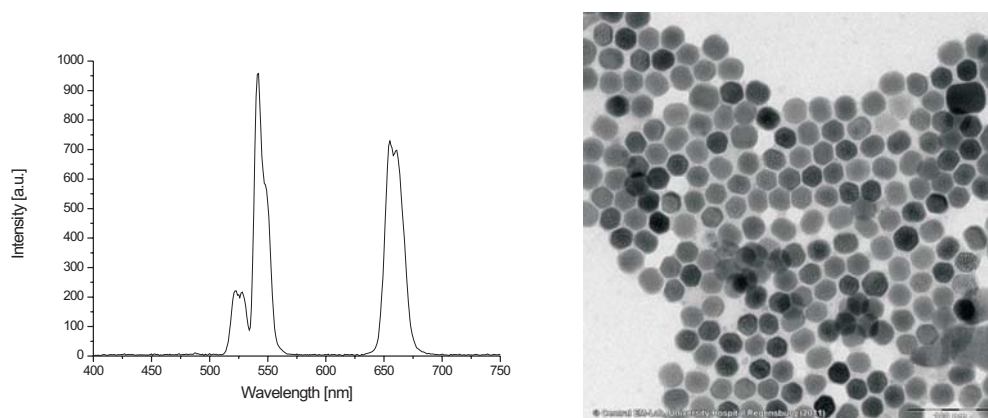

Fig. 1. *Left:* Emission spectrum of NaYF₄:Yb,Er nanoparticles. *Right:* TEM image of UCLNPs.

in several advantages like deep penetration into biological tissue, low background autofluorescence of biomolecules and low photodamage of tissue [3].

Most materials displaying photon upconversion consist of a host material with low phonon energy and one or more dopants enabling the upconversion process. Oxides and halides were used as host materials with fluorides showing the lowest phonon energy. The dopants of choice for high upconversion efficiency are trivalent lanthanide ions which determine the absorption and emission wavelengths of the host/dopants system. Ytterbium (Yb³⁺) absorbs light of 980 nm and transfers the energy to the emitting ions. These can be erbium (Er³⁺) or holmium (Ho³⁺) which entails emission in the green and red spectrum or thulium (Tm³⁺) with emission bands in the blue and red spectrum. A host/dopants system showing the highest upconversion efficiency is NaYF₄:Yb, Er (Fig. 1). All these materials can either be in the bulk phase or in the nanoscale (upconverting luminescent nanoparticle UCLNP, Fig. 1) [4].

There are many fields of application of the UCLNPs in biological and medicinal science. There were several studies in this regard like photodynamic therapy [5], *in vivo* bioimaging [6], *in vitro* detection and FRET based sensing [3]. Another application of high interest is their use as thermometers in the nanoscale [7]. The feasibility and the temperature resolution attainable were studied recently by our working group with a ratiometric evaluation method.

High biocompatibility of the nanoparticles and low tendency to aggregate are requirements for biological applications. Biocompatibility includes a low cytotoxicity and the prevention of any detrimental effects on the biological

environment like denaturation of proteins or the addition of proteins to the particle surface. Aggregation of upconverting luminescent nanoparticles may occur due to surface interactions and a low stability of the dispersion. This process can result in precipitation and, thus, in sedimentation, a decreased spatial resolution or even in the uselessness of the particles. Therefore, a stable colloid is one of the main challenges during the synthesis and subsequent surface modification of the particles. The prevention of aggregation as well as high compatibility can probably be achieved by surface modifications like a silica shell around the particles or ligand exchanges [8]. Another approach to obtain a biocompatible particle is building a biomimetic shell. A promising material for this method is viral capsids, an outer part of a virus.

Capsids are the protein cage of virions, the extracellular form of a virus, containing the viral DNA/RNA. They are built by self-assembly of the protein subunits, the so called capsomers, around the 'nucleation grain', i.e. the DNA/RNA. Their morphology, i.e. their outer appearance, depends on the symmetry of the capsid. For example, helical symmetry results in a rod-shaped form and icosahedrons are quasi-spherical. These almost spherical constructs have an inner cavity where the genomic material is stored. This cavity is the target for different synthetic modifications or functionalities like encapsulation or reaction chambers [9].

The replacement of the material by non-genomic material, e.g. functionalized polymer, enzyme, nanoparticles, forms a so called virus-like particle (VLPs). There are several approaches to achieve this replacement: the synthesis of the non-genomic material inside the cavity after enclosing the starting materials in the assembled capsid, the self-assembly of the capsomers around the non-genomic material (encapsulation) or the covalent bonding of the material to the capsomers and the following self-assembly [9].

We have employed an icosahedral virus (Fig. 2) for the encapsulation of photon upconverting nanoparticles. In general, non-genomic material suitable for encapsulation has to meet two requirements. First, the material must not be larger than the cavity of the virus although small deviations to larger diameters are acceptable. Second, it has to have a negatively charged surface to imitate the DNA/RNA, i.e. the 'nucleation grain'. The synthesis of VLPs with gold nanoparticles [10] and quantum dots [11] was successfully carried out employing the second approach.

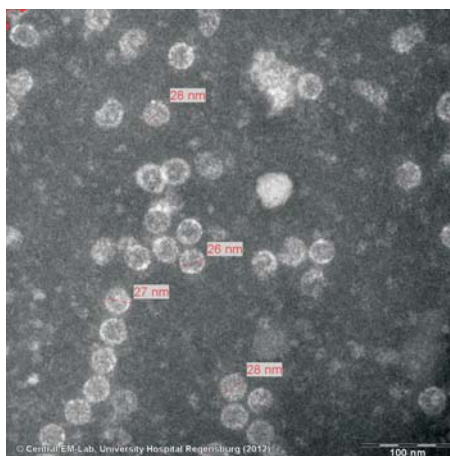

Fig. 2. TEM image of an icosahedral virus (staining agent: tungstophosphoric acid).

The virus-like particles with a photon upconverting nanoparticle core combines the advantages of upconversion with the high biocompatibility of virus capsids and are thus of high interest for biological or medical applications like *in vivo* imaging, phage display or targeting/labeling after functionalization with antibodies.

References

- [1] Auzel F.: *Chem. Rev.* **104** (2004), 139–173.
- [2] Gamelin D.R., Güdel H.U.: *Acc. Chem. Res.* **33** (2000), 235–242.
- [3] Wang F., Liu X.: *Chem. Soc. Rev.* **38** (2009), 976–989.
- [4] Haase M., Schäfer H.: *Angew. Chem. Int. Ed.* **50** (2011), 5808–5829.
- [5] Qian H.S., Guo H.C., Ho P.C.L., Mahendran R., Zhang Y.: *Small* **5** (2009), 2285–2290.
- [6] Nyk M., Kumar R., Ohulchanskyy T.Y., Bergey E.J., Prasad P.N.: *Nano Lett.* **8** (2008), 3834–3838.
- [7] Sedlmeier A., Achatz D.E., Fischer L.H., Gorris H.H., Wolfbeis O.S.: submitted (2012).
- [8] Liebherr R.B., Soukka T., Wolfbeis O.S., Gorris H.H.: submitted (2012).
- [9] Aniyagyei S.E., DuFort C., Kao C.C., Dragnea B.: *J. Mater. Chem.* **18** (2008), 3763–3774.
- [10] Chen C., Daniel M.-C., Quinkert Z.T., De M., Stein B., Bowman V.D., Chipman P.R., Rotello V.M., Kao C.C., Dragnea B.: *Nano Lett.* **6** (2006), 611–615.
- [11] Dixit S.K., Goicochea N.L., Daniel M.-C., Murali A., Bronstein L., De M., Stein B., Rotello V.M., Kao C.C., Dragnea B.: *Nano Lett.* **6** (2006), 1993–1999.

SPME-LC/MSⁿ for the Analysis of Selected Biologically Active Compounds

JUSTYNA WALCZAK, MAŁGORZATA SZULTKA, BOGUSŁAW BUSZEWSKI

*Department of Environmental Chemistry and Bioanalytics, Faculty of Chemistry,
Nicolaus Copernicus University
Gagarin Str. 7, 87-100 Torun, Poland, ✉ walczak_justyna@wp.pl*

Keywords

antibiotics

drug monitoring

high performance liquid chromatography

mass spectrometry

solid phase microextraction

Metabolomics applications require sample preparation methods that are fast, reproducible and able to extract a wide range of analytes of differing polarities. The measurement of drug levels in biological fluids is the corner stone for drug discovery and development as well as for pharmacodynamic, pharmacokinetic studies and drug monitoring. The most relevant matrices to be analyzed for this purpose are plasma or blood, due to providing a good correlation between their concentration and pharmacological effects. Sample preparation is frequently done *off-line* and this is often a limiting step to perform fast bioanalysis. The introduction of *on-line* sample pretreatment would greatly speed up the analyses. The choice of an appropriate sample extraction technique is very important step for metabolomic studies. For metabolomic analyses, the analytical technique must therefore be really suitable for a diverse range of small endogenous metabolites in various concentrations. *In vivo* solid phase microextraction (SPME) provides an interesting new complement to the range of technologies currently being employed for *in vivo* analysis of living systems. Solid phase microextraction can match the selectivity and sensitivity for improved time resolution of sampling.

Polypyrrole, polythiophene, and poly(3-alkylthiopenes) SPME coatings with a molecular imprint were used and evaluated their ability to extract selected

drugs from different classes with different physicochemical properties and of widely varying polarities. Mass spectrometric parameters were optimized for target compound in positive ion mode over the m/z 100–1000 range. Quantitation was done using multiple reaction monitoring mode to monitor precursor ion at $[M+H]^+$ to product ion transition of m/z 366 \rightarrow 349 for amoxicillin, 332 \rightarrow 288 for ciprofloxacin, 478 \rightarrow 322 for gentamycin, 338 \rightarrow 296 for linezolid, 172 \rightarrow 128 for metronidazole. The results demonstrate the potential of *in vivo* SPME as a useful sample preparation tool for chromatographic based metabolomics drug monitoring in the biomedical application from patients receiving therapeutic dosages.

Acknowledgments

This work was supported by National Science Center (Cracow, Poland), no. 2011/01/N/ST4/03178 and CHEMO-KOP no. 49/2011.

Temperature Effect on the Sorption Selectivity of Some Phenolic Acids on Molecularly Imprinted Stationary Phases

NATALIA DENDERZ, JOZEF LEHOTAY

*Institute of Analytical Chemistry, Faculty of Chemical and Food Technology,
Slovak University of Technology in Bratislava,
Radlinskeho 9, 812 37 Bratislava, Slovak Republic ✉ natalia.denderz@stuba.sk*

Keywords

liquid chromatography
molecularly imprinted polymers
phenolic acids
van't Hoff equation

Recently, a great deal of emphasis has been placed on the development of molecularly imprinted polymers. The term molecularly imprinted polymers stands for very attractive man-made materials with defined molecular recognition and predetermined selectivity for the specific analyte, named template [1, 2].

In the presence of the template there are creating synthetic recognition sites, tailor-made by the copolymerization of crosslinking monomer and at least one functional monomer. After a polymerization process the template molecule is removed leaving three-dimensional cavities. Prepared binding sites possess a steric (in size and shape) and chemical (spatial arrangement of complementary functional groups) memory for one structure or group of structures on which was designed [3].

At present time, the importance of molecularly imprinted polymers is growing up due to many reasons. Their advantage is that they are very selective, cheap, easy to prepare and they have special chemical and physical properties, which guarantee them a good stability over a wide range of experimental conditions and solvents [1].

The large interest of molecularly imprinted polymers has progressed mainly in chemistry and biology, but its preparation is of importance also for philosophy of science because it enables to get closer to the nature. Currently, there are a lot of examples of molecularly imprinted polymers application as stationary phases, sorbents, or synthetic receptors in liquid chromatography, capillary electrophoresis, capillary electrochromatography, solid-phase extraction, solid-phase microextraction or chemical sensors [4–8].

Our work was devoted to determination of temperature-dependence of retention factors of tested analytes in acetonitrile (porogen) and methanolic eluents. By examining the temperature dependence of retention we can determine the retention mechanisms as enthalpically or entropically driven [9]. The extent in the retention of analytes on stationary phases under given conditions is determined by the retention factors, k_i and the distribution of the solute between the mobile and stationary phases is defined by the standard free energy change, ΔG_i° . Combination of these two quantities over a sufficiently broad temperature range is commonly used to investigate recognition mechanisms in chromatography as a van't Hoff analysis. If the chromatographic retention is specified as a partitioning process between two phases, the temperature dependence on retention should be modelled by the van't Hoff plot [10, 12]

$$\ln k_i = -\frac{\Delta H_i}{RT} + \frac{\Delta S_i}{R} + \ln \varphi \quad (1)$$

where k_i is the retention factor; ΔH_i is the partial molar enthalpy of transfer [kJ mol^{-1}], ΔS_i is the partial molar entropy of transfer [$\text{J mol}^{-1}\text{K}^{-1}$], R is the gas constant [$8,314 \text{ J mol}^{-1}\text{K}^{-1}$], T is the absolute temperature [K], and φ is the phase ratio (the ratio of stationary and mobile phase volumes, V_s and V_M respectively, within the column) [4].

The aim of present study was an examination of thermodynamic parameters of the molecular recognition in order to understand the sorption mechanisms on prepared molecularly imprinted polymers. As templates the following phenolic compounds were used: gallic, gentisic, syringic, protocatechuic, 4-hydroxybenzoic, and vanillic acids (Fig. 1). The functional monomer was acrylamide.

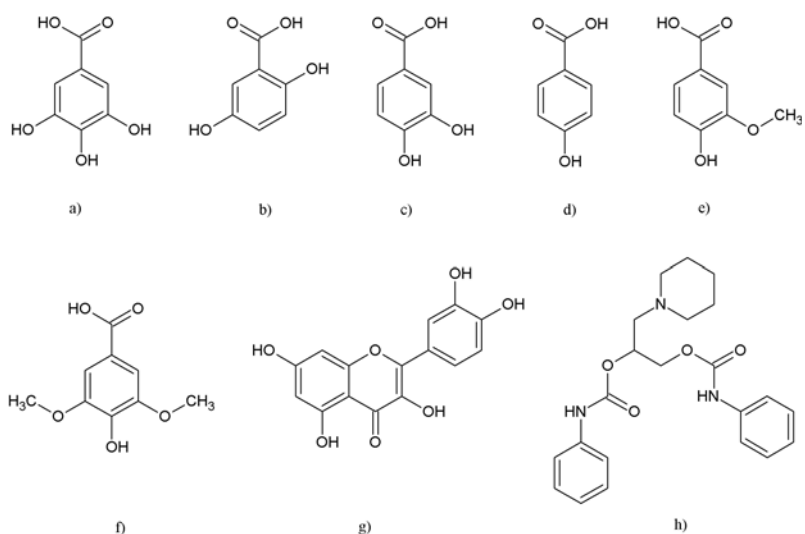

Fig. 1. Structures of analytes used in the study: (a) gallic acid, (b) gentisic acid, (c) protocatechuic acid, (d) 4-hydroxybenzoic acid, (e) vanillic acid, (f) syringic acid, (g) quercetin, and (h) dipiperodon.

Acknowledgments

This work was supported by the VEGA grants No. 1/0164/11.

References

- [1] Gholivand M.B., Karimian N., Malekzadeh G.: *Talanta* **89** (2012), 513–520.
- [2] Valtchev M., Palm B.S., Schiller M., Steinfeld U.: *J. Hazard. Mater.* **170** (2009), 722–728.
- [3] Hall A., Lanza-Sellergren F., Manesiotis P., Sellergren B.: *Anal. Chim. Acta* **538** (2005), 9–14.
- [4] Guo Z., Hao T., Shi L., Gai P., Duan J., Wang S., Gan N.: *Food Chem.* **132** (2012), 1092–1097.
- [5] Xu Z.X., Gao H.J., Zhang L.M., Chen X.Q., Qiao X.G.: *J. Food Sci.* **76** (2011), R69–R75.
- [6] Denderz N., Lehotay J., Čižmárik J.: *J. Chrom. A* **1235** (2012), 77–83.
- [7] Quaglia M., De Lorenzi E., Sulitzky C., Caccialanza G., Sellergren B.: *Electrophoresis* **24** (2003), 952–957.
- [8] Turiel E., Martin-Esteban A.: *J. Sep. Sci.* **32** (2009), 3278–3284.
- [9] Ogden P.B., Coym J.W.: *J. Chrom. A* **1218** (2011), 2936–2943.
- [10] Haidacher D., Vailaya A., Horváth C.: *PNAS* **93** (1996), 2290–2295.
- [11] Coym J.W.: *J. Sep. Sci.* **31** (2008), 1712–1718.
- [12] Chester T.L., Coym J.W.: *J. Chrom. A* **1003** (2003), 101–111.

Functionalized Dendrimer Stationary Phases on Silica Gel for Ion Chromatography

MAGDALENA JAĆKOWSKA, BOGUSŁAW BUSZEWSKI

*Department of Environmental Chemistry and Bioanalytics, Faculty of Chemistry,
Nicolaus Copernicus University
Gagarin Str. 7, 87-100 Torun, Poland, ✉ mgdjackowska@gmail.com*

Keywords

anion exchanger
dendrimer-bonded silica surfaces
ion chromatography

Ion chromatography is one of the most often applied techniques in the laboratories all over the world. Since ion chromatography offers many possibilities of application it is used in different branches of current analytical chemistry. This method is fast, cheap, giving good reproducibility of the results, and what is the most important, providing the qualitative and quantitative results as well.

To develop this method it is necessary to look for new solutions reduce of the detection limits, improving the efficiency of analytical systems, the quality of the separation of the components of a mixture and selectivity. At present search modern stationary phases of high ion exchange capacity, which permit for the analysis of samples large concentration and contain considerably disproportions in concentrations of particular ions. The aim of current science is to build systems simulating the behaviour of real ones. Recently very popular are dendrimer-bonded silica surfaces. Unlike classical polymers, dendrimers have a high degree of molecular uniformity, narrow molecular weight distribution, specific size and shape characteristic and a highly-functionalised terminal surface which features render them suitable candidates for the production of homogenous, highly functionalised chromatographic surfaces.

The main purpose of this paper was to present the method to obtain new stationary phase for the ion chromatography. A novel ion-exchanger was prepared

by chemically modification of surface of silica gel carrier. A multilayer structure (Joshua Tree) was formed during the process. As the monomers: 1, 4-butanediol diglycidyl ether and methylamine were used. The new anion exchanger for the determination of inorganic anions was subjected physico-chemical characterization: ^{29}Si CP/MAS NMR and FT-IR and elemental analysis.

Acknowledgments

This work was supported by European Social Found, Polish National Budget, Kuyavian-Pomeranian Voivodeship Budget (within Sectoral Operational Programme Human Resources) 'Krok w przyszłość IV' and Nicolaus Copernicus University grant no. 1115-Ch.

Electrocatalytic Oxidation of Unsaturated Hydrocarbons Mediated by Phthalocyanine Derivate

MONIKA KLUSÁČKOVÁ^{a, b}, PAVEL JANDA^a

^a *J. Heyrovský Institute of Physical Chemistry, Academy of Sciences of the Czech Republic, v.v.i., Dolejškova 3, 182 23 Prague 8, Czech Republic* ✉ monika.klusackova@jh-inst.cas.cz

^b *Department of Analytical Chemistry, Faculty of Science, Charles University in Prague, Albertov 6, 128 43 Prague 2, Czech Republic*

Keywords

atomic force microscopy
backscattering spectroscopy
cyclic voltammetry
phthalocyanine
unsaturated hydrocarbons

The oxidation of ethylene and propylene respectively, mediated by thin layer *N,N',N'',N'''*-tetramethyltetra-3,4-pyridinoporphyrazinocobalt, simply called CoTmt-3,4-ppa, deposited on basal plane of highly ordered pyrolytic graphite (HOPG) was studied in aqueous phosphate buffer phosphate solution by cyclic voltammetry, backscattering spectroscopy and atomic force microscopy. Our interest has been focused on optimizing conditions of electrocatalytic oxidation unsaturated hydrocarbon on electrode modified by pyridinoporphyrazine.

The complex CoTmt-3,4-ppa as a heterocyclic derivate of metallophthalocyanines [1, 2] is water soluble due to the positive charge localized on the porphyrazine cycle and shows lower tendency to form aggregates in solution [1, 3]. CoTmt-3,4-ppa can form thin electrically conducting films on the electrode surface after reduction of the central metal [4, 5]. It can act as an electron transfer mediator between the electrode surface and analyte in solution in our case of ethylene and propylene. In this work we modified electrode surface by two different deposition techniques: adsorption and electrochemical deposition, that just lead to the deposition of an insoluble film on electrode surface.

The highly ordered pyrolytic graphite used in this work as a working electrode is a special type of graphite material [6] with the advantage of well-defined structure, atomically flat surface, easily renewable surface by removing several layers of the surface with using adhesive (Scotch) tape. It represents an excellent electrode material suitable for characterization by atomic force microscopy respectively.

We demonstrate that HOPG with deposited thin layer CoTmt-3,4-ppa displays electrocatalytic activity towards the oxidation of both ethylene and propylene, respectively. We report on the interaction of ethylene and propylene with reduced form of the CoTmt-3,4-ppa complex involving metal centre and ligand catalytic activity. During cyclic voltammetry on modified electrode surface irreversible anodic peaks of ethylene and propylene were observed in the potential range corresponding to redox couple of the complex CoTmt-3,4-ppa. Influence of pH and thickness of the deposit on electrode surface on oxidation unsaturated hydrocarbon were observed. The electrochemical behavior has been completed by *in situ* backscattering spectroscopy that confirms the interaction of CoTmt-3,4-ppa with ethylene and propylene. The change in nanomorphology of the surface reacting with unsaturated hydrocarbon (Fig. 1b) compared to argon atmosphere (Fig. 1a) and the thickness of the film on the electrode surface have been examined *ex situ* by atomic force microscopy.

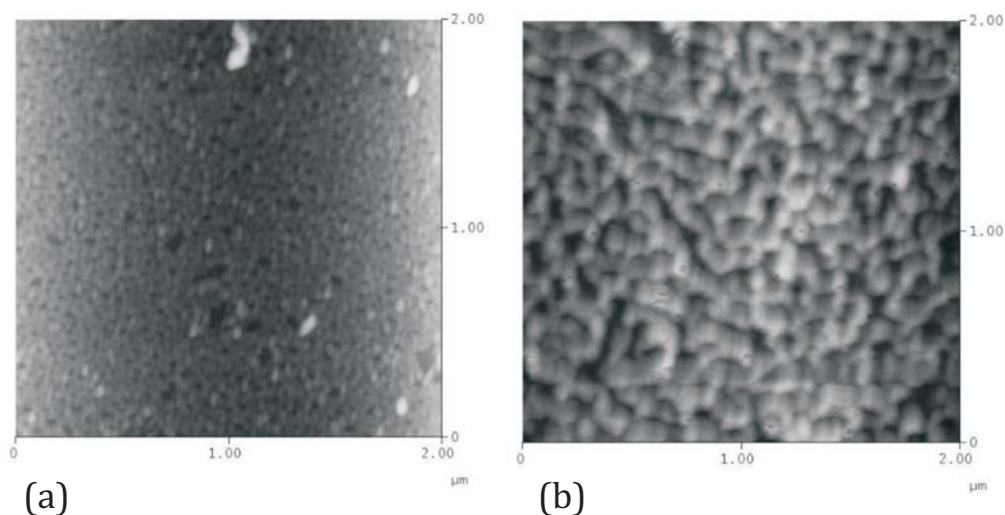

Fig. 1. *Ex situ* AFM image of the basal plane HOPG modified by CoTmt-3,4-ppa with successive subject to (a) argon atmosphere, compared to (b) propylene atmosphere.

Acknowledgments

We are grateful to Yu-Hong Tse, York University, Toronto for supply of CoTmtppa used in this work. This work was supported by the research project MSM0021620857, grant project SVV-2012-265201 of Charles University in Prague.

References

- [1] Chen J., Zhang J., Tse Y.H., Janda P., Christendat D., Lever A.B.P.: *J. Porphyrins Phthalocyanines* **10** (2006), 1238–1248.
- [2] Zhang J., Tse Y.H., Pietro W.J., Lever A.B.P.: *J. Electroanal. Chem.* **406** (1996), 203–211.
- [3] Thamae M.A., Nyokong T.: *J. Electroanal. Chem.* **470** (1999), 126–135.
- [4] Tse Y.H., Janda P., Lever A.B.P.: *Anal. Chem.* **66** (1994), 384–390.
- [5] Janda P., Weber J., Dunsch L., Lever A.B.P.: *Anal. Chem.* **68** (1996), 960–965.
- [6] Chang H., Bard A.J.: *Langmuir* **7** (1991), 1143–1153.

Chiroptical Spectroscopy of Human Blood Plasma in Clinical Diagnosis

MICHAL TATARKOVIČ, VLADIMÍR SETNIČKA

Department of Analytical Chemistry, Institute of Chemical Technology Prague, Technická 5, 166 28 Prague 6, Czech Republic ✉ michal.tatarkovic@vscht.cz

Keywords

blood plasma

cancer

chiroptical spectroscopy

spectral marker

Biological fluids, such as blood plasma, serum and serum ultrafiltrate [1] have been widely investigated by molecular spectroscopy methods in order to establish new, minimally-invasive, rapid, reliable and relatively inexpensive screening methods in the clinical diagnosis of various diseases – neurodegenerative, cancerous and others [2–4]. Blood plasma probably has the highest potential because it is relatively easy to obtain and contains many dissolved peptides, proteins and other biomolecules, among others those causing or indicating several diseases [2–4]. The methods newly introduced in the last decade for such investigations are Raman, infrared and fluorescence spectroscopy [1–6]. However, to the best of our knowledge, the advanced chiroptical variants (ECD, Electronic Circular Dichroism, and ROA, Raman Optical Activity) of above mentioned methods have never been used for analyzing the real clinical blood-based samples. Chiroptical methods are among the few methods inherently sensitive to the 3D structure of chiral biomolecules [7, 8] that is a big advantage compared to their common (unpolarized) variants. Furthermore, chiroptical methods have probably a potential for the detection of slight conformational and stereochemical changes in the secondary and tertiary structure of biomolecules, which occur during the above mentioned diseases.

We tested possibilities of chiroptical methods for the prospective diagnosis of cancer and neurodegenerative diseases, based on the analysis of blood plasma

samples. The blood of healthy controls and patients with colon cancer was collected by venipuncture and plasma was immediately frozen ($-75\text{ }^{\circ}\text{C}$). The ECD spectra were measured directly after thawing frozen samples at ambient temperature and also after dilution them by a phosphate buffer ($\text{pH} = 7.4$) in 0.01 mm quartz cuvette. Unfortunately, the blood plasma had a very strong fluorescence background in ROA/Raman spectroscopy; therefore, we had developed the methodology how to suppress it [9]. We were able to reduce fluorescence background ten times. However, the spectral baselines had to be further improved by correction using Fourier filtering procedure [10]. The ECD and ROA spectra were evaluated by multidimensional statistical methods (PCA, LDA).

Our preliminary results suggest that the human blood plasma can be successfully measured by both the ECD and ROA methods. We observed the spectral differences between the blood samples of healthy controls and the colon cancer patients. Therefore, these methods can potentially be useful for following research in the development of new, minimally-invasive screening methods of clinical diagnostics of colon cancer and maybe other diseases in future.

Acknowledgments

The work was supported by the Prague Operational Programme for Competitiveness (Grant No. CZ.2.16/3.1.00/22197); the Ministry of Health of the Czech Republic (Grant No NT13259); the Ministry of Education, Youth, and Sports of the Czech Republic (Grant No MSM6046137307); Specific University Research MSMT No 21/2012 - A1_FCHI_2012_003 and A2_FCHI_2012_015.

References

- [1] Lasch P, Kneipp J.: *Biomedical Vibrational Spectroscopy*. Wiley 2008.
- [2] Burns D.H., Rosendahl S., Bandilla D., Maes O.C., Chertkow H.M., Schipper H.M.: *J. Alzheimer's Dis.* **17** (2009), 391–397.
- [3] Griebel M., Daffertshofer M., Stroick M., Syren M., Ahmad-Nejad P., Neumaier M., Backhaus J., Hennerici M.G., Fatar M.: *Neurosci. Lett.* **420** (2007), 29–33.
- [4] Ahmed S.S.S.J., Santosh W., Kumar S., Thanka Christlet T.H.: *Vib. Spectrosc.* **53** (2010), 181–188.
- [5] Mizuno A., Kitajima H., Kawachi K., Muraishi S., Ozaki Y.: *J. Raman Spectrosc.* **25** (1994), 25–29.
- [6] Huang Z., McWilliams A., Lui H., McLean D.I., Lam S., Zeng H.: *Int. J. Cancer* **107** (2003), 1047–1052.
- [7] Berova N., Nakanishi K., Woody R.: *Circular Dichroism. Principles and Applications*. Wiley 2000.
- [8] Barron L.D., Hecht L., Blanch E.W., Bell A.F.: *Prog. Biophys. Mol. Biol.* **73** (2000), 1–49.
- [9] Tatarkovič M., Fišar Z., Raboch J., Jiráček R., Setnička V.: *Chirality* (2012), in press.
- [10] Člupek M., Matějka P., Volka K.: *J. Raman Spectrosc.* **38** (2007), 1174–1179.

Fast Non-Aqueous Capillary Electrophoresis in Short Capillaries with Amperometric End-Column Detection

JONAS MARK, FRANK-MICHAEL MATYSIK

Institute of Analytical chemistry, Chemo- and Biosensors, University of Regensburg, Universitätsstrasse 31, 93040 Regensburg, Germany, ✉ jonas.mark@chemie.uni-regensburg.de

Keywords

amperometric detection

end-column

fast separation

high-throughput

non-aqueous capillary electrophoresis

Research on separations using short conventional capillary pathways at high field strengths is receiving increased interest due to the possibility of achieving rapid and inexpensive analyses with potential for high-throughput applications. The concept can be especially useful for monitoring reaction kinetics or for implementation into multidimensional systems. Coupling the short capillaries to electrochemical detection offers the possibility to construct highly miniaturized and independent analysis devices as power consumption and component size are comparatively low [1, 2].

A system for combining the advantages of short capillary electrophoresis and amperometric detection within an automated device is presented. An electrochemical cell made from PTFE is used to align short capillaries (4 to 10 cm) with homemade Pt-microelectrodes in the end-column detection mode. The use of non-aqueous acetonitrile based buffer systems offers some advantages like better electrochemical response and faster separations. In order to achieve high-throughput separations, the cell is placed in a homemade autosampling unit and injection occurs in a vertical positioning of the capillary. As the injection plug

length has to be kept at a narrow level, especially using such short capillaries, different injection protocols (for example tapered capillary tips) are investigated. In addition to that, a range of different capillary inner diameters (5 to 50 μm) were tested and evaluated for applicability. A variety of effects like potential shift under influence of high voltage fields are examined and the method is optimized using a model system consisting of ferrocene, its derivatives and other electrochemically active substances. In this manner, a continuous sequence of fast and reproducible electrophoretic measurements is possible. This method will allow in the near future the construction of a miniaturized, fully portable device with point-of-care applicability.

References

- [1] Opekar F, Coufal P, Stulik K.: *Chem Rev.* **109** (2009), 4487–4499.
- [2] Matysik F. M.: *Anal. Bioanal. Chem.* **397** (2010), 961–965.

Spectroelectrochemical Study of 4-Aminobenzenethiol Adsorbed on Gold, Silver and Copper Nanostructured Surfaces

MARCELA DENDISOVÁ, LUKÁŠ HAVRÁNEK, PAVEL MATĚJKA

Department of Analytical Chemistry, Institute of Chemical Technology Prague, Technická 5, 166 28 Prague 6, Czech Republic ✉ *Marcela.Dendisova@vscht.cz*

Keywords

4-aminobenzenethiol
in-situ spectroelectrochemistry
SERS

4-aminobenzenethiol can form self-assembled monolayers via its thiol group on appropriate metal surfaces (Fig. 1). The Surface-Enhanced Raman Scattering (SERS) has become an appropriate technique to study layers on metal/solution surface/interface. Raman spectra of analytes adsorbed on nanostructured surfaces of coinage metals can be enhanced by factor 10^5 or higher [1, 2], but only under certain conditions: The analyte molecules have to be adsorbed to the surface or located in its close vicinity. Roughness of metal surface has to be in nano- and/or micro-scale level.

The suitable method for approaching nanostructured surface is electrochemical roughening using cathodic metal coating of suitable substrate or oxidation-reduction cycles when both surface morphology and the corresponding enhancement factor are changing. The enhancement factor depends on several effects, e.g. applied potential, excitation wavelength, surface coverage, and surface morphology [3]. The resulting enhancements of surface Raman signals of adsorbed molecules arise from two main aspects: physical and chemical enhancement mechanisms. The so-called electromagnetic mechanism is

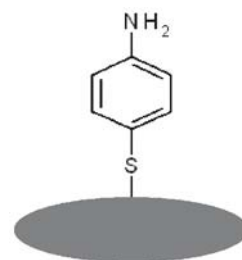

Fig. 1. Bound of 4-aminobenzenethiol on a metal surface.

considered as the main contribution to the SERS effect. Chemical enhancement can be caused for example by photoinduced charge transfer mechanism, tautomerization of benzoid or the charge tunnelling enhancement mechanism [4]. Raman bands corresponding to the modes perpendicular to the surface are significantly enhanced. Thiol group of 4-aminobenzenethiol interacts strongly with the metal surface and covalent bond is formed usually between surface atoms and sulphur atom [4]. Furthermore, 4-aminobenzenethiol can react to a new azobenzene compound by catalytic coupling reaction on silver nanoparticles [5, 6]. A similar behaviour was observed probably on gold nanostructures [5]. The formation of the azobenzene should be indicated by observation of intense bands about 1142, 1392 and 1439 cm^{-1} .

The nature and re-orientation of molecule adsorbed on SERS-active nanostructured surfaces (Au, Ag, or Cu) can be readily determined by electrochemical surface-enhanced Raman scattering spectroscopy [7]. The combination of SERS spectroscopy and electrochemistry allows much more comprehensive studying of adsorption processes, enabling to tune the conditions of analyte sorption onto metal surface by changing the experimental electrochemical parameters. In this study, the electrochemical cell was used for electrochemical SERS study of 4-aminobenzenethiol adsorbed on gold, silver and copper substrates to demonstrate that adsorption of 4-aminobenzenethiol is influenced by applied electrode potential and formation of azobenzene complex depends evidently on the kind of metal used. In our previous study aimed at enhancement factor calculation [1] we revealed that any azo-complex do not form from 4-aminobenzenethiol adsorbed on copper surface at 1064-nm excitation which can be explained either by the influence of the metal or the low energy excitation.

SERS-active large-scaled substrates were prepared by electrochemical (cathodic) metal coating of massive platinum target in two-electrode arrangement from electrochemical bath contained corresponding ions. Current sequences (based on previously published procedures [8–10]) include from two to five individual steps (Table 1). Surface morphologies were modified using oxidation-reduction cycle application.

All *in-situ* SERS spectra were collected using Raman spectrometer Dimension P2 (Lambda Systems, USA). The laser beam (785 nm) irradiating the surface of target through glass window was focused using a micrometer positioning device developed at our department. Measurement conditions as laser power and integration time were optimized for each tested metal. Number of repeated accumulations was always ten. Spectra were recorded with resolution better than 8 cm^{-1} .

Table 1

Current sequences used for large-scaled substrates preparation.

Substrate	Au		Ag		Cu	
	[Au(CN) ₂] ⁻		[Ag(NH ₃) ₂] ⁺		[Cu(NH ₃) ₄] ²⁺	
Step	<i>I</i> , mA	<i>t</i> , min	<i>I</i> , mA	<i>t</i> , min	<i>I</i> , mA	<i>t</i> , min
1	15	5	5	5	10	10
2	10	10	10	15	20	10
3	5	15	-	-	30	10
4	-	-	-	-	40	10
5	-	-	-	-	50	10

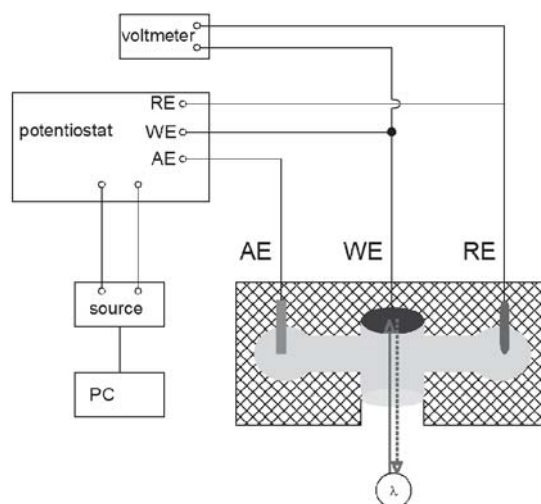
**Fig. 2.** Spectroelectrochemical cell

All measurements were performed in an electrode cell (Fig. 2) which was equipped with a salt bridge suitable for various reference electrodes, platinum plate and contact for SERS-active working electrode (massive metal target with diameter up to 10 mm coated with various SERS-active metal layers). Cyclic series of potentials were applied to working electrode in direction from ca. +100 mV to ca. -1100 mV and backward with a step of 100 mV; SERS spectra were recorded at each (stabilized during data accumulation) applied potential. Raman probe head was connected to the spectrometer via fibre optics. Electrolyte (aqueous 0.1 mol L⁻¹ K₂SO₄) contained 4-aminobenzenethiol (5 × 10⁻⁵ mol L⁻¹).

In *in-situ* SERS spectra recorded on **gold substrate** from 100 to -1100 mV we can observe maximal spectral intensity at potential values about -600 mV and lower. The bands of azobenzene compound at ca. 1142 and 1390 cm⁻¹ are clearly

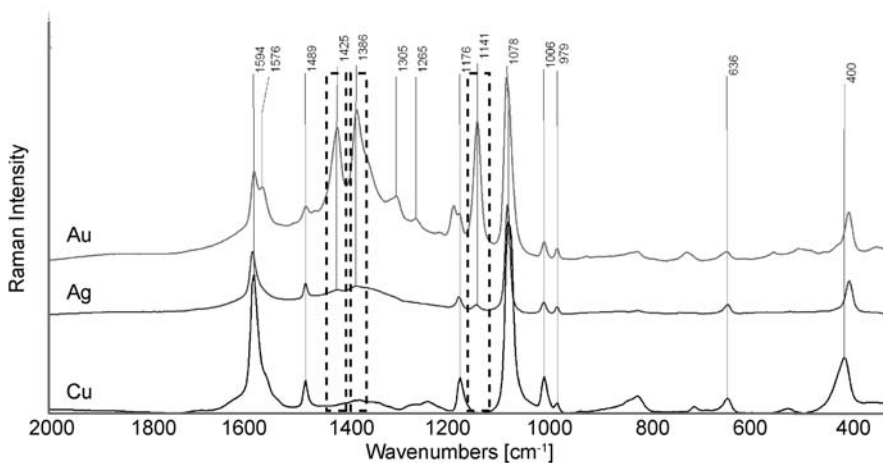

Fig. 3. *In-situ* surface-enhanced Raman scattering spectra of 4-aminobenzenethiol adsorbed on gold, silver, or copper surfaces measured at -700 mV.

evident (Fig. 3). Intensity of other characteristic vibration modes assigned to 4-aminobenzenethiol (e.g., at about 1080 cm^{-1} assigned to C-S vibration mode) increased to potential values about -600 mV and then increased very gradually. From the observations we can conclude that adsorption of 4-aminobenzenethiol is irreversible process, while azobenzene complex formation depends reversibly on potential. In spectra measured on **silver substrate** we can observe similar behaviour as in the case of gold substrate. Band intensities characteristic for azobenzene formation increased up to -700 mV and then decreased close to noise level. Bands intensity assigned to 4-aminobenzenethiol vibration modes increased too but their intensity did not decrease to the noise level. In the case of **copper substrate** no azobenzene bands (Fig. 3) were observed at any electrode potential. That means that photon-driven charge transfer mechanism does not contribute to the chemical mechanism and 4-aminobenzenethiol molecules are adsorbed to the copper substrate unchanged.

In the work we confirm formation of azo-complex produced by catalytic coupling reaction in the cases of gold and silver surfaces. The formation of the complex is not observed in the case of copper surface even at shorter wavelengths (785 nm) than 1064 nm . Thus, there is a crucial role of the metal on the photocatalytic formation of azobenzene surface complex.

Acknowledgments

Financial support from specific university research (MSMT no. 21/2012 – A2_FCHI_2012_013) was gratefully acknowledged.

References

- [1] Dendisová-Vyškovská M., Prokopec V., Člupek M., Matějka P.: *J. Raman Spectrosc.* **43** (2012), 181–186.
- [2] Otto A., Mrozek I., Grabhorn H., Akemann W.: *J. Phys.-Condes. Matter* **4** (1992), 1143–1212.
- [3] Brolo A. G., Irish D. E., Smith B. D.: *J. Mol. Struct.* **405** (1997), 29–44.
- [4] Wu D. Y., Liu X. M., Huang Y. F., Ren B., Xu X., Tian Z. Q.: *J. Phys. Chem. C* **113** (2009), 18212–18222.
- [5] Canpean V., Iosin M., Astilean S.: *Chem. Phys. Lett.* **500** (2010), 277–282.
- [6] Wu D. Y., Zhao L. B., Liu X. M., Huang R., Huang Y. F., Ren B., Tian Z. Q.: *Chem. Commun.* **47** (2011), 2520–2522.
- [7] Roguska A., Kudelski A., Pisarek M., Lewandowska M., Kurzydłowski K. J., Janik-Czachor M.: *Surf. Sci.* **603** (2009), 2820–2824.
- [8] Prokopec V., Čejkova J., Matejka P., Hasal P.: *Surf. Interface Anal.* **40** (2008), 601–607.
- [9] Čejkova J., Prokopec V., Brazdova S., Kokaislova A., Matejka P., Stepanek F.: *Appl. Surf. Sci.* **255** (2009), 7864–7870.
- [10] Prokopec V., Dendisová-Vyškovská M., Kokaislová A., Čejková J., Člupek M., Matějka P.: *J. Mol. Struct.* **993** (2011), 410–419.

Voltammetric Determination of Fomesafen and Fluorodifen in Drinking Water and River Water

VÍT NOVOTNÝ, JAN MAŠKA, ETELA KOUKLÍKOVÁ, JIŘÍ BAREK

UNESCO Laboratory of Environmental Electrochemistry, Department of Analytical Chemistry, Faculty of Science, Charles University in Prague, Albertov 6/2030, 128 43 Prague 2, Czech Republic, ✉ novotny1@natur.cuni.cz

Keywords

Fomesafen
Fluorodifen
voltammetry
water

Introduction

The diphenyl ether herbicides Fomesafen and Fluorodifen, that are a focus of this work, are potent herbicides [1, 2]. As other diphenyl ethers they have unfortunately some unpleasant side-effects, including mast cell activation, teratogenesis and endocrine disrupting activity [3–5]. In addition, some of their metabolites are known to be possible mutagens [6, 7]. Compounds with similar structure exhibit toxicity toward aquatic organisms and interfere with blood formation [4]. The herbicide Fomesafen has been developed for the preemergence protection of beans, soybeans and cotton against weeds [8]. Although appropriate methods for the determination of diphenyl ether herbicides in the environment already exist, it still makes sense to develop new voltammetric methods. This is because substances of our interest do exhibit electrochemical activity [9] and electrochemical methods are cheap, easy and have low detection limits [10]. Silver solid amalgam electrodes poses these characteristics and have already proved suitable for the determination of trace amounts of pollutants [11, 12]. Our goal in this work is to develop sensitive and reliable methods for the determination of Fomesafen and Fluorodifen at meniscus modified silver solid amalgam electrode (m-AgSAE)

by finding the optimal conditions for the determination and testing the reliability of the method.

Chemicals

Fomesafen (98.7 %) and Fluorodifen (99.6 %) were used. The stock solution of Fomesafen ($c = 1 \times 10^{-3} \text{ mol L}^{-1}$) has been prepared by dissolving 0.0439 g of Fomesafen in 100 mL of methanol. The stock solution of Fluorodifen ($c = 1 \times 10^{-3} \text{ mol L}^{-1}$) has been prepared by dissolving 0.03290 g of Fluorodifen in 100 mL of methanol. Both were purchased from SigmaAldrich Laborchemikalien, Steinheim, Germany. Other used chemicals: boric acid, acetic acid (99%), phosphoric acid (85%), sodium hydroxide, potassium chloride all substances p.a., Lachema Brno, Czech Republic. Methanol p.a. (Merck, Germany) and deionized water (Millipore, USA) were used as solvents.

Apparatus

Measurements of pH were performed on a Jenway 3510 (Jenway, Essex, Great Britain) pH-meter with a combined glass membrane electrode (type 924 005) The electrode was calibrated by standard buffer solutions in water. The UV-VIS measurements were done using a HP 8453 (Hewlett Packard, Great Britain) diode-array spectrophotometer with a fused quartz cuvette with a thickness of 1 mm. Palmsens Electrochemical Sensor Interface (Palm Instruments BV, Ruitercamp, The Netherlands) and the PalmsensPC software were used for all voltammetric measurements. The software was running under the Windows XP (Microsoft Corp.) operating system.

Pulses of width of 100 ms and height of 50 mV were used while performing DPV. A polarization rate of 20 mV s^{-1} , and potential resolution of 5 mV were used. All measurements were performed using a three electrode system. A silver chloride electrode ($1 \text{ mol L}^{-1} \text{ KCl}$) type RAE 113, (Monokrystalý, Turnov, Czech Republic), a platinum wire auxiliary electrode and a meniscus modified silver solid amalgam electrode (Polaro Sensors, Prague, Czech Republic). The vacuum manifold and Lchrolut RP-18 E cartridges were purchased from Merck, Darmstadt, Germany.

Procedures

The stability of stock solutions was checked by UV-VIS spectrophotometric measurements. The stock solutions were stable for the duration of the experiments. The phosphate buffer of the desired pH was prepared by mixing the appropriate amounts of 1 mol L⁻¹ sodium hydroxide and 0.5 mol L⁻¹ phosphoric acid. Passivation of the electrode during DPV measurements of solutions containing Fomesafen was resolved by activating the electrode by 300×0,1 s pulses between the potentials 0 V and -500 mV. Passivation of the electrode while measuring Fluorodifen was resolved by activating the electrode by 300×0,1 s pulses between the potentials -200 mV and -1100 mV. Measured solutions of Fomesafen were prepared by mixing 1 mL phosphate buffer pH = 2.0 with 9 mL drinking water and then adding the appropriate amount of Fomesafen stock solution in methanol. Measured solutions of Fluorodifen were prepared by mixing 3 mL methanol eluate with 2 mL methanol and 5 mL BR buffer pH = 6.0. Values of points in calibration curves are arithmetic averages of three measurements done in newly prepared solutions. Error bars are the standard deviations of the same data. Detection limits are calculated according to the formula

$$LOD = 3.3 \sigma / S \quad (1)$$

where σ is the standard deviation of 10 measurements of the lowest concentration when the signal can still be evaluated, and S is the slope of calibration curve in the vicinity of that concentration [13]. The SPE cartridges were conditioned by passing 10 mL methanol and deionised water. 100 mL of sample of drinking water spiked with Fluorodifen was then passed through them. In order to elute the cartridges 3 mL of methanol was used.

Results and Discussion

The voltammograms of Fomesafen in a mixture of phosphate buffer pH = 2.0 and drinking water (1:9) can be found in Fig. 1. The calibration dependence of Fomesafen in the concentration range from 1×10⁻⁶ mol L⁻¹ to 2×10⁻⁷ mol L⁻¹ is in the inset. The calibration dependence is linear. Lower concentrations could not be reached because the signal is not meaningfully reproducible below 2×10⁻⁷ mol L⁻¹ concentration.

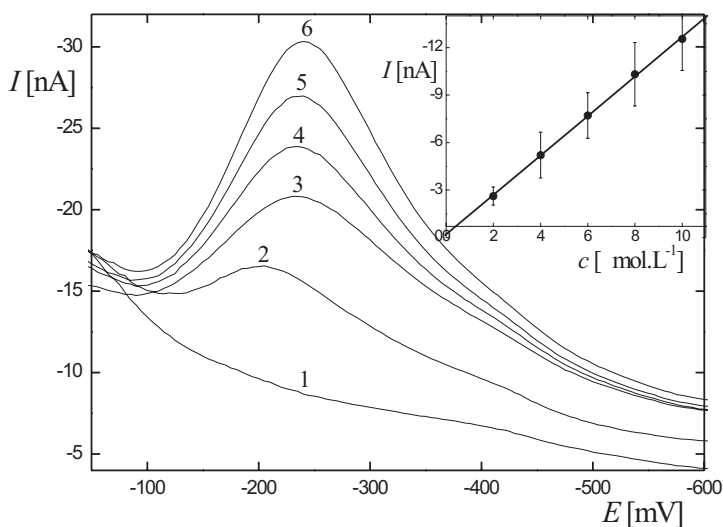

Fig. 1. Difference pulse voltammograms of Fomesafen at meniscus modified silver solid amalgam electrode in a mixture of phosphate buffer pH = 2.0 and drinking water 1:9. Fomesafen concentration in solution 0 (1), 2 (2), 4 (3), 6 (4), 8 (5) and 10 (6) $\mu\text{mol}\cdot\text{L}^{-1}$. The corresponding calibration straight line is in the inset.

The calibration dependence of Fluorodifen is linear and the intercept is not significantly different from zero, and detection limit is below 2×10^{-7} mol L⁻¹.

Conclusions

A method for the determination of Fomesafen in drinking water in the concentration range $2\text{--}100\times 10^{-6}$ mol L⁻¹ has been developed. The resulting calibration dependence is linear. The limit of detection achieved is 1.5×10^{-6} mol L⁻¹. A method for the determination of Fluorodifen in drinking water using SPE in the concentration range $2\text{--}10\times 10^{-7}$ mol L⁻¹ has been developed. The limit of detection achieved is below 1.0×10^{-7} mol L⁻¹. The calibration dependence is linear. The results for the determination of Fomesafen in drinking water in the concentration range $2\text{--}10\times 10^{-7}$ mol L⁻¹ and the methods for direct determination of Fomesafen and SPE assisted determination of Fluorodifen in river water will be presented.

Acknowledgments

Financial support of this work, provided by The Ministry of Education, Youth and Sports of the Czech Republic (project MSM 0021620857), Technological Agency of the Czech Republic (project TA01020565), Charles University in Prague (project SVV 2012-265201), and Grant Agency of the Czech Republic (project P206/12/G151), is gratefully acknowledged.

References

- [1] Jacobs J. M., Jacobs N. J., Sherman T. D., Duke S. O.: *Plant Physiol.* **97** (1991), 197–203.
- [2] Hallahan B. J., Camilleri P., Smith A., Bowyer J. R.: *Plant Physiol.* **100** (1992), 1211–1216.
- [3] Mastorakos G., Karoutsou E. I., Mizamtsidi M., Creatsas G.: *Endocrine* **31** (2007), 219–237.
- [4] Teshima R., Nakamura R., Nakajima O., Hachisuka A., Sawada J.-I.: *Toxicol. Lett.* **150** (2004), 277–283.
- [5] Takayasu H., Nakazawa N., Montedonico S., Puri P.: *J. Pediatr. Surg.* **42** (2007), 426–430.
- [6] Draper W. M., Casida J. E.: *J. Agric. Food Chem.* **31** (1983), 227–231.
- [7] Tanaka Y., Iwasaki H., Kitamori S.: *Water Sci. Technol.* **34** (1996), 15–20.
- [8] Santos J. B., Jakelaitis A., Silva A. A., Costa M. D., Manabe A., Silva M. C. S.: *Weed Research* **46** (2006), 284–289.
- [9] Rupp E. B., Zuman P., Šestáková I., Horák V.: *J. Agric. Food Chem.* **40** (1992), 2016–2021.
- [10] Barek J., Fischer J., Navrátil T., Pecková K., Yosypchuk B., Zima J.: *Electroanalysis* **19** (2007), 2003–2014.
- [11] Yosypchuk B., Barek J.: *Crit. Rev. Anal. Chem.* **39** (2009), 189–203.
- [12] Novotný V., Barek J.: *Chem. Listy* **103** (2009), 217–223.
- [13] Hayashi Y., Matsuda R., Ito K., Nishimura W., Imai K., Maeda M.: *Anal. Sci.* **21** (2005), 167–169.

Determination of Mycotoxins by Micro-SPE Coupled *on-line* with Micro-HPLC/LIF

DAMIAN GRZYWIŃSKI, MICHAŁ SZUMSKI, RENATA GADZAŁA-KOPCIUCH,
BOGUSŁAW BUSZEWSKI

*Department of Environmental Chemistry and Bioanalytics, Faculty of Chemistry,
Nicolaus Copernicus University
Gagarin Str. 7, 87-100 Torun, Poland, ✉ grzywinski.damian@wp.pl*

Keywords

aflatoxins
micro-HPLC/LIF
micro-SPE

Aflatoxins are a type of pathogens which can be found in agricultural food products. These mycotoxins are secondary metabolites produced by several species of fungi, such as *Aspergillus flavus* (which produces aflatoxin B₁ and aflatoxin B₂) and *Aspergillus parasiticus* (which produces aflatoxin B₁, B₂, G₁ and G₂). Aflatoxins are known to be mutagenic, carcinogenic and teratogenic compounds. The intake of these toxins over a long period of time in very low concentrations may be highly dangerous. It has been estimated that mycotoxin contamination may effect as much as 25% of the world's food crops each year.

There have been elaborated several methods for determination of aflatoxins in food. The aim of this work was develop an innovative system of micro-SPE coupled *on-line* with micro-HPLC/LIF. The designed system consists of two pumps delivering the mobile phases, a set of capillaries (extraction, separation, connecting capillaries), and a LIF detector (comprising a 355 nm laser, a photomultiplier, and an optical system of our own design). The capillary extraction columns were either packed with C₁₈ phase or molecularly imprinted polymeric monoliths. The main separation column was a 200 μm i.d. capillary packed with a cholesterol phase. Also, an attempt to synthesize a cholesteryl methacrylate monolithic column has been made.

Monolithic capillary extraction columns have been prepared in fused-silica capillaries in two-step process. First, a poly-TRIM monolith was photopolymerized, then it was modified by photografting by the mixture of methacrylic acid (MAA) as a functional monomer, ethylene dimethacrylate (EDMA) as a cross-linking agent, 5,7-dimethoxycoumarin (5,7-DMC) as a template, isooctane/toluene as a porogenic solvent and 2,2-azobis-(2-methylpropionitrile) (AIBN) as an initiator. Different thermal conditions and concentrations of the grafting mixture were tested. The extraction capillary columns were evaluated in the terms of their hydrodynamic and chromatographic properties. Retention coefficients for aflatoxin B₁ and 5,7-DMC were calculated in order to determine the selectivity and imprinting factor.

The on-line micro-SPE/micro-HPLC-LIF system allowed to extract and separate four aflatoxins from an aqueous sample and detect them on the picogram level. It was clearly demonstrated that MIP polymers are able to bind aflatoxins more effectively than NIP. The obtained experimental results successfully highlight the effectiveness of this method in routine analysis of environmental samples.

Acknowledgments

The work was financially supported by the Ministry of Science (Warsaw, Poland) grant number N N204 012038 and National Science Center (Krakow, Poland) grant no 2011/01/B/ST4/00543.

Analytical Methods Used in the Studies on Chemical Ecology of Termites

JANA KRASULOVÁ^{a, b}, ROBERT HANUS^b, DAVID SILLAM-DUSSÈS^b, PETR ŽÁČEK^{a, b},
PAVEL JIROŠ^b, JAN ŠOBOTNÍK^b, BLANKA KALINOVÁ^b, ZUZANA BOSÁKOVÁ^a,
IRENA VALTEROVÁ^b

^a Department of Analytical Chemistry, Faculty of Science, Charles University in Prague,
Albertov 6, 128 43 Prague 2, Czech Republic

^b Infochemicals, Institute of Organic Chemistry and Biochemistry, Academy of Sciences
of the Czech Republic,
Flemingovo nám. 2, 166 10 Prague 6, Czech Republic ✉ krasulova@uochb.cas.cz

Keywords

defensive compounds
GC-MS
GC×GC-MS
termites
trail-following pheromone

Chemical signals represent the main communication tool in termites. In view of the fact that termites are living in the permanent darkness of their nests and tunnels, all aspects of their social life are regulated by pheromones. Chemistry is also involved in termite defence; up to now, nearly 400 defensive compounds from different chemical classes were identified in termites, produced namely by the unique defensive gland of soldiers, the frontal gland [1]. In our current project, we aim at chemical communication and defensive chemistry of several termite genera from the families Rhinotermitidae and Serritermitidae. In my presentation, I review our recent results on the trail-following communication in the Neotropical termite *Glossotermes oculatus* (Serritermitidae) and the defensive chemistry of African sand termite *Psammotermes hybostoma* (Rhinotermitidae). The results are presented with emphasis on modern methods of analytical chemistry used to detect and identify semiochemicals and defensive compounds.

Firstly, we investigated the trail-following pheromone in *Glossotermes oculatus*. The trail-following pheromones, studied in more than 60 termite

species, belong to the most frequent chemical signals used by termites and their diversity is surprisingly low, with only 8 compounds being identified so far [2]. Using a combination of two-dimensional gas chromatography, preparative GC, electrophysiology and behavioural bioassays, we identified (10Z,13Z)-nonadeca-10,13-dien-2-one as the trail-following pheromone of *Glossotermes oculatus* [3]. Fragmentation pattern of EI mass spectrum, DMDS derivatization and knowledge of termite biosynthesis enabled us to propose the final structure which was subsequently confirmed by synthesis of the compound. The biological activity was verified in bioassays and the quantity of pheromone (hundreds of picograms to units of nanograms) in the sternal gland of one worker was determined using three different approaches.

Secondly, we studied the composition of the frontal gland secretion of soldiers in *Psammotermes hybostoma*. Using GC-MS analyses we indicated altogether 30 sesquiterpene hydrocarbons or their oxygenated derivatives in nine colonies from five localities [4]. Identification of sesquiterpenes is difficult due to similarity of their mass spectra so we compared retention indices and fragmentation patterns with published data [5] or with commercial or natural standards using SPME. The comparison of chemical diversity between particular colonies has revealed a considerable geographical variability.

I review our findings on the trail-following pheromone of *Glossotermes oculatus* and on the chemical composition of the defensive secretion in *Psammotermes hybostoma*. These findings belong to our current project focused on chemical ecology of critical termite genera from families Rhinotermitidae and Serritermitidae.

Acknowledgments

We are grateful for financial support to the Czech Science Foundation (No. P506/10/1570), to the Academy of Sciences, Czech Republic (RVO:61388963) and to the Grant Agency of the Charles University in Prague, projects SVV 2012265201 and MSM 0021620857.

References

- [1] Šobotník J., Jirošová A., Hanus R.: *J. Insect Physiol.* **56** (2010), 1012–1021.
- [2] Bordereau C., Pasteels J.M.: Pheromones and chemical ecology of dispersal and foraging in termites. In: *Biology of Termites, a Modern Synthesis*. Bignell D.E., Roisin Y., Lo N. (edits). Dordrecht, Springer 2011. p. 279–320.
- [3] Hanus R., Šobotník J., Krasulová J., Jiroš P., Žáček P., Kalinová B., Dolejšová K., Cvačka J., Bourguignon T., Roisin Y., Lacey M., Sillam-Dussès D.: *Chem. Senses.* **37** (2012), 55–63.

- [4] Krasulová J., Hanus R., Kotalová K., Šobotník J., Sillam-Dussès D., Tichý M., Valterová I.: *J. Chem. Ecol.* **38** (2012), 557–565.
- [5] Adams R. P.: *Identification of Essential Oil Components by Gas Chromatography/Mass Spectrometry*. Allured Publishing Corporation 2007.

Analytical Capabilities of Plasma Pencil in Atomic Emission Spectrometry

LUKÁŠ NOVOSÁD^a, ALEŠ HRDLIČKA^{a,*}, PAVEL SLAVÍČEK^b,
VÍTEŽSLAV OTRUBA^a, VIKTOR KANICKÝ^a

^a *Central European Institute of Technology, CEITEC MU, Department of Chemistry, Faculty of Science, Masaryk University, Kamenice 753/5, 62500 or Kotlářská 2, 61137 Brno, Czech Republic, ✉ ales2003h@centrum.cz*

^b *Department of Physical Electronics, Faculty of Science, Masaryk University, Kotlářská 2, 61137 Brno, Czech Republic*

Keywords

elements determination
low-cost
plasma pencil
sample introduction

Plasma pencil is a modern and unique tool developed for surface treatment of some archaeological artefacts. In fact it is a narrow quartz tube with an atmospheric pressure argon or helium radiofrequency (13.56 MHz) plasma jet. This plasma pencil was modified for chemical analysis of liquids by a fused inlet for sample aerosol introduction from the nebulizer into the plasma gas stream. This is a big challenge for development of a new low-cost analytical method of elements determination. Possibilities can be upgraded towards chemical analysis or to control the admixture composition. The admixture may then be helpful for sample treatment. The top of this work is the fact that the excitation capabilities of the discharge were proven. For this purpose sets of calibration standard water solutions containing Li, Ca, Mg, Zn, Cu ions, construction of calibration dependences in the range of concentrations from 1 to 100 mg/L and calculation of instrumental detection limits (3σ) for these elements were done. A sample was introduced by a system consisted of a peristaltic pump delivering 0.6 mL/min of the aqueous solution into a Scott chamber with a concentric nebulizer with efficiency about 6%. Carrier gas argon (0.3 L/min) flowing from the nebulizer transported this created aerosol perpendicularly into the main argon stream (4 L/min) flowing

directly to the plasma pencil. The electrical input power coming into the plasma should be between 120 and 140 W, which is necessary to maintain discharge stability in the case of water and sample load. Electron number densities and rotational temperatures (relatively low about 1000 K) for the discharge under and without water load were calculated using H_{β} line and OH spectra. Found excitation temperatures from argon lines ranged from 3000 to 4200 K. Intensities of the lines were acquired in 10 lateral positions along the tube from the aerosol inlet towards the discharge tail. Intensities of analytical lines were acquired in the same positions and an optimal position providing the best signal-to-noise ratio was for each line intensity was determined. These results are promising and mean that the analytical application of plasma pencil as a Liquid Chromatography detector or instead of e. g. Inductively Coupled Plasma Optical Emission Spectrometry (ICP-OES) for non-ultra trace analysis may be possible. Plasma pencil has lower investment and operational costs and thus possible higher economical profitability than ICP-OES.

Acknowledgments

This work was supported by the projects CEITEC – Central European Institute of Technology (CZ.1.05/1.1.00/02.0068) from European Regional Development Fund, and MSM0021622411 of the Ministry of Education, Youth and Sports of the Czech Republic.

New Types of Carbon Composite Film Electrodes Based on Various Metal Substrates for Determination of Genotoxic Environmental Pollutants

TEREZA RUMLOVÁ, VLASTIMIL VYSKOČIL, JIŘÍ BAREK

UNESCO Laboratory of Environmental Electrochemistry, Department of Analytical Chemistry, Faculty of Science, Charles University in Prague, Hlavova 2030/8, 128 43 Prague 2, The Czech Republic, ✉ rumlova@natur.cuni.cz

Keywords

carbon composite film electrodes
electrochemistry
voltammetry

A non-traditional carbon composite film electrode (CCFE) was developed as an alternative to commercially available screen-printed carbon electrodes compatible with the concept of 'green analytical chemistry' [1]. The main advantage of the CCFE is primarily its simple, fast and inexpensive preparation (the surface of classical solid working electrode is covered with carbon ink suspension – a mixture of carbon powder and polystyrene dissolved in an organic solvent – which is evaporated to dryness). The film can be easily removed by wiping it off by a filter paper and reformed by immersing the electrode surface into the carbon ink created from a carbon powder homogeneously mixed with some polymer dissolved in a solvent in an exact ratio. Renewing the film is a way how to eliminate the influence of the electrode history completely. The other advantages are its wide potential window in both cathodic and anodic regions (ca. 3 V span), high sensitivity and low noise and also the non-toxicity as compared with mercury electrodes [1].

In this contribution, electrochemical properties of the CCFEs based on non-traditional substrates for the carbon composite film deposition (aluminum, copper and tin) were investigated by cyclic voltammetry, and the electroanalytical

applicability of such sensors was tested by differential pulse voltammetry (DPV) using 4-nitrophenol as a model analyte. 4-nitrophenol is known as a hazardous substance, and it has a high environmental impact due to its toxicity and persistence in the environment; the contamination generally comes from chemical industry and agricultural practices [2]. 4-nitrophenol is one of the nitrophenols, which are registered in the U.S. Environmental Protection Agency's list of priority pollutants [3, 4]. Nitrophenols are major degradation products from organophosphorus pesticides [5].

4-Nitrophenol (ReagentPlus[®], ≥99%, CAS Registry number: 100-02-07) was supplied by Sigma-Aldrich, CZ. A stock solution of 1×10^{-3} mol L⁻¹ was prepared by dissolving an exactly weighed amount of substance in deionized water. Diluted solutions were prepared by exact dilution of the stock solution with Britton-Robinson buffer solutions. The solutions were stored in refrigerator. Britton-Robinson buffer solutions were prepared by mixing a 0.04 mol L⁻¹ solution of phosphoric acid (Lach-Ner, CZ), acetic acid (Lachema, CZ) and boric acid (Lachema, CZ) with an appropriate amount of 0.2 mol L⁻¹ sodium hydroxide (Lach-Ner, CZ). Deionized water was produced by Milli-Q Plus system (Millipore, USA).

Voltammetric measurements were carried out using an Eco-Tribo Polarograph driven by Polar Pro 5.1 software (both Polaro-Sensors, CZ). The software worked under the operational system Microsoft Windows XP (Microsoft Corporation, USA). All measurements were carried out in a three-electrode system using a platinum electrode PPE (Monokrystal, CZ) as an auxiliary electrode and a silver/silver chloride electrode RAE 113 (3 mol L⁻¹ KCl, Monokrystal, CZ) as a reference electrode. Carbon composite film electrodes were used as working electrodes. A scan rate 20 mV s⁻¹ was used for both cyclic voltammetry and DPV, a pulse amplitude -50 mV and a pulse width 100 ms were used for DPV.

For voltammetric measurements, an appropriate amount of 4-nitrophenol stock solution in deionized water was measured into a voltammetric vessel and filled up to 10.0 mL with Britton-Robinson buffer of appropriate pH. Oxygen was removed from the measured solution by bubbling with nitrogen for five minutes. All curves were measured five times.

At the beginning, the electrodes from different metal substrates were made in our laboratory. Namely, the aluminium, copper, and tin substrates (disc diameters 5.00 mm) were used for the CCFEs preparation. Then, the electrochemical behavior of 4-nitrophenol was tested using these electrodes.

The influence of pH on voltammetric behavior of 4-nitrophenol (concentration of 1×10^{-4} mol L⁻¹) at three different CCFEs was investigated. Initially, three Britton-Robinson buffer solutions (of pH = 2.0, 7.0, and 11.0) representing acidic, neutral and alkaline media respectively, were used as supporting electrolytes for the cyclic voltammetry measurement of the potential window width, the charging current and the electrical noise. Afterwards, the influence of pH on voltammetric behavior of 4-nitrophenol was measured using DPV; the peak potentials shifted towards negative values with increasing pH which can be explained by a preceding protonation of the nitro group in 4-nitrophenol. The best developed and the highest peaks were obtained in the Britton-Robinson buffer of pH = 7.0. This medium was further used for following measurements.

The measurements repeatability on single carbon film (variability on a particular film) and between several different films (variability of film renewal) at different CCFEs were investigated. The several regeneration potentials were tested using DPV. Regeneration potentials were chosen in order to cover gradually the whole available potential window of the electrode focussing on the cathodic region. Influence of choosing regeneration potentials before and after the analyte peak potential was tested.

This work was focussed on the preparation and application of the CCFEs for the development of voltammetric methods for the determination of submicromolar concentrations of biologically active compounds detrimental to the environment. Upon the development of the CCFEs, several metals (aluminum, copper, tin) were tested as the electrode substrates. Afterwards, the electrochemical properties of the CCFEs prepared using these materials were investigated and the usability of these electrodes for the voltammetric determination of 4-nitrophenol was verified.

Acknowledgments

Financial support by The Ministry of Education, Youth and Sports of the Czech Republic (Project MSM 0021620857), by the Charles University in Prague (Projects UNCE 2012/44 and SVV 2012-265201) and by The Grant Agency of the Czech Republic (Project P206/12/G151).

References

- [1] Yosypchuk B., Barek J., Fojta M.: *Electroanalysis* **18** (2006), 1126–1130.
- [2] Christophersen M. J., Cardwell T. J.: *Anal. Chim. Acta* **323** (1996), 39–46.
- [3] US Environmental Protection Agency: *Fed. Regist.* **44** (1979), 233.
- [4] US Environmental Protection Agency: *Fed. Regist.* **52** (1989), 131.
- [5] Castillo M., Dominigues R., Alpendurada M. F., Barcelo D.: *Anal. Chim. Acta* **353** (1997), 133–42.

HPLC-UV Method for the Determination of Genotoxic 4-Nitroindane in the Mixture of Selected Nitrated Polycyclic Aromatic Hydrocarbons

VENDULA NĚMCOVÁ, JIŘÍ BAREK, VLASTIMIL VYSKOČIL

UNESCO Laboratory of Environmental Electrochemistry, Department of Analytical Chemistry, Faculty of Science, Charles University in Prague, Hlavova 2030/8, 128 43 Prague 2, Czech Republic, ✉ Burdova.Vendula@seznam.cz

Keywords

HPLC with UV detection
nitrated polycyclic aromatic hydrocarbons
4-nitroindane

Presented paper is focused on the development of an HPLC-UV method for the determination of genotoxic 4-nitroindane (Fig. 1) – one of the representatives of nitrated polycyclic aromatic hydrocarbons (NPAHs) – in a mixture with NPAHs used as markers of incomplete combustion. A hydrocarbon indane (a component of petrol, primarily used as an additive) is a precursor of 4-nitroindane. Nitrated polycyclic aromatic hydrocarbons are mainly produced by combustion processes in gasoline and diesel engines [1–3]. It has been shown that NPAHs can be many times more mutagenic or carcinogenic than their parent polycyclic aromatic hydrocarbons [4] and, therefore, the analysis of these dangerous pollutants becomes important for modern environmental analytical chemistry.

A less time-consuming HPLC-UV method was developed for the determination of 4-nitroindane in the model mixture of selected NPAHs: 1-nitropyrene,

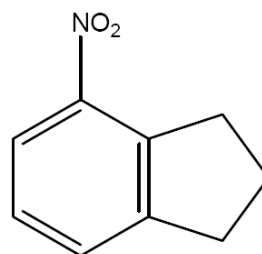

Fig. 1. Structural formula of 4-nitroindane

2-nitrofluorene, and 3-nitrofluoranthene. During the optimization of the method, heightened attention was paid to reducing the time of analysis and, on the other hand, to the achievement of sufficient selectivity in the determination of 4-nitroindane in the mixture. Optimal conditions for the determination of 4-nitroindane were investigated in a buffered water-methanolic mobile phase (0.01 mol L⁻¹ acetate buffer pH = 4.8: HPLC methanol, 85:15, v/v). A flow rate 1.2 mL min⁻¹ and a wavelength 210 nm were used as optimal. Measured sample solutions were prepared by an accurate dilution of stock solutions of tested NPAHs (all stock solutions of 1×10⁻³ mol L⁻¹) by HPLC methanol and injected by a 20-μL sample loop. Linear calibration dependences were obtained in the concentration range from 2×10⁻⁸ mol L⁻¹ to 1×10⁻⁴ mol L⁻¹ for all the analytes tested. For 4-nitroindane, the attained limit of quantification (L_Q) was 5×10⁻⁷ mol L⁻¹ (evaluated from the peak height) and 4×10⁻⁷ mol L⁻¹ (evaluated from the peak area).

Acknowledgments

This research was supported by The Ministry of Education, Youth and Sports of the Czech Republic (Project MSM 0021620857) and by the Charles University in Prague (Project UNCE 2012/44 and SVV 2012-263204).

References

- [1] Feilberg A., Poulsen M. W. B., Nielsen T., Skov, H.: *Atmos. Environ.* **35** (2001), 353–366.
- [2] Ding X., Wang X. M., Xie Z. Q., Xiang C. H., Mai B. X., Sun L. G., Zheng M., Sheng G. Y., Fu J. M., Poschl U.: *Atmos. Environ.* **41** (2007), 2061–2072.
- [3] McCartney M. A., Chatterjee B. F., McCoy E. C., Mortimer E. A., Rosenkranz H. S.: *Mutat. Res.* **171** (1986), 99–104.
- [4] Salmeen I., Durisin A. M., Prater T., Riley T., Schuetzle D.: *Mutat. Res.* **104** (1982), 17–23.

Determination of Selenium Using Photochemical Volatile Compounds Generation Coupled with Atomic Absorption Spectrometry Detection

MARCELA RYBÍNOVÁ, ALŽBĚTA KOLOROSOVÁ, VÁCLAV ČERVENÝ, PETR RYCHLOVSKÝ

Department of Analytical Chemistry, Faculty of Science, Charles University in Prague, Albertov 6, 128 43 Prague 2, The Czech Republic, ✉ rybinova.marcela@seznam.cz

Keywords

AAS

photochemical generation

selenium

volatile compounds

Presented work is focused on the determination of selenium in aqueous samples using UV-photochemical generation of its volatile compounds coupled with atomic absorption spectrometry detection. This way of sample introduction is an alternative to conventional chemical or electrochemical volatile compounds generation [1]. In contrast to these approaches, proposed method provides some advantages. In photochemical generation there is no need of expensive and relatively unstable reducing agent in contrast with chemical generation [2], based on the reaction with sodium borohydride as a reducing agent in the presence of high-purity mineral acids. Additionally, this reagent can be prepared only in a limited purity, which increases the potential for contamination of the sample. The electrochemical generation eliminates also the problems associated with a reducing agent, because the reduction is carried out by electric current only [3]. Moreover, UV-photochemical generation comes with a simpler apparatus and overcomes difficulties associated with passivation or memory effects on the electrodes. Passivation may ultimately lead to a reduction in generation efficiency or again to contamination of sample etc.

UV-photochemical generation is based on the fact, that in the presence of a low molecular weight organic acid (formic, acetic, propionic or malonic), nonvolatile precursors (inorganic selenium(IV)) are converted by the effect of UV irradiation from the condensed phase to volatile species (selenium hydride, selenium carbonyl, dimethyl selenide, diethyl selenide, respectively). The resulting gaseous products are then rapidly transported to the externally heated quartz tube for detection by atomic absorption spectrometry [4]. Reaction mechanism remains the subject of discussion because of the complicated nature of photoreactions [2].

At the beginning, two designs of flow-through photoreactor were constructed. In both arrangements, the photoreactor was realized by low-pressure Hg vapor UV lamp (20 W, 254 nm). In the first case, PTFE tubing (2.0 mm o.d./1.0 mm i.d.) was wrapped around UV lamp; in the second case, the quartz tube (4.0 mm o.d./2.0 mm i.d.) was attached to the surface of UV lamp. Samples, it means solution of selenium with addition of a low molecular organic acid (possibly other additives were added) or blank (according to turning the valve), were propelled through the tubing with the aid of a peristaltic pump (Cole Parmer, USA) into the photoreactor. Volatile forms were generated there after UV irradiation. The reaction mixture was then transported to a gas/liquid separator with forced outlet, where gaseous and liquid phases were mutually separated. Liquid phase was then pumped to waste by second pump. Gaseous phase with the volatile products was transported by a stream of carrier gas (argon) directly to the externally heated quartz tube atomizer (950 °C). The carrier gas was introduced before the phase separator; the introduction before the photoreactor was also tested. In order to increase the atomization efficiency, additional hydrogen was introduced into the atomizer. A scheme of used arrangement is illustrated in Fig. 1. All the measurements were carried out in continuous flow mode; a sample signal at steady state was evaluated against the blank signal. A hollow cathode lamp for selenium (Unicam, UK) served as a primary source radiation at 196.0 nm (band-pass of 0.2 nm). Simultaneous deuterium background correction was used for the measurements.

Then optimum experimental conditions for UV-photochemical volatile compounds generation using formic acid were found. Formic acid was chosen for the study as a representative of the simplest organic acids. The conditions for optimal time of irradiation of the analyte, which is dependent on the sample flow rate and the length of PTFE tubing or the quartz tube, was studied. Further key parameters

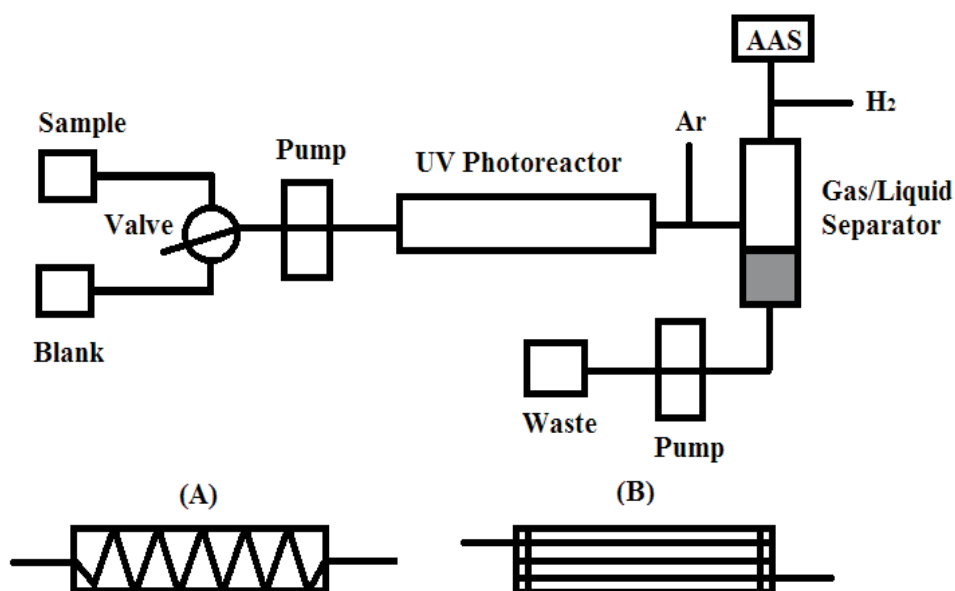

Fig. 1. Scheme of the experimental setup: (A) UV photoreactor – PTFE tubing wrapped around UV lamp, (B) UV photoreactor – quartz tube attached to the surface of UV lamp

were also optimized: the carrier gas flow rate as well as the auxiliary hydrogen flow, concentration of formic acid or concentration of additives. Analyte response was significantly increased by adding hydrogen peroxide, sodium nitrite, sodium nitrate or nitric acid [4]. The signal increased approximately five times when nitrate anion was added. A detection limit of $58.0 \text{ ng L}^{-1} \text{ Se(IV)}$ with a repeatability of 2.1 % (RSD, $n = 10$) was obtained with proposed method.

Consequently, the generation efficiency was investigated. It was determined by comparing of slope of calibration curves of UV-photochemical and reference chemical generation. In chemical generation, the individual efficiencies (efficiencies for formation, gas-liquid separation and analyte transport) are known to be essentially quantitative and the response can thus be used as a relative benchmark for performance [4].

Although further investigations are still needed, results obtained so far show that this approach of sample introduction could be a useful alternative to conventional chemical and electrochemical volatile compounds generation in the future because of its simplicity, sensitivity or cost effectiveness.

Acknowledgments

This work was supported by MŠMT (project No. MSM0021620857), Charles University in Prague (project SVV 2012-265201 and project UNCE 204025/2012).

References

- [1] Guo, X., Sturgeon, R. E., Mester, Z., Gardner, G. J.: *Anal. Chem.* **76** (2004), 2401–2405
- [2] He, Y., Hou, X., Zheng, Ch., Sturgeon, R. E.: *Anal. Bioanal. Chem.* **388** (2007), 769–774.
- [3] Červený, V., Rychlovský, P., Hraníček, J., Šíma, J.: *Chem. listy* **103** (2009), 652–660.
- [4] Guo, X., Sturgeon, R. E., Mester, Z., Gardner, G. J.: *Anal. Chem.* **75** (2003), 2092–2099.

Determination of Sevoflurane and Hexafluoroisopropanol from Plasma by GC-MS/MS

PETER PODOLEC^a, ALEXANDRA HENGERICS SZABÓ^a, RÓBERT KUBINEC^a,
WILHELM LORENZ^b

^a *Institute of Chemistry, Faculty of Natural Sciences, Comenius University,
Mlynská dolina CH-2, 842 15 Bratislava, Slovakia, ✉ podolec@fns.uniba.sk*

^b *Department of Chemistry, Institute of Analytical and Environmental Chemistry,
Martin-Luther University,
Kurt-Mothes St. 2, 06120 Halle, Germany*

Keywords

direct injection

GC-MS/MS

hexafluoroisopropanol

plasma

sevoflurane

Sevoflurane was introduced into clinical practice in 1990 as an inhalation anesthetic agent and now belongs to the world's most commonly used anesthetics. Due to its low blood-gas partition coefficient and low solubility in blood, it enables rapid and smooth induction of anesthesia. It is readily excreted from the central nervous system, allowing quick awakening of the patient at the end of anesthesia [1]. Sevoflurane present in blood is rapidly metabolized to its primary metabolite, hexafluoroisopropanol, which is excreted in urine. Hexafluoroisopropanol circulates in blood primarily as a glucuronide conjugate. The published methods are based on the deglucuronidation of conjugated hexafluoroisopropanol, what is necessary for the quantification of the total hexafluoroisopropanol content in plasma [2, 3]. In the present study only free, unconjugated form of hexafluoroisopropanol, which represents about 15% of the total amount of hexafluoroisopropanol, is determined [4].

Analytical methods allowing the elimination of liquid solvents in the analytical procedures and the shortening of sample preparation time are in constant

development [5–7]. Direct aqueous injection (DAI) undoubtedly belongs to this group. In methods involving DAI, water samples are directly injected into the gas-chromatographic system without any pretreatment [8–10]. The elimination of sample pretreatment and preconcentration reduces the loss of volatile analytes and the risk of sample contamination. The main drawback of this injection technique is that huge amounts of water are introduced into the GC system what results in analytical problems (e.g., changing the characteristics of stationary phase in capillary columns, or affecting the detectors' response) [11–15].

Plasma is a matrix similar to water. Apart from water, representing the main component (more than 90%), it also contains a wide range of macromolecules and salts, inducing difficulties in GC analysis with direct sample injection. Problems may arise mainly because of thermal degradation of the sample in the injector and contamination of the GC system by products of sample degradation. To date, only few studies dealing with this issue can be found in the literature [16, 17].

Direct injection of plasma samples into the GC system was used by Abdel-Rehim et al. [18] for the determination of the anesthetic agent ropivacaine and its metabolite pipercoloxylidide. A packed liner was installed in the injector, which had a lifetime of about 20 sample injections. The method is suitable for the determination of substances less volatile than water. A system allowing injection of large volumes of water samples into the GC system and the determination of the non-polar volatile components was presented by Kubinec et al. [15]. Aeppli et al. [16] published the simultaneous determination of polar and non-polar volatiles in water using direct injection. However, this method can only be applied when water samples contain trace amounts of non-volatile components. The simultaneous determination of sevoflurane and its metabolite hexafluoroisopropanol in plasma also represents a problem of simultaneous determination of non-polar and polar volatile components.

A method for the simultaneous determination of non-polar sevoflurane and its polar metabolite hexafluoroisopropanol in plasma was developed. This method allows direct injection of 150 plasma samples into the GC system without necessary injector cleaning. The method is very rapid and does not require sample pretreatment.

Acknowledgments

This publication is the result of the project implementations: 'Amplification of the Centre of Excellence on Green Chemistry Methods and Processes (CEGreenII)' ITMS: 26240120025 supported by the Research & Development Operational Programme funded by the ERDF. Work was also supported by the Slovak Research and Development Agency under the contract No. APVV-0416-10.

References

- [1] Bouche M-P.L.A., Van Boxclaer J.F.P., Rolly G., Versichelen L.F.M., Struys M.M.R.F., Mortier E., De Leenheer A.P.: *Clin. Chem.* **47** (2001), 281–291.
- [2] Morgan S.E., Frink E.J., Gandolfi A.J.: *Anesthesiology* **80** (1994), 201–205.
- [3] Accorsi A., Morrone B., Benzo M., Gandini C., Raffi G.B., Violante F.S.: *J. Chromatogr. A* **1071** (2005), 131–134.
- [4] Kharasch E.D., Armstrong A.S., Gunn K., Artru A., Cox K., Karol M.D.: *Anesthesiology* **82** (1995), 1379–1388.
- [5] Namiesnik J., Wardencki W.J.: *High Resol. Chromatogr.* **23** (2000), 297–303.
- [6] Příklad P., Kubinec R., Jurdáková H., Ševčík J., Ostrovský I., Soják L., Berezkin V.G.: *Chromatographia* **64** (2006), 65–70.
- [7] Kubinec R., Berezkin V.G., Górová R., Addová G., Mračnová H., Soják L.: *J. Chromatogr. B* **800** (2004), 295–301.
- [8] Gurka D.F., Pyle S.P., Titus R.: *Anal. Chem.* **64** (1992), 1749–1754.
- [9] Zwank L., Schmidt T.C., Haderlein S.B., Berg M.: *Environ. Sci. Technol.* **36** (2002), 2054–2059.
- [10] Golfopoulos S.K., Lekkas T.D., Nikolaou A.D.: *Chemosphere* **45** (2001), 275–284.
- [11] Straková M., Matisová E.: *Chem. Listy* **91** (1997), 330.
- [12] Kuráň P., Soják L.: *J. Chromatogr. A* **733** (1996), 119–141.
- [13] Sung N.J., Johnson S.I., Zlatkis A., Middleditch B.S.: *J. High Resol. Chromatogr.* **11** (1988), 409–410.
- [14] Demeestere K., Dewulf J., De Witte B., Van Langenhove H.: *J. Chromatogr. A* **1153** (2007), 130–144.
- [15] Kubinec R., Adamuščin J., Jurdáková H., Foltin M., Ostrovský I., Kraus A., Soják L.: *J. Chromatogr. A* **1084** (2005), 90–94.
- [16] Aeppli C., Berg M., Hofstetter T.B., Kipfer R., Schwarzenbach R. P.: *J. Chromatogr. A* **1181** (2008), 116–124.
- [17] van Hout M.W.J., de Zeeuw R.A., Franke J.P., de Jong G.J.: *J. Chromatogr. B* **729** (1999), 199–210.
- [18] Abdel-Rehim M., Svensson K.A., Askemark Y., Pettersson K.-J.: *J. Chromatogr. B* **755** (2001), 253–258.

New Capillary Monolithic Column for Isocratic Separation of Small Molecules

JIRÍ VOJTA, ADÉLA SVOBODOVÁ, PAVEL COUFAL

Department of Analytical Chemistry, Faculty of Science, Charles University in Prague, Hlavova 8, 128 43 Prague 2, The Czech Republic, ✉ vojta@natur.cuni.cz

Keywords

methacrylic acid
monolithic
small molecules
styrene

The first high-efficiency monolithic column for liquid chromatography was published in 1989 by Stellan Hjertén and co-workers [1]. It was a compressed hydrophilic gel for an ion-exchange chromatography separation of five peptides. Since then many ways how to prepare monolithic columns have been found, including new combinations of monomers, new initiators or new polymerization conditions [2]. Monolithic columns exhibit a new separation media with high efficiency, low back pressure and high pH resistance. Preparing monolithic columns in fused silica capillaries started a new age of electrochromatography methods, which combine efficiency of capillary zone electrophoresis with selectivity of HPLC [3].

Key features of monolithic columns are their surface chemistry and morphological characteristics. Monolithic columns contain three kinds of pores. At first there are macropores, high flow-through pores bigger than 50 nm, which provide the low back pressure of column. Second and third kinds of pores are mesopores and micropores, pores smaller than 50 nm and 2 nm, respectively, which provide a major part of specific surface area of monolithic column. Morphological characteristics of monolithic column causes that analyte comes to an active center of stationary phase by convective flow and not by diffusion like within conventional packed columns. Due to that, monolithic columns are better separation media,

especially for slow-diffusion macromolecules, than packed columns. Several groups also work on preparation of monolithic columns, which would provide a high-efficiency separation of small molecules and this is an up-to-date topic in the literature [4].

Last year, we introduced a styrene-*co*-divinylbenzene-*co*-methacrylic acid (1:2:1 %vol.) monolithic column for separation of small molecules by capillary liquid chromatography [5]. Such column, originally designed for capillary electrochromatography [6], was proven to be very suitable for this purpose. In electrochromatography, methacrylic acid generates electroosmotic flow. An addition of methacrylic acid was shown to be essential even for capillary liquid chromatography analysis. The carboxylic group of methacrylic acid causes the formation of flow-through pores and mesopores, both are necessary for analysis of small molecules by chromatography. Now, we would like to find a relationship between the amount of methacrylic acid in the polymerization mixture and morphological characteristics of resulting monolithic column. Pore size distribution is changed by increasing amount of methacrylic acid in polymerization mixture and due to that, we are able to prepare new monolithic column, which provides significantly more efficient separation of small molecules than the original column.

All prepared columns are tested with a mixture of thiourea and seven derivatives of benzene. Columns have length 17 cm and 320 μm inner diameters. Measurements are conducted at ambient temperature with 65% acetonitrile in water as a mobile phase (flow rate 4 $\mu\text{L min}^{-1}$). Original polymerization mixture contained 50 μL of methacrylic acid and newly we prepared a column containing 75 μL . Polymerization conditions were 70 $^{\circ}\text{C}$ and 6 hours for both. Base line separation of all eight analytes was achieved with the new column. Time of analysis decreased two times (under 9 minutes) and separation efficiency increased by 10 000 plates m^{-1} (up to 40 000 plates m^{-1} for retained). Column back pressure dropped from 60 bars to 40 bars. These results suggest that the new column has different morphology, probably with higher content of bigger mesopores and macropores. After such promising results we are working on other columns with different amount of methacrylic acid, which are polymerized under different conditions (temperature and time). We expect that even more efficient columns could be prepared.

Acknowledgments

The projects No. 710 and SVV 2012-265201 of the Grant Agency of Charles University and Research Project MSM 0021620857 of the Ministry of Education, Youth and Sports are acknowledged for the financial support.

References

- [1] Hjertén S., Liao J. L., Zhang R.: *J. Chromatogr. A* **473** (1989), 273–275.
- [2] Svec F.: *J. Chromatogr. A* **1217** (2010), 902–924.
- [3] Svec F.: *Electrophoresis* **30** (2009), S68–S82.
- [4] Svec F.: *J. Chromatogr. A* **1228** (2012), 250–262.
- [5] Svobodová A., Křížek T., Širc J., Šálek P., Tesařová E., Coufal P., Štulík K.: *J. Chromatogr. A* **1218** (2011), 1544–1547.
- [6] Jin W., Fu H., Huang X., Xiao H., Zou H.: *Electrophoresis* **24** (2003), 3172–3180.

Indexes

Author Index

- Adam M. 19
Barek J. 16, 28, 41, 72, 84, 87
Berezkin V.G. 33
Bosáková Z. 47, 79
Bursová M. 21
Buszewski B. 11, 36, 53, 58, 77
Čabala R. 21
Červený V. 89
Čížková A. 19
Coufal P. 96
Denderz N. 55
Dendisová M. 67
Dziubakiewicz E. 11, 36
Džúrová J. 13
Gadzała-Kopciuch R. 77
Gorris H.H. 24, 49
Grzywiński D. 77
Hanus R. 79
Havránek L. 67
Hengerics Szabó A. 33, 93
Hrdlička A. 82
Jačkowska M. 58
Janda P. 60
Jandera P. 45
Jiroš P. 79
Kalinová B. 79
Kanický V. 82
Klusáčková M. 60
Kolorosová A. 89
Kouklíková E. 72
Kozlík P. 47
Krasulová J. 79
Krejčová Z. 16
Kubinec R. 33, 93
Lehotay J. 55
Liebherr R.B. 24
Lorenz W. 93
Májek P. 38
Mark J. 65
Markechová D. 38
Maška J. 72
Matějka P. 67
Matysik F.-M. 65
Němcová V. 87
Novosád L. 82
Novotný V. 72
Otruba V. 82
Pažitná A. 13
Pecková K. 41
Podolec P. 33, 93
Pomastowski P. 36
Prchal V. 28
Rumlová T. 84
Rybínová M. 89
Rychlovský P. 89
Sádecká J. 38
Sedlmeier A. 49
Sillam-Dussès D. 79
Škeříková V. 45
Slaviček P. 82
Šobotník J. 79
Špánik I. 13
Staňková M. 45
Stěnička V. 63
Svobodová A. 96
Szultka M. 53
Szumski M. 77
Tatarkovič M. 63
Urban J. 45
Valterová I. 79
Ventura K. 19
Vogl F. 24
Vojta J. 96
Vyskočil V. 16, 28, 84, 87
Walczak J. 53
Wilhelm S. 49
Žáček P. 79
Zavázalová J. 41

Keyword Index

- AAS 89
- aflatoxins 77
- 4-aminobenzenethiol 67
- aminobiphenyls 41
- aminonaphthalenes 41
- amperometric detection 65
- amperometry 41
- anion exchanger 58
- antibiotics 53
- aromatic and polyaromatic amines 21
- atomic force microscopy 60
- backscattering spectroscopy 60
- bacterial cell 11
- bell-shaped extraction device
 - assisted liquid-liquid microextraction 21
- beverage 38
- bicollloid 36
- blood plasma 63
- boron-doped diamond film
 - electrode 41
- cancer 63
- capillary columns 45
- capsid 49
- carbon composite film
 - electrodes 84
- chiroptical spectroscopy 63
- cyclic voltammetry 60
- defensive compounds 79
- dendrimer-bonded silica
 - surfaces 58
- direct injection 93
- DNA biosensor 16
- drug monitoring 53
- electrochemistry 84
- electrophoresis 11
- elements determination 82
- encapsulation 49
- end-column 65
- enzymes 24
- essential oils 19
- exhaled breath 33
- fast separation 65
- femtoliter arrays 24
- fluorescence 38
- Fluorodifen 72
- Fomesafen 72
- GC×GC-MS 79
- GC-MS 21, 33, 79
- GC-MS/MS 93
- hanging mercury drop
 - electrode 16, 28
- herbal beverages 19
- hexafluoroisopropanol 93
- high performance liquid chromatography 53
- high-throughput 65
- honey 13
- HPLC with UV detection 87
- hydrophilic interaction liquid chromatography 47
- in situ* spectroelectrochemistry 67
- INCAT 33
- ion chromatography 58
- juniper drinks 38
- liquid chromatography 45, 55
- low-cost 82
- low-molecular compounds 45
- luminescence 24
- mass spectrometry 47, 53
- methacrylic acid 96
- micro-HPLC/LIF 77
- microscopy 24
- micro-SPE 77
- molecularly imprinted polymers 55
- monolithic 96
- multidimensional gas chromatography 13
- nanoparticles 49
- nitrated polycyclic aromatic hydrocarbons 16, 87
- 2-nitrofluorene 16
- 4-nitroindane 87
- non-aqueous capillary electrophoresis 65
- organic polymer monolith 45
- parallel factor analysis 38
- phenolic acids 55
- photochemical generation 89
- phthalocyanine 60
- physicochemical surface characteristics 11
- plasma 93
- plasma pencil 82
- potentiometric titration 36
- pteridines 47
- response surface method 21
- sample introduction 82
- selenium 89
- self-assembled monolayer 28
- SERS 67
- sevoflurane 93
- single drop microextraction 19
- single-molecule studies 24
- small molecules 96
- solid phase microextraction 53
- solventless extraction 33
- spectral marker 63
- square-wave voltammetry 28
- styrene 96
- termites 79
- trail-following pheromone 79
- two-dimensional chromatography 45
- unsaturated hydrocarbons 60
- upconversion 49
- van't Hoff equation 55
- virus-like particles 49
- volatile compounds 89
- volatile organic compounds 13
- voltammetry 16, 41, 72, 84
- water 72
- yeast 36
- zeta potential 36
- zone capillary electrophoresis 36

Proceedings of the 8th International Students Conference “Modern Analytical Chemistry”

Edited by Karel Nesměrák.

Published by Charles University in Prague, Faculty of Science.

Prague 2012.

1st edition – 104 pages – Number of copies: 60

ISBN 978-80-7444-017-5



knihovnicka.cz

ISBN 978-80-7444-017-5

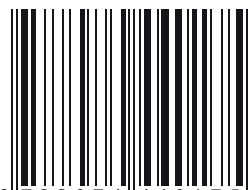

9 788074 440175