

Group of Environmental Electron Microscopy (EEM)

Department of Electron Microscopy



Institute of Scientific
Instruments
The Czech Academy
of Sciences

THEMATIC RESEARCH FOCUS

Research area

- Scanning & Environmental scanning electron microscopy (SEM/ESEM)
- Environmental and scanning transmission electron microscopy (Wet-STEM/STEM)
- Signal electron and photon detection systems
- Energy dispersive X-Ray spectroscopy
- Computer based simulations for SEM/ESEM

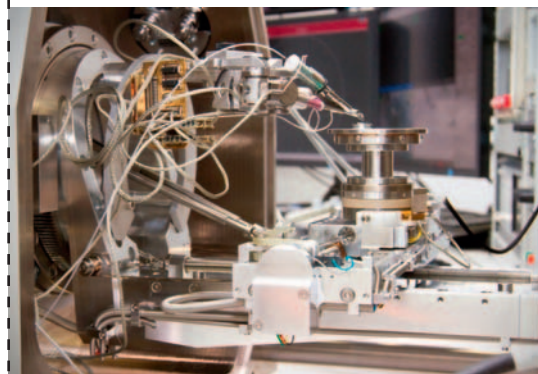

Laboratory of environmental electron microscopy with high resolution ESEM QUANTA 650 FEG (left) equipped with micromanipulators (right)

Excellence

- Low dose micro-morphological characterisation of untreated wet biological samples and polymers in ESEM
- Dynamical in-situ observation on the phase boundaries/transitions of matters and under well balanced thermodynamic conditions in ESEM & electron microscopy for ice chemistry
- Monte-Carlo simulations of electron-gas, electron-water and electron-solid interactions in ESEM
- High-resolution imaging and X-ray micro-analysis of non/semi conductive samples in ESEM
- Research, development, and manufacturing of very high efficient detectors of signal electrons for SEM/ESEM
- Gas flow and heat transfer simulations for R&D of custom instrumentation for SEM/ESEM

Mission

To be the world leader in the low dose/energy environmental scanning electron microscopy and at the forefront in the field of static or dynamic in-situ characterisation of low emissive, beam sensitive, mostly non-conductive wet samples observed in their native state. To invent new methods, instrumentation, and applications for further exploration of the nano-world.

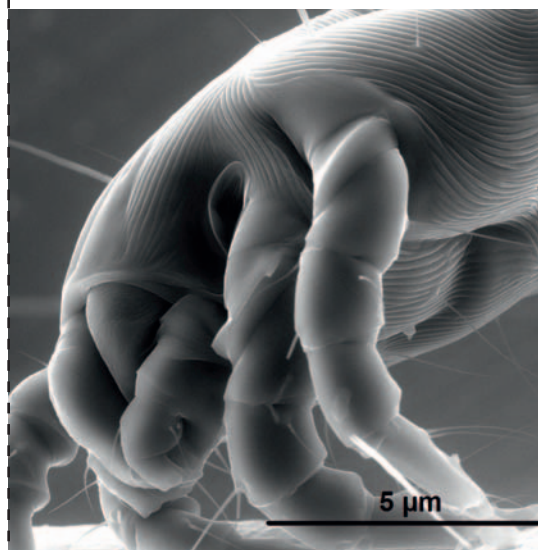

Live Mite observed in the ESEM AQUASEM II

UP-TO-DATE ACTIVITIES

Research focus

- Theoretical and experimental activities related to pushing boundaries of ESEM capabilities (development of new ESEM designs, new detectors)
- Dynamical in situ characterisation of samples under different physical and chemical impacts, etc.
- Morphological and structural analysis of natural or live samples

Main capabilities

Basic research

- Theoretical simulations of electron-gas, electron-water and solid interactions
- Theoretical simulations of gas flow and heat transfer in ESEM
- New methodology for low dose observation and chemical analysis of native biological samples

Applied research

- Design and conversion of SEM Vega (Tescan) to experimental ESEM AQUASEM II
- Design and manufacturing of the HAADF detector for Hitachi TEM, the BSE detector for Jeol SEM-JSM 5600LV, the new „edge-free“ detector for Hitachi SEM, the YAP detector for Jeol SEM, the Scintillation SE detector for ESEM and other prototypes of BSE detectors (over 50 pieces) for Jeol, Hitachi & FEI

Innovations

- New Ionisation SE detector with electrostatic separator for ESEM (EU patent No. 2195822)

Sub-fields of group activities

- Micro/nanotechnology
- Biology/biotechnology, chemistry
- Semiconductor industry/electronics
- Pharmaceutical industry
- Textile industry
- Building materials
- Automotive

KEY RESEARCH EQUIPMENT

List of devices

- Environmental scanning electron microscopes AQUASEM II, QUANTA 650 FEG
- Scintillation BSE detectors (YAG, YAP and CRY018 scintillators)
- X-Ray EDS analyzer Bruker XFlash 6/60 + mapping (EDS microanalysis in SEM/ESEM)
- Many types of special detectors (ET, GAD, LFD, GSED, ICD, DBS, CL, scintillation SE detector, ISEDS)
- Kleindiek micromanipulators, EBIC, RCI amplifier, gas and liquid micro-injectors & hydration system
- Peltier cooling stage and heating stage (from -20°C to +1000°C)
- Retractable solid state WetSTEM/STEM detector

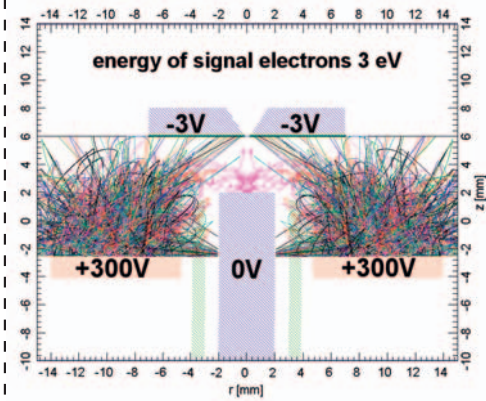
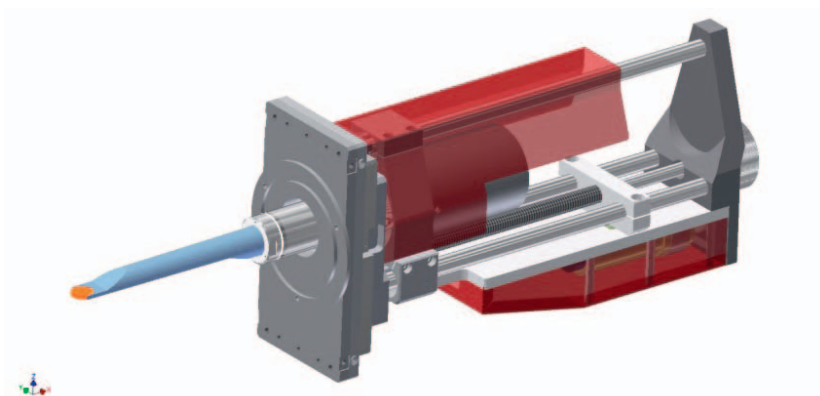

Monte Carlo simulation of electron trajectories in gas (ESEM conditions)

Monte Carlo simulations of electron-solid sample interactions (C-Si multilayer)

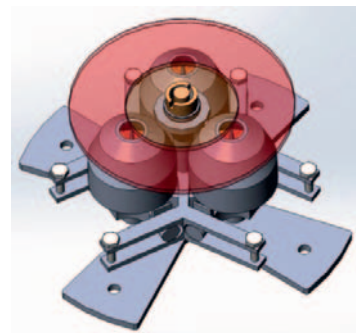
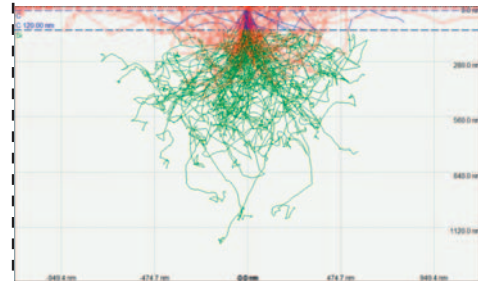

New version of patented ISEDS with magnetic field (new detector for ESEM)

New scintillation BSE detector for SEM and ESEM (left) and hydration system (right)



ACHIEVEMENTS

Awards

Kenbikyo Award 2016 – excellent paper of the journal for last two years (Japanese society of microscopy award). The best Ph.D. thesis (Czechoslovak Microscopy Society award), 2nd place in the event the Best doctoral thesis in the field of Building rehabilitation and reconstruction (Scientific and Technical Association for Building Rehabilitation and Monument Preservation award).

Papers

We are pushing the limits of possibilities of imaging and analysis of untreated, electrically non-conductive/semi-conductive and wet or liquid samples in ESEM. We are specialized in the characterization of difficult to see and advanced materials using our developed new methods and unique instrumentation.

■ **Pioneering theoretical results of Monte Carlo simulations of electron-gas interactions and signal electron transportation in gas owing to the collection efficiency of segmented ionization detector for signal electrons with selected energies from units of eV to 18 keV.**

- V. Neděla, et al., *Microscopy and Microanalysis* **21**(4), 264, 2015
- V. Neděla, et al., *Microscopy and Microanalysis* **21**(3), 1109, 2015

■ **Significant theoretical work focused on calculations of higher-order deflections aberrations of the electron-optical system used for environmental scanning electron microscopy and possibility of their dynamical corrections. This work indicates future trends in the ESEM.**

- M. Oral et al., *Microscopy and Microanalysis* **21** (4), 194, 2015

■ **World unique experimental results were attained by studying ice contamination processes at grain boundaries in environmentally compatible conditions of a high gas pressure and a relatively high temperature in a specially modified ESEM in a combination with fluorescence microscopy.**

- J. Krausko et al., *Langmuir* **30** (19), 5441, 2014

■ **A new method for the high-resolution morphological study of plant samples in their native state. Method also allows increasing sample resistance to radiation damage by the electron beam. This method was invented and experimentally tested on many types of plant biological samples in our laboratories.**

- V. Neděla et al., *Microsc Res Tech*. **78**, 13, 2015
- V. Neděla et al., *Biologia Plantarum* **56** (3), 595, 2012

■ **Based on the results of Monte Carlo simulations of an electron beam with water involving study of free radicals concentration, a new, extremely sample-preserving method was introduced. It allows studying of small live and surviving animals like mites in ESEM. The method presents basic research in the new field of live organism observation in the conditions of a high pressure, a low electron energy, and a low beam current, utilizing advanced instrumentation systems.**

- E. Tihlaříková et al., *Microscopy and Microanalysis* **19** (4), 914, 2013
- V. Neděla et al., *Kenbikyo*. **49** (1), 64, 2014

■ **Based on optimization of the new method for study of live samples and in combination with our unique high efficient detectors of signal electrons for ESEM, a new method for morphological characterization of very beam sensitive wet polyelectrolyte complex microcapsules containing a semi liquid core with live cells was introduced. Our**

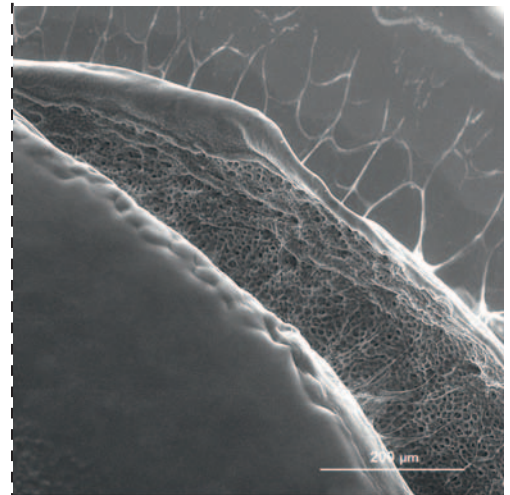

Wet polyvinyl-alcohol lances (LentiCat™) in native state in ESEM

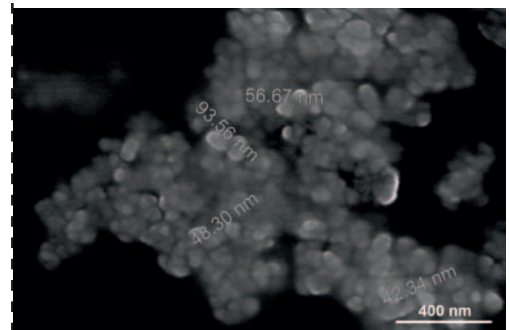

Uncoated zinc oxide nanoparticles in ESEM

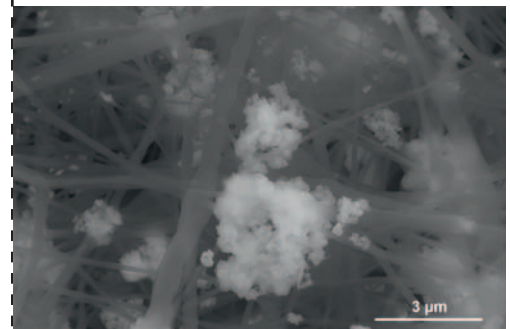

Uncoated surface of PUR with 10% CuO₂ nanoparticles (ESEM for textile industry)

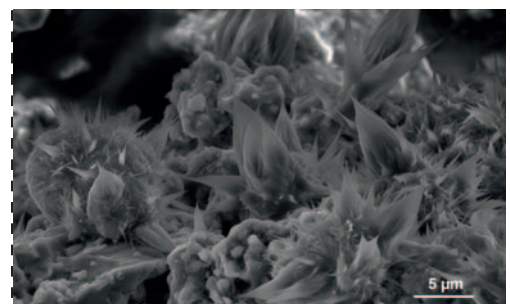

Alkali-activated steel making slag in ESEM (Uncoated surface)

laboratory is the only one in the world able to observe these types of samples free of destruction or damage.

- A. Bertóková et al., *Biocatalysis and Biotransformation* **33** (2), 111, 2015
- A. Schenk Mayerová et al., *Applied Biochemistry and Biotechnology*, **174** (5), 1834, 2014

Patents

The ISEDS allows to reach one of the world highest detection efficiency and is possible to detect low energy signal electrons within optional energy range and with very high signal to noise ration.

New Ionisation SE detector with electrostatic separator for ESEM (CZ patent No. 299864, EU patent No. 2195822)

For more details and publications see eem.isibrno.cz

MAIN COLLABORATING PARTNERS

Collaboration with academic partners

- University of Cambridge (Cambridge, GB)
- University of Kyoto (Kyoto, JP)
- University of Nagoya (Nagoya, JP)
- Wrocław University of Science and Technology (Wrocław, PL)
- University of technology Sydney (Sydney, AS)
- Charles University (Praha, CZ)
- Brno University of Technology (Brno, CZ)
- Masaryk University (Brno, CZ)
- Mendel University (Brno, CZ)
- Institute of Experimental Botany CAS (Praha, CZ)
- Institute of Chemistry, Slovak Academy of Sciences (Bratislava, SK)

Collaboration with companies

- Hitachi High Technologies (Tokyo, JP)
- Jeol (Tokyo, JP)
- FEI Czech Republic, s.r.o. (Brno, CZ)
- Tecpa s.r.o. (Brno, CZ)
- AutraDet (Brno, CZ)

EXPECTATIONS

Offers

We offer collaboration in the field of research and testing of a wide range of difficult to observe samples in SEM/ESEM. Study of materials under dynamically changing conditions using unique electron microscopes, advanced instrumentations and methods. Partnership in local and international scientific or company projects.

Custom research, development and manufacturing of special detection systems and advanced instrumentation for electron microscopes. Theoretical studies from the field of electron-gas/liquid/solid interactions and gas flow simulations for R&D of environmental electron microscopes.

Requirements

We look for cooperation with academic partners as well as companies in the fields of electron microscopy, physical, life and applied sciences as biology, chemistry, pharmacy, micro & nano-technologies, automotive, etc.

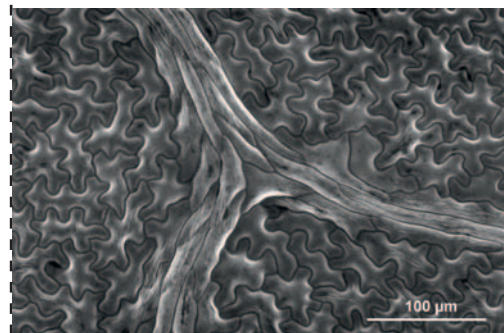

Fully expanded apple leaf, adaxial epidermis formed by puzzle-like cells (ESEM for plant biology)

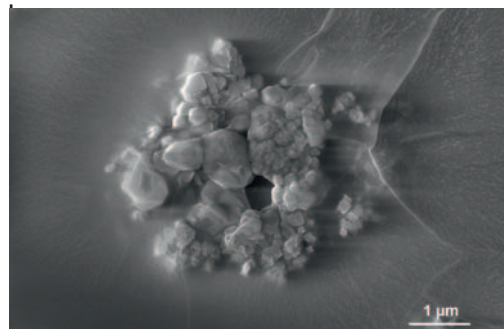

Uncoated SiO₂ nanoparticles in epoxy resin (ESEM for micro/nanotechnology and electronics)

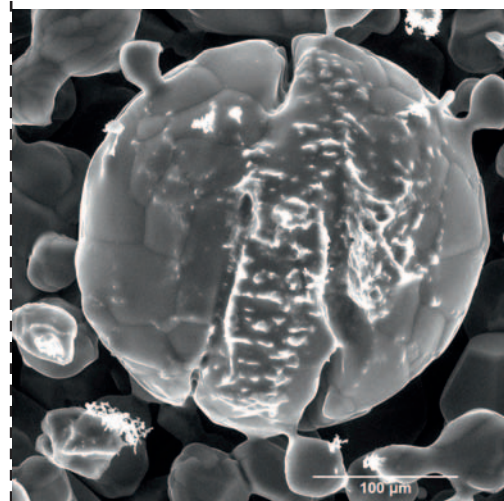

Ice particle with pollutants (ESEM for ice chemistry)

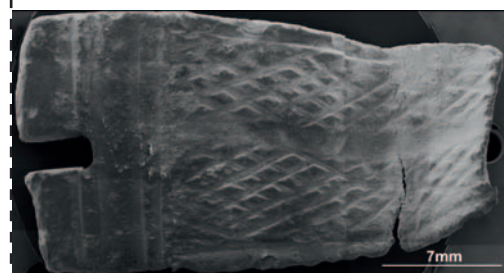

Uncoated buckle (ESEM for archaeology)