

Preface

I have the pleasure to introduce to you a collection of documents presenting the research activities of the Institute of Scientific Instruments of the Academy of Sciences of the Czech Republic carried out in the period 1995 - 1999.

The Institute of Scientific Instruments was founded in 1957 as an institution to guarantee instrumentation for the other institutes of the Academy of Sciences in a number of fields. At the beginning, there were 83 employees. In 1989 their number increased to as many as 240. The transformation process, which was aimed at improving the quality of the scientific work of the specialists of the institute and at dealing with top-quality projects only, resulted in a decrease in the number of employees to the present 95 full jobs. Changes in the scientific structure of the institute were made, and on their basis projects are proposed and dealt with by smaller teams. The teams constitute laboratories and the laboratories constitute departments. There are three main research areas in the institute: electron optics, nuclear magnetic resonance and coherent optics.

In the pre-transformation period, the activities of the institute were concentrated on the development of unique devices that were not available on the market. Its present concept is based on theoretical research, methodology, special technologies and instrument components of original design. The scientific activities of the above mentioned fields of experimental physics include not only fundamental research but, to a high degree, also applied research. The evidence is the extended co-operation with the industry. The institute supports particularly projects based on some original idea, its experimental verification, materialisation and utilisation in industry. In the recent period, the activity of about 25 scientific workers is focused on the research of diagnostic methods for medicine and biology. The diagnostic method of identification of protein particles on a blood cell by means of backscattered electrons, observation of water-containing biological specimens by environmental scanning electron microscopy methods, spatially localised *in vivo* ^1H and ^{31}P NMR spectroscopy of biological tissues (particularly human brain), inverse and optimisation methods directed toward biomedical diagnostics, a new method for the diagnostics of the autonomic nervous system (ANS) which among others controls the adjustment and dynamics of the blood system, and the method of optical micromanipulation of organic and inorganic microobjects and sub-cellular structures inside living cells are examples of the new trend of the scientific activities of the institute started in the past five years.

Traditionally, there is a very good co-operation of the institute with the universities in Brno. Several joint laboratories, about twenty postgraduates each year, professors and associate professors from the range of specialists of the institute, and about twenty diploma students and student-assistants create the backbone of this collaboration.

The favourable image of the institute is due to its excellent and experienced staff, long-term personal policy and up to date management. The institute has gained reputation of a significant research and application centre concentrated on developing non-traditional diagnostic methods used in a number of fields. I thank all that shared in achieving this. Although there are financial problems, problems with instrumentation, and with "escape" of specialists of younger generation, I believe in the full bloom of the Institute of Scientific Instruments in the future.

Brno, 29th November 1999

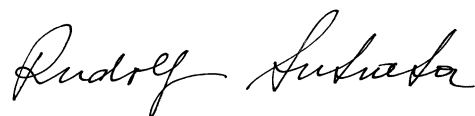

Professor Rudolf Aufrata
Director of the Institute

Contents

| | Page |
|---|------|
| I History | .3 |
| II About the Institute | .6 |
| III Scientific activities and results | .15 |
| IV Recent results | .22 |
| V Publications | .67 |

I

History

On November 16, 1956, the Presidium of the Czechoslovak Academy of Sciences (CAS) adopted the decision to establish the Institute of Scientific Instruments (ISI) in Brno with effect from January 1, 1957. Its basis was the Development Workshop of CAS that had existed since July 1, 1953 and served as the instrumentation base for the growing Academy of Sciences. On January 1, 1960, two smaller institutions of CAS - the Laboratory of Electron Optics (LEO) and the Laboratory of Industrial Electronics (LIE) - joined ISI. In the same year the institute moved to a new building where it has been residing since then. At the very beginning of the 1960s, the scientific concept of the institute was laid down so luckily that it outlasted for more than three decades and has been valid, in a modified form, to-date. It has comprised theoretical fundamentals, methodology, and research and development of instrument parts of three big branches of experimental physics - electron microscopy, nuclear magnetic resonance and quantum light generators.

From the beginning of its existence, the institute was, to a certain degree, considered as a guarantor of instrumentation for the Academy of Science in a number of fields. The institute tried to play this role, though many tasks connected with it were a load that consumed capacities at the expense of the conceptual activity. A big portion of the history of ISI is connected with Prof. Armin Delong who had directed the institute for 29 years (1961-1990). Prof. Delong with his nearest colleague, Prof. Vladimír Drahoš, who died twenty years ago, founded at the turn of the 1940s - 1950s Czechoslovak electron microscopy as a scientific field, one of our most successful industrial branches for many years.

A drastic reduction in the number of employees of ISI during the so-called transformation was far from being painless, nevertheless it happened in a nearly natural way. In the range of activities of the specialists, from theoretical foundations of experimental methods to the development of prototypes of instruments, it was really possible to make a certain partition line. The more theoretically oriented specialists remained at ISI. As a result, the instrument parts production capacity of the institute decreased to a level exceeding only slightly the needs of its own laboratories but the production of original scientific results significantly increased, both relatively and absolutely.

At present, Prof. Rudolf Atrata is the director of the institute, in his second function period. The institute is organised into three scientific departments - nuclear magnetic resonance, electron microscopy and coherent

optics - that are formed by 6 laboratories. In the individual laboratories, teams and projects of related orientation are joined. The departments are led by departmental councils headed by leaders of the departments. The backbone of the institute, where about one hundred physical workers are employed, is formed by regular scientific workers - 30 persons in number to an extent of 23.5 full jobs. Further, 21 doctoral students to an extent of 10.1 full jobs and 10 technically oriented graduates work in the institute. The difference in the physical and converted numbers follows from the effort to educate a maximum number of doctoral students and on the basis of agreements with universities to offer them part-time jobs on the one hand, and on the other hand to make use of help of the retired scientific workers. Collaboration with universities is realised in terms of part-time work of significant pedagogues at the institute.

At the institute, 20 projects supported by national grant agencies and 5 projects supported by foreign agencies (Copernicus, Kontakt, and others) are dealt with on average. At present 16 partially supported joint projects with partners from Japan, United Kingdom, The Netherlands, Canada, Italy, Russia and others are in progress. From the point of view of research financing, collaboration with companies, e.g. those participating in the project „Devices for diagnostics and therapy of oncological diseases“ supported by the Ministry of Industry and Trade, and with companies such as ŠKODA Plzeň, LIMTEK Blansko, Delft Particle Optics Foundation and others is interesting. The list of informal collaborations with foreign universities and institutes from many countries in the world contains several tens of items. ISI is the organiser of two international conferences held every two years. The conference „Recent Trends in Charged Particle Optics and Surface Physics Instrumentation“, in which about thirty individually invited significant scientists from Europe and extra-European countries take part, becomes a tradition that attracts an increasing number of interested participants. The Joint Czech-Japanese seminars „Modelling and Simulation of Non-Linear Systems“ are held alternately in both countries and are a very prestige event in which specialists not only from the organising countries take part. Last year, the ISI scientific workers held 62 lectures at international conferences. Four scientific workers are members of editorial boards of renowned journals. Since its foundation in 1991, the Czechoslovak Society for Electron Microscopy has been residing in the institute. Its present President is the Deputy Director of the institute RNDr. Luděk Frank, DrSc.

The Society succeeded in gaining the organising of the 12th European Congress on Electron Microscopy in Brno.

There are very good relations between the ISI and Brno universities. There are seven joint laboratories in the building of the institute where the work on joint grant-supported projects is carried out and where the student courses take place. On average, over 20 ISI specialists act as pedagogues at the universities. Of them, two are full professors and three are associate professors. ISI signed contracts on scientific education with a number of faculties of Masaryk University and Technical University in Brno.

The Nuclear Magnetic Resonance Department was founded at ISI by Dr. J. Dadok in 1960. At that time he already was the author of the first spectrometer with a frequency of 30 MHz. The industrial production of spectrometers in TESLA Brno began in 1966. It was the only production of that kind in the East-European countries and lasted 25 years. The spectrometers were a very successful export article. As early as 1968, a laboratory for very low temperatures was built in the institute to enable research and development of NMR superconducting magnets and their cryostats. In the 1970s, the department began to deal with Fourier pulse spectrometry. The most significant achievements include a number of priorities in the field of NMR experiment methodology. The specialists attained also a great many original results in the fields of design and generation of magnetic fields in general, data processing and experiment control, spectrometer electronics, etc. At present, the NMR department consists of three laboratories.

The *Laboratory of NMR Tomography and Localised Spectroscopy* led by Ing. Zenon Starčuk, DrSc. is engaged in methodology oriented toward research and development of new single-voxel and multi-voxel methods for spatially localised in vivo ¹H and ³¹P NMR spectroscopy. To measure good quality ¹H NMR spectra with a large information content, methods to suppress with high efficiency very strong water signals and methods to suppress undesirable fat and macromolecule signals have been developed. A package of software operating in Windows NT has been developed which enables processing and presentation of data obtained in different regimes of spatially localised NMR measurements. For precise measurement of gradient magnetic fields in MR systems a new adaptive digital filter has been developed and implemented into digital signal processors Motorola.

The *Laboratory of NMR Electronics* led by doc. Ing. Miroslav Kasal, CSc. is concerned with the development of novel methods of excitation signal generation and NMR signal detection. The aim is to qualitatively improve the existing parameters and to eliminate instrument artefacts. The digital processing of NMR signals allows attainment of a larger dynamic range and suppression of translated signals by several orders, which is important mainly for the measurement of proton spectra of biological specimens with a high content of water. Much attention is paid to the research of resonators for the

imaging and for localised ¹H and ³¹P spectroscopy of biological tissues, particularly of human brain (in collaboration with IKEM Praha). A significant progress has also been achieved in post-acquisition processing of NMR signals. The laboratory co-operates with the University in Pavia, Italy, and with other partners. The results obtained by the specialists of the laboratory have found their use also in other fields. A good example is a novel method used for making diagnosis of the autonomous nervous system developed in collaboration with the 1st Internal Clinic of St. Anna Faculty Hospital in Brno. At present, the method is being tested in clinical praxis and could mean a breakthrough in the field of routine cardiological examinations.

The *Laboratory of Magnetic Fields and Cryogenics* led by Ing. Aleš Srnka, CSc. focuses its effort on the development and generalisation of design methods that enable construction of magnetic systems that effectively generate magnetic fields with defined proton configuration, such as superconducting magnets for NMR, special correction coils, windings with decreased input power, decreased induction, etc. The laboratory is the only workplace in the Czech Republic which designs and thanks to the technological background of the institute also realises for domestic and foreign institutions cryogenic devices operating up to the temperature of supra-liquid helium.

The history of the Electron Microscopy Department at ISI is the history of this field in the country. The Tesla BS242 desktop transmission electron microscope was completed at the time when only three countries in the world were able to manufacture electron microscopes. This microscope was awarded the gold medal of the World Exhibition in Brussels in 1958. It keeps the lead as regards the number of produced pieces of one type of microscope. Its boom era lasted 15 years. Another milestone was the development of the Tesla BS 600 electron lithograph. The development was strictly enforced by the political establishment of that time. It consumed enormous sums of money that however were determined, for the most part, for the partners in industry. Nevertheless, the device was fully comparable with those developed in the laboratories in the world and solved the problem of embargo put by the western countries on advanced technologies. One of the lithographs is now being very successfully used in ISI for the preparation of diffraction and holographic elements. From among the most significant achievements, let us mention the unique instruments that were ahead of their time (ultrahigh vacuum field emission microscope with Auger spectroscopy, tunnel-emission electron microscope, and interference electron microscope), investigation techniques (Lorentz microscopy for the study of magnetic materials, very low energy electron microscopy, etc.), and numerous principles and approaches that were absolutely original or began to appear (systematic dealing with the problem of electron detection, introduction of single-crystal scintillation detectors, methodology and software for parameters computation and electron optical elements simulation, electron-beam welding, etc.).

The Electron Optics Department consists of two laboratories. The *Electron Microscopy Laboratory* led by RNDr. Petr Schauer, CSs. includes scientific teams that concern themselves, with a high degree of independence, with topical problems in this field. The *Laboratory of Special Technologies* led by Ing. Jan Dupák, CSc. comprises teams engaged in the theoretical fundamentals and in the development of electron beam based technologies that are necessary for the construction of electron optical devices operating in vacuum or ultra-high vacuum (electron beam welding).

The Quantum Light Generators Department (Coherent Optics) was established at ISI shortly after the discovery of lasers, and Ing. František Petrů, DrSc. was its leader up to 1991. In 1961, the first Czechoslovak gas laser operating on the 1.15 μ m wavelength was put into operation. The pulse laser was put into operation in 1964 and on its basis the drilling machine for diamonds was later developed. In the same year, 1964, Meopta Přerov exhibited on the occasion of the International Brno Trade Fair three types of lasers developed at ISI. From 1967, the department was engaged in precise measurement of geometrical quantities by using interference methods and in the development of the Czechoslovak laser length sub-standard. In 1981-1982, a laser system for measurement in two coordinates with

a resolution of 40nm and a laser system for velocity measurement were designed and constructed. The present Coherent Optics Department consists of two laboratories.

The *Laboratory of High Coherence Lasers* led by Ing. František Petrů, DrSc. is concerned with iodine-stabilised He-Ne lasers, with an increase in accuracy of interferometric systems, and with two-colour and absolute interferometry. Gradually, more attention is paid to semiconductor lasers operating on the 633nm wavelength. A laser diode based iodine-stabilised system has been constructed and compared with the world laser length standard in BIPM in Paris and with standards of other foreign laboratories.

The *Laboratory for Nanotechnology* led by Mgr. Pavel Zemánek, Dr. is concerned with the use of lasers for optical micromanipulation and microablation. In the period of three years, they succeeded in constructing a device that enables 3D manipulation of organic and inorganic micro-objects and sub-cellular structures inside living cells, in measuring strengths of the pN order that act upon trapped objects, in fusing and sorting living cells according to specific criteria, and in doing controlled destructive operations inside living cells.

II

About the Institute

Director: prof. Ing. Rudolf Autrata, DrSc.

Deputy Director for Science: RNDr. Luděk Frank, DrSc.

Deputy Director for Economics: Ing. Jan Slaměník, CSc.

Scientific Council:

Chairman: Ing. Aleš Gottvald, CSc.

Deputy Chairman: Ing. Jaroslav Sobota, CSc.

Secretary: Ing. Josef Lazar, Dr.

Internal members:

Ing. Karel Bartušek, DrSc.

Ing. Jan Dupák, CSc.

RNDr. Luděk Frank, DrSc.

doc. Ing. Miroslav Kasal, CSc.

RNDr. Petr Schauer, CSc.

Ing. Aleš Srnka, CSc.

Mgr. Pavel Zemánek, Dr.

External members:

prof. Ing. Jiří Jan, CSc.

prof. RNDr. Jan Janča, DrSc.

prof. RNDr. Miroslav Liška, DrSc.

prof. RNDr. Eduard Schmidt, CSc.

prof. RNDr. Vladimír Sklenář, DrSc.

SCIENTIFIC STRUCTURE OF THE INSTITUTE

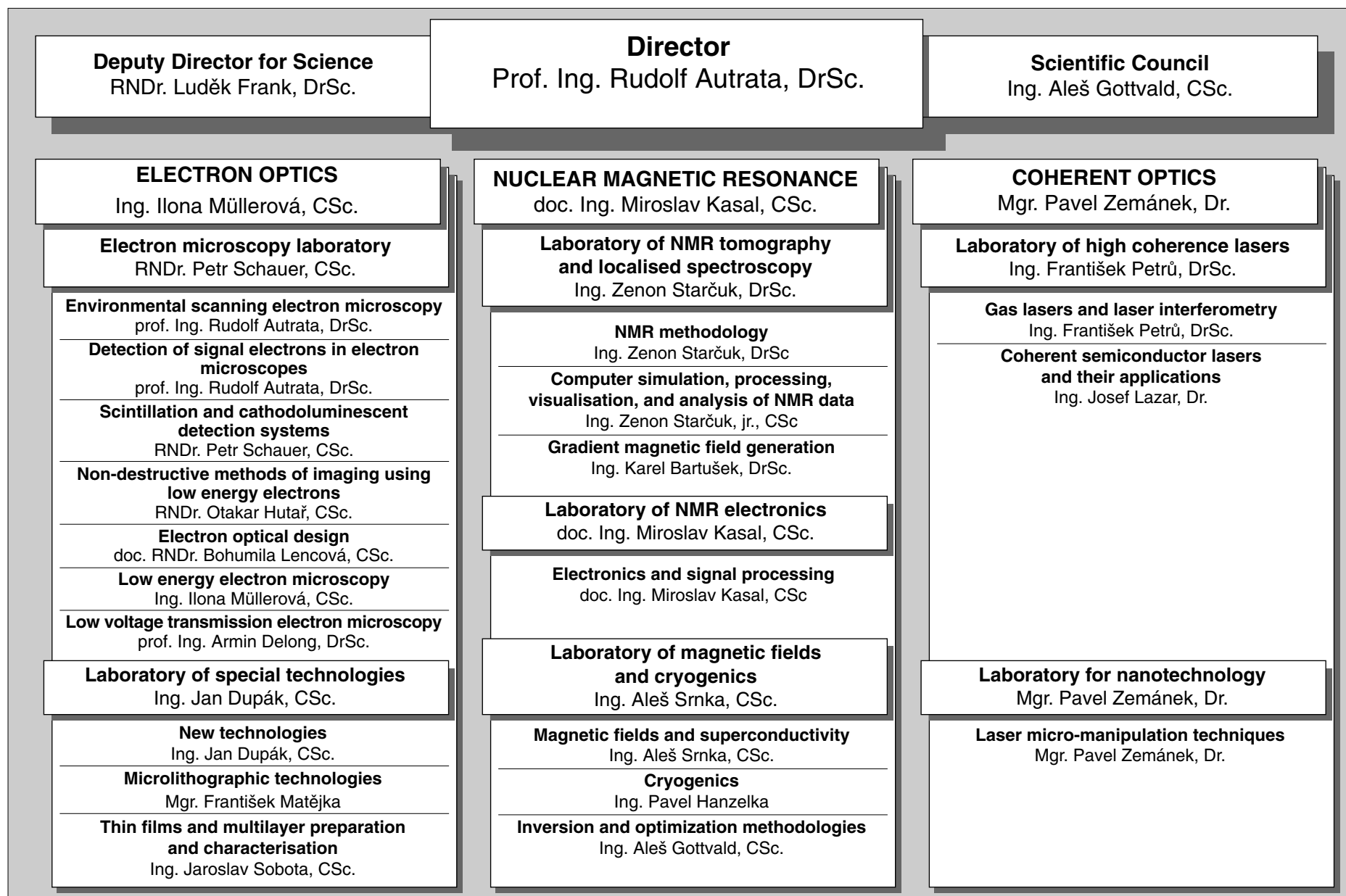

ELECTRON OPTICS

Electron microscopy laboratory

Environmental scanning electron microscopy

At the joint laboratory of ISI and the Institute of Electrical and Electronic Technology of Brno University of Technology, the team is concerned with the problems of scanning electron microscopy whose main feature is a relatively high pressure of gases in the microscope specimen chamber. Physical processes of interaction mechanisms at collisions of electrons with gas molecules, ways of electron scatter in gaseous media, problems of differential evacuation of a microscope, problems of electron scatter in the dependence on the gas medium pressure, etc., are studied. Special attention is paid to the

ways of detection of signal electrons and ions. Scintillation methods, by using single crystal materials, ionisation methods and the combined use of both methods are investigated. Problems of suppression of the electrons carrying the undesirable signal, problems of the attainment of the maximum signal output, problems of cooling a specimen and long term preservation of its wetness in the space of the specimen chamber, etc., are dealt with. Extraordinary attention is concentrated on the investigation of wet biological specimens in their natural state.

Detection of signal electrons in electron microscopes

The team is concerned with the investigation of new scintillation materials based on single crystals of dioxides and with their use in detection systems of signal electrons, particularly in scanning electron microscopes. Special attention is paid to computer simulation of interaction mechanisms between electrons and a solid, to light propagation in light guides, and electron propagation in electrostatic and magnetic fields. Simulation results are compared with the experiment directed at the design of systems for the detection of backscattered and secondary electrons. The team is concentrated on the development of methods of detection of electrons that are difficult to detect,

such as low energy backscattered electrons or electrons propagated in a gas medium. Different modes of information obtained by means of electrons with different take-off angles and energies propagated in different media are studied. The basic methodological conception is connected with the detection systems that ensure attainment of a high resolution image of the studied specimen, enable separation of different types of detected electrons and cathodoluminescent light, record different contrast mechanisms, and make use of the variety of the physical properties of signal electrons in scanning or transmission electron microscopy.

Scintillation and cathodoluminescent detection systems

The team is concentrated on the study of electron interaction in solids, cathodoluminescence, and on the research of noise effects. The team activity includes the Monte Carlo simulation of interaction processes and of related optical effects. The results are used for the construction of detection systems and/or screens for electron microscopes. The essence of the current project is the investigation of properties of single crystal imaging screens (cerium activated single crystals of yttrium aluminium garnet YAG:Ce), and their exploitation in transmission electron microscopy. The project is motivated by the effort to put into practice new imaging components with relatively

small dimensions and a high spatial resolution that will enable gaining of high quality digital images of objects investigated in the transmission electron microscope. The goal of the project is to experimentally determine the spatial resolution and detection efficiency of a single crystal cathodoluminescence screen in the dependence on its thickness. The results of the measurement are compared with the values predicted by the theory and obtained by a computer simulation. The results are used for the design and construction of an imaging unit of the transmission electron microscope.

Non-destructive methods of imaging using low energy electrons

The team concentrates on the study of the characteristics and mechanisms of imaging in scanning electron microscopy by using low energies of the primary electron beam (~1 keV) and on the development of respective detectors of signal electrons. Attention is focused on applications especially in the diagnostics of microelectronic structures and in the monitoring of production processes.

Characteristics of imaging by means of secondary and backscattered electrons are studied and laws of material and topographic contrast by using backscattered electron detection and other attributes, such as edge overbrightening and contamination, are investigated in detail. For this purpose, two types of scintillation detectors of signal electrons - annular and planar - have been developed that

enable alternate imaging in either the backscattered electron mode or in a combined secondary and backscattered electron mode. To optimise the design, the mathematical modelling of the electric fields and trajectories of signal electrons is used. At present, the team is engaged in the research of detection systems combined with retarders of the primary electron beam - the cathode lens and EDOL

system. These systems can continually control the incident energy of the primary electron beam in the range from several electronvolts to several kiloelectronvolts. The problems of the electrostatic charging of poorly conductive surfaces of specimens in the dependence on the incident energy of the primary electron beam and of the influence of a strong electrostatic field are dealt with.

Electron optical design

The members of the group are engaged in the study of electron optical elements and systems from both theoretical and practical point of view, aiming at the improvement of electron optical systems. We have at our disposal our own powerful programs for the computation of electromagnetic fields and their optical properties, with user interfaces developed in cooperation with TU Delft, and programs from University of Manchester, for mechanical design we use the CAD system. Thanks to the specialisation of the team members (e.g. particle optics, vacuum physics, fine mechanics) it is possible to perform theoretical and

mechanical design up to the experimental realisation. At present we are interested in the problems of Wien filter. This interesting element has a practical application in the low voltage scanning electron microscope, and it represents a number of electron optical challenges not only from the point of view of electron optics but also for the mechanical design because of stringent requirements on the accuracy of the combination of electrostatic and magnetic fields. Additional activities are directed towards the improvement of the computer methods of electron optical simulations.

Low energy electron microscopy

The team deals with low and very low energy scanning electron microscopy and its applications. Its activity concentrates on methodology, instrument principles and unique parts of instrumentation enabling one to achieve high resolution imaging at electron energies down to units of electronvolts. The main tasks are elaboration of methods based on variable electron beam energy along the microscope column and exploration of retarding optical elements. Important problems are detection of signal

electrons emitted at very low energies, resolution of the low energy images, specimen preparation techniques and vacuum problems. The main application fields are the study of very clean and defined surfaces including those prepared in-situ in ultrahigh vacuum, observation of real surfaces under medium voltage conditions, observation of non-conductive specimens and comparison of the low energy image signals with electron-spectroscopical signals, e.g. Auger electrons.

Low voltage transmission electron microscopy

The low voltage transmission electron microscope is intended for the study of objects composed of atoms with low atomic numbers, such as biological specimens. By decreasing the accelerating voltage, the image contrast increases many times but at the same time the attainable resolution limit decreases, owing to the diffraction limit and chromatic aberration of the objective lens. The obtained

results are very promising. A number of technical problems were solved due to which the repeated attempts to realise a low voltage microscope failed in the past. The activities are oriented toward correction of optical aberrations (aperture and chromatic ones), alignment automation, astigmatism correction, image computer focusing, and an increase in electron to light image conversion efficiency.

Laboratory of special technologies

New technologies

The team is concerned with the development of technologies and with the design and construction of technological equipment representing the basis for the building of electron optical devices operating in vacuum or ultrahigh vacuum conditions. These technologies include electron beam welding, vacuum brazing, pulse laser welding, development and manufacture of vacuum electric

feedthroughs, etc. A new method of joining metals with brittle non-metal materials by brazing using ductile active brazing solders and a method of electron beam welding of metal materials with different physical properties have been developed. A function model of a desktop electron beam welding machine intended for welding instrument parts has been realised.

Microlithographic technologies

The group deals with the research in the field of microlithographic technology using an e-beam lithograph. Its activity concentrates on large-size microstructure diffractive optical elements for laser-beam forming, sub-micron diffractive holography structures for industrial holography applications, and thin-film metallic and dielectric structures on silicon substrates for biosensors and conductive chemical sensors. This research necessarily

includes the dealing with the following problems: off-line and on-line software enabling exposition of large-volume data, proximity effect, dimension distortion of the deflection field (caused by imperfection of the optical deflection system and by temperature drift), and modelling and simulation of generated structures that simplify the design cycle and enable parameter optimisation.

Thin films and multilayer preparation and characterisation

The group of thin films and multilayer preparation and characterisation has been concerned with r.f. magnetron sputtering of thin films for more than ten years. From the beginning up to now we have been preparing thin films (e.g. Al, Si, Mo, Ti, Ni, Ag, C, ITO, Nb, W, TiN, Si₃N₄, SiO₂) intended for use within projects treated at our Institute. In 1990 we started collaboration with the Department of Multilayers at the Institute of Physics ASCR on the characterisation and production of multilayer systems consisting of a large number of double layers of nanometer thickness for use in x-ray optics. In recent years the collaboration with the HVM Plasma Ltd. in the field of evaluation of film hardness and adhesion led to the study

of sputtered layers of carbon and carbon nitride. Mastering these tasks at our laboratory helped create technological background for prerequisites for the design and realisation of nanostructured multilayers for tools. After establishing contacts with the Surface Engineering and Tribology Group of the Institute of Physics and Astronomy of the University of Aarhus in 1994 practical experiments started at the end of 1995 verifying the possibility of preparation of designed nanostructured multilayer systems. In 1998 we obtained the Joint Project (101/98/0553) having as the main objective the development of a new generation of the coatings for tools with high adhesion, low wear and high performance.

NUCLEAR MAGNETIC RESONANCE

Laboratory of NMR tomography and localised spectroscopy

NMR methodology

Current research activities of the NMR methodology group are concentrated on complex studies of problems of spatially localised *in vivo* ¹H and ³¹P NMR spectroscopy of the brain. Different existing techniques for localised *in vivo* NMR spectroscopy of the brain have been improved and new techniques have been developed in order to make quantification of the acquired *in vivo* NMR spectra more accurate and simple and, as a result, to facilitate and widen exploiting of these promising techniques in clinical applications. In particular, these present research activities aim to acquire the highest possible quality *in vivo* NMR spectra of all available diagnostically important low

molecular weight metabolites. In addition to the proper spatial localisation, this requires dealing with a number of other partial, but nevertheless very difficult, problems such as highly efficient water spectrally selective water suppression, minimisation of contamination of the recorded metabolite spectra by water and lipid signals generated outside the volume of interest, suppression of different origin distortions, efficient differentiation between low molecular weight metabolites and macromolecules and lipids, exploiting 2D and editing techniques in NMR spectra interpretation, and magnetisation transfer effect on the intensity of metabolite signals.

Computer simulation, processing, visualisation, and analysis of NMR data

The NMR experiment simulation activity is focused on the development of mathematical models and simulation of experiments with spatial and/or spectral localisation, i.e. experiments applying frequency selective radiofrequency (RF) pulses and/or magnetic field gradients. The developed

software is used for the design and optimisation of selective RF pulses and pulse sequences for localised *in vivo* spectroscopy. It is used by the cooperating teams as a development and verification tool for their research activity. The primary task in the area of processing, visualisation,

and analysis of NMR data was the establishment of a universal and open software package for the processing and visualisation of multidimensional NMR data on a PC, with the emphasis on various kinds of 2- and 3-dimensional imaging and spectroscopic imaging, with modules for input NMR data conversion from various proprietary formats to a unified representation used in processing and

visualisation, with the possibility of user-defined expansion of the functionality of the package. The current work is oriented towards integrability of this system into an experimental environment and towards the development or integration of special algorithms for data preprocessing and analysis.

Gradient magnetic field generation

The team is occupied with the generation of gradient magnetic fields with minimum rise and decay times in the working space for NMR spectroscopy and MR tomography. The eddy current effects are eliminated by the preemphasis compensation for the gradient systems with and without active shielding. To set precisely the preemphasis constants, the optimisation techniques and the precision measurement of the time behaviour of the gradient field are used. For this purpose, the new NMR method of the gradient magnetic field measurement has been developed. It is based on the selective excitation of the nuclei in the gradient field and on the instantaneous frequency measurement of

the NMR signal (FID) which is proportional to the measured gradient. To increase the measured precision, filtration techniques have been developed, namely the adaptive and wavelet filtration techniques, which increase the S/N ratio of the measured gradient and eliminate the problems with the transient response of the used digital filters. To compensate the preemphasis, a new gradient system with digital generation was developed. It is based on the digital filtration implemented on the digital signal processor (DSP96002). A similar DSP system was used for setting the homogeneity of the static magnetic field using the matrix method.

Laboratory of NMR electronics

Electronics and signal processing

The team is concerned with the development of new methods of excitation signals generation and NMR signals detection in order to quantitatively improve the available parameters and to eliminate instrument artefacts. The signal generation based on the direct digital synthesis of signals and digital modulation makes it possible to achieve substantially more precise interactions of the excitation radiofrequency magnetic field with nuclear spins. The digital processing of NMR signals based on the methods of redundant sampling and digital quadrature detection enables achievement of an essentially broader dynamic range and suppression of translated signals by several orders, which is important for the measurement of proton spectra of biological specimens with high contents of water. Much

attention is paid to the research of rf resonators for imaging and localised ^1H and ^{31}P spectroscopy of biological tissues, especially of the human brain (in collaboration with IKEM Praha). Significant progress has been achieved also in the post-acquisition NMR signal processing. The results are used also in other fields, for example for the measurement and processing of biosignals for the diagnostics of cardiovascular diseases. In collaboration with the St. Anna Faculty Hospital in Brno, a new method of non-invasive measurement of baroreflex sensitivity has been developed which uses controlled breathing for the excitation, and the instantaneous complex value obtained by digital quadrature detection and filtration is evaluated.

Laboratory of magnetic fields and cryogenics

Magnetic fields and superconductivity

The team is concerned with the development and generalisation of design approaches enabling realisation of magnetic systems that generate effectively magnetic fields with the defined space configuration. These approaches are used for designing magnetic systems for various physical experiments, such as homogeneous magnetic fields for NMR and MRI (excited by superconducting magnets),

special shim coils magnetic field, gradient coils for NMR imaging, low power consumption windings etc. The team is also engaged in the development of the measurement methods for the magnetic field mapping and suitable techniques for data acquisition. In the cryogenic field, the calculation methods and analysis of low temperature systems heat flows and optimisation of system parameters

are studied. The results of our study of material properties at low temperatures and special technology techniques are used for superconductivity and cryogenics applications. An important part of our activity is the expertise work in the

area of cryogenics. We are the only laboratory in the Czech Republic that is able to design and manufacture, for domestic and foreign institutions, exacting cryogenic equipment for temperatures down to 1.5 K.

Cryogenics

The main effort of the team is concentrated on the optimisation of the helium cryogenic systems, especially on the possibilities of reduction of the undesirable heat flows. A set of numerical procedures for the calculation of steady temperatures and heat flows in cryogenic systems has been therefore created and is improved constantly. A program KRYOM 3.3 based on the procedures enables one to analyse and optimise usual cryogenic devices. Low temperature material properties are studied by the team in order to evaluate the intrinsic parameters of the investigated cryogenic systems. As the heat radiation is a significant part of the heat flows, the coefficients of the thermal emissivity of materials are examined. The results achieved by the calculation methods are verified experimentally and also by

comparison with the parameters measured on the designed and realised devices. For example, cryostats of the superconducting magnets supporting the development of the NMR spectroscopy and tomography methods at our institute and also special instruments designed and manufactured for foreign institutions could be mentioned. As ultrahigh vacuum technology is an essential discipline applied in cryogenics, the problems of the vacuum generation and its long term maintenance in cryogenic devices are studied, too. The compatibility of the technological and safety standards in the field of cryogenics valid in the Czech Republic and in European countries is investigated.

Inversion and optimization methodologies

The team is engaged in the interdisciplinary study of Inverse and Optimization Methodologies (IOM) in NMR and related domains. A new synthesis and hidden links are sought between generalized resonance phenomena and several seemingly isolated areas: Bayesian Probability Theory, Evolutionary Optimization, Inverse Methods, Information Physics, Neoclassical and Quantum Physics of Resonance, Electromagnetic Field Theory, Deconvolution Spectroscopy, and Digital Signal Processing. An important goal consists in shifting critical parameters of biomedical NMR-experiments beyond their conventional stringent limits. Original tools for the analysis of biomedical NMR-signals and spectra under non-ideal or extreme conditions are being developed. Pioneering some new paradigms of optimal information processing for biomedical NMR is supported by uncertainty analyses and comparative studies with alternative techniques (Fourier-based quantifications,

etc.). A unifying frame is investigated for the complex resonance phenomena under convolutionary and noise artifacts, involving some harmonic, pulse, chirp, stochastic, wavelet, spin-echo and other excitations. Some more fundamental possibilities emerge, too: (a) Bayesian Quantum Theory, which avoids long-time paradoxes and puzzles of standard "Copenhagen" interpretations; (b) Bayesian Field Theory, which clarifies the role of probability, uncertainty and prior information in many problems of electromagnetics; and (c) Bayesian Evolutionary Optimization, which elucidates surprising links between the parameters of evolutionary processes on an algorithmic, biological and brain-informatic level. The team of IOM promotes a large spectrum of international scientific activities especially with its partners in Japan and Italy (workshops, conferences, editorial and lecturing cooperations, etc.).

COHERENT OPTICS

Laboratory of high coherence lasers

Gas lasers and laser interferometry

The activities of the team are oriented toward the field of high coherence gas lasers and their use in laser interferometry. Laser length standards for the 633nm region were designed and constructed. They satisfy all CIPM

parameters for the laser standard. Periodically, comparison of their parameters with those of BIPM standards are made and the resulting data are registered in the list of length standards for the respective field. A new design of cells and

technology of filling them with ultra-pure iodine for laser standards for wavelengths 532, 543 and 633nm have been developed. In the region of shorter wavelengths, the single-frequency mode of the laser operating on the 543nm wavelength has been achieved and a hyperfine structure of the absorption line of $^{127}\text{I}_2$ has been recorded for this region. A laser interference refractometer with an evacuated cell has been designed and measurement accuracy of the order of 10^{-8} has been achieved. At present, work on the

laser refractometer using optical resonators in connection with tunable lasers is in progress. In collaboration with NIST Gaithersburg, an absolute interferometry device that uses a tunable semiconductor laser has been designed, and measurement accuracy of the order of 10^{-6} has been achieved. For gas lasers, laser interferometers and refractometers, special systems of thin optical layers have been designed.

Coherent semiconductor lasers and their applications

The team derives its conception from its research projects and further perspectives and concerns itself with the design of a primary standard of the optical frequency based on a semiconductor laser with an external resonator. Its high stability is derived from narrow spectral lines of molecular iodine that are used for stabilisation. The project consists of not only the design of the laser itself but also of the development and optimisation of the methods of high-resolution laser absorption spectroscopy including modern techniques of digital signal processing. The research in this field and the results achieved are fully comparable with those of the leading world metrological laboratories

contributing to the formulation of recommendations for the primary length standardisation. The team is occupied with the laser resonator design aiming at the attainment of broadband fluent tuneability. The tuneable, high-coherence laser as a source for high-resolution spectroscopy will be a very promising tool for the spectroscopical analysis and also for optical frequency standardisation. The team focuses also on the development of new interferometric techniques of length measurement, where the tuneable laser allows "absolute" measurement, and in the future also surface roughness measurement by means of several discrete wavelengths.

Laboratory for nanotechnology

Laser micro-manipulation techniques

The team deals with problems that are connected with the employment of laser beam interaction with objects for optical micro-manipulation. An experimental set-up enabling optical trapping of micro-objects and nano-objects by means of the optical fields has been built up here as the only one in the Czech Republic. This system is used for our own experimental activities, or for experiments on biological objects that are co-ordinated by our external colleagues. This set-up has been enriched by the possibility of laser micro-ablation that is used for topology modification of optically trapped objects, perforation of inner and outer cell membranes and cell fusion. An original

method employing the gaussian standing wave and objective with a low numerical aperture was suggested and experimentally tested for the optical trapping. The system is being gradually modified to enable generation and independent positioning of several optical traps using a computer. Precise position detection of optically trapped objects can be employed for the measurement of forces in the range from pN to nN. It is the only method enabling estimation of forces comparable to intermolecular ones acting on the neutral objects. Original methods for the cooling and trapping of atoms using the gaussian standing wave have been developed, too.

INSTITUTE IN NUMBERS

Scientific capacity

| Year | University graduates | | Scientists | |
|-------|----------------------|-----------|------------|-----------|
| | Persons | Full jobs | Persons | Full jobs |
| 1995 | 51.39 | 38.41 | 28.77 | 21.63 |
| 1996 | 52.71 | 38.68 | 26.51 | 20.64 |
| 1997 | 58.28 | 41.34 | 30.75 | 24.52 |
| 1998 | 59.46 | 42.61 | 30.51 | 24.23 |
| 1999* | 62.07 | 42.19 | 31.59 | 24.09 |

* until December 1, 1999

Education statistics

| Year | PhD students | PhD degrees awarded | Diploma students | Student assistants |
|-------|--------------|---------------------|------------------|--------------------|
| 1995 | 20 | 1 | 17 | 17 |
| 1996 | 17 | 2 | 10 | 21 |
| 1997 | 16 | 1 | 17 | 15 |
| 1998 | 21 | 1 | 18 | 16 |
| 1999* | 21 | 2 | 10 | 19 |

* until December 1, 1999

Publication statistics

| Year | Monographs | Papers in reviewed journals | Papers in proceedings | Abstracts in proceedings |
|-------|------------|-----------------------------|-----------------------|--------------------------|
| 1995 | 1 | 18 | 40 | 9 |
| 1996 | 4 | 18 | 78 | 23 |
| 1997 | 4 | 29 | 50 | 33 |
| 1998 | 5 | 17 | 63 | 23 |
| 1999* | 2 | 17 | 46 | 25 |

* until December 1, 1999

Travelling to abroad

| Year | Conferences and congresses | | Work and study stays | |
|-------|----------------------------|-------------------------|----------------------|-------------------------|
| | Total | Of these, on invitation | Total | Of these, on invitation |
| 1995 | 29 | 11 | 60 | 15 |
| 1996 | 32 | 4 | 43 | 18 |
| 1997 | 50 | 11 | 53 | 17 |
| 1998 | 29 | 12 | 21 | 14 |
| 1999* | 23 | 10 | 37 | 19 |

* until December 1, 1999

III

Scientific activities and results

SCIENTIFIC EVENTS ORGANISED AND CO-ORGANISED BY THE INSTITUTE

- 3rd Japanese-Czech-Slovak Joint Seminar on Applied Electromagnetics, Prague 1995. Institute of Scientific Instruments (ISI) - co-organiser.
- 2nd Multinational Congress on Electron Microscopy, Stará Lesná 1995. Czechoslovak Society for Electron Microscopy (CSEM) seating in ISI - co-organiser.
- 4th Int. Workshop on Optimization and Inverse Problems in electromagnetism, Brno, June 19-21, 1996.
- Recent Trends in Charged Particle Optics and Surface Physics Instrumentation, 5th Seminar, Brno, June 24-28, 1996. ISI - organiser, CSEM - co-organiser.
- PECO 12283 Project Meeting and Seminar, Brno, July 19-21, 1996. ISI - organiser.
- 3rd Multinational Congress on Electron Microscopy, Portorož, Slovenia, September 1997, CSEM - co-organiser.
- Recent Trends in Charged Particle Optics and Surface Physics Instrumentation, 6th Seminar, Skalský Dvůr, June 29 to July 3, 1998. ISI - organiser, CSEM - co-organiser.
- 3rd Japan-Central Europe Joint Workshop on Modelling and Simulation of Non-linear Engineering Systems and Related Phenomena, Bratislava, September 27-30, 1998. ISI - co-organiser.
- 12th European Congress on Electron Microscopy, Brno, July 9-14, 2000. CSEM - organiser, ISI - organiser.
- Recent Trends in Charged Particle Optics and Surface Physics Instrumentation, 7th Seminar, Skalský Dvůr, July 15-19, 2000. ISI - organiser, CSEM - co-organiser.

COLLABORATION WITH UNIVERSITIES

Joint laboratories and their activities

ESEM Physics Laboratory, Faculty of Electrical Engineering and Computer Science, Brno University of Technology (FEECS BUT)

- Experimental activity oriented toward the study of wet specimens.
- Realisation of electronics for ionisation detectors.

ESEM Demonstration and Application Laboratory (FEECS BUT)

- Study of surfaces of non-conductive specimens and wet biological tissues.
- Construction of new detector systems for the observation of wet specimens in ESEM, and solution of the problem connected with the automatic shifting of the detector (supported by a grant and by Preciosa Crytur).
- Design of a complete system to cool a specimen in the environmental scanning electron microscope and of a system to fill water vapours into the specimen chamber. Recording of images of untreated biological wet tissues with a sufficient resolution.

Laboratory for the study of detection systems (FEECS BUT)

- Development the detector of secondary electrons (SE) and the detector of ionised particles. Comparison of the results obtained using the detector of backscattered electrons (BSE).
- Determination of the signal-to-noise ratio for the scintillation paired detector at different pressures in the specimen chamber, angular distribution of BSE in ESEM, evaluation of trajectories of SE in the electrostatic field for the ionisation detector, and the design of an electrode system for the detection of SE.
- Computer simulation of the operation of the ionisation detector of SE, tests of use of the cathode lens to decrease the energy of primary electron, and of the annular detector of BSE, computer simulation of the detector of EDOL type.

DSP Laboratory (FEECS BUT)

- Design and experimental verification of special digital filters for the analysis of the gradient magnetic field distorted NMR signal in the NMR microscope.
- Creation of conditions for tuition and applications of digital and signal processors (DSP) and methods of digital signal processing.
- Design of an optimum structure of digital filters for DSP96002 their use for the analysis of the gradient magnetic field distorted NMR signal.
- Design of the NMR signal processing procedure used for the elimination of amplitude and phase modulation of the signal distorted by residual gradient fields.
- Study and simulation of the change in the signal-to-noise ratio at the application of the COBALD method to correct spectra baselines. Design of the procedure of modification of input data prior to their processing by the COBALD method that permits spectrum baseline correction with high dynamics of the NMR signal.
- Completion of the first version of the integrated DSPlus96 environment that serves for the development of new designs of the MR signal processing. Design of the digital adaptive filter with DSP96002 for the measurement of gradient fields and creation of the program to realise wavelet transformation with the same processor.
- Use of the original coding technique of wavelet coefficients made it possible to attain for MR images, for which low compression ratios can be achieved in comparison with classical images, a two times higher compression ratio compared with currently available images.
- Experimental verification of the use of wavelet transformation for MR image compression and comparison of the results with those obtained by means of the currently used techniques (e.g. JPEG).

Electron Microscopy and Special Technologies Laboratory (MU Brno)

- Preparation of tips of defined types and structures for purposes of tunnelling microscopy.
- Determination of Avogadro constant by the sedimentation method and by the analysis of Brownian motion.
- Study of materials by tunnelling microscopy.

Optoelectronics and Electron Lithography Laboratory (FEECS BUT)

- Design and construction of the atomic force detector for the material surface analysis by the Atomic Force Microscope and solution of structure of cantilevers on Si₃N₄ membranes.
- Measurement of thickness and profiles of plasma deposited thin layers (TEDS) on silicon and on glass substrates used for the determination of growth rates and properties of layers.
- Realisation of a new data control system based on the PC Pentium NMX and ADSP2181 signal processor.
- Development of exposition software to enable preparation of large-area diffraction structures, which necessitates processing of large volumes of data over 1GB, for laser beam formation (focusing devices, beam splitters, etc.) (Project "ELITO" supported by a GA ČR grant).
- Solution of structures of conductive sensors.

Laboratory for the study of physical properties of polysilylene (FCH BUT)

- Study of metastable states generated by ultraviolet radiation and by the electron beam in poly(methyl fenysilylene) in the frame of research in polymer materials for photoelectrically active detectors (supported by a grant and carried out in collaboration with IMCH AS CR and FCH BUT).
- Study of metastability of one-dimensional Si-polysilylenes with regard to prospective luminescence properties. In particular, the effect of purity and contaminants and the effect of controlled desorption on photoluminescence metastability were studied.

Laboratory for Nanotechnologies (FME BUT)

- Realisation and measurement of optical elements and systems (rhombic and anamorphic prisms, circular and elliptic windows, cell windows, etc.).
- Design and realisation of a standing Gaussian wave based optical trap for nanoparticles and microparticles.
- Use of a gradient optical trap made it possible to three-dimensionally catch fluorescent-labelled nanoparticles of 50 nm in diameter and visualise them by a unique method that makes use of two-photon fluorescence excited by the trapping beam.
- Use of the original standing wave based optical trap for three-dimensional trapping of polystyrene particles of 50 nm in diameter by using an objective with a smaller numeric aperture that enables dark field visualisation of particles.

The most important outcomes of joint activities

- In collaboration with FEECS BUT (Institute of Electrical and Electronic Technology) and under the support of the firm Preciosa, an environmental scanning electron microscope has been built, the ESEM application laboratory has been established, possibilities of x-ray analysis of large specimens were studied, and modification of detector systems as regards especially the detection of secondary electrons for large specimens was carried out.
- In collaboration with FEECS BUT (Institute of Telecommunications), optimal structures of digital filters for DSP96002 and techniques for the processing of signals distorted by residual gradient magnetic fields were designed.
- In collaboration with the College of Chemical Technology in Prague, the evaporation rate of helium from the cryomagnet of the NMR spectrometer was decreased.
- In collaboration with the Faculty of Mathematics and Physics of Charles University Prague, an experimental dilution refrigerator to cool radioactive metal specimens to 10mK in the magnetic field 4T.
- In collaboration with the Institute of Radio Electronics of FEECS BUT, theoretical analysis and experimental verification of the influence of the S/H circuit on the frequency range of A/D converters was made (grant-supported project).
- Together with the Faculty St. Anna Hospital of Masaryk University, original methodology of diagnostics of cardiovascular diseases, based on the evaluation of the instantaneous phase shift between the systolic blood pressure and pulse intervals, was designed. The method of evaluation of the instantaneous baroflex sensitivity (BRS) was experimentally verified. New information is provided by its dissipation which according to the so far obtained measurement results (for 20 healthy persons, 40 patients suffering from cardiovascular diseases) is of essentially higher diagnostic significance than the classical BRS obtained by evaluation in the time or frequency domain.
- In collaboration with the Faculty Hospital of Masaryk University in Bohunice, evaluation of a contrast substance was made by direct measurement of relaxation times T1 and T2 of extirpated organs. A good correlation of the results of this original method with those obtained by MR tomography measurement was found.
- On the basis of long-term collaboration with the Faculty of Mathematics and Physics of Charles University Prague, a small 2.6 T superconducting magnet has been developed for economy NMR measurements of solids at helium temperatures. The specialists of the institute gave consultations when cryogenics laboratories were built at the faculty.
- In collaboration with the Faculty of Mechanical Engineering of BUT, problems of vacuum-tight welds of aluminium with stainless steel were solved (grant-supported project).
- In collaboration with the Institute of Biomedical Engineering of FEECS BUT, problems of identification of distortion functions of NMR signals were solved.
- In collaboration with the Faculty of Mechanical Engineering of BUT and the Faculty of Science of Masaryk University, problems connected with creation of welds of metals with different physical properties were solved (grant-supported project).
- In collaboration with the Institute of Radio Electronics of FEECS BUT, the method for jitter measurement based on the evaluation of the frequency dependence of the output noise of an A/D converter was designed and experimentally verified (joint grant-supported project).
- In collaboration with the Medical Faculty of Masaryk University, a focused laser beam was successfully used for 3D manipulation of sub-cell structures (mitochondria and vacuoles), without any mechanical damage of the test living cell (grant-supported project).
- In collaboration with the Institute of Telecommunications of FEECS BUT, the wavelet filtration of the MR signal, e.g. localised spectrum of the rat brain, was experimentally verified. The use of this filtration is restricted by the low signal-to-noise ratio (<5).
- In collaboration with the Institute of Telecommunications of FEECS BUT, a new adaptive digital filtration method of the FIR type for the filtration of noise in the FID signal for the determination of an instantaneous frequency was designed. The adaptive method significantly decreases the error, compared with the original filtration method of the FIR type with a fixed limit frequency.
- The arrangement of the laboratory for measurement of concentrations of light aerial ions of both polarities for laboratory measurements at the Institute of Electrical and Electronic Technology of FEECS BUT and on open-air sites for purposes of the building industry was designed and experimentally verified.

COOPERATION WITH INSTITUTES OF ASCR, SPECIALISED INSTITUTIONS, AND INDUSTRY

Preciosa, a.s., Turnov

Our institute (ISI) is the co-investigator in the project "Single Crystal Based Devices for Oncology" supported by a grant of the Ministry of Industry and Business of the Czech Republic, and the co-investigator in the project "Health" supported by a grant of the same Ministry. The objective is the use of single crystal materials in scanning electron microscopy.

Tescan, s.r.o., Brno

The collaboration is oriented toward solution of problems connected with electronics of the environmental scanning electron microscope. The outcome of the collaboration is the completion of the electronic control of the microscope installed in the ESEM application centre in ISI.

Delong Instruments, s.r.o., Brno

The subject of collaboration is the construction of a low-voltage transmission electron microscope and the study of its experimental possibilities.

IKEM Praha

Development of methods to increase sensitivity of *in vivo* NMR spectroscopy and tomography. A double-resonance (^1H and ^{31}P) head system has been developed. Its clinical testing is being prepared.

Institute of Physics of Materials, ASCR

Study of detection of electrons in Philips scanning electron microscopes and modification of the original scintillation detector by using a single-crystal scintillator.

Škoda Plzeň

Development of a high-pressure feedthrough for the primary circuit of the nuclear reactor, and of vacuum connectors for nuclear devices.

IBS Velká Bíteš

Collaboration on solution of technological problems arising at manufacture of expansion turbines and low-pressure compressors.

Czech Holography, s.r.o., Husinec-Řež

Joint project: Electron beam shaping of thin structures of polymer substances into surface image microstructures suitable for the basic and applied research of optically active structures and for industrial applications of holography.

Toma, a.s., Zlín

Observation of industrial specimens and of the eyeball surface.

Institute for further education of specialists in health service, Brno

Study of surfaces of tooth cavities treated using a laser drill.

Lachema, a.s., Brno

Study of the influence of drugs on changes of the eye lens.

Research Institute for Wool, Brno

Study of surfaces of textile fibres aimed at determining technology influence.

Synthesisia, Pardubice

Study of surfaces of substrates for printed board technology aimed at increasing copper foil adhesion.

Institute of Nuclear Research in Řež

Technology of welding containers that contain specimens of materials to be irradiated.

Vakuum Praha

Collaboration on the construction of the electron welding machine (company supported project).

HVM s.r.o., Praha

Deposition of hard coatings.

Krejčí Engineering, Tišnov

Thin-layer gas detectors.

Uniplet Třebíč, a.s.

Coating of pole-pieces of knitting machines EDIS.

Limtek Blansko

Laminated laser optics, and laser stability calibration.

DI Brno, Tesla Elmi

Partial modernisation and solution of some problems of NMR spectrometers.

Cryometal Říčany

Thermally technical evaluations of dewar vessels.

Grants awarded by Ministries

- "MR-lymphography using specific paramagnetic contrast agents". Grant no. IZ3027 awarded by the Ministry of Health of the Czech Republic
- "Devices for diagnostics and therapy of oncological diseases". Grant no. PP-Z1/27/98 awarded by the Ministry of Industry and Business.

Significant research projects on the basis of contracts

- "Evaluation of the excited signal of blood pressure for diagnostics of autonomous nervous system", Grant no.4624 awarded by the Ministry of Health, St. Anna Faculty Hospital.
- "Electron beam welding", Vakuum Praha.
- "Electron beam shaping of thin structures of polymer substances into surface image microstructures suitable for the basic and applied research of optically active structures and for industrial applications of holography", Czech Holography s.r.o.
- "Conductivity sensors", Krejčí Engineering
- "Control and data system for the electron lithograph", ELTEK s.r.o.
- "Development of systems for localised spectroscopy and tomography of brain", IKEM, Prague
- "Measurement and processing of biological signals EKG, EEG and BP", St. Anna Faculty Hospital.
- "Technology of the electron system for the integrated detector of secondary and backscattered electrons in the AQUASEM microscope", Preciosa-Crytur s.r.o.
- "Modifications of software and of the electron-optical part of the environmental microscope", Tescan s.r.o.
- "Improvement of electron-optical parameters of the low-voltage transmission electron microscope", Delong Instruments s.r.o.

COOPERATION WITH FOREIGN INSTITUTIONS

International grants and projects, agreements on collaboration

- Novel heterostructure devices and materials assessment for communication and information technologies, PECO 12283, CEC ESPRIT/MEL, 1994-8, University of York, ITP Budapest, STU Bratislava, Institute of Scientific Instruments (ISI).
- New course in advanced materials technology at the Technical University Brno, JEP 2559 PEGAS, CEC, 1995-6.
- Laser stabilization for multi-color interferometric measurement, Joint US-CZ project no. 92065, NIST Gaithersburg, ISI, 1993-6.
- Critical Assessment of Computational Methods in Charged Particle Optics, Collaborative Grant for a Joint Project UK/CZ (Royal Society), University of Manchester, UK, 1996-7.
- Agreement on cooperation, University of Pavia, Italy, since 1990.
- Agreement on scientific cooperation, Inst. Vac. Technol. Warsaw, Poland, since 1995.
- Agreement on cooperation, TU Delft, The Netherlands, since 1989.
- Agreement on cooperation, University of York, UK, since 1998.
- Contract on cooperation with SUJV Dubna, Russia, experiments with oriented nuclei.
- Development of new high efficiency methods of localised MR spectroscopy, grant of Ministry of Health of the Slovak Republic, no. 95-03-02, Derer Hospital in Bratislava, 1995-7.
- Optimisation of the helium necks closures systems of a NMR cryostat, agreement on scientific cooperation, SITEV Srl., Italy, since 1996.
- Primary standard of electric resistance, agreement on cooperation, Institute of Electrical Engineering of the Slovak Academy of Sciences in Bratislava, since 1996.
- Electron microscopy with slow electrons (Elektronenmikroskopie mit langsamen Elektronen), joint project, TU Clausthal (DFG Bonn), Germany, 1994-6.
- High resolution SEM of semiconductor superlattices, joint project, LAMEL Bologna (CNR), Italy, 1995-7.
- Optimisation of a membrane performance in terms of a reduced heat loss, temperature uniformity and mechanical stability, joint project, LAMEL Bologna (CNR), Italy, 1995-7.
- Compact low energy electron microscope for surface imaging, cooperation with Arizona State University, USA, 1996.
- Controlled reactive RF/DC magnetron sputtering of hard coating materials, cooperation with University of Aarhus, Denmark, since 1996.
- Multicrystal X-ray diffraction from high energy implanted silicon and reflection from multi-layered materials, joint project, LAMEL Bologna (CNR), Italy, 1995-7.
- Very low energy scanning electron microscopy, joint project with Shimadzu Research Laboratory, Manchester, and with University of York, UK, since 1998.

- Advanced instruments and methodology for NMR spectroscopy and tomography, agreement on joint project with INFN, University of Pavia, Italy, 1998-2000, grant of the Czech Ministry of Education, Youth and Sport, no.30/66, in the framework of the programme of cooperation between the Czech Republic and Italy, 1999-2000.
- KONTAKT program, grant of the Czech Ministry of Education, Youth and Sport, no. ME 181, cooperation with Japan, Japan-Czech-Slovak Joint Seminars on Applied Electromagnetics., 1998-2000.
- KONTAKT program, grant of the Czech Ministry of Education, Youth and Sport, no. ME 066, cooperation with DFG, Germany, 1997-8
- KONTAKT program, grant of the Czech Ministry of Education, Youth and Sport, no. OK 165, support of the project PECO 12283, 1996-8.
- Agreement on cooperation on the development of software for imaging, research in the field of instrumentation and NMR methodology with Institute for Biodiagnostics (NRC), Winnipeg, Canada.
- CERN, agreement on cooperation on the research and development of special devices, equipment and technologies for the experimental complex COMPASS.
- CRYODATA, Louisville, USA, agreement on the promotion of software KRYOM 3.3.
- Delft Particle Optics Foundation and TU Delft, The Netherlands, agreement on the promotion of software for electron optics.

Informal cooperation with foreign laboratories

- Cooperation with PTB Braunschweig, Germany - Frequency stabilisation of laser diodes in the visible spectral region. Attention is focused on computer controlled precise thermostatisation of the external resonator of a laser system. Preparation of quartz cells filled with superpure iodine.
- Cooperation with the Danish Institute of Fundamental Metrology. Preparation of quartz cells filled with superpure iodine.
- Cooperation with ZPA Pečky, Slovak Republic, on new trends in regulation of power units and automation design.
- Cooperation with "Cryo Anlagebau GmbH" Willnsdorf, Germany - order for manufacturing of polystyrene vessels for LN2.
- Cooperation with CERN on research and development of special devices, equipment and technologies for the experimental complex COMPASS.
- Cooperation with Bruker-Franzen Analytik GmbH, Bremen, Germany.
- Cooperation with Max-Planck Institute of Cognitive Neuroscience, Leipzig, Germany.
- Cooperation with Universität Wien, Institut für Medizinische Physik, Austria
- Cooperation with Universität Wien, AKH, Austria
- Absolute interferometry - cooperation with NIST, USA.
- Cooperation with the Institute of Electronic Engineering of the Slovak Academy of Sciences on Nb/Si Josephson transitions.
- Cooperation with the University of Nagoya, Japan (Prof. Hibino) in the field of cathodoluminescent properties of single crystal screens for TEM with electron energy 100 keV to 1 MeV.
- Low voltage detection of signal electrons, cooperation with JEOL Ltd., Japan.
- High-resolution detection of signal electrons, cooperation with Hitachi Div. Instrum, Japan.
- Cooperation with TU Clausthal, Germany, and Arizona State University in the field of scanning electron microscopy with very slow electrons.
- Detection of biological objects marked by colloidal gold, cooperation with EMBL, Heidelberg, Germany.
- Long-term cooperation on the multicolour laser refractometer, PTB Braunschweig, Germany.
- Ion source of plasma type, cooperation with University in Lublin, Poland.
- Frequency stabilisation of laser diodes in the visible spectral region, PTB Braunschweig, Germany.
- Preparation of quartz cells filled with superfine iodine, Danish Institute of Metrology.
- Organisation of ISEM Symposium, 1999, and OIPEM workshop, 2000, cooperation with the Department of Electrical Engineering, University of Pavia, Italy.
- Distance elements for the NMR cryostat, SITEV Frosinone, Italy.
- Cooperation with University of Minnesota, USA.
- Analysis of tests and dynamic range of ADC, cooperation with Analog Devices, work group IMEKO TC-4, project EUPAS.
- Comparison of numerical evaluations of 2D electrostatic rotationally symmetrical systems by using three different methods of potential evaluation, University of Manchester, Great Britain, in connection with the joint grant of the royal Society 1996-7.
- Cooperation with the Laboratory of surface physics, Latvian Academy of Sciences, since 1998.

The most important scientific results achieved in the frame of international cooperation

- Design and construction of a compact LEEM (Arizona State University, USA)
- First images of wave optical (diffraction) contrast in a scanning electron microscope (TU Clausthal, Germany)
- High-resolution high-efficiency single-crystal screens (University of Nagoya, Japan)
- Optimised design of a BSE detection system to provide high resolution in the microscope with wide pole pieces (Hitachi Ltd., Japan).
- Two-wave refractometer for the evaluation of the absolute value of the refraction index of air (PTB Braunschweig, Germany).
- Comparison measurements of iodine-stabilised lasers (IFTAR, Romania).
- Design of a new atomic trap created by a standing Gaussian wave, its optimisation, and simulation of behaviour of Cs atoms (University of Oxford, Great Britain).
- Helium cryostat with evacuation of helium vapours with temperatures of up to 1,5 K (Institute of Electrical Engineering of the Slovak Republic, Bratislava).
- Controlled reactive deposition of hard coatings, and solid lubricants (University of Aarhus, Denmark).
- High-efficiency high-resolution single-crystal screens in TEM in the range of energies from 100 keV to 1 MeV (University of Nagoya, Japan).
- Single crystal based SE and BSE detection systems (JEOL Ltd., Japan).
- High-resolution detection of signal electrons (Hitachi, Div. Instruments, Japan).
- Imaging of surfaces of biological tissues by means of low energy backscattered electrons (Beiersdorf GmbH, Germany)
- Comparison of numerical evaluations of 2D electrostatic rotationally symmetric systems by three different methods of potential evaluation (University of Manchester, Great Britain).
- Attainment of original experimental results in imaging of multilayer structures by slow electrons (in the framework of a Copernicus project).
- Precise measurements of yields of backscattered and secondary electrons on clean surfaces of a number of elements at low energies (University of York, Great Britain).
- Frequency stabilisation of laser diodes in the visible spectral region, participation in the international measurement of stabilised semiconductor lasers on the 633 nm wavelength (BIPM Paris, France).
- Deposition and characterisation of multilayers and nanostructured coatings (University of Aarhus, Denmark).
- Realisation of an improved television system of an electron image converter for the high-voltage transmission electron microscope (University of Nagoya, Japan).
- Measurement and evaluation of the decay time of single crystal YAP scintillators at very high signal amplification (JEOL Ltd., Japan).
- Development of a miniature scanning ultrahigh vacuum microscope with a field emission gun operating in the electron energy range from 1 eV to 10 keV (University of York, Great Britain).

IV

Recent results

Compact Ultra-High Vacuum Low Energy Electron Microscope

Pavel Adamec and Bohumila Lencová

Detection of signal electrons in scanning electron microscopy

Rudolf Autrata, Petr Schauer, Otakar Hutař, Jiří Runštuk, and Jitka Káňová

Environmental scanning electron microscopy for the study of wet specimens

Rudolf Autrata, Josef Jirák, Jiří Špinka, Jiří Runštuk, Martin Klvač, and Vladimír Romanovský

Adaptive and Wavelet filtration for NMR

Karel Bartušek, Zdeněk Dokoupil, and Radomír Svoboda

Generation of magnetic field gradients for NMR tomography

Karel Bartušek, Zdeněk Dokoupil, and Radomír Svoboda

Method for the scale linearization of the laser interferometer

Ondřej Číp and František Petrů

Miniaturized low voltage TEM

Armin DeLong and Karel Hladil

Desktop E-beam Welding Machine

Jan Dupák, Pavel Kapounek, Eduard Kunc, Miroslav Horáček, Jaroslav Lahoda, Ivan Vlček, Mojmír Sirný, and Martin Zobač

Welding of metals with considerably different properties

Jan Dupák, Pavel Škoda, and Petr Kapounek

Noncharging scanning electron microscopy of non-conductive specimens

Luděk Frank, Martin Zdražil and Ilona Müllerová

Bayesian Evolutionary Quantifications for Biomedical NMR-Spectroscopy

Aleš Gottvald, Roman Malczyk

Processing of the bandpass signal with a large dynamic range.

Josef Halánek, Miroslav Kasal, Vlastimil Vondra, Pavel Jurák, Ivan Krejčí, Vladimír Húsek, and Milan Samek

Dynamic errors of ADC – measurement and analysis

Josef Halánek, Pavel Jurák, Miroslav Kasal, Milan Samek, and Vladimír Húsek

Methods of calculation of steady heat flows in cryogenic systems

Pavel Hanzelka, Josef Jelínek a Věra Musilová.

The blood pressure and heart rate variability evaluation for cardiovascular diagnostics

Pavel Jurák, Josef Halánek, Miroslav Kasal, and Milan Samek

Selective NMR excitation by digital amplitude and phase modulation

Miroslav Kasal, Josef Halánek, Vlastimil Vondra, Vladimír Húsek, Milan Samek, and Radek Václavík

Resonators for in vivo MR spectroscopy and tomography

Miroslav Kasal, Milan Samek, Josef Halánek, Vladimír Húsek, Vlastimil Vondra, and David Bělohrad

The generation, measurement and analysis of high purity correcting magnetic fields

Pavel Konzbul, Aleš Srnka, Karel Švéda

The tuneable source of coherent radiation based on laser diode

Josef Lazar, Ondřej Číp, Petr Jedlička,
and František Petrů

The computer-controlled stabilised He-Ne laser – primary standard of length

Josef Lazar, Ondřej Číp, and František Petrů

Computations of electron optical elements

Bohumila Lencová

Electron-beam lithograph - new exposition software

František Matějka

Sub-micron diffractive holographic structures

František Matějka

First observation of a diffraction contrast in the scanning electron microscope

Ilona Müllerová and Luděk Frank

Very low energy electron microscopy combined with surface chemical microanalysis

Ilona Müllerová and Luděk Frank

Laser interferometer with 0.3 nm resolution

František Petrů, Ondřej Číp, Josef Lazar
and Pavel Pokorný

Laser refractometer

František Petrů, Ondřej Číp, Josef Lazar
and Pavel Pokorný

Interference Multilayers for Lasers and Interferometry

Pavel Pokorný

Single crystal imaging screens

Petr Schauer, Rudolf Atrata, Armin Delong,
Ivan Vlček, Otakar Hutař, Karel Hladil
and Martin Klvač

Nanostructured multilayers

Jaroslav Sobota and Jaroslav Boušek

Broadband and narrowband decoupling using adiabatic spin-inversion RF pulses

Zenon Starčuk, jr., Zenon Starčuk, and Karel Bartušek

Frequency selective RF pulses for NMR spectroscopy and imaging

Zenon Starčuk, Zenon Starčuk, jr., Karel Bartušek,
and Jaroslav Horký

Suppression of unwanted coherences in short echo time *in vivo* proton NMR spectra of the brain

Zenon Starčuk, Zenon Starčuk, jr., Karel Bartušek,
and Jaroslav Horký

Measurement of *in vivo* proton MR spectra of pure metabolites or macromolecules in the brain using a very short echo time STEAM sequence

Zenon Starčuk, Zenon Starčuk, jr., Karel Bartušek,
and Jaroslav Horký

WIN-MRI: Open software system for processing, analysis and visualization of multidimensional NMR data

Jana Starčuková and Zenon Starčuk, jr.

NMR experiment simulator for the development of spatially and/or spectrally selective techniques

Zenon Starčuk, jr. and Zenon Starčuk

Absolute Distance Interferometry

Alois Stejskal

Frequency Stabilization of a Gre-Ne Laser

Alois Stejskal

Direct digital synthesis and study of error signals

Vlastimil Vondra, Miroslav Kasal, and Josef Halánek

The use of the standing wave for manipulation of microobjects and nanoobjects

Pavel Zemánek, Alexandr Jonáš, and Libor Šrámek

The use of lasers for non-contact interventions in the microspace

Pavel Zemánek, Alexandr Jonáš, Libor Šrámek,
Jan Ježek, and Petr Ják

Atomic trap formed by counter-propagating Gaussian beams

Pavel Zemánek

Compact Ultra-High Vacuum Low Energy Electron Microscope

Pavel Adamec and Bohumila Lencová

The work on the project of the Low Energy Electron Microscope (LEEM) is a continuation of former long-term cooperation with Professor E. Bauer of TU Clausthal, Germany, now at Department of Physics and Astronomy, Arizona State University, USA. It was a part of the PhD Thesis of P. Adamec, defended in April 1997.

In the LEEM, the almost parallel beam of primary electrons illuminating the sample is just before impinging on the sample slowed down to 0-200 eV. Electrons with such a low energy can be reflected from the sample surface, and so we can either make an image of the surface or we can observe low-energy electron diffraction (LEED) pattern,

which provides information about the crystallographic structure of the surface. For the study of surfaces we must guarantee very high vacuum in the specimen region. The microscope designed and realized in this project differs from previous LEEM designs in that respect that it is not a complicated and expensive special instrument, but it was designed as an attachment to an UHV apparatus. Consequently it is very compact and light (just 20 kg), so that it does not limit other functions of the apparatus. This has been achieved by using just a small angle of 20° between illuminating and imaging beams in the beam separator, made by a homogeneous magnetic field, and by

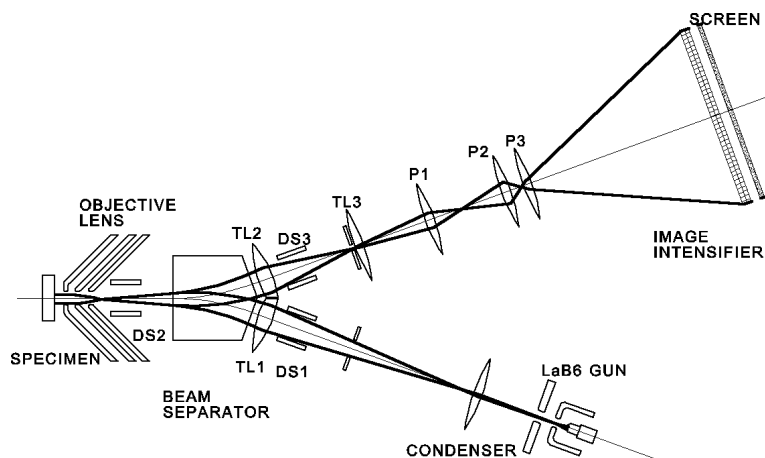

Fig.1. Schematic arrangement of the electron optical system of the microscope.



Fig.1. The view of the assembled microscope.

using electrostatic optics that can be easily operated in an UHV system. The use of electrostatic optics does not bring significantly worse resolution power of the microscope, which is determined mostly by the electrostatic field strength in front of the sample: on the contrary, the use of electrostatic optics allows the unique design of the separator. The sample itself must be held at the earth potential, and so the electron optical elements must be held at a high voltage, and the whole microscope is placed on a single UHV flange with six-inch diameter. Electron optical system of the microscope has been computed with the help of programs developed in our institute, and the separator design was performed with participation of M. Yavor of IANIN, Russian Academy of Sciences. All components of the microscope have been designed and fabricated, and the whole equipment was assembled and tested in USA. It was possible to demonstrate proper functioning of the whole microscope including the observation of diffraction patterns, and the image resolution was, as a consequence of a number of experimental limitations, just three times worse than the theoretical value.

Detection of signal electrons in scanning electron microscopy

Rudolf Autrata, Petr Schauer, Otakar Hutař, Jiří Runštuk, and Jitka Káňová

A beam of primary electrons incident on a studied specimen is a source of signal electrons that are emitted from different depths of their penetration into a specimen and have different energies. Secondary electrons (SEs) with an energy of 3 - 50 eV which are emitted from a specimen depth of about 10 nm are one of the most important types of signal electrons. SEs are therefore the source of topographic information about the structural character of the specimen. Backscattered electrons (BSEs) with an energy of about 80 - 90% of the primary beam energy which are emitted from a specimen depth of about one hundred nanometers, in the dependence of the atomic number of the specimen, are another important type of signal electrons. And this nearly linear dependence of the number of BSEs (expressed by the backscattering coefficient) on the atomic number of the studied specimen creates the diagnostic possibility of studying material distribution of the specimen. Elements with a high atomic number produce a higher BSE signal than those with a low atomic number. This contrast is called material contrast (Z-contrast).

SE detection has become a routine method that has been successfully mastered by employing the scintillation-photomultiplier detector according to Everhart-Thornley (ET). In the scope of the above-mentioned project, some new modifications of the ET detector were made, such as the introduction of a conical single crystal scintillator of yttrium aluminium garnet (YAG) and the introduction of additional electrodes (Fig.1). The SE detector efficiency was improved 2.7times.

BSE detection is, because of the importance of these signal electrons, under continuous study. There are several types of BSE detectors, such as semiconductor detectors, channel detectors and detectors with plastic scintillators. All these detectors do not however fulfil requirements that are the prerequisite for the achievement of a high image resolution. In the course of the project duration, attention was therefore focused on the study of detectors based on single crystal scintillators of dioxides activated by trivalent cerium. These scintillators possess outstanding properties from the viewpoint of efficiency of light generation, lifetime, radiation resistance, temperature and chemical

resistance, and their easy shaping. If a scintillator, e.g. a YAG one, is connected in an optically optimised way to a light guide that guides the generated photons toward the photocathode of the photoelectric multiplier, then the signal-to-noise ratio of this system (Fig.2) is much higher than that provided by other detection methods. The coefficient of the detection quantum efficiency reaches a value of 0.8 at a BSE energy of 12 keV.

Although this detector is intended for the recording of material contrast by using high take-off angle BSEs, also topographic contrast can be recorded if the scintillator - light guide part is split into two halves and signals from both halves are subtracted. Another possibility of topographic contrast recording is the detection of low take-off angle BSEs. For this purpose, the so-called annular BSE detector was designed in which the YAG scintillator has a shape of a ring onto which BSEs with a take-off angle of 0 - 20° are incident. Topographic contrast is a result of detection of those BSEs that have lost a smaller portion of their initial energy during their penetration through the specimen. By changing the position of the specimen or the YAG ring along the vertical axis, the take-off angle of BSEs and consequently also the contrast can be changed.

As the YAG BSE detector shows a decreased sensitivity to low-energy BSEs (0.5 - 1.5 keV), BSEs are accelerated in the electrostatic field produced by the electrode on the scintillator supplied with a voltage of +3 to +5 kV. Because not only BSEs but also SEs are accelerated, a retardation grid supplied with a negative voltage of -100 V is positioned under the electrode on the scintillator. It deflects SEs off the scintillator and in this way a pure BSE image for BSE energies of 200 eV to 1.5 keV, without any influence of SEs, is obtained.

The above-described detectors possess a high signal-to-noise ratio that is a prerequisite for the attainment of a high image resolution. Fig.3 is an image of a broken blood cell. Protein particles on its surface are labelled with colloidal gold with a grain size of 1 - 5 nm. The high resolution of particles and high contrast enable determination of the number of particles on the defined area, which is used for the diagnostics of the state of an organism.

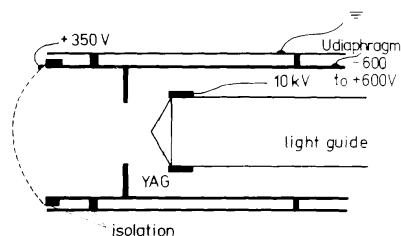

Fig.1. Modified ET-SE detector

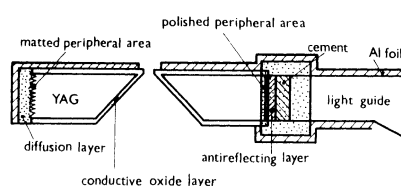

Fig.2. YAG-BSE detector

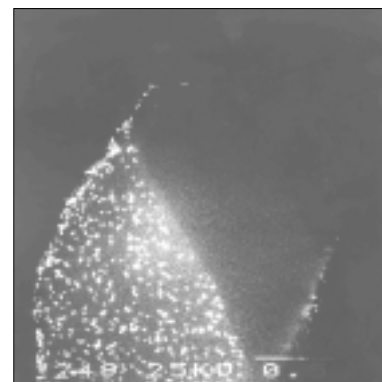

Fig.3. BSE image of protein particles on a blood cell

Environmental scanning electron microscopy for the study of wet specimens

Rudolf Autrata, Josef Jirák, Jiří Špínka, Jiří Runštuk, Martin Klvač, and Vladimír Romanovský

Environmental scanning electron microscopy (ESEM) deals with problems connected with observation of water-containing specimens at pressures of 300 to 2000 Pa in the specimen chamber. The ESEM operation is made possible by separating the microscope column containing electron optics from the space of the specimen chamber by using pressure-limiting apertures and a system for differential pumping of the individual pressure regions. One such possibility is the introduction of a differential chamber fitted closely to the pole-piece. The chamber is pumped separately, and two apertures separate it from the specimen chamber and the microscope column, respectively (Fig.1). The height of the differential chamber must be as low as possible so that it does not limit the working distance and decrease the image resolution. Within the scope of the above-mentioned project, a scanning electron microscope named AQUASEM was realised which enables observation of wet specimens at a pressure higher than that of saturated water vapours (609 Pa at a temperature of 0°C). The problems of gas flow between the regions with different pressures were solved, the scatter of primary electrons in pressure environment was studied and detectors for the detection of signal electrons in ESEM were designed. There are three principles of the detection of signal electrons in ESEM: the scintillation-photomultiplier principle, the principle of multiplication of electrons and holes in the p-n junction of a semiconductor after the impact of signal electrons, and the principle of ionisation current due to the ionisation by collision of molecules of the gaseous medium around the specimen with signal electrons, primarily secondary electrons (SEs). Within the scope of the project, a detection system of original design has been realised in which scintillation and ionisation methods of detection are integrated and which enables separation of vacuum from the pressure region of the specimen chamber. The detection system is based on the single crystal of yttrium aluminium garnet (YAG), split in two optically independent parts for the recording of the BSE signals $A + B$ or $A - B$. It is provided with an aperture (C1) to separate the pressure

in the differential chamber from that in the specimen chamber (Fig.1). From the side of impact of BSEs, a system of circular thin-layer electrodes is deposited on the single crystal. It is used for the ionisation method of detection of secondary electrons by means of electrons and ions generated by the collision mechanism in the pressure environment of the specimen chamber. The ionisation by collision is produced not only by SEs but partially also by BSEs. The principle consists in that in the electric field produced by the electrode system, which is held on a potential of the order of hundreds of electronvolts, an avalanche increase in the number of electrons occurs in the gas, and they are then detected by the electrode system. Using an appropriate arrangement of the circular electrodes, it is possible to achieve suppression of the BSE contribution in the total signal. The process of the ionisation by collision can be optimised by adjusting the detector - specimen distance, pressure in the specimen chamber and potential supplied to the electrodes. The aim is to detect a maximum of SEs in preference to BSEs.

The objective of our project based on the microscope AQUASEM (Fig.2) is the study of primarily biological soft tissues with a high content of water. For this purpose, the microscope has been equipped with a device for freezing specimens to a temperature of -23°C and for filling the specimen chamber with water vapour. In this way, the dehydration of specimens at higher pressures in the specimen chamber was slowed down. Fig.3 below shows the wall of a human stomach. The specimen contains as many as 80% of water and was taken using the ionisation method of detection. The ionisation detector (detects primarily SEs) records topographical contrast, the scintillation detector (detects primarily BSEs) records material contrast in the dependence on the atomic number of the specimen. Because of not too different mean atomic numbers of biological specimens (they contain primarily atoms of C, H, and O), material contrast is much less distinct than topographic contrast.

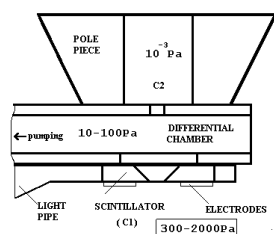

Fig.1. Scintillation BSE detector



Fig.2. ESEM - AQUASEM

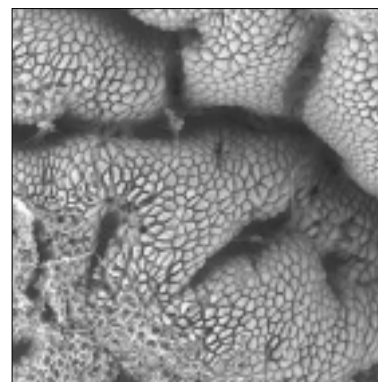

Fig.3. Human stomach
mag.1000x, pressure 500Pa

Adaptive and Wavelet filtration for NMR

Karel Bartušek, Zdeněk Dokoupil, and Radomír Svoboda

Noise and transient properties of current digital filters are ones of the limiting parameters when dynamic properties of gradient magnetic fields generated in systems for MR tomography and MR localised spectroscopy are measured. The NMR technique for the measurement of time and spatial characteristics of magnetic field gradients is based on a high accuracy measurement of an instantaneous frequency of a FID signal. The derivation of an instantaneous phase of a complex FID signal and an increase in its amplitude due to relaxation properties of nuclei cause a steep rise of the noise amplitude in the course of nuclear decay of the measured specimen. To increase the precision of the measured gradient, it is necessary to use an efficient filtration technique. Filtration may not increase the fault of the measured gradient, either for the beginning of the time characteristic (which leads to inaccurate determination of short time constants) or for long times (a long time constant fault occurs).

When the classic filtration of a FID signal with an exponentially variable instantaneous frequency is made using a filter of the FIR type, a high distortion of the first points of the signal takes place. This is due to the shape of the filter impulse characteristic. The distortion can be decreased by the signal time inversion technique developed at ISI. The principle of this technique is to split the output signal of the filter into two parts in time corresponding to the filter group delay. The time-inverted first part of the output signal is added to the second part. This way, the amplitude modulation of the beginning of the filtered signal is significantly decreased but the faults of its instantaneous frequency will be considerably high.

The use of a digital FIR filter with a constant bandwidth cannot significantly increase the signal-to-noise ratio (SNR). For this reason, an adaptive filter was designed and

tested for which the width of the transmission band changes in time according to the character of the input signal. Prior to the beginning of the filtration, constants and limiting frequencies of low-pass FIR filters designed using the algorithm REMEZ are stored. According to the instantaneous frequency of the signal at the immediate output of the filter, filter constants for the next filtered stage are chosen. If an adaptive filter is used, a measurement error of the instantaneous frequency of the FID signal can be decreased to a level <10 Hz (i.e. $<0.3\%$). The distortion of the beginning of the instantaneous frequency characteristic must be removed by other techniques, e.g. the time inversion technique.

Both disadvantages of the FIR filter can be eliminated by filtration making use of wavelet transformation (WT). The input signal is transformed by WT. After choosing suitable wavelet coefficients (deletion of coefficients smaller than the chosen limit), reverse WT was carried out and an output signal was obtained. The filter making use of WT decreases the fault at the end of the measured time characteristic to a value <500 Hz, and at the beginning of the time characteristic no additional distortion occurs. By additional sliding window averaging, the measurement fault of the time characteristic of the instantaneous frequency can be decreased to a level <10 Hz.

Time characteristics of the instantaneous frequency determined from the complex FID signal by using different types of filtration are presented in the figure below. It is evident from the figure that filtration made using the classic FIR filter does not significantly improve the SNR. The most advantageous type of filtration is the wavelet filter cascading and sliding window averaging for which the measurement error is less than 10 Hz.

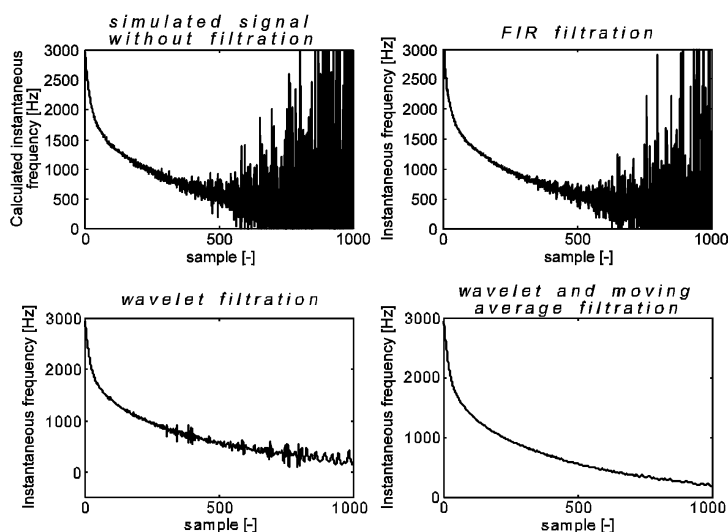

Fig.1. Time characteristics of the instantaneous frequency determined from the complex FID signal.

Generation of magnetic field gradients for NMR tomography

Karel Bartušek, Zdeněk Dokoupil, and Radomír Svoboda

One of the main problems of MR tomography and localised MR spectroscopy is the generation of magnetic field pulse gradients, with a good homogeneity and minimal rise and decay times, to the level of inhomogeneity of the basic magnetic field. A fast decrease in the magnetic field gradient is hindered by induced eddy currents in conductive materials placed in the vicinity of gradient coils. To decrease the influence of eddy currents, an active shielding of gradient coils and preemphasis compensation can be used. An active shielding is an additional coil positioned outside a gradient coil that produces such a compensating magnetic field that in the place of conductive materials decreases the amplitude of the generated magnetic field or eliminates it. A disadvantage of the active shielding is that the working space diminishes by more than 30%. Preemphasis compensation using a precisely defined excess of current flowing through the gradient coil eliminates the eddy currents effect, and the gradient field rise (decay) will be maximally fast. A disadvantage of this technique is a high demand on the accuracy of determination of preemphasis constants.

A precise analytical description of induced eddy currents is complicated and corresponds to an only one constructional arrangement of a magnet. A rough analysis of generated gradient magnetic fields suggests the necessity of using complex preemphasis compensation, i.e. any gradient direction and all cross-couplings among the individual gradients must be compensated. To set preemphasis compensation, NMR methods for precise measurement of gradient decay time characteristics have

been developed at ISI, which serve for the determination of preemphasis constants.

The technique called "Instantaneous frequency method" is based on selective excitation of a thin layer in a spherical whole-volume sample positioned off the electric centre of the gradient system. Nuclear excitation takes place in the gradient field and the NMR signal is recorded after the end of the gradient pulse in the presence of the residual gradient field. By evaluating the instantaneous frequency of the NMR signal we obtain the gradient field decay time characteristic. Approximation of a multiexponential characteristic can be used for the determination of compensation constants for a digital preemphasis filter. The pulse sequence used is shown in the figure. Noise along the whole measuring path significantly decreases the measurement accuracy. To increase the accuracy, the measurement is made in two steps. First, the adaptive setting of preemphasis constants is carried out in several separate measurements. Then, the found constants are further optimised using a model where noise is eliminated and higher-order optimisation techniques are used.

Using the above-described method, the time characteristics of the decrease in the gradient magnetic field were measured with an accuracy of 5×10^{-4} . The figure shows the time characteristic of the gradient G_x without and with optimally set preemphasis compensation. Using a special pulse sequence, it was verified that the gradient field decreased to the level of inhomogeneity in 10 ms. The experimental verification was made on the 200 MHz home-built NMR system adapted for microscopy.

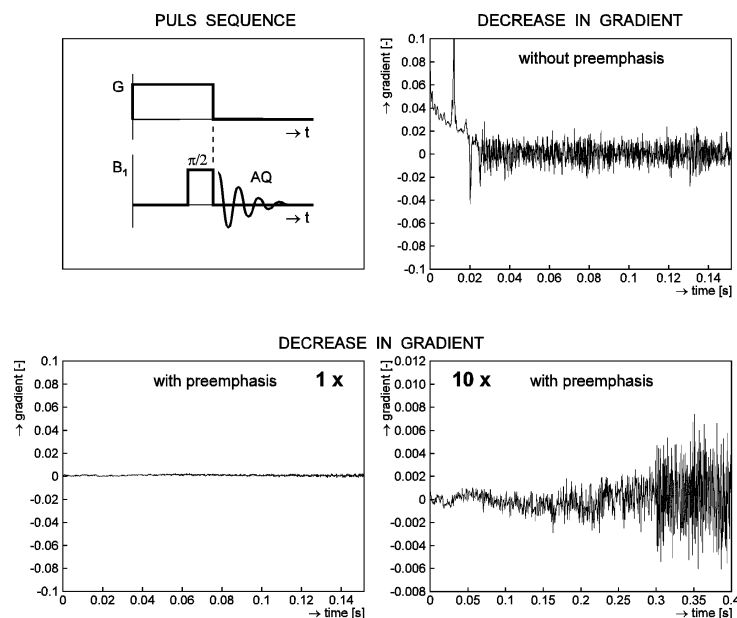

Fig.1. Test pulse sequence and measured time characteristic of G_x gradient without and with optimally set preemphasis compensation.

Method for the scale linearization of the laser interferometer

Ondřej Číp and František Petřů

Laser interferometers are increasingly used for the most precise measurement of lengths and other geometrical quantities, such as travel straightness and perpendicularity, for the measurement of oscillations, and for similar applications. The measurement of lengths using a laser interferometer may be traced to the SI base unit for length - the meter. The resolving power of the interferometer is high, owing to the short wavelength of light of the lasers commonly used (usually 633 nm) and owing to the subsequent electronic division of the interference fringe spacing into fractions.

Difficulties with the scale linearity occur when subdividing a fringe with high resolution in the nanometer region. The single-frequency interferometer uses detection technique based on the fringe division where are two output signals in quadrature (with phase difference $\pi/2$). The amplitude ratio of signals represents tangent of an actual phase between the measurement and reference beam of the interferometer. If the interferometer is not possible be adjusted properly, the phase error can arise as a consequence of the interference of two spherical wavefronts whose axes of propagation are not identical (either parallel-shifted or at an angle). In such case the relation between the amplitude

ratio of quadrature signals and tangent of the actual phase is nonlinear and the measurement by the interferometer has an error because the course of quadrature signals has elliptical distortion. The error can be eliminated by specialized mathematical method which fulfils the expectation of the minimum influence of the fringe distortion caused by a phase difference from $\pi/2$ between two quadrature signals and the amplitude difference of signals.

The method is based on the real-time measurement of parameters of the detected interferometer fringe and an optimal approximation of the quadrature signals course by a conic section in Cartesian plane. The obtained parameters are transformed from the analytical form to the parameter form of the equation of the conic section and an inversion function is established. The final calculation is based on the inversion function. The method has been verified by an experimental measurement on the 4-path Michelson's interferometer with the total resolution $\lambda/2048$ using the Soleil-Babinet compensator. The reproduced measurements with an error less than 0.3nm are available now. Example of linearized scale of the interferometer by the method is shown in Fig.1.

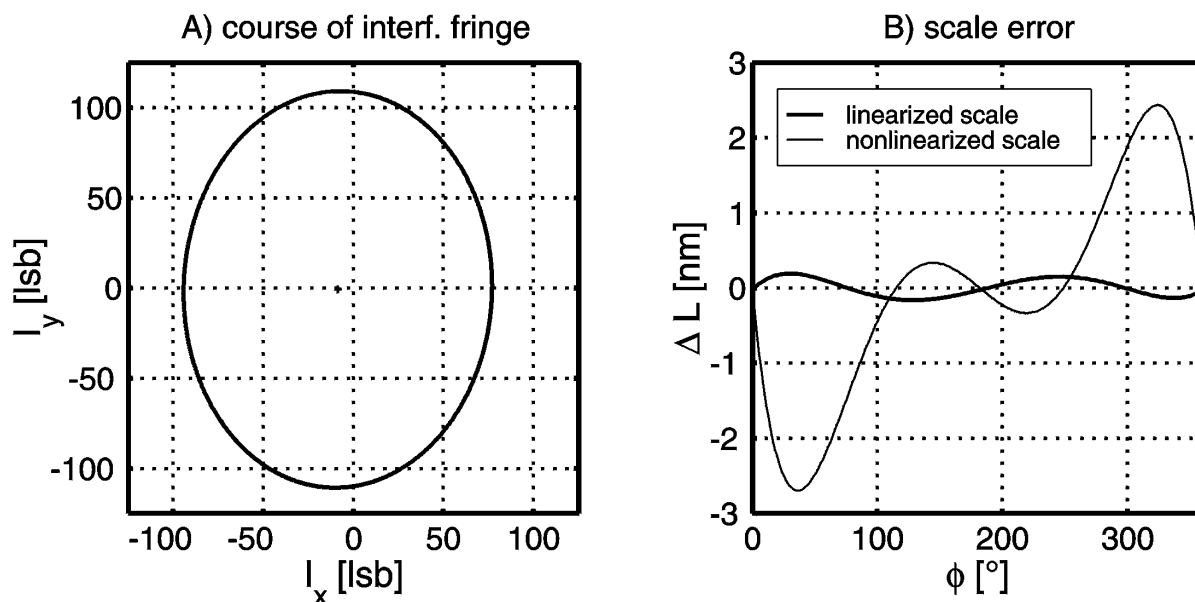

Fig.1. Example of the scale linearization of laser interferometer. A) course of quadrature signals of an distorted interference fringe. B) course of linearized and nonlinearized scale of interferometer vs. true phase between two interference laser beams.

Miniaturized low voltage TEM

Armin Delong and Karel Hladil

The contemporary transmission electron microscope (TEM) is a very powerful instrument that enables one to observe structures of solids with very high resolution, and in the case of crystals even their atomic structure. The resolution depends, in principle, on the wavelength of the moving electron - the higher the energy (given by the accelerating voltage) the better the resolution. On the other

hand, the contrast of the image decreases with increasing accelerating voltage (Fig.1). Especially biological objects, composed of elements with low atomic numbers, are imaged with an insufficient contrast influencing also the resolution. This is the reason for the existence of the low voltage TEM (LVTEM).

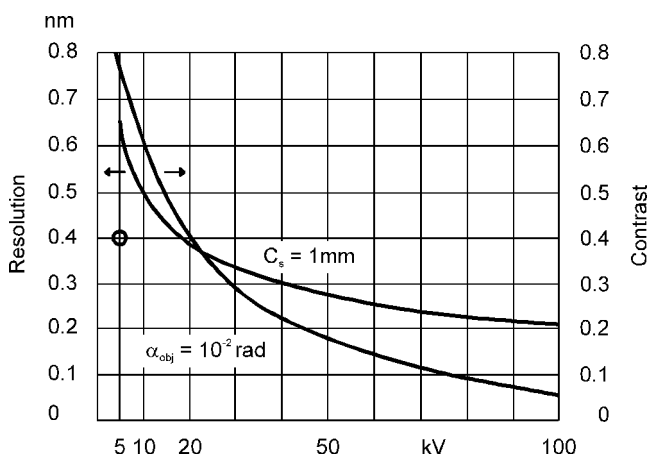

Fig.1. Dependence of resolution and contrast of TEM on accelerating voltage. The resolution ($d = 0.43 (C_s \lambda^3)^{-1/4}$) is given for lenses with the same coefficient $C_s = 1$ mm. The dependence of contrast holds for a carbon foil 20 nm thick.

LVTEM is composed of two microscopes, a small electron microscope with magnification of maximum 250 times with a single YAG fluorescent screen and a standard high quality commercially available light microscope with magnification as many as 400 times. This design has several advantages from different points of view:

- The projection system composed of a single crystal fluorescent screen and a light microscope has high light transport efficiency, compared with the direct observation of the fluorescent screen. A 10 000 times less amount of light comes into the entrance pupil of a naked eye, compared with the objective lens with the numerical aperture $NA=1$.
- This design is feasible when energy of 5 keV is used. At this energy, the scattering of electrons in the YAG screen is relatively low, compared with electrons with higher energy (e.g. 20 keV).
- The light microscope can be attached by means of a CCD camera to a PC for image recording and processing and for TEM alignment, astigmatism correction and automatic image focusing.

The original idea to use an ergonomical design of a modern light microscope for LVTEM can be realised using the miniaturised electron optical column only. This requirement was fulfilled via electron lenses with permanent magnets of new construction, which enable one to reach low aberration coefficients. An electron source with the Schottky emission cathode with high brightness was necessary not only for good image observation, but also for using the instruments in a scanning mode.

The theoretical resolution can be improved in the future several times using some of different methods of aberration correction.

The microscope is easy to transport and the demand for the installation place is very modest. The need to use a specimen as thin as possible can be fulfilled practically for all specimen preparation techniques.

LV TEM is also interesting from the point of view of a low price and low working expenses.

Desktop E-beam Welding Machine

Jan Dupák, Petr Kapounek, Eduard Kunc, Miroslav Horáček, Jaroslav Lahoda, Ivan Vlček, Mojmír Sirný, and Martin Zobač

The desktop e-beam welding machine is intended for welding parts usually made of special materials used in instrumentation. The outstanding features of the realised functional model are its high productivity, easy operation and the possibility of its adapting for different welding processes.

The vacuum working chamber is a horizontal-axis cylinder of 230 mm in inner diameter, and 200 mm long. Its lateral area is provided with holes intended for the connection of an electron gun, manipulator and extension tubes to enable welding of extremely long parts. In the front hinged cover is a sight glass that allows observation of the welding process. A pumping system is connected to the rear cover of the chamber. It consists of a turbomolecular and a rotary air pump and enables one to reach the working vacuum in the chamber in about two minutes and a half. One Pirani and one Penning vacuum gauge are used to measure the vacuum and to control the automatics of the pumping process.

The electron gun is constructed so that it is not necessary to use another auxiliary pump to evacuate the cathode

space. This enables its easy mounting into various positions on the working chamber. As the electron source, a field emission gun is used which together with the control electrode creates an easily replaceable unit. The electron-optical part of the gun consists of centring coils, an electromagnetic lens and a deflection system that enables $\pm 35^\circ$ deflecting of the beam along axes x and y . The electron gun is supplied from a high voltage supply of 0 - 60 kV with an output power of 2 kW.

The manipulator used allows rotary and rectilinear motion of the weld. The position of the electron gun, manipulator and extension tubes can be changed so that the machine can be adapted for a great many requirements. To carry out the most usual rotary lateral welds, the manipulator is positioned in the bottom hole of the chamber and the electron gun is in the horizontal position. For front welds, the electron gun is shifted to the perpendicular position opposite the manipulator. Edge welds can be realised by deflecting the electron gun.

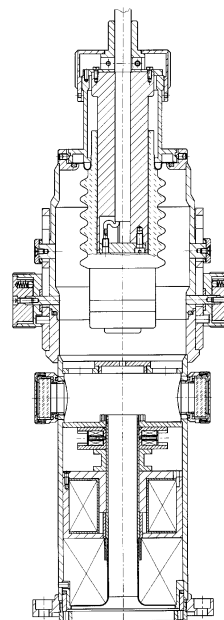
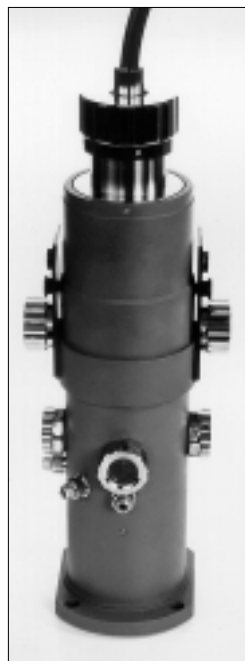

Elektronové dělo

Welding of metals with considerably different properties

Jan Dupák, Pavel Škoda, and Petr Kapounek

The new electron beam welding technology makes it possible to produce vacuum-tight and mechanically resistant joints of materials with considerably different metallurgical properties, e. g. Ti-Al. When the classical melting technology is used for welding these materials (both are in liquid state and their mixing occurs), fragile intermetallic compounds arise in most cases, and owing to their small strength, the produced joints are of no practical importance. Therefore we apply the heating method which ensures that only the lower-melting-point material is melted and in it the higher-melting-point material is partially dissolved, so that a solid solution without any fragile phases is produced at

the interface. The pre-requisites for the creation of a good-quality joint are the existence of the area of partial solid solubility in the phase diagram and a sufficiently large difference between the melting temperature of both materials. We used the described method for making welds such as Al-Cu, Al-Ni, Al-Ag, Al-Ti, and stainless steel with aluminium, copper, molybdenum and niobium. Main attention was paid to the welding of aluminium with titanium, because this technology was used when a nitrogen cryostat with required minimum values of evaporation was designed.

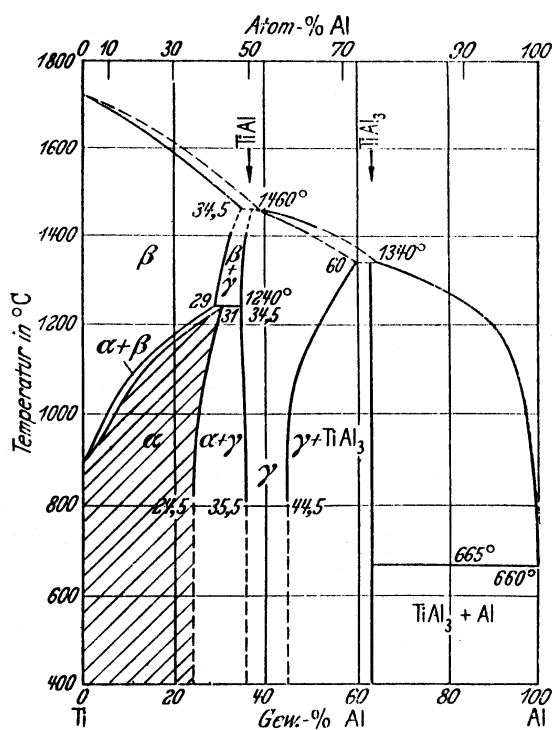

Fig.1. The phase diagram for Ti-Al

Noncharging scanning electron microscopy of non-conductive specimens

Luděk Frank, Martin Zadražil and Ilona Müllerová

In the scanning electron microscope (SEM) the specimen is bombarded by a focused beam of primary electrons and the emitted secondary and backscattered electrons are detected to form the image signals. The total charge balance is generally not in equilibrium - the numbers of incoming and outgoing charges are unequal and some charge is dissipated within the specimen. The specimen current can be used as an additional image signal for conductors but in insulators the dissipated charge remains concentrated near the impact point and forms a local electric field. This field influences the trajectories of both primary and signal electrons and consequently destroys the image, and it can even endanger sensitive parts of the instrument. Thus, non-conductive specimens have to be made conductive before microcopying, which is made by a suitable coating or staining. This operation complicates the specimen preparation and alters the specimen appearance and properties so that it is highly desirable to avoid it.

One possibility is to carefully measure the energy value at which the total electron yield amounts to one, i.e. when the numbers of incoming and outgoing electrons are equal. As a rule, such an energy value does exist for a great majority of materials and biological specimens. This idea has been elaborated into a novel method of the SEM observation of non-conductors. The prerequisite was the adaptation of SEM to the version with low energy microscopy by means of the cathode lens. It decelerates the primary beam to an arbitrarily low energy without sacrificing the image resolution, and a minimum realignment is necessary when the energy is changed. The electron yield curves cross the unity level, and the surface charge changes its sign, at a critical energy somewhere between 1 and 8 keV. An important property is that during the build-up process of the surface charge the critical electron energy adjusts automatically by the surface potential which increases up to a charge balance when the

further charging stops. This means that effectively a certain movement along the electron yield curve occurs and the yield varies. The principle of the novel method consists in the measurement of the total electron signal in time, and in the search for an energy at which the signal change is minimum. Even for a single electron energy value, the measurement has to be made in many points not illuminated before because the critical energy depends on both the local specimen composition and surface relief inclination. This brings some average values for the viewfield as it was verified on a broad spectrum of specimens of various types. The accuracy of the critical energy measurement was found to be approximately ± 50 eV that is a value similar to the critical energy spread due to, e.g., variations in the local surface inclination on a fibrous specimen. If the spread caused by the composition heterogeneity does not exceed some fuzzy limit of about 100 to 200 eV, the image can be taken at an optimum energy so that it exhibits no traces of charging.

The method has been fully automated using a computer controlled SEM where the signal measurements are made in a preselected net of image points for a preselected set of energy values adjusted by means of a computer controlled high-voltage supply for specimen biasing. The acquired signal vs. time curves are statistically processed and the resulting quantity for each electron energy is the measure of the total signal change during the charging-up process (i.e. the charging-up curve). The examples below show the charging-up curve for the surface of a textile specimen, the micrograph (in the centre) taken at 1200 eV where the curves cross the zero level, and the comparison image taken at 1700 eV which demonstrates the charging-up phenomena. The method is extremely suitable and promising for microscopy of non-conductive materials and biological specimens in general.

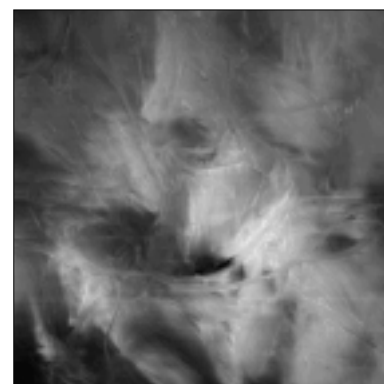
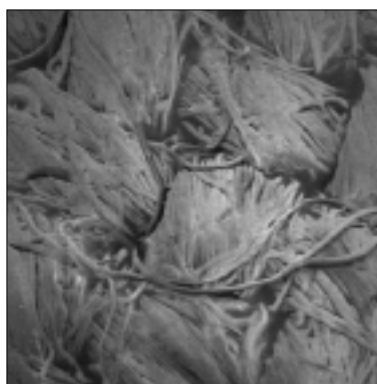
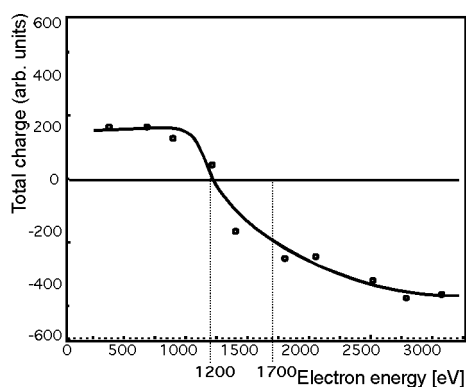

Bayesian Evolutionary Quantifications for Biomedical NMR-Spectroscopy

Aleš Gottvald, Roman Malczyk

A huge potential of NMR for biomedical diagnostics now needs no advocacy. However, if the sensitivity, resolution, time demands, costs, reproducibility, and other critical attributes of biomedical NMR-experiments would be shifted significantly, this methodology would be adopted for routine clinical applications on a much wider scale. A particular modality where the above limits are strongly perceived is *In Vivo NMR-spectroscopy*. A central problem consists in *spectra quantifications*. Minimizing the *uncertainty of quantifications* requires all forms of *contextual knowledge* ("prior information") which is available to the spectroscopist. Conventional quantification paradigms (e.g., based on Digital Fourier Transform, DFT) often impose some stringent limitations and systematic errors - especially for large deviations from ideal conditions.

Bayesian probabilistic methods offer a novel systematic rationale for reducing the above limitations. To incorporate a large class of important realworld artifacts to the quantification scheme, we derived a *generalized model of NMR signals and spectra*. The physical frame describes complex interactions between the magnetic fields inhomogeneity and instability, additive noise, amplitude and phase modulations, initial and terminal truncations, apodizations and linear filterings, etc. Methods for the *distortion function identification*, providing some important prior information, were developed and tested using both synthetic and experimental data. A concept of *generalized NMR-spectroscopy* has been elaborated as well. This concept involves the classical (CW) and pulse (FT) spectroscopies as two limit cases, and, as an intermediate case, the rapid-scan "correlation" spectroscopy devised by Dadok. For solving the associated *inverse problems* (the model parameter quantifications subject to constraint conditions), a biologically inspired *Meta-Evolutionary optimization* was elaborated. This original concept mimics a darwinistic evolution theory and brain information processing. The amalgamation of the Bayesian and

Evolutionary methodology is very flexible with respect to various forms of prior knowledge (parametric models, distorting functions, constraint conditions, noise distributions, ...).

Computer programs for the simulation, visualization and quantification of the generalized NMR-signals and spectra were implemented, and some comparative studies between the Bayesian-Evolutionary and DFT-based quantifications were elaborated. Our findings, still restricted to synthetic and quasi-experimental data, show that the Bayesian-Evolutionary quantifications are much less susceptible to various data artifacts than their conventional DFT-based counterparts - especially for large deviations from ideal conditions. In other words, reducing the uncertainty of initial parameter estimates, determined by some conventional DFTbased scheme, is very likely. In a good agreement with recent findings of several other authors (e.g., Bretthorst et al.), some critical attributes of NMR-experiments (sensitivity, resolution, time demands, ...) may often be shifted - sometimes even dramatically. The Bayesian-Evolutionary quantification may also be used for *optimal spectra restorations* (deconvolution, denoising). As an illustration, a quasi-experimental *In Vivo* phosphorus spectrum of human brain, strongly distorted with an inhomogeneity and noise, was optimally restored (see figures below). This restoration is not exact, but only the most likely with respect to some explicitly defined prior information. Moreover, a systematic *uncertainty analysis* helps us to see neither "too much" nor "too little" in our NMRdata. Also this "safety feature" is unique and generally not available in most conventional non-Bayesian quantification paradigms. As the diversity and complexity of prior information in biomedical *In Vivo* NMR spectroscopy is generally very large, the Bayesian methodology actually opens a large program which is far from its closure. More detailed investigations using clinical experimental data are underway.

In Vivo ^{31}P SPECTRUM DISTORTED BY INHOMOGENEITY & NOISE

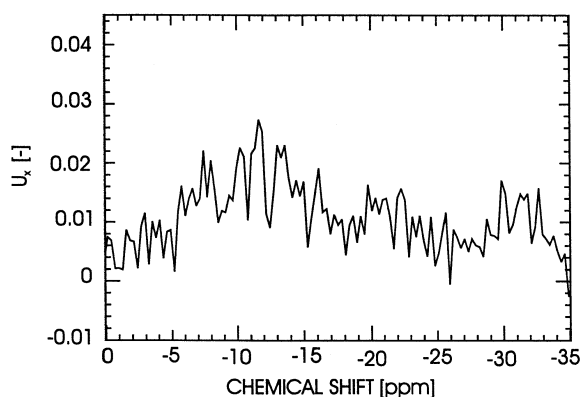

RECONSTRUCTED In Vivo ^{31}P SPECTRUM (21/256/10)

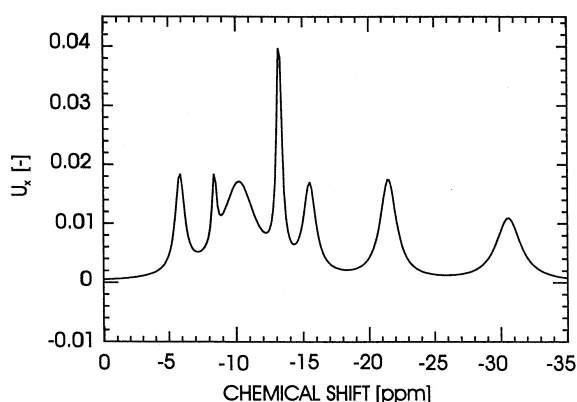

Processing of the bandpass signal with a large dynamic range.

Josef Halánek, Miroslav Kasal, Vlastimil Vondra, Pavel Jurák, Ivan Krejčí, Vladimír Húsek, and Milan Samek

In NMR spectroscopy and tomography, relatively high demands are put on signal processing. The signal is a bandpass one, with a carrier frequency from 10 to 600 MHz, the analyzed spectral width is from 100 Hz to 1 MHz, and analyzed lines can be as narrow as 0.1 Hz. The analyzed signals are mostly weak, sometimes below the noise level, and so accumulation must be used to increase the signal-to-noise ratio. Moreover, often a strong, unwanted signal (solvent or water in biological samples) is present in the processed data. It can be as many as 100 dB above the level of the analyzed signals. This strong signal cannot be eliminated by analog filters and so the resulting sensitivity was sometimes limited by a maximal dynamic range, above all for analog NMR receivers. This problem was eliminated using the digital receiver, i.e. oversampling and ZOOM FFT on-line. In 1992 we tested oversampling and digital filtering on-line (HSP43220) using analog quadrature detection, since 1996 we have been using a full digital receiver based on HSP50016. Besides the problems connected with the design of the digital receiver we had to analyze a couple of others, given by the application in NMR. For example:

a) Baseline distortions given by the filter transient response. Some rules were set how to acquire data to minimize baseline distortions. This rule was valid for analog filters with a small steepness of the frequency response. When the steepness was higher, some empirical constants were used to correct amplitudes of the first points of accumulated data. We determined the origin of this distortion and the proper setting of measurement parameters. Using this, the baseline distortions given by the transient response of filters were eliminated for any filter, Fig. 1. The theory was also expanded to a different type of measurement in NMR tomography and so the corresponding ghost signals were eliminated.

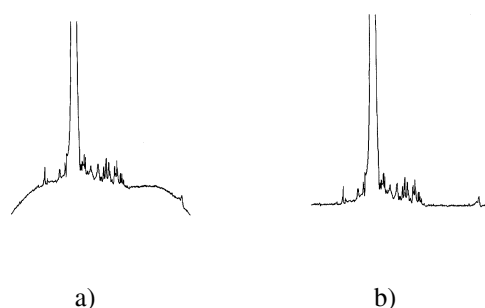

Fig.1. Baseline distortion given by filter transient response. a) acquisition parameters as with analog filters, b) elimination by proper setting of acquisition parameters

b) Baseline distortions given by a different type of data. The NMR time signal is complex, and two different types of data, given by a different time shift between real and imaginary samples, were used: the zero time shift (pure complex data) and the time shift 0.5 of the sampling period (Redfield-Kunc data). Both types of data have their adherents, the baseline distortion is different, but the theoretical explanation does not exist. We have found that a different baseline distortion is given by different aliasing of signals off the basic Nyquist band. When the complex signal is sampled, the aliased signal can occur in two positions, and the amplitude and phase depend on the time shift between samples in the real and imaginary parts.

c) Phase coherence of the digital receiver. In NMR, the phase coherence between the transmitter and receiver must be ensured. Using analog quadrature detection, the phase coherence is preserved by the mixing frequency. In the case of digital quadrature detection this signal is missing and the resulting phase depends on the transmitter signal, sampling frequency, and time schedule of the experiment. This is why the manufacturers still use the mixed design – analog and digital quadrature detection. We have achieved the phase coherence using the synchronization signal from the pulse generator that is responsible for the time schedule of the experiment.

Some algorithms are applied as the postprocessing, for example for the solvent suppression, Fig. 2. We have a close cooperation with partners in Italy, Prof. Marco Villa and Pacifico Cofrancesco, Unita INFM di Pavia. In the area of standardization, our aim is to lay down the proper definition of a maximal dynamic range, the ratio of the full-scale signal power to noise power per Hz, and the introduction of the dBFS/ $\sqrt{\text{Hz}}$ unit. In NMR, the number of ADC bits is still used as the unit.

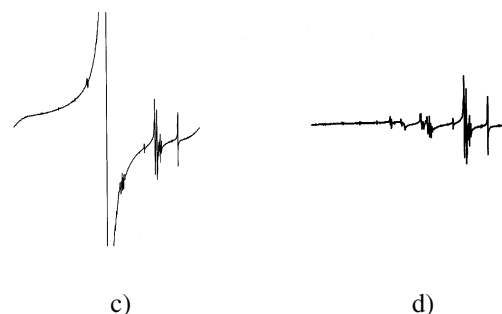

Fig.2. Solvent suppression by postprocessing. a) input spectrum, dispersion part with solvent signal, b) the same spectrum with suppressed solvent

Dynamic errors of ADC – measurement and analysis

Josef Halánek, Pavel Jurák, Miroslav Kasal, Milan Samek, and Vladimír Húsek

For a digital receiver the dynamic range and the frequency bandwidth are mostly limited by ADC. So the top-quality system design must go out from ADC's parameters. But parameters used by ADC manufacturers are mostly too global, give together more error signals and different error sources. That is why we are interested in the analysis and measurement of ADC's dynamic errors. Only so we can achieve the best parameters of a NMR receiver. Two different error signals were considered - noise and spurious with harmonics. The latter was eliminated as much as possible. Different sources of these error signals were taken into account, such as the analog preamplifier, sample and hold circuit, quantization and differential nonlinearity, jitter, and coupling between the analog and the digital part. The digital receiver is used for the measurement of ADC, so the problems with a fast sampling, large data set, sensitivity, input signal imperfections and measurement automation are eliminated. On the basis of different tests, we can pick out the following new methods:

Coupling between the analog and the digital part. We have good experience with the measurement of the output noise as a function of the sampling frequency when the input signal is broadband noise of small amplitude (1 or 2 LSB) with the dc level exactly at the center of the input range. This input signal makes the ADC errors irrelevant and ensures a maximum change in maximum output bits at the same time. The output noise should become independent of f_s when the coupling between the

analog and the digital part has been eliminated.

Signal distortion given by the sample and hold circuit. S/H was for a long time the limiting part of the ADC. It was the main source of noise and its transient response can be a source of a spurious that cannot be eliminated by dither. These error signals can be still dominant in ADC undersampling applications, when the ADC is used for frequency conversion. These error signals depend above all upon the amplitude difference between subsequent samples, and this difference depends on the ratio between the sampling frequency and the carrier frequency. So with a proper choice of f_s we can minimize (optimal working point of the digital receiver) or maximize this error signal (ADC measurement), see Fig. 1.

Jitter measurement. Jitter is the time uncertainty that limits the ADC frequency bandwidth; it is caused by ADC itself and by the phase noise of the sampling frequency. When jitter is random, the corresponding error signal is noise, and from this additive noise jitter can be computed. Standard measurements of jitter have a low sensitivity, do not assume the influence of the ADC's analog frequency response, and the result depends on the noise floor of the input signal. Our method is based on a theoretical model that assumes the analog frequency response of ADC and the noise floor of the input signal. The analysis of the ADC's output noise as a function of the input frequency or amplitude gives us the accuracy level of jitter, Fig.2.

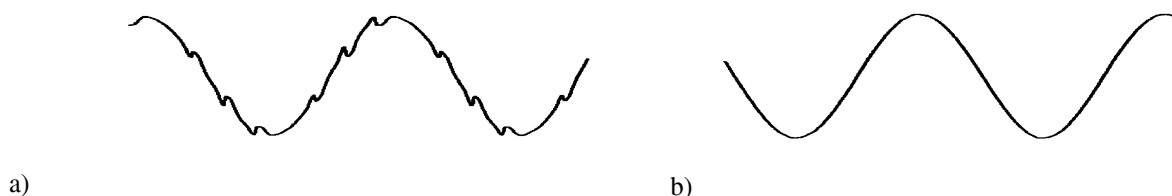

Fig.1. Signal distortion given by the sample and hold circuit, the output signal from the digital receiver. a) carrier frequency 66.25 MHz, b) carrier frequency 68.75 MHz.

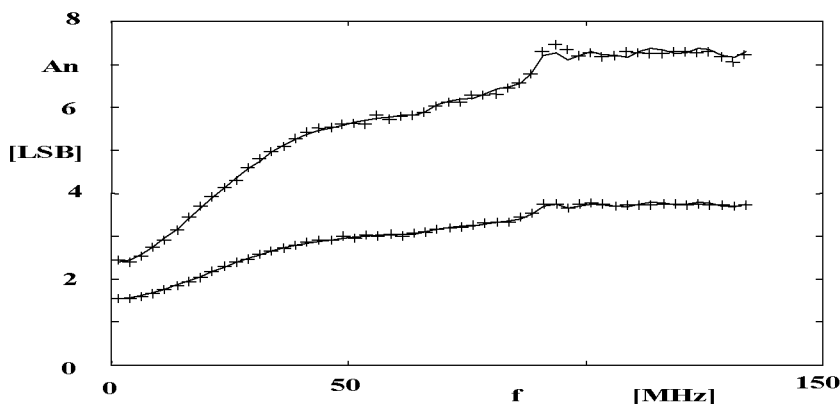

Fig. 2. The coincidence of the theoretical jitter model (full lines) with measurement (points). Two amplitudes of the input signal (full scale – 6 dB and –12 dB) were used. The jitter values were 15.7 and 16.1 ps, respectively.

Methods of calculation of steady heat flows in cryogenic systems

Pavel Hanzelka, Josef Jelínek a Věra Musilová.

Consumption of cryoliquids, usually liquid helium and nitrogen (LHe and LN₂), is an important parameter of many cryogenic devices, such as Dewar flasks, experimental cryostats and also superconducting magnets for the nuclear magnetic resonance (NMR) spectrometers and tomographs. This consumption together with the cryoliquids refill interval affects substantially the operational economy of the mentioned devices. A significant saving of cryoliquids may be achieved by minimising the heat that gets into the low temperature internal parts from the outer surface with room temperature. For illustration, the insulation properties of a well designed NMR cryostat are three or four orders better when compared with those of a standard thermos bottle.

Several techniques are simultaneously used for the heat input reduction. The internal parts are placed in a high vacuum space and so the heat exchange by the gas is avoided. Heat radiation and heat conduction in the necks of the vessels and internal supports become thus the most significant heat flows. Therefore the internal parts are often surrounded by thermal radiation shields that are cooled by outgoing cryoliquid vapours, by an external refrigerator or by an additional bath of another cryoliquid. When designing such a complex system, its structural parameters are to be optimised so that the minimal heat input is achieved and also other conditions determined by the device utilisation are fulfilled. The application of simple presumptions or rough calculations leads usually to the necessity to modify the device repeatedly after its realisation. The set of algorithms for the calculation of the steady temperatures and heat flows in cryogenic systems created in ISI Brno makes the design of the low temperature devices easier and more precise.

For the purpose of calculation, the analysed system is divided into the parts with a constant temperature (vessel with cryoliquid, radiation shields) and the parts with temperature gradients (necks, supports). The goal of the calculation is to find the heat equilibrium of all isothermal parts. Owing to the complicated and nonlinear mutual relations of the quantities describing the system, numerical methods must be used. The algorithms of the heat flows calculations consist of hierarchically assembled modules.

The output parameters of the modules on a lower level are used as input parameters for the higher level modules. The physical sense of the quantities calculated on individual levels is checked continuously. The modular structure enables one to create a program for the calculation of a cryogenic system with a defined configuration. A program KRYOM 3.3 was developed for the analysis of usual cryogenic devices. The following operations can be carried out by the program:

- Calculation of the heat flows and temperatures in the necks and supports of the vessels with cryoliquids.
- Analysis of thermal processes in the Dewar flasks and cryostats.
- Optimisation of a cryostat with one radiation shield.

This program is used at ISI and also at four foreign institutions: Spectrospin Fällanden, Switzerland; IEE SAS Bratislava, Slovakia; DeMaCo, Netherlands; Indian Institute of Science, Bangalore, India.

The results of calculations achieved by the described methods were verified experimentally and by comparison with the parameters measured on the formerly built or newly designed devices. Thanks to the calculation methods, cryogenic systems with excellent parameters were built. The programs are employed for the design of the cryostats of the superconducting magnets to support the development of the NMR spectroscopy and tomography methods at ISI, and for designs made in co-operation with foreign institutions. ISI was invited to participate in the state grant of the Slovak Republic aimed at the application of the quantum Hall effect. An economical 1.5 K superfluid helium cryostat was successfully designed and manufactured.

The design of a cryostat of a 500 MHz NMR spectrometer made for the Italian company ANSALDO is another example of a successful application of the programs. The cryogenic parameters of the cryostat, manufactured by the SITEV company, are displayed in the following table. The available parameters of the magnets manufactured by Bruker and Oxford Instruments are included too. When comparing, the lower working space of the Bruker magnet should be taken into account.

| Cryostat | ISI - SITEV - ANSALDO 500 MHz | Bruker D 220/52 500 MHz | Oxford Instruments 500 MHz |
|-------------------------------------|----------------------------------|----------------------------|-------------------------------|
| Working space diameter [mm] | 89 | 52 | 89 |
| Outer shell diameter [mm] | 800 | 750 | - |
| Height [mm] | 1910 | 1653 | - |
| LHe consumption [l/day] | 0.6 | 0.46 | 0.84 |
| LN ₂ consumption [l/day] | 5.4 | 6.0 | 7.5 |

The blood pressure and heart rate variability evaluation for cardiovascular diagnostics

Pavel Jurák, Josef Halánek, Miroslav Kasal, and Milan Samek

In collaboration with the 1st Internal Clinic of the Faculty Hospital “Sv. Anna” in Brno (T.Kára, M.Souček, and J.Šumbera) we have developed non-invasive cardiovascular diagnostics which involved quantitative assessment of the risk of an acute cardiovascular event like a sudden cardiac death, arrhythmia, strokes and heart failure, diagnostics of ischemic diseases, hypertension and transplanted heart rejection. The diagnostics is based on the evaluation of ECG, blood pressure (BP) and respiratory (RESP) signals. The autonomic nervous system (ANS) control mechanism, which participates in the maintenance of BP and heart rate (RR) balance, is excited by precise control breathing at 0.1 Hz frequency. This frequency represents resonance oscillation of the baroreflex system. Baroreflex is defined as the relationship between the systolic BP (SBP) and heart beat intervals variations.

In diagnostics we have used the previously developed algorithm for the narrow band NMR signal processing. We have established the new quantity - immediate value of complex baroreflex sensitivity (BRS). The BRS is

calculated by means of digital quadrature detection and digital filtration. The time behaviour of the immediate complex value of BRS much more better defines the mutual relationship between the heart beat intervals (RR) and systolic blood pressure (SBP). It partly eliminates the non-stationary state, and the immediate phase carries information about the mutual signal coherency.

The sensitivity and specificity of results (100 patients, 40 healthy volunteers) are essentially higher than the standard methods including the invasive technique. Our results have been partially verified abroad. In April 1999, Prof. Coats’ team in London finished its study (31 patients, 18 healthy volunteers) which confirms the highest reproducibility in the case of the 0.1 Hz control breathing method.

The last measurement results reflect the eventual influence between the middle beat frequency and the period of the baroreflex feedback system (BFS). Documentation of this dependence may help to do a more precise prognosis of cardiovascular diseases.

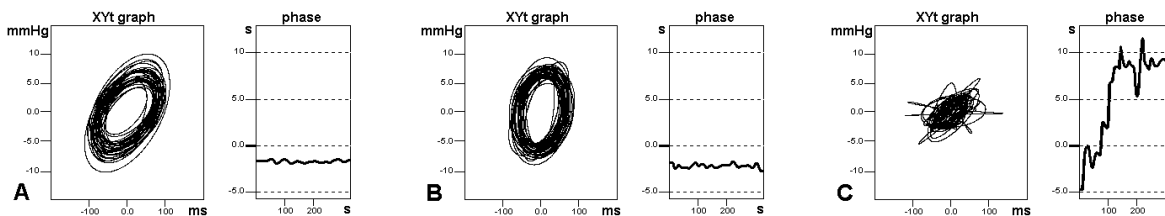

Fig.1. A) Healthy individuals: a very stable value of the phase shift (approx. -1.7 s) and a symmetrical XYt graph represent very good characteristics of the BFS. B) Patient with essential hypertension: higher phase shift (-2.5 s) but still good BFS characteristics. C) Patient indicated for defibrillator implementation: total chaos in BFS - system unstable.

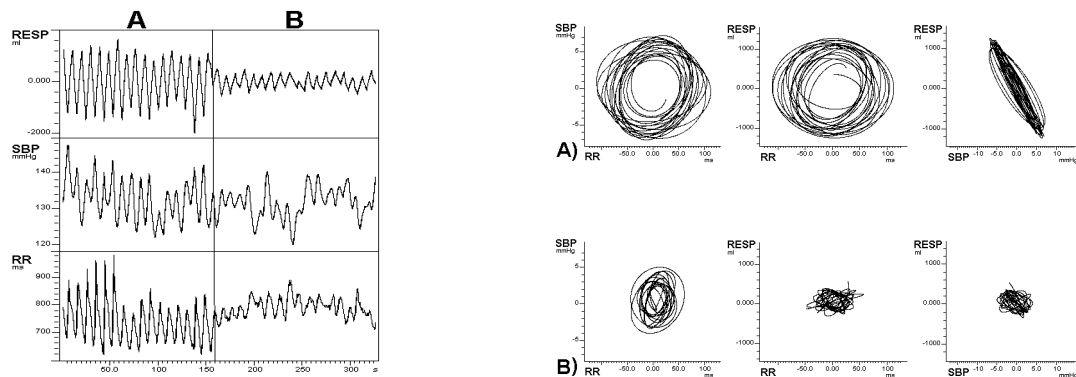

Fig. 2. Deep breathing (A) and mild breathing (B) and their influence on SBP and RR intervals during one 5-minute measurement of a healthy volunteer. It is evident that the precise respiration measurement is very important.

Selective NMR excitation by digital amplitude and phase modulation

Miroslav Kasal, Josef Haláček, Vlastimil Vondra, Vladimír Húšek, Milan Samek, and Radek Václavík

In MRI and MRS, shaped pulses are used for selective excitation of nuclear spins. If a radio-frequency signal is amplitude-modulated by the function $\text{sinc}(\pi t/\tau)$, we obtain in the frequency domain about the carrier ω_0 the band $\omega_0 \pm \pi/\tau$ with a constant spectral output density. There are no spectral components outside this band. The difficulty is that for practical reasons and also for the attainment of a short excitation interval the pulse length is limited. The resulting spectral function is then rippled in the desired band, and spectral components occur also outside this band. Although the pulse length is the factor that limits the attainment of a certain spectral profile, for different applications new courses of the modulation envelope are steadily looked for. Various non-symmetric functions or combinations of amplitude modulation with frequency and phase modulation (the so-called adiabatic pulses) are used

Most MR tomographs realise amplitude modulation in the double-balanced circular diode modulator (DBM) with a low output power. The resulting DSB signal is additionally amplified to a desired output power in linear high-performance amplifiers. The demands on linearity and the dynamic range of amplitude modulation are very high.

A quadrature modulator ($I&Q$) is more universal. From the viewpoint of excitation, its advantage is the possibility of realising amplitude and phase modulation in one place of the excitation signal generator. It also enables generation

of non-symmetric spectral profiles in relation to the carrier frequency.

On the basis of analyses and experiments, the $I&Q$ modulator is realised at a low output frequency of a direct digital synthesiser. Although the resulting parameters of modulation are in this case partially deteriorated by the limited dynamic range of the following mixer, the attained quality of excitation pulses is very good. Excellent results have been achieved using the direct digital synthesiser HARRIS HSP45116. The integrated digital matrix multiplier enables realisation of a digital quadrature modulator with two orthogonal outputs for the following mixer. The 16-bit word length at all edges of the multiplier enables theoretical attainment of modulation dynamics of 96 dB. The dynamic range is however restricted by 12-bit D/A converters. The attained suppressions of the carrier and the undesired 80 dB sideband are superior parameters.

An essential advantage of the quadrature modulator is that no spectra mirroring around the carrier frequency takes place (in Fig.2 zero corresponds to the carrier). The spectrum of the output signal is a shifted spectrum of the modulation function and is unambiguously determined by this function. The modulator enables realisation of an excitation signal with a non-symmetric spectral profile. The modulation function must be in complex shape (Fig.1).

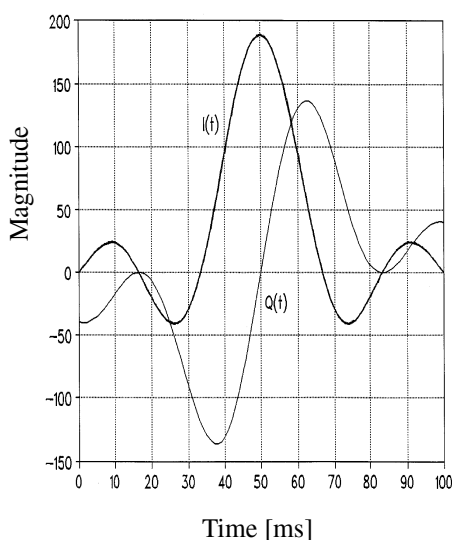

Fig. 1. Time characteristics of both components of modulation function $I(t)$ & $Q(t)$ for the quadrature modulator.

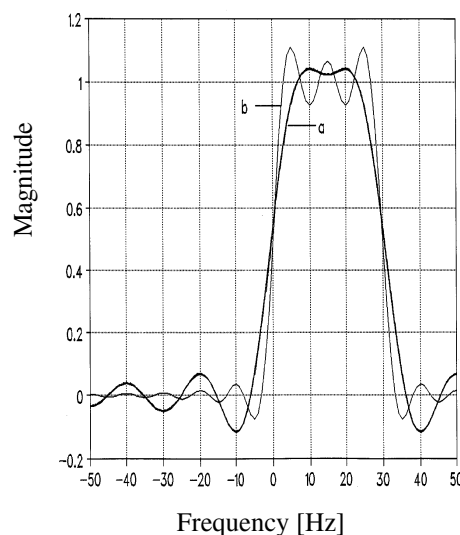

Fig. 2. Spectral profile of excitation signal. a) for a pulse length of 100 ms, b) for a pulse length of 200 ms.

Resonators for in vivo MR spectroscopy and tomography

Miroslav Kasal, Milan Samek, Josef Halánek, Vladimír Húsek, Vlastimil Vondra, and David Bělohrad

In an NMR experiment, the magnitude of magnetic induction of the rf field B_1 and the field homogeneity in the entire sample space are decisive for nuclear excitation. The rf magnetic field is produced by the coil of the resonant circuit into which a signal of a transmitter with a corresponding output power is fed. The active energy is consumed in the loss resistance of this circuit. An essential improvement can be achieved by circular polarisation of the field. The excitation power can be then 3 dB lower and also the field homogeneity is improved. Because the same resonator is used for the NMR signal detection, also the sensitivity is increased $\sqrt{2}$ -times. Circular polarisation began to be used in MRI systems where it can be realised thanks to the available larger space. It is produced either by two pairs of saddle coils that are perpendicular to each other and are excited by 90° phase-shifted signals or by a system of tuned conductors on a cylindrical surface with the corresponding distribution of currents (birdcage coil). In the latter case, a better B_1 field homogeneity can be achieved.

To do clinical spectroscopic studies of human brain, it is

necessary to develop an efficient double-tuned resonator to ensure acquisition of proton images and to enable measurement of proton-decoupled ^{31}P spectra. Compared with single-resonance coils, the main advantage of the double-tuned resonator is that all parts of the experiment can be carried out in immediate succession, without changing patient's position and without exchanging coils. Moreover, the double-spin system will enable acquisition of phosphorous spectra with a higher sensitivity at simultaneous proton excitation (decoupling).

We have developed a double-tuned resonator of 'four-ring birdcage' type that represents a new category of resonators for the mentioned application. The resonator consists of one inner and two outer sections and has the character of a low-pass filter (LP). The three structures are of 'birdcage' type with sinusoidal distribution of currents around the axis of the resonator. The inductive coupling with the resonator is designed so that it enables quadrature excitation of the inner and outer sections and the attainment of circular polarisation of the field at both frequencies.

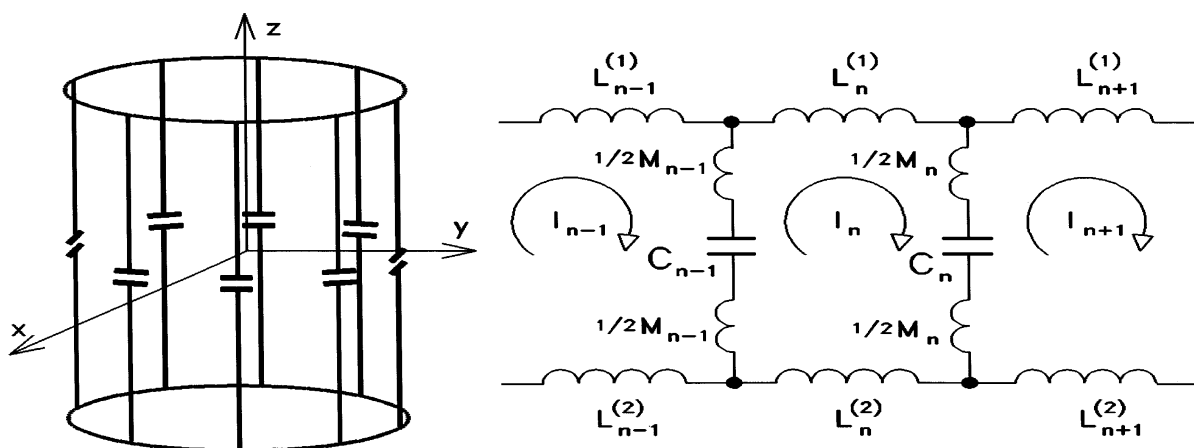

Fig. 1. Substitute circuit of one segment of the 'birdcage - LP' resonator.

The double-nucleus four-ring resonator consists of three single 'birdcage - LP' resonators (Fig. 1). It is a case of a closed periodic structure with N elements (loops), where N is an even integer. Each element of such a line has the phase delay $\Delta\rho(\omega)$. The total phase shift must be $2\pi k$, $1 \leq k \leq N/2$. The resonance condition is then expressed by the relation $N\Delta\rho(\omega) = 2\pi k$. The number of resonances is $N/2$. The sinusoidal standing wave of the lowest mode ($k = 1$) excites in transverse elements currents that produce inside the cylindrical resonator a homogeneous field B_1 oriented perpendicularly to the axis z . The field homogeneity generated by higher modes is worse

proportionally to k , up to $k = N/2$, when neighbouring transverse elements are excited in antiphase.

The objective was to find a substitute circuit of the resonator with concentrated parameters for the inner and outer sections so that it corresponds with sufficient accuracy to reality and can be used for resonator adjustment. From the measured resonance values of the fundamental mode ($k = 1$) and the fourth mode ($k = 4$) we calculated the corresponding values of longitudinal and transverse inductances. The check was made by calculation of resonance frequencies of all modes, and again comparison with the experiment was made.

The generation, measurement and analysis of high purity correcting magnetic fields

Pavel Konzbul, Aleš Srnka, Karel Švéda

A sufficiently homogeneous DC magnetic field is an important prerequisite for a successful experimental work in the field of nuclear magnetic resonance (NMR) spectroscopy and magnetic resonance imaging (MRI). The order of effective inhomogeneity should not be higher than one part in some hundred millions of the nominal basic field. To get these extremal values, some correction of the basic magnet field is needed. Either some properly located small ferromagnetic pieces (the passive corrections) or a rather complicated system of current bearing windings (the active corrections) is used for this purpose. The relevant questions regarding the design methods and technologies of the active correction systems are dealt with at our laboratory. These systems are intended for homogenising basic fields of the solenoidal NMR and MRI magnets. From the theoretical point of view, an important achievement has been the finding of the recursion formulae for different types of current bearing elements. These formulae are used for the evaluation of the coefficients of the spherical functions by means of which Laplace's fields can be expressed. This knowledge opens the possibility of further work by combining the analytical and the stochastic methods for getting very pure correction fields. The most important methods include:

- Analytical and graphical methods for the design of multi-sectional systems that show a standard magnetic field purity in a volume about 30% greater than shim systems designed and constructed by classical methods;
- A method of the independent windings which combines analytical approach with the optimisation Monte-Carlo

method. This method is suitable for coils producing extremely pure correction magnetic fields.

- A modification of the inversion matrix method used primarily for the Fast Field Cycling (FFC) magnet design. Instead of using prescribed values of magnetic fields at given positions, the derivatives in origin are used in the modification. This design method can be adapted for the axial correcting windings.
- The matrix design method enables one to lower the needed electrical power consumption outstandingly and simplifies the production and its costs.

Together with the work on the design methods, the magnetic field space configuration measurement and the analysis of the obtained data have been made. In principle, the latter uses a field model described by a spherical harmonic expansion, which is a solution of the Laplace's equation. This magnetic field mapping and the obtained data processing are used both for the examination of the correcting fields and for simulating the homogenisation, i.e. finding the optimum currents in the individual correcting shims (subsystems). This can be very useful especially for shimming superconducting corrections. This application is illustrated using two magnetic field maps of a superconducting whole body MRI solenoid, before and after the field correction. The reduction of the magnetic field inhomogeneity for the tomograph magnet (RT bore 600 mm) is evident from the figures. The data of the magnetic induction were measured on the surface of a hypothetical cylinder of 300 mm in diameter and 350 mm high.

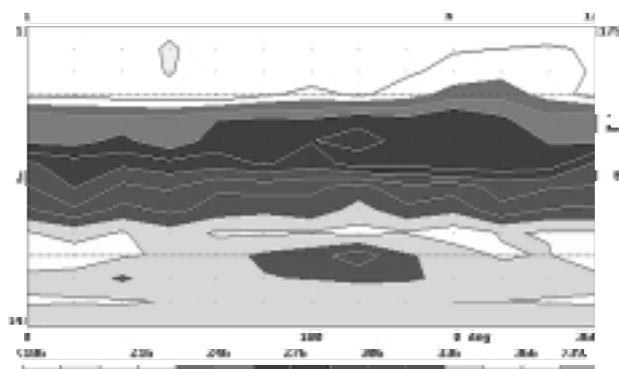

Fig.1. The map of the magnetic field of the tomograph magnet (inhomogeneity 164 μT)

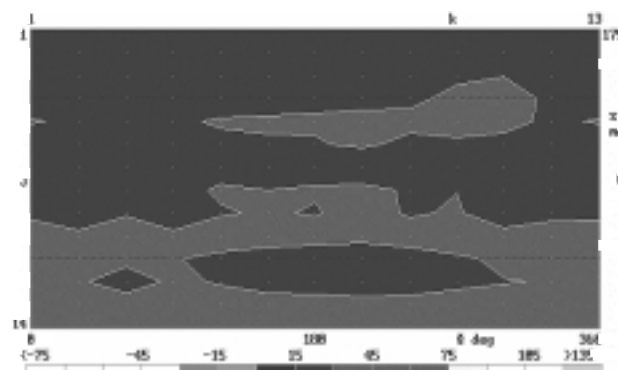

Fig.1. The same magnetic field after shimming by the correction coils type Z1 and Z2 (inhomogeneity 6 μT)

The tuneable source of coherent radiation based on laser diode

Josef Lazar, Ondřej Číp, Petr Jedlička, and František Petru

Semiconductor laser diodes become widespread in the past several years. They are commonly used as transmitters in optical communication systems, CD players, bar code readers and many other commercial applications where high coherence and mode purity are not demanded. There is a lot of laser diodes available on the market from various producers and for acceptable prices working on great variety of wavelengths. The development of LD's leads from types emitting in infrared region of spectra toward shorter wavelengths. During the last several years the red light emitting diodes emerged and shorter wavelength ones will surely follow.

Low price, small size and high output power of LD's led to the effort to use it also in applications where a narrow linewidth, single-frequency regime and high frequency stability is needed. Broad spectral characteristic of the active media promises also broad tuneability and small size and thus low capacity of the semiconductor junction allows high-frequency modulation of the optical frequency and power.

We concentrated our effort on applications putting high demand on the optical frequency stability and coherence

– the fundamental metrology. At present the unit of length is defined through the vacuum speed of light and the practical realisation of the length standard is the highly stable laser with its wavelength and thus also its optical frequency of the output radiation varies very little. There are several stabilised laser systems (mostly based on He-Ne laser) accepted by the international commission. They represent only a few points on the scale of optical frequencies. Their stability comparison is very complicated or even impossible.

When we designed our laser system we used the technique of single optical frequency selection developed previously for dye lasers, some time ago the only lasers with a broadband amplifying media. We assembled a laser resonator with the grating as an optical selective element transforming the wavelength to the angle displacement of the beam. When a suitable geometry of the end-mirror movement is selected it is possible to synchronise the tuning of the grating reflection and resonator length the way the laser wavelength is fluent, without mode hops.

The long-term stability of traditional standards is achieved by a feedback regulation of the laser wavelength

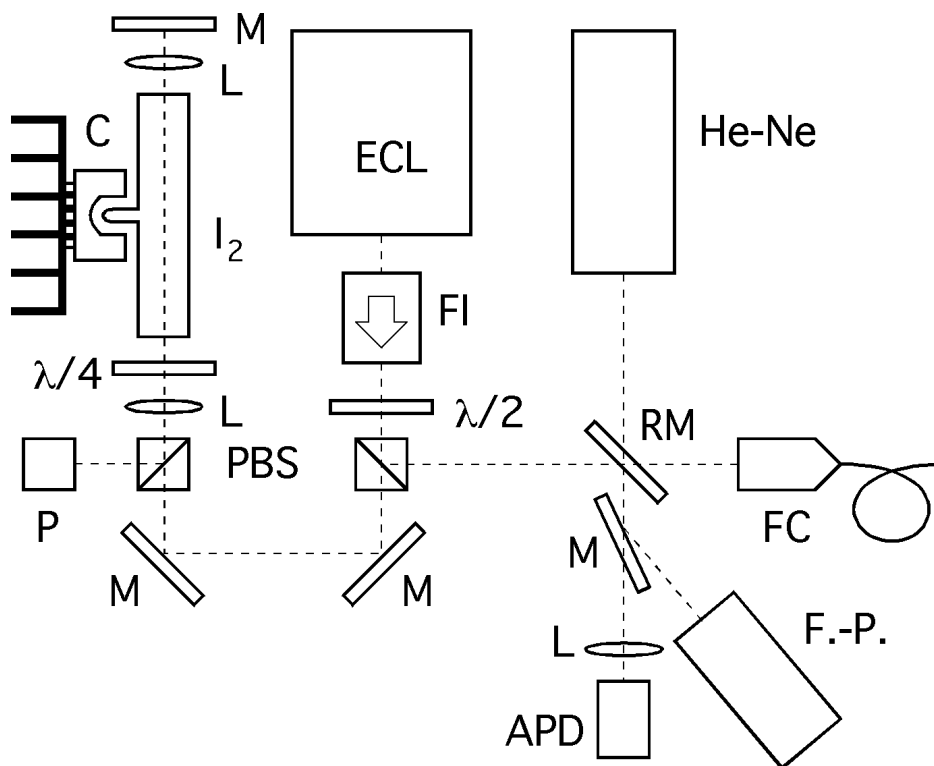

Figure 1. **The experimental setup.** APD: avalanche photodetector, F.-P.: scanning Fabry-Perot cavity, L: lens, FC: fiber coupling, M: mirror, RM: removable mirror, PBS: polarizing beamsplitter, $\lambda/2$: half-wave plate, $\lambda/4$: quarter-wave plate, FI: Faraday isolator, He-Ne: free-running He-Ne laser, ECL: extended-cavity diode laser, I₂: 300 mm long iodine cell, C: Peltier cooler.

which is derived from very narrow absorption spectral lines of various gasses. We also applied this technique with some modifications. The absorption medium we used iodine vapour with a dense net of spectral lines in the visible region of spectra. The effort of several metrological laboratories (including our team) was to build a laser system close to the 633 nm wavelength of the common He-Ne laser which serves as a present length standard. Covering of this wavelength by the new semiconductor laser system allowed also direct stability comparison.

Our team participated on the first international comparison of semiconductor lasers stabilised by means of

absorption in iodine vapour under the supervision of the International bureau of weights and measures, BIPM in Paris, France, the metrological institute supervising the primary standards of fundamental physical quantities. The comparison clearly proved the long-term stability of optical frequencies of the semiconductor laser systems to be on the level of the present primary standard and more they allow to cover much broader region of optical spectra by a dense “scale” of stable frequencies.

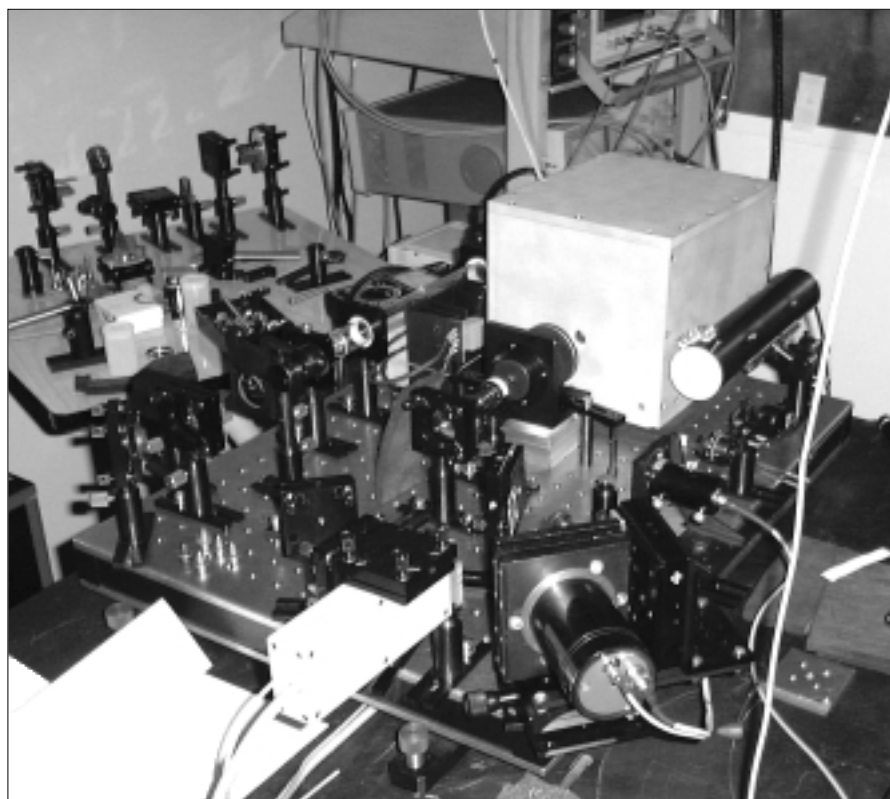

Figure 2. Arrangement on the optical table

The computer-controlled stabilised He-Ne laser – primary standard of length

Josef Lazar, Ondřej Číp, and František Petrů

Introducing the new definition of meter derived from the vacuum speed of light by the decision of the international metrological commission CCDDM in 1983 and specifying it further in 1984 and 1992, the importance of lasers in metrology grew significantly. The primary standard of length is based on the helium-neon laser now featuring many advantages. It is easily possible to achieve the single-frequency regime, stable mode-structure, the output beam is narrow and symmetrical and the laser itself is compact and relatively simple. The wavelength of the laser varies within the range given by the active media amplification with the thermal dilatation of the resonator. The demands on the stability of the wavelength and thus the optical frequency of the primary standard are much higher.

The very precise optical frequencies are derived from the narrow absorption lines of various gaseous absorbers. For the 633 nm wavelength of the He-Ne laser, the iodine vapour proved suitable. The two-atom molecules have many so called hyperfine spectral lines with different intensity generated by vibration-rotational splitting of fundamental energetic transitions. The 633 nm wavelength of the He-Ne laser coincides with one of the weaker groups of hyperfine lines that is possible to detect on the noise

background only by placing the absorption cell into the laser resonator. The energy density is there about two orders higher than in the output beam. The absorption in iodine vapour is weak enough not to raise the level of losses in the resonator over the threshold when the laser oscillations stop.

The spectral lines detection is done by the technique known as derivative spectroscopy where the line profile is achieved by electronic derivation of the power profile of the laser depending on the wavelength. Higher derivatives lead to the suppression of the power curve background that is not so steep and to amplification of narrow and sharp spectral lines superimposed on it. The laser wavelength is regulated by a feedback loop on the centre of one of the absorption lines. Relative stability of the order of 10^{-11} can be achieved. It is the primary standard so its calibration according to any more accurate standard is impossible. Its uncertainty is estimated only by comparison with other lasers from other metrological laboratories. During such comparisons the difference frequencies of two lasers locked on different spectral lines are measured. Even when the optical frequencies are very high (approx. 400 THz), its beat signals are detectable by common electronic measuring devices.



Our system (see fig.) was designed as a compact and easily transportable one with user-friendly control by a computer. Its monitor shows the spectral lines during the laser tuning and helps find and lock the line. Detailed system diagnostics is also available.

The laser standard is included into the international metrological network and is regularly compared with the

standards of other countries. It is used for calibration of stabilised He-Ne lasers for interferometers designed for position measurements for precise machining in industry or for calibration of gauge blocks and mechanical measurement tools in metrological centres.

Computations of electron optical elements

Bohumila Lencová

For the design of electron lenses and deflectors we have to calculate very accurately electrostatic or magnetic fields that influence the motion of charged particles. Therefore we must have at our disposal methods and programs for accurate computation of potential distributions and for the computation of trajectories in these fields. In such a way we can determine the properties of rotationally symmetric lenses as well as the properties of magnetic deflection systems made of accurately wound magnetic coils or electrostatic deflectors made on subdivided rotationally symmetric surfaces. Since the early 1970's the Finite Element Method (FEM) has been used with success in electron optics; this method is irreplaceable in particular for the computation of magnetic electron lenses where the magnetic materials saturate. All necessary elements we can calculate with the help of programs, that were in the course of time developed in the institute, and that are used in a number of laboratories worldwide. Our programs run on common personal computers. They are based on the first order FEM that allows us to change the properties of materials such as local permeability within a very small region. We use a simple topology of the mesh made by horizontal and vertical lines subdividing the region under study into quadrilateral areas that define the geometry of the problem. High computation accuracy can be obtained by using a computational fine mesh with graded mesh step, that is dense in the regions where the field changes, and by

using large meshes with up to 100000 mesh points. Even for so dense meshes we have reasonably short computation time in the order of minutes thanks to the use of preconditioned conjugate gradient method for the solution of large systems of linear equations. Successively we have managed to improve the computation methods for all required types of potential and boundary conditions. For practical computations it is necessary to have such a user interface that enables us to input the data interactively on a graphical screen, to generate the fine mesh automatically, and to display the results of the computations. Such interface programs were made in cooperation with TU Delft. Much attention was devoted to the evaluation of the optical properties of the computed fields. The most frequent approach is to evaluate the paraxial properties and the aberrations. We have also participated in the development of methods for very accurate tracing of electrons by solving the equation of motion, required for such problems where either the aberration theory is not applicable, or for the design of detectors.

Example of a highly saturated objective lens for a 1 MeV transmission electron microscope studied by Tsuno and Honda. Our computations, published at the EUREM 1996 conference, provide correct distribution of axial flux density $B(z)$ three times faster than recently introduced second order FEM.

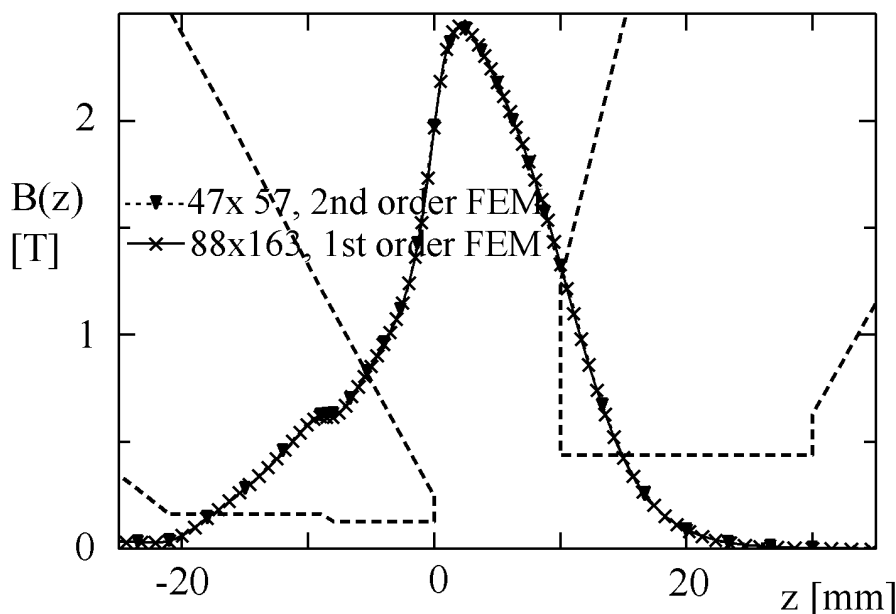

Fig.1. Comparison of computed axial flux density distribution for a highly saturated 1 MeV objective lens at 32000 A-turns excitation (polepieces of the objective lens are shown as dashed lines).

Electron-beam lithograph - new exposition software

František Matějka

In the last two years we have achieved a basic qualitative update of the control & data system for the electronbeam lithograph (EBL) BS 600. This work was carried out at the EBL laboratory within the frame of the research project in cooperation with the Department of Microelectronics, Faculty of Electrical Engineering and Computer Science, Technical University in Brno. In cooperation with the ELTEK s.r.o. company, a new control system was assembled which is based on IBM PC including a digital signal processing board ADSP 2181. The new control system contains also a videosignal adapter for processing the signal from a back-emitted electron detector. The novel solution of this adapter enables the read-in of video data directly into the signal processor which simultaneously controls the deflection and size of the shaped electron beam while the lithograph works in a scanning electron microscope (SEM) mode. The new control system also directs instructions to a stage system (through the service channel). The stage system sets and measures (laser interferometers with a resolution of 40nm) the X and Y coordinates of the support lithographic stage on which an exposed substrate is held.

The new hardware design of the control & data system created a new situation in dealing with the problem of the user software interface. The basic feature is the flexibility of the SW development according to user demands. The new exposition program enables editing, simulation, and exposition of the source code, i.e. files of an extended **.ASB format. System variables are set by **.SET files with the same name as the ASB file. Both of them are ASCII files, which allows simple and versatile editing and viewing. The exposition program ASB EXPO is compatible with the original ASBEST3 language. The new program has four main features: subroutine calls can be directed forwards as well as backwards, full mathematical support, parametric programming, and recursion. The program

interpreter includes a set of user parameters that, together with variable setting, branching, cycling, and subroutine call, supports creation of versatile and complex program modules. The new exposition program runs without any compilation phase, and ASB instructions are interpreted with direct links to the HW subsystem. Special macro-instructions were developed to process both bitmap files (B/W or colour) and interpretation of colours as distinct subroutines according to the designed colour palette. A hierarchical interpretation and library file links are allowed. The total volume of exposition data is limited only by an internal PC memory. One of the major advantages is a possibility to control the exposition by a mathematical equation. This equation can include several mathematical functions whose argument can be also some mathematical expression. In the program fixed waiting times are included for a large deflection of the beam. Before the start of the proper exposition, the EBL operator can enter correction factors for geometric and metric deviations of the deflection area. The program ASB EXPO is compiled to be run under Windows 95 or Windows NT; dialog windows make it user-friendly and easy in manipulation. Programming and debugging were predominantly done by experts from the ELTEK s.r.o. company.

We have achieved large and complex data expositions using the new program. As an example we can mention a large-size structure of the phase diffractive lens for $\lambda=617\text{nm}$, and $f=8.4\text{mm}$ (the lens is composed of 12 000 zones). The exposure was controlled by the source file that fully exploited the mathematical support of the ASB interpreter. The source file has only 140 lines. The figures below show the central part of the lens. On the right is a simulated result from a simulation window of the exposition program. On the left is a microscope image of the same lens realised in the thin film of a negative electron resist.



Fig.1. The central part of diffractive lens microstructure in a negative electron resist (magnification 500)

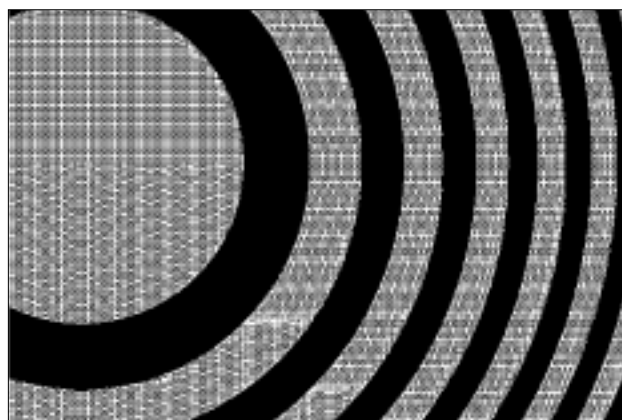

Fig.2. Simulation of the central part of a diffractive lens

Sub-micron diffractive holographic structures

František Matějka

Electron-beam lithography (EBL) became a well-known widely used tool in the microelectronics field. It has been used for generation of geometrical shapes with sub-micron details. Assuming the resolution of the lithography to be in the order of 10^{-7} m, it can be also used for generation of some diffractive microstructures that are able to process optical waves using the diffraction effect. It is clear that the aim of the diffractive optics (which is involved in the above field) is generation of intentionally optically active structures. The optical activity of the microstructure can be achieved in one of the following ways:

- modulation of the material transmission resulting in amplitude diffractive structures,
- modulation of the refraction index in the volume of material resulting in volume (space) diffractive structures,
- modulation of a relief resulting in relief (phase) diffractive structures.

Generation of these structures requires technology and techniques that are able to process appropriate materials into structures with sub-micron details.

Electron-beam lithography - that has been used at our institute for several years - is one of the suitable techniques. We welcomed the occasion for an evaluation of our EBL facilities in this very exciting field. This was done in the frame of cooperation with the Czech Holography s.r.o. company and the Department of Physical Electronics, Faculty of Nuclear Science and Physical Engineering, Czech Technical University in Prague.

Diffractive microelements become part of diffractive optical elements (DOE), which are proper elements for the transmission or reflection of the light beam. By the effect of DOE, the light beam is focused into a required shape (focusing elements, elements shaping the laser beam) or into a required image (holograms). Image diffractive structures (holograms) are realized often in a holographic

way, i.e. by interference of at least two light waves recorded on a light sensitive resist. This traditional record of diffractive structures can be replaced with a synthetic record if a suitable recording system is used. An EBL might be such a system because it works, in fact, as an image generator. The synthetic holographic record allows some special image information to be included in the graphical holographic motif itself, which is impossible to achieve with the traditional optical record. Normally, an EBL generates geometric templates in the resist by filling the required geometry using the shaped electron beam deflected over the whole area. The dimensions of the shaped beam are variable from 0.1 to 6.3 μm in both axes, which enables optimization of the number of exposures over the given area. Traditionally, the beam size of several micrometers is suitable for the required geometry; hence the exposition time is not critical. The generation of the diffractive structure using the EBL represents a completely different problem. The exposition must be done in such a way that the resulting image is made of diffractive grids with required parameters. Holograms observed in normal light have the grid parameter (period) within the interval 0.5 - 1.4 μm . During such an exposition, the lithograph must be working permanently with sub-micron beam dimensions. Thus the exposition becomes a time-consuming process that requires a long-term fault-free function of the system and long-term parameter stability. The exposition is also very challenging as the volume of data processed during the exposition is concerned (it may require more than 1G of basic instructions). A complex solution to these problems - HW, SW, and technology update of the former lithograph system BS 600 - enables generation of synthetic holograms and generic phase diffractive structures within our facilities. The photos below prove this.

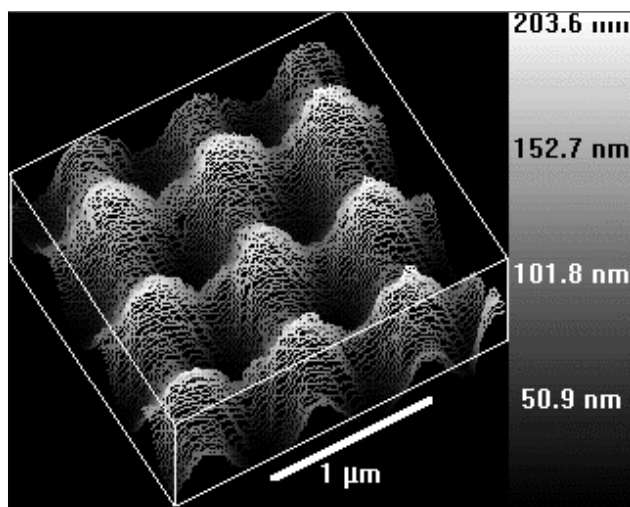

Fig.1. Relief of cross holographic grid (by AFM).

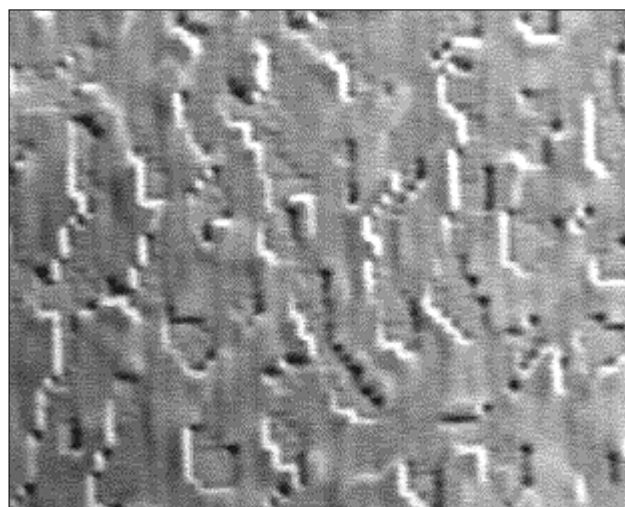

Fig.2. Generic diffractive structure (magnification 1000).

First observation of a diffraction contrast in the scanning electron microscope

Ilona Müllerová and Luděk Frank

In the scanning electron microscope (SEM), a focused electron beam illuminates the specimen surface and the image signal is generated by collection of backscattered electrons and of secondary electrons, again emitted in the backward direction with respect to the primaries. The detection is of intensity character and the process is a completely incoherent one because the path differences and angles between the partial rays exceed by orders of magnitude the coherence length. This is fully true for all electron energies available in SEM, i.e. for the range of tens and units of keV. The situation decisively changes if the electron energy decreases to tens and units of eV. Then the electron wavelength becomes comparable with interatomic distances in a solid and the waves scattered from individual atoms can interfere to produce a diffraction pattern even in the backward direction. In addition to the diffraction on crystals, other phenomena can be observed, like the divided-amplitude interference on ultrathin films and clusters or divided-waveform interference on surface atomic steps. All these phenomena are known from the so-called low energy electron microscope with a plane coherent electron wave but they had not been obtained in a scanning device yet.

SEM at so low energies is feasible only after adaptation incorporating a suitable decelerating field element like the cathode lens. The beam coherence in this configuration was analysed and found sufficient for obtaining a diffraction

pattern caused by amplitude summation of the partial waves from within the illuminated spot of the order of 10^2 nm^2 . The first demonstration experiment was performed in co-operation with Professor E. Bauer in Technical University Clausthal-Zellerfeld, Germany, where a suitable ultrahigh-vacuum (UHV) SEM was available. The microscope was modified by using a bakeable UHV version of the slow electron detector and a specimen stage enabling one to bias the specimen up to tens of keV and to heat it above 1200° C . As a specimen, the silicon single crystal with (100) orientation was chosen which was in-situ, i.e. directly in the specimen stage of the microscope, treated to receive an atomically smooth reconstructed surface. After that, single crystal Pb islands were prepared by slow evaporation at an elevated temperature.

The result below demonstrates the diffraction contrast between the Pb crystals of different orientations (triangular (111) and square (100) islands) and even the contrast between particles of the same orientation but mutually rotated. The latter was obtained owing to a slight specimen tilt by 1.3° , which removes the rotational symmetry of the experiment. The images a-f were taken at 6.5, 7.5, 10.5, 16, 18, 22, 29 and 34.5 eV . The analysis of the crystal intensities in the dependence on the electron energy and impact angles with respect to crystal axes produce data containing all information about the surface crystallinity.

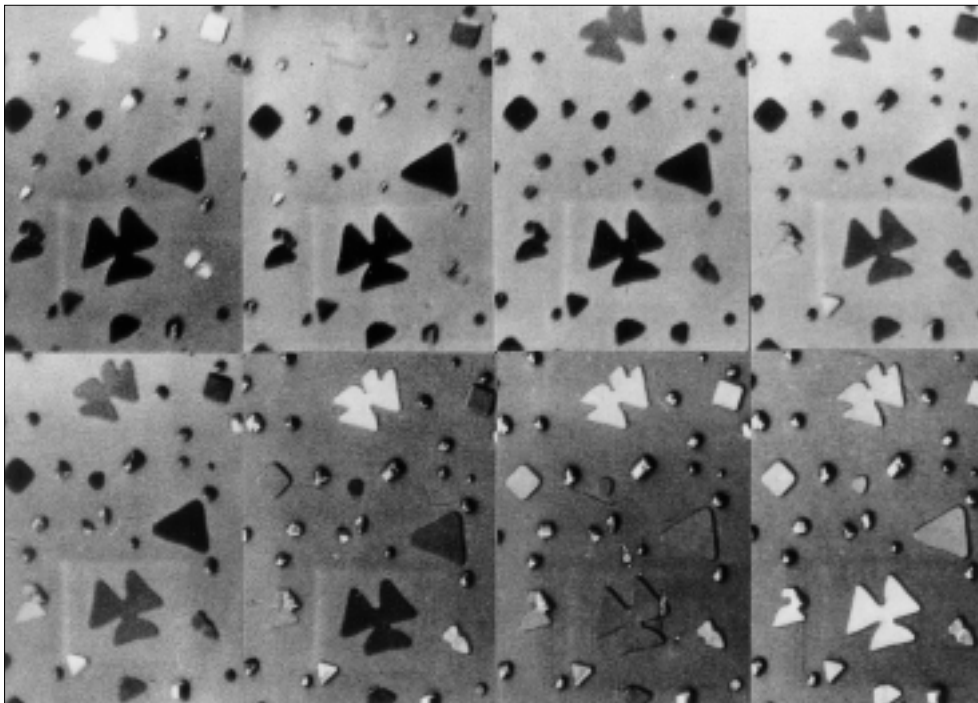

Fig.1. Pb islands deposited onto the Si (100) surface. Series of micrographs taken with the specimen tilted to approx. 1.3° in the direction inclined 55° with respect to the horizontal line. Electron energies from the top left by rows: 6.5, 7.5, 10.5, 16, 18, 22, 29 and 34.5 eV , width of field of view $50 \mu\text{m}$.

Very low energy electron microscopy combined with surface chemical microanalysis

Ilona Müllerová and Luděk Frank

Surface elemental composition and some additional chemical information about the solid surface can be obtained by various analytical methods employing electrons and photons. Of them, very important is the analysis of Auger electrons emitted from atoms after their ionisation at deep electron levels, and bearing energies equal to differences between the levels. As the information is hidden in the exact energy value, it can be extracted only when the electron avoids any subsequent collision, i.e. when it originates within a few nanometers at the surface. Thus, the analysis is extremely surface sensitive, which opens to it a broad field of applications including problems connected with corrosion, catalysis, wear and friction, segregation on grain boundaries (studied on brittle fractures), or any other tasks connected with the properties of very thin surface films and layers. In case a focused electron beam excites the Auger electrons, the emitted signal can be used for imaging in which the surface chemistry can be mapped at a high resolution. Nevertheless, the exciting beam penetrates into depths exceeding by orders of magnitude the depth under analysis so that the in-depth composition is a source of very undesirable spurious contrasts in the surface chemical mappings. In order to solve the described problem, the authors started a common project with Professor M.M. ElGomati in the University of York, UK. The idea was to combine scanning Auger microscopy (SAM) in one device with scanning low energy electron microscopy (SLEEM). SLEEM at various energies can examine the in-depth specimen properties and produce information necessary to suppress the spurious contrast in the SAM images.

The most frequently used SAM devices are based on the cylindrical mirror analyser (CMA) in which the electron energy is analysed by means of dispersion caused by the energy dependence of electron trajectories inside electrostatic fields between two cylinders. The primary beam source is designed as a sophisticated miniature electrostatic scanning electron microscope (SEM) column fitted into the inner cylinder of the CMA. Critical factors are tiny dimensions, very limited access to the column and restrictions as regards any fields radiated from it. In the project presented here, the demands were significantly extended, owing to the SLEEM adaptation of the column. This includes provisions for decelerating the primary electrons down to an arbitrarily low landing energy in the immediate vicinity above the specimen by using the so-called cathode lens. Furthermore, a novel type of detector was needed for very slow signal electrons re-accelerated by the cathode lens and thus collimated toward a narrow beam along the axis.

The cathode lens between the final column electrode and the specimen holder was designed. The detector was solved

as the in-lens type fitted to inside the outer half of the final column lens. The lens field was modified so that it, in addition to the primary beam formation, decelerates the accelerated signal electrons toward a special mirror electrode with a suitable coating. The tertiary electrons emitted from the mirror are once more, within the same field, re-accelerated and detected by a channel-plate based detector with the collector split into segments enabling one to acquire also the azimuthal signal distribution.

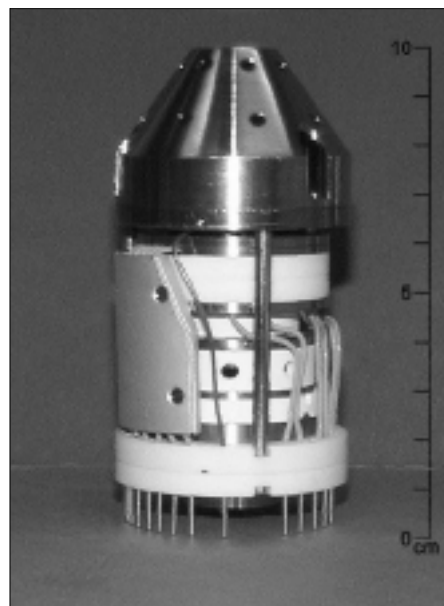

The device, shown in the figure, has been designed as fully UHV compatible and bakeable, manufactured and verified in a separate SLEEM operation. Sophisticated pre-alignment provisions are applied which make the operation possible with only one stage of the octupole deflection/stigmating/centering unit. The full column with the built-in detector is 89 mm long and 44.6 mm in diameter. The image resolution at mere 3 eV of electron energy was measured to be worse by a factor of 1.85 only with respect to 2000 eV electrons (while in a normal SEM without the cathode lens, this factor amounts to 130). The total detector efficiency, expressed as a portion of the emitted electrons which causes a signal impulse, was carefully analysed and found to be 35% for 10 eV and 26% for 1 eV electrons. These values significantly exceed those for other detector types. The novel SLEEM column has been used for examination of various layered structures and in the next period, in co-operation extended to Shimadzu Research Laboratory, UK, it will be incorporated into an already prepared CMA device.

Laser refractometer

František Petrů, Ondřej Číp, Josef Lazar and Pavel Pokorný

The laser refractometer for the measurement of the refraction index of air is used mainly for laser interferometers intended for length measurement. The device determines the refraction index of air and thus in fact also the laser light wavelength in the air. The length measurement is then converted into the determination of the number of wavelengths of laser light along the measured path. The laser refractometer measures the refraction index of air with the utmost accuracy. It uses the interference principle and a cell that is being evacuated and filled and is positioned in one path of the symmetric difference interferometer.

The device consists of a single-frequency He-Ne laser **L** with a precisely known vacuum wavelength, a difference interferometer **I** with a built-in cell **K** that can be evacuated, and a unit for the detection of interference signals **D**. A computer performs the evaluation. The refraction index is evaluated from the quotient of the optical paths in the cell that is filled with air and then evacuated. The device uses a new type of high-stability laser difference interferometer with 0.3 nm resolution. To achieve the highest parameters of the device, conditions for the limiting accuracy of the

refractometer were determined. The detection system evaluates the number of fractions of the interference units given by the difference in the optical paths for the evacuated and air-filled states of the cell and sends the result into the evaluation electronics. On the basis of the known wavelength of light of the used laser, and of the number of fractions of the interference units, the computer then directly computes the refraction index of air. The high accuracy of the device is further increased by averaging the values in adjustable time, and the refraction index is directly evaluated at the end of every measurement.

On the basis of international collaboration, comparison measurements of our refractometer with those of Physikalisch-Technische Bundesanstalt in Berlin und Braunschweig /PTB/ were made. The measurement accuracy of the order of 10^{-8} was verified by comparing it with the most accurate values of the refraction index evaluated indirectly by a modified Edlén's formula. The measurement reproducibility was of the order of 10^{-9} . The device can be used for testing wavelengths of industrially manufactured laser interferometers.

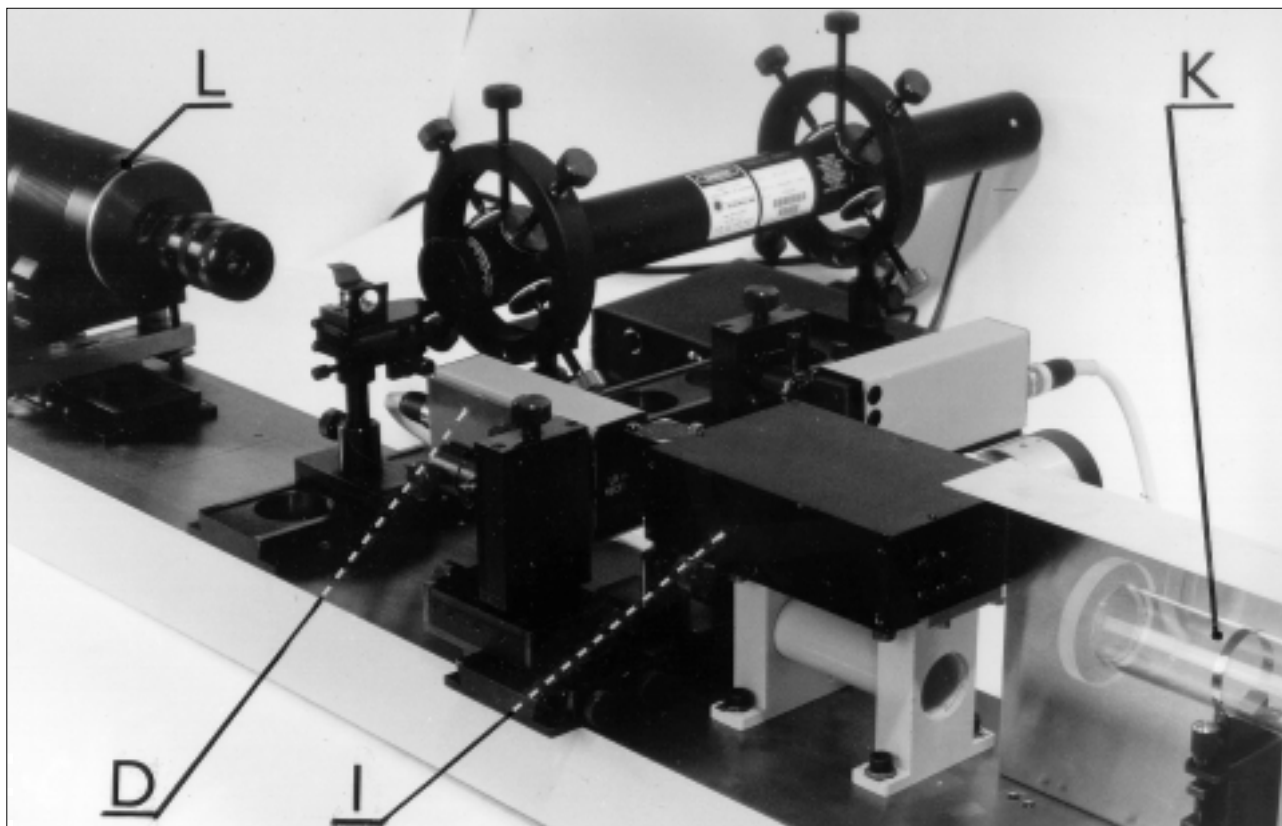

Fig.1. Laser refractometer composed of the laser **L**, interferometer **I**, evacuated and filled cell **K** and the detection unit **D**.

Laser interferometer with 0.3 nm resolution

František Petřů, Ondřej Číp, Josef Lazar and Pavel Pokorný

A number of applications in the field of nanotechnologies and in metrology require measurement of lengths with subnanometer resolution, high stability and good scale linearity. This demand is best met by the laser difference interferometer with a symmetric arrangement of light beams. The realised difference interferometer consists of reference and measuring branches. The path difference between both branches is only measured, so that the influence of the dead path toward the measured object is eliminated. A high resolution and good scale linearity of the interferometer itself are achieved by utilising a multiple pass of light beams through the interferometer. A four-fold pass of light beams through both the reference and measuring paths of the interferometer is used in an arrangement that is strictly symmetric with respect to the centre of both the reference and measuring light beams. This way, the measurement of shifts only in the direction of the axes of the light beams is ensured. The result of the four-fold pass of light beams through the interferometer is that the interferometer shows not only a four times higher resolution but also a four times higher scale linearity, compared to a simple interferometer. A multiple pass of light beams

through the same optical elements of the interferometer puts high demands on the elements from the viewpoint of geometrical as well as polarisation optics. The design and measurement of optical elements were made by J. Kršek, Technical University of Brno. The design of polarisation optics must prevent the mixing of multiple passes and must ensure minimum phase shifts for different polarisations of light beams. In this way, the scale non-linearity caused by the mentioned effects is eliminated and only the non-linearity due to the interference of two wavefronts with different axes of light beam propagation persists. To minimise the cause, the design of the interferometer is based on plane reflecting mirrors that, when tilted, do not cause any angular deflection of the interfering light beams. They cause only a shift of the axes of the parallel light beams. For plane wavefronts, no non-linearity occurs, and for spherical wavefronts, the distortion is lower. In connection with an electronic system, the resolution of the interferometer is 0.3 nm and, if no correction is made, the scale non-linearity is, in the dependence on the setting, about 1 to 2 nm. The stability of the basic device is about 0.5 nm.

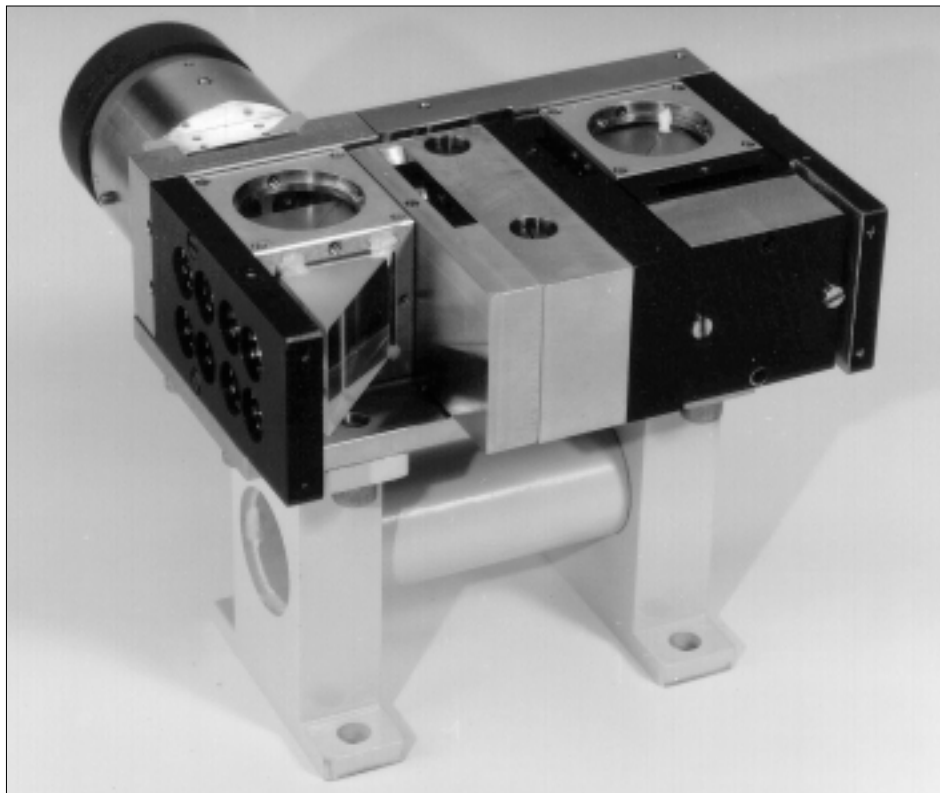

Interference Multilayers for Lasers and Interferometry

Pavel Pokorný

Optical interference coatings are used for desired forming the spectral curves of reflectance and transmittance or phases of the complex reflection or transmission coefficient. Most common applications of thin films are narrowband or achromatic antireflection coatings, non-absorbing mirrors, neutral or one-wavelength beamsplitters, monochromatic filters, additive or subtractive dichroic colour filters, cold mirrors, heat filters. In cases, which require an oblique incidence, the spectra become the function of light polarization. Examples of such applications of thin films are polarizers, depolarizers or various defined beam splitters. The task of our laboratory is to design and produce optical coatings for lasers and interferometry.

One of the most important sorts of elements is that of mirrors forming the resonator of He-Ne lasers operating at the 543 and 633 nm wavelengths. The required parameters are: maximum reflectance and specified transmittance at the functional wavelength, minimum reflectance at the wavelengths corresponding to the undesired concurrent quantum transitions, low absorption and light scattering, mechanical, chemical and thermal resistance. Such a laser mirror consists of 20-30 alternating layers with high and low refractive indices, respectively. The design of their thickness is complicated especially by requirements regarding suppression of reflection for concurrent wavelengths. Demands on minimisation of the scattering and absorption necessitate searching for corresponding layer materials and technology of their deposition.

An example of the so called minus filter is the laser goggles that protect eyes of people working with lasers. Transmittance of the laser wavelength must be suppressed (proportional to power of laser), but ability of sufficient seeing must be retained.

Antireflection coatings are used to reduce unwanted surface reflectance of optical components and to transilluminate them. Each type of glass, each wavelength, polarization and angle of incidence of light needs some other coating. The simplest case of one wavelength and normal incidence requires a double-layer with their thickness matched to the type of glass and wavelength. A difficult case is simultaneous suppression of reflectance in oblique incidence for both polarizations.

Thin film edge filters can serve in multi-colour interferometry as beam separators. For example, the beam from the green laser can be transmitted while that from the red one is reflected. Problems can arise in oblique incidence, when the position of the edge is dependent on the polarization of light.

Polarizing beam splitters are used for simultaneously polarizing 543 and 633 nm laser light for reflection and

transmission. The extinction ratio of both polarizations should be at least 500. An additional requirement is that the reflected and the transmitted beam must form the right angle. The refractive indices of both layer-forming materials and glass must respect the technological possibilities. From this it follows that it must be a cemented cube. It is possible to choose from two compromises: a cube of perfect optical glass BK7 with a coating containing unstable cryolith layers, or worse heavy optical glass with a good quality layers-technology $\text{TiO}_2/\text{SiO}_2$. Such a polarizer needs 10-15 layers. Attention should be paid to the optical effect of the cement. Outer walls of the cube must be provided with antireflection coatings for both wavelengths and for the chosen type of glass.

On the contrary, some interferometers make use of non-polarizing beam splitters, in which case both polarizing components are required to show 50% reflectance and transmittance for an angle of incidence of 45° , and phase differences p-s are required to be zero for both reflection and transmission. For a single wavelength, these conditions can be fulfilled by using a simple alternating system, e.g. 15 quarter-wave layers of $\text{TiO}_2/\text{ZrO}_2$. For more wavelengths, it is difficult to fulfil the phase condition. All these systems are however very sensitive to usual production deviations and it is therefore better to be content with compromise depolarization that can be achieved using for example a system of 6 quarter-wave layers $\text{TiO}_2/\text{Al}_2\text{O}_3$. The residual polarization of reflectance/transmittance amounts to about 7%, the phases are ideally depolarized, spectral dependence is weaker and deposition of such a system is reproducible.

Another application of coatings is compensation of the polarization effect of the cube-corner retro-reflector. Phase differences that arise in the cube-corner at total reflections on its three faces are usually undesirable in interferometry. For total reflection, reflectance (100%) and transmittance (0%) cannot be changed but the values of phases of the reflection coefficient can be changed by deposition of a suitable coating. So unwanted phase changes can be compensated by using correcting dielectric multilayers deposited on each face and matched to the type of glass and angle of incidence. In the most often case of normal incidence on the base of the cube-corner, the same coating consisting of 2-5 layers is deposited on all faces. More layers in the coating bring less spectral dependence. The base of the cube-corner must be provided with an antireflection coating.

Single crystal imaging screens

Petr Schauer, Rudolf Atrata, Armin Delong, Ivan Vlček, Otakar Hutař, Karel Hladil and Martin Klvač

In a transmission electron microscope (TEM), the image is formed by free electrons transmitted through the investigated specimen and guided by electron optics of the microscope to the site where the image information is to be visualised. For this purpose, an image screen is used which is capable of converting the energy of signal electrons into photons and offers the resulting image to the human eye or to a recording device. This happens the same way as in TV. The only essential difference is that in TEM the whole image is produced on the screen simultaneously, while on the TV screen the image is being gradually composed pixel by pixel and line by line until the whole image is ready. The screen is thus an indispensable cathodoluminescent element that is to convert the electron-carried image information into a useful form.

In TEM, no high demands are put on the true colour reproduction of the image. It is however important that the spectrum of the emitted light should be suitable both for the direct observation with the human eye and for photographing or recording by a CCD camera. An important parameter of the TEM screens is the cathodoluminescent efficiency because it determines to a certain degree the signal-to-noise ratio, which is always the measure of quality of the resulting image. In comparison with TV screens, with the TEM screens the highest demands are put on spatial resolution. The reason is that current TV screens have diagonals usually longer than 37 cm so that the pixels are relatively large (larger than approx. 0.4 mm). Images on TEM screens are much smaller, and are not scanned so that the pixel size is at least two orders smaller than that with TV screens. In miniature TEMs, where the image taken from the screen must be considerably magnified, the image on the screen is required

to have even submicron pixel resolution. Such a small pixel size is unattainable when classical powder screens are used because their pixel size is limited by the powder grain size (3-10 μm). Single crystal imaging screens have no such resolution limitation. Moreover, they are optically transparent and possess perfectly defined optical properties. Besides, crystals can be modified with a high accuracy, even very thin and small imaging screens can be made prepared from them.

In Electron Microscopy Laboratory, a number of powder and single crystal cathodoluminescent materials were examined. For the use in TEM, the single crystal of cerium activated Yttrium Aluminium Garnet – YAG:Ce (Fig.1) seems to be the most advantageous. This single crystal was developed at our laboratory in collaboration with Preciosa Crytur for scintillation detectors of scanning electron microscopes. It emits yellow-green light that is ideal for the human eye and possesses an extremely high electron beam resistance so that its lifetime is practically unlimited. The project of the study of the spatial resolution of YAG:Ce screens was started at our laboratory by measuring the transfer function by means of the edge projection method on the TEM Philips CM-12 microscope. The image of the edge on the examined YAG:Ce screen was in the first stage of the study, after processing by magnification optics, recorded by the classical photographic technique. The development of a digital processing method by using a CCD camera is in progress. The measurement was accompanied by Monte Carlo simulation (Fig.2) of the distribution of the absorbed energy corrected for electron diffusion. The first results of the study of single crystal YAG:Ce screens give space resolution of 150, 18 and 8 lp/mm for electron beam energies of 20, 60 and 100 keV, respectively.

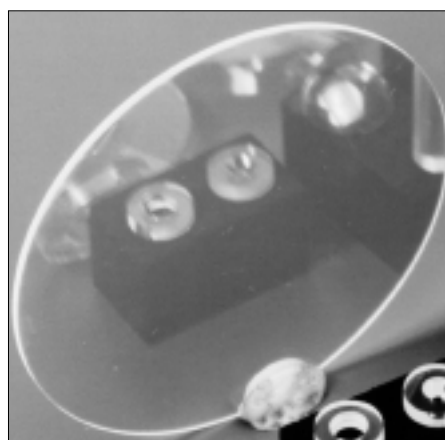

Figure 1. YAG:Ce single crystal imaging screen for TEM.

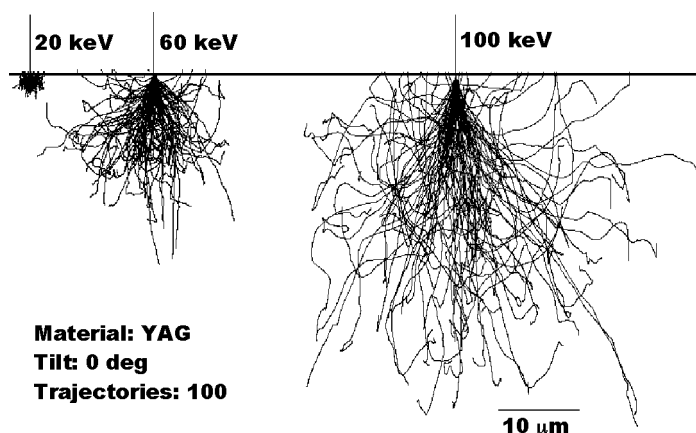

Figure 2. Monte Carlo simulation of interactive volumes in the YAG:Ce single crystal screens.

Nanostructured multilayers

Jaroslav Sobota and Jaroslav Boušek

Nanostructured multilayers are the latest generation of hard coatings for engineering applications that enable, by using an optimal ratio of individual components, creation of a stable structure with unique physical properties, and particularly combination of properties conventionally considered as excluding one another, such as high hardness and high toughness. Besides standard titanium nitride films, other carbide and nitride layers, such as chromium nitride, titanium carbide and multicomponent coatings TiAlN and TiCN are used at present, and in recent years also more complex multilayer and gradient coatings appear. Mastering deposition of these coatings has brought improvement in wear and corrosion of the coated products. In spite of this, it is clear that the possibilities of improving these coatings were not completely exhausted. To achieve a significant progress, we must change to nanocomposite coatings.

The idea of creating nanocomposite coatings as the next generation of hard coatings for tools originated in the nineties, in parallel at several laboratories. At our laboratory, we utilised our experience acquired in collaboration with the Institute of Physics ASCR on preparation and characterisation of multilayered systems with the bilayers thickness in the nanometer range applicable in x-ray optics. In the field of evaluation of microhardness and adhesion of DLC and CN_x coatings we collaborated with HVM Plasma L.t.d.. Managing these technologies led to the idea to apply the knowledge acquired in implementation of x-ray mirrors to the field of coatings for tools. In 1994 we established contact with the group of surface modification and tribology at the Institute of Physics and Astronomy in Aarhus where the sputtering system suitable for deposition of nanocomposite multilayers was at the disposal. After its undemanding reconstruction we began there the experiments, which in 1996 led to the verification of the chance to realise the designed nanostructured systems. At that time the first papers about nanostructured multilayers from several other laboratories (Wright Laboratory - Materials Directorate, Wright-Patterson Air Force Base, Ohio USA; BIRL, Northwestern University Illinois USA and Institute for Chemistry of Inorganic Materials, Technical University Munich, Germany) started to appear. In 1996 we managed to establish contacts with these laboratories. In 1996-1997 the investigator of the project worked on nanocomposite coatings at the Tribology Laboratory in Aarhus University. Since 1998 the project of nanostructured multilayers has been dealt with also in ISI (see the figure). The entire coating a few micrometers thick composed of hundreds up to thousands of bilayers is deposited by magnetron

sputtering during substrate rotation in front of carbon and metal targets in a reactive atmosphere composed of a mixture of argon and nitrogen.

These coatings are useful for a wide spectrum of machine industry products, from cutting tools to bearings of compressors and pumps. The purpose is not only to prolong the lifetime of products but in many cases the ecological aspects, such as elimination or limitation of cutting fluids,

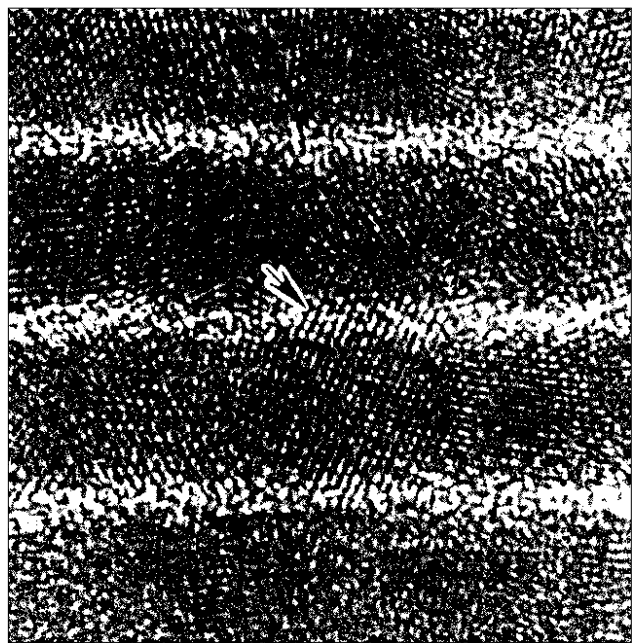

10 nm

Fig.1. *The cross-section of a multilayer (HREM) is an example of a multilayer structure, where thin films of metal nitride (marked with the arrow) and films of carbon nitride (dark) alternate.*

play an important role here. This is allowed by the use of carbon containing nanocomposite coatings, when the friction coefficient without lubrication is lower than typical friction values for the system steel - high quality lubricant - steel. Managing creation of these sophisticated coatings in the industrial coating centres will be the challenge for the first decade of next millennium.

Broadband and narrowband decoupling using adiabatic spin-inversion RF pulses

Zenon Starčuk, jr., Zenon Starčuk, and Karel Bartušek

Decoupling is an invaluable tool in most modern NMR experiments. Heteronuclear and homonuclear scalar coupling lead to complicated multiplet structures and extensive line broadening in NMR spectroscopy, unless they are simplified by decoupling using a suitable radiofrequency irradiation scheme. In addition, decoupling improves the sensitivity by gathering all the intensity of a multiplet into a singlet, and by generating a nuclear Overhauser enhancement (NOE). As higher and higher static magnetic fields are becoming available, the bandwidth that must be covered by decoupling steadily increases. The demands are particularly severe for inverse detection methods, which have become ubiquitous in biomolecular NMR and which require spins such as carbon-13 and nitrogen-15 to be decoupled while the protons are observed. Here an ultra-broadband decoupling uniformly efficient across the entire range of chemical shifts of the irradiated spins is required without undue radiofrequency heating of the sample. The heating problem may become severe also in relatively narrowband decoupling applications, such as proton decoupling in *in vivo* phosphorus-31 NMR spectroscopy. Until recently, various very sophisticated sequences of composite inversion RF pulses exploiting complex phase cycles and supercycles for reducing unwanted effects due to imperfect inversion have been used for broadband decoupling in high resolution NMR spectroscopy.

On the basis of our experience with (a) the use of frequency (phase) swept adiabatic pulses for the spin inversion in various NMR experiments and (b) the development of composite pulse sequences for broadband decoupling we proposed new broadband decoupling methods where spin inversion is achieved adiabatically with either sech/tanh RF pulses (ESMRMB, Roma, 1993, SMRM, New York, 1993, J. Magn. Reson., 1994) or properly modified „chirp“ RF pulses (ESMRMB, Wien, 1994). To the analysis of the proposed decoupling adiabatic schemes, a theoretical approach designed for composite pulse cycles by Waugh has been applied. We

found that the – until 1994 persisting – conviction that, in comparison with conventional RF pulses, adiabatic pulses require in general much more RF power and are, therefore, not suitable for broadband decoupling was wrong. On the contrary, we found RF power demands of properly designed adiabatic pulse sequences substantially lower than those of composite pulse sequences. Recent investigations have shown that adiabatic pulse sequences can ensure outstanding broadband decoupling even in future generation of extremely high field NMR spectrometers operating, for instance, at 1 GHz for protons.

Adiabatic decoupling benefits from the outstanding inversion performance of adiabatic pulses providing a very flat inverted region independently of the RF field homogeneity and very sharp frequency cut-off between the decoupled and the fully coupled spectral regions. All decoupling power is concentrated in the decoupled bandwidth. For this reason, adiabatic pulses can be employed with advantage not only for ultra-broadband decoupling but also for both heteronuclear and homonuclear narrowband/selective decoupling. The lower limit of the decoupled bandwidth is given by the magnitude of the J -coupling constant (for instance, for J of 10 Hz, the bandwidth of decoupling can be as narrow as 150-200 Hz). The narrowband low RF power adiabatic decoupling can be of importance not only for many high-resolution NMR experiments in liquids but also for localised *in vivo* NMR studies. Under certain conditions, cycling sidebands appear in the decoupled spectra. Two methods were employed for their suppression. First, the MLEV-16 supercycling and, second, the "accordion" technique based on variation of the repetition time of RF pulses in the decoupling sequence.

Thanks to its outstanding decoupling performance, robustness, general applicability, and easy implementation on the current generation of commercial instruments, the adiabatic decoupling technique has been very fast acknowledged as superior to all other means of broadband decoupling and started to be widely employed.

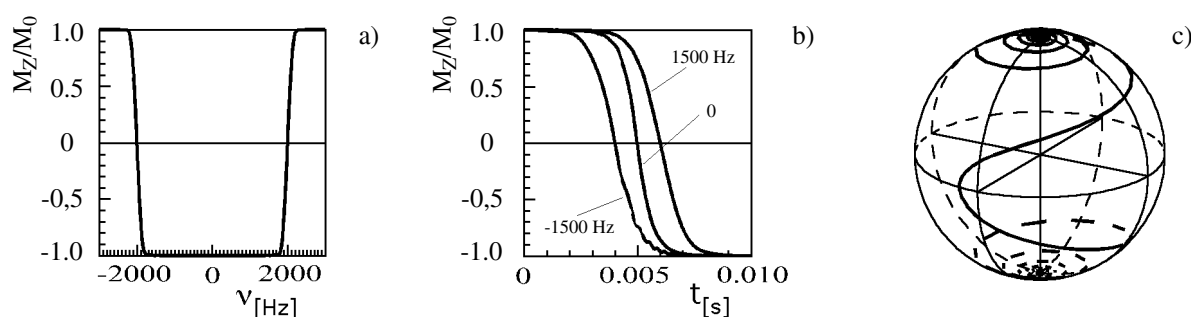

Figure 1. (a) Typical inversion profile of sech/tanh RF pulse. (b) M_z trajectories generated by the sech/tanh RF pulse at -1500, 0, and 1500 Hz offsets. (c) Magnetization trajectory generated on a unit sphere by the sech/tanh pulse.

Frequency selective RF pulses for NMR spectroscopy and imaging

Zenon Starčuk, Zenon Starčuk,jr., Karel Bartušek, and Jaroslav Horký

At present, there are many experiments in high-resolution NMR and, particularly, in spatially localized NMR spectroscopy and NMR imaging that call for continuously modulated radiofrequency RF pulses which perturb nuclear spins over a well prescribed frequency range without affecting magnetization elsewhere. The subject of frequency selective spin manipulation has many facets. Search is conducted for band-selective RF pulses differing, in particular, in (a) modulation type (amplitude, amplitude and phase, stochastic phase modulation), (b) flip angle (with specific interest paid to 90° and 180° RF pulses), (c) main effect provided (excitation, de-excitation, inversion, refocusing, saturation). Because of their multipurpose destination, frequency selective RF pulses should often satisfy rather contradictory requirements. A treatment of the frequency selective excitation is by no means a simple matter, since it belongs to the class of inverse problems for which an exact unique solution does not exist. Besides the trial and error technique, many methods have been proposed until now for developing frequency selective RF pulses, using different kinds of calculation and optimization techniques, such as the optimal control theory, conjugate-gradient techniques, evolutionary methods, simulated annealing, neural network schemes, inverse scattering transform, Shinnar-Le Roux transform. Computer optimization typically involves specifying and then adjusting suitably chosen parameters describing a trial pulse shape until the response achieves the given target profile.

The research work of the NMR methodological group in the field of frequency selective excitation with the use of continuous RF pulses followed very successful research activities of this group in the design and applications of a variety of composite RF pulses and their sophisticated cycles and supercycles.

The first successful result achieved in the field of frequency selective excitation using shaped RF pulses consisted in the development of a new technique for

designing continuous analytically defined symmetric amplitude-modulated 90° RF pulses for excitation and 180° RF pulses for spin inversion and refocusing (echo generation), all exhibiting outstanding frequency profiles. Until now, only an imperceptible improvement of frequency profiles has been achieved in the case of the originally designed 180° RF pulses thanks to the application of elaborated optimization techniques. On the basis of the developed symmetric RF pulses, 90° and 180° asymmetric pulses were designed with very good excitation performance. Asymmetric RF pulses are important, in particular, for NMR experiments where besides a good frequency profile also a short duration of RF pulses is required. This is, for instance, the case of the heteronuclear broadband decoupling and slice selection in some techniques for spatially localized NMR spectroscopy. The designed 90° and 180° RF pulses (both symmetric and asymmetric) can serve for the construction of RF pulses with flip angles between 90° and 180° . On the basis of asymmetric 90° and 180° very important composite continuous RF pulses with a virtual phase focus either following the end or preceding the start of the pulse can be constructed. These pulses have been successfully applied, for instance, in SPRES sequences recently developed in the group of NMR methodology for *in vivo* spatially localized NMR spectroscopy. Starting from symmetric 180° RF pulses, antisymmetric RF pulses were designed having a variety of applications in NMR spectroscopy (whole antisymmetric pulse can be used for the double-band spin inversion or echo generation, one half of this pulse can be used with advantage in several NMR experiments for selective coherence-transfer, double-quantum filtration etc.).

For highly selective saturation of the unwanted magnetization, the use of the frequency (phase) swept RF pulse was proposed and successfully applied in *in vivo* proton NMR spectroscopy.

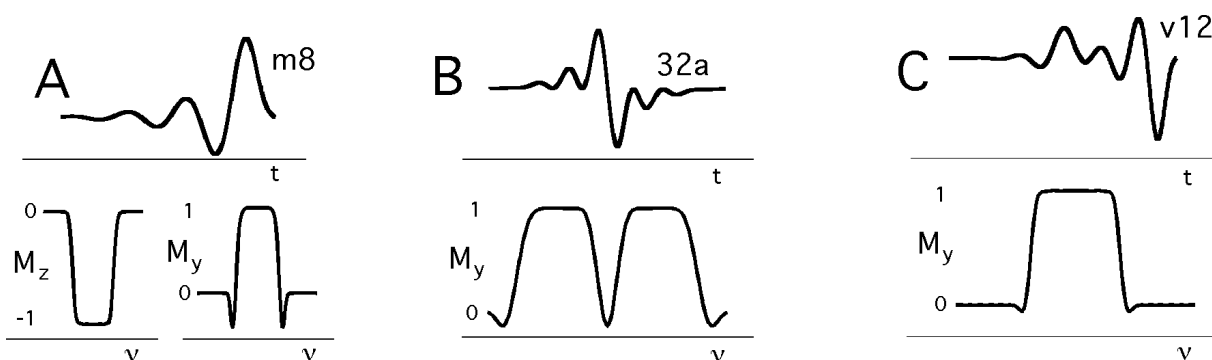

Figure 1. Examples of the designed frequency selective RF pulses and their excitation profiles. (A) 180° RF pulse m8 and its inversion (M_z) and spin-echo (M_y) profile. (B) 180° RF pulse 32a and the generated double-band echo (M_y) profile. (C) Delayed-focus RF pulse v12 and the generated pure M_y profile. Proper phase cycling was used to obtain echo signals rid of unwanted spurious signals.

Suppression of unwanted coherences in short echo time *in vivo* proton NMR spectra of the brain

Zenon Starčuk, Zenon Starčuk,jr., Karel Bartušek, and Jaroslav Horký

Proton magnetic resonance spectroscopy (^1H MRS) offers unique possibilities for noninvasive studies of biochemistry in the brain *in vivo*. A growing body of evidence suggests that ^1H MRS may become an important tool for the clinical evaluation of almost all major brain pathologies. Accurate and reliable quantification of metabolite resonances in MR spectra is one of the basic prerequisites for successful application of proton MRS in clinics. Acquisition of metabolite spectra free of any type of contamination is of crucial importance for their reliable quantification. In single voxel spatially localized MR spectroscopy, water and subcutaneous lipids occurring in the exterior of the volume of interest (VOI) are considered an almost exclusive source of contaminating signals. Due to magnetic field inhomogeneities and local magnetic susceptibility effects at interfaces air/tissue, both water and lipid resonances can span over a very large region of chemical shifts embracing practically the whole range of metabolite resonances. The amplitudes of contaminating (not suppressed) signals can often exceed considerably (even by several orders) those of metabolites. In real experiments, efficient outer volume suppression (OVS) is commonly very complicated owing to a non ideal behavior of experimental conditions. Therefore, usually as many of available approaches as possible (dephasing of unwanted magnetizations by spoiling gradients, properly designed phase cycling schemes, saturation of unwanted regions, proper choice of the slice ordering, use of spectroscopic acquisition mode, and, especially efficient suppression of the magnetization in all regions providing contaminating signals) have to be used simultaneously to maximize the OVS effect. However, even in this case, complete elimination of all contaminating signals remains a difficult task. Another problem which must be solved in *in vivo* proton MRS is the suppression of the water signal occurring at water nominal frequency. Many techniques for suppression of the dominating water signal in proton MRS have been designed until now. In

short echo time (TE) proton MRS almost exclusively sequences comprising chemical shift selective RF pulses with narrow bandwidth followed by gradient dephasing are used for water suppression.

In ISI AS CR, the problem of highly effective suppression of unwanted coherences in the short echo time proton MRS of the brain has been dealt with in a very complex manner and during solution several priorities have been achieved. All the above mentioned means have been exploited for the suppression purposes. Two types of sequences have been designed for CHES water suppression. The first type utilizes for water suppression 6-7 CHES asymmetric purely amplitude modulated RF pulses with properly chosen flip angles and interpulse delays containing spoiling gradients. The second type exploits for CHES WS hyperbolic secant 180° RF pulses with optimized offsets and interpulse delays. Both these WS schemes are very robust and insensitive to the RF field and T_1 inhomogeneities. For OVS original techniques based on saturation or inversion of suppressed regions using frequency swept 90° and 180° RF pulses, respectively, have been developed. All schemes were designed to make it possible to utilize spectroscopic acquisition mode for increasing their localization capability. To improve the localization performance of the employed VOI selecting sequences (STEAM, SPRES, PRESS), slice selective RF pulses have been developed which completely avoid the out-of-band excitation. It has been found that this last improvement can have a crucial effect on the elimination of contaminating signals until now often ascribed to some unspecified metabolites. The designed schemes have been verified on several animal and human commercial MR systems at MR Centers at Bratislava, Minneapolis, and Vienna. At all employed magnetic field strengths (3 - 9.4T), spectra with an outstanding purity have been obtained. This is documented in Fig.1 containing the MR spectrum acquired at 9.4T from the rat brain at Minneapolis.

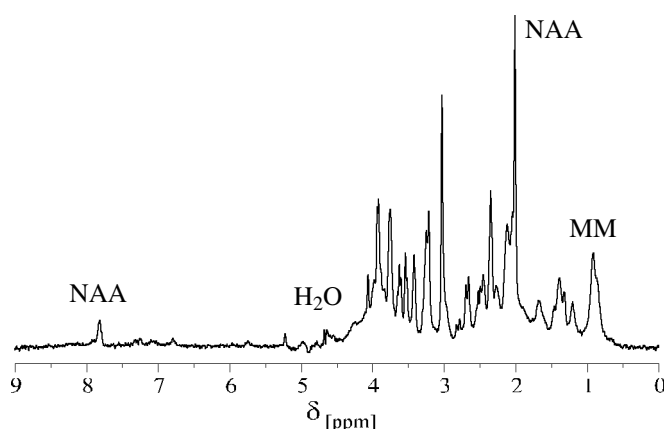

Fig.1. *In vivo* proton NMR spectrum of the rat brain measured by an ultra short echo time ($TE=1\text{ms}$) STEAM localization sequence equipped with (a) slice selective of outstanding localization performance, (b) water suppression scheme based on the use of seven asymmetric amplitude modulate CHES RF pulses, (c) outer volume suppression based on the use of hyperbolic secant RF pulses. The spectrum was measured at 9.4 T on the Varian (INOVA) MR scanner in the Center MRR, University of Minnesota, Minneapolis.

Measurement of *in vivo* proton MR spectra of pure metabolites or macromolecules in the brain using a very short echo time STEAM sequence

Zenon Starčuk, Zenon Starčuk, jr., Karel Bartušek, and Jaroslav Horký

Proton NMR spectroscopy of the brain can noninvasively provide very useful information about almost all important cerebral metabolites. Some of these metabolites, such as N-acetylaspartate, total creatine, cholines, and lactate possess relatively long T_2 relaxation times and, therefore, can be measured with a quite good efficiency at long echo-times (usually 135 or 270 ms). However, measurement of metabolites exhibiting short T_2 relaxation times and/or strong homonuclear coupling behavior (glutamine, glutamate, myoinositol, glucose, GABA) must be performed at very short echo times (even less than 10 ms) to achieve the required accuracy and reliability of the measurement. Acquisition of very short TE *in vivo* proton MR spectra of good quality has become feasible only quite recently thanks to some methodological developments and the availability of high performance actively shielded gradient systems with very fast rise times and substantially reduced eddy current effects. However, despite the methodological and technological progress, ultra short TE proton MR spectroscopy of the brain still remains a difficult issue. Serious problems in short TE proton MRS are bound with the necessity to suppress unwanted very strong signals of water and lipids. Water suppression in the volume of interest (VOI), which is the region providing the required metabolite spectrum, is most commonly performed with various chemical shift selective (CHESS) schemes. Much more difficulties are bound with suppression of water and lipid signals originating in regions outside the VOI. These signals can span over the whole chemical shift range of metabolites of interest and, if not eliminated, can fully prevent from the evaluation of the recorded metabolite spectra. All means available must be used to avoid this contamination problem.

At very short echo times, simultaneously with long T_2 relaxation time metabolites also coherences of macromolecules (proteins), possessing short T_2 relaxation times (about 20 ms), are detected with a fairly good efficiency. Macromolecule resonances underlie inherently

those of metabolites in both animal and human brain. Quite recently, it has been found that macromolecule resonances can be exploited as a new source of valuable information about a variety of brain diseases. Therefore, much attention is nowadays devoted to the development of techniques enabling one to measure separately proton MR spectra of low molecular metabolites and macromolecules. Mainly, differences in relaxation times of metabolites and macromolecules are employed to their differentiation. Separate measurement of metabolite and macromolecule spectra imposes increased demands on approaches employed for suppression of unwanted resonances.

In ISI AS CR developments have been performed leading to the design of complex measuring schemes capable to record separately ultra short echo-time proton MR spectra of the brain *in vivo* of low molecular weight metabolites and macromolecules. For the differentiation, differences in T_1 relaxation times of metabolites and macromolecules have been exploited. The timings of the developed measuring sequences were designed with the aim to reduce markedly the unwanted effects of inhomogeneities of metabolite and macromolecule T_1 relaxation times on their detection as well as suppression efficiencies. For measuring, the stimulated echo based localization sequence (STEAM) equipped with new RF pulses exhibiting outstanding excitation profiles, and new schemes for chemical shift selective water suppression and outer volume suppression have been employed. The developed schemes have been tested in MR Centers in Bratislava, Minneapolis and Vienna on animal and human MR scanners operating at 4.7T, 4T and 9.4T, and 3T, respectively. In all cases outstanding proton MR spectra of the brain have been obtained using echo times in the range 1-4 ms. Figure 1 shows pure metabolite and macromolecule spectra of the rat brain recorded with TE=2ms in Minneapolis on a 9.4T MR scanner. These ultra short TE spectra do not exhibit any contamination from unwanted resonances.

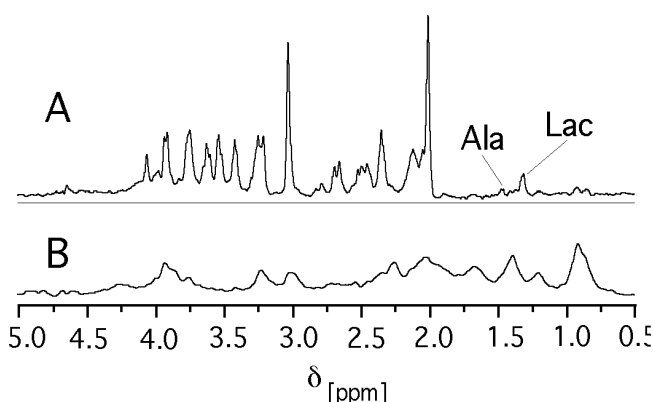

Fig.1. *In vivo* proton MR spectra acquired at 9.4 T on a Varian (INOVA) scanner using TE=2ms STEAM sequences equipped with asymmetric slice selective RF pulses. (A) Pure low molecular metabolite spectrum acquired with the acquisition time (AQT) of 16 min. (B) Pure macromolecule spectrum acquired at 25 min. In both cases VOI = 0.065 ml.

WIN-MRI: Open software system for processing, analysis and visualization of multidimensional NMR data

Jana Starčuková and Zenon Starčuk, jr.

In the past decade, NMR imagers have become widespread and the problem of incompatibility of data formats used by different spectrometer types has become very obvious. It results from the increasing number of NMR sites equipped by more spectrometers or willing to exchange data with others. At the same time, many progressive methods require specific data processing. The existence of proprietary formats and of software tied to them and to the operating systems preferred by the manufacturers (UNIX, Solaris, Windows) is an obstacle for data processing standardization, data exchange and scientific collaboration, it creates a monopolistic market with problematic and expensive software, it enforces customer loyalty. The support by manufacturers is limited by their commercial interests, by their years-long awaiting of markets that are to be created by the development teams of their customers. These either accept the manufacturer's platform, or reduce the cost of the development and of migration to another system by creating single-purpose software in some multiplatform environment (e.g., IDL), which, as a rule, necessitates frequent data transfers and conversions, often error-prone. The resulting applications tend to be bound to one specific experiment, often the author's presence, they do not use the computer power effectively and therefore they require extremely powerful computers, and their transfer into clinical praxis is difficult. The price of new method development increases.

For the reasons stated above, there appeared an idea at the Institute for Biodiagnostics, National Research Council of Canada (J. K. Saunders, P. Kozlowski) to develop a new, open, Windows-based, vendor-independent software system for multidimensional NMR data processing, visualization including experimentally dependent relations between various data sets, and their analysis. The program has been developed in cooperation with ÚPT AV ČR and the German company Bruker Daltonik GmbH (H. Thiele, A. Germanus). This company also became its commercial distributor. At the present time the program is used in

several research institutes and universities worldwide.

WIN-MRI is a software package for processing, display, and analysis of various types of multidimensional data (up to 10 dimensions) obtained in NMR imaging or spectroscopic imaging experiments. For example, WIN-MRI handles 2D and 3D images, 2D spectra, spectroscopic imaging data, multi-slice and/or multi-echo images, time series of such experiments. The system is open – its functionality can be expanded by building new functions in dynamically linked libraries (DLL), which are automatically linked with WIN-MRI. At the same time a new menu item is inserted into the program menu, based on a simple text file. The program is distributed with several DLLs for loading data from most major NMR equipment manufacturers. Data transfers to/from other applications are handled in a standard way (transfer of bitmaps, metafiles, texts via clipboard).

Besides visualisation of NMR-specific relations in data (e.g., spectroscopic-image pixel position or spectrum origination with respect to a pilot image), WIN-MRI implements most usual operations on images (intensity manipulation, zooming, symmetry operations). At the same time, any number of images can be displayed, the images can be overlaid, their zooming can be changed, 3D data can be viewed in a rotatable cube. Data can be reconstructed (it is possible to restrict the Fourier transform to some directions only, correct DC offset, perform windowing, interpolate, eliminate frequency-dependent phase error), phase corrected, resampled, images can be linearly combined. For the analysis WIN-MRI offers a possibility to define regions of interest in images, their statistical evaluation, geometric measurements, calculation of relaxation times T_1 and T_2 , calculation of diffusion coefficients etc.

The present work on WIN-NMR is oriented to its integrability in an experimental environment (creation of communication paths to other applications by means of DDE and sockets, and macro interpretation).

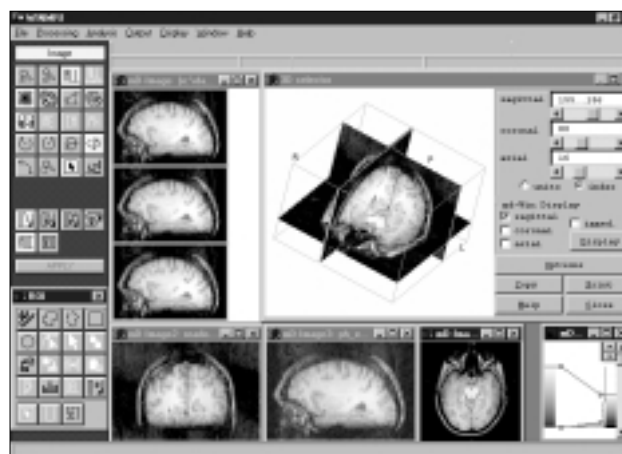
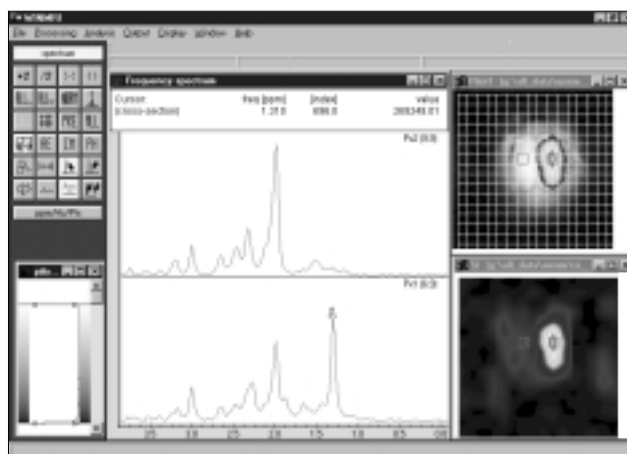

Examples: *spectroscopic imaging with a pilot image (left), 3D imaging (right).*

NMR experiment simulator for the development of spatially and/or spectrally selective techniques

Zenon Starčuk, jr. and Zenon Starčuk

One of the areas in which NMR has demonstrated its ability to produce relevant information is biomedicine. For diagnostics and for the research of metabolism of healthy and diseased tissues in vivo a large number of experimental techniques have been developed in the past decade, including 2-D and 3-D imaging (MRI), localised 1-D and 2-D spectroscopy (MRS), and spectroscopic imaging (MRSI). Many methods (esp. MRI) have already migrated from research into clinical praxis, others (MRS, fast imaging techniques) are still a subject of R&D. The development of a technique for a particular application aims at obtaining valuable information in the shortest time possible, while meeting the requirements for method robustness, energy dissipation etc. The development of new methods and technology is the basis for the growth of the quality of measured and analyzed data, broader applicability, and economic acceptability in clinical use.

Most biomedically useful techniques require spatial localization and in many in vivo and in vitro methods spectral selection is needed. Spectral selectivity is based on excitation with frequency selective RF pulses. Spatial localization is achieved by a gradient base- or RF-field in combination with frequency or amplitude selective RF pulses (spatial selection) or with acquisition in more dimensions (position encoding). To achieve the desired function, several shaped RF and gradient pulses are often needed in one sequence, accompanied by phase cycling. No analytical solution is available for the calculation of the spin behaviour in such a general excitation. For the design of pulse sequences, simulation solution of Bloch (or Liouville) equation is a suitable method. Unlike high-resolution spectroscopy, most present biomedical applications can be handled with the classical vector model of the quantum system, but on the other hand more emphasis must be put on robustness, i.e., the sensitivity to the disagreement of

reality and the physical model used in method design.

Simulation is an important tool in method development which allows one to observe general relations which cannot be easily determined experimentally because they are invariably linked to the instrument (inhomogeneity of magnetic fields) or to the internal properties of the measured subject, e.g., to the dispersion of spin parameters (relaxation times). One can also observe the evolution of quantities that are forming factors (coherence-transfer, CT-, profiles of selective pulses) or potential sources (macroscopically dephased CT pathways, other than 1-quantum coherences) of the signal in future evolution, but which are not directly detectable and only describe some internal order in the spin system, without external manifestation. Because of the large number of factors affecting the experimental result, simulation is valuable by its ability to isolate individual effects and to reliably isolate magnetization components with different histories of coherence-level transitions.

For these purposes we developed program Romag (PC-DOS, co-authors Sklenář, Půček and Kessler). It is not an ideal duplicate of a spectrometer, but rather an analytical tool showing the evolution of a given physical model. Romag is able to simulate the evolution of magnetization of noninteracting nuclei with spin 2, or of two weakly coupled nuclei in decoupling. The model includes the chemical shift, spatial position, gradients, relaxation times T_1 and T_2 , and local RF field strength. Their values can be set independently and any of them may be used as an independent variable. Pulse sequences are defined interactively or in text files. Romag supports construction and import/export of shaped RF pulses. The calculated magnetization or CT profiles can be presented graphically and exported to other applications. The program has been extensively verified experimentally.

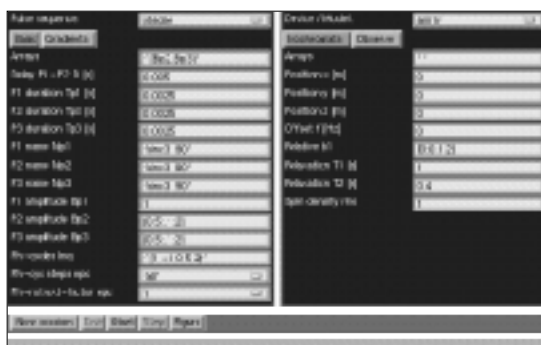

Fig.1. Control panel.

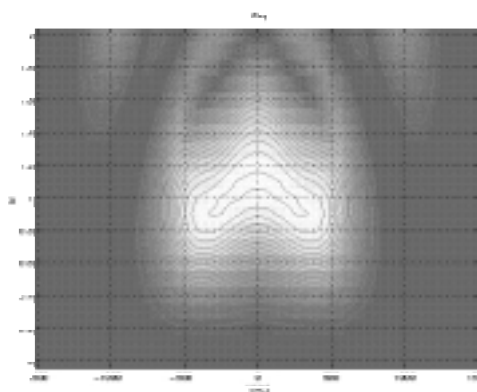

Fig.2. Result example (3-pulse excitation for MRS).

A new Matlab-based simulator version supports pulse sequences with general calculations, with concurrent actions (shaped RF and gradient pulses). It supports calculation of integral signals, more independent variables – incl. pulse sequence parameters, it displays 1-D and 2-D dependences.

Clear separation of infrastructure, pulse sequences, and the simulation core modeling the spin system opens the way to creating special models and to automatic parameter optimization.

Absolute Distance Interferometry

Alois Stejskal

Absolute Distance Interferometry (ADI) could be a somewhat misleading name. It is a measurement method for finding the distance between two objects, equipped with appropriate optical elements (corner cube, beamsplitter, etc.), with a precision comparable to that of standard interferometric measurements but without the need to pass smoothly from one point to another with the corner cube. This can be accomplished through the use of semiconductor lasers which can be tuned in wavelength by an amount many orders of magnitude greater than can a gas laser. Diode lasers can be tuned in wavelength by about 0.1% to 1% of the central wavelength. However, the tuning must be smooth and continuous so that it is possible to follow the response at the output of the interferometer.

There are two basic approaches to this problem:

(1) Tune the laser between two precisely defined frequencies given by atomic absorption lines.

(2) Apply a second interferometer as a reference; the unknown distance being measured is calculated by multiplying the known length of the reference interferometer by the ratio of the number of pulses obtained in the interferometer that measures the unknown path to the number of pulses in the reference interferometer. We are using the second method, because it automatically compensates for the effect of changing atmospheric parameters on the wavelength of the laser. Of course, it is necessary to place the reference interferometer in a position where atmospheric conditions are similar to conditions in the measurement path.

Often the term “synthetic wavelength” is used in absolute

interferometry. The synthetic wavelength λ_s is defined by

$$1/\lambda_s = 1/\lambda_f - 1/\lambda_i \approx \Delta\lambda/\lambda_i^2$$

with $\Delta\lambda = \lambda_f - \lambda_i$. Here λ_f and λ_i are the wavelengths at the end and beginning of the measurement and $\Delta\lambda$ is small so $\lambda_f \approx \lambda_i$. The smooth tuning range of the laser is very small, about 10^{-3} of the wavelength. Therefore $\lambda_s \approx 1000\lambda$ and the basic resolution of ADI is about 1000 times worse than a standard interferometer. Careful electronic processing is required to obtain a resolution on the order of nanometers.

Heterodyne techniques rather than DC fringe processing are needed to achieve sufficient dependability. A second frequency for heterodyne processing was obtained from an AOM at 80 MHz. A generator working at a frequency close to the AOM and a DBM (double balanced mixer) were used to mix-down the 80 MHz AOM frequency into a region more suitable for processing. Unlike the somewhat similar Zygo system, here the spatial separation of the beams is maintained. The problem of polarization mixing is thus avoided, which is important because any such small parasitic effects are several orders of magnitude more disturbing here than in classical interferometry.

After several tens of seconds of averaging, distances of a few meters can be measured with an accuracy comparable to that achieved with classical interferometry.

ADI is most important in applications where it is not practical or even impossible to pass a corner cube between two points as is required in classical interferometry. Unlike some ADI methods, the method described here does not require any previous information about the value of the measured distance.

Frequency Stabilization of a Gre-Ne Laser

Alois Stejskal

Contrary to the He-Ne laser, which generates a wavelength 632.8 nm, where several methods for frequency stabilization achieve acceptable results, in the case of stabilization of green lasers (543 nm) the variety of methods is not so wide, because of the very low gain of the active medium. One method of frequency stabilization is to apply so-called nonlinear dispersion, which causes the difference frequency between modes being generated to vary when the position of the modes under the gain curve is changed. The new method applied here is to generate three modes and look at the difference in the two beat frequencies between pairs of adjacent modes. Most Gre-Ne lasers generate three modes. The beat frequency between adjacent modes is given by the length of the resonator and is on the order of hundreds of megahertz. These frequencies are too high for convenient processing, but the difference between two beats is in the kilohertz region and easily processed.

First studies of this method were made not with a green laser but with a red one, UPT-TK450, which generates three longitudinal modes. The variation of beat frequency as the resonator length is tuned is a smooth curve expressed by a function $y=\exp[\sin(x)]$. This function has clear local extremes that can be used for frequency stabilization at a maximum or minimum point. The curve is unambiguously related to the gain curve of the active medium and it is not necessary to use any additional frequency reference for stabilization.

The resonator length is swept periodically and the sweep signal simultaneously switches the direction of counting of a reversible counter. The counter output is sent to a DAC to generate an analog control signal which is further amplified and drives a PZT, creating the basis for a servo system that keeps the laser frequency at the one of the extreme points of the laser tuning curve.

In spite of the fact that the so far only beat frequency of signals has been mentioned, in fact the reversible (up-down) counter is never reset (unlike the case where frequencies are measured). The counter indicates the total number of pulses with the direction of counting periodically changed synchronously with the direction of sweeping. By this natural, compact, and simple manner there is an ideal numerical integrator in the servo loop. There is a minimum of weak points and no information is lost.

The commercially available green laser used here did not have as smooth a tuning curve as would be ideal. A laser designed explicitly for frequency stabilization would simplify the problem.

The green laser has been applied for multicolor interferometry of gage blocks, where it substantially simplifies the determination of the order of interference and determining the real distance being measured.

Direct digital synthesis and study of error signals

Vlastimil Vondra, Miroslav Kasal, and Josef Halánek

Direct Digital Synthesis (DDS) is a method in which the generated signal parameters are affected by digital circuits and a digital-to-analogue converter and by the properties of an external system clock source. The basic principle is as follows: each digital synthesiser contains a phase increment register, phase accumulator and look-up-table. In each system clock cycle the value stored in the phase shift register is added to the value in the phase accumulator. The output value of the phase accumulator inputs into the look-up-table (conversion of phase into a value of a cosine or sine function). The output of the look-up-table is connected to a digital-to-analogue converter (DAC), which converts digital information to a value of an analogue quantity, usually electrical voltage. The main advantages of the DDS systems are a high frequency resolution, perfect quadrature of output signals, continuous phase change during step frequency change, and high frequency stability influenced only by the external system clock source. The whole DDS system is controlled by the interface of the host processor. Thanks to the mentioned properties the DDS system is ideal for the generation of the signals in nuclear magnetic resonance spectroscopy and tomography (NMR), where we

successfully apply these circuits. There are many manufacturers of the DDS systems. Their products differ in the possibilities of the phase and amplitude modulation, maximum available frequency of the system clock, and numbers of bits in the individual parts of the synthesiser.

The quality of the desired generated signal can be influenced by an arbitrary part of the whole DDS system, including the properties of DAC. Unwanted signal components (error signals) have different origins and properties in comparison with the classical analogue synthesiser. NMR is very sensitive to the properties of the used signal and therefore we had to analyse parasitic signals generated by the DDS system and to find the critical part(s). On the basis of the results we wanted to draw the conclusion regarding the proper solution of the DDS based system for the NMR applications. Our analyses were made with regard to the number of bits of the DDS system buses and registers and to the DAC properties (number of bits, static and dynamic properties). Each block was described mathematically and on the basis of this description we developed the numerical model of the whole DDS system. The properties of the numerical model of each part were

very precisely compared with the real-world measurement to obtain a good model (especially for the DAC properties). In our application where the desired maximum generation frequency is up to 10 MHz we use the DDS system Q2334 (Qualcomm) and HSP 45116 (Harris) and 12-bit DACs Q2520 (Qualcomm) – 80 Msps and AD9713B, AD9713BAN (both Analog Devices) – 100 Msps. After a great many numerical simulations under various conditions and comparisons with the measured spectral properties of the generated signal we can claim that in our applications the most critical part of the whole digital synthesiser is DAC. The dynamic properties of DAC have the major influence on the quality of the generated spectrum.

The outcomes of this research are the understanding of the influence of each part of the DDS system on the generated error signal, the design of the numerical model of the general DDS system, and the finding of the criteria for the selection of components for our synthesisers with DDS systems.

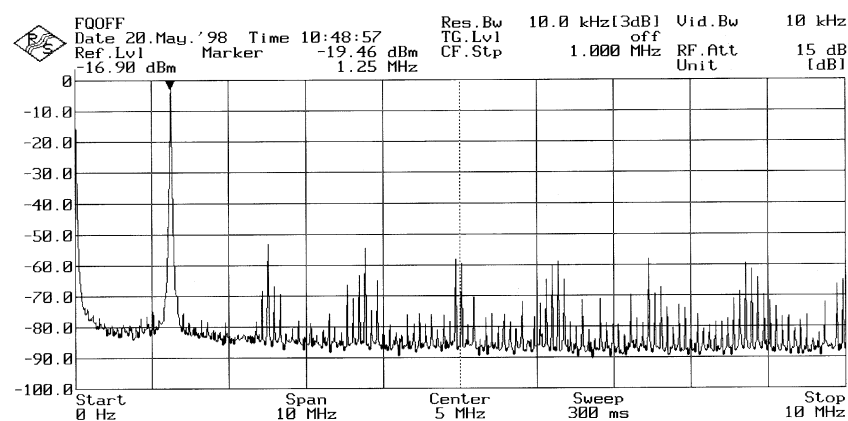

Figure 1. *The measured spectrum*

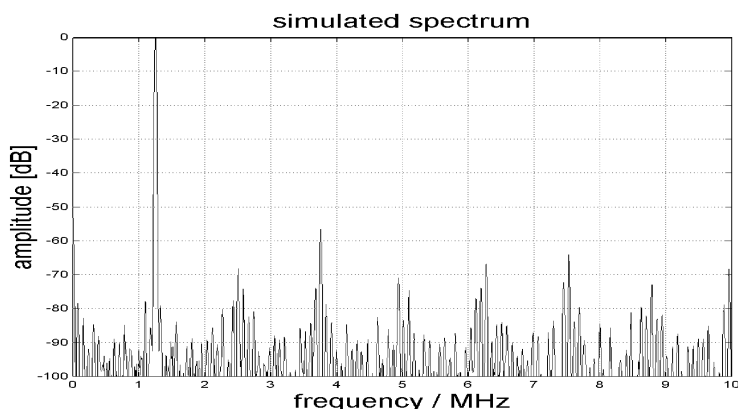

Figure 2. *The results of the numerical modelling*

The use of the standing wave for manipulation of microobjects and nanoobjects

Pavel Zemánek, Alexandr Jonáš, and Libor Šrámek

The classical (single beam) method of manipulation of microobjects and nanoobjects requires the beam to be focused down to the diameter of the size of the used wavelength. This can be achieved using a high numerical aperture microscopic objective. Small dimensions of the beam spot and its high divergence angle lead to the big spatial changes in the optical intensity. These produce the forces that act upon the irradiated objects and are proportional to the rapidity of the intensity changes. If the refractive index of the object is higher than the refractive index of the surrounding medium, these forces push the object to the position of maximal field intensity. In a classical set-up, the transversal forces acting upon the object are two orders of magnitude higher than the axial ones. Therefore, the object can easily escape along the beam axis. We have proposed and experimentally tested a method that uses the interference of two counter-propagating waves. The incident beam is one of them and the beam that is reflected from the microscope slide is the other one. The slide is coated with a dielectric reflective layer so that the reflected wave is comparable with the incident one. The interference product – standing wave – has a number of intensity maxima and minima separated by half the wavelength of

the incident light in the medium. Owing to the rapid intensity changes, the strong axial force acts on the object. Its amplitude is several orders of magnitude higher, compared to the classical method. The radial forces are slightly bigger as well.

This method does not need a tightly focused beam to create big axial intensity changes, therefore, the objectives with small numerical apertures can be used. Several equilibrium positions are created in the standing wave. If the particle is much smaller than the trapping wavelength, these positions are situated at the standing wave intensity maxima. A number of stable positions can be found even for particles that cover several antinodes but they are not exactly at the intensity maximum. Our theoretical results have been confirmed experimentally: we succeeded in the simultaneous manipulation of several objects both non-living (polystyrene spheres) and living ones (yeast cells). The manipulation was always easier using the standing wave set-up than the single beam one. We have proved (in agreement with the theory) that the influence of the standing wave is observable even if an ordinary uncoated microscope slide (its reflectivity is about 6 %) is used as the reflecting element.

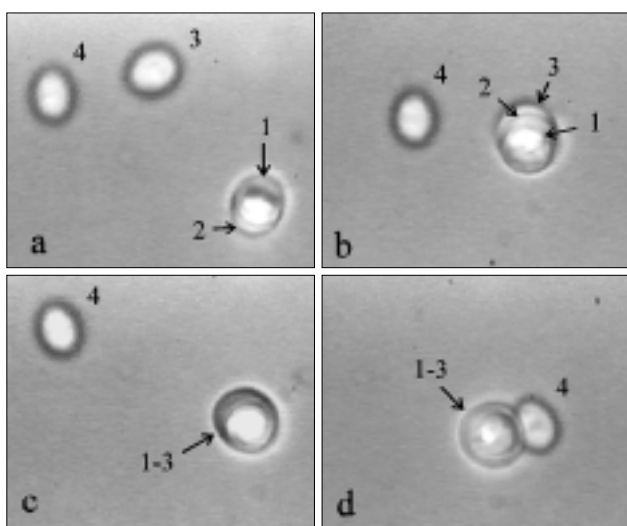
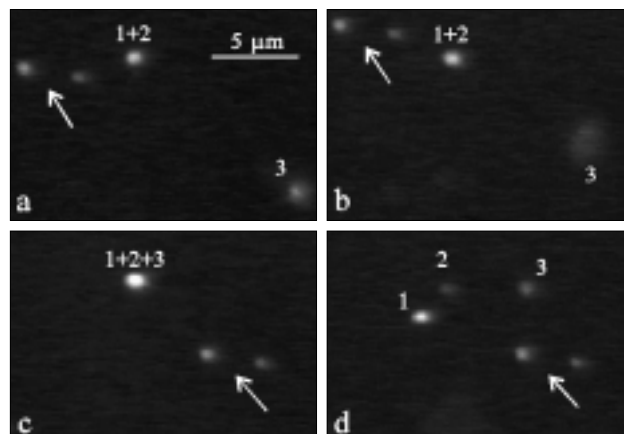

Fig.1. Simultaneous manipulation of several objects (yeast cells). The cells are trapped in a vertical line in the standing wave and can be moved horizontally. In figure a, cells labelled 1 and 2 are trapped. Cells 3 and 4 lie on the bottom of the trapping cell. In figure b, yeast cell 3 enters the trap. The movement of the three cells trapped is documented by the movement of the free cell 4 in figures b and c. In figure d, cell 4 approaches the trap.

Fig.2. 100 nm particles trapped in one SWT near the microscope slide of reflectivity of 0.4 %. Part a shows two 100 nm spheres 1 and 2 trapped approximately 1 micrometer above the bottom. The arrow indicates reference objects lying on the bottom. Particle 3 moves randomly through the medium as can be seen from its image sharpness changes (compare a and b) whereas the trapped particles and reference objects stay equally sharp. Particle 3 consequently enters the trap (see c) and moves simultaneously with the other two trapped particles as indicated by the change in the position of the reference objects. Finally, the trapping beam is switched off and the particles travel away in random directions d.



The use of lasers for non-contact interventions in the microspace

Pavel Zemánek, Alexandr Jonáš, Libor Šrámek, Jan Ježek, and Petr Jákl

In the Laboratory of Laser Nanotechnologies, we have combined a continually working laser, an ultra-violet pulsed laser, and an optical microscope to design an apparatus which enables us to manipulate microobjects, to change their shape and, at the same time, to observe them.

The continually working laser with the wavelength in the near infra-red region (1064 nm) serves as „optical tweezers“ – a device which uses light for the three-dimensional manipulation of objects of sizes from tens of nanometers to tens of micrometers. The principle of the method employs the law of action and reaction (the 3rd Newton's law) for the microobject and the photons in the laser beam as the interacting objects. The incident radiation can be represented by a flux of photons that change their directions owing to the scattering by the microobject. This „action“ leads to „reaction“ - the microobject is consequently pushed to the place of the maximal optical intensity if the refractive index of the object is greater than the refractive index of the surrounding medium. To achieve an observable effect, however, it is necessary to focus the energy contained in the laser beam into the spot of dimensions comparable with the incident light wavelength (app. micrometer). The

wavelength that is not absorbed by the object must be used to avoid a possible destruction of the object due to the high energy density. For biological specimens, the infrared region is best suited. The unique feature of this perfectly sterile tool is the possibility of manipulation inside the living cells without breaking their outer walls.

The pulsed laser emitting in the ultra-violet region (355 nm) is exploited for ablations and perforations that are again localised to the spot of the size of the incident light wavelength. The ultra-violet light is strongly absorbed by a living tissue. The absorbed energy leads to a rapid local temperature rise by thousands degrees of centigrade. The pulse duration (5 ns) is too short to damage the vicinity of the target spot by the heat flow. Because this wavelength is approximately three times smaller than the trapping light wavelength, the target spot size is adequately smaller and the „optical scalpel“ is able to operate within the region of hundreds of nanometers. This instrument can also be used for cutting inside living cells since the energy density out of the focus is sufficiently small to avoid the damage of the outer cell wall.

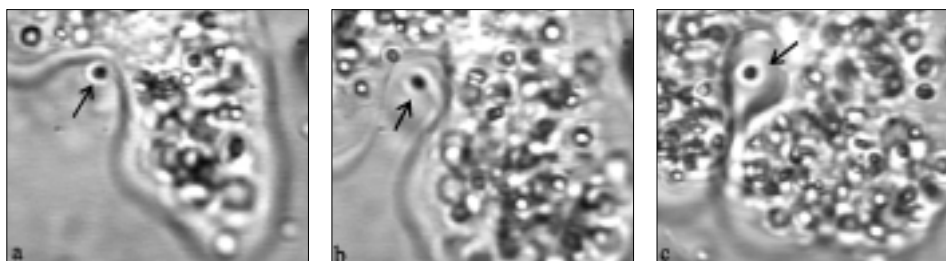

Fig.1. Phagocytosis of an optically trapped bacteria (denoted by an arrow) by a giant amoeba cell. The bacteria was brought to the contact with the amoeba outer membrane **a** leading to the protrusion of the amoeba cell into two arms around the trapped bacteria **b**. Finally, the bacteria was completely surrounded by amoeba cytoplasm **c**.



Fig.2. Spontaneous rotation of a 15 μm sphere irradiated by a continually working laser. The holes on the sphere top were made using a pulsed laser. They cause the photons to leave the sphere in an asymmetric way, which leads to the sphere rotation (note the change in the position in figures **a** and **b**). In figure **c**, another hole was made.

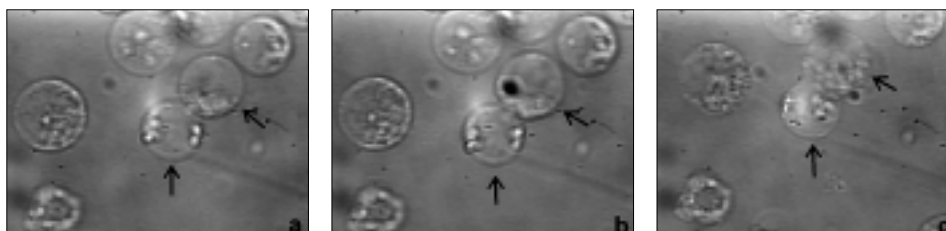

Fig.3. Cell fusion induced by the laser light. Two HL 60 cells were brought to close contact by optical tweezers **a**. Then, a few moderate-energy pulses were shot to the place of contact **b**. Finally, the outer cell membranes of both cells joined and the cell contents were mixed **c**.

Atomic trap formed by counter-propagating Gaussian beams

Pavel Zemánek

Three physicists were awarded Nobel price in 1997[1]. These scientists made the principal theoretical and experimental breakthrough in the atomic physics and they established a new branch – laser cooling and trapping of atoms. An atom irradiated by the electromagnetic wave absorbs a part of the energy from the direction of an incoming beam. During each absorption the atom is kicked in the direction of incoming wave. Absorbed energy is afterwards emitted by the spontaneous emission which does not prefer any direction. After each spontaneous emission the atom is kicked in the opposite direction than the emitted radiation. These random kicks cause a chaotic motion of the atom (diffusion) similar to the Brownian motion of microparticles. In the long-time scale the kicks from absorption and emission are averaged and the final "macroscopic" atomic motion is controlled by the incoming radiation. Acceleration or deceleration (cooling) of the atoms can be obtained in this way and the force causing this behaviour is called *radiation force*.

The incoming wave induces a dipole in the atom. The dipole oscillates in-phase with the incoming wave if its frequency is smaller than the frequency of the atomic resonant transition or in opposite-phase if the frequency is higher. The atom in the non-homogenous field is pushed to the place of higher intensity if the field frequency is smaller than the resonant atomic frequency. In the case of higher field frequency, the atom moves to the place of the lowest field intensity. The force that is responsible for this motion

is called *gradient (dipole) force*. This force is used for the confinement of the atoms into optical traps, which are formed at the intensity maximum or minimum according to the used field frequency. If the atom is trapped in the place of maximum intensity (beam focus, beam cross-section, standing wave) it is difficult to keep it there for a long time since the atom strongly interacts with the beam and the level of diffusion is higher. Therefore it is desirable to trap atoms in the place of lower intensities.

We suggested a special configuration of incoming laser beams (gaussian lateral profile) that uses counter-propagating waves of the same polarisation (they interfere) but different beam widths. With respect to the special properties of the gaussian beam the resulting space distribution of the intensity has localised minima (see figure). We studied their properties so as the lifetime of atoms in the traps was maximised. The behaviour of a two-level atom was simulated by the Monte Carlo method, the atom was considered as a classical particle following the equations of motion. The optical forces that control the atomic motion was calculated using the quantum mechanics formalism of the "dressed states". Each spontaneous emission was generated randomly in the time as well as the direction of the photon emission. We found analytical conditions describing the trap existence and the trap properties. We proved numerically that the atoms could be confined in this trap for a long time.

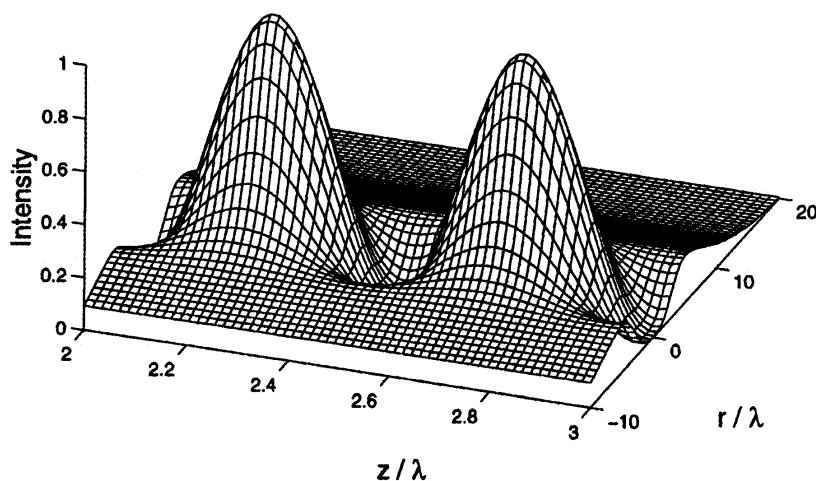

Fig.1. An example of intensity space distribution caused by the interference of counter-propagating gaussian beams with different beam widths

¹ Steven Chu (Stanford University), Claude Cohen-Tannoudji (Ecole Normale Supérieure, Paris) and William Phillips (National Institute of Standards and Technology).

V

Publications

Year of publication: 1995

ELECTRON OPTICS

Articles in Journals

- Adamec, P., Delong, A., Lencová, B.: Miniature magnetic electron lenses with permanent magnets. *Journal of Microscopy* 179 [2] 129-132 (1995).
- Autrata, R., Schauer, P.: Cathodoluminescent Properties of Single Crystal Materials for Electron Microscopy. *Scanning Microscopy* 9 [Supplement] 1-12 (1995).
- Dupák, J., Kapounek, P., Horáček, M.: Použití nové technologie svařování elektronovým svazkem v kryogenní a vakuové technice. *Jemná mechanika a optika* 40 [10-11] 342-343 (1995).
- Dupák, J., Kapounek, P., Horáček, M.: Applications of a New Electron Beam Welding Technology in Vacuum Equipment Design. *Kovine, zlitine, tehnologije* 29 [3-4] 431-432 (1995).
- Frank, L., Matějka, F.: Edge effect in Auger electron microscopy: quantification of the effect. *Journal of Microscopy* 180 [2] 158-164 (1995).
- Hawkes, P., Lencová, B., Lenc, M.: Approximate expressions for electron lens properties. *Journal of Microscopy* 179 [2] 145-157 (1995).
- Janča, J., Kryštof, P., Navrátil, K., Němec, P., Bochníček, Z., Matějková, J.: Deposition and Characterization of Organosilicon Thin Films from TEOS+O₂ Gas Mixture. *Acta Physica Universitatis Comenianae* 36 [1] 57-64 (1995).
- Lencová, B.: Computation of electrostatic lenses and multipoles by the first order finite element method. *Nuclear Instruments and Methods in Physics Research, A* 363 [1-3] 190-197 (1995).
- Lencová, B.: Unconventional lens computation. *Journal of Microscopy* 179 [2] 185-190 (1995).

Conference Contributions

- Adamec, P., Bauer, E.: New Design of Low Energy Electron Microscope. In: *Proceedings of Multinational Congress on Electron Microscopy*. - Bratislava, Slovak Academic Press 1995, p. 109-110.
- Autrata, R.: Single Crystal Detectors in SEM. In: *Proceedings of Multinational Congress on Electron Microscopy*. - Bratislava, Slovak Academic Press 1995, p. 29-36.
- Autrata, R., Jiráček, J., Špínka, J.: Detection of Signal Electrons in the ESEM. In: *Proceedings of Multinational Congress on Electron Microscopy*. - Bratislava, Slovak Academic Press 1995, p. 113-114.
- Autrata, R., Jiráček, J., Špínka, J.: Single Crystal Scintillation Detectors for Low Voltage and Low Vacuum Scanning Electron Microscopy. In: *Proceedings of Workshop '95*. - Prague, Czech Technical University 1995, p. 657-658.
- Autrata, R., Jiráček, J., Špínka, J.: Possibilities of ESEM in diagnostics of electronic components. In: *Proceedings of Electronic Devices and Systems Conference 1995*. - Brno, Technical University 1995, p. 140-141.
- Autrata, R., Jiráček, J., Špínka, J.: Nové možnosti sledování izolantů v rastrovací elektronové mikroskopii. In: *Sborník mezinárodní konference Diagnostika '95*. - Plzeň, KES/ET, FEL, ZČU 1995, p. 199-202.
- Autrata, R., Jiráček, J., Špínka, J.: Diagnostika poruch v polovodičích pomocí metody EBIC. In: *Sborník mezinárodní konference Diagnostika '95*. - Plzeň, KES/ET, FEL, ZČU 1995, p. 194-198.
- Autrata, R., Jiráček, J., Špínka, J.: Využití katodoluminiscenčního detektoru integrovaného s BSE detektorem pro diagnostiku elektrotechnických materiálů. In: *Sborník mezinárodní konference Diagnostika '95*. - Plzeň, KES/ET, FEL, ZČU 1995, p. 203-207.
- Barth, J., Steen van der, H., Chmelík, J.: Improvements to the electrostatic lens optimization method SOEM. In: *Proceedings of SPIE*. - San Diego, SPIE - International Society for Optical Engineering 1995, p. 128-137.
- Dittrichová, L., Šikola, T., Janová, D., Matějka, F.: Ion Beam Technologies. In: *Proceedings of Workshop '95*. - Praha, Czech Technical University 1995, p. 483-484.

- Fišer, J., Chmelík, J.: Objective Lens for Environmental SEM. In: Proceedings of Multinational Congress on Electron Microscopy. - Stará Lesná, Slovak Academic Press 1995, p. 107-108.
- Frank, L.: Real image resolution of SEM and Low-Energy SEM and its optimization. In: Proceedings of Multinational Congress on Electron Microscopy. - Bratislava, Slovak Academic Press 1995, p. 105-106.
- Frank, L., Müllerová, I.: Characterization and diagnostic of materials by using slow electron microscopy. In: Workshop - Physics, chemistry and applications of molecular systems. - Brno, Masaryk University 1995, p. 71-76.
- Lenc, M.: Immersion objective lenses for very low energy electron microscopy. In: Proceedings of Multinational Congress on Electron Microscopy. - Bratislava, Slovak Academic Press 1995, p. 103-104.
- Lencová, B.: Accuracy of Magnetic Lens Computation with the First Order Finite Element Method. In: Abstracts of the 3rd Japanese-Czech-Slovak Joint Seminar on Applied Electromagnetics. - Prague, Czech Technical University 1995, p. 41-44.
- Lencová, B.: CAD in electron optics. In: Proceedings of Multinational Congress on Electron Microscopy. - Bratislava, Slovak Academic Press 1995, p. 19-23.
- Madea, D., Autrata, R.: Influence of the Conductive Coating of the Scintillator on the BSE Detector Efficiency. In: Proceedings of Multinational Congress on Electron Microscopy. - Bratislava, Slovak Academic Press 1995, p. 111-112.
- Madea, D., Autrata, R.: Detectors for the study of contrast mechanisms of backscattered electrons in scanning electron microscopy. In: Proceedings of Electronic Devices and Systems Conference 1995. - Brno, Technical University 1995, p. 135-136.
- Müllerová, I.: Low Energy Electron Microscopy. In: Proceedings of Multinational Congress on Electron Microscopy. - Bratislava, Slovak Academic Press 1995, p. 24-28.
- Obukhov, V., Raiko, V., Dupák, J., Finger, M., Latuszynski, A.: Ion Source of Difficulty-Ionized Refractory Elements. In: Proceedings of International Workshop on Physics with Polarized Beams and Targets. - Prague, Charles University 1995, p. -.
- Pejchl, D., Müllerová, I.: Signal detection in LVSEM. In: Proceedings of Multinational Congress on Electron Microscopy. - Bratislava, Slovak Academic Press 1995, p. 117-118.
- Pištora, J., Postava, K., Ciprian, D., Kantor, R., Sobota, J.: Guided Modes in Three-Layered Sandwich Structures. In: European Optical Society. Annual Meetings Digest Series. Photonics '95. Vol. 2A. - Praha, Czech and Slovak Society for Photonics 1995, p. 143-146.
- Schauer, P., Autrata, R.: Spatial Resolution of YAG:Ce Single Crystal CL Screens. In: Proceedings of Multinational Congress on Electron Microscopy. - Bratislava, Slovak Academic Press 1995, p. 115-116.
- Zdražil, M., Frank, L.: Critical electron energies for non-charging microscopy and their measurement. In: Proceedings of Multinational Congress on Electron Microscopy. - Bratislava, Slovak Academic Press 1995, p. 119-120.

Conference Abstracts

- Dupák, J., Kapounek, P., Horáček, M.: Application of a New Welding Technology in Vacuum Equipment Design. In: Book of Abstracts of Slovenian-Hungarian-Croatian-Austrian Sixth Joint Vacuum Conference. - Bled, Slovenian Vacuum Society 1995, p. 84.
- Frank, L., Matějka, F.: Correction of the Edge Effect in Surface Analytical SEM. In: Book of Abstracts of EMAS 95. - St. Malo, EMAS 1995, p. 343.
- Frank, L., Zdražil, M., Müllerová, I.: Low Energy Imaging of Nonconductive Surfaces in SEM. In: Book of Abstracts of EMAS 95. - St. Malo, EMAS 1995, p. 344.
- Gurevich, G., Topalov, S., Delyagin, N., Erzinkyan, A., Parfenova, V., Reyman, S., Finger, M., Pavlov, V., Slunecka, M., Dupák, J.: Magnetic Atom Behaviour in the Alloys with Competing Interactions FeNiMn. In: Book of Abstracts of the 10th International Conference on Hyperfine Interactions. - Leuven 1995, p. P111.
- Sobota, J.: Friction Characteristic of R.F. Magnetron Sputtered C and C:N Thin Films. In: Book of Abstracts of Slovenian-Hungarian-Croatian-Austrian Sixth Joint Vacuum Conference. - Bled, Slovenian Vacuum Society 1995, p. 131.

NUCLEAR MAGNETIC RESONANCE

Books & Non-conference Proceedings

- Čermáková, E., Chramosta, O., Navarová, H., Pazdera, L.: Study of Magnetic Fields in Buildings with Iron Reinforcements and Pipe Installation. In: Sborník vědeckých a odborných prací Stavební fakulty VUT v Brně 1995/1. - Brno 1995, p. 69-76.

Articles in Journals

- Bartušek, K., Dokoupil, Z.: DSP96002 Based Software Pulse Generator for NMR Tomography and Spectroscopy. *Journal of Electrical Engineering* 46 [1] 36-38 (1995).
- di Barba, P., Gottvald, A., Savini, A.: Global optimization of Loney's solenoid: a benchmark problem. *International Journal of Applied Electromagnetics and Mechanics* 4 [4] 273-276 (1995).
- Halámek, J., Villa, M., Kasal, M., Cofrancesco, P.: Solvent Suppression by Post-Processing. *Applied Magnetic Resonance* 9 [-] 73-79 (1995).
- Hanzelka, P.: Vakuüm v kryostatech pro NMR. *Jemná mechanika a optika* 40 [7] 223-225 (1995).
- Hanzelka, P., Musilová, V.: Influence of changes in atmospheric pressure on evaporation rates of low-loss helium cryostats. *Cryogenics* 35 [3] 215-218 (1995).
- Konzbul, P., Švéda, K.: Shim coils for NMR and MRI solenoid magnets. *Measurement Science and Technology* 6 [8] 1116-1123 (1995).

Conference Contributions

- Bartušek, K., Jílek, B.: Automatic Adjustment of Precise Compensation of Eddy Currents for Localized NMR Spectroscopy. In: *Proceedings of the 7th International IMEKO TC-13 Conference on Measurement in Clinical Medicine.* (Ed.: Kneppo, P., Tyšler, M.) - Stará Lesná, Slovenská akadémia vied 1995, p. 207.
- Gottvald, A.: Inverse and Optimization Methodologies in Magnetic Resonance: Applications to Bloch and Maxwell's Systems. In: *Second International Conference on Advanced Methods in the Theory of Electrical Engineering.* - Plzeň, University of West Bohemia 1995, p. 71-74.
- Gottvald, A.: Inverse and Optimization Methodologies in Magnetic Resonance: Applications to In Vivo Spectra Quantifications. In: *Second International Conference on Advanced Methods in the Theory of Electrical Engineering.* - Plzeň, University of West Bohemia 1995, p. 75-78.
- Gottvald, A.: Meta-Evolutionary Optimization. In: *The 1st International Conference on Genetic Algorithms.* - Brno, Technical University 1995, p. 47-52.
- Gottvald, A.: Inverse and Optimization Methodologies in Magnetic Resonance Part 1: Evolution Strategies. In: *Abstracts of the 3rd Japanese-Czech-Slovak Joint Seminar on Applied Electromagnetics.* - Prague, Czech Technical University 1995, p. 5-8.
- Gottvald, A.: Inverse and Optimization Methodologies in Magnetic Resonance Part 2: Meta-Optimization. In: *Abstracts of the 3rd Japanese-Czech-Slovak Joint Seminar on Applied Electromagnetics.* - Prague, Czech Technical University 1995, p. 9-12.
- Gottvald, A.: Inverse and Optimization Methodologies in Magnetic Resonance Part 3: Applications to Bloch and Maxwell Systems. In: *Abstracts of the 3rd Japanese-Czech-Slovak Joint Seminar on Applied Electromagnetics.* - Prague, Czech Technical University 1995, p. 13-16.
- Gottvald, A.: Inverse and Optimization Methodologies in Magnetic Resonance Part 4: Applications to In Vivo Spectra Quantifications. In: *Abstracts of the 3rd Japanese-Czech-Slovak Joint Seminar on Applied Electromagnetics.* - Prague, Czech Technical University 1995, p. 17-20.
- Konzbul, P., Švéda, K.: Measurement and Analysis of the Magnetic Fields of Shim System for MRI Magnet. In: *Abstracts of the 3rd Japanese-Czech-Slovak Joint Seminar on Applied Electromagnetics.* - Prague, Czech Technical University 1995, p. 133-136.
- Krejčí, I., Vondra, V., Húsek, V.: Information Interchange in a DSP Based Multiprocessor System. In: *Telekomunikácie '95 - 1. mezinárodná konferencia o telekomunikačných technológiach.* Vol. 2. Vedecká sekcia. - Bratislava, COFAX 1995, p. 165-166.
- Krejčí, I., Vondra, V., Studnička, P.: DSPs in Measurement and Automatic Control Systems. In: *Telekomunikácie '95 - 1. mezinárodná konferencia o telekomunikačných technológiach.* Vol. 2. Vedecká sekcia. - Bratislava, COFAX 1995, p. 167-168.
- Musilová, V., Srnka, A.: Contribution of Superconductor Magnetization to the Field of NMR Magnets. In: *Abstracts of the 3rd Japanese-Czech-Slovak Joint Seminar on Applied Electromagnetics.* - Prague, Czech Technical University 1995, p. 100-104.
- Srnka, A., Jelínek, J., Musilová, V., Hanzelka, P.: Testování supravodivého magnetu pro 400MHz NMR spektrometr. In: *Slovensko-český seminář o supravodivosti.* - Bratislava, Elektrotechnický ústav SAV 1995, p. 37-38.
- Starčuk, Z., Bartušek, K., Starčuk jr., Z., Tkáč, I., Mlynárik, V.: Improvements in Localized Proton NMR Spectroscopy: SPRES - New Spin Echo Single Voxel Localization Sequences. In: *Proceedings of the 3rd Scientific Meeting and Exhibition of the Society of Magnetic Resonance and the 12th Annual Meeting and Exhibition of the European Society for Magnetic Resonance in Medicine and Biology.* - Nice, Society of Magnetic Resonance 1995, p. 1923.
- Starčuk, Z., Starčuk jr., Z., Tkáč, I., Mlynárik, V.: Highly Effective Spectrally and Spatially Tailored Saturation of Unwanted Magnetization for Localized In Vivo ¹H NMR

Spectroscopy. In: Proceedings of the 3rd Scientific Meeting and Exhibition of the Society of Magnetic Resonance and the 12th Annual Meeting and Exhibition of the European Society for Magnetic Resonance in Medicine and Biology. - Nice, Society of Magnetic Resonance 1995, p. 1966.

- Starčuk, Z., Tkáč, I.: Spatial Localization and Efficient Suppression of Water and Fat Signals - Two Basic

Conference Abstracts

- Bartušek, K., Jílek, B.: Automatic compensation of eddy currents for localized NMR spectroscopy and NMR microscopy. In: Book of Abstracts of the 3rd International Conference on Magnetic Resonance Microscopy - Heidelberg Conference. - Würzburg, Division of Spatially Resolved Magnetic Resonance of the Groupement Ampere 1995, p. 57.
- Konzbul, P., Švéda, K.: Superconducting shim system for NMR solenoid Magnet MIDI 200. In: Abstracts of the 14th International Conference on Magnet Technology. - Tampere, TUT 1995, p. 48.
- Starčuk, Z., Tkáč, I., Mlynárik, V., Bartušek, K., Horký, J., Starčuk jr., Z.: New Sequences for the Single-Voxel Localization in In Vivo Proton NMR Spectroscopy.

Problems of In Vivo Proton MR Spectroscopy. In: Proceedings of the 7th International IMEKO TC-13 Conference on Measurement in Clinical Medicine. (Ed.: Kneppo, P., Tyšler, M.) - Stará Lesná, Slovenská akadémia vied 1995, p. 204.

In: Book of Abstracts of the 10th Spectroscopic Conference with International Participation. - Lanškroun, Spektroskopická spoločnosť Jana Marci 1995, p. M2-0-11.

- Starčuk, Z., Tkáč, I., Mlynárik, V., Starčuk jr., Z., Havlišová, H.: A New Procedure to the Spectrally and Spatially Tailored Saturation of Water and Fat Signals in In Vivo Proton NMR Spectroscopy. In: Book of Abstracts of the 10th Spectroscopic Conference with International Participation. - Lanškroun, Spektroskopická spoločnosť Jana Marci 1995, p. M2-0-10.

COHERENT OPTICS

Articles in Journals

- Lazar, J., Schellekens, P.: Properties and stabilization of a short-resonator 543 nm HeNe laser. Optics Communications 119 [Aug15] 117-124 (1995).
- Stejskal, A., Stone, J.: Frequency stabilization of a green He-Ne laser. Applied Optics 34 [24] 5278-5281 (1995).
- Zemánek, P.: Optimalizace disperzního signálu frekvenčně modulované saturační spektroskopie. Jemná mechanika a optika 40 [3] 71-75 (1995).

Year of publication: 1996

ELECTRON OPTICS

Books & Non-conference Proceedings

- Delong, A.: Emisní elektronová mikroskopie. In: Metody analýzy povrchů - Elektronová mikroskopie a difrakce. (Ed.: Eckertová, L., Frank, L.) - Praha, Academia 1996, p. 159-184.
- Frank, L.: Klasické metody analytické elektronové mikroskopie: zobrazování Augerovými elektrony a charakteristickým rtg zářením. In: Metody analýzy povrchů - Elektronová mikroskopie a difrakce. (Ed.: Eckertová, L., Frank, L.) - Praha, Academia 1996, p. 93-157.
- Lenc, M., Lencová, B.: Optické prvky elektronových mikroskopů. In: Metody analýzy povrchů - Elektronová mikroskopie a difrakce. (Ed.: Eckertová, L., Frank, L.) - Praha, Academia 1996, p. 15-63.

Articles in Journals

- Autrata, R.: Single Crystal Detectors in Scanning Electron Microscopy. *European Microscopy and Analysis* [41] 9-11 (1996).
- Autrata, R., Jiráček, J., Špinka, J.: Rastrovací elektronová mikroskopie vlhkých vzorků a izolantů. *Jemná mechanika a optika* 41 [4] 98-100 (1996).
- Bedrníkov, A., Chmelík, J.: New algorithms for testing accuracy of numerically calculated trajectories of charged particles. *Optik* 102 [1] 13-17 (1996).
- Frank, L.: Real image resolution of SEM and low-energy SEM and its optimization: distribution width of the total surface emission. *Ultramicroscopy* 62 [4] 261-269 (1996).
- Frank, L., Matějka, F.: Correction of the Edge Effect in Auger Electron Microscopy. *Mikrochimica Acta* 13 [Suppl.] 279-287 (1996).
- Frank, L., Zadražil, M., Müllerová, I.: Low Energy Imaging of Nonconductive Surfaces in SEM. *Mikrochimica Acta* 13 [Suppl.] 289-298 (1996).
- Klíčnický, M., Dupák, J., Ustohal, V.: Kontaktní eutektické tavení. *Zeszyty naukowe Wyższej szkoły inżynierskiej w Opolu, Mechanika* 217 [52] 145- (1996). In: *Metody oceny struktury oraz i własności materiałow i wyrobów*.
- Lencová, B.: Comment on "Optimization of electrostatic deflectors" [*J. Vac. Sci. Technol. B* 13, 142 (1995)]. *Journal of Vacuum Science & Technology, B* 14 [3] 1860-1863 (1996).
- Pištora, J., Ciprian, D., Kantor, R., Postava, K., Sobota, J.: Dark mode spectroscopy of magnetic thin films. *Journal of Magnetism and Magnetic Materials* 157/158 [May] 283-284 (1996).
- Rotter, M., Dupák, J., Forget, P., Hubálovský, Š., Janotová, J., Pari, P., Srnka, A., Trhlík, M.: The New Nuclear Orientation Facility at Charles University Prague. *Czechoslovak Journal of Physics* 46 [Supp. S5] 2795-2796 (1996). In: *Proceedings of the 21st International Conference on Low Temperature Physics. Vol. S5. Low temperature properties of solids 2 - Techniques and applications*.
- Rotter, M., Hubálovský, Š., Trhlík, M., Delyagin, N., Erzinkyan, A., Dupák, J., Gurevich, G., Parfenova, V., Pari, P.: Low temperature nuclear orientation of ⁵⁴Mn in FeNiMn. *Czechoslovak Journal of Physics* 46 [Supp. S4] 2205-2206 (1996). In: *Proceedings of the 21st International Conference on Low Temperature Physics. Vol. S4. Low temperature properties of solids 1*.
- Tikhonravov, A., Trubetskov, M., Hrdina, J., Sobota, J.: Characterization of quasi-rugate filters using ellipsometric measurements. *Thin Solid Films* 277 [1-2] 83-89 (1996).
- Vlček, I.: Návrh a řešení Wienova filtru do VLESEM. *Jemná mechanika a optika* 41 [3] 78-79 (1996).
- Vorlíček, V., Široký, P., Sobota, J., Peřina, V., Železný, V., Hrdina, J.: C:N and C:N:O films: preparation and properties. *Diamond and Related Materials* 5 [3-5] 570-574 (1996).

Conference Contributions

- Autrata, R., Jiráček, J., Klvač, M., Špinka, J.: Detector of backscattered electrons for environmental SEM. In: *CD-ROM Proceedings of the 11th European Congress on Electron Microscopy. - Dublin, University College 1996, p. -*.
- Autrata, R., Jiráček, J., Špinka, J.: Charging Effect Problems in ESEM Conditions. In: *Recent Trends in Charged Particle Optics and Surface Physics Instrumentation - 5th Seminar. (Ed.: Müllerová, I., Frank, L.) - Brno, Czechoslovak Society for Electron Microscopy 1996, p. 65-66*.
- Autrata, R., Jiráček, J., Špinka, J.: Use of ESEM in Diagnostics of Electrotechnical Materials and Technologies. In: *Zborník príspevkov z konferencie ELMAT '96. - Košice, Technická univerzita, FEI 1996, p. 39-40*.
- Autrata, R., Jiráček, J., Špinka, J.: Environmental High Resolution Scanning Electron Microscopy. In: *Workshop '96. Vol. 3. - Brno, Technical University 1996, p. 837-838*.
- Autrata, R., Schauer, P., Jiráček, J., Špinka, J.: Signal Detection in SEM. In: *Recent Trends in Charged Particle Optics and Surface Physics Instrumentation - 5th Seminar. (Ed.: Müllerová, I., Frank, L.) - Brno, Czechoslovak Society for Electron Microscopy 1996, p. 43-46*.
- Autrata, R., Schauer, P., Madea, D.: Single crystal scintillators for BSE detectors in SEM. In: *CD-ROM Proceedings of the 11th European Congress on Electron Microscopy. - Dublin, University College 1996, p. -*.
- Dupák, J.: Svařování svazkem elektronů a pájení ve vakuu. In: *Škola vakuové techniky 1996. (Ed.: Češpíro, Z.) - Praha, Česká vakuová společnost 1996, p. 35-36*.
- Dupák, J., Klíčnický, M., Ustohal, V.: Ductile Active Solders. In: *Kryogenika '96 - Cryogenics '96. Proceedings of the 4th International Conference. - Praha, Czech Society for Mechanical Engineering - National Section for Cryogenics 1996, p. 51-52*.
- Dupák, J., Škoda, P., Ustohal, V.: Electron Beam Welded Joints of Stainless Steel with Different Metals. In: *Proceedings of the 2nd European Congress Stainless Steels '96. - Düsseldorf, Verein Deutscher Eisenhüttenleute 1996, p. 361-362*.
- Frank, L.: Width of the SEM and LESEM response function as a tool for the image resolution assessment.

- In: Proceedings of the IX Conference on Electron Microscopy of Solids - EM '96. (Ed.: Czyska-Filemonowicz, A.) - Kraków, State Committee for Scientific Research 1996, p. 109-112.
- Frank, L., Müllerová, I.: Diffraction contrast in cathode lens equipped Low-Energy SEM. In: CD-ROM Proceedings of the 11th European Congress on Electron Microscopy. - Dublin, University College 1996, p. -.
 - Hibino, M., Ban, K., Tanaka, S., Schauer, P., Atrata, R.: High Resolution and High Collection Efficiency YAG Screen for Lens Coupling TV and CCD Camera. In: Proceedings. Sixth Asia-Pacific Conference on Electron Microscopy. (Ed.: Barber, D., Chan, P. Y., Chew, E. C.) - Hong Kong, Chinetek Promotion 1996, p. 45-46.
 - Hrdina, J., Sobota, J., Peřina, V.: Ellipsometric analysis of quasi-rugate films: regularization technique revisited. In: Proceedings of the Developments in Optical Component Coatings (Proc. SPIE 2776). (Ed.: Reid, I.) - Washington, SPIE-The International Society for Optical Engineering 1996, p. 236-243.
 - Hrdina, J., Jastrabík, L., Fendrych, F., Sobota, J.: RF magnetron sputtering of CN_x thin films. In: Modern Plasma Surface Technology. (Ed.: Precht, W.) - Koszalin, Technical University of Koszalin 1996, p. 113-121.
 - Klíčník, M., Dupák, J., Ustohal, V.: Brittle Behaviour of Electron Beam Welded Aluminium. In: Welding Science & Technology - Japan-Slovak Welding Symposium. Proceedings of the International Conference. (Ed.: Hrivňák, I.) - Košice, Technical University - Department of Material Science 1996, p. 147-149.
 - Klvač, M., Romanovský, V.: Integrated Scintillation and Ionization Detector for ESEM. In: Recent Trends in Charged Particle Optics and Surface Physics Instrumentation - 5th Seminar. (Ed.: Müllerová, I., Frank, L.) - Brno, Czechoslovak Society for Electron Microscopy 1996, p. 67-68.
 - Lencová, B.: Notes on Finite Element Method for Electron Optics. In: Recent Trends in Charged Particle Optics and Surface Physics Instrumentation - 5th Seminar. (Ed.: Müllerová, I., Frank, L.) - Brno, Czechoslovak Society for Electron Microscopy 1996, p. 13-16.
 - Lencová, B.: Accuracy of Magnetic Lens Computation with the First Order Finite Element Method. In: Interdisciplinary Applied Electromagnetics. (Ed.: Gottvald, A., Zemánek, I.) - Praha, Czech Society of Applied Electromagnetics 1996, p. 40-46.
 - Lencová, B., Lenc, M.: The use of the first order FEM for the computation of magnetic electron lenses. In: Proceedings of the Charged Particle Optics II (Proc. SPIE 2858). (Ed.: Munro, E.) - Washington, SPIE-The International Society for Optical Engineering 1996, p. 34-45.
 - Lencová, B., Lenc, M.: Accurate computation of higher multipole components of electrostatic and magnetic deflectors with the first order FEM. In: Proceedings of the Charged-Particle Optics II (Proc. SPIE 2858). (Ed.: Munro, E.) - Washington, SPIE - International Society for Optical Engineering 1996, p. 58-67.
 - Lencová, B., Mulvey, T., Tsuno, K.: Computer-aided design of a high resolution magnetic electron lens by first and second order finite element methods. In: CD-ROM Proceedings of the 11th European Congress on Electron Microscopy. - Dublin, University College 1996, p. -.
 - Lencová, B., Zlámal, J.: Selected Recent Results of Electron Optical Computations. In: Recent Trends in Charged Particle Optics and Surface Physics Instrumentation - 5th Seminar. (Ed.: Müllerová, I., Frank, L.) - Brno, Czechoslovak Society for Electron Microscopy 1996, p. 55-56.
 - Madea, D.: Low-Energy Electron Single Crystal Detector Efficiency. In: Recent Trends in Charged Particle Optics and Surface Physics Instrumentation - 5th Seminar. (Ed.: Müllerová, I., Frank, L.) - Brno, Czechoslovak Society for Electron Microscopy 1996, p. 69-70.
 - Müllerová, I.: Contrast Mechanisms in Low Voltage SEM. In: Proceedings of the IX Conference on Electron Microscopy of Solids - EM '96. (Ed.: Czyska-Filemonowicz, A.) - Kraków, State Committee for Scientific Research 1996, p. 93-96.
 - Müllerová, I., Frank, L.: Contrast Mechanisms at Low Energies in SEM. In: Recent Trends in Charged Particle Optics and Surface Physics Instrumentation - 5th Seminar. (Ed.: Müllerová, I., Frank, L.) - Brno, Czechoslovak Society for Electron Microscopy 1996, p. 79-82.
 - Müllerová, I., Frank, L.: The forming of contrast at low energies in SEM. In: CD-ROM Proceedings of the 11th European Congress on Electron Microscopy. - Dublin, University College 1996, p. -.
 - Myšková, M., Matějka, F.: Binary diffraction structures fabricated on a silicon nitride membrane. In: Proceedings of Electronic Devices and Systems Conference 1996. (Ed.: Bukovjan, P., Boušek, J.) - Brno, Technical University 1996, p. 141-144.
 - Pejchl, D., Müllerová, I.: Imaging with Slow Electrons in SEM. In: Recent Trends in Charged Particle Optics and Surface Physics Instrumentation - 5th Seminar. (Ed.: Müllerová, I., Frank, L.) - Brno, Czechoslovak Society for Electron Microscopy 1996, p. 83-84.
 - Pejchl, D., Müllerová, I.: Imaging in Low-Energy SEM equipped with separator of primary and signal electrons. In: CD-ROM Proceedings of the 11th European Congress on Electron Microscopy. - Dublin, University College 1996, p. -.
 - Pejchl, D., Müllerová, I.: Imaging with slow electrons in SEM. In: Proceedings EMAS '96 - 2nd Regional Workshop on Electron Probe Microanalysis of Materials Today - Practical Aspects. (Ed.: Lábár, J. L., Heikinheimo, E., Nicholson, P.) - Balatonfüred,

- Kossuth Lajos University Debrecen, Department of Solid State Physics 1996, p. 48-49.
- Schauer, P., Aufrata, R.: Some Methods for Investigation of Detector Components for Electron Microscopy. In: Recent Trends in Charged Particle Optics and Surface Physics Instrumentation - 5th Seminar. (Ed.: Müllerová, I., Frank, L.) - Brno, Czechoslovak Society for Electron Microscopy 1996, p. 47-50.
 - Schauer, P., Aufrata, R.: Computer Designed Scintillation Detectors for SEM. In: Recent Trends in Charged Particle Optics and Surface Physics Instrumentation - 5th Seminar. (Ed.: Müllerová, I., Frank, L.) - Brno, Czechoslovak Society for Electron Microscopy 1996, p. 73-74.
 - Schauer, P., Aufrata, R.: Computer optimized design of BSE scintillation detector for SEM. In: CD-ROM Proceedings of the 11th European Congress on Electron Microscopy. - Dublin, University College 1996, p. -.
 - Šikola, T., Lopour, F., Spousta, J., Dub, P., Zlámal, J., Průša, S., Klimeš, Z., Kalousek, R., Nebojsa, A., Lencová, B.: Design of UHV Apparatus for Low Energy Ion Beam Thin Film Deposition and In-Situ Surface and Thin Film Analysis. In: Proceedings of the 6th European Conference on Applications of Surface and Interface Analysis. (Ed.: Mathieu, H. J., Reihl, B., Briggs, D.) - Chichester, John Wiley & Sons 1996, p. TD8.
 - Škoda, P., Dupák, J., Michalička, P.: Creation of Heterogeneous Weld Joints of Titanium- and Aluminium-Based Materials by Electron Beam Welding. In: Welding Science & Technology - Japan-Slovak Welding Symposium. Proceedings of the International Conference. (Ed.: Hrivňák, I.) - Košice, Technical University - Department of Material Science 1996, p. 157-160.
 - Zdražil, M., Frank, L.: Noncharging SEM for biomedical and material research. In: CD-ROM Proceedings of the 11th European Congress on Electron Microscopy. - Dublin, University College 1996, p. -.
 - Zdražil, M., Frank, L., Kofroňová, O., Benada, O.: Imaging of Non-Conducting Specimens by Non-Charging Scanning Electron Microscopy Method. In: Recent Trends in Charged Particle Optics and Surface Physics Instrumentation - 5th Seminar. (Ed.: Müllerová, I., Frank, L.) - Brno, Czechoslovak Society for Electron Microscopy 1996, p. 75-77.
 - Zdražil, M., Frank, L., Kofroňová, O., Benada, O.: Imaging of non-conducting specimens by non-charging scanning electron microscopy method. In: Proceedings EMAS '96 - 2nd Regional Workshop on Electron Probe Microanalysis of Materials Today - Practical Aspects. (Ed.: Lábár, J. L., Heikinheimo, E., Nicholson, P.) - Balatonfüred, Kossuth Lajos University Debrecen, Department of Solid State Physics 1996, p. 75-76.

Conference Abstracts

- Klíčnický, M., Dupák, J., Ustohal, V., Audyová, J.: Joining by Active Solders. In: Abstracts of the European Conference Junior Euromat '96. - Lausanne, Deutsche Gesellschaft für Materialkunde 1996, p. 379.

NUCLEAR MAGNETIC RESONANCE

Books & Non-conference Proceedings

- Horký, J., Vodáková, M.: Spektrometr NMR BS 687. Brno, Delong Instruments Industrial 1996.

Articles in Journals

- Jurášková, V., Vetterl, V., Chramosta, O.: Effect of cadmium and 50 Hz electric and magnetic fields on bone marrow and tumour cells. *Bioelectrochemistry and Bioenergetics* 39 119-123 (1996).
- Konzbul, P., Švéda, K., Srnka, A.: Superconducting Shim System with High Purity Magnetic Field for NMR and MRI Solenoid Magnet MIDI-200. *IEEE Transactions on Magnetics* 32 [4] 2643-2646 (1996).
- Villa, M., Tian, F., Cofrancesco, P., Halánek, J., Kasal, M.: High-resolution digital quadrature detection. *Review of Scientific Instruments* 67 [6] 2123-2129 (1996).
- Vondra, V., Boogaart van den, A., Graveron-Demilly, D., Ormond van, D.: Automatic Estimation of the Time Origin and Overall Phase of an FID Signal. *Journal of Magnetic Resonance, A* 119 [2] 271-274 (1996).

Conference Contributions

- Bartušek, K.: The application of the DSP96002 to the optimization of preemphasis parameters for NMR microscopy. In: Proceedings of the IASTED International Conference Signal and Image Processing and Applications - SIPA '96. (Ed.: Namazi, N. M., Matthews, K.) - Anaheim, International Association of Science and Technology for Development 1996, p. 27-29.
- Bartušek, K.: Analysis of NMR Signal Distorted by Gradient Magnetic Field. In: Proceedings of the 29th NMR conference. - Krakow, Instytut Fizyki Jadrowej 1996, p. 117-120.
 - Bartušek, K., Dokoupil, Z.: DSP Hardware System for Analysis of NMR Signals Distorted by Gradient Pulses. In: Proceedings of the International Conference on Communications, Signals and Systems. (Ed.: Bukovjan, P., Škoda, P.) Vol. 2. - Brno, TU - Faculty of Electrical Engineering and Computer Science 1996, p. 443-446.
 - Gottvald, A.: MRS beyond Inhomogeneity and Noise Limits. In: Analysis of Biomedical Signals and Images. Proceedings of the 13-th Biennial International Conference Biosignal '96. (Ed.: Jan, J., Kilián, P., Provazník, I.) - Brno, Technical University 1996, p. 83-85.
 - Gottvald, A.: Meta-Evolutionary Optimization: Applications to Magnetic Resonance in Extreme Conditions. In: Mendel '96 - 2nd International Conference on Genetic Algorithms. - Brno, Technical University, Faculty of Mechanical Engineering 1996, p. 47-51.
 - Gottvald, A.: On Evolutionary Quantification of Strongly Distorted MR-Signals. In: Workshop on MR Signal Processing. - Urbana-Champaign, University of Illinois, Beckman Institute for Advanced Science and Technology 1996, p. 51-53.
 - Gottvald, A.: Inverse and Optimization Methodologies in Magnetic Resonance Part 1: Evolution Strategies. In: Interdisciplinary Applied Electromagnetics. (Ed.: Gottvald, A., Zemánek, I.) - Brno, Czech Society of Applied Electromagnetics 1996, p. 2-5.
 - Gottvald, A.: Inverse and Optimization Methodologies in Magnetic Resonance Part 2: Meta - Optimization. In: Interdisciplinary Applied Electromagnetics. (Ed.: Gottvald, A., Zemánek, I.) - Brno, Czech Society of Applied Electromagnetics 1996, p. 6-9.
 - Gottvald, A.: Inverse and Optimization Methodologies in Magnetic Resonance Part 3: Applications to Bloch and Maxwell Systems. In: Interdisciplinary Applied Electromagnetics. (Ed.: Gottvald, A., Zemánek, I.) - Brno, Czech Society of Applied Electromagnetics 1996, p. 10-13.
 - Gottvald, A.: Inverse and Optimization Methodologies in Magnetic Resonance Part 4: Applications to In Vivo Spectra Quantifications. In: Interdisciplinary Applied Electromagnetics. (Ed.: Gottvald, A., Zemánek, I.) - Brno, Czech Society of Applied Electromagnetics 1996, p. 14-17.
 - Gottvald, A., Zemánek, I.: Interdisciplinary Applied Electromagnetics. Brno, Czech Society of Applied Electromagnetics 1996.
 - Haláček, J., Jurák, P., Kasal, M.: Analog/Digital Converter - Bits and Dynamic Range. In: Proceedings of Electronic Devices and Systems Conference 1996. (Ed.: Bukovjan, P., Boušek, J.) - Brno, Technical University 1996, p. 1-4.
 - Haláček, J., Kasal, M.: Sampling and Aliasing of Complex Data. In: Conference Proceedings of the 6th National Scientific Conference with International Participation Radioelektronika '96. (Ed.: Svačina, J.) Vol. 1. - Brno, Technical University 1996, p. 200-203.
 - Haláček, J., Kasal, M., Húsek, V.: Programmable Digital Receiver. In: Nové smery v spracovaní signálov III. Vol. 2. - Liptovský Mikuláš, Vojenská akadémia Slovenského národného povstania 1996, p. 38-41.
 - Hanzelka, P., Jelínek, J., Musilová, V.: Application of Thermocouples in Cryogenic Devices. In: Kryogenika '96 - Cryogenics '96. Proceedings of the 4th International Conference. - Praha, Czech Society for Mechanical Engineering - National Section for Cryogenics 1996, p. 120-123.
 - Jelínek, J.: Kryovývěvy. In: Škola vakuové techniky 1996. (Ed.: Češpíro, Z.) - Praha, Česká vakuová společnost 1996, p. 13-15.
 - Jurák, P., Haláček, J.: Aplikace systému ScopeWin pro analýzu poruch v energetice. In: Nové smery v spracovaní signálov III. Vol. 2. - Liptovský Mikuláš, Vojenská akadémia Slovenského národného povstania 1996, p. 123-126.
 - Jurák, P., Haláček, J., Švejdová, M.: 2D EEG Signal Processing. In: Analysis of Biomedical Signals and Images. Proceedings of the 13th Biennial International Conference Biosignal '96. (Ed.: Jan, J., Kilián, P., Provazník, I.) - Brno, Technical University 1996, p. 296-298.
 - Kasal, M., Haláček, J.: The Four-Ring Birdcage Coil for 1H Imaging and 1H-Decoupled 31P MR Spectroscopy of the Human Head. In: Analysis of Biomedical Signals and Images. Proceedings of the 13-th Biennial International Conference Biosignal '96. (Ed.: Jan, J., Kilián, P., Provazník, I.) - Brno, Technical University 1996, p. 89-91.
 - Konzbul, P., Švéda, K.: Measurement and Analysis of the Magnetic Fields on SHIM System for MRI Magnet. In: Interdisciplinary Applied Electromagnetics. (Ed.: Gottvald, A., Zemánek, I.) - Brno, Czech Society of Applied Electromagnetics 1996, p. 93-96.
 - Krejčí, I., Vondra, V.: The application of the Direct Digital Synthesizer in the exciting signal generation in the NMR Spectroscopy. In: Nové smery v spracovaní signálov III. Vol. 1. - Liptovský Mikuláš, Vojenská akadémia Slovenského národného povstania 1996, p. 86-89.
 - Kuchařová, H., Gottvald, A.: Identifying Inhomogeneity Functions in MRS. In: Analysis of Biomedical Signals

- and Images. Proceedings of the 13-th Biennial International Conference Biosignal '96. (Ed.: Jan, J., Kilián, P., Provazník, I.) - Brno, Technical University 1996, p. 92-94.
- Kuchařová, H., Gottvald, A.: On Direct Algebraic Identification of Inhomogeneity Functions in MRS. In: Workshop on MR Signal Processing. - Urbana-Champaign, University of Illinois, Beckman Institute for Advanced Science and Technology 1996, p. 54-56.
 - Malczyk, R., Gottvald, A.: Modelling Inhomogeneity Phenomena in MRS. In: Analysis of Biomedical Signals and Images. Proceedings of the 13-th Biennial International Conference Biosignal '96. (Ed.: Jan, J., Kilián, P., Provazník, I.) - Brno, Technical University 1996, p. 95-97.
 - Malczyk, R., Gottvald, A.: Comparison of Evolution Strategy and Back-Propagation for Estimating Parameters of Neural Network. In: Mendel '96 - 2nd International Conference on Genetic Algorithms. - Brno, Technical University, Faculty of Mechanical Engineering 1996, p. 71-74.
 - Malczyk, R., Gottvald, A.: On Generalized FID-Signals in MRS. In: Workshop on MR Signal Processing. - Urbana-Champaign, University of Illinois, Beckman Institute for Advanced Science and Technology 1996, p. 57-59.
 - Musilová, V., Hanzelka, P.: Thermal Shielding Using High Temperature Superconductors? In: Kryogenika '96 - Cryogenics '96. Proceedings of the 4th International Conference. - Praha, Czech Society for Mechanical Engineering - National Section for Cryogenics 1996, p. 124-127.
 - Musilová, V., Srnka, A.: Influence of Superconductor Magnetization and Flux Creep on Field Homogeneity and Stability of NMR Magnets. In: Interdisciplinary Applied Electromagnetics. (Ed.: Gottvald, A., Zemánek, I.) - Brno, Czech Society of Applied Electromagnetics 1996, p. 97-107.
 - Starčuk jr., Z., Starčuk, Z., Tkáč, I.: Highly Effective Spectrally Selective Water Suppression Method for in vivo Localized 1H MR Spectroscopy of the Brain. In: Analysis of Biomedical Signals and Images. Proceedings of the 13th Biennial International Conference Biosignal '96. (Ed.: Jan, J., Kilián, P., Provazník, I.) - Brno, Technical University 1996, p. 110-112.
 - Starčuk jr., Z., Starčuk, Z., Tkáč, I.: Proton MR spectroscopy in vivo: Double spin echo (PRESS) volume localization with reduced contamination artifacts. In: Proceedings of the 29th NMR conference. - Krakow, Instytut Fizyki Jadrowej 1996, p. 71-74.
 - Starčuk, Z., Starčuk jr., Z., Tkáč, I.: New Sequences for Spatially Localized Proton in vivo MR Spectroscopy with Enhanced Outer Volume Saturation. In: Analysis of Biomedical Signals and Images. Proceedings of the 13th Biennial International Conference Biosignal '96. (Ed.: Jan, J., Kilián, P., Provazník, I.) - Brno, Technical University 1996, p. 107-109.
 - Starčuk, Z., Starčuk jr., Z., Tkáč, I.: Pulse sequence for a multi-voxel MR spectroscopy using two-dimensional Hadamard encoding. In: Proceedings of the International Society for Magnetic Resonance in Medicine. Vol. 2. - New York, International Society for Magnetic Resonance in Medicine 1996, p. 1206.
 - Starčuk, Z., Starčuk jr., Z., Tkáč, I.: Short echo-time single-voxel localization scheme for in vivo 1H MRS with enhanced outer volume saturation. In: Proceedings of the International Society for Magnetic Resonance in Medicine. Vol. 2. - New York, International Society for Magnetic Resonance in Medicine 1996, p. 1207.
 - Tkáč, I., Starčuk, Z., Starčuk jr., Z.: Visualisation of Dephased Magnetization. In: 2. Iglar NMR Táže. Perspectives in NMR Spectroscopy. - Innsbruck, University of Innsbruck 1996, p. 12.
 - Vondra, V., Haláček, J.: Influence of digital audio filters on image reconstruction in Magnetic Resonance Imaging. In: Nové směry v spracování signálů III. Vol. 2. - Liptovský Mikuláš, Vojenská akadémia Slovenského národného povstania 1996, p. 119-122.

Conference Abstracts

- Bartušek, K., Dokoupil, Z.: A digital gradient controller and a matrix shims feeding device for NMR tomography. Magnetic Resonance Materials in Physics, Biology, and Medicine 4 [2-Suppl.] 269-270 (1996). In: Scientific Program and Book of Abstracts of the 13th Annual Meeting European Society for Magnetic Resonance in Medicine and Biology. (Ed.: Haase, A.)
- Bartušek, K., Dokoupil, Z.: About some Achievements in Preemphasis Compensation of the Eddy Currents in ISI Brno. In: 11th NMR Valtice. - Brno, Spectroscopic Society of Johannes Marcus Marci - Magnetic Resonance Spectroscopy Discussion Group 1996, p. 28
- Gottvald, A.: On Inverse Methodologies of ECT. In: Proceedings of the 4th International Workshop on Optimization and Inverse Problems in Electromagnetism. - Brno, Institute of Scientific Instruments of the Academy of Sciences of the Czech Republic 1996, p. 29.
- Gottvald, A.: On Inverse and Optimization Problems in MR: Old Dogs, New Tricks. In: Proceedings of the 4th International Workshop on Optimization and Inverse Problems in Electromagnetism. - Brno, Institute of Scientific Instruments of the Academy of Sciences of the Czech Republic 1996, p. 33.

- Gottvald, A.: Inverse Methodologies, Meta-Evolutionary Optimization and Bayesian Statistics: Applications to In Vivo MRS. In: Proceedings of the 4th International Workshop on Optimization and Inverse Problems in Electromagnetism. - Brno, Institute of Scientific Instruments of the Academy of Sciences of the Czech Republic 1996, p. 34.
- Halámek, J., Kasal, M., Jurák, P.: Simple Digital Receiver and Acquisition Unit. In: 11th NMR Valtice. - Brno, Spectroscopic Society of Johannes Marcus Marci - Magnetic Resonance Spectroscopy Discussion Group 1996, p. 31.
- Halámek, J., Kasal, M., Vondra, V., Villa, M., Cofrancesco, P.: Direct digital receiver for NMR and MRI. Magnetic Resonance Materials in Physics, Biology, and Medicine 4 [2-Suppl.] 276 (1996). In: Scientific Program and Book of Abstracts of the 13th Annual Meeting European Society for Magnetic Resonance in Medicine and Biology. (Ed.: Haase, A.)
- Hanzelka, P.: Calculation Algorithms for the Analysis of Thermal Processes in Cryogenic Devices - KRYOM 3.2 Software. In: Symposium Guide and Abstracts Brochure of the International Symposium on Cryogenics in Science and Industry. - Geneva, CERN, European Laboratory for Particle Physics 1996, p. 16.
- Hanzelka, P., Konzbul, P., Musilová, V., Srnka, A.: Economical Superconducting Magnet System for NMR and MRI in Medium Volumes. In: Symposium Guide and Abstracts Brochure of the International Symposium on Cryogenics in Science and Industry. - Geneva, CERN, European Laboratory for Particle Physics 1996, p. 18.
- Konzbul, P., Švéda, K.: Design and Optimization of Cylindrical Gradient Coils with Ultra Purity Magnetic Field for MRI System MIDI-200. In: Proceedings of the 4th International Workshop on Optimization and Inverse Problems in Electromagnetism. - Brno, Institute of Scientific Instruments of the Academy of Sciences of the Czech Republic 1996, p. 38.
- Malczyk, R., Gottvald, A.: Comparison of Evolution Strategy and Back-Propagation for Estimating Parameters of Neural Networks. In: Proceedings of the 4th International Workshop on Optimization and Inverse Problems in Electromagnetism. - Brno, Institute of Scientific Instruments of the Academy of Sciences of the Czech Republic 1996, p. 48.
- Starčuk jr., Z., Saunders, J.: Magnet-Specific Shim Coil Design. In: 11th NMR Valtice. - Brno, Spectroscopic Society of Johannes Marcus Marci - Magnetic Resonance Spectroscopy Discussion Group 1996, p. 29.
- Starčuk jr., Z., Starčuk, Z., Tkáč, I.: Robust spectrally and spatially tailored water saturation in in vivo MR spectroscopy. Magnetic Resonance Materials in Physics, Biology, and Medicine 4 [2-Suppl.] 282 (1996). In: Scientific Program and Book of Abstracts of the 13th Annual Meeting European Society for Magnetic Resonance in Medicine and Biology. (Ed.: Haase, A.)
- Starčuk, Z., Horký, J., Starčuk jr., Z.: Low-Power Composite RF Pulse for Water Resonance Suppression. In: 11th NMR Valtice. - Brno, Spectroscopic Society of Johannes Marcus Marci - Magnetic Resonance Spectroscopy Discussion Group 1996, p. 30.
- Starčuk, Z., Starčuk jr., Z., Tkáč, I.: Multi-Voxel in vivo NMR Spectroscopy. In: 11th NMR Valtice. - Brno, Spectroscopic Society of Johannes Marcus Marci - Magnetic Resonance Spectroscopy Discussion Group 1996, p. 25.
- Starčuk, Z., Tkáč, I., Starčuk jr., Z.: Suppression of Relaxation Effects in Water-Saturated Localized 1-H in vivo MR Spectroscopy. In: EENC '96 Paris. Abstract Book of the 13th European Experimental NMR Conference. - Paris, - 1996, p. 349.
- Starčuk, Z., Tkáč, I., Starčuk jr., Z., Horký, J.: Single voxel localized proton MR spectroscopy: SPRES-D with improved water suppression. Magnetic Resonance Materials in Physics, Biology, and Medicine 4 [2-Suppl.] 281 (1996). In: Scientific Program and Book of Abstracts of the 13th Annual Meeting European Society for Magnetic Resonance in Medicine and Biology. (Ed.: Haase, A.)
- Šalanský, I., Bartušek, K.: Problematika měření biopotenciálu živých systémů. In: Abstrakta 14. Congressus Acupuncturae Bohemiae et Slovacae. - Brno, Česká lékařská akupunkturistická společnost 1996, p. 58.
- Tkáč, I., Starčuk, Z., Starčuk jr., Z.: Benefits and Drawbacks of the Pulse Sequences for Localized NMR Spectroscopy. In: 11th NMR Valtice. - Brno, Spectroscopic Society of Johannes Marcus Marci, Magnetic Resonance Spectroscopy Discussion Group 1996, p. 24.
- Tkáč, I., Starčuk, Z., Starčuk jr., Z., Kavec, M.: Short echo-time two-voxel MR spectroscopy based on Hadamard encoding. Magnetic Resonance Materials in Physics, Biology, and Medicine 4 [2-Suppl.] 281-282 (1996). In: Scientific Program and Book of Abstracts of the 13th Annual Meeting European Society for Magnetic Resonance in Medicine and Biology. (Ed.: Haase, A.)
- Vondra, V., Halámek, J.: Influence of digital audio filters on image reconstruction in MRI. In: 11th NMR Valtice. - Brno, Spectroscopic Society of Johannes Marcus Marci - Magnetic Resonance Spectroscopy Discussion Group 1996, p. 32.
- Vondra, V., Wajer, F., Halámek, J., Ormond van, D.: Influence of digital audio filters on image reconstruction in MRI. Magnetic Resonance Materials in Physics, Biology, and Medicine 4 [2-Suppl.] 292-293 (1996). In: Scientific Program and Book of Abstracts of the 13th Annual Meeting European Society for Magnetic Resonance in Medicine and Biology. (Ed.: Haase, A.)

COHERENT OPTICS

Articles in Journals

- Zemánek, P., Foot, C.: Laser cooling of atoms in a strong Gaussian standing wave. *Jemná mechanika a optika* 41 [4] 111-118 (1996).

Conference Contributions

- Jonáš, A., Šrámek, L., Liška, M., Zemánek, P.: Manipulation of microobjects by means of the focused laser beam. In: *Proceedings of the Wave and Quantum Aspects of Contemporary Optics (Proc. SPIE 3320) - 10th Polish-Czech-Slovak Optical Conference*. (Ed.: Nowak, J., Zajac, M.) - Washington, SPIE-The International Society for Optical Engineering 1996, p. 104-110.
- Lazar, J., Číp, O.: Computer-controlled portable He-Ne-I2 stabilized laser for interferometry. In: *Proceedings of the Wave and Quantum Aspects of Contemporary Optics (Proc. SPIE 3320) - 10th Polish-Czech-Slovak Optical Conference*. (Ed.: Nowak, J., Zajac, M.) - Washington, SPIE-The International Society for Optical Engineering 1996, p. 122-129.
- Stone, J., Howard, L., Stejskal, A., Stephens, M., Oates, C., Hollberg, L.: Novel Methods for Length Measurement Employing Diode Lasers. In: *Proceedings of the 1996 Workshop and Symposium: Preparing Metrology for the Next Millennium. Vol. 2.* - Monterey, NCSL 1996, p. 667-676.
- Stone, J., Stejskal, A., Howard, L.: Wavelength-Shift Interferometry: Using a Dither to Improve Accuracy. In: *Proceedings of the 11th Annual Meeting the American Society for Precision Engineering.* - Raleigh, ASPE 1996, p. 357-362.
- Zemánek, P., Foot, C.: Strong Gaussian standing wave - an efficient tool for laser cooling of atomic beams. In: *Proceedings of the Wave and Quantum Aspects of Contemporary Optics (Proc. SPIE 3320) - 10th Polish-Czech-Slovak Optical Conference*. (Ed.: Nowak, J., Zajac, M.) - Washington, SPIE-The International Society for Optical Engineering 1996, p. 97-103.

Year of publication: 1997

ELECTRON OPTICS

Books & Non-conference Proceedings

- Crewe, A., Hawkes, P., Kruit, P., Jansen, G., Lencová, B., Mair, G., Munro, E., Postek, M., Sato, M., Schwind, G., Tsuno, K., Utlaut, M.: *Electrostatic Lenses* In: *Handbook of Charged Particle Optics*. (Ed.: Orloff, J.) Vol. 5. - New York, CRT Pres LLC 1997, p. 177-222.
- Delyagin, N., Erzinkyan, A., Parfenova, V., Reyman, S., Gurevich, G., Dupák, J.: Preprint INR 0955-97: Temperature Evolution of Spin Configurations in the System with Competing Exchange Interactions ($\text{Fe}_{0.65}\text{Ni}_{0.35}1-x\text{Mnx}$ ($x=0.024$ and 0.034)). Moscow, Institute for Nuclear Research of the Russian Academy of Sciences 1997. 18 s.
- Lencová, B.: *Electrostatic Lenses - habilitační práce*. Brno, Ústav přístrojové techniky AV ČR 1997. 62 s.

Articles in Journals

- Autrata, R., Hutař, O., Schauer, P.: Low voltage single crystal backscatter electron detectors. *Journal of Computer-Assisted Microscopy* 9 [2] 105-107 (1997).
- Autrata, R., Jiráček, J., Klvač, M., Špinka, J.: Detection of backscattered electrons in environmental scanning electron microscope. *Journal of Computer-Assisted Microscopy* 9 [2] 113-114 (1997).
- Autrata, R., Jiráček, J., Romanovský, V., Špinka, J.: Signal detection in environmental SEM with ionisation detector. *Journal of Computer-Assisted Microscopy* 9 [2] 115-116 (1997).
- Frank, L., Müllerová, I.: Wave-optical contrast in SEM. *Journal of Computer-Assisted Microscopy* 9 [2] 109-110 (1997).

- Hutař, O., Austrata, R.: Optimization of the BSE Detector for LVSEM. *Journal of Computer-Assisted Microscopy* 9 [2] 117-118 (1997).
- Jensen, H., Sobota, J., Sorensen, G.: Multilayer film deposition of TIN/AIN on rotating substrate holder from reactive sputtering of elemental targets of titanium and aluminium. *Journal of Vacuum Science & Technology, A* 15 [3] 941-945 (1997).
- Jensen, H., Sobota, J., Sorensen, G.: A study of film growth and tribological characterization of nanostructured C-N/TiNx multilayer coatings. *Surface and Coatings Technology* 94-95 [1-3] 174-178 (1997).
- Lenc, M., Lencová, B.: Analytical and numerical computation of the multipole components of magnetic deflectors. *Review of Scientific Instruments* 68 [12] 4409-4414 (1997).
- Lencová, B., Lenc, M.: Third order geometrical and first order chromatic aberrations of electrostatic lenses, a comparison of formulas. *Optik* 105 [3] 121-128 (1997).
- Müllerová, I.: Microscopy with slow electrons. *Journal of Computer-Assisted Microscopy* 9 [2] 97-100 (1997).
- Müllerová, I., Frank, L.: Low Energy Scanning Electron Microscopy (LESEM). *Jemná mechanika a optika* 42 [11-12] 335-340 (1997).
- Müllerová, I., Zdražil, M., Frank, L.: Low-energy SEM imaging of bevelled multilayers. *Journal of Computer-Assisted Microscopy* 9 [2] 121-122 (1997).
- Schauer, P., Austrata, R.: Inquiry of detector components for electron microscopy. *Jemná mechanika a optika* 42 [11-12] 332-334 (1997).
- Schauer, P., Austrata, R.: Scintillator-photocathode matching in scintillation detector for S(T)EM. *Journal of Computer-Assisted Microscopy* 9 [2] 119-120 (1997).
- Sobota, J., Sorensen, G.: Ion bombardment of MoS₂ nanoplatelet coatings deposited by electrospraying. *Tribology Letters* 3 [2] 161-164 (1997).
- Sobota, J., Sorensen, G.: Ion bombardment of solid lubricating nanoparticle coatings. *Nuclear Instruments and Methods in Physics Research, B* 127/128 [May] 945-948 (1997).
- Zdražil, M., El Gomati, M., Walker, A.: Measurements of very low energy secondary and backscattered electron coefficients. *Journal of Computer-Assisted Microscopy* 9 [2] 123-124 (1997).

Conference Contributions

- Austrata, R., Hutař, O., Jiráček, J., Špínka, J.: Využití detekce zpětně odražených elektronů v rastrovací elektronové mikroskopii pro studium materiálů. In: *Mezinárodní konference Diagnostika '97. - Plzeň, Západočeská univerzita v Plzni 1997*, p. 223-224.
- Austrata, R., Hutař, O., Schauer, P.: Low voltage single crystal backscatter electron detectors. In: *Proceedings of the 3rd Multinational Congress on Electron Microscopy. - Ljubljana, Jožef Stefan Institute, Ceramics Department 1997*, p. 281-282.
- Austrata, R., Jiráček, J., Klvač, M., Špínka, J.: Detection of backscattered electrons in environmental scanning electron microscope. In: *Proceedings of the 3rd Multinational Congress on Electron Microscopy. - Ljubljana, Jožef Stefan Institute, Ceramics Department 1997*, p. 287-288.
- Austrata, R., Jiráček, J., Romanovský, V., Špínka, J.: Signal detection in environmental SEM with ionisation detector. In: *Proceedings of the 3rd Multinational Congress on Electron Microscopy. - Ljubljana, Jožef Stefan Institute, Ceramics Department 1997*, p. 289-290.
- Austrata, R., Jiráček, J., Špínka, J.: Detection of Signal Electrons in an Environmental Scanning Electron Microscope. In: *Proceedings of Workshop '97. Vol. 3. - Praha, Czech Technical University 1997*, p. 1025-1026.
- Austrata, R., Jiráček, J., Špínka, J.: Podmínky pozorování vzorků materiálů v ESEM. In: *Mezinárodní konference Diagnostika '97. - Plzeň, Západočeská univerzita v Plzni 1997*, p. 220-222.
- Austrata, R., Jiráček, J., Špínka, J.: Využití ESEM v diagnostice elektrotechnických materiálů. In: *Mezinárodní konference Diagnostika '97. - Plzeň, Západočeská univerzita v Plzni 1997*, p. 225-227.
- Cubric, D., Lencová, B., Read, F.: Comparison of Finite Difference, Finite Element and Boundary Element Methods for Electrostatic Charged Particle Optics. In: *Electron Microscopy and Analysis 1997 - Proceedings of the Institute of Physics Conference (Series Number 153, Section 3). (Ed.: Rodenburg, J. M.) - Bristol, Institute of Physics Publishing Ltd. 1997*, p. 91-94.
- El Gomati, M., Assa'd, A., El Gomati, T., Zdražil, M.: On the measurement of low energy backscattered and secondary electron coefficients. In: *Electron Microscopy and Analysis 1997 - Proceedings of the Institute of Physics Conference (Series Number 153, Section 7). (Ed.: Rodenburg, J. M.) - Bristol, Institute of Physics Publishing Ltd. 1997*, p. 265-268.
- Frank, L., Müllerová, I.: Wave-optical contrast in SEM. In: *Proceedings of the 3rd Multinational Congress on Electron Microscopy. - Ljubljana, Jožef Stefan Institute, Ceramics Department 1997*, p. 283-284.
- Frank, L., Müllerová, I., El Gomati, M.: Localised information in scanning electron beam excited imaging of surfaces. In: *Proceedings of the International Seminar*

- New Trends in Surface Analysis NTSA '97. (Ed.: Breza, J., Liday, J., Frank, L., Král, J.) - Bratislava, Slovak University of Technology, Faculty of Electrical Engineering and Information Technology 1997, p. 1-4.
- Hutař, O.: Diagnostika elektrotechnických materiálů s použitím nízkovoltové rastrovací elektronové mikroskopie. In: Mezinárodní konference Diagnostika '97. - Plzeň, Západočeská univerzita v Plzni 1997, p. 262-266.
 - Hutař, O., Aufrata, R.: Optimization of the BSE Detector for LVSEM. In: Proceedings of the 3rd Multinational Congress on Electron Microscopy. - Ljubljana, Jožef Stefan Institute, Ceramics Department 1997, p. 291-292.
 - Müllerová, I.: Microscopy with slow electrons. In: Proceedings of the 3rd Multinational Congress on Electron Microscopy. - Ljubljana, Jožef Stefan Institute, Ceramics Department 1997, p. 273-278.
 - Müllerová, I., Frank, L.: New types of contrast at low electron energies. In: Proceedings of the International Seminar New Trends in Surface Analysis NTSA '97. (Ed.: Breza, J., Liday, J., Frank, L., Král, J.) - Bratislava, Slovak University of Technology, Faculty of Electrical Engineering and Information Technology 1997, p. 5-8.
 - Müllerová, I., Zdražil, M., Frank, L.: Low-energy SEM imaging of bevelled multilayers. In: Proceedings of the 3rd Multinational Congress on Electron Microscopy. - Ljubljana, Jožef Stefan Institute, Ceramics Department 1997, p. 297-298.
 - Schauer, P., Aufrata, R.: Scintillator-photocathode matching in scintillation detector for S(T)EM. In: Proceedings of the 3rd Multinational Congress on Electron Microscopy. - Ljubljana, Jožef Stefan Institute, Ceramics Department 1997, p. 293-294.
 - Srnanek, R., Satka, A., Liday, J., Vogrincic, P., Kovac, J., Zdražil, M., Frank, L., El Gomati, M.: Study of bevelled InP-based heterostructures by low energy SEM and AES. In: Electron Microscopy and Analysis 1997 - Proceedings of the Institute of Physics Conference (Series Number 153, Section 10). (Ed.: Rodenburg, J. M.) - Bristol, Institute of Physics Publishing Ltd. 1997, p. 453-456.
 - Srnanek, R., Škriniarová, J., Kováč, J., Frank, L., Novotný, I., Hotový, I., Gottschalch, V.: Recognition of defects in semiconductor heterostructures on bevelled surface. In: Defect Recognition and Image Processing in Semiconductors 1997 - Proceedings of the Institute of Physics Conference (Series Number 160). (Ed.: Donecker, J., Rechenberg, I.) - Bristol, Institute of Physics Publishing Ltd. 1997, p. 409-412.
 - Šikola, T., Spousta, J., Zlámal, J., Průša, S., Lopour, F., Kalousek, R., Třískala, M., Tichopádek, P., Krejzlík, T., Nebojsa, A., Lencová, B.: Ion Beam Thin Film Deposition, Surface and Thin Film Analysis. In: Proceedings of Workshop '97. Vol. 1. - Praha, Czech Technical University 1997, p. 117-118.
 - Šikola, T., Zlámal, J., Spousta, J., Štefka, J., Lencová, B., Nebojsa, A., Armour, D.: Diagnostics of Beams and Surface Analysis in an IBA Apparatus. In: ECASIA 97 - 7th European Conference on Applications of Surface and Interface Analysis. (Ed.: Olefjord, I., Nyborg, L., Briggs, D.) - Chichester, John Wiley & Sons Ltd. 1997, p. 991-994.
 - Škoda, P., Dupák, J., Ustohal, V.: Problems Regarding Electron Beam Welding of Aluminium with Stainless Steel. In: EBT '97 - 5th International Conference on Electron Beam Technologies. - Varna, Institute of Electronics, Bulgarian Academy of Sciences 1997, p. 182-185.
 - Ustohal, V., Škoda, P., Dupák, J.: Spojování hliníku s nerez ocelí "pájecím svařováním" ve vakuu. Zeszyty naukowe Politechniki Opolskiej, Mechanika 235 [55] 103-106 (1997).
 - Yamamoto, K., Tanji, T., Hibino, M., Schauer, P., Aufrata, R.: Improvement of Light Collection Efficiency of Lens Coupled YAG Screen TV System for HVEM. In: Proceeding of the International Symposium on Atomic Level Characterization for New Materials and Devices '97. - Maui, The Microbeam Analysis 141 Committee of Japan Society for the Promotion of Science 1997, p. 98-101.
 - Zdražil, M., El Gomati, M., Walker, A.: Measurements of very low energy secondary and backscattered electron coefficients. In: Proceedings of the 3rd Multinational Congress on Electron Microscopy. - Ljubljana, Jožef Stefan Institute, Ceramics Department 1997, p. 301-30.

Conference Abstracts

- Cubric, D., Lencová, B., Read, F.: Comparison of Finite Difference, Finite Element and Boundary Element Methods for electrostatic charged particle optics. In: Abstract Book - Electron Microscopy and Analysis Conference. - Cambridge, Institute of Physics 1997, p. PEO.3.
- El Gomati, M., Müllerová, I., Frank, L.: Image contrast by Auger and very low energy electron microscopy. In: Programme of the International Centennial Symposium on the Electron. - Cambridge, University of Cambridge 1997, p. P16.
- Frank, L., Müllerová, I.: Achievement of Wave-Optical Contrasts in a Scanning Electron Microscope. In: Book of Abstracts EMAS '97 - 5th European Workshop on Modern Developments and Applications in Microbeam Analysis. - Torquay, European Microbeam Analysis Society 1997, p. 302.

- Jensen, H., Sobota, J., Sorensen, G.: Film Growth of Nanostructured C-N/TiN Multilayers Reactively Sputtered in Pure Nitrogen. In: Abstracts: 44th National Symposium AVS. - New York, American Vacuum Society 1997, p. 76.
- Müllerová, I., Frank, L.: Microscopy of Solid State Surfaces by Low Energy Electron Beams. In: Book of Abstracts EMAS '97 - 5th European Workshop on Modern Developments and Applications in Microbeam Analysis. - Torquay, European Microbeam Analysis Society 1997, p. 332.
- Srnánek, R., Kováč, J., Fesic, V., Frank, L., Liday, J., Vogrincic, P., Novotný, I., Hotový, I., Buc, D.: Characterization of III-V Semiconductor Heterostructure on Bevelled Surface. In: 3rd International Workshop on Heterostructure Epitaxy and Devices HEAD '97. - Bratislava, Institute of Electrical Engineering, Slovak Academy of Sciences 1997, p. P10.
- Srnánek, R., Satka, A., Liday, J., Vogrincic, P., Kováč, J., Zadražil, M., Frank, L., El Gomati, M.: Study of bevelled InP-based heterostructures by low energy SEM and AES. In: Abstract Book - Electron Microscopy and Analysis Conference. - Cambridge, Institute of Physics 1997, p. PSE.6.
- Srnánek, R., Škriniarová, J., Kováč, J., Frank, L., Novotný, I., Hotový, I., Gottschalch, V.: Effect Recognition in Semiconductor Heterostructures on Bevelled Surface. In: Abstracts of the 7th International Conference on Defect Recognition and Image Processing in Semiconductors DRIP VII. - Berlin, Institute of Crystal Growth 1997, p. 10.8.
- Šikola, T., Zlámal, J., Spousta, J., Štefka, J., Lencová, B., Nebojsa, A., Armour, D.: Diagnostics of Beams and Surface Analysis in an IBAD Apparatus. In: Proceedings of the 7th European Conference on Applications of Surface and Interface Analysis. (Ed.: Olefjord, I.) - Göteborg, Chalmers University of Technology 1997, p. TC-34.
- Tarasenko, A., Jastrabík, L., Chvostova, D., Sobota, J.: An ellipsometric study of Ni, Mo and NiNx films deposited on Si. In: Final Program & Abstracts of the 2nd International Conference on Spectroscopic Ellipsometry. - Charleston, University of North Carolina 1997, p. P2.14.
- Zadražil, M., Frank, L.: Non-Charging Scanning Electron Microscopy at Critical Energies. In: Book of Abstracts EMAS '97 - 5th European Workshop on Modern Developments and Applications in Microbeam Analysis. - Torquay, European Microbeam Analysis Society 1997, p. 373.

NUCLEAR MAGNETIC RESONANCE

Books & Non-conference Proceedings

- Starčuková, J., Starčuk jr., Z., Kozłowski, P.: Software Manual WIN-MRI. Bremen, Bruker-Franzen Analytik GmbH 1997. 301 s.

Articles in Journals

- Gottvald, A.: On Bayesian Analysis of Generalized MR-Signals. *Journal of Electrical Engineering* 48 [8/s] 137-140 (1997).
- Gottvald, A.: A survey of inverse methodologies, meta-evolutionary optimization and Bayesian statistics: applications to in vivo MRS. *International Journal of Applied Electromagnetics and Mechanics* 8 [1] 17-44 (1997).
- Gottvald, A., Kuchařová, H., Malczyk, R.: Properties of Inhomogeneity Functions in MRS. *Journal of Electrical Engineering* 48 [8/s] 145-148 (1997).
- Gottvald, A., Malczyk, R.: Geometry of Generalized Signals and Spectra in MRS. *Journal of Electrical Engineering* 48 [8/s] 141-144 (1997).
- Haláček, J., Jurák, P., Kasal, M., Villa, M., Cofrancesco, P.: Analog-to-Digital Converter and Dynamic Range. *Journal of Electrical Engineering* 48 [7-8] 183-189 (1997).
- Haláček, J., Kasal, M., Villa, M., Cofrancesco, P.: Bandpass Signal Processing. *Radioengineering* 6 [1] 1-8 (1997).
- Konzbul, P., Švéda, K.: Design and Optimization of Low Power Consumption Shim-Gradient Coil of Z0 type for MRI and NMR. *Journal of Electrical Engineering* 48 [8/s] 125-128 (1997).
- Penaz, J., Honzíková, N., Jurák, P.: Vibration plethysmography: a method for studying the visco-elastic properties of finger arteries. *Medical & Biological Engineering & Computing* 35 [6] 633-637 (1997).
- Srnka, A., Musilová, V.: Field Homogeneity and Stability of Spectrotomograph Magnet MIDI-2000. *Journal of Electrical Engineering* 48 [8/s] 190-191 (1997).

Conference Contributions

- Bartušek, K.: Baseline Correction of the Magnetic Resonance Spectra by the COBALD Method. In: Proceedings of the 15th IASTED International Conference. Applied Informatics. (Ed.: Hamza, M. H.) - Anaheim, IASTED - Acta Press 1997, p. 25-28.
- Bartušek, K., Mlynárik, V.: Fast measurement technique to characterize the gradient fields in MR systems. In: Proceedings of the International Conference - Measurement '97. (Ed.: Frollo, I., Plačková, A.) - Bratislava, Institute of Measurement Science, Slovak Academy of Sciences 1997, p. 305-308.
- Gottvald, A.: On Bayesian Analysis of Generalized MR-Signals. In: Proceedings of International Conference Measurement '97. (Ed.: Frollo, I., Plačková, A.) - Bratislava, Institute of Measurement Science, Slovak Academy of Sciences 1997, p. 174-177.
- Gottvald, A.: Biological Consequences of Evolutionary Optimizations: Mortality, Variability, Survival. In: Mendel '97 - 3rd International Mendel Conference on Genetic Algorithms, Optimization problems, Fuzzy Logic, Neural networks, Rough Sets. - Brno, Technical University Brno, Faculty of Mechanical Engineering 1997, p. 56-58.
- Gottvald, A.: Inverse Problems and Bayesian Analysis: Applications to Magnetic Resonance in Extreme Conditions. In: AMTEE '97 - 3rd International Conference on Advanced Methods in the Theory of Electrical Engineering applied to power systems. - Plzeň, University of West Bohemia 1997, p. 289-295.
- Gottvald, A., Kuchařová, H., Malczyk, R.: Properties of Inhomogeneity Functions in MRS. In: Proceedings of International Conference Measurement '97. (Ed.: Frollo, I., Plačková, A.) - Bratislava, Institute of Measurement Science, Slovak Academy of Sciences 1997, p. 320-323.
- Gottvald, A., Malczyk, R.: Geometry of Generalized Signals and Spectra in MRS. In: Proceedings of International Conference Measurement '97. (Ed.: Frollo, I., Plačková, A.) - Bratislava, Institute of Measurement Science, Slovak Academy of Sciences 1997, p. 316-319.
- Haláček, J., Jurák, P., Kasal, M.: Dynamic range and digital signal processing. In: Proceedings of the International Conference - Measurement '97. (Ed.: Frollo, I., Plačková, A.) - Bratislava, Institute of Measurement Science, Slovak Academy of Sciences 1997, p. 182-185.
- Haláček, J., Jurák, P., Samek, M.: The ADC frequency bandwidth. In: Proceedings of the 3rd International Conference on Digital Signal Processing DSP '97. (Ed.: Kocour, D., Levický, D., Marchevský, S.) - Košice, Technical University in Košice 1997, p. 121-124.
- Haláček, J., Kasal, M., Húsek, V.: Phase coherence and digital quadrature detection. In: Proceedings of the 3rd International Conference on Digital Signal Processing DSP '97. (Ed.: Kocour, D., Levický, D., Marchevský, S.) - Košice, Technical University in Košice 1997, p. 125-127.
- Haláček, J., Kasal, M., Jurák, P.: Vyhodnocení úzkopásmového signálu. In: STO-6 Seminář teorie obvodů: Moderní směry výuky elektrotechniky a elektroniky. - Brno, Katedra elektrotechniky a elektroniky FL a PVO VA Brno 1997, p. 176-179.
- Jurák, P., Haláček, J.: Band Pass Signal Amplitude. In: Proceedings of the International Conference - Measurement '97. (Ed.: Frollo, I., Plačková, A.) - Bratislava, Institute of Measurement Science, Slovak Academy of Sciences 1997, p. 336-339.
- Jurák, P., Haláček, J.: Band Pass Signal Immediate Frequency and Phase Computation. In: Proceedings of the 3rd International Conference on Digital Signal Processing DSP '97. (Ed.: Kocour, D., Levický, D., Marchevský, S.) - Košice, Technical University in Košice 1997, p. 234-237.
- Jurák, P., Haláček, J.: ScopeWin - systém pro záznam a zpracování signálů. In: STO-6 Seminář teorie obvodů: Moderní směry výuky elektrotechniky a elektroniky. - Brno, Katedra elektrotechniky a elektroniky FL a PVO VA Brno 1997, p. 204-207.
- Jurák, P., Haláček, J., Kára, T.: Heart Beat Intervals Setting Gained from Distorted Blood Pressure Signal. In: Conference Proceedings of the 7th International Scientific Conference Radioelektronika '97. - Bratislava, Slovak University of Technology 1997, p. 327-332.
- Kasal, M., Haláček, J.: Image Reject Mixer. In: Conference Proceedings of the 7th International Scientific Conference Radioelektronika '97. - Bratislava, Slovak University of Technology 1997, p. 74-77.
- Konzbul, P., Švéda, K.: Measurement and Analysis of the Stationary Magnetic Fields for NMR and MRI Using Minimum Number of Data. In: Proceedings of the International Conference - Measurement '97. (Ed.: Frollo, I., Plačková, A.) - Bratislava, Institute of Measurement Science, Slovak Academy of Sciences 1997, p. 348-350.
- Konzbul, P., Švéda, K.: Some Experience with Determination of Maximal Admissible Current Density in the Winding of the Shim PCB Coils for NMR. In: AMTEE '97 - 3rd International Conference on Advanced Methods in the Theory of Electrical Engineering applied to power systems. - Plzeň, University of West Bohemia 1997, p. 191-194.
- Krejčí, I., Kraus, M.: Měření a regulace poměru průtoků dvou kapalin. In: Sborník příspěvků z konference IMEKO TC-9 Měření průtoků '97. - Praha, TECH-MARKET Praha 1997, p. 79-83.
- Krejčí, I., Stoklásek, R., Slaměník, V.: A DSP based system for monitoring and analysis of physiological signals. In: Proceedings of the 3rd International Conference on Digital Signal Processing DSP '97. (Ed.: Kocour, D., Levický, D., Marchevský, S.) - Košice, Technical University in Košice 1997, p. 148-150.

- Krejčí, I., Studnička, P.: The DSP controlled switching mode power supply - a new approach to negative feedback system solution. In: Proceedings of the 3rd International Conference on Digital Signal Processing DSP '97. (Ed.: Kocour, D., Levický, D., Marchevský, S.) - Košice, Technical University in Košice 1997, p. 73-75.
- Malczyk, R., Gottvald, A.: On Evolutionary Phase Corrections in MRS. In: Mendel '97 - 3rd International Mendel Conference on Genetic Algorithms, Optimization problems, Fuzzy Logic, Neural networks, Rough Sets. - Brno, Technical University Brno, Faculty of Mechanical Engineering 1997, p. 83-87.
- Starčuk jr., Z., Starčuk, Z., Tkáč, I.: RF heating in high-field in vivo 1H MR spectroscopy of the human head: are 36 RF pulses too many? In: Proceedings of the International Conference - Measurement '97. (Ed.: Frollo, I., Plačková, A.) - Bratislava, Institute of Measurement Science, Slovak Academy of Sciences 1997, p. 157-160.
- Vojta, J., Bartušek, K.: De-noising of FID signal by wavelets. In: Proceedings of the 3rd International Conference on Digital Signal Processing DSP '97. (Ed.: Kocour, D., Levický, D., Marchevský, S.) - Košice, Technical University in Košice 1997, p. 266-269.
- Vojta, J., Bartušek, K.: Filtrace signálu FID pomocí waveletů. In: Sborník přednášek celostátní konference s mezinárodní účastí Telekomunikace '97. - Brno, Vysoké učení technické, Fakulta elektrotechniky a informatiky, Ústav telekomunikací 1997, p. 145-147.

Conference Abstracts

- Bartušek, K.: Fast measurement of the gradient fields in MR systems. Magnetic Resonance Materials in Physics, Biology, and Medicine 5 [2-Suppl.] 183 (1997). In: Scientific Program and Book of Abstracts of the 14th Annual Meeting of the European Society for Magnetic Resonance in Medicine and Biology. (Ed.: Haase, A.)
- Bartušek, K.: Signal De-Noising in the Gradient Magnetic Field Measurement. In: 1st Kraków - Winnipeg Workshop on Biomedical Applications of MRI and MRS. - Kraków, Komitet Badań Naukowych 1997, p. 39.
- Bartušek, K., Vojta, J.: Some NMR Applications of the Wavelet Transformation. In: 12th NMR Valtice. - Brno, The Spectroscopic Society of Johannes Marcus Marci, Central European NMR Discussion Group 1997, p. 21.
- Bartušek, K., Vojta, J.: Increase in the Precision of the Gradient Magnetic Field Measurement. In: Book of Abstracts of the 4th International Conference on Magnetic Resonance Microscopy and Macroscopy - Heidelberg Conference. - Albuquerque, Division of Spatially Resolved Magnetic Resonance of the Groupement Ampere 1997, p. 54.
- Brázdil, M., Rektor, I., Dufek, M., Jurák, P., Daniel, P.: Effect of subliminally presented visual stimuli on event-related potentials: Use of oddball paradigm. Electroencephalography and Clinical Neurophysiology 103 [1] 109 (1997).
- Halámek, J., Kasal, M., Vondra, V.: The DSP Acquisition Unit. In: 1st Kraków - Winnipeg Workshop on Biomedical Applications of MRI and MRS. - Kraków, Komitet Badań naukowych 1997, p. 41.
- Kasal, M., Halámek, J., Vondra, V.: The Four-Ring Birdcage Coil and Its Equivalent Circuit. In: 1st Kraków - Winnipeg Workshop on Biomedical Applications of MRI and MRS. - Kraków, Komitet Badań Naukowych 1997, p. 43.
- Kára, T., Jurák, P., Halámek, J., Novotný, J., Šumbera, J., Souček, M., Štejf, M.: Spektrální analýza variability srdeční frekvence a senzitivita baroreflexu u nemocných s chronickým srdečním selháním. In: Abstrakta - 23. den mladých výzkumníků České kardiologické společnosti. - Praha, Česká kardiologická společnost 1997, p. 16-17.
- Kára, T., Jurák, P., Šumbera, J., Toman, J., Novák, M., Halámek, J., Seménka, J., Špinarová, L., Toman, O., Tejc, M., Novotný, J.: Možnosti hodnocení variability srdeční frekvence a baroreflexní senzitivity metodami fázového posunu a XYt grafem. In: Sborník abstrakt ze IV. českého symposia o arytmiích a kardiostimulaci. - Olomouc, Česká kardiologická společnost 1997, p. L26.
- Kára, T., Jurák, P., Toman, J., Halámek, J., Novotný, J., Špinarová, L., Šumbera, J., Souček, M., Štejf, M.: Spektrální analýza variability srdeční frekvence a senzitivita baroreflexu u nemocných s chronickým srdečním selháním. In: Sborník abstrakt - V. výroční sjezd České kardiologické společnosti. - Brno, Česká kardiologická společnost 1997, p. 126.
- Starčuk jr., Z., Starčuk, Z., Horký, J., Tkáč, I.: RF Power Deposition in High-Field in vivo 1H MR Spectroscopy. In: 12th NMR Valtice. - Brno, The Spectroscopic Society of Johannes Marcus Marci, Central European NMR Discussion Group 1997, p. 20.
- Starčuk jr., Z., Starčuk, Z., Tkáč, I.: Localized proton MR spectroscopy: Short echo-time STEAM sequence with a new approach to T1 insensitive highly effective water suppression. In: Proceedings of the International Society for Magnetic Resonance in Medicine - 5th Scientific Meeting and Exhibition. - Berkeley, International Society for Magnetic Resonance in Medicine 1997, p. 1459.
- Starčuk, Z., Starčuk jr., Z., Tkáč, I.: Proton spectroscopy in vivo by SPRES localization with improved contamination suppression and with reduced RF power and homogeneity requirements. Magnetic Resonance Materials in Physics, Biology, and Medicine 5 [2-Suppl.] 17 (1997). In: Scientific Program and Book of Abstracts of the 14th Annual Meeting of the European Society for Magnetic Resonance in Medicine and Biology. (Ed.: Haase, A.)

- Starčuk, Z., Starčuk jr., Z., Tkáč, I.: Low Contamination, Short Echo-Time Proton NMR Spectroscopy in vivo by STEAM and SPRES Localization. In: 1st Kraków - Winnipeg Workshop on Biomedical Applications of MRI and MRS. - Kraków, Komitet Badań Naukowych 1997, p. 11.
- Starčuk, Z., Starčuk jr., Z., Tkáč, I., Horký, J.: STEAM Proton in vivo MR Spectroscopy: An Approach to Recording Spectra with Extremely Short Echo Times. In: 12th NMR Valtice. - Brno, The Spectroscopic Society of Johannes Marcus Marci, Central European NMR Discussion Group 1997, p. 19.
- Starčuk, Z., Tkáč, I., Starčuk jr., Z.: Whole chemical shift range in vivo ^1H MR spectroscopy of the rat brain. Magnetic Resonance Materials in Physics, Biology, and Medicine 5 [2-Suppl.] 166-167 (1997). In: Scientific Program and Book of Abstracts of the 14th Annual Meeting of the European Society for Magnetic Resonance in Medicine and Biology. (Ed.: Haase, A.)
- Starčuk, Z., Tkáč, I., Starčuk jr., Z.: Some Aspects of Reliable Measurement of Whole Chemical Shift Range (0-9 ppm) in vivo ^1H MR Spectra in the Brain. In: 1st Kraków - Winnipeg Workshop on Biomedical Applications of MRI and MRS. - Kraków, Komitet Badań Naukowych 1997, p. 10.
- Starčuková, J., Kozłowski, P., Starčuk jr., Z., Saunders, J., Germanus, A., Thiele, H.: WIN-MRI: PC Software for Imaging and Spectroscopic Imaging Data Processing and Presentation. In: 1st Kraków - Winnipeg Workshop on Biomedical Applications of MRI and MRS. - Kraków, Komitet Badań Naukowych 1997, p. 40.
- Tkáč, I., Starčuk jr., Z., Starčuk, Z.: Recording of short and long echo time MR spectra in vivo in a single experiment using a SPRES sequence. In: Proceedings of the International Society for Magnetic Resonance in Medicine - 5th Scientific Meeting and Exhibition. Vol. 3. - Berkeley, International Society for Magnetic Resonance in Medicine 1997, p. 1461.
- Tkáč, I., Starčuk, Z., Starčuk jr., Z.: Field Gradients in Localized MR Spectroscopy. In: 12th NMR Valtice. - Brno, The Spectroscopic Society of Johannes Marcus Marci, Central European NMR Discussion Group 1997, p. 18.
- Vondra, V., Haláček, J., Kasal, M.: Elimination of digital audio filters effects in MRI. In: 1st Kraków - Winnipeg Workshop on Biomedical Applications of MRI and MRS. - Kraków, Komitet Badań Naukowych 1997, p. 42.
- Vondra, V., Wajer, F., Haláček, J., Ormond van, D.: Influence of digital audio filters on image reconstruction in MRI. In: Proceedings of the International Society for Magnetic Resonance in Medicine - 5th Scientific Meeting and Exhibition. - Berkeley, International Society for Magnetic Resonance in Medicine 1997, p. 2049.

COHERENT OPTICS

Articles in Journals

- Lazar, J., Číp, O.: Electronics for He-Ne-I2 stabilized laser with digital control. Review of Scientific Instruments 68 [10] 3660-3665 (1997).
- Petrů, F., Lazar, J., Číp, O., Popescu, G., Chartier, J.: Frequency comparison of He-Ne/iodine lasers at 633 nm between the NILPRP and the ISI, and traceability through the BIPM. Metrologia 34 [6] 515-518 (1997).
- Pokorný, P.: Control of Polarization Effects in Cube-Corner Reflectors. Jemná mechanika a optika 42 [11-12] 347-349 (1997).

Year of publication: 1998

ELECTRON OPTICS

Books & Non-conference Proceedings

- Delyagin, N., Erzinkyan, A., Parfenova, V., Reyman, S., Gurevich, G., Dupák, J.: Preprint INR 0978-98: Evidence for a relation between the temperature dependence of the Fe-Fe exchange interactions and magnetic behaviour of the $(\text{Fe}_{0.65}\text{Ni}_{0.35})_{1-x}\text{Mn}_x$ alloys. Moscow, Institute for Nuclear Research of the Russian Academy of Sciences 1998.
- Müllerová, I., Frank, L.: Recent Trends in Charged Particle Optics and Surface Physics Instrumentation - 6th Seminar. Brno, Czechoslovak Society for Electron Microscopy 1998.

Articles in Journals

- Adamec, P., Bauer, E., Lencová, B.: Compact low-energy electron microscope for surface imaging. Review of Scientific Instruments 69 [10] 3583-3587 (1998).
- Deljagin, N., Jerzinkjan, G., Gurevich, G., Parfenova, V., Rejman, S., Dupák, J.: Temperaturnaja evoljucija frustrirovannyh spinovyh sostojanij v sisteme s konkurirujuščími obmennymi vzaimodejstvijami (Fe_{0.65}Ni_{0.35})_{1-x}Mnx(x=0,0.024 i 0.034). Fizika tverdogo tela 40 [9] 1650-1655 (1998).
- Handlíř, R., Schauer, F., Nešpůrek, S., Kuřitka, I., Weiter, M., Schauer, P.: Metastable states in poly(methylphenylsilylene) induced by UV radiation and electron beam. Journal of Non-Crystalline Solids 227-230 [0] 669-672 (1998).
- Horáček, M.: Detection of the Angular Distribution of the Signal Electrons in VLESEM. Journal of Computer-Assisted Microscopy 10 [1] 23-32 (1998).
- Hutař, O.: Application of noncharging microscopy in semiconductor fabrication. Bulletin CSEM - [9] 21 (1998).
- Jensen, H., Sobota, J., Sorensen, G.: Film growth of nanostructured C-N/TiNx multilayers reactively sputtered in pure nitrogen. Journal of Vacuum Science & Technology, A 16 [3] 1880-1884 (1998).
- Lenc, M., Lencová, B.: Poincaré a magnetický monopol jako elektronová čočka. Československý časopis pro fyziku 48 [5] 287-292 (1998).
- Manika, I., Muktepavela, F., Jensen, H., Sobota, J., Sorensen, G.: Microhardness and adhesion measurements of reactively sputtered TiN/AlN multilayer coatings deposited as function of mass-flow of nitrogen. Surface and Coatings Technology 100-101 [1-3] 333-337 (1998).
- Škoda, P., Ustohal, V., Dupák, J.: Vakuově těsné spoje trubek z hliníku a korozivzdorné oceli. Zváranie-Svařování 47 [3] 56-60 (1998).
- Tarasenko, A., Jastrabík, L., Chvostova, D., Sobota, J.: An ellipsometric study of Ni, Mo and Ni_xN films deposited on Si. Thin Solid Films 313-314 [1-2] 314-318 (1998).
- Zadražil, M., Frank, L., Müllerová, I.: Rastrovací elektronová mikroskopie nevodivých vzorků. Bulletin CSEM - [9] 33 (1998).

Conference Contributions

- Atrata, R.: Backscatter electron detection in SEM for material science. In: Proceedings of International Symposium of Hybrid Analyses for Functional Nanostructure. (Ed.: Shiojiri, M., Nishio, K.) - Kyoto, Kyoto Institute of Technology 1998, p. 121-124.
- Atrata, R., Jiráček, J., Klvač, M., Romanovský, V.: Detection Of Backscattered Electrons in Environmental SEM. In: Recent Trends in Charged Particle Optics and Surface Physics Instrumentation - 6th Seminar. (Ed.: Müllerová, I., Frank, L.) - Brno, Czechoslovak Society for Electron Microscopy 1998, p. 9-10.
- Atrata, R., Jiráček, J., Klvač, M., Špínka, J.: Detection of BSE signal at higher pressures in the specimen chamber. In: Proceedings of the 14th International Congress on Electron Microscopy. (Ed.: Benavides, H. A. C., Yacamán, M. J.) Vol. 3. - Bristol, Institute of Physics Publishing Ltd. 1998, p. 509-510.
- Atrata, R., Jiráček, J., Michálek, M., Špínka, J.: Amplification of Signal Electrons in Gas Environment. In: Recent Trends in Charged Particle Optics and Surface Physics Instrumentation - 6th Seminar. (Ed.: Müllerová, I., Frank, L.) - Brno, Czechoslovak Society for Electron Microscopy 1998, p. 13-14.
- Atrata, R., Jiráček, J., Michálek, M., Špínka, J.: Conditions for Specimen Observation in Environmental SEM. In: Recent Trends in Charged Particle Optics and Surface Physics Instrumentation - 6th Seminar. (Ed.: Müllerová, I., Frank, L.) - Brno, Czechoslovak Society for Electron Microscopy 1998, p. 15-16.
- Atrata, R., Jiráček, J., Klvač, M., Špínka, J.: Detector of backscattered electrons for environmental SEM. In: Proceedings of the 11th European Congress on Electron Microscopy. Vol. 1. Techniques and Instrumentation. - Brussels, Committee of European Societies of Microscopy 1998, p. 142-143.
- Atrata, R., Jiráček, J., Michálek, M., Špínka, J.: Study of conditions for observation of electrode masses in a higher-pressure scanning electron microscope. In: 22nd Meeting on Electrochemical Power Sources. - Brno, Czech Electrotechnical Society 1998, p. 26-28.
- Atrata, R., Jiráček, J., Špínka, J.: Elektronová mikroskopie vlhkých vzorků. In: Sborník 21. konference o chemických zdrojích proudu s mezinárodní účastí. - Brno, Česká elektrotechnická společnost 1998, p. 32-35.
- Atrata, R., Romanovský, V., Jiráček, J., Klvač, M.: Ionisation Detector for the Environmental SEM. In: Recent Trends in Charged Particle Optics and Surface Physics Instrumentation - 6th Seminar. (Ed.: Müllerová, I., Frank, L.) - Brno, Czechoslovak Society for Electron Microscopy 1998, p. 11-12.
- Atrata, R., Schauer, P.: Single crystal scintillation detectors for LVSEM. In: Proceedings of the 14th International Congress on Electron Microscopy. (Ed.: Benavides, H. A. C., Yacamán, M. J.) Vol. 1.

- General Interest and Instrumentation. - Bristol, Institute of Physics Publishing Ltd. 1998, p. 437-438.
- Autrata, R., Schauer, P., Madea, D.: Single crystal scintillators for BSE detectors in SEM. In: Proceedings of the 11th European Congress on Electron Microscopy. Vol. 1. Techniques and Instrumentation. - Brussels, Committee of European Societies of Microscopy 1998, p. 467-468.
 - El Gomati, M., Müllerová, I., Frank, L.: Combination of Scanning Auger and Very-Low-Energy Electron Microscopy. In: Proceedings of the International Centennial Symposium on the Electron. (Ed.: Kirkland, A., Brown, P. D.) - Cambridge, The University Press 1998, p. 326-333.
 - Frank, L., Müllerová, I.: Diffraction contrast in cathode lens equipped Low-Energy SEM. In: Proceedings of the 11th European Congress on Electron Microscopy. Vol. 1. Techniques and Instrumentation. - Brussels, Committee of European Societies of Microscopy 1998, p. 105-106.
 - Hutař, O.: Noncharging Microscopy of Semiconductor Structures. In: Recent Trends in Charged Particle Optics and Surface Physics Instrumentation - 6th Seminar. (Ed.: Müllerová, I., Frank, L.) - Brno, Czechoslovak Society for Electron Microscopy 1998, p. 32-33.
 - Hutař, O., Autrata, R.: The Separation of Secondary Electrons in Annular and Planar Detectors. In: Recent Trends in Charged Particle Optics and Surface Physics Instrumentation - 6th Seminar. (Ed.: Müllerová, I., Frank, L.) - Brno, Czechoslovak Society for Electron Microscopy 1998, p. 34-35.
 - Jensen, H., Sorensen, G., Sobota, J.: Deposition and Performance Testing of Nanostructured Multilayers. In: Hard Coatings Based on Borides, Carbides & Nitrides: Synthesis, Characterization & Applications. (Ed.: Kumar, A., Chung, Y. W., Chia, R. W. J.) - San Antonio, The Minerals, Metals & Materials Society 1998, p. 35-47.
 - Lencová, B.: New Trends in Software for Electron Optics. In: Recent Trends in Charged Particle Optics and Surface Physics Instrumentation - 6th Seminar. (Ed.: Müllerová, I., Frank, L.) - Brno, Czechoslovak Society for Electron Microscopy 1998, p. 40-43.
 - Lencová, B., Mulvey, T., Tsuno, K.: Computer-aided design of a high resolution magnetic electron lens by first and second order finite element methods. In: Proceedings of the 11th European Congress on Electron Microscopy. Vol. 1. Techniques and Instrumentation. - Brussels, Committee of European Societies of Microscopy 1998, p. 361-362.
 - Matějka, F., Kolařík, V.: ELito Project - New Ways in Electron-Beam Lithography. In: Proceedings of the 5th Electronic Devices and Systems Conference 1998. - Brno, Technical University Brno 1998, p. 366-369.
 - Müllerová, I., Frank, L.: Short Note on Low-Energy SEM Configuration. In: Recent Trends in Charged Particle Optics and Surface Physics Instrumentation - 6th Seminar. (Ed.: Müllerová, I., Frank, L.) - Brno, Czechoslovak Society for Electron Microscopy 1998, p. 53-54.
 - Müllerová, I., Frank, L.: The forming of contrast at low energies in SEM. In: Proceedings of the 11th European Congress on Electron Microscopy. Vol. 1. Techniques and Instrumentation. - Brussels, Committee of European Societies of Microscopy 1998, p. 87-88.
 - Müllerová, I., Frank, L., El Gomati, M.: A compact combined Auger and very low energy electron scanning microscopy. In: Proceedings of the 14th International Congress on Electron Microscopy. (Ed.: Benavides, H. A. C., Yacamán, M. J.) Vol. 1. General Interest and Instrumentation. - Bristol, Institute of Physics Publishing Ltd. 1998, p. 375-376.
 - Müllerová, I., Frank, L., Weimer, E.: Variable Mode Retarding Field Element for Low Energy SEM. In: Recent Trends in Charged Particle Optics and Surface Physics Instrumentation - 6th Seminar. (Ed.: Müllerová, I., Frank, L.) - Brno, Czechoslovak Society for Electron Microscopy 1998, p. 51-52.
 - Müllerová, I., Steklý, R., Hutař, O., Zdražil, M., Frank, L.: Information transfer in SEM micrograph hardcopying. In: Proceedings of the 14th International Congress on Electron Microscopy. (Ed.: Benavides, H. A. C., Yacamán, M. J.) Vol. 1. General Interest and Instrumentation. - Bristol, Institute of Physics Publishing Ltd. 1998, p. 199-200.
 - Pejchl, D., Müllerová, I.: Imaging in Low-Energy SEM equipped with separator of primary and signal electrons. In: Proceedings of the 11th European Congress on Electron Microscopy. Vol. 1. Techniques and Instrumentation. - Brussels, Committee of European Societies of Microscopy 1998, p. 109-110.
 - Schauer, P., Autrata, R.: Cathodoluminescent Properties of Single Crystals for S(T)EM Detectors. In: Recent Trends in Charged Particle Optics and Surface Physics Instrumentation - 6th Seminar. (Ed.: Müllerová, I., Frank, L.) - Brno, Czechoslovak Society for Electron Microscopy 1998, p. 60-63.
 - Schauer, P., Autrata, R.: Performance of YAG:Ce single crystal screens for TEM. In: Proceedings of the 14th International Congress on Electron Microscopy. (Ed.: Benavides, H. A. C., Yacamán, M. J.) Vol. 1. General Interest and Instrumentation. - Bristol, Institute of Physics Publishing Ltd. 1998, p. 633-634.
 - Schauer, P., Autrata, R.: Computer optimized design of BSE scintillation detector for SEM. In: Proceedings of the 11th European Congress on Electron Microscopy. Vol. 1. Techniques and Instrumentation. - Brussels, Committee of European Societies of Microscopy 1998, p. 369-370.
 - Steklý, R., Frank, L., Müllerová, I.: Distributed Monte Carlo: Smart Way for Computing Complex Problem. In: Recent Trends in Charged Particle Optics and Surface Physics Instrumentation - 6th Seminar. (Ed.: Müllerová, I., Frank, L.) - Brno, Czechoslovak Society for Electron Microscopy 1998, p. 77-78.

- Zdražil, M., El Gomati, M.: Measurements of the Secondary and Backscattered Electron Coefficients in the Very Low Energy Range. In: Recent Trends in Charged Particle Optics and Surface Physics Instrumentation - 6th Seminar. (Ed.: Müllerová, I., Frank, L.) - Brno, Czechoslovak Society for Electron Microscopy 1998, p. 82.
- Zdražil, M., El Gomati, M.: Measurements of the secondary and backscattered electron coefficients in the energy range 250-5000eV. In: Proceedings of the 14th International Congress on Electron Microscopy. (Ed.: Benavides, H. A. C., Yacamán, M. J.) Vol. 1. General Interest and Instrumentation. - Bristol, Institute of Physics Publishing Ltd. 1998, p. 495-496.
- Zdražil, M., Frank, L.: Noncharging SEM for biomedical and material research. In: Proceedings of the 11th European Congress on Electron Microscopy. Vol. 1. Techniques and Instrumentation. - Brussels, Committee of European Societies of Microscopy 1998, p. 371-372.
- Zdražil, M., Frank, L., Müllerová, I.: Noncharging scanning electron microscopy of non-conductors at automatically adjusted critical energies. In: Proceedings of the 14th International Congress on Electron Microscopy. (Ed.: Benavides, H. A. C., Yacamán, M. J.) Vol. 1. General Interest and Instrumentation. - Bristol, Institute of Physics Publishing Ltd. 1998, p. 457-458.
- Zdražil, M., Frank, L., Norris, J.: Imaging of Non-Conducting Specimens by Noncharging Scanning Electron Microscopy with Method for Automatically Adjusted Critical Energies. In: Recent Trends in Charged Particle Optics and Surface Physics Instrumentation - 6th Seminar. (Ed.: Müllerová, I., Frank, L.) - Brno, Czechoslovak Society for Electron Microscopy 1998, p. 83-84.

Conference Abstracts

- Chvatil, D., Dupák, J., Finger, M., Finger jr., M., Janata, A., Jarolímek, O., Kracíková, T., Laub, M., Novák, R., Nováková, D., Slunečka, M., Slunečková, V., Sonský, M., Srnka, A., Sulc, M., Šimáně, Č., Vognar, M., Zícha, J.: The CMS Electromagnetic Calorimeter Project. In: Sborník abstrakt Nukleonika '98. - Praha, FJFI ČVUT 1998, p. 24.
- Cubric, D., Lencová, B., Read, F., Zlámal, J.: Comparison of FDM, FEM and BEM for Electrostatic Charged Particle Optics. In: Abstracts of the 5th International Conference on Charged Particle Optics. - Delft, University of Technology 1998, p. 171.
- Dupák, J., Finger, M., Finger jr., M., Hanzelka, P., Horáček, M., Janata, A., Jarolímek, O., Jelínek, J., Kasal, M., Kracíková, T., Laub, M., Linka, A., Novák, R., Nováková, D., Ota, J., Pícek, J., Slunečka, M., Slunečková, V., Sonský, M., Srnka, A., Šulc, M., Virius, M., Vognar, M., Volf, P., Zícha, J.: COMPASS - Common Muon and Proton Apparatus for Structure and Spectroscopy. In: Sborník abstrakt Nukleonika '98. - Praha, FJFI ČVUT 1998, p. 23.
- Dupák, J., Finger, M., Finger jr., M., Janata, A., John, J., Krmar, M., Kumar, K., Kvasil, J., Kracíková, T., Lebedev, N., Pavlov, V., Procházka, I., Slunečka, M., Slunečková, V., Šimečková, E., Yuschkevich, Y.: Low Temperature Nuclear Orientation of Radioactive Nuclei. In: Sborník abstrakt Nukleonika '98. - Praha, FJFI ČVUT 1998, p. 39.
- Frank, L., Müllerová, I., El Gomati, M.: Mini-Column for Low-Energy Electron Imaging in CMA. In: Abstracts of the 5th International Conference on Charged Particle Optics. - Delft, Delft University of Technology 1998, p. 90.
- Jensen, H., Sorensen, G., Sobota, J.: Reactive Sputtering of Nanostructured Multilayer Coatings and their Tribological Properties. In: Abstracts - 6th International Conference on Plasma Surface Engineering. - Düsseldorf, Deutsche Gesellschaft für Galvano- und Oberflächentechnik 1998, p. 300.
- Lencová, B.: Accurate Computation of Magnetic Lenses with Fofem. In: Abstracts of the 5th International Conference on Charged Particle Optics. - Delft, University of Technology 1998, p. 219.
- Matějka, F., Kolařík, V.: Mikrolitografie struktur pro senzoriku a prvky MEMS a OVS. In: Celostátní konference technických univerzit a průmyslu Transfer '98. (Ed.: Strejc, A.) Vol. 1. - Praha, Ediční středisko ČVUT 1998, p. 171-172.
- Muktepavela, F., Manika, I., Jensen, H., Sorensen, G., Sobota, J.: Microhardness Study of the Surface and Bulk Mechanical Properties of Hard Nitride Coatings. In: Abstracts - 6th International Conference on Plasma Surface Engineering. - Düsseldorf, Deutsche Gesellschaft für Galvano- und Oberflächentechnik 1998, p. 200.
- Peřina, V., Jelínek, M., Jurek, K., Sobota, J.: RBS and WDX Characterization of Sputtered Carbon Nitride Films. In: ESCAMPIG 98 - Fourteenth European Conference on the Atomic and Molecular Physics of Ionised Gases - Abstracts of Invited Lectures and Contributed Papers. Vol. 22H. - Belfast, European Physical Society 1998, p. 502-503.

NUCLEAR MAGNETIC RESONANCE

Books & Non-conference Proceedings

- Bartušek, K.: Generace a měření gradientů magnetického pole pro nukleární magnetickou rezonanci. Brno, Ústav přístrojové techniky AV ČR 1998. 142 s.
- Kasal, M.: Moderní metody generace a zpracování signálů nukleární magnetické rezonance - teze habilitační práce. Brno, Vysoké učení technické v Brně 1998.
- Kasal, M.: Moderní metody generace a zpracování signálů nukleární magnetické rezonance - habilitační práce. Brno, Ústav přístrojové techniky AV ČR 1998. 72 s.
- Kasal, M.: Družicové přenosy v radiokomunikacích. In: Říčný, V., Radiové komunikační služby. - Brno, VUT FEI, Ústav radioelektroniky 1998, p. 162-189.

Articles in Journals

- Brázdil, M., Rektor, I., Dufek, M., Jurák, P., Daniel, P.: Effect of Subthreshold Target Stimuli on Event-Related Potentials. *Electroencephalography and Clinical Neurophysiology* 107 64-68 (1998).
- Vondra, V., Wajer, F., Halámek, J., Ormondt van, D.: Influence of Digital Audio Filters on Image Reconstruction in MRI. *Magnetic Resonance Materials in Physics, Biology, and Medicine* 6 70-76 (1998).

Conference Contributions

- Bartušek, K., Vojta, J.: Applications of the Wavelet Transformation in NMR. In: Proceedings of the 8th International IMEKO TC-13 Conference on Measurement in Clinical Medicine: Biomedical Measurement and Instrumentation & 12th International Symposium on Biomedical Engineering. (Ed.: Magrajevic, R.) Vol. 3. - Zagreb, KoREMA 1998, p. 152-154.
- Fiala, P., Konzbul, P.: ANSYS Computation of Eddy Currents Influence at Magnetic Field Shape Checking. In: 6. ANSYS Users Meeting - Sborník přednášek. - Brno, SVS FEM 1998, p. 1-4.
- Gottvald, A.: Inverse Problems and Bayesian Evolutionary Uncertainty: Quantification of MR-Signals in Extreme Conditions. In: Proceedings of the 3rd Japan-Central Europe Joint Workshop on Modelling and Simulation of Non-linear Engineering Systems and Related Phenomena. - Bratislava, Comenius University 1998, p. 281.
- Gottvald, A., Malczyk, R.: Bayesian Evolutionary Optimizations versus Fourier Parameter Estimations in NMR Data Inversions. In: Proceedings of the 3rd Japan-Central Europe Joint Workshop on Modelling and Simulation of Non-linear Engineering Systems and Related Phenomena. - Bratislava, Comenius University 1998, p. 290.
- Halámek, J., Jurák, P., Kasal, M., Villa, M., Cofrancesco, P.: Spurious signals and ADC. In: Proceedings of the 5th Electronic Devices and Systems Conference 1998. - Brno, Technical University Brno 1998, p. 410-413.
- Halámek, J., Kasal, M., Jurák, P., Húsek, V.: Measuring the phase noise of the system clock. In: Conference Proceedings of the 8th International Czech-Slovak Scientific Conference Radioelektronika '98. (Ed.: Svačina, J., Kudják, V.) Vol. 1. - Brno, Technical University Brno 1998, p. 89-92.
- Halámek, J., Kasal, M., Jurák, P., Samek, M.: Signal distortions and sample-and-hold circuit. In: Nové směry v spracovaní signálov IV. - Liptovský Mikuláš, Vojenská akadémia v Liptovskom Mikuláši 1998, p. 166-169.
- Halámek, J., Kasal, M., Jurák, P., Villa, M., Cofrancesco, P.: Frequency Bandwidth of ADC's and Jitter Measurement. In: Proceedings of the 10th International IMEKO TC-4 Symposium on Development in Digital Measuring Instrumentation - ISDDMI '98. (Ed.: Daponte, P., D'Apuzzo, M., Langella, A.) Vol. 1. - Napoli, IMEKO 1998, p. 393-398.
- Hanzelka, P., Bachorec, T.: Nonlinear Transient and Steady State Thermal-Electric Coupled Field Analysis of a Conductor for Cryogenics. In: 1998 ANSYS Conference Proceedings - Simulating Real Life: Software with No Boundaries. (Ed.: Bhashyam, G., Bryan, W., Canann, S., Ostergaard, D.) Vol. 2. - Pittsburgh, ANSYS 1998, p. 245-254.
- Hanzelka, P., Jelínek, J., Musilová, V.: Low-Cost Helium Cryostat for 1.5K. In: Proceedings of the 5th Cryogenics '98 IIR International Conference. Vol. BP9. - Praha, Czech Committee of the International Institute of Refrigeration 1998, p. 92-95.
- Jelínek, J.: Cryogenic Safety Requirements. In: Proceedings of the 5th Cryogenics '98 IIR International Conference. Vol. AP10. - Praha, Czech Committee of the International Institute of Refrigeration 1998, p. 227-231.
- Jurák, P., Halámek, J., Kára, T., Brázdil, M.: The Phase in Biosignal Analysis. In: Proceedings of the 10th International IMEKO TC-4 Symposium on Development

- in Digital Measuring Instrumentation - ISDDMI '98. (Ed.: Daponte, P., D'Apuzzo, M., Langella, A.) Vol. 1. - Napoli, IMEKO 1998, p. 539-542.
- Jurák, P., Haláček, J., Kára, T., Brázdil, M.: The abnormal activities focusing by means of time shifts determination. In: Nové směry v spracování signálů IV. - Liptovský Mikuláš, Vojenská akadémia v Liptovskom Mikuláši 1998, p. 15-18.
 - Jurák, P., Kára, T., Haláček, J.: The coherence of systolic blood pressure and heart rate intervals computation. In: Analysis of Biomedical Signals and Images. Proceedings of the 14-th Biennial International Conference Biosignal '98. (Ed.: Jan, J., Kozumplík, J., Szabó, Z.) - Brno, Technical University Brno Press 1998, p. 130-132.
 - Kasal, M., Haláček, J.: The Equivalent Circuit of the Birdcage Coil. In: Analysis of Biomedical Signals and Images. Proceedings of the 14-th Biennial International Conference Biosignal '98. (Ed.: Jan, J., Kozumplík, J., Szabó, Z.) - Brno, Technical University Brno Press 1998, p. 86-88.
 - Kasal, M., Haláček, J., Samek, M., Húsek, V., Hanousek, K.: Broad Band Quadrature Signal Generator. In: Conference Proceedings of the 8th International Czech-Slovak Scientific Conference Radioelektronika '98. (Ed.: Svačina, J., Kudják, V.) Vol. 1. - Brno, Technical University Brno 1998, p. 85-88.
 - Konzbul, P., Švéda, K., Chládek, J.: Practical Optimization of the MRI Gradient System. In: Mendel '98 - 4th International Mendel Conference on Genetic Algorithms, Optimization Problems, Fuzzy Logic, Neural Networks, Rough Sets. - Brno, Technical University Brno, Faculty of Mechanical Engineering 1998, p. 173-177.
 - Musilová, V., Hanzelka, P., Srnka, A.: Cryostat Pressurisation after Superconducting Magnet Quench. In: Proceedings of the 5th Cryogenics '98 IIR International Conference. Vol. BP5. - Praha, Czech Committee of the International Institute of Refrigeration 1998, p. 82-85.
 - Starčuk, Z., Starčuk jr., Z., Tkáč, I.: In vivo proton MR spectroscopy of the brain: Acquisition of metabolite- or macromolecule-nulled short echo-time MR spectra. In: Proceedings of the 8th International IMEKO TC-13 Conference on Measurement in Clinical Medicine: Biomedical Measurement and Instrumentation & 12th International Symposium on Biomedical Engineering. (Ed.: Magjarevic, R.) - Zagreb, KoREMA 1998, p. 1021-1024.
 - Šebesta, J., Kasal, M.: The Direct Digital Synthesizer with Quadrature Modulation. In: Conference Proceedings of the 8th International Czech-Slovak Scientific Conference Radioelektronika '98. (Ed.: Svačina, J., Kudják, V.) Vol. 1. - Brno, Technical University Brno 1998, p. 81-84.
 - Tkáč, I., Starčuk, Z., Choi, I., Gruetter, R.: Ultra-short Echo-time "dehydrated" in vivo 1H NMR Spectroscopy. In: Proceedings of the International Society for Magnetic Resonance in Medicine. Vol. 3. - Sydney, International Society for Magnetic Resonance in Medicine 1998, p. 1760.
 - Václavík, R., Kasal, M.: Advanced Pulse Modulator for Selective Excitation in MRI and MRS. In: Analysis of Biomedical Signals and Images. Proceedings of the 14-th Biennial International Conference Biosignal '98. (Ed.: Jan, J., Kozumplík, J., Szabó, Z.) - Brno, Technical University Brno Press 1998, p. 83-85.
 - Václavík, R., Kasal, M.: Modulation function generator for quadrature modulator of NMR spectrotomograph. In: Conference Proceedings of the 8th International Czech-Slovak Scientific Conference Radioelektronika '98. (Ed.: Svačina, J., Kudják, V.) Vol. 1. - Brno, Technical University Brno 1998, p. 93-96.
 - Vojta, J., Bartušek, K., Tyc, O.: The Problems of DWT Implementing on DSP. In: Analysis of Biomedical Signals and Images. Proceedings of the 14-th Biennial International Conference Biosignal '98. (Ed.: Jan, J., Kozumplík, J., Szabó, Z.) - Brno, Technical University Brno Press 1998, p. 224-226.
 - Vondra, V., Haláček, J.: Signal preprocessing of digital filtered data before image reconstruction in MRI. In: Analysis of Biomedical Signals and Images. Proceedings of the 14-th Biennial International Conference Biosignal '98. - (Ed.: Jan, J. - Kozumplík, J. - Szabó, Z.) - Brno, Technical University Brno Press 1998, p. 80-82.
 - Vondra, V., Haláček, J., Kasal, M.: Main Sources of Error Signal in DDS Application. In: Proceedings of the 10th International IMEKO TC-4 Symposium on Development in Digital Measuring Instrumentation - ISDDMI '98. (Ed.: Daponte, P., D'Apuzzo, M., Langella, A.) Vol. 1. - Napoli, IMEKO 1998, p. 533-538.

Conference Abstracts

- Bareš, M., Brázdil, M., Jurák, P., Kaňovský, P., Daniel, P.: Změna v pomalých sledovacích očních pohybech u l-dopa naivních pacientů s parkinsonovou chorobou po podání subkutánní injekce apomorfínu. Česká a slovenská neurologie a neurochirurgie 61/94 [1-Suppl.] 26 (1998).
- Bareš, M., Brázdil, M., Jurák, P., Kaňovský, P., Daniel, P.: The Change in Smooth Pursuit Eye Movements in L-dopa-naive Parkinsonian Patients Following Administration of Subcutaneous Apomorphine. Movement Disorders 13 [2-Suppl.] 181 (1998).

- Brázdil, M., Rektor, I., Dufek, M., Jurák, P., Daniel, P.: The Effect of Subthreshold Target Stimuli on Event-Related Potentials. In: The Sixth International Evoked Potentials Symposium - Programme & Abstracts. - Okazaki, National Institute for Physiological Sciences 1998, p. 174.
- Gottvald, A.: Inverse Problems and Bayesian Evolutionary Uncertainty: Quantification of MR-Signals in Extreme Conditions. In: 3rd Japan-Central Europe Joint Workshop on Modelling and Simulation of Non-linear Engineering Systems and Related Phenomena - Abstracts. - Bratislava, Slovak Technical University 1998, p. 71.
- Gottvald, A., Malczyk, R.: Bayesian Evolutionary Optimizations versus Fourier Parameter Estimations in NMR Data Inversions. In: 3rd Japan-Central Europe Joint Workshop on Modelling and Simulation of Non-linear Engineering Systems and Related Phenomena - Abstracts. - Bratislava, Slovak Technical University 1998, p. 72.
- Haláček, J., Kasal, M., Jurák, P., Villa, M., Cofrancesco, P.: Dynamic Range and NMR. In: 13th NMR Valtice. - Brno, The Spectroscopic Society of Johannes Marcus Marci, Central European NMR Discussion Group 1998, p. 24.
- Kára, T., Jurák, P., Šumbera, J., Haláček, J.: The phase shift between blood pressure and heart rate signal, new approach in non-invasive sudden cardiac death stratification. *Journal of Heart Failure* 5 [1] 425 (1998).
- Kára, T., Jurák, P., Toman, J., Souček, M., Haláček, J., Šumbera, J., Špinarová, L., Novák, M., Štejfá, M.: Nové přístupy k hodnocení sympatické aktivace u pacientů s chronickým srdečním selháním. In: Abstrakty - 26. Konferencia komisie experimentálnej kardiológie. - Bratislava, Komisia experimentálnej kardiológie 1998, p. 9.
- Kára, T., Souček, M., Jurák, P., Šumbera, J., Haláček, J., Toman, J., Novák, M.: Nové přístupy k hodnocení sympatické aktivace u pacientů s esenciální hypertenzí. In: 15. konference o arteriální hypertenzi a 7. konference preventivní kardiologie - Abstrakta. - Ostrava, Ústav klinické farmakologie 1998, p. 16.
- Konzbul, P., Švéda, K.: The Gradient Coils for NMR Spectro-Tomographic System. In: 13th NMR Valtice. - Brno, The Spectroscopic Society of Johannes Marcus Marci, Central European NMR Discussion Group 1998, p. 23.
- Konzbul, P., Švéda, K., Fiala, P.: Influence of Eddy Currents on Checking Gradient and Shim Magnetic Field Configurations for MRI. In: Book of Abstracts - Magnetic Measurements '98. - Bratislava, Slovak University of Technology 1998, p. 13.
- Vojta, J., Bartušek, K.: Compression of MR images. *Magnetic Resonance Materials in Physics, Biology, and Medicine* 6 [1-Suppl.] 150 (1998).

COHERENT OPTICS

Articles in Journals

- Navrátil, V., Fodreková, A., Gata, R., Blabla, J., Balling, P., Ziegler, M., Zelený, V., Petrů, F., Lazar, J., Veselá, Z., Gliwa-Gliwinski, J., Walczuk, J., Bánréti, E., Tomanyiczka, K., Chartier, A., Chartier, J.: International comparisons of He-Ne lasers stabilized with 12712 at $\lambda=633$ nm (July 1993 to September 1995). *Metrologia* 35 [6] 799-806 (1998).
- Petrů, F., Číp, O., Sparrer, G., Herrmann, K.: Methoden zur Messung der Brechzahl der Luft. *Jemná mechanika a optika* 43 [11-12] 348-356 (1998).
- Zemánek, P., Foot, C.: Atomic dipole trap formed by blue detuned strong Gaussian standing wave. *Optics Communications* 146 [Jan15] 119-123 (1998).
- Zemánek, P., Jonáš, A., Šrámek, L., Liška, M.: Optical trapping of Rayleigh particles using a Gaussian standing wave. *Optics Communications* 151 [Jun1] 273-285 (1998).

Conference Contributions

- Jonáš, A., Šrámek, L., Liška, M., Zemánek, P.: Efficient Particle Trapping Using an Upward Reflected Laser Beam. In: Proceedings of the Photoconversion: Science and Technologies (Proc. SPIE 3580). (Ed.: Maksymilian, P.) - Washington, SPIE-The International Society for Optical Engineering 1998, p. 91-100.
- Šrámek, L., Jonáš, A., Liška, M., Zemánek, P.: Laser Trapping of Micron Sized Objects: Theory and Experiment. In: Proceedings of the Photoconversion: Science and Technologies (Proc. SPIE 3580). (Ed.: Maksymilian, P.) - Washington, SPIE-The International Society for Optical Engineering 1998, p. 82-89.
- Zemánek, P., Foot, C.: Atomic Dipole Trap Formed by a Gaussian Standing Wave. In: Proceedings of the Photoconversion: Science and Technologies (Proc. SPIE 3580). (Ed.: Maksymilian, P.) - Washington, SPIE-The International Society for Optical Engineering 1998, p. 102-110.

Year of publication: 1999

ELECTRON OPTICS

Articles in Journals

- Cubric, D., Lencová, B., Read, F., Zlámal, J.: Comparison of FDM, FEM and BEM for electrostatic charged particle optics. *Nuclear Instruments and Methods in Physics Research, A* 427 [1] 357-362 (1999).
- Deineka, A., Tarasenko, A., Jastrabík, L., Chvostova, D., Boušek, J.: An ellipsometric study of W thin films deposited on Si. *Thin Solid Films* 339 [1-2] 216-219 (1999).
- Dupák, J., Klíčník, M., Ustohal, V.: Pájení tvárnými aktivními pájkami. *Zváranie-Svařování* 48 [6] 130-132 (1999).
- Dupák, J., Vlček, I.: Elektronové dělo pro svařování v přístrojové technice. *Jemná mechanika a optika* 44 [7-8] 239-241 (1999).
- Frank, L., Müllerová, I.: Strategies for low- and very-low-energy SEM. *Journal of Electron Microscopy* 48 [3] 205-219 (1999).
- Frank, L., Müllerová, I., Faulian, K., Bauer, E.: The Scanning Low-Energy Electron Microscope: First Attainment of Diffraction Contrast in the Scanning Electron Microscope. *Scanning* 21 [1] 1-13 (1999).
- Jelínek, M., Kulisch, W., Delplancke-Ogletree, M., Vorlíček, V., Studnička,., Chvostová, D., Trchová, M., Sobota, J.: Application-relevant characterization of magnetron-sputtered carbon nitride films. *Diamond and Related Materials* 8 1857-1862 (1999).
- Lencová, B.: Accurate computation of magnetic lenses with FOFEM. *Nuclear Instruments and Methods in Physics Research, A* 427 [1] 329-337 (1999).
- Romanovský, V., Aufrata, R.: Scintillation and Ionisation Detectors for Environmental SEM. *European Microscopy and Analysis* [59] 19 (1999).

Conference Contributions

- Aufrata, R., Jiráček, J., Špínka, J.: Rastrovací elektronový mikroskop pracující s vyššími tlaky v komoře vzorku. In: *Sborník vyzvaných přednášek a posterových příspěvků Transfer '99*. - Brno, Vysoké učení technické v Brně 1999, p. C1-C2.
- Aufrata, R., Jiráček, J., Špínka, J.: Vliv prostředí na detekci signálu v REM pracujícím při vyšším tlaku. In: *Sborník vyzvaných přednášek a posterových příspěvků Transfer '99*. - Brno, Vysoké učení technické v Brně 1999, p. C3-C4.
- Aufrata, R., Jiráček, J., Špínka, J.: Detection of SEs and BSEs at Higher Pressure. In: *Proceedings of the 4th Multinational Congress on Electron Microscopy*. - Veszprém, University of Veszprém 1999, p. 285-286.
- Aufrata, R., Jiráček, J., Špínka, J.: Signal detection in SEM at higher pressure. In: *1st Congress of the Croatian Society for Electron Microscopy*. - Zagreb, Croatian Society for Electron Microscopy 1999, p. 63-64.
- Aufrata, R., Jiráček, J., Špínka, J.: Scanning electron microscopy at higher pressure. In: *1st Congress of the Croatian Society for Electron Microscopy*. - Zagreb, Croatian Society for Electron Microscopy 1999, p. 75-77.
- Aufrata, R., Jiráček, J., Špínka, J., Romanovský, V.: Environmental scanning electron microscopy for the study of wet specimens. In: *Proceedings of the 4th Multinational Congress on Electron Microscopy*. - Veszprém, University of Veszprém 1999, p. 105-111.
- Frank, L., Steklý, R., Zdražil, M., El Gomati, M., Müllerová, I.: To the information depth of backscattered electron signal. In: *Proceedings of the 4th Multinational Congress on Electron Microscopy*. - Veszprém, University of Veszprém 1999, p. 315-316.
- Horáček, M.: Direct Detection of Electrons by Area Array CCD. In: *Conference Proceedings of the 9th International Czech-Slovak Scientific Conference Radioelektronika '99*. - Brno, Brno University of Technology, Institute of Radio Electronics 1999, p. 78-81.
- Hutáň, O.: Plazmochemické technologie pro výrobu IO. In: *Škola vákuové techniky 1999*. (Ed.: Dubravcová, V., Řepa, P.) - Bratislava, Slovenská technická univerzita 1999, p. 31-41.
- Hutáň, O.: The imaging using a cathode lens in LVSEM. In: *Proceedings of the 4th Multinational Congress on Electron Microscopy*. - Veszprém, University of Veszprém 1999, p. 169-167.
- Hutáň, O., Aufrata, R., Romanovský, V.: Simple BSE detector for LVSEM. In: *Proceedings of the 4th Multinational Congress on Electron Microscopy*. - Veszprém, University of Veszprém 1999, p. 325-326.
- Káňová, J.: Scintilační detektor sekundárních elektronů s brzdným polem. In: *Sborník vyzvaných přednášek a posterových příspěvků Transfer '99*. - Brno, Vysoké učení technické v Brně 1999, p. C15-C16.

- Klvač, M., Jiráček, J.: Detector for Backscattered Electrons in Environmental SEM. In: Proceedings of the 4th Multinational Congress on Electron Microscopy. - Veszprém, University of Veszprém 1999, p. 335-336.
- Matějka, F., Kolařík, V.: Metrické normály pro elektronovou a optickou mikroskopii připravované pomocí elektronové litografie. In: Sborník vyzvaných přednášek a posterových příspěvků Transfer '99. - Brno, Vysoké učení technické v Brně 1999, p. C21-C22.
- Müllerová, I.: Low Voltage Electron Microscopy. In: Proceedings of the 4th Multinational Congress on Electron Microscopy. - Veszprém, University of Veszprém 1999, p. 99-104.
- Romanovský, V., Aufrata, R.: Nové možnosti využití rastrovacích mikroskopů. In: Sborník vyzvaných přednášek a posterových příspěvků Transfer '99. - Brno, Vysoké učení technické v Brně 1999, p. C33-C34.
- Romanovský, V., Aufrata, R.: Use of ionisation detectors in environmental SEM. In: Proceedings of the 4th Multinational Congress on Electron Microscopy. - Veszprém, University of Veszprém 1999, p. 359-360.
- Romanovský, V., Aufrata, R., Hutař, O.: Voltage contrast imaging in environmental SEM. In: Proceedings of the 4th Multinational Congress on Electron Microscopy. - Veszprém, University of Veszprém 1999, p. 357-358.
- Ryzí, Z., Fiala, P., Matějka, F.: Blazed diffractive structures produced by scanning methods. In: EOS Topical Meetings Digest Series Vol. 22: Diffractive Optics - Jena '99. - Jena, Electron Optical Society 1999, p. 193-194.
- Schauer, P., Aufrata, R.: Study of TEM fluorescent screens. In: Proceedings of the 4th Multinational Congress on Electron Microscopy. - Veszprém, University of Veszprém 1999, p. 167-168.
- Sobota, J.: Vrstvy pro aplikaci ve strojírenství. In: Škola vákuové techniky 1999. (Ed.: Dubravcová, V., Řepa, P.) - Bratislava, Slovenská technická univerzita 1999, p. 6-12.

Conference Abstracts

- Frank, L., Zdražil, M., Müllerová, I.: Automatically Adjustable Optimum Energy Mode for Minimum-Charging SEM of Non-Conductors. In: Book of Abstracts EMAS '99 - 6th European Workshop on Modern Developments and Applications in Microbeam Analysis. - Konstanz, European Microbeam Analysis Society 1999, p. 309.
- Sobota, J., Sorensen, G., Jensen, H., Kubina, J., Holý, V.: Temperature stability of C-N/NbN nanocomposite multilayers. In: Abstract Book of the 10th European Conference on Diamond, Diamond-Like Materials, Carbon Nanotubes, Nitrides and Silicon Carbide. - Prague, Elsevier Science 1999, p. 5.425.
- Steklý, R., Zdražil, M., El Gomati, M., Frank, L., Müllerová, I.: Surface Cleanliness and Electron Backscattering. In: Book of Abstracts EMAS '99 - 6th European Workshop on Modern Developments and Applications in Microbeam Analysis. - Konstanz, European Microbeam Analysis Society 1999, p. 344.
- Škoda, P., Ustohal, V., Dupák, J.: Spojení hliníku se stříbrem a mědí pro vakuovou techniku. In: Přínos metalografie pro řešení výrobních problémů - sborník přednášek. - Ostrava, Tanger 1999, p. 153-156.

NUCLEAR MAGNETIC RESONANCE

Books & Non-conference Proceedings

- Gottvald, A.: Sec. 3.1 - Optimizing Axisymmetric Coils Systems for NMR. In: Electromagnetic Phenomena and Inverse Problems. (Ed.: Kojima, F., Uesaka, M.) - Tokyo, Yokendo 1999, p. 58-73.
- Gottvald, A.: Sec. 5.2 - Meta-Evolutionary Optimization and Inverse Problems. In: Electromagnetic Phenomena and Inverse Problems. (Ed.: Kojima, F., Uesaka, M.) - Tokyo, Yokendo 1999, p. 125-139.

Articles in Journals

- Dokoupil, Z.: Personal Computer Debug Port. Journal of Electrical Engineering 50 [3-4] 102-105 (1999).
- Hanzelka, P., Dupák, J.: Studie heliové kryovývěvy pro elektronově optické přístroje. Jemná mechanika a optika 44 [4] 108-110 (1999).

- Hanzelka, P., Horký, J.: Problems of measurement of the helium boil of rate of tomographic magnets. *Cryogenics* 39 [7] 647-649 (1999).
- Jurák, P., Halánek, J., Kára, T., Davies, L., Francis, D., Souček, M., Toman, J., Šumbera, J.: Immediate baroreflex sensitivity - new approach to this parameter. *Medical & Biological Engineering & Computing* 37 [Supplement 2] 496-497 (1999).
- Kára, T., Jurák, P., Halánek, J., Souček, M., Francis, D., Davies, L., Toman, J., Samek, M.: Frequency and depth of breathing - important signals at autonomic nervous system analysis. *Medical & Biological Engineering & Computing* 37 [Supplement 2] 1310-1311 (1999).
- Musilová, V., Hanzelka, P., Jelínek, J.: Dosahování nízkých teplot odčerpáváním par. *Héliový kryostat 1,5K. Jemná mechanika a optika* 44 [4] 111-115 (1999).
- Tkáč, I., Starčuk, Z., Choi, I., Gruetter, R.: In Vivo 1H NMR Spectroscopy of Rat Brain at 1ms Echo Time. *Magnetic Resonance in Medicine* 41 [4] 649-656 (1999).

Conference Contributions

- Bartušek, K., Buřival, Z., Hanáková, D.: Methodology of Measurement of Air Ions in Moist Environment for Speleotherapy. In: *Proceedings of the 2nd International Conference on Measurement - Measurement '99.* (Ed.: Frollo, I., Plačková, A.) - Bratislava, Institute of Measurement Science, Slovak Academy of Sciences 1999, p. 262-265.
- Chládek, J., Konzbul, P., Ošmera, P., Gottvald, A.: Optimization of NMR Coils using Evolutionary and Genetic Algorithms. In: *Mendel '99 - 5th International Conference on Soft Computing.* - Brno, Brno University of Technology, Faculty of Mechanical Engineering 1999, p. 15-17.
- Chládek, J., Konzbul, P., Ošmera, P., Gottvald, A.: Evolutionary and Genetic Optimization of NMR Gradient and Shim Coils. In: *Proceedings of the 12th Conference on the Computation of Electromagnetic Fields - COMPUMAG.* - Sapporo, Hokkaido University 1999, p. 840-841.
- Chládek, J., Konzbul, P., Ošmera, P., Gottvald, A.: Optimization of NMR Gradient and Shim Coils Using Evolutionary Algorithms. In: *Digests of the Joint Seminar '99.* - Sapporo, Hokkaido University 1999, p. 22-23.
- Gottvald, A.: Bayesian Evolutionary Inversions in Computational Electromagnetics. In: *Proceedings of the 12th Conference on the Computation of Electromagnetic Fields - COMPUMAG.* - Sapporo, Hokkaido University 1999, p. 302-303.
- Gottvald, A.: Bayesian Evolutionary Optimization. In: *Mendel '99 - 5th International Conference on Soft Computing.* - Brno, Brno University of Technology, Faculty of Mechanical Engineering 1999, p. 30-35.
- Gottvald, A.: On Bayesian Spectral Electromagnetics - I. In: *Digests of the Joint Seminar '99.* - Sapporo, Hokkaido University 1999, p. 101-102.
- Gottvald, A.: On Bayesian Spectral Electromagnetics - II. In: *Digests of the Joint Seminar '99.* - Sapporo, Hokkaido University 1999, p. 103-104.
- Halánek, J., Kasal, M., Húsek, V.: Maximal Dynamic Range - Its Limitation. In: *Conference Proceedings of the 9th International Czech-Slovak Scientific Conference Radioelektronika '99.* - Brno, Brno University of Technology, Institute of Radio Electronics 1999, p. 229-232.
- Halánek, J., Kasal, M., Jurák, P., Villa, M., Cofrancesco, P.: The ADC and maximal dynamic range. In: *Proceedings of the 4th International Workshop on ADC Modelling and Testing - IWADC '99.* - Bordeaux, IMEKO TC-4 1999, p. 227-231.
- Konzbul, P.: Practical Aspects of Some Designing Methods for NMR Shim Coils. In: *Digests of the Joint Seminar '99.* - Sapporo, Hokkaido University 1999, p. 16-17.
- Konzbul, P., Švéda, K.: Measurement of Magnetic Field of Matrix Shim Systems for MRI. In: *Proceedings of the 2nd International Conference on Measurement - Measurement '99.* (Ed.: Frollo, I., Plačková, A.) - Bratislava, Institute of Measurement Science, Slovak Academy of Sciences 1999, p. 76-78.
- Konzbul, P., Švéda, K.: Matrix coils for magnetic resonance imaging. In: *AMTEE '99 - 4rd International Conference on Advanced Methods in the Theory of Electrical Engineering applied to power systems.* - Plzeň, University of West Bohemia 1999, p. A28-A31.
- Konzbul, P., Švéda, K.: Modified Matrix Inversion Design Method for Cylindrical NMR Coils. In: *Proceedings of the 12th Conference on the Computation of Electromagnetic Fields - COMPUMAG.* - Sapporo, Hokkaido University 1999, p. 68-69.
- Konzbul, P., Švéda, K.: Design and Optimisation of Matrix Shim Coils for NMR and MRI. In: *Proceedings of the 12th Conference on the Computation of Electromagnetic Fields - COMPUMAG.* - Sapporo, Hokkaido University 1999, p. 860-861.
- Konzbul, P., Švéda, K., Chládek, J.: Optimum Design of Axial Matrix Shim Coils for NMR. In: *Mendel '99 - 5th International Conference on Soft Computing.* - Brno, Brno University of Technology, Faculty of Mechanical Engineering 1999, p. 162-164.

- Konzbul, P., Švéda, K., Chládek, J., Srnka, A.: Axial Super Shim Coils System for MRI. In: Digests of the Joint Seminar '99. - Sapporo, Hokkaido University 1999, p. 18-19.
- Krejčí, I.: Experience with Application and Programming of Analog Devices' DSPs in Automation and Instrumentation of Physical Experiments. In: Conference Proceedings of the 9th International Czech-Slovak Scientific Conference Radioelektronika '99. - Brno, Brno University of Technology, Institute of Radio Electronics 1999, p. 213-216.
- Matys, K., Gottvald, A.: On Wavelet Transform in Generalized NMR Spectroscopy. In: Digests of the Joint Seminar '99. - Sapporo, Hokkaido University 1999, p. 105-106.
- Starčuk, Z., Tkáč, I., Starčuk jr., Z., Horký, J., Gruetter, R.: Measurement of macromolecule or metabolite nulled in vivo proton NMR spectra of the rat brain. In: ISMRM - 7th Scientific Meeting and Exhibition. - Philadelphia, International Society for Magnetic Resonance in Medicine 1999, p. 1582.
- Viščor, I., Halánek, J.: DSP and Digital Down Conversion. In: Conference Proceedings of the 9th International Czech-Slovak Scientific Conference Radioelektronika '99. - Brno, Brno University of Technology, Institute of Radio Electronics 1999, p. 225-228.

Conference Abstracts

- Gottvald, A.: Bayesian Evolutionary Inversions in Biomedical MR-Spectroscopy. In: Conference Digest - International Symposium on Non-Linear Electromagnetic System. - Pavia, University of Pavia 1999, p. 90.
- Gottvald, A.: Aharonov-Bohm Effect and Vector Potential: How Weird for Bayesians? In: Conference Digest - International Symposium on Non-Linear Electromagnetic System. - Pavia, University of Pavia 1999, p. 149.
- Horký, J.: Zpráva o posouzení technického stavu magnetu NMR tomografu GE Signa 1,5T umístěného na MR pracovišti RDG oddělení ÚVN, U vojenské nemocnice 1200, 169 02 Praha 6. Brno, Ústav přístrojové techniky AV ČR 1999.
- Horký, J.: Zpráva o posouzení technického stavu NMR tomografu Elscint Gyrex 2T - Prestige umístěného na MR pracovišti Radiodiagnostické kliniky FN KV, Šrobárova 50, 100 34 Praha 10. Brno, Ústav přístrojové techniky AV ČR 1999.
- Horký, J.: Protokol o měření odparu He ze supravodivého magnetu NMR tomografu Siemens Symphony v.č.13102 umístěného na MR pracovišti kliniky zobrazovacích technik FN u sv. Anny, Pekařská 53, 656 91 Brno. Brno, Ústav přístrojové techniky AV ČR 1999.
- Kára, T., Jurák, P., Halánek, J., Souček, M., Šumbera, J., Novák, M., Toman, J.: Spirometr ANNA 1, hloubka dýchání a baroreflexní senzitivita srdeční frekvence. *Cor et Vasa* 41 [4-Suppl.] 29 (1999).
- Kára, T., Jurák, P., Halánek, J., Souček, M., Šumbera, J., Novák, M., Toman, J.: A Spirometre ANNA 1, Depth of Breathing and Autonomic Nervous System. *Pacing and Clinical Electrophysiology* 22 [6-Part II] A79 (1999).
- Kára, T., Jurák, P., Novák, M., Souček, M., Nováková, Z., Halánek, J., Šumbera, J., Toman, J., Štejf, M., Řiháček, I.: Sudden Cardiac Death Risk Stratification Based on Phase Shift and XYt Graph Methods. *Pacing and Clinical Electrophysiology* 22 [6-Part II] A20 (1999).
- Kára, T., Jurák, P., Nováková, Z., Halánek, J., Novák, M., Šumbera, J., Toman, J.: Hodnocení vlivu autonomního nervového systému na srdeční frekvenci a krevní tlak metodami fázového posuvu a XYt grafem. *Cor et Vasa* 41 [4-Suppl.] 29 (1999).
- Kára, T., Jurák, P., Souček, M., Halánek, J., Novák, M., Šumbera, J., Toman, J., Štejf, M., Nováková, Z., Řiháček, I.: Depth of Breathing and Baroreflex Sensitivity. *American Journal of Hypertension* 12 [4-P2] D004 (1999).
- Kára, T., Jurák, P., Souček, M., Halánek, J., Novák, M., Šumbera, J., Toman, J., Štejf, M., Nováková, Z., Řiháček, I.: Evaluation of Autonomic Nervous System Dysfunction by Phase Shift and XYt Graph Methods. *American Journal of Hypertension* 12 [4-P2] D005 (1999).
- Kára, T., Jurák, P., Souček, M., Novák, M., Nováková, Z., Halánek, J., Šumbera, J., Toman, J., Štejf, M., Řiháček, I.: Time delay stability of baroreflex feedback system and autonomic nervous system dysfunction. *Journal of Hypertension* 17 [3-Suppl.] S44 (1999).
- Kára, T., Jurák, P., Souček, M., Novák, M., Nováková, Z., Halánek, J., Šumbera, J., Toman, J., Štejf, M., Řiháček, I.: Time delay stability of Baroreflex feedback system and autonomic nervous system dysfunction. *European Heart Journal* 20 [Supplement] 443 (1999).
- Kára, T., Jurák, P., Souček, M., Toman, J., Halánek, J., Špinarová, I., Novák, M., Šumbera, J., Štejf, M., Nováková, Z., Řiháček, I.: The Influence of Atrial Mechanisms on Heart Rate of Patients with Essential Hypertension. *American Journal of Hypertension* 12 [4-P2] E028 (1999).
- Kára, T., Novák, M., Jurák, P., Halánek, J., Nováková, Z., Souček, M., Šumbera, J., Homolka, P.: Změny vegetativní regulace krevního tlaku u pacientů s vazodilatorickým typem neurokardiogenní synkopy. *Cor et Vasa* 41 [4-Suppl.] 29-30 (1999).

- Mynárik, V., Gruber, S., Starčuk, Z., Starčuk jr., Z., Moser, E.: Short echo time MR spectroscopy of human brain at 3 Tesla using asymmetric pulses. *Magnetic Resonance Materials in Physics, Biology, and Medicine* 8 [1-Suppl.] 231-232 (1999).
- Souček, M., Kára, T., Jurák, P., Toman, J., Halánek, J., Špinarová, L., Šumbera, J., Štejf, M., Řiháček, I., Meluzín, J.: The influence of atrial mechanisms on heart rate in patients with essential hypertension. *Journal of Hypertension* 17 [3-Suppl.] S285 (1999).
- Souček, M., Kára, T., Novák, M., Jurák, P., Halánek, J., Nováková, Z., Šumbera, J., Homolka, P., Toman, J., Štejf, M., Řiháček, I.: Changes in autonomic regulation of blood pressure in patients with vasodepressor type of vasovagal syncope. *Journal of Hypertension* 17 [3-Suppl.] S47 (1999).
- Starčuk, Z., Horký, J., Starčuk jr., Z.: Some Aspects of in vivo ¹H NMR Spectroscopy. In: 14th NMR Valtice. - Brno, Masarykova univerzita 1999, p. 33.

COHERENT OPTICS

Articles in Journals

- Petrů, F., Číp, O.: Problems regarding linearity of data of a laser interferometer with a single-frequency laser. *Precision Engineering* 23 [1] 39-50 (1999).

Conference Contributions

- Číp, O., Petrů, F.: The compensation method for the scale linearization of the high precision laser interferometer. In: *Proceedings of the Wave and Quantum Aspects of Contemporary Optics (Proc. SPIE 3820) - 11th Slovak-Czech-Polish Optical Conference*. (Ed.: Hrabovský, M., Štrba, A., Urbanczyk, W.) - Washington, SPIE-The International Society for Optical Engineering 1999, p. 144-153.
- Jonáš, A., Šrámek, L., Liška, M., Zemánek, P.: Theoretical study of the optical forces and other characteristic parameters in the standing wave trap. In: *Proceedings of the Wave and Quantum Aspects of Contemporary Optics (Proc. SPIE 3820) - 11th Slovak-Czech-Polish Optical Conference*. (Ed.: Hrabovský, M., Štrba, A., Urbanczyk, W.) - Washington, SPIE-The International Society for Optical Engineering 1999, p. 70-76.
- Zemánek, P., Jonáš, A.: Employment of Gaussian standing wave for optical trapping of nanoparticles and microparticles. In: *Digests of the Joint Seminar '99*. - Sapporo, Hokkaido University 1999, p. 20-21.
- Zemánek, P., Šrámek, L., Jonáš, A., Moravčík, Z., Janisch, R., Liška, M.: Standing wave trap and single beam gradient optical trap - experiments and biological applications. In: *Proceedings of the Wave and Quantum Aspects of Contemporary Optics (Proc. SPIE 3820) - 11th Slovak-Czech-Polish Optical Conference*. (Ed.: Hrabovský, M., Štrba, A., Urbanczyk, W.) - Washington, SPIE-The International Society for Optical Engineering 1999, p. 401-410.

Conference Abstracts

- Ják, P., Jonáš, A., Lazar, J., Číp, O., Harna, Z., Zemánek, P., Liška, M., Tománek, P.: Measurement of submicron laser beam profiles using nanoprobe. In: *Programme and Book of Abstracts of the 3rd International Conference Photonics '99*. - Praha, Czech and Slovak Society for Photonics 1999, p. 96.
- Ježek, J., Jedlička, P., Zemánek, P., Liška, M.: Applications of combined cutting and multiple-beam trapping optical system. In: *Programme and Book of Abstracts of the 3rd International Conference Photonics '99*. - Praha, Czech and Slovak Society for Photonics 1999, p. 95.

Design and printed by Reklamní atelier Kupka