

**Institute of Scientific Instruments
of the CAS, v. v. i.**
The Czech Academy of Sciences
Královopolská 147, 612 64 Brno,
Czech Republic
<http://ebt.isibrno.cz/en/about-us>

Head: Dr. Tomáš Fořt
Phone: +420 541 514 339
E-mail: fortt@isibrno.cz

Expert: Dr. Jaroslav Sobota
Phone: +420 541 514 256
E-mail: sobota@isibrno.cz



*Computer controlled magnetron
sputtering system Aurion*

Aurion chamber

THEMATIC RESEARCH FOCUS

Research area

Deposition of thin films by magnetron sputtering and their dynamic impact testing



Excellence

- Multilayer x-ray and EUV optics
- Precise Au/Fe/Au nanostructures as a tool to magnetic field sensing
- Self-organized growth of nanocrystals
- Dynamic impact testing of thin films

Mission

Search for new practical application of well – handled technologies, e.g. deposition of x-ray and EUV optics, in particular in new brand of industry (space research), development of unique instruments, and last but not least, the technological support of existing teams on this institute.

UP-TO-DATE ACTIVITIES

Research orientation & focus

- Creation and characterization of nanolayers used in soft x-ray lasers
- Deposition of precise Au/Fe/Au nanostructures as a tool to magnetic field sensing
- Deposition of thermally stable nanostructured DLC coatings
- Coating technology of thin passivation and antireflection layers, production of crystalline solar cells
- Deposition of multilayer x-ray and EUV optics
- Dynamic impact testing of thin films

Main capabilities

Basic research

- Study of self-organized growth of nanocrystals
- Study of structures intended as magnetic field sensors
- Study of mechanisms of dynamic impact wear of films / substrate systems

Applied research

- New types and features of the multilayer x-ray and EUV optics
- Electrochemical sensors
- Solar cells
- Wear resistant coatings in automotive industry

Fields of group activities

- Material science (study of coating/substrate system under dynamical load)
- Measuring instruments (construction of impact testers and microfluidic apparatus)
- Renewable energy (Solar cells)
- Automotive industry (Wear resistant coatings in automotive industry)
- Optics (multilayer x-ray and EUV optics)

KEY RESEARCH EQUIPMENT

List of devices

- Computer controlled magnetron sputtering system Aurion equipped with two r.f. and one DC magnetrons 152 mm in diameter enabling development and production of the multilayer x-ray and EUV optics
- Magnetron sputtering system Leybold Heraeus - Z550 equipped with three r.f. magnetrons 152 mm in diameter enabling development and production of the wear resistant coatings
- Magnetron sputtering system equipped with one r.f. magnetron 76 mm in diameter enabling development and production of the electrochemical detectors
- Confocal microscope Olympus 3100 (magnification max. 14.400x)

- Calotest - CSM Instruments
- Impact tester for evaluating impact resistance of coating/substrate system
- Disc polishing and grinding machine MTH kompakt 1031 + head APX010

ACHIEVEMENTS

Our group is one of a few laboratories in Europe capable to produce multilayered systems with an exactly defined individual layer thickness, which can be used for x-ray or EUV optics. The repeatability of the bilayer thickness of the Mo/Si multilayer is better than 0,1 nm. We master also deposition of x-ray or EUV optic elements composed of different materials, such as Sc/Si, Ni/C or C/Si with the same repeatability.

- V. V. Protopov, J. Sobota: "X-ray dark-field refraction-contrast imaging of micro-objects", OPTICS COMMUNICATIONS **213**, 4–6, 267–279
- K. Kolářek, J. Štraus, J. Schmidt, O. Frolov, V. Prukner, A. Shukurov, V. Holy, J. Sobota, T. Fořt : "Nano-structuring of solid surface by extreme ultraviolet Ar8+ laser", LASER AND PARTICLE BEAMS **30**, 1, 57–63
- K. Jakubczak, T. Mocek, B. Rus, J. Polan, J. Hřebíček, M. Sasická, P. Sikocinski, J. Sobota, T. Fořt, L. Pina: "Beam properties of fully optimized, table-top, coherent source at 30 nm", OPTO-ELECTRONICS REVIEW **19**, 2, 169–175
- J. Krčmář, V. Holý, L. Horák, TH. Metzger, J. Sobota: "Standing-wave effects in grazing-incidence x-ray diffraction from polycrystalline multilayers", JOURNAL OF APPLIED PHYSICS **103**, 3

Our group is one of a few laboratories in Europe capable to evaluate impact resistance of coating-substrate system using impact tester developed in our laboratory in collaboration with Brno University of Technology.

- J. Sobota, J. Grossman, V. Bursiková, L. Dupák, J. Vyskočil: "Evaluation of hardness, tribological behaviour and impact load of carbon-based hard composite coatings exposed to the influence of humidity", DIAMOND AND RELATED MATERIALS **20**, 4, 596–599
- T. Fořt, T. Vitu, R. Novák, J. Grossman, J. Sobota, J. Vyskočil: „Testing of the impact load and tribological behaviour of w-c:h hard composite coatings“, CHEMICKE LISTY **105**, Special Issue: SI Supplement: 2, 102-104

Our group was one of a few laboratories discovering nanocomposite principle applied on thin films. We find possibility to use this principle in practical use and at present we participate in this field in industrially oriented research.

- V. Vorlíček, P. Šíroky, J. Sobota, V. Peřina, V. Železný, J. Hrdina: "C:N and C:N:O films: Preparation and properties", DIAMOND AND RELATED MATERIALS **5**, 3–5, 570–574, 1996
- H. Jensen, J. Sobota, G. Sorensen: "A study on film growth and tribological characterization of nanostructured C-N/TiNx multilayer coatings", SURFACE & COATINGS TECHNOLOGY **94–5**, 1–3, 174–178, 1997
- J. Sobota, G. Sorensen, H. Jensen, J. Kubena, V. Holý: "Temperature stability of C-N/NbN nanocomposite multilayers", DIAMOND AND RELATED MATERIALS **9**, 3–6, 587–591, 2000
- J. Sobota, Z. Bochníček, V. Holý: "Friction and wear properties of C-N/MeNx nanolayer composites", THIN SOLID FILMS **433**, 1–2, 155–159, 2003
- J. Sobota, J. Grossman, V. Bursiková, L. Dupák, J. Vyskočil: "Evaluation of hardness, tribological behaviour and impact load of carbon-based hard composite coatings exposed to the influence of humidity", DIAMOND AND RELATED MATERIALS **20**, 4, 596–599, 2011



Cross section of the Si/C multilayer on silicon substrate



Impact tester in chamber with controlled atmosphere

MAIN COLLABORATING PARTNERS

Collaboration with academic partners

- Masaryk University (Brno, CZ)
- Institute of Physics of Materials of the ASCR, v.v.i. (Brno, CZ)
- University of West Bohemia (Plzeň, CZ)
- Institute of Physics of the ASCR, v.v.i. (Praha, CZ)
- Institute of Photonics and Electronics (Praha, CZ)
- Czech Technical University in Praha (Praha, CZ)
- Charles University (Praha, CZ)
- Institute of Plasma Physics (Praha, CZ)
- Tomas Bata University (Zlín, CZ)
- PALS – Prague asterix laser system (Praha, CZ)
- The University of Sheffield (Sheffield, UK)
- Aristoteles University of Thessaloniki, (Thessaloniki, Greece)

Collaboration with companies

- Solartec s.r.o. (Rožnov pod Radhoštěm, CZ)
- HVM Plasma Ltd. (Praha, CZ)
- Rigaku Innovative Technologies Europe, s.r.o. (Praha, CZ)
- Czech Metrology Institute (Brno, CZ)
- VUHZ a.s. (Dobrá, CZ)
- Research and Testing Institute (Plzeň, CZ)

EXPECTATIONS

Offers

- We offer testing of functional properties of thin coating under dynamic load, development and deposition of new types and features of the multilayer x-ray and EUV optics, coatings used in photovoltaic solar cells, etc.
- Partnership in international projects

Requirements

We look for cooperation with academic partners as well as companies in the fields of EUV and x-ray optics, photovoltaic solar cells, testing of thin films.



Computer controlled magnetron sputtering system Aurion

Group of Electron Beam Technologies (EBT)

Department of New Technologies



ISI
CAS
Institute of Scientific
Instruments
The Czech Academy
of Sciences

Institute of Scientific Instruments
of the CAS v. v. i.

The Czech Academy of Sciences
Královopolská 147, 612 64 Brno,
Czech Republic
<http://ebt.isibrno.cz>

Head: Dr. Martin Zobač
Phone: +420 541 514 315
E-mail: Martin.Zobac@isibrno.cz

Expert: Dr. Ivan Vlček
Phone: +420 541 514 297
E-mail: Ivan.Vlcek@isibrno.cz

Expert: Dr. Libor Dupák
Phone: +420 541 514 316
E-mail: Libor.Dupak@isibrno.cz



Electron guns for electron beam welding

Electron beam welding



THEMATIC RESEARCH FOCUS

Research area

- Electron beam welding
- Vacuum brazing
- Vacuum feedthroughs
- High-voltage DC power supplies
- Special electronics



Electron beam welder

Excellence

Electron beam welding of dissimilar metals; custom-made vacuum feedthroughs; precise high voltage supplies

Mission

Development of the new joining techniques of various metals, as well as design of the necessary equipment for such, as electron beam welders, vacuum furnaces and analytical electron-optics devices

UP-TO-DATE ACTIVITIES

Research focus

- Electron beam welding of dissimilar metals
- Development of electron beam welders including high-voltage power supplies
- High voltage power supplies for particle optics devices
- Brazing of metals with brittle non-metallic materials using pliable active filler metals
- Development of vacuum feedthroughs based on glass-to-metal seal

Main capabilities

Basic research

- Study of homogenous and heterogeneous joints of various metals

Applied research

- Design of technological devices such as electron beam welders, vacuum furnaces, etc.
- Development of high voltage powers supplies for both high power and precise electron optics
- Various types of vacuum feedthroughs based on glass-to-metal seal (matched kovar-glass or compression seal) both standard types (e.g. D-sub) or custom made

Sub-fields of group activities

- Precision engineering
- Automotive and aerospace industry
- Nuclear industry
- Vacuum technology
- Scientific instruments
- Semiconductor manufacturing

Electrical vacuum feedthroughs



KEY RESEARCH EQUIPMENT

List of devices

- Three electron beam welders (up to 60 kV, up to 2kW) developed and produced at ISI with two different types of vacuum chambers
- Upgraded vacuum furnace PZ-810 produced by former Czech company Tesla Rožnov
- Laboratory vacuum furnace for brazing and heat treatment of smaller parts (made by team)
- Furnace for glass-to-metal seal processing
- Helium leak detector QualyTest™ Dry HLT 270 by Pfeiffer Vacuum
- Precise 100 kV high voltage power supply with stability better than 2 ppm per 24 hours (made by team in collaboration with TESCAN Brno)
- Precise reference high voltage divider for voltage measurements up to 120 kV (made by team)

ACHIEVEMENTS

- **We developed a new improved version of the welding electron gun. The new electron beam generator has improved functionality, better X-ray protection and lower manufacturing costs. A special version of the gun with output power of 6 kW was developed for nuclear research facility.**
- **Our partners from academic institutions and from industry bring continuously new challenges in the field of metal joining. We dealt with dissimilar metal welding and braising, e.g. welding of Inconel alloys, refractory metals, steels, copper alloys and lot of others.**
- **During the fruitful cooperation with the leading electron microscopy manufacturer TESCAN a new precise high voltage supply was developed. The device can generate up to 100 kV with long term stability better than 2 ppm per 24 hour period. For testing and calibration a highly stable precise reference voltage divider was built.**
- **New types of vacuum feedthroughs were developed, among others quad SMB connector on ISO-KF 25 flange, MIL-C-5015 14S-2P on ISO-KF 25 flange and 12 way circular Hypcon-type connector for welding.**
- **We replaced old manual control of our vacuum and glass-processing furnaces with state-of-the-art PLC control systems. The new control systems support easy temperature profiling, remote control, data logging and system diagnostics.**

MAIN COLLABORATING PARTNERS

Collaboration with academic partners

- Brno University of Technology (Brno, CZ)
- University of West Bohemia in Pilsen (Plzeň, CZ)
- Masaryk University (Brno, CZ)
- Institute of Physics of Materials AV ČR, v. v. i. (Brno, CZ)

Collaboration with companies

- Focus GmbH (Hünstetten, Germany)
- TESCAN Brno, s.r.o. (Brno, CZ)
- První brněnská strojírna, a.s. (Velká Bíteš, CZ)
- PBS ENERGO, a.s. (Velká Bíteš, CZ)

High voltage reference divider for voltages up to 120 kV





Improved vacuum furnace

- Honeywell, spol. s r. o. (Brno, CZ)
- KOMO mark s.r.o. (Ostrava, CZ)
- ATEKO a.s. (Hradec Králové, CZ)
- Lavat a.s. (Chotutice, CZ)
- MESIT AEROSPACE, s.r.o. (Uherské Hradiště, CZ)
- Rigaku Innovative Technologies Europe s.r.o. (Praha, CZ)
- ŠKODA JS a.s. (Plzeň, CZ)
- VUES Brno s.r.o. (Brno, CZ)
- Glatt - Pharma, spol. s r.o. (Hradec Králové, CZ)
- VÚHŽ a.s. (Dobrá, CZ)
- ÚJP PRAHA a.s. (Praha, CZ)
- LAPP Insulators Alumina s.r.o. (Hradec Králové, CZ)
- Siemens, s.r.o., odštěpný závod Industrial Turbomachinery (Brno, CZ)
- FEI Czech Republic s.r.o. (Brno, CZ)
- DELONG INSTRUMENTS a.s. (Brno, CZ)
- Hanon Systems Autopal s.r.o. (Nový Jičín, CZ)
- Howden ČKD Compressors s.r.o. (Praha, CZ)

EXPECTATIONS

Offers

- Know-how in field of electron beam welding and vacuum brazing
- Welding and brazing equipment capacities for job shop production
- Development and small-lot production of vacuum feedthroughs
- Special electronics development skills, in particular high-voltage DC supplies design

Requirements

- Collaboration with industrial partners in joint projects dedicated to applied science
- Knowledge and technologies for material analysis
- New complementary technologies

Group of Electron Beam Lithography (EBL)

Department of New Technologies



Institute of Scientific
Instruments
The Czech Academy
of Sciences

THEMATIC RESEARCH FOCUS

Research area

- Electron beam lithography (EBL)
- Diffractive optically variable image devices (DOVIDs)

Excellence

- Planar relief micro and nano structures on silicon wafers and glass masks
- Laser beam shaping by computer generated holograms (CGH)
- Diffractive optically variable image devices (DOVIDs)
- Masks for photo and UV lithography and special purposes

Mission

To be highly specialized EBL team with focus on relief and multilevel structures for large range of particular applications

UP-TO-DATE ACTIVITIES

Research orientation

- Theoretical and experimental activities related to the e-beam lithography writing process (electron emitter preparation and characterization, current density distribution, benchmarking patterns, proximity effect correction, writing strategies, sequencing, partitioning)
- Theoretical and experimental activity in the field of technologies related to e-beam nanopatterning (coating process, resist development, etching techniques, evaluation methodology, technology of nano structured nitride membranes)
- Diffractive structures (gratings, Fourier and Fresnel structures, DOVIDs, laser beam shaping)
- Micro-sensors and microscopy calibration specimens

Main capabilities

Basic research

- Study and evaluation of electron scattering effects, simulation and correction algorithms
- Experimental activities related to electron emitter preparation and characterisation
- Calculation and optimization of computer generated holograms (CGH)

Applied research

- Phase and amplitude computer generated hologram structures
- Diffractive optically variable image devices
- Electrochemical and biological sensors
- MMS and MEMS, e.g. micro and nano structured free standing nitride membranes

Sub-fields of group activities

- Scanning electron microscopy – calibration samples
- Optical microscopy – resolution and calibration samples
- Microtechnology, nanotechnology
- Laser beam shaping and splitting

Institute of Scientific Instruments
of the CAS, v. v. i.

The Czech Academy of Sciences
Královopolská 147, 612 64 Brno,
Czech Republic
www.isibrno.cz
<http://ebl.isibrno.cz/>

Head: Assoc. Prof. Vladimír Kolařík
Phone: +420 541 514 525
E-mail: vladimir.kolarik@isibrno.cz

Expert: Dr. Miroslav Horáček
Phone: +420 541 514 318
E-mail: miroslav.horacek@isibrno.cz

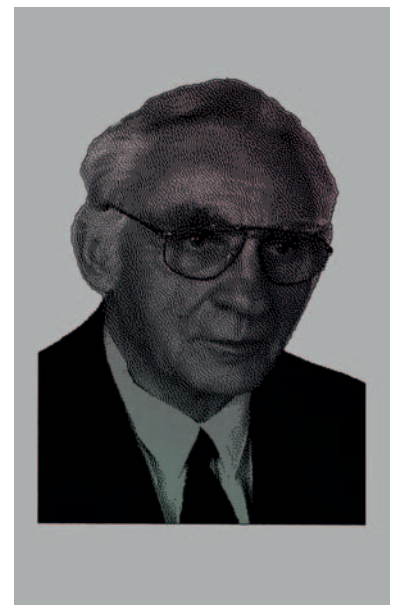

Armin Delong, 1925–2017 —
optically variable image device
(25 mm × 40 mm) composed of
light-absorbing and light-scattering
building blocks (0.1 mm × 0.1 mm)

KEY RESEARCH EQUIPMENT

List of devices

- E-beam writer (pattern generator) with shaped beam Tesla BS600: electron energy 15 keV, field deflection up to 3 mm × 3 mm, resolution 50 nm, rectangular stamp size range 50–6300 nm (standard mode), 17–2100 nm (TZ mode), writing speed > 1 cm² / hour (stamp size 1 μm × 1 μm, area filling factor 50 %)
- E-beam writer with Gaussian beam Vistec EBPG5000plusES: electron energy 50 or 100 keV, field deflection up to 0.25 mm × 0.25 mm, resolution 8 nm, beam size down to 2 nm, writing speed up to 1 cm² / hour (at beam step size 50 nm and area filling factor 50 %)

ACHIEVEMENTS

■ We deepened the methodology of e-beam lithography process using both the pattern generators as well as their combination. We also tuned up the technology processes with results useful in numerous application domains. Within the period 2012–2017 we published some 59 contributions in conference proceedings and journals. Within the same period we performed over 987 e-beam exposure runs.

■ Apparatus for cathode processing, activation and testing

- M. Horáček et al.: “Nano Modification of the W(100)/ZrO Electron Emitter Tip Using Reactive Ion Etching”, NANOCON 2012: 4th Int’l Conf. Proc’s, 2012

■ Cathodes with ultra-sharp tips are produced using automated set-up utilizing electrochemical etching method (both single-crystalline and poly-crystalline can be used). Cathodes which are based on cold field emission and thermal field emission (Schottky cathodes) are tested at ultra-high vacuum conditions. The following properties are obtained: I–V characteristics, Fowler–Nordheim analysis, an emission pattern of the electron beam, a long time stability of the electron beam, a surface characterization and a diagnostics of a cathode surface using scanning electron microscopy

- A. Knápek et al.: “Programmable set-up for electrochemical preparation of STM tips and ultra-sharp field emission cathodes”, *Microelectronic Engineering*, 2017, 173: 42–47
- A. Knápek et al.: “Field emission from the surface of highly ordered pyrolytic graphite”, *Applied Surface Science*, 2017, 395: 157–161

Field-emission microscope: ultra-high vacuum system for development and testing of single-crystal and alternative electron emitters

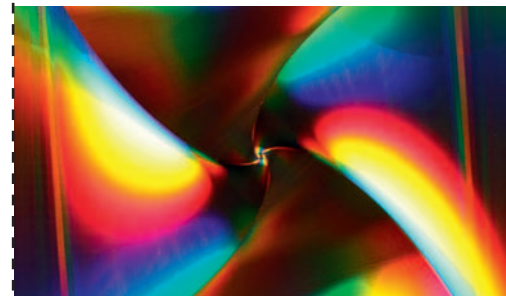
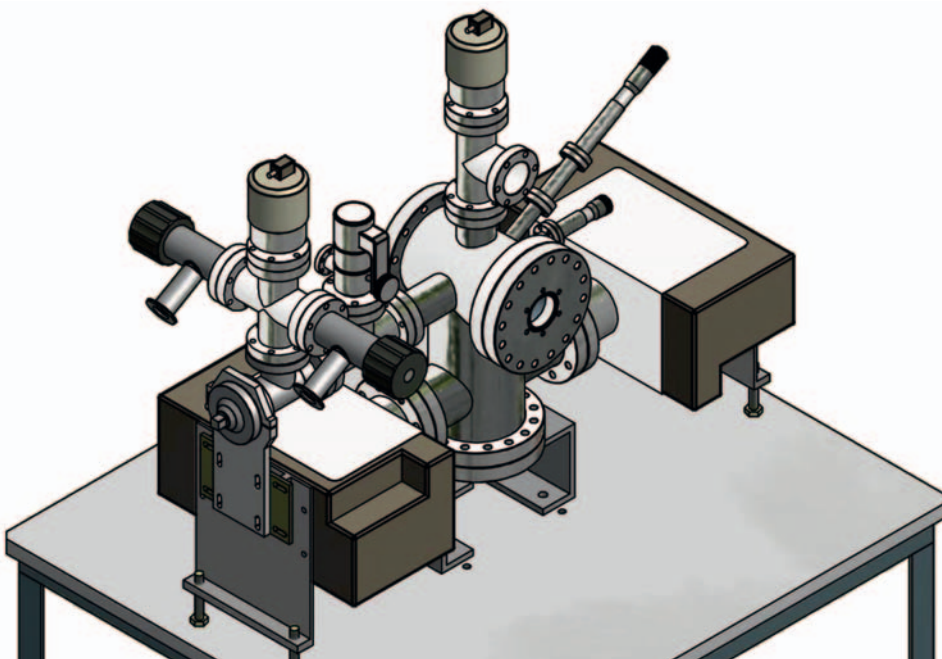

EBPG homogeneity testing pattern

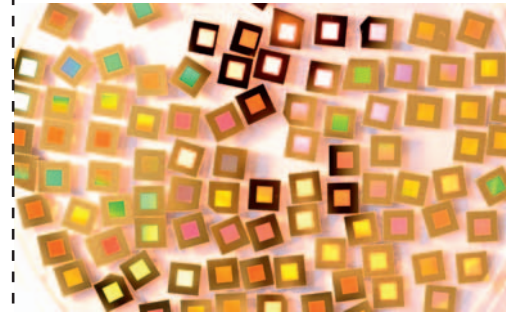

Specimens for Raman spectroscopy — etched silicon with Au nano-islands

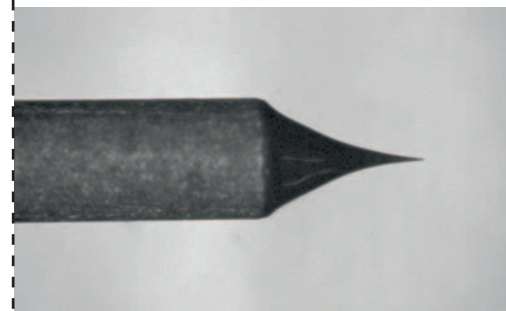

Electrochemically etched micro/nano tungsten wire with controllable tip profile for the field emission cathodes and SPM probes applications

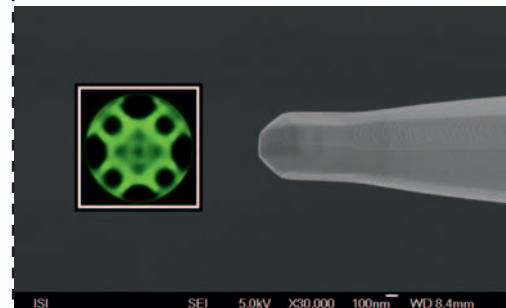

Electron emitter tip and its emission pattern (inlay)

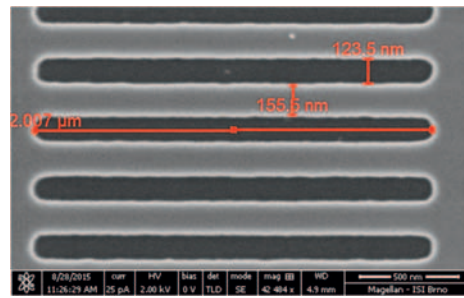
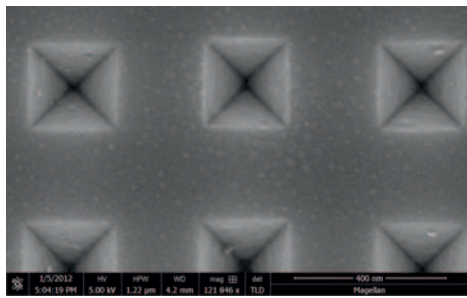

Anisotropically etched silicon grating — resolution testing pattern (left)

Grating motif of patterned free-standing nitride membrane (right)

Technology of combined e-beam lithography patterning using writers with variable-shape beam and Gaussian-type beam. Proximity effect correction — reliability of the method for 3D e-beam nanopatterning of diffractive optical elements.

- S. Krátký et al.: “Combined E-Beam Lithography Using Different Energies”, in 42nd Int’l Conf. on Micro and Nano Engineering, 2016
- S. Krátký et al.: “PEC Reliability in 3D E-beam DOE Nanopatterning”, *Microscopy and Microanalysis* **21**, S4, 230–235, 2015

Lithographic and etching technological processes, MEMS preparation, planar nanostructures on silicon nitride membranes

- M. Matějka et al.: “Nanopatterning of Silicon Nitride Membranes”, NANOCON 2016: 8th Int’l Conf. Proc’s, 2016
- M. Urbánek et al.: “Plasmochemical Etching of Silicon in Diener Nano Device” (in Czech), *Chemické listy* **108**, 592–595, 2014

Benchmarking patterns allowing visual check of e-beam patterning performance

- P. Meluzín et al.: “Some Other Gratings: Benchmarks for Large-Area E-Beam Nanopatterning”, NANOCON 2014: 6th Int’l Conf. Proc’s, 2014
- Vox Populi Award IMC2014
- Raith Micrograph Special Art Award 2014

Planar structures with structural colors, plasmonic structures, optical antireflective structures

- V. Kolařík et al.: “Structural Color of Metallic Surfaces”, METAL 2014: 23rd International Conference on Metallurgy and Materials, 2014

Various samples for microscopy (optical, SEM, SPM, confocal): dimension specimens, bi-metal samples, defined height step sample, USAF 1951 sample (ranged from the set 0 down to the set 11)

- V. Kolařík et al.: “Calibration specimens for microscopy”, NANOCON 2012: 4th Int’l Conf. Proc’s, 2012

Utility models of diffractive optically variable image devices

A monograph on practical aspects of e-beam lithography techniques and related technologies was released. A miniature of this book (size 1.7 mm x 2.7 mm, 101 600 dpi) was performed with the BS600 system.

- F. Matějka: “Practical E-Beam Lithography” (in Czech), ISI CAS, Brno, 2013, 100 pages

Various highly specialized samples: dozens of dedicated samples were performed with both origination systems, e.g. masks for vortex beam generation, masks for Bragg fiber grating exposures, masks for seismology applications, gold finger micro biosensors, CGH annular frame set, masks for micro fluidic applications, etc.

- S. Krátký et al.: “Differential conductometry biosensors prepared by lift-off technique by using of e-beam writer with shaped beam”, MNE2013: 39th International Conference on Micro and Nano Engineering, p. 387

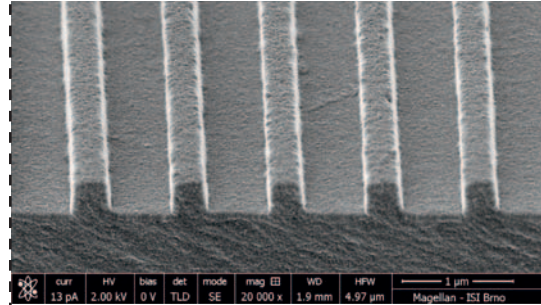

Phase photo mask for Bragg fiber grating

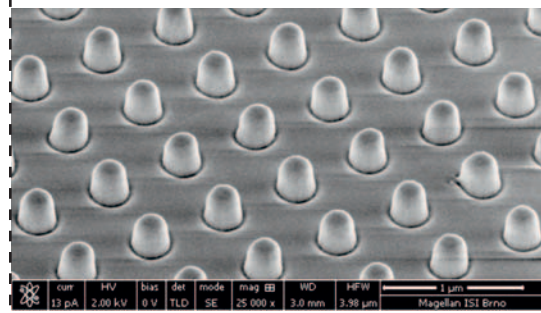

Quartz nano-pillar template for NIL

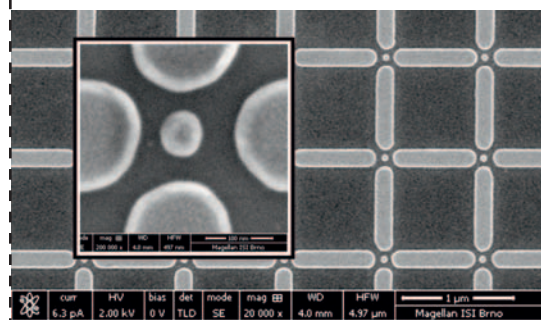

Ni-Fe nanostructures prepared by lift-off



Multi-axial diffractive zonal lens

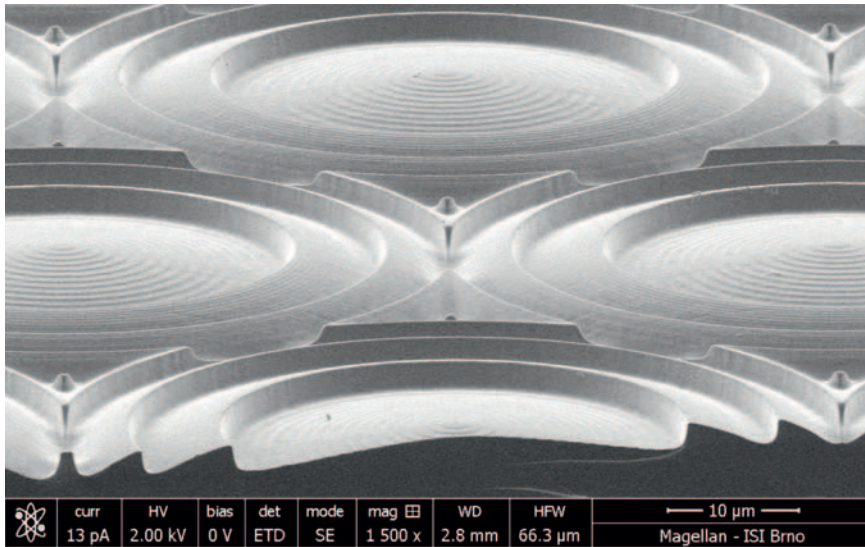

Hexagonal array of zonal micro lenses

MAIN COLLABORATING PARTNERS

Collaboration with academic partners

- Brno University of Technology (Brno, CZ)
- CEITEC (Brno, CZ)
- Institut NEEL (Grenoble, FR)
- Institute of Informatics SAV (Bratislava, SK)
- Institute of Thermomechanics CAS (Praha, CZ)
- Jozef Stefan Institute (Ljubljana, SI)
- Masaryk University (Brno, CZ)
- University Olomouc (Olomouc, CZ)
- Slovak University of Technology in Bratislava (Bratislava, SK)
- Tomas Bata University in Zlín, Centre of Polymer Systems (Zlín, CZ)

Collaboration with companies

- Czech Metrology Institute (Brno, CZ)
- Delong Instruments (Brno, CZ)
- FEI Czech Republic / Thermofisher Scientific (Brno, CZ)
- IQ Structures (Řež u Prahy, CZ)
- NETWORK GROUP, s.r.o. (Brno, CZ)
- Optaglio (Lochovice, CZ)
- Optometrics (USA)
- TESCAN Brno, s.r.o. (Brno, CZ)
- Thermofisher Scientific (UK)

EXPECTATIONS

Offers

We offer collaboration in the areas of our expertise. Custom development and manufacturing of particular planar microstructures and nanostructures, e.g. optical focusing / splitting / beam shaping elements, photolithography masks, dimension and material calibration samples for microscopy.

Requirements

We look for cooperation with academic partners as well as application partners in the fields of lithography and complementary techniques, microtechnologies, nanotechnologies, applications of planar nanostructures.

Diffractive optically variable image devices based on deterministic aperiodic mesh of nano-pillars and/or nano-holes

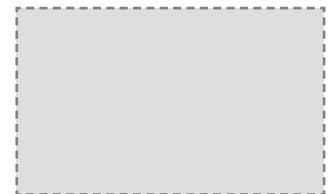
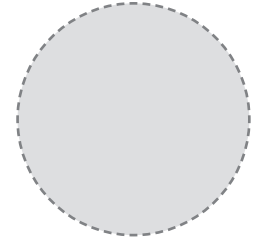

Detail of the optically variable image device from the front page: light-absorbing (a) and light-scattering (b) 100-micron square building blocks

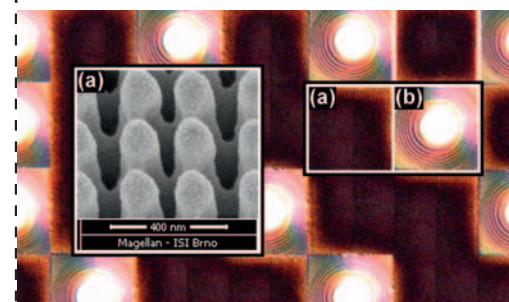

THEMATIC RESEARCH FOCUS

Research area

- Electron and ion optics
- Electron optical design and simulations
- Design of detection systems in electron and ion optical instruments
- Simulations of ion and electron sources

Excellence

- Electron and ion optical simulation of nonstandard systems and aberration corrected systems

Mission

- Development of new computations methods in electron and ion optical systems
- Simulation and design of nonstandard electron and ion optical systems

**Institute of Scientific Instruments
 of the CAS v.v.i.**

The Czech Academy of Sciences
 Královopolská 147, 612 64 Brno,
 The Czech Republic
 www.isibrno.cz

Head: Dr. Tomáš Radlička
 Phone: +420 541 514 294
 E-mail: TomasRadlicka@isibrno.cz

3D field of a stigmator

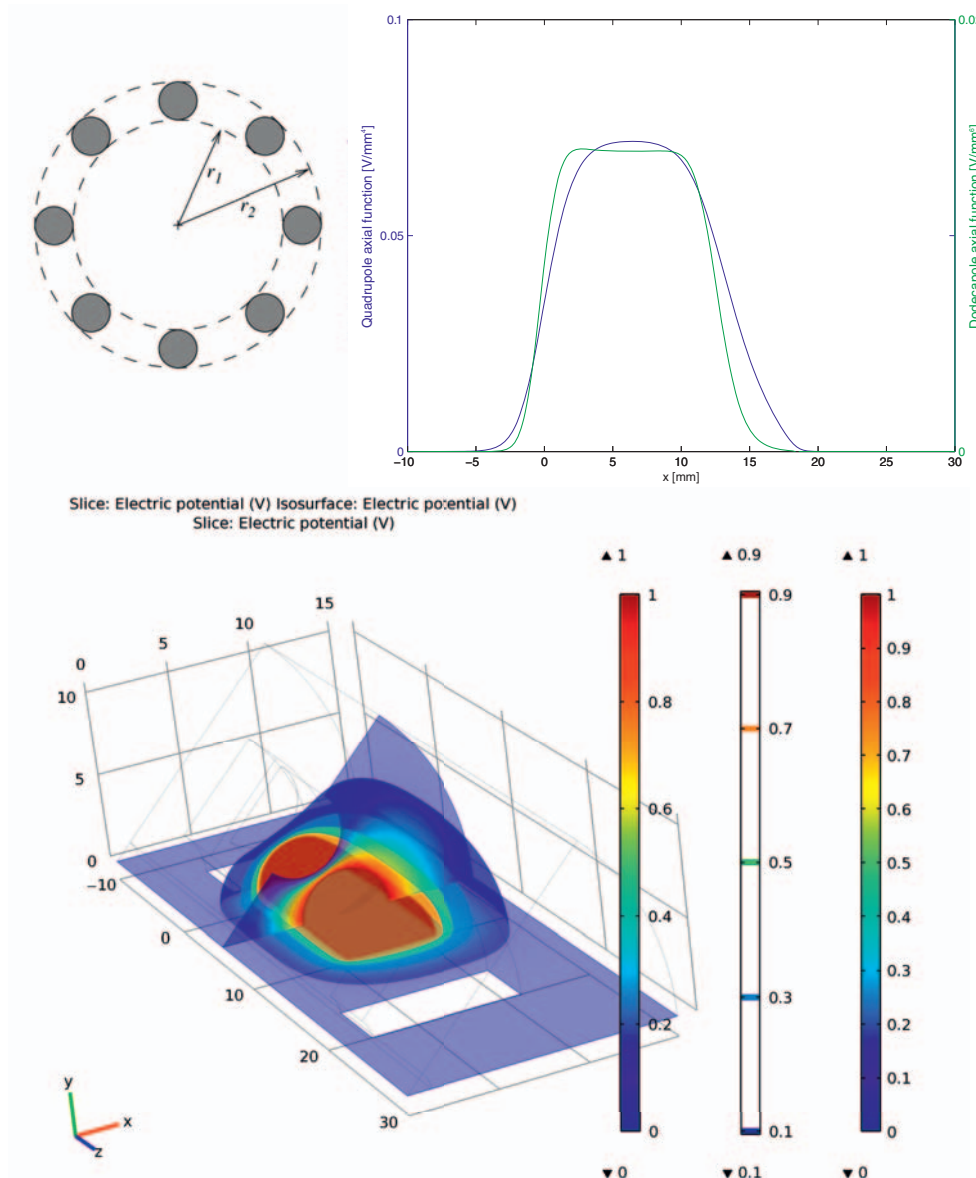

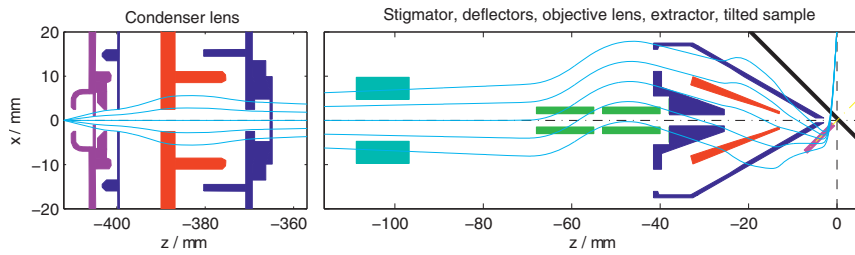

UP-TO-DATE ACTIVITIES

Research orientation

- Calculations of high order aberrations by regression or by differential algebraic method
- Current density profiles with and without diffraction
- Space charge and stochastic Coulomb interactions
- Simulation of interaction of electron with gas molecules

Main capabilities

Basic research

- Exploring the resolution limits of electron and ion optical systems due to aberrations, Coulomb interaction and diffraction
- Simulations of the electron and ion source properties
- Analysis and correction of parasitic aberrations in general optical columns including aberration-corrected systems

Applied research

- Design of electron and ion optical instruments
- Development of software for simulation of non-standard electron and ion optical systems

Sub-fields of group activities

- Electron optics and electron microscopy
- Ion mass spectroscopy and electron spectroscopy (ToF, energy-dispersive)
- Signal electron and X-ray detector optimisation

KEY RESEARCH EQUIPMENT

List of devices

Software for simulation of electron and ion optical systems that has been developed at ISI.

ACHIEVEMENTS

■ Simulation of nonstandard electron and ion optical systems (electron mirror, extraction optics of Time of Flight detectors, Wien Filter with permanent magnets, general 3D optical systems), correctors and misalignment aberrations

- M. Oral, T. Radlička, B. Lencová: "Effect of sample tilt on Photo Emission Electron Microscopy resolution", *Ultramicroscopy* **119**, 45–50, 2012
- M. Oral, B. Lencová: "Correction of sample tilt in FIB instruments", *Nucl Instrum Meth A*. **645**, 130–135, 2011

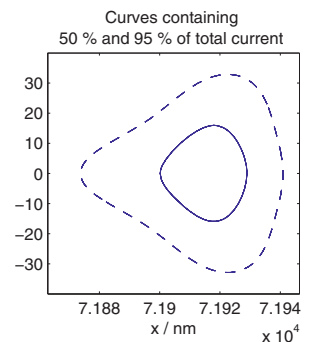
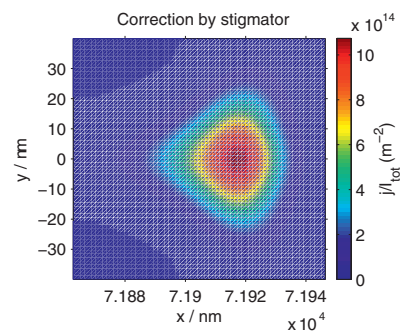
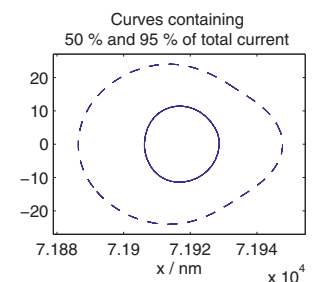
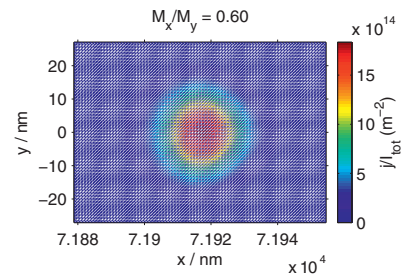
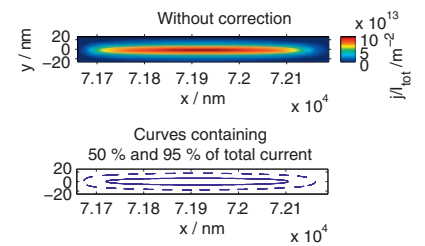

Corrections of sample tilt SIMS

Analysis and correction of parasitic aberrations of a hexapole corrector of spherical aberration

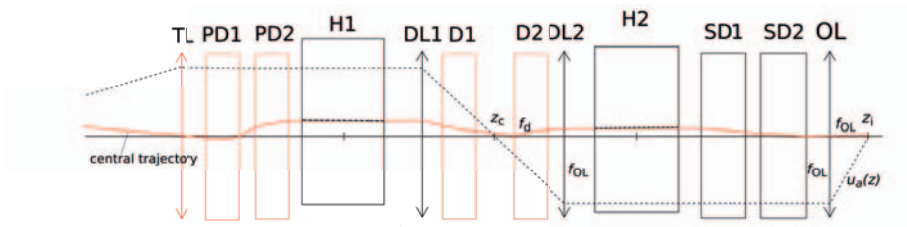

Doublet lenses ellipticity: $1\mu\text{m}$, $(0.57+0.48i)\mu\text{m}$

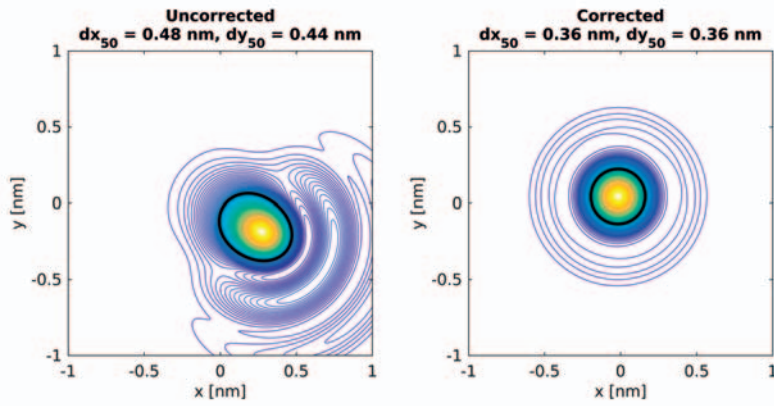

■ Exploring the resolution limits of low-energy SEM and corrected Transmission SEM including design of correctors and parasitic aberration analysis.

- T. Radlička: "Wave Optical Calculation of Probe Size in Low Energy Scanning Electron Microscope"; Microscopy and Microanalysis **21**, S4, 212–217, 2015

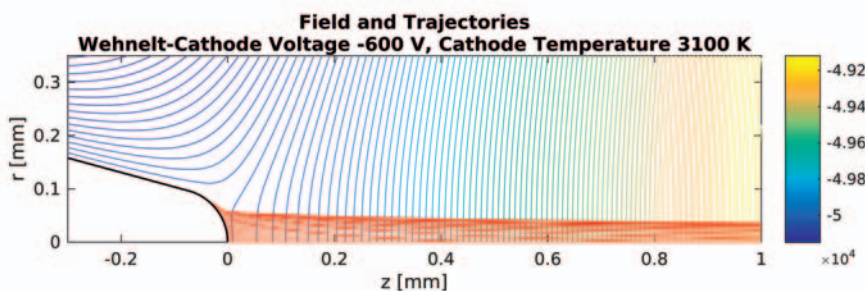
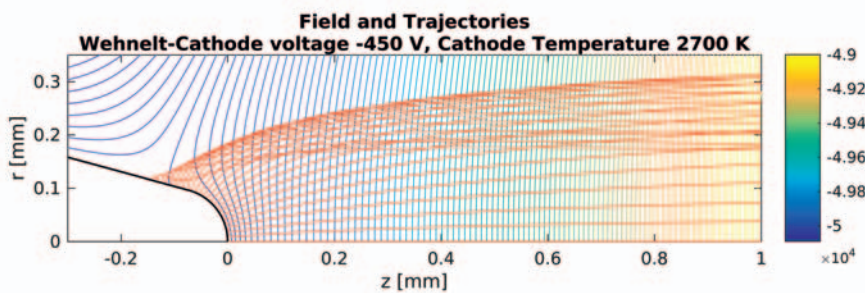
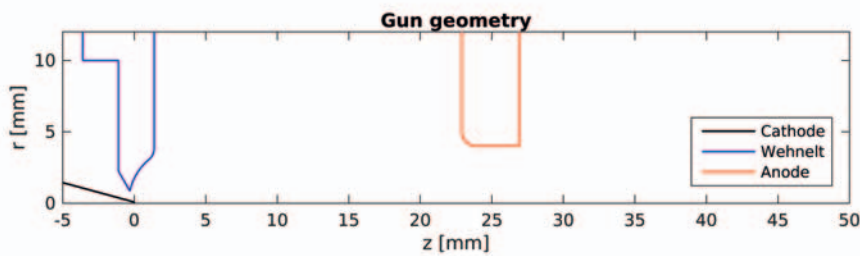

Space-charge-limited thermionic emission

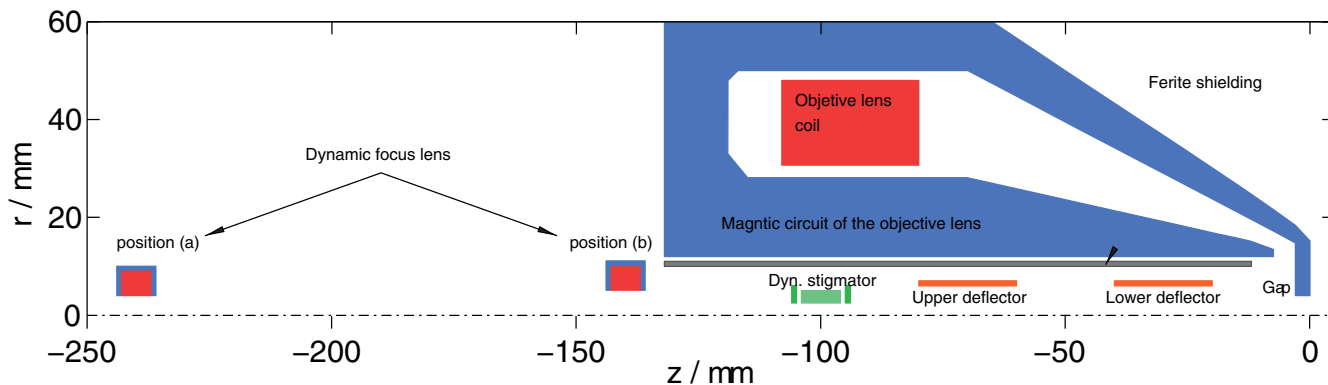

■ Design of low-energy environmental SEM with dynamically corrected deflection systems

- M. Oral, V. Neděla, G. Danillatos: "Dynamic Correction of Higher-Order Deflection Aberrations in the Environmental SEM"; *Microscopy and Microanalysis* **21**, S4, 194–199, 2015

■ Simulation of thermionic electron sources with space-charge-limited emission.

- J. Zelinka, M. Oral, T. Radlička: "Simulation of Space Charge Effects in Electron Optical System Based on the Calculations of Current Density"; *Microscopy and Microanalysis* **21**, S4, 246–251, 2015

MAIN COLLABORATING PARTNERS

Collaboration with academic partners

Brno University of Technology (Brno, CZ)
Technische Universität Wien (Vienna, A)

Collaboration with companies

FEI CR (Brno, CZ); now Thermo-Fisher Scientific
Delong Instruments, a.s. (Brno, CZ)
Nion Company, (Kirkland, USA)

EXPECTATIONS

Offers

- Partnership in international projects
- Design of electron and ion optical systems
- Simulation and design of electron and ion sources
- Computationally intensive calculations of acceptance diagrams for description of contrast mechanism including Monte-Carlo simulation of signal electron emission
- Consulting in the field of charge particle optics

Requirements

Collaboration with industrial partners in projects dedicated to charged particle optics.
Collaboration with academic partners on development of custom instruments using charged particles.

Design of a low-energy environmental SEM objective lens with a dynamically corrected deflection system

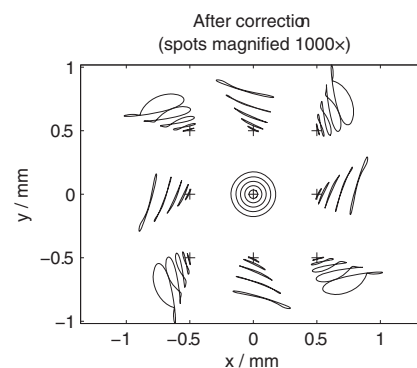
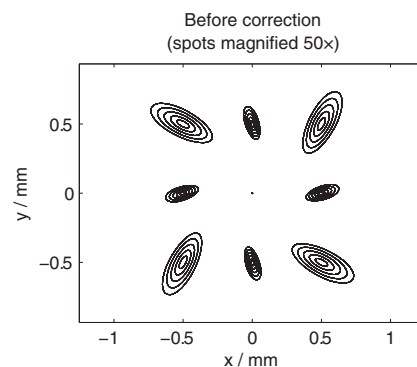

Deflection aberration patterns without and with dynamic corrections

**Institute of Scientific Instruments
of the CAS, v.v.i.**

The Czech Academy of Sciences
Královopolská 147, 612 64 Brno,
The Czech Republic
<http://www.isibrno.cz/msp/>

Head: Dr. Ilona Müllerová
Phone: +420 541 514 204
E-mail: ilona@isibrno.cz

THEMATIC RESEARCH FOCUS

Research area

- Low energy scanning electron microscopy
- Low energy transmission electron microscopy and time-of-flight spectroscopy
- Auger electron spectroscopy and spectromicroscopy
- Surface physics
- Micro- and nanostructure of advanced materials
- Technology and diagnostics of 2D crystals and thin films
- Computer simulations of formation and detection of electron beams

Excellence

Contrast formation at low and very low energies in the scanning electron microscopy and spectroscopy both in the reflection and transmission mode with lateral resolution of units of nm, with an application to the study of advanced materials and biostructures; generation, acquisition and processing of electron micrographs

Mission

Development of advanced methods of scanning electron microscopy and their application in materials and biomedical sciences and technologies

UP-TO-DATE ACTIVITIES

Research orientation

- Methodology for the formation of beams of very slow electrons and their manipulation aimed at the illumination of solid surfaces or free-standing films, including vortex electron beams
- Theory of interaction of slow electrons with matter, generation of signals released under impact of electrons, analysis of information carried by species emitted under electron bombardment, electron crystallography, examination of 2D crystals
- Detection of electrons emitted from surfaces or transmitted through films, including multichannel detection of angular and energy distribution of emitted electrons in SEM and STEM, aiming at ultimate angular, energy and lateral resolution, simulation of signal generation and detection
- Interpretation of scanned electron beam micrographs and Auger electron spectromicrographs
- Quantitative scanning electron microscopy, especially at low energies
- Examination of treatment of solid surfaces with slow electrons
- Questions of the coherence of electron beams

Main capabilities

Basic research

- Interaction of slow electrons with matter
- Reflectivity and transmissivity of slow and very low electrons from/through solids
- Generation of Auger electrons
- Theory of contrast mechanisms in scanning electron microscopy
- Relations between the state of surface and its response to electron bombardment
- Principles of detection of low energy electrons
- 3D distribution of electromagnetic field and motion of charged particles therein

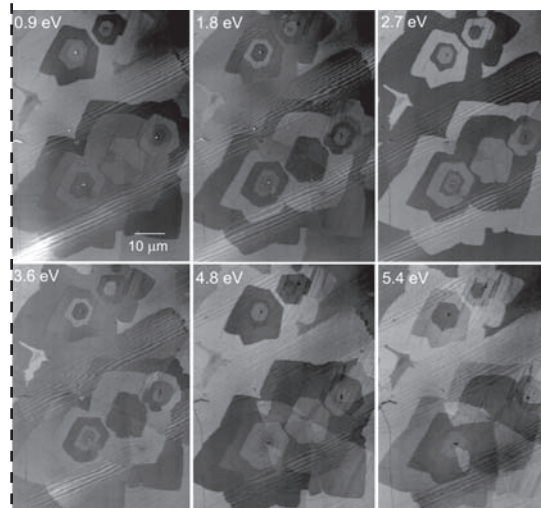

Multilayer graphene deposited by the CVD technique on a Cu foil; variations in brightness of graphene islands originates in fluctuations of their reflectivity and number of reflectivity minima indicates the number of overlapped graphene layers

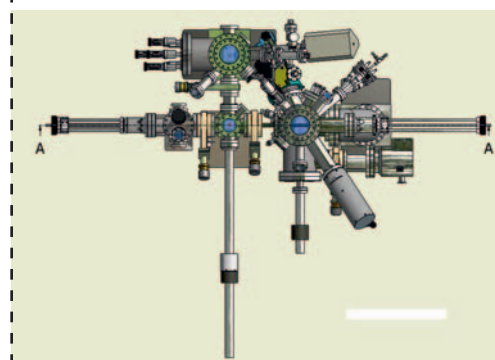

Design of the innovated preparation chambers and air-lock for the ultrahigh vacuum microscope, which is currently assembled

Applied research

- Ultrahigh vacuum scanning low energy electron microscopy
- Analysis of phases in complex materials, e.g. steels
- Visualization of crystal orientation and internal stress
- Analysis of surface coatings and thin films, Auger electron spectromicroscopy
- Analysis of ultrathin tissue sections and free-standing films and 2D crystals
- Simulation of electron trajectories in electron optical elements and systems
- Design of multichannel electron detectors and the time-of-flight velocity analyser

Innovations

- Extension of the scanning electrons microscopy to arbitrarily low energy in reflection and transmission modes
- Electron-beam-induced release of hydrocarbons from solid surfaces
- Counting of graphene layers upon reflection as well as transmission of slow electrons
- Acquisition of high contrast images of tissue sections not treated with any heavy metal species

Subfields of group activities

- Materials science (micro- and nanostructure of materials)
- Life sciences (ultrathin tissue sections, biological crystals)
- Nanotechnologies
- Industry of scientific instrumentation
- Metallurgy
- Industry of polymers, composites, surface coatings, etc.
- Medicine

KEY RESEARCH EQUIPMENT

List of devices

- Ultrahigh vacuum scanning low energy electron microscope of in-house design consisting of the observation and preparation chambers, equipped with in-situ technologies for specimen treatment, namely ion beam cleaning, heating and deposition of thin films, and auxiliary techniques, namely Auger electron spectroscopy, mass spectroscopy of released gases and reflection high-energy electron diffraction from crystals
- Ultrahigh vacuum scanning low energy electron microscope of in-house design equipped with time-of-flight analysis of energies of electrons transmitted through ultrathin films and 2D crystals and two-dimensional position sensitive detection of the angular distributions of reflected electrons
- Attachments for several commercial scanning electron microscopes allowing sample observation with low and very low energy electrons
- Equipment for the preparation of clean, smooth or coated specimens and for the CVD technology grown thin films

ACHIEVEMENTS

■ Study of transmissivity of ultrathin free standing foils at very low energies in scanning electron microscope with a high contrast and a high lateral resolution in the nm scale

- I. Müllerová, M. Hovorka, L. Frank: "A method of imaging ultrathin foils with very low energy electrons"; *Ultramicroscopy* **119**, 78–81, 2012

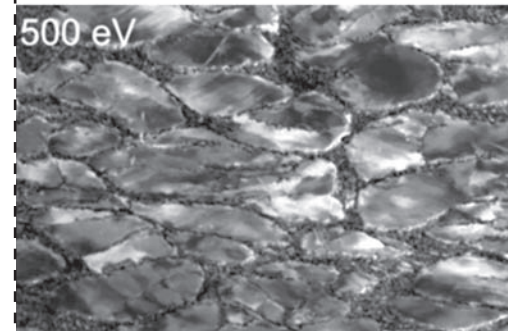
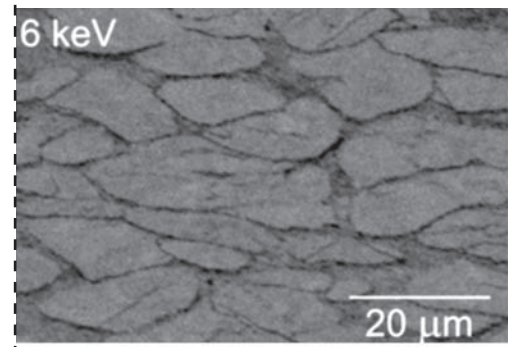

X210Cr12 ledeburitic steel heated to a semisolid state, heavily deformed and cooled; standard micrograph at 6 keV does not visualize the distribution of internal stress that is well shown in the cathode lens mode at 500 eV

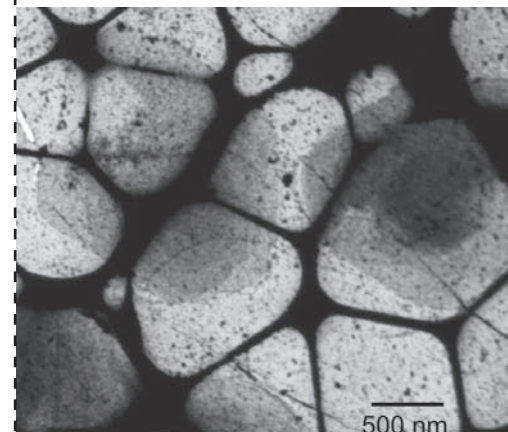

CVD graphene samples deposited on lacey carbon lying on a copper mesh, commercially available sample declared as three- to five-layer graphene; image in transmitted electrons at 220 eV clearly visualizes sites differing by a single carbon atom in thickness

■ **Imaging of graphene multilayers with a high contrast, counting the graphene layers upon reflectivity as well as transmissivity of very slow electrons, identification of the grow mechanism of graphene**

- L. Frank, E. Mikmeková, I. Müllerová, M. Lejeune: "Counting graphene layers with very slow electrons"; *Applied Physics Letters* **106**, 013117:1-5, 2015
- E. Mikmeková, L. Frank, I. Müllerová, B.W. Li, R.S. Ruoff, M. Lejeune: "Study of multi-layered graphene by ultra-low energy SEM/STEM"; *Diamond and Related Materials* **63**, 136-142, 2016

■ **Characterisation of crystal orientation with a high lateral resolution from the reflectivity of electrons at impact energies below 40 eV**

- Z. Pokorná, Š Mikmeková, I. Müllerová, L. Frank: "Characterization of the local crystallinity via reflectance of very slow electrons"; *Appl. Phys. Lett.* **100**, 261602: 1-4, 2012
- A. Knápek, Z. Pokorná: "A method for extraction of crystallography-related information from a data cube of very-low-energy electron micrographs"; *Ultramicroscopy* **148**, 52-56, 2015

■ **Imaging at high contrast and resolution of ultrathin tissue sections not treated with any agents containing heavy metal salts for contrast enhancement**

- L. Frank, J. Nebesářová, M. Vancová, A. Paták, I. Müllerová: "Imaging of tissue sections with very slow electrons"; *Ultramicroscopy* **148**, 146-150, 2015
- J. Nebesářová, P. Hozák, L. Frank, P. Štěpán, M. Vancová: "The Cutting of Ultrathin Sections With the Thickness Less Than 20 nm From Biological Specimens Embedded in Resin Blocks"; *Microscopy Research Technique* **79**, 512-517, 2016

■ **Applications of low energy SEM in nanotechnology**

- I. Müllerová, M. Hovorka, F. Mika, E. Mikmeková, Š. Mikmeková, Z. Pokorná, L. Frank: "Very low energy scanning electron microscopy in nanotechnology"; *International Journal of Nanotechnology* **9**, 695-716, 2012

■ **Development of new highly sensitive method for the determination of crystallographic orientation of grains from maximum anisotropy of reflected electrons**

- Š. Mikmeková, M. Hovorka, I. Müllerová, O. Man, L. Pantělejev, L. Frank: "Grain contrast imaging in UHV SLEEM"; *Materials Trans.* **51**, 292-296, 2010

■ **A method for quantitative measurements of dopant level in semiconductors using optimum primary beam energy**

- L. Frank, I. Müllerová, D. Valdaitsev, A. Gloskovskii, S. Nepijko, H. Elmers, G. Schönhense: "The origin of contrast in the imaging of doped areas in silicon by slow electrons"; *J. Appl. Phys.* **100**, 093712: 1-5, 2006
- I. Müllerová, M.M. El Gomati, L. Frank: "Imaging of the boron doping in silicon using low energy SEM"; *Ultramicroscopy* **93**, 223-243, 2002

■ **An overview about the development of the scanning low energy electron microscopy**

- I. Müllerová, L. Frank: "Scanning low energy electron microscopy"; *Advances in imaging and electron physics* **128**, 309-443, 2003

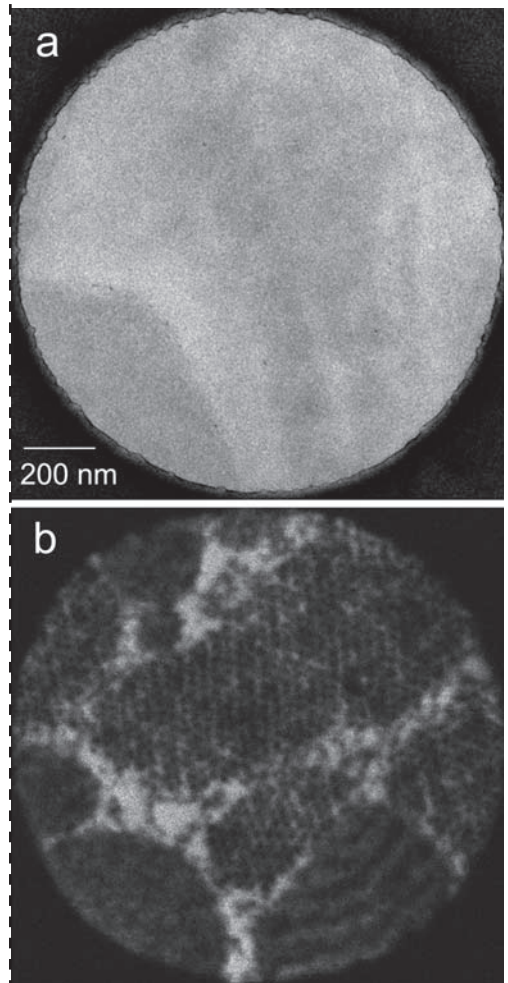

Section of mouse heart muscle, not fixed with osmium tetroxide and not stained; (a) 10 nm section imaged by conventional TEM at 80 keV, (b) micrograph taken at 500 eV by means of the cathode lens, showing drastically enhanced contrast

Identification of crystal grains in Al on the basis of reflectivity of very slow electrons; EBSD map (a), micrographs acquired using the cathode lens (b and c), and energy dependence of the reflectivity of selected grains (d)

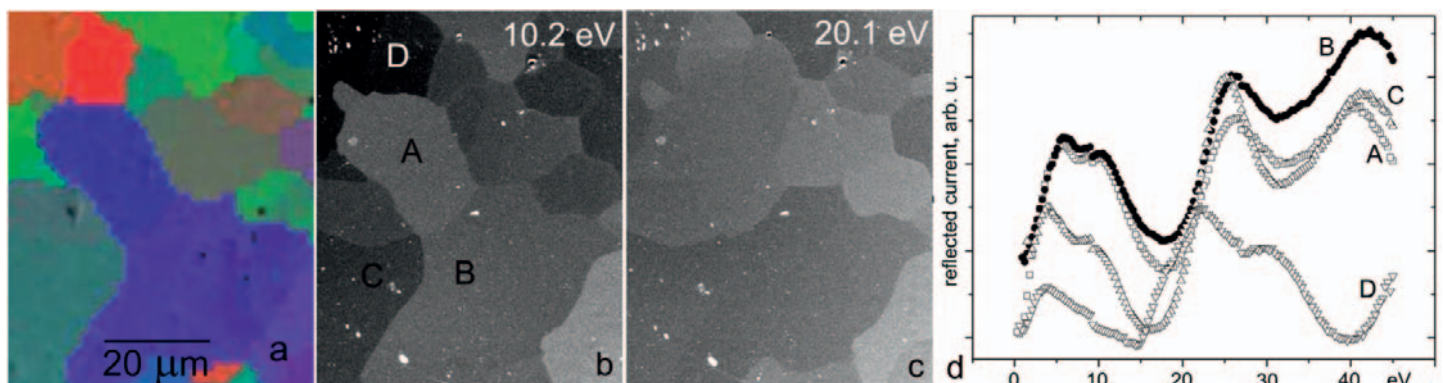

An automatic method for non-charging imaging of uncoated and nonconductive specimens by fine-tuning the primary beam energy

- L. Frank, M. Zdražil, I. Müllerová: "Scanning electron microscopy of nonconductive specimens at critical energies in a cathode lens system", Scanning **23**, 36–50, 2001

M+AIN COLLABORATING PARTNERS

Collaboration with academic partners

- University of Toyama (Toyama, Japan)
- University of York (York, UK)
- University of Zürich (Zürich, CH)
- University of West Bohemia (Plzeň, CZ)
- Biology Centre of the CAS (CZ)
- Institute of Macromolecular Chemistry of the CAS (CZ)
- Brno University of Technology (Brno, CZ)
- Masaryk University (Brno, CZ)

Collaboration with companies

- JFE Steel Corporation (Tokyo, Japan)
- Voestalpine Stahl (Wien, Austria)
- Research and Testing Institute (Plzeň, CZ)
- DeLong Instruments (Brno, CZ)
- Thermo Fisher (FEI Czech Republic, Brno, CZ)
- Thermo Fisher (FEI Company, Hillsboro, OR, USA)
- Crytur (Turnov, CZ)

EXPECTATIONS

Offers

- Partnership in international projects
- Analysis of samples of advanced materials
- Cooperation on nanostructure tasks difficult to solve with traditional electron microscopic methods
- Design of detection systems for instruments using charged particles (electron and ion microscopes and lithographs)
- Contrast formation in electron and ion microscopes and lithographs, study of signal trajectories and interaction of charged particles with matter
- Design and manufacture of ultrahigh vacuum components and systems

Requirements

- Provision of samples of advanced materials
- Cooperation on nanostructure tasks difficult to solve with traditional electron microscopic methods
- Collaboration with industrial and academic partners
- Cooperation on vortex electron beams

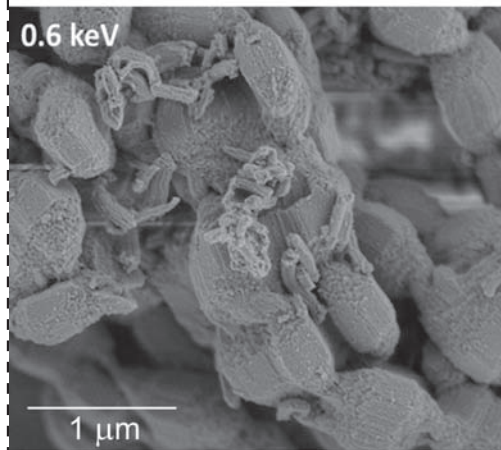
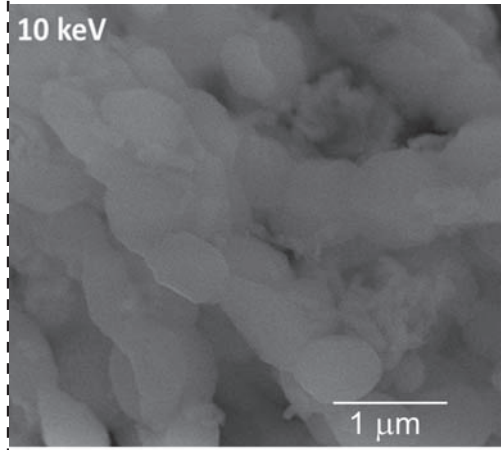

Mesoporous carbon nitride foam as a carrier for catalytic gold nanoparticles; when reducing the energy of electrons, we diminish the interaction volume from which we receive the image information so the image gets „sharper“

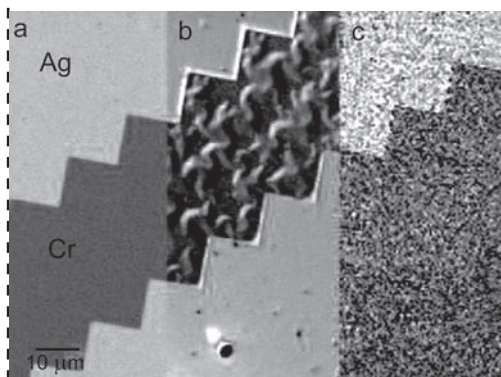

Surface analysis tools demonstrated on a 100 nm microcrystalline chromium foil, electron beam lithograph patterned on a silver-coated silicon wafer; (a) conventional image; (b) low energy image; (c) corrected Auger mapping in Cr

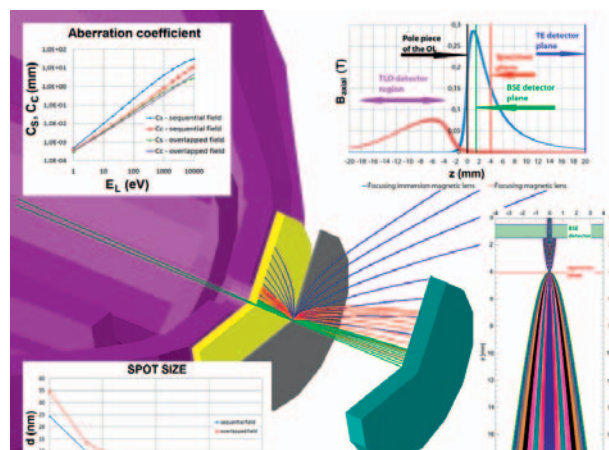

Examples of simulated configurations and results of simulations of electron-optical properties and trajectories of signal species

Group of Microscopy and Microanalysis

Department of Electron Microscopy



Institute of Scientific
Instruments
The Czech Academy
of Sciences

THEMATIC RESEARCH FOCUS

Research area

- High resolution scanning electron microscopy (SEM)
- Imaging of nonconductors in SEM
- Low energy SEM
- Scanning transmission electron microscopy (STEM)
- Energy dispersive X-ray analysis (EDX)
- Electron backscattered diffraction analysis (EBSD)
- Cathodoluminescence (CL)

Excellence

- Imaging of samples (biological specimens) without metal coating in standard vacuum high resolution SEM
- Imaging of materials at low energies of impact electrons

Mission

Be in the forefront in the development of new high resolution SEM imaging methods and analysis for different kind of materials even at low energies.

UP-TO-DATE ACTIVITIES

Research focus

- Experimental and theoretical activities related to imaging of specimens with electrons of energy below 1000 eV, fit for high resolution imaging without metal coating. Imaging in reflected and transmitted detection mode
- Determination of precise component compound of the sample with energy dispersive analysis
- Determination of precise crystallographic orientation, defect studies, phase and grain boundary identification in many materials with electron back scattered diffraction
- STEM imaging
- Cathodoluminescence imaging and spectroscopy

Main capabilities

Basic research

- Generation of signal electrons and their detection mechanism in SEM

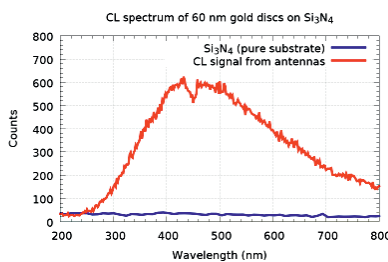
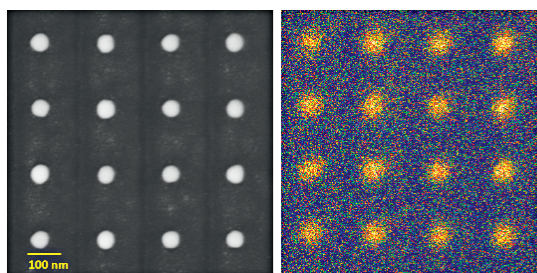

Institute of Scientific Instruments
of the CAS, v. v. i.

Czech Academy of Sciences

Královopolská 147, 612 64 Brno,
Czech Republic

E-mail: institute@isibrno.cz

www.lem.isibrno.cz

Head: Dr. Filip Mika

Phone: +420 541514298

E-mail: mika@isibrno.cz

Expert: Dr. Aleš Paták

Phone: +420 541514361

E-mail: patak@isibrno.cz

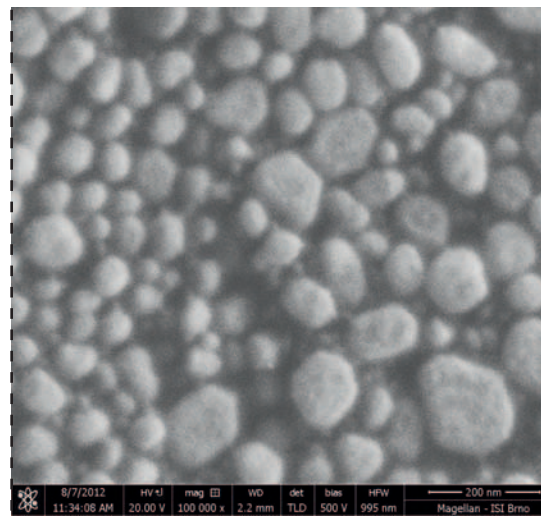
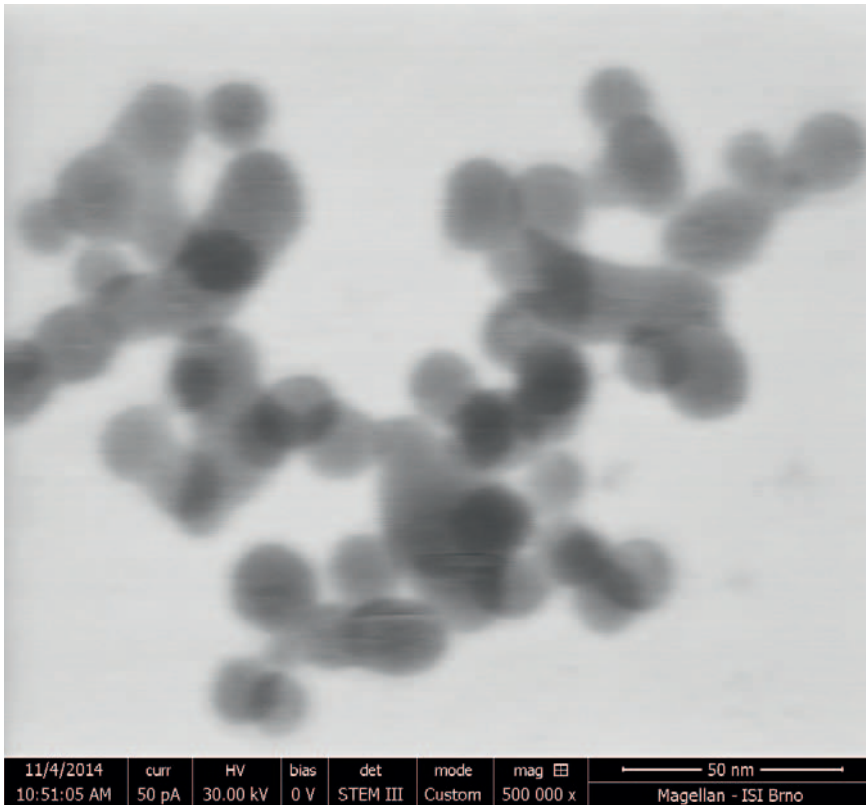

Image of gold on carbon test specimen at
the landing energy of 20 eV

Gold disk antenna-SEM image with SE
detector – Cathodoluminescence (CL)
panchromatic image-measured CL spectrum



NaYF₄ nano particles imaged with STEM brightfield detector

Applied research

- Imaging of samples of various properties and specific requirements on their observation (metals and alloys, composite materials and polymers, electronics materials, ceramic materials, natural and biological materials)
- Complex sample analysis

Sub-fields of group activities

- Material engineering
- Life-sciences (especially molecular biology, biochemistry)
- Measuring instruments
- Plastics, polymers
- Glass, ceramics

KEY RESEARCH EQUIPMENT

List of devices

Scanning electron microscopes:

- FEI MAGELLAN 400
- JEOL JSM 6700F
- TESCAN VEGA 5130

Analysers:

- Energy dispersive analyzer of X-rays (INCA 350 and EDAX Apolo X)
- Electron Back Scattered Diffraction Analyzer (Hikari)
- Cathodoluminescence detector (Gatan MonoCL)

Others:

- Evaporators
- Sputters
- Cutting machine

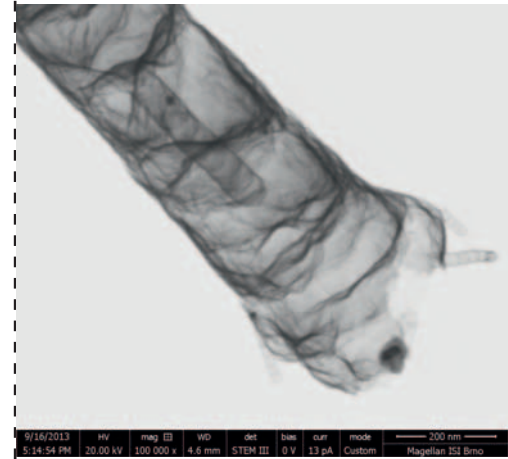

Carbone multiwall nano tube imaged with STEM bright field detector

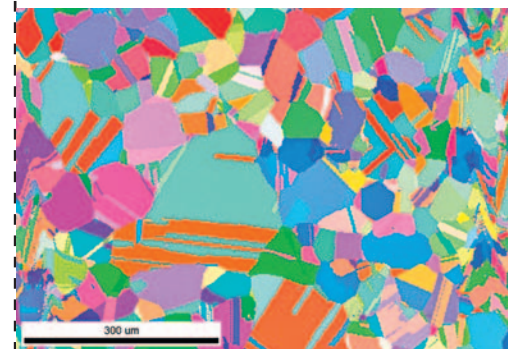

Different orientations of polycrystalline copper imaged with EBSD detector

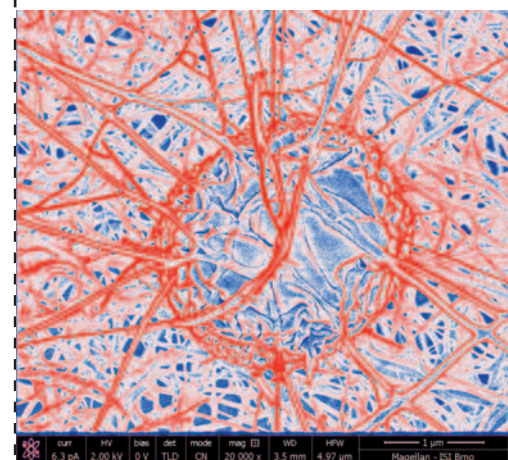

Thorium „brain“ imaged with charged neutralisation method

ACHIEVEMENTS

■ Mastering of original methods of imaging nonconductive specimens with electrons of energy below 1000 eV without their metal coating.

This method reveals the real nanostructure and microstructure of the studied sample. Recently we have focused on microstructure of dielectric layers, tissue sections, plasmonic nanoparticles, natural photonic crystals with interesting optical properties.

- F. Mika, J. Matějková-Plšková, S. Jiwajinda et al.: "Photonic Crystal Structure and Coloration of Wing Scales of Butterflies Exhibiting Selective Wavelength Iridescence", *MATERIALS* **5**, 754–771, 2012
- L. Frank, J. Nebesářová, M. Vancová, A. Paták, I. Müllerová: "Imaging of tissue sections with very slow electrons", *Ultramicroscopy* **148**, 146–150, 2015
- J. Buršík, M. Soroka, R. Uhrecký, R. Kužel, F. Mika, Š. Huber: "Thin (111) oriented CoFe_2O_4 and Co_3O_4 films prepared by decomposition of layered cobaltates", *Applied Surface Science* **376**, 209–218, 2016
- O. Brzobohatý, M. Šiler, J. Trojek, L. Chvátal, V. Karásek, A. Paták, Z. Pokorná, F. Mika, P. Zemánek: "Three-Dimensional Optical Trapping of a Plasmonic Nanoparticle using Low Numerical Aperture Optical Tweezers", *Scientific Reports*, **5**, JAN **29**, 08106:1–9, 2015
- J. Buršík, M. Soroka, R. Kužel, F. Mika: "Growth and characterization of thin oriented Co_3O_4 (111) films obtained by decomposition of layered cobaltates", *Journal of Solid State Chemistry* **227**, 17–24, 2015

■ Mastering of simulation methods for generation of signal electrons and their detection mechanism in SEM.

- F. Mika, Ch. Walker, I. Konvalina, I. Müllerová: "Imaging with STEM Detector, Experiments vs. Simulation", *Microscopy and Microanalysis* **21**, S4, 66–71, 2015
- L. Frank, F. Mika, I. Müllerová: "Optimizing the Recognition of Surface Crystallography", *Microscopy and Microanalysis* **21**, S4, 124–129, 2015

MAIN COLLABORATING PARTNERS

Collaboration with academic partners

- Brno University of Technology (Brno, CZ)
- Masaryk University (Brno, CZ)
- Tomas Bata University (Zlín, CZ)
- Institute of Inorganic Chemistry AS CR, v.v.i. (Praha, CZ)
- Institute of Analytical Chemistry AS CR, v.v.i. (Praha, CZ)
- University of Scheffield (Scheffield, UK)
- INP Greifswald e.V. (Greifswald, D)
- Institute of Physics of Materials AS CR, v.v.i. (Brno, CZ)
- University of Toyama (Toyama, Japan)

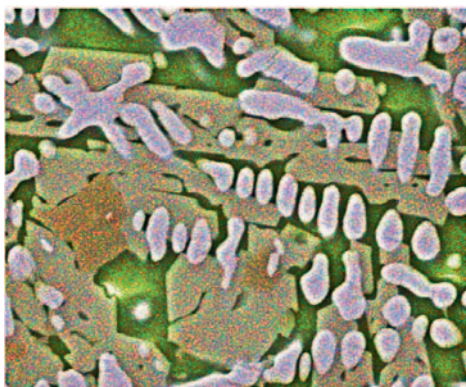

- O K α
- Al K α
- Si K α
- Ca K α
- Fe K α

EDX elemental map of an iron slag. Courtesy of Associate Professor Antonín Rek

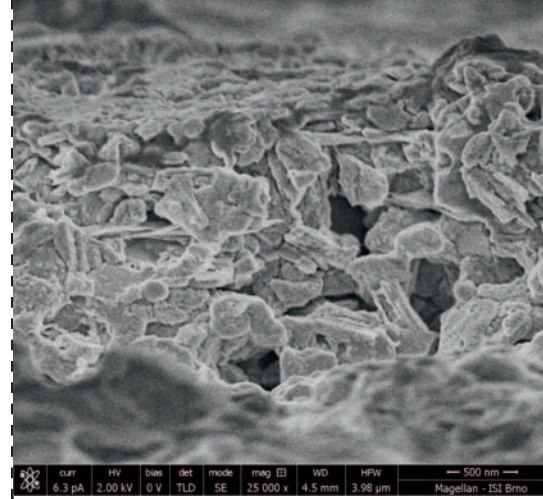

Crosssection of dielectric layer imaged without coating

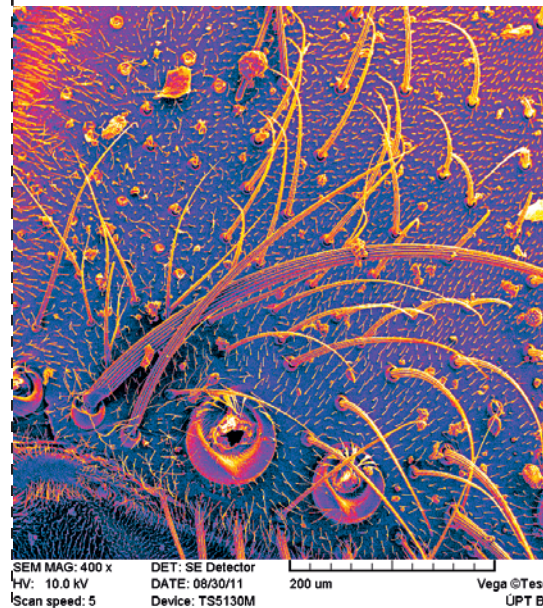

Detail of a Fly imaged with SE detector

Extreme high-resolution SEM Magellan 400



Collaboration with companies

- Contipro (Dolní Dobrouč, CZ)
- Synthesia (Pardubice, CZ)
- EID Industrial Diamonds (London, GB)
- BVT Technologies, a.s. (Brno, CZ)
- Solartec s.r.o (Rožnov pod Radhoštěm, CZ)
- SURO s.r.o. (Praha, CZ)
- Koito (Žatec, CZ)
- Precision s.r.o. (Zlín, CZ)
- HARIS DIVISION s.r.o. (Psáry, CZ)
- Automotive s.r.o. (Velké Meziříčí, CZ)
- Inventec s.r.o. (Brno, CZ)
- Autopal (Uherské Hradiště, CZ)

EXPECTATIONS

Offers

- Know-how in the field of scanning electron microscopy imaging and interpretation of results from different detection modes
- Know-how in the field of energy dispersive X-ray analysis
- Know-how in the field of Electron backscattered diffraction analysis
- Know-how in the field of Cathodoluminescence imaging and spectroscopy

Requirements

- Collaboration with industrial partners in common projects dedicated to applied science
- Knowledge and technologies for material analysis
- New complementary technologies

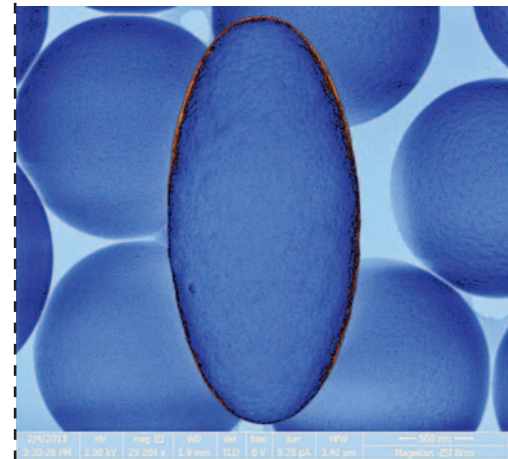

Polystyrene spheres and ellipsoids

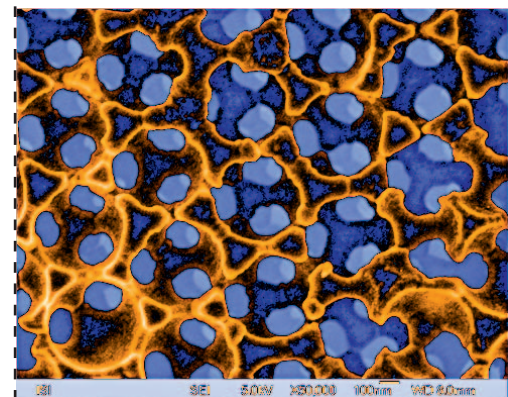

Gold sensor imaged with SE detector

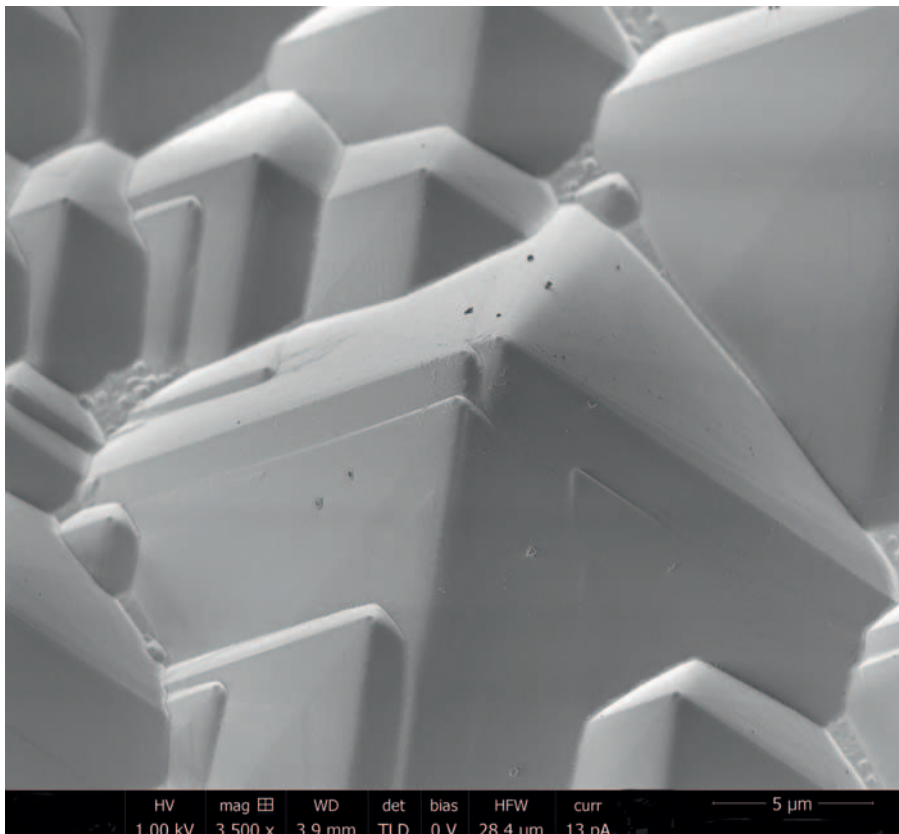

Solar panel

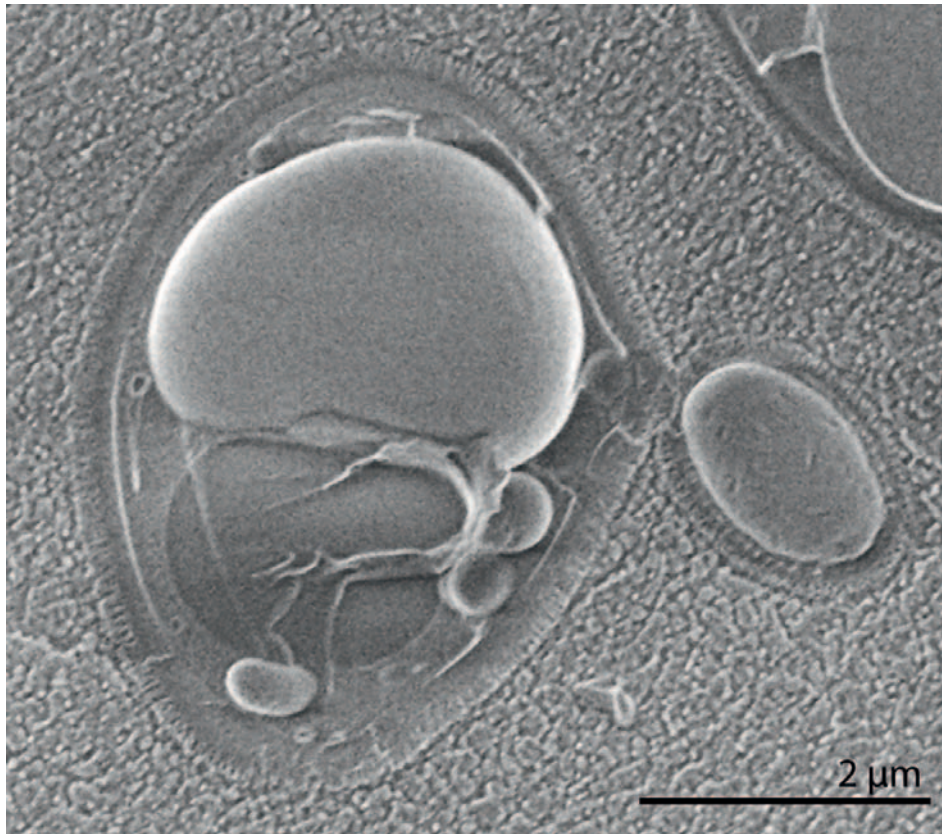

**Institute of Scientific Instruments
of the CAS, v. v. i.**
The Czech Academy of Sciences
Královopolská 147, 612 64 Brno,
Czech Republic
<http://www.isibrno.cz/bioem/>

Head: Dr. Vladislav Krzyžánek
Phone: +420 541 514 302
E-mail: krzyzane@isibrno.cz

THEMATIC RESEARCH FOCUS

Research area

- Scanning electron microscopy (SEM)
- Scanning transmission electron microscopy (STEM)
- Cryo scanning electron microscopy (cryo-SEM)
- Quantitative imaging
- Cathodoluminescence (CL)

Excellence

- Methodology and instrumentation of cryo-SEM of hydrated samples
- Quantitative imaging using annular dark-field mode in SEM, detection of very low signals, mass measurement with STEM
- Cathodoluminescence and photon collection in scintillators and screens for image formation in electron microscopy

Mission

To improve the performance of imaging and analytical systems in electron microscopy including developments of hardware, software and specific cryo sample preparation methods for soft and full-hydrated materials

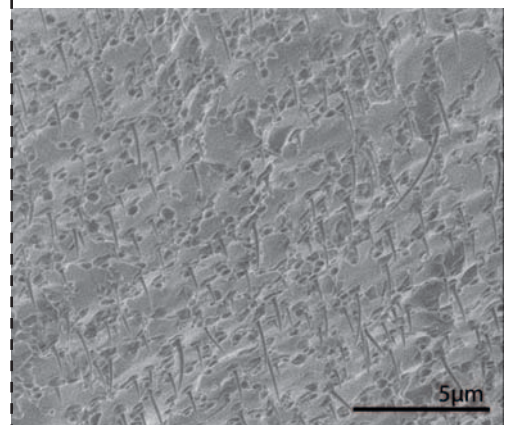

*Freeze-fracture of bacteria
Cupriavidus necator containing
PHB granules, elastic under LN2
temperatures*

UP-TO-DATE ACTIVITIES

Research orientation

- Theoretical and experimental activities related to quantitative imaging using SEM/STEM of very thin samples and nanoparticles
- Development of cryo-techniques in SEM encompassing sample processing and imaging using combined signal detection
- Conventional SEM of biological and beam sensitive samples including EDX and CL analysis
- Cathodoluminescence kinetics of fast scintillators including thin and bulk single crystals
- Scintillation detection systems design with high signal photon collection efficiency

Main capabilities

Basic research

- Theoretical simulations of electron scattering for quantitative imaging
- Experimental activities related to sample preparation for quantitative imaging and low temperature SEM (physical fixation of hydrated samples, sublimation measurements etc.)
- Study of very weak cathodoluminescence using Time Correlated Single Photon Counting (TCSPC)
- Examination of cathodoluminescence efficiency and kinetics using time-resolved spectroscopy in a large temperature range

Applied research

- Design and production of cryo-devices for sample processing and detection systems for quantitative imaging
- Applications in cryo-SEM of biological and chemical samples, and in quantitative imaging such as mass-thickness mapping and mass loss measurements of soft materials
- Cathodoluminescence characterization of new scintillator materials

Sub-fields of group activities

- Electron microscopy
- Cryo-electron microscopy
- Materials sciences (polymers, soft matter, etc.)
- Life sciences (molecular biology, tumor biology, clinical and environmental microbiology)
- Nanotechnology
- Solid state physics
- Nuclear radiation detection

KEY RESEARCH EQUIPMENT

List of devices

- Cryo-equipment extending the SEM Magellan 400 (FEI) to cryo-SEM
- Cryo-high-vacuum preparation chamber ACE600 with freeze-fracture system, and cryo-vacuum transfer system VCT100 (Leica microsystems)
- Cryo-fixation systems (plunger, propane jet)
- Detection systems for quantitative STEM imaging
- Equipment for chemical processing of biological samples (chemical fixation, critical point dryer, etc.)
- Electron beam excitation unit with an electrostatic deflection system and a blanking diaphragm
- UV light collection and transmission system with a Horiba Jobin Yvon iHR320 spectrometer
- Utilization of equipment of the Group of Microscopy and Microanalysis

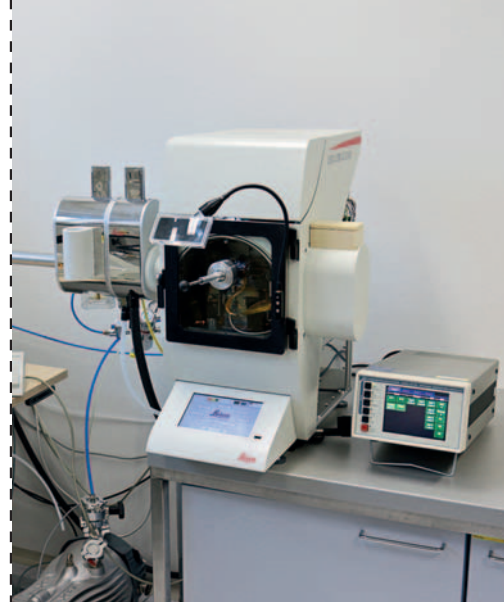

Equipment for cryo-SEM sample preparation

ACHIEVEMENTS

We have been focused on instrumental and methodological research in the fields of signal detection with its theoretical description and calibration, sample preparation and sublimation experiments for the low temperature SEM. In the last five years we published about 30 papers in impacted journals with a good citation response, and about 40 longer contributions in conference proceedings or local journals.

■ Cryogenic scanning electron microscopy (cryo-SEM)

Instrumental and methodological developments in cryo-SEM, e.g. combination of high-pressure-freezing on sapphire discs with cryo-SEM imaging.

- V. Krzyžánek, K. Hrubanová, J. Nebesářová, F. Růžička: "Cryo-SEM of Perpendicular Cross Freeze-Fractures Through a High-Pressure-frozen Biofilm", *Microscopy and Microanalysis* **20**, S3, 1232–1233, 2014
- FEI/CSMS scholarship awarded to Kamila Hrubanová (2015–2017)
Structure investigations of bacterial and yeast biofilms using cryo-SEM
- O. Samek, S. Bernatová, J. Ježek, M. Šiler, M. Šerý, V. Krzyžánek, K. Hrubanová, P. Zemánek, V. Holá, F. Růžička: "Identification of individual biofilm-forming bacterial cells using Raman tweezers", *Journal of Biomedical Optics* **20**, 051038:1–6, 2015
Investigations of PHB granules produced by bacteria under specific conditions
- S. Obruca, P. Sedlacek, V. Krzyzaneck, F. Mravec, K. Hrubanova, O. Samek, D. Kucera, P. Benesova, I. Marova: "How accumulation of poly(3-hydroxybutyrate) helps bacterial cells to survive freezing", *PLoS ONE* **11**, e0157778, 2016

■ Quantitative imaging using the transmission mode in SEM

Instrumental and methodological developments in quantitative imaging including samples preparation, electron scattering simulation, data recording with required calibrations.

- S. Tacke, V. Krzyzaneck, H. Nüsse, R. Wepf, J. Klingauf, R. Reichelt: "A versatile high-vacuum cryo transfer system for cryo microscopy and analytics", *Biophysical Journal* **110**, 758–765, 2016
- V. Krzyžánek, S. Tacke, K. Hrubanová, R. Reichelt: "Beyond Imaging: Scanning Electron Microscope for the Quantitative Mass Measurement", *Microscopy and Microanalysis* **19**, S2, 130–131, 2013
Applications of STEM quantitative imaging.
- J. Hajduová, K. Procházka, V. Raus, M. Šlouf, V. Krzyžánek, V. M. Garamus, M. Štěpánek: "Structure of polymeric nanoparticles in surfactant-stabilized aqueous dispersions of high-molar-mass hydrophobic graft copolymers", *Colloids and Surfaces. A - Physicochemical and Engineering Aspects* **456**, 10–17, 2014
- V. Novotná, K. Hrubanová, J. Nebesářová, V. Krzyžánek: "Investigation of Electron Beam Induced Mass Loss of Embedding Media in the Low Voltage STEM", *Microscopy and Microanalysis* **20**, S3, 1270–1271, 2014

■ Conventional electron microscopy of biological, medical and chemical samples

- S. Voběrková, S. Hermanová, K. Hrubanová, V. Krzyžánek: "Biofilm formation and extracellular polymeric substances (EPS) production by *Bacillus subtilis* depending on nutritional conditions in the presence of polyester film", *Folia Microbiologica* **61**, 91–100, 2016
- Y. Resch, K. Blatt, U. Malkus, C. Fercher, I. Swoboda, M. Focke, K.-W. Chen, S. Seiberler, I. Mittermann, C. Lupinek, A. Rodriguez-Dominguez, P. Zieglmayer, R. Zieglmayer, W. Keller, V. Krzyzaneck, P. Valent, R. Valenta, S. Vrtala: "Molecular, Structural and Immunological Characterization of Der p 18, a Chitinase-Like House Dust Mite Allergen", *PLoS ONE* **11**, e0160641, 2016

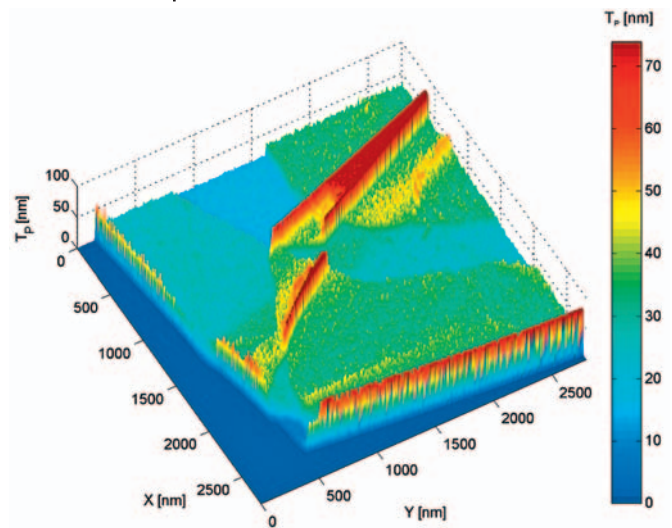

Randomly folded very thin carbon film: ADF STEM image and projected thickness map

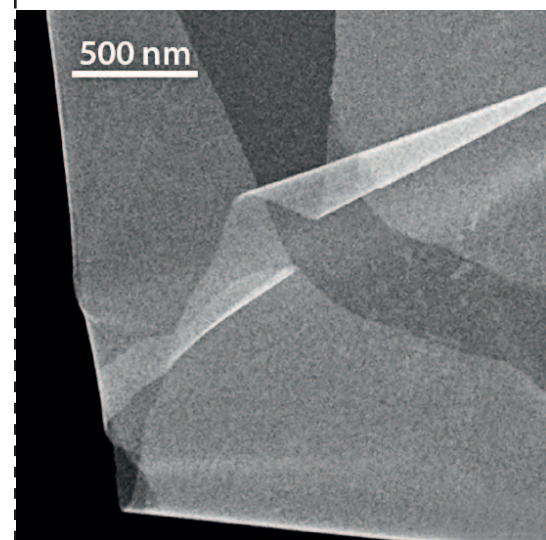

■ Cathodoluminescence (CL) measurements

New method of performance characterization of SEM detectors.

- J. Bok, P. Schauer: "Performance of SEM scintillation detector evaluated by modulation transfer function and detective quantum efficiency function", *Scanning* **36**, 384–393, 2014
Promising scintillator improving SEM detectors efficiency.
- J. Bok, O. Lalinský, M. Hanuš, Z. Onderišinová, J. Kelar, M. Kučera: "GAGG:ce single crystalline films: New perspective scintillators for electron detection in SEM", *Ultramicroscopy* **163**, 1–5, 2016
Strong innovation of the CL apparatus enabling much deeper CL studies thanks to the temperature-controlled specimen holder.
- J. Bok, P. Schauer: "Apparatus for temperature-dependent cathodoluminescence characterization of materials", *Measurement Science and Technology* **25**, 075601, 2014
Cooperation with CRYTUR company on improving scintillators.
- J. Bok, P. Horodský, V. Krzyžánek: "Effect of oxidation annealing on optical properties of YAG:Ce single crystals", *Optical Materials* **46**, 591–595, 2015

For more details and publications see www.isibrno.cz/bioem.

MAIN COLLABORATING PARTNERS

Collaboration with academic partners

- University of Münster (Münster, DE)
- ETH (Zurich, CH)
- National Institute of Health (Bethesda, USA)
- The University of Queensland (Brisbane, Australia)
- Brno University of Technology (Brno, CZ)
- Masaryk University (Brno, CZ)
- St. Anne's University Hospital (Brno, CZ)
- Biology Centre of the CAS (České Budějovice, CZ)
- Institute of Macromolecular Chemistry of the CAS (Praha, CZ)
- Charles University (Praha, CZ)
- Institute of Physics of the CAS (Praha, CZ)
- Tomáš Baťa University in Zlín (Zlín, CZ)

Collaboration with companies

- CRYTUR (Turnov, CZ)
- Microscopy Improvements (Eisenstadt, Austria)
- Leica Microsystems (Vienna, Austria)

EXPECTATIONS

Offers

- We offer collaboration in our areas of expertise
- Partnership in international projects

Requirements

We look for cooperation with academic partners as well as companies in the fields of electron microscopy, nanotechnologies, applications of SEM/STEM techniques including cryo-techniques in biological, medical and soft matter research, material characteristics, applications of scintillators and imaging screens.

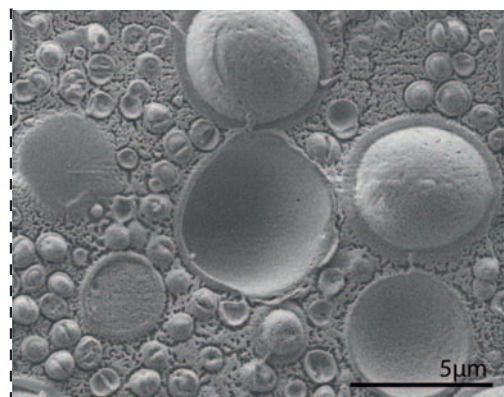
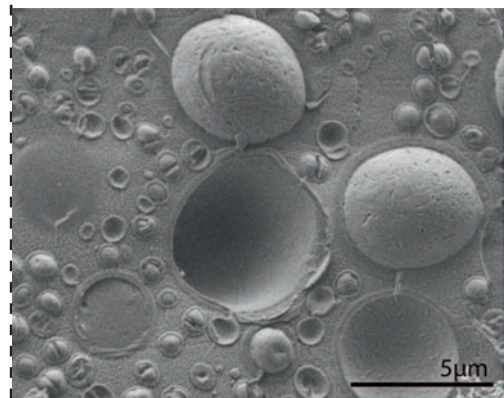

Progressive sublimation exposing inner structure of microbial biofilm (Staphylococcus epidermidis, Candida parapsilosis)

Group of Environmental Electron Microscopy (EEM)

Department of Electron Microscopy



ISI
CAS
Institute of Scientific
Instruments
The Czech Academy
of Sciences

THEMATIC RESEARCH FOCUS

Research area

- Scanning & Environmental scanning electron microscopy (SEM/ESEM)
- Environmental and scanning transmission electron microscopy (Wet-STEM/STEM)
- Signal electron and photon detection systems
- Energy dispersive X-Ray spectroscopy
- Computer based simulations for SEM/ESEM



Excellence

- Low dose micro-morphological characterisation of untreated wet biological samples and polymers in ESEM
- Dynamical in-situ observation on the phase boundaries/transitions of matters and under well balanced thermodynamic conditions in ESEM & electron microscopy for ice chemistry
- Monte-Carlo simulations of electron-gas, electron-water and electron-solid interactions in ESEM
- High-resolution imaging and X-ray micro-analysis of non/semi conductive samples in ESEM
- Research, development, and manufacturing of very high efficient detectors of signal electrons for SEM/ESEM
- Gas flow and heat transfer simulations for R&D of custom instrumentation for SEM/ESEM

Mission

To be the world leader in the low dose/energy environmental scanning electron microscopy and at the forefront in the field of static or dynamic in-situ characterisation of low emissive, beam sensitive, mostly non-conductive wet samples observed in their native state. To invent new methods, instrumentation, and applications for further exploration of the nano-world.

Institute of Scientific Instruments
of the CAS, v. v. i.

The Czech Academy of Sciences
Královopolská 147, 612 64 Brno,
Czech Republic
<http://eem.isibrno.cz>

Head: Vilém Neděla, Ing., Ing., Ph.D.
Phone: +420 541 514 333
E-mail: vilem@isibrno.cz

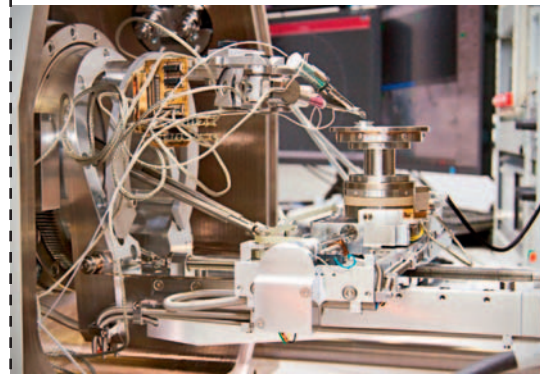

Laboratory of environmental electron
microscopy with high resolution ESEM
QUANTA 650 FEG (left) equipped with
micromanipulators (right)

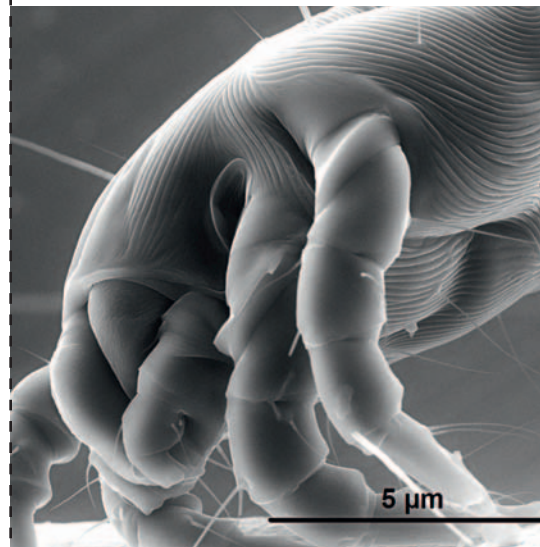

Live Mite observed in the ESEM
AQUASEM II

UP-TO-DATE ACTIVITIES

Research focus

- Theoretical and experimental activities related to pushing boundaries of ESEM capabilities (development of new ESEM designs, new detectors)
- Dynamical in situ characterisation of samples under different physical and chemical impacts, etc.
- Morphological and structural analysis of natural or live samples

Main capabilities

Basic research

- Theoretical simulations of electron-gas, electron-water and solid interactions
- Theoretical simulations of gas flow and heat transfer in ESEM
- New methodology for low dose observation and chemical analysis of native biological samples

Applied research

- Design and conversion of SEM Vega (Tescan) to experimental ESEM AQUASEM II
- Design and manufacturing of the HAADF detector for Hitachi TEM, the BSE detector for Jeol SEM-JSM 5600LV, the new „edge-free“ detector for Hitachi SEM, the YAP detector for Jeol SEM, the Scintillation SE detector for ESEM and other prototypes of BSE detectors (over 50 pieces) for Jeol, Hitachi & FEI

Innovations

- New Ionisation SE detector with electrostatic separator for ESEM (EU patent No. 2195822)

Sub-fields of group activities

- Micro/nanotechnology
- Biology/biotechnology, chemistry
- Semiconductor industry/electronics
- Pharmaceutical industry
- Textile industry
- Building materials
- Automotive

KEY RESEARCH EQUIPMENT

List of devices

- Environmental scanning electron microscopes AQUASEM II, QUANTA 650 FEG
- Scintillation BSE detectors (YAG, YAP and CRY018 scintillators)
- X-Ray EDS analyzer Bruker XFlash 6/60 + mapping (EDS microanalysis in SEM/ESEM)
- Many types of special detectors (ET, GAD, LFD, GSED, ICD, DBS, CL, scintillation SE detector, ISEDS)
- Kleindiek micromanipulators, EBIC, RCI amplifier, gas and liquid micro-injectors & hydration system
- Peltier cooling stage and heating stage (from -20°C to +1000°C)
- Retractable solid state WetSTEM/STEM detector

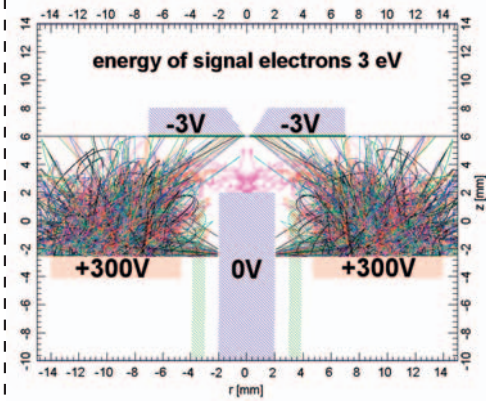
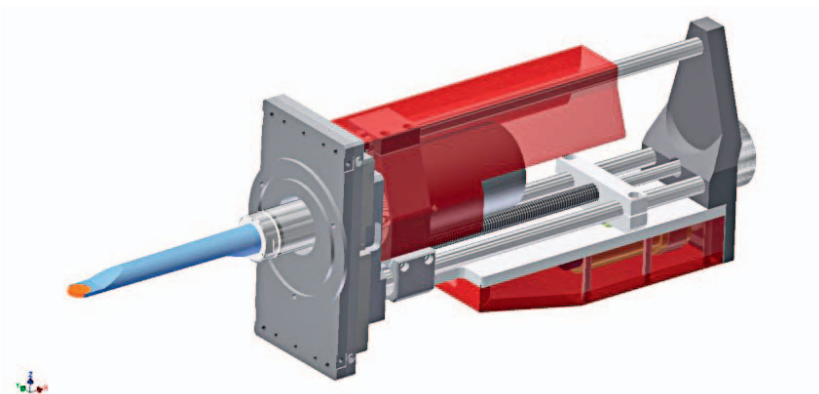

Monte Carlo simulation of electron trajectories in gas (ESEM conditions)

Monte Carlo simulations of electron-solid sample interactions (C-Si multilayer)

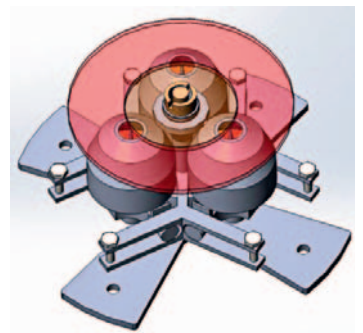
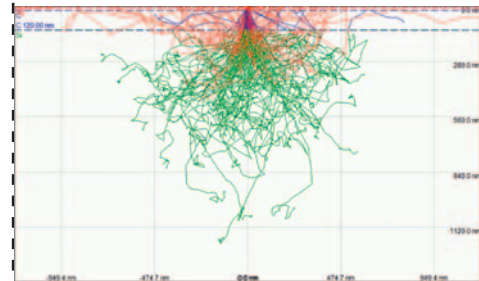

New version of patented ISEDS with magnetic field (new detector for ESEM)

New scintillation BSE detector for SEM and ESEM (left) and hydration system (right)



ACHIEVEMENTS

Awards

Kenbikyo Award 2016 – excellent paper of the journal for last two years (Japanese society of microscopy award). The best Ph.D. thesis (Czechoslovak Microscopy Society award), 2nd place in the event the Best doctoral thesis in the field of Building rehabilitation and reconstruction (Scientific and Technical Association for Building Rehabilitation and Monument Preservation award).

Papers

We are pushing the limits of possibilities of imaging and analysis of untreated, electrically non-conductive/semi-conductive and wet or liquid samples in ESEM. We are specialized in the characterization of difficult to see and advanced materials using our developed new methods and unique instrumentation.

■ **Pioneering theoretical results of Monte Carlo simulations of electron-gas interactions and signal electron transportation in gas owing to the collection efficiency of segmented ionization detector for signal electrons with selected energies from units of eV to 18 keV.**

- V. Neděla, et al., *Microscopy and Microanalysis* **21**(4), 264, 2015
- V. Neděla, et al., *Microscopy and Microanalysis* **21**(3), 1109, 2015

■ **Significant theoretical work focused on calculations of higher-order deflections aberrations of the electron-optical system used for environmental scanning electron microscopy and possibility of their dynamical corrections. This work indicates future trends in the ESEM.**

- M. Oral et al., *Microscopy and Microanalysis* **21** (4), 194, 2015

■ **World unique experimental results were attained by studying ice contamination processes at grain boundaries in environmentally compatible conditions of a high gas pressure and a relatively high temperature in a specially modified ESEM in a combination with fluorescence microscopy.**

- J. Krausko et al., *Langmuir* **30** (19), 5441, 2014

■ **A new method for the high-resolution morphological study of plant samples in their native state. Method also allows increasing sample resistance to radiation damage by the electron beam. This method was invented and experimentally tested on many types of plant biological samples in our laboratories.**

- V. Neděla et al., *Microsc Res Tech*. **78**, 13, 2015
- V. Neděla et al., *Biologia Plantarum* **56** (3), 595, 2012

■ **Based on the results of Monte Carlo simulations of an electron beam with water involving study of free radicals concentration, a new, extremely sample-preserving method was introduced. It allows studying of small live and surviving animals like mites in ESEM. The method presents basic research in the new field of live organism observation in the conditions of a high pressure, a low electron energy, and a low beam current, utilizing advanced instrumentation systems.**

- E. Tihlaříková et al., *Microscopy and Microanalysis* **19** (4), 914, 2013
- V. Neděla et al., *Kenbikyo*. **49** (1), 64, 2014

■ **Based on optimization of the new method for study of live samples and in combination with our unique high efficient detectors of signal electrons for ESEM, a new method for morphological characterization of very beam sensitive wet polyelectrolyte complex microcapsules containing a semi liquid core with live cells was introduced. Our**

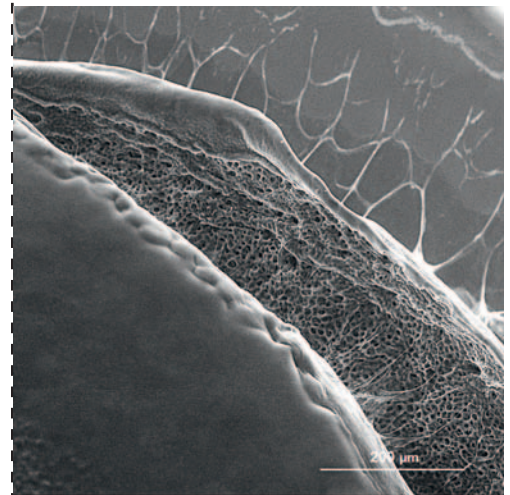

Wet polyvinyl-alcohol lances (LentiCat™) in native state in ESEM

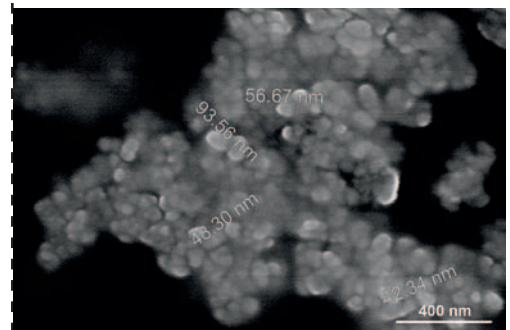

Uncoated zinc oxide nanoparticles in ESEM

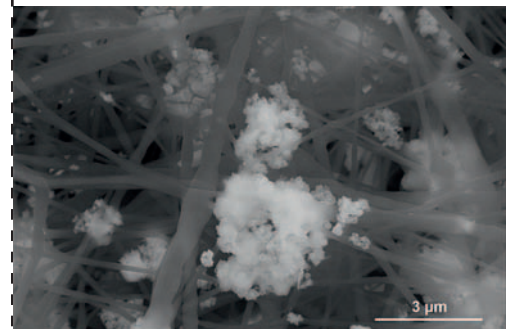

Uncoated surface of PUR with 10% CuO₂ nanoparticles (ESEM for textile industry)

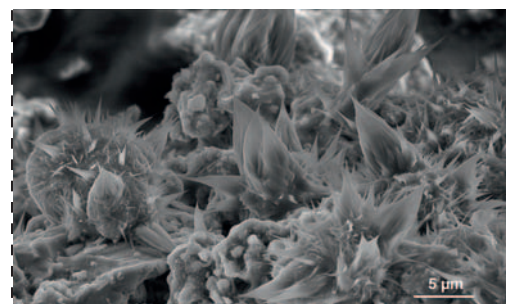

Alkali-activated steel making slag in ESEM (Uncoated surface)

laboratory is the only one in the world able to observe these types of samples free of destruction or damage.

- A. Bertóková et al., *Biocatalysis and Biotransformation* **33** (2), 111, 2015
- A. Schenk Mayerová et al., *Applied Biochemistry and Biotechnology*, **174** (5), 1834, 2014

Patents

The ISEDS allows to reach one of the world highest detection efficiency and is possible to detect low energy signal electrons within optional energy range and with very high signal to noise ration.

New Ionisation SE detector with electrostatic separator for ESEM (CZ patent No. 299864, EU patent No. 2195822)

For more details and publications see eem.isibrno.cz

MAIN COLLABORATING PARTNERS

Collaboration with academic partners

- University of Cambridge (Cambridge, GB)
- University of Kyoto (Kyoto, JP)
- University of Nagoya (Nagoya, JP)
- Wrocław University of Science and Technology (Wrocław, PL)
- University of technology Sydney (Sydney, AS)
- Charles University (Praha, CZ)
- Brno University of Technology (Brno, CZ)
- Masaryk University (Brno, CZ)
- Mendel University (Brno, CZ)
- Institute of Experimental Botany CAS (Praha, CZ)
- Institute of Chemistry, Slovak Academy of Sciences (Bratislava, SK)

Collaboration with companies

- Hitachi High Technologies (Tokyo, JP)
- Jeol (Tokyo, JP)
- FEI Czech Republic, s.r.o. (Brno, CZ)
- Tecpa s.r.o. (Brno, CZ)
- AutraDet (Brno, CZ)

EXPECTATIONS

Offers

We offer collaboration in the field of research and testing of a wide range of difficult to observe samples in SEM/ESEM. Study of materials under dynamically changing conditions using unique electron microscopes, advanced instrumentations and methods. Partnership in local and international scientific or company projects.

Custom research, development and manufacturing of special detection systems and advanced instrumentation for electron microscopes. Theoretical studies from the field of electron-gas/liquid/solid interactions and gas flow simulations for R&D of environmental electron microscopes.

Requirements

We look for cooperation with academic partners as well as companies in the fields of electron microscopy, physical, life and applied sciences as biology, chemistry, pharmacy, micro & nano-technologies, automotive, etc.

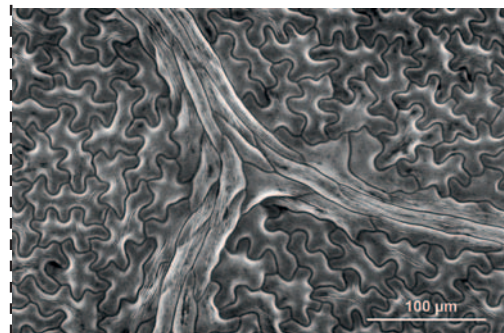

Fully expanded apple leaf, adaxial epidermis formed by puzzle-like cells (ESEM for plant biology)

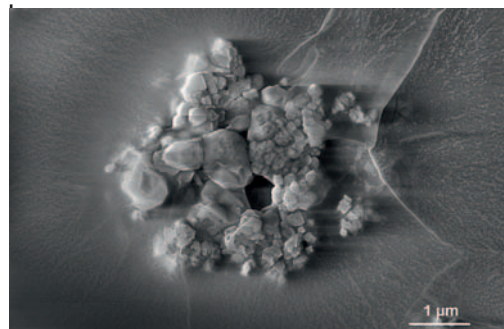

Uncoated SiO₂ nanoparticles in epoxy resin (ESEM for micro/nanotechnology and electronics)

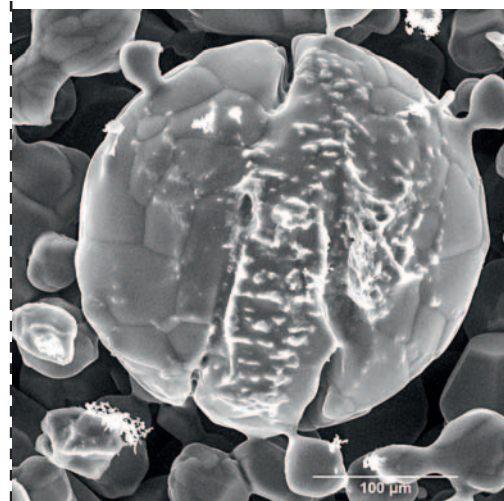

Ice particle with pollutants (ESEM for ice chemistry)

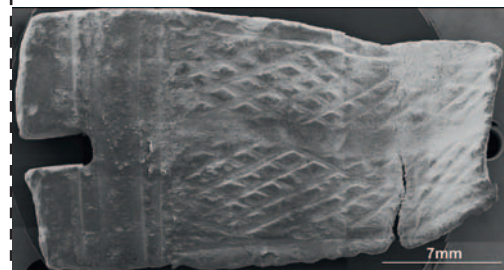

Uncoated buckle (ESEM for archaeology)

Group of Magnetic Resonance (MR)

Department of Magnetic Resonance and Cryogenics



Institute of Scientific
Instruments
The Czech Academy
of Sciences

THEMATIC RESEARCH FOCUS

Research areas

- Customization and development of methods and applications of ultra-high-field magnetic resonance imaging and spectroscopy of small laboratory animals (mouse, rat, rabbit), excised organs, and in vitro samples for selected areas of multidisciplinary research.
- Quantitative MR imaging of relaxation, diffusion, perfusion, blood flow, metabolites, water/fat:
 - perfusion measurement, mathematical modelling of pharmacokinetics,
 - MR spectroscopic data analysis, MR physics simulation for metabolite quantitation and method development.

Excellence

- In vivo MR spectroscopy – computer simulation of NMR dynamics of coupled spin systems
- In vivo MR measurement of perfusion, and pharmacokinetics modelling

Mission

- Transform own research in MR physics and related areas into progress in quantitative MR imaging and spectroscopy – transform the prevailing MR paradigm of marker detection into quantitative, robust, accurate and precise measurement of well-defined biophysical, biochemical or physiological properties, whose potential of interinstitutional transferability will support biomedical research and development and medical diagnostics and will contribute to better understanding of pathophysiological processes.
- Provide MR measurements implementing the goals stated above, including adequate animal services, to external research and development clients under the framework of large research infrastructures Czech-Biolmaging and Euro-Biolmaging, and to contribute to the establishment of high-quality standards in these consortia.

UP-TO-DATE ACTIVITIES

Research focus

- MR-data quality improvement by
 - artefact avoidance and quality-assurance filtering of raw data
 - advanced data modelling, robust estimation of model parameters
- Experimental and data-analysis techniques for quantitative MR imaging and spectroscopy – hierarchical data modelling of MR physics and physiology:
 - perfusion measurement protocols, data analysis algorithms for pharmacokinetics modelling, development of web-based perfusion analysis software PerfLab
 - spectroscopy protocols, development of program NMRScopeB for quantum-mechanical simulation, and collaborative improvement of quantitation software jMRUI
- Exploration of the potential of synergies of multiparametric/multimodal imaging
- Method optimization with regard to animal measurement constraints and economics. Extending the current MR spectroscopic simulation possibilities of program NMRScopeB to more complex experiments and improving the utility of

Institute of Scientific Instruments
of the CAS, v. v. i.

Czech Academy of Sciences

Královopolská 147, 612 64 Brno,
Czech Republic

<http://www.isibrno.cz/mr>

Head: Zenon Starčuk jr.

Phone: +420 739 451 114

E-mail: starcuk@isibrno.cz



Biomedical 9.4T MR scanner equipped for
mouse, rat and rabbit imaging

the current quantitation software jMRUI, based on users' feedback, own testing and using modern computer technology

- Development of perfusion measurement protocols, pharmacokinetic models and data analysis algorithms based on own validation experiments, and development of web-based perfusion analysis software PerfLab

Main capabilities

Basic research

- Development of customized MR protocols (sample preparation, MR measurement, data analysis)
- MR data analysis for the measurement of relaxation, diffusion, perfusion, spectroscopy
- Pulse sequence design and analysis by computer simulation of spin system evolution
- Validation of measurement protocols and data analysis by phantom studies

Applied research

- Support for studies in pathophysiology, development of diagnostics, therapeutic procedures and drugs in translational research in oncology, neurology, cardiology or regenerative medicine by multiparametric MR examinations of small laboratory animals
- Testing of experimental molecule or nanoparticle-based carriers for targeted delivery of imaging markers and drugs by relaxometric in vitro and multiparametric in vivo MR imaging
- Support for plant research, study of the properties of technical and natural gels (e.g. for geology or industries), characterization of porous materials

Sub-fields of group activities

- Biomedical research - (patho)physiology, diagnostics, therapy monitoring
- Nanotechnologies for (bio)medicine
- Pharmaceuticals
- Processes in natural and industrial gels



Rack for individually ventilated cages for accommodation of mice

KEY RESEARCH EQUIPMENT

List of devices

- MR scanner 9.4T/30cm Bruker Avance III 94/30 (¹H 400 MHz), 200 mT/m gradients, 660 mT/m gradient insert for microimaging, multinuclear equipment (³¹P, ¹³C, ¹⁹F, ²³Na, ¹²⁹Xe), RF coils for mouse/rat/rabbit measurement, 2 transmit, 4 receive channels, software ParaVision 5.1 and 6.0.1
- general anesthesia (isoflurane, N₂O), vital function monitor SAI 1030, artificial ventilation, animal bed heating
- minisurgery room

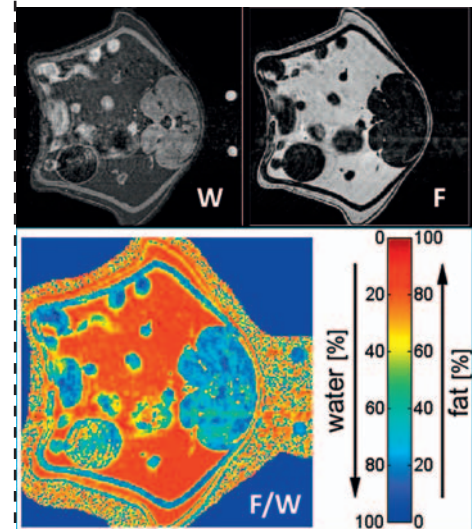

Quantification of water and fat fractions in the mouse body

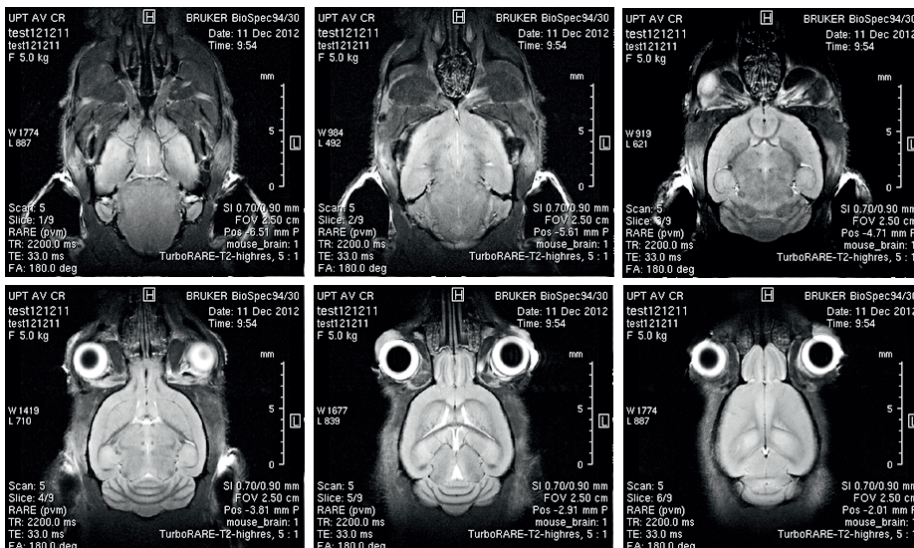

Anatomical T₂ weighted images of a mouse brain

- animal facility for about 200 mice and 100 rats with overpressure and EU14 filtration, animals in individually ventilated cages, hygienic loop, autoclave, UV sterilization chamber, laminar flow boxes for animal handling, minisurgery room
- wet lab with fume chamber, deep freezer (-80°C), cadaver freezer
- MR scanner 4.7T/20cm with magnet Magnex Sci. Ltd., console and electronics MR Solutions MR6000, 1kW RF amplifier CPCamps 5T1000M, gradients 180 mT/m, Gz insert 1000 mT/m

ACHIEVEMENTS

- **Ultra-short echo-time spectroscopic techniques exhibiting particularly robust water suppression and low contamination, developed in ISI long ago, have become a worldwide standard and make it possible to reliably determine more than 20 metabolites in brain MR spectra.**

– I. Tkáč, Z. Starčuk, I.-Y. Choi, R. Gruetter: "In Vivo 1H NMR Spectroscopy of Rat Brain at 1 ms Echo Time"; *Magnetic Resonance in Medicine* **41**, 649–656, 1999

- **A simulator of coupled spin systems undergoing relaxation and spatially/frequentially-inhomogeneous excitation (NMRScopeB) has been developed and integrated into jMRUI software, used at over 2500 institutions worldwide.**

– D. Stefan, F. Di Cesare, A. Andrasescu, E. Popa, A. Lazariiev, E. Vescovo, O. Strbak, S. Williams, Z. Starčuk, M. Cabanas, D. van Ormondt, D. Graveron-Demilly:

"Quantitation of magnetic resonance spectroscopy signals: the jMRUI software package", *Meas. Sci. Technol.* **20**, 104035, 9p., 2009

– Z. Starčuk, J. Starčuková: "Quantum-mechanical simulations for in vivo MR spectroscopy: principles and possibilities demonstrated with the program NMRScopeB", *Analytical Biochemistry* **529**, 79–97, 2017

- **Techniques or protocols for accurate measurement of material properties (magnetic susceptibility, relaxivity) have been developed and applied in practical studies.**

– J. Tuček, Z. Sofer, D. Bouša, M. Pumera, K. Holá, A. Malá, K. Poláková, M. Havrdová, K. Čepe, O. Tomanec, R. Zbořil: "Air-stable superparamagnetic metal nanoparticles entrapped in graphene oxide matrix", *Nature Communications* **7**, DOI: 10.1038/ncomms12879, 2016

– J. Starčuková, Z. Starčuk, H. Hubálková, I. Linetskiy: "Magnetic susceptibility and electrical conductivity of metallic dental materials and their impact on MR imaging artifacts", *Dental materials* **24**, 715–723, 2008

– R. Kořínek, J. Vondrák, K. Bartušek, M. Sedlaříková: "Experimental investigations of relaxation times of gel electrolytes during polymerization by MR methods", *J. Solid State Electrochem* DOI 10.1007/s10008-012-1715-6, 2012

- **Models and algorithms have been developed for the analysis of perfusion based on MR measurement in animals and humans. This development aids the diagnostics, therapy development, and basic research of pathophysiology.**

– M. Bartoš, R. Jiřík, J. Kratochvíla, M. Standara, Z. Starčuk, T. Taxt: "The precision of DCE-MRI using the tissue homogeneity model with continuous formulation of the perfusion parameters", *Magnetic Resonance Imaging* **32**, 505–513, 2014

– J. Kratochvíla, R. Jiřík, M. Bartoš, M. Standara, Z. Starčuk, T. Taxt: "Distributed capillary adiabatic tissue homogeneity model in parametric multi-channel blind AIF estimation using DCE-MRI", *Magnetic Resonance in Medicine* **75**, 1355–1365, 2016

– E. Eskilsson, G.V. Rosland, K.M. Talasila, S. Knappskog, O. Keunen, A. Sottoriva, S. Foerster, G. Solecki, T. Taxt, R. Jiřík, S. Fritah, P. N. Harter, K. Vålk, J. Al Hossein, J. V. Joseph, R. Jahedi, H. S. Saed, S. G. Piccirillo, I. Spiteri, P. Euskirchen, G. Graziani, T. Daubon, M. Lund-Johansen, P. Ø. Enger, F. Winkler, C. A. Ritter, S. P. Niclou, C. Watts, R. Bjerkvig, H. Miletic: "EGFRVIII mutations can emerge as late

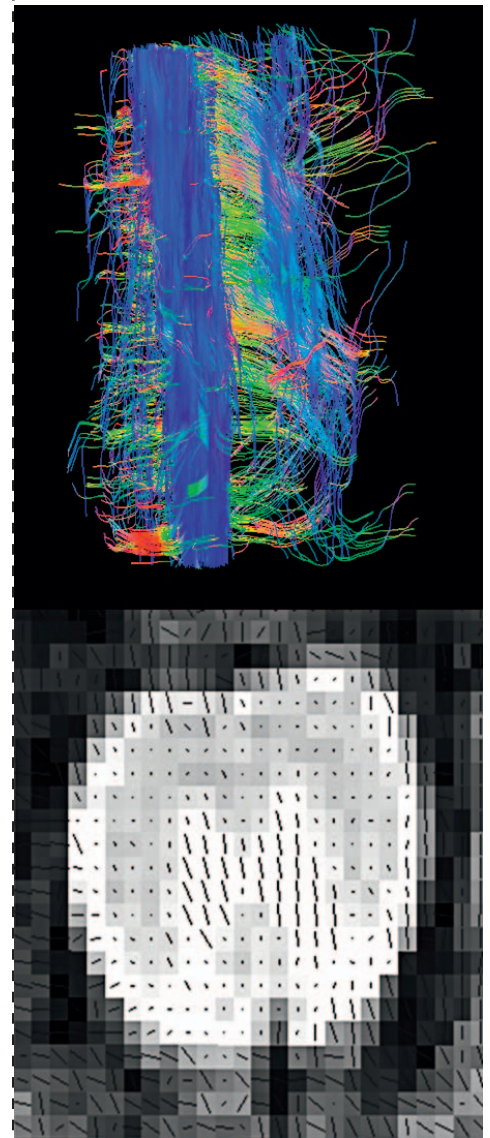

Neuronal fibre tracking based on diffusion tensor imaging in rat spinal cord

and heterogenous events in glioblastoma development and promote angiogenesis through Src activation”, Neuro-Oncology DOI: 10.1093/neuonc/now113, 2016

■ Diffusion measurement has been applied in the search for potential early-stage markers of Parkinson’s disease

- A. Khairnar, P. Latta, E. Dražanová, J. Rudá-Kučerová, N. Szabó, A. Arab, B. Hutter-Paier, D. Havas, M. Windisch, A. Šulcová, Z. Starčuk, I. Rektorová: “Diffusion Kurtosis Imaging Detects Microstructural Alterations in Brain of α -Synuclein Overexpressing Transgenic Mouse Model of Parkinson’s Disease: A Pilot Study”, Neurotoxicity Research **28**, 281–289, 2015
- A. Khairnar, J. Rudá-Kučerová, E. Dražanová, N. Szabó, P. Latta, A. Arab, B. Hutter-Paier, D. Havas, M. Windisch, A. Šulcová, Z. Starčuk, A. Király, I. Rektorová: “Late-stage α -synuclein accumulation in TNWT-61 mouse model of Parkinson’s disease detected by diffusion kurtosis imaging”, Journal of Neurochemistry **136**, 1256–1269, 2016

MAIN COLLABORATING PARTNERS

Collaboration with academic partners

- Masarykova univerzita (Brno, CZ), Vysoké učení technické (Brno, CZ), Fakultní nemocnice u sv. Anny – ICRC (Brno, CZ), Biofyzikální ústav AV ČR (Brno, CZ), Univerzita Palackého (Olomouc, CZ), Veterinární a farmaceutická univerzita (Brno, CZ), Ústav makromolekulární chemie AV ČR (Praha, CZ), Ústav živočišné fyziologie a genetiky AV ČR (Brno, CZ), Ústav molekulární genetiky AV ČR (Praha, CZ), Výzkumný ústav veterinárního lékařství (Brno, CZ)
- Katholieke Universiteit Leuven (Leuven, BE), Ecole Polytechnique Fédérale de Lausanne (Lausanne, CH), Université Claude Bernard Lyon 1 (Lyon, FR), University of Manchester (Manchester, UK), Max Planck Institute for Human Cognitive and Brain Sciences (Leipzig, DE), Radboud University Nijmegen Medical Centre (Nijmegen, NL), Universitat Autònoma de Barcelona (Barcelona, ES), Universitat de Barcelona (Barcelona, ES), University of Bern (Bern, CH), University of Bergen (Bergen, NO)

Collaboration with companies

- Philips Healthcare (Nijmegen, NL), Siemens Healthcare (Erlangen, DE), GE Healthcare (USA), icoMetrix (Leuven, BE)

EXPECTATIONS

Offers

- Development and execution of MR measurement protocols and data analysis methods for specific applications (multiparametric testing of contrast agents, pharmacokinetics, pharmacodynamics, therapeutic procedures in animal models, characterization of gels or porous materials, MR imaging of small diamagnetic objects)
- Collaboration in development, preparation, validation of an animal model, assistance in animal use protocol preparation, arrangement of complementary examinations
- Open access via Czech-Biolmaging (www.isibrno.cz/czbi, www.czech-bioimaging.cz)

Requirements

- We seek scientifically interesting applications with societal impact on medicine or industry.
- We offer collaboration in MR technology development.

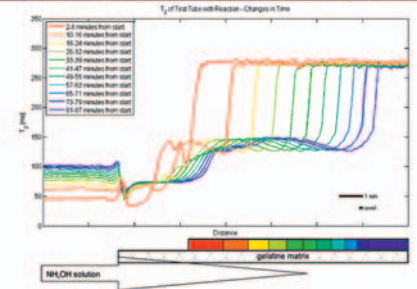
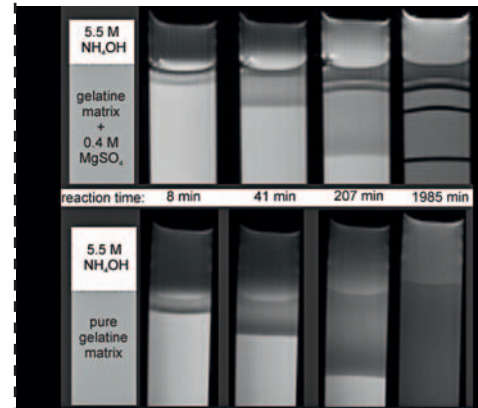

Dynamic study of the formation of Liesegang rings in a reaction-diffusion process in a gel modelling a natural geologic process; MR-observation of changes in T_2 relaxation

T_1 -weighted images of rat heart

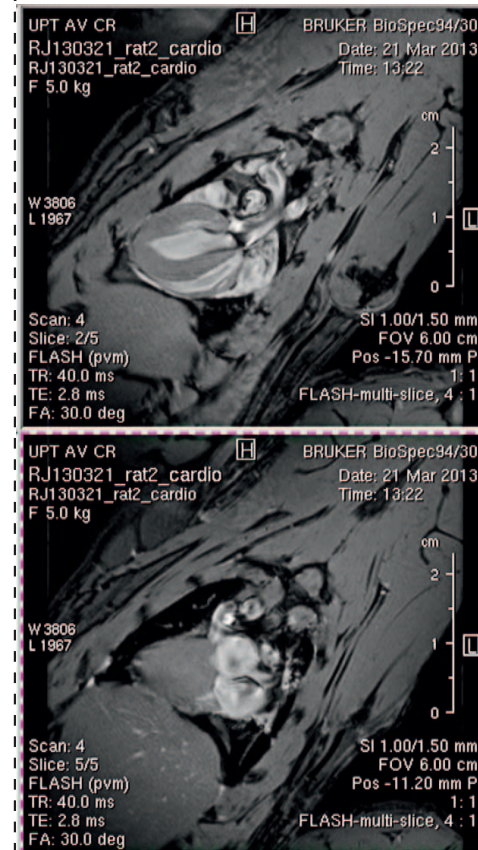

THEMATIC RESEARCH FOCUS

Research area

- Low temperature physics
- Cryogenics
- Thermal radiation and near field heat transfer
- Fluid dynamics, turbulence
- Quantum phase transitions
- Applied superconductivity

Excellence

- Basic research in fluid dynamics – Rayleigh-Bénard cryogenic convection
- Characterization of thermal radiative properties of materials for cryogenics and space applications
- Near field heat transfer at low temperatures
- Quantum phase transitions in mesoscopic systems
- Design and optimization of special cryogenic systems
- Design of special superconducting magnet systems

Mission

- Deeper understanding of turbulence - one of unsolved problems of modern physics on both classical and quantum levels
- Experimental verification of theory of near field heat transfer
- Expanding of our unique material database of thermal radiative properties and understanding the impacts of surface treatment on emission or absorption of thermal radiation
- Analysing of thermal conductivity of insulating materials, especially those used in multilayer insulations
- Theoretical understanding of quantum phase transitions - structural changes in mesoscopic systems, like atomic nuclei, molecules and low-dimensional crystals at zero temperature

UP-TO-DATE ACTIVITIES

Research orientation

- Modelling of natural turbulent flows at extreme dynamical conditions in table-top experiments using cryogenic helium within the paradigmatic model system – the Rayleigh-Bénard Convection (RBC)
- Studying transitions between different regimes of classical RBC flows at extreme values of Rayleigh numbers, and determining respective heat transfer scaling laws
- Understanding connections between the classical and quantum turbulence via theoretical and experimental analyses of heat transfer laws
- Radiative heat transfer over a microscopic gap exceeds the black body limit by the effect of near field. The gaps are down to tens of micrometres at low temperatures. Superconductivity affects the heat transfer in the near field regime
- Temperature dependence of emissivity and absorptivity of various metallic and non-metallic materials

a) Experimental cryostat developed at ISI Brno for studies of RBC in a very wide range of Rayleigh numbers

b) Schematic depiction of the He parts of the cryostat

c) Section through a 3D model of the existing cryogenic RBC cell

**Institute of Scientific Instruments
 of the CAS, v. v. i.**

The Czech Academy of Sciences

Královopolská 147, 612 64 Brno,
 Czech Republic

<http://www.cryogenics.isibrno.cz>

Head: Dr. Aleš Srnka
 Phone: +420 541 514 264
 E-mail: srnka@isibrno.cz

Expert: Dr. Pavel Urban
 Phone: +420 541 514 269
 E-mail: urban@isibrno.cz

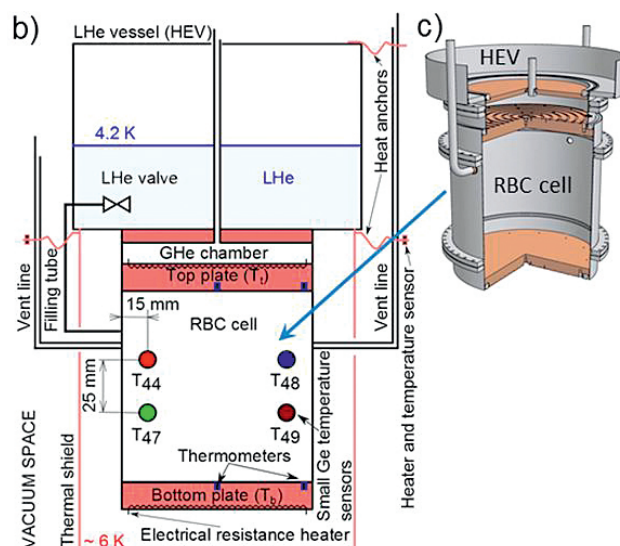

- Developing group theoretical models to study collective dynamics in mesoscopic systems, which display quantum phase transitions

Main capabilities

Basic research

- Research activities at unique experimental facilities for study of turbulent Rayleigh-Bénard natural convection. Our two helium cryostats allow to study natural turbulent flows up to very high Rayleigh number about $Ra \sim 1e15$, utilizing the cryogenic helium gas (up to 3 bars). The first one contains a cylindrical fixed geometry (30 cm diameter, aspect ratio one) Rayleigh-Bénard cell of arguably one of the best designs so far. The second one contains a cylindrical (10 cm diameter) Rayleigh-Bénard cell with continuously adjustable geometry.
- Study of the radiative heat transfer over a microscopic gap between various thin films on dielectric substrates with variable temperatures (5 K – 15 K for the colder sample and 9 K – 60 K for the hotter sample). The results measured on plane parallel configuration are directly compared with present theory.
- Collaboration with CERN on the cryogenic part of the project NA58 "COMPASS". The main goal of the experiment is the study of hadron structure and hadron spectroscopy via interactions between low temperature polarised target and high intensity muon and hadron beams.

Applied research

- Design of special thermal insulation pads, characterized by low thermal conductance, high mechanical stiffness and small dimensions. These pads are used in UHV SEM/SPM microscopy as sample holders at variable temperatures (20 – 700 K).
- Design of flow cooling systems using cryogenic helium (5 K) or nitrogen (77 K) as a coolant. Systems consist of a flow cryostat and a flexible low-loss transfer line connecting a Dewar vessel with the flow cryostat.
- Analysis of thermal conductivity performance of insulating materials under controlled conditions
- Assessment of a given surface's ability to emit/absorb thermal radiation in a wide range of temperatures of thermal radiation source
- Determination of electrical resistivity by cryogenic four point probe up to room temperature (thin layers, foils, sheets)

Sub-fields of group activities

- Materials science (study of physical properties of materials used in cryogenics and space)
- Two-phase cryogenic convection
- Special measuring instruments for cryogenics
- Low temperature thermometry
- Cryogenic safety

KEY RESEARCH EQUIPMENT

List of devices

- Helium liquefier L1410 (Linde Process Plants) with 500 l Dewar, 18 l of liquid helium per hour, complete helium recovery system for helium gas savings
- Helium Dewars with up to 50 mm neck diameter and 30 – 100 litre volumes
- Precise NMR magnetometer PT 2025 (Metrolab Instrum.), range 0.7 – 13.7 T
- Low temperature controllers Lakeshore (Model 340, 350, 372, 332, 218) for precise temperature measurement and control with different sensor types
- Helium leak detector ASM 310 (Adixen Vacuum Products)
- Mass spectrometer PrismaPlus (Pfeiffer Vacuum) up to mass number $A=100$
- Apparatuses for research of near-field and far-field radiative heat transfer made by the research team
- Thermal conductivity meter, made by the research team, for analysis of various insulating materials

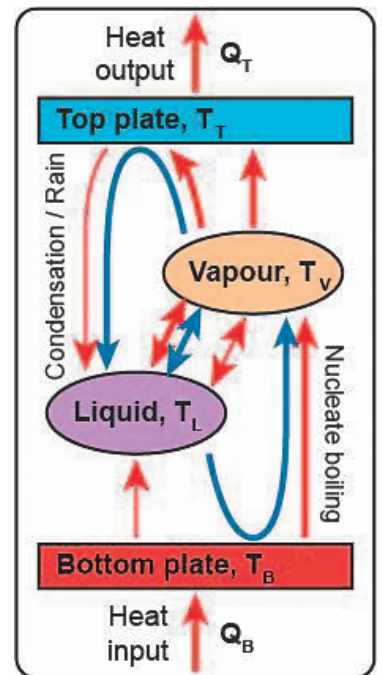

Schematic illustration of heat flows (red arrows) and mass flows (blue arrows) in two-phase He vapour-liquid system

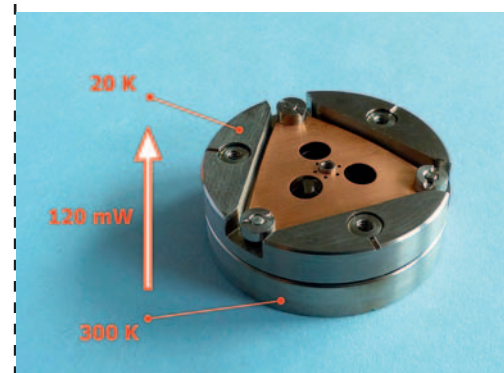

Thermal insulation pad (InBallPad)

- Special apparatuses for study of natural thermally driven convection using cold helium gas (ConEV) made by the research team
- Unique small helium bath cryopump made by the research team

ACHIEVEMENTS

We contributed to elucidation of the thermally driven turbulence processes and developed special cryogenic apparatuses for characterization of thermal radiative properties of materials at low temperatures. We published about 30 papers in impacted journals with very good citation response and about 25 contributions in conference proceedings or local journals in last five years. Our research results has had impact on the space research.

For more details and publications see www.cryogenics.isibrno.cz

The most important results:

■ Ultimate state of turbulent natural convection/RBC

- L. Skrbek, P. Urban: "Has the ultimate state of turbulent thermal convection been observed?", *J. Fluid Mech.* **785**, 270–282, 2015

- P. Urban, P. Hanzelka, T. Králík, V. Musilová, A. Srnka, L. Skrbek: "Reply: Effect of Boundary Layers Asymmetry on Heat Transfer Efficiency in Turbulent Rayleigh-Bénard Convection at Very High Rayleigh Numbers", *Phys. Rev. Lett.* **110**, 199402, 2013

- P. Urban, P. Hanzelka, V. Musilová, T. Králík, M. La Mantia, A. Srnka, L. Skrbek: "Heat transfer in cryogenic helium gas by turbulent Rayleigh-Bénard convection in a cylindrical cell of aspect ratio 1", *New J. Phys.* **16**, 053042, 2014

■ Two-fluid convection

- P. Urban, D. Schmoranzler, P. Hanzelka, K.R. Sreenivasan, L. Skrbek: "Anomalous heat transport and condensation in convection of cryogenic helium", *Proc. Natl. Acad. Sci. USA* **110** (20), 8036-8039, 2013

■ Thermal insulation pad (InBallPad) for a sample holder of UHV SEM/SPM microscope

- P. Hanzelka, J. Voňka, V. Musilová: "Low conductive support for thermal insulation of a sample holder of a variable temperature scanning tunneling microscope", *Rev. Sci. Instrum.* **84**, 085103, 2013

■ Investigation of radiative heat transfer by near-field effect at low temperatures

- T. Králík, P. Hanzelka, M. Zobač, V. Musilová, T. Fořt, T.; M. Horák: "Strong near-field enhancement of radiative heat transfer between metallic surfaces", *Phys. Rev. Lett.* **109**, 224302, 2012

■ Emissivity and absorptivity at low temperatures

- T. Králík, V. Musilová, P. Hanzelka, J. Frolec: "Method for measurement of emissivity and absorptivity of highly reflective surfaces from 20 K to room temperatures", *Metrologia* **53**, 743-753, 2016

■ Thermal properties of spacers for multilayer insulation

- The unique apparatus for thermal characterization of materials used as spacers under precisely controlled compression was designed. Apparatus measures simultaneously heat transfer by conduction and radiation across sample.

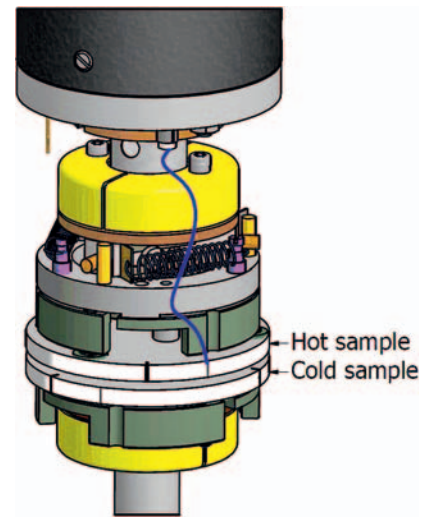

Schematic view of the measuring part of the near-field apparatus

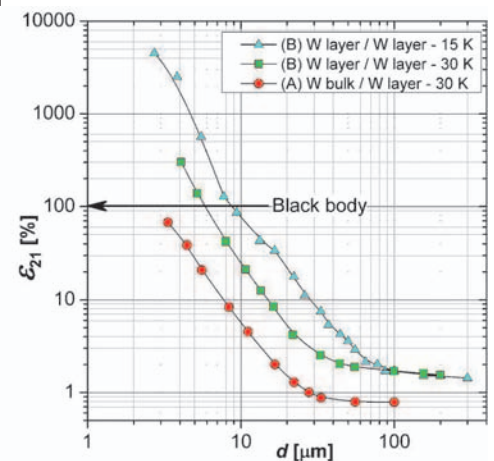

Example plot of normalized emissive power versus gap between samples

Opened chamber of the far field apparatus

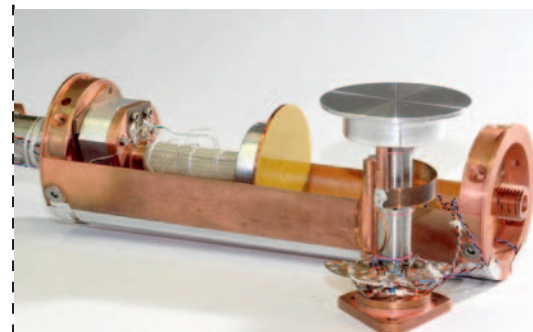

■ Formulation of a unified theory of excited state quantum phase transitions in systems with low number of degrees of freedom in a series of papers:

- P. Stránský, M. Macek, A. Leviatan, P. Cejnar; “Excited-state quantum phase transitions in systems with two degrees of freedom II: Finite-size effects”, *Ann. Phys.* **356**, 57, 2015
- P. Stránský, M. Macek, P. Cejnar; “Excited-state quantum phase transitions in systems with two degrees of freedom: Level density, level dynamics, thermal properties”, *Ann. Phys.* **345**, 73, 2014

MAIN COLLABORATING PARTNERS

Collaboration with academic partners

- CERN (Geneva, Switzerland)
- Technical University Ilmenau (Ilmenau, Germany)
- New York University (New York, USA)
- Yale University (New Haven, USA)
- Hebrew University (Jerusalem, Israel)
- Florida University (Gainesville, USA)
- Institut Néel CNRS/UGA (Grenoble, France)
- Charles University (Praha, CZ)
- Brno University of Technology (Brno, CZ)
- Masaryk University (Brno, CZ)
- Palacky University (Olomouc, CZ)

Collaboration with companies

- RUAG Space GmbH (Vienna, Austria)
- Frentech Aerospace s.r.o. (Brno, CZ)
- TESCOAN, s.r.o. (Brno, CZ)
- Chart Ferox, a.s. (Děčín, CZ)

EXPECTATIONS

Offers

We offer partnership in international projects and collaboration in the areas of our expertise, namely:

- Development, optimization and design of special cryogenic devices
- Calculation and measurement of parasitic heat flows at cryogenic temperatures
- Theoretical and experimental studies based on thermally driven cryogenic turbulence
- Measurements of low temperature properties of materials (electrical and thermal conductivities, emissivity and absorptivity of thermal radiation) in the range 4.2–320 K
- Cryogenic cooling systems, calculation of cooling capacities of different liquids and gases
- Low temperature measurement and its accuracy determination
- Vacuum in cryogenic systems
- Expertise in cryogenic safety, training in cryogenic safety
- Research activities under the EuHIT consortium (www.euhit.org), integrating cutting-edge European facilities for turbulence research.

Requirements

We look for cooperation with academic partners as well as companies in the fields:

- Radiative heat transfer (metrology, standardization)
- Partners for EU research projects in the field of cryogenic helium turbulence
- Co-operative research and development of new materials for the thermal insulation of cryogenic systems
- Collaboration with industrial partners on common projects dedicated to applied science in the field of cryogenics (e.g. special cryogenic devices)

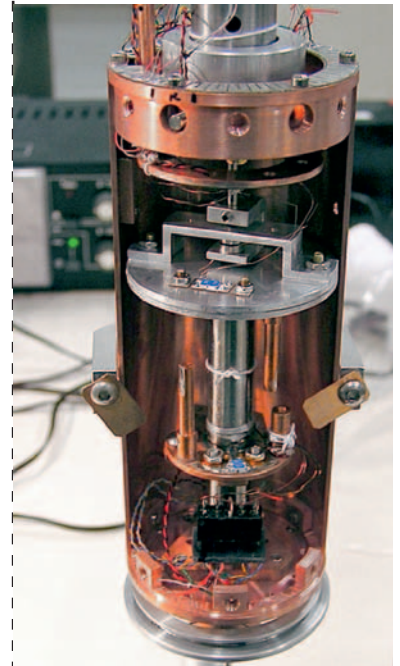

Sample sandwiched between two discs - hot radiator and cold absorber in the thermal conductivity meter

Examples of spacers installed on the absorber

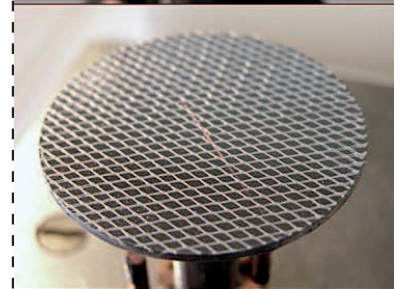

Group of Medical Signal (MEDISIG)

Department of Medical Signals



Institute of Scientific
Instruments
The Czech Academy
of Sciences

THEMATIC RESEARCH FOCUS

Research area

- Biomedical engineering
- Signal processing methods
- Software design and development
- Cardiac electrophysiology
- Neuro electrophysiology
- Epileptic seizure localization
- Blood circulation control
- Advanced acquisition technologies

Excellence

- Deep brain electrophysiology – basic neuroscience research regarding the brain activities time-spatial distribution
- Epileptic sources identification and localization, ultra-high frequency oscillations detection
- Blood circulation and hemodynamic control (stroke volume, pulse wave velocity, heart rate and blood pressure variability)
- Heart repolarization abnormalities identification
- Development (in cooperation with academic partners and private companies) of the novel acquisition technologies in neurology and cardiology (the multichannel whole-body bioimpedance monitor, PulseWave software, high frequency and dynamic EEG and ECG recorders)
- High frequency high dynamic range ECG for early diagnostics of heart pathologies
- New software solutions for large data visualization and processing – SignalPlant open access platform

Mission

To contribute to the development of novel diagnostic markers, technologies, protocols and analytical methods that will allow physicians to see more and that improve the quality of life

UP-TO-DATE ACTIVITIES

Research orientation

- Design and verification of methods for identification of epileptic sources within the brain (clinical outcome) and the establishment of functional links between brain structures (basic research outcome)
- Methodology and algorithms for HFOs detection. These are, primarily, identification of the seizure onset zone, irritative zones and remote areas, spikes, ripples, fast-ripple and especially very and ultra-fast ripples (up to 2 kHz) detection, automated detection of HFOs and Welch power spectra analysis. The numerical outputs are statistically evaluated and presented in graphic form
- Design and implementation of new technologies. Includes: high dynamic acquisition system, new software for the analysis of high frequency ECG, interpretation of results and diagnostic applications
- Diagnostic contribution of high frequency ECG
- Analysis of time-spatial distribution of electrical heart activation
- Open access tools of large data visualization and processing

Institute of Scientific Instruments
of the CAS, v. v. i.

Czech Academy of Sciences

Královopolská 147, 612 64 Brno,
Czech Republic

<http://www.isibrno.cz/medisig/>

www.medisig.com

Head: Dr. Pavel Jurák

Phone: +420 541 514 312

E-mail: jurak@isibrno.cz

Expert: Dr. Filip Plešinger

Phone: +420 541 514 518

E-mail: fplesinger@isibrno.cz

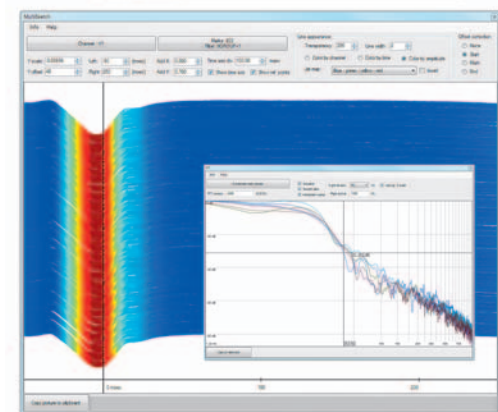
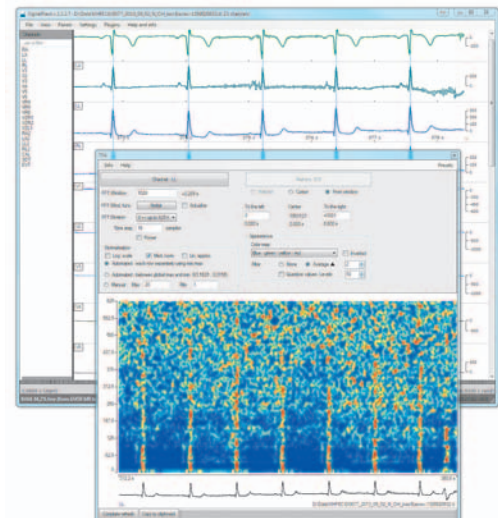

SignalPlant. SignalPlant is free software tool for signal examination, scoring and post-processing. Although it is originally aimed to biological signals, it contains tools useful for any other area of signal processing

Main capabilities

Basic research

- Description of brain region involvement in different mental activities
- Description of brain information transfer and connectivity
- Identification of pathological oscillations properties in intracerebral EEG in epileptic patients, experimental outcomes for clinical medicine
- Distribution of high frequency components during ventricular depolarization period, detection of ventricular dyssynchrony in high temporal resolution
- Dynamic properties of blood circulation parameters

Applied research

- Development and realization of Multichannel PulseWave Monitor – medical device intended for novel non-invasive diagnostics of the state of the arterial system
- High frequency ECG monitor – experimental device for advanced acquisition of multi-lead high frequency and high dynamic electrocardiography
- High frequency ECG methods for identification of ventricular dyssynchrony (patent: <https://patents.google.com/patent/WO2015090260A3/en>)
- Cardiac Resynchronization Therapy optimization
- SignalPlant – free signal processing and visualization software tools (<https://signalplant.codeplex.com/>)

Sub-fields of group activities

- Clinical and experimental medicine – neurology
- Clinical end experimental medicine – cardiology
- Biomedical engineering
- Signal acquisition and processing

KEY RESEARCH EQUIPMENT

List of devices

- Computing facilities intended for large data interactive processing (64 core parallel computing, high-speed SSD storages, SW support)
- Equipment for development of high quality signal devices – low noise DC power supply (Kikusui PMR18-1.3TR), arbitrary function generator 50 MHz (Rohde&Schwarz HMF2550), RF signal generator 2 GHz (Anritsu MG3642A)
- Equipment for basic EMC tests – RF spectrum analyser 3.6 GHz (Rohde&Schwarz FSH4), near-field probe set (Rohde&Schwarz HZ-15), electromagnetic field meter, active directional antenna (Rohde&Schwarz HE300)
- Software for FPGA development – signal processing tool (Xilinx System Generator for DSP), logic analyser tool (Xilinx ChipScope Pro)

ACHIEVEMENTS

Awards

- 2014: ESGCO 2014 Award for Technology Transfer, Influence of Tilt Load on Pulse Wave Velocity in Lower Limbs
- 2014: Physionet challenge, Robust Detection of Heart Beats in Multimodal Data, 4th prize (Boston, USA) for QRS multimodal detection algorithm.
- 2015: Physionet challenge (Nice, France), Reducing False Arrhythmia Alarms in the ICU, the 1st and 2nd prize (two different categories) for arrhythmias detection methods.
- 2017: Clinical Needs Translational Award (CTA), European Society of Cardiology, Rennes, France

Publications

- J. Halánek, J.P. Couderc, P. Jurák, V. Vondra, W. Zareba, I. Viščor, P. Leinveber: *“Measure of the QT-RR Dynamic Coupling in Patients with the Long QT Syndrome”*, Annals of Noninvasive Electrocardiology **17**, 4, 323-330, 2012

- **F. Plešinger, J. Jurco, J. Halámek, P. Jurák:** "SignalPlant: an open signal processing software platform", *Physiol Meas* **37(7)**, 38–48, 2016
- M. Pail, J. Halámek, P. Daniel, R. Kuba, I. Tyrliková, J. Chrastina, P. Jurák, I. Rektor, M. Brázdil: "Intracerebrally recorded high frequency oscillations: Simple visual assessment versus automated detection", *Clinical Neurophysiology* **124**, 10, 1935-1942, 2013
- **M. Brázdil, J. Janeček, P. Klimeš, R. Mareček, R. Roman, P. Jurák, J. Chládek, P. Daniel, I. Rektor, J. Halámek, F. Plešinger, V. Jirsa:** "On the time course of synchronization patterns of neuronal discharges in the human brain during cognitive tasks", *PLoS ONE*. **8**, 5, e63293:1-9, 2013
- **P. Jurák, J. Halámek, J. Meluzín, F. Plešinger, T. Postránecká, J. Lipoldová, M. Novák, V. Vondra, I. Viščor, L. Soukup, P. Klimeš, P. Veselý, J. Šumbera, K. Zeman, S. Asirvatham, J. Tri, S.J. Asirvatham, P. Leinveber:** "Ventricular dyssynchrony assessment using ultra-high frequency ECG technique", *Journal of Interventional Cardiac Electrophysiology* **49**, 3, 245-254, 2017
- **M. Brázdil, M. Pail, J. Halámek, F. Plešinger, J. Cimbálník, R. Roman, P. Klimeš, P. Daniel, J. Chrastina, E. Brichtová, I. Rektor, G.A. Worrell, P. Jurák:** "Very High-Frequency Oscillations: Novel Biomarkers of the Epileptogenic Zone", *Annals of Neurology*, **82**, 2, 299-310, 2017
- **US patent: Device for blood flow property measurement and method of its connection**

Patent Number: US 9,167,984 B2
 Group Author(s): INSTITUTE OF SCIENTIFIC INSTRUMENTS AS CR, V. V. I
 Inventor(s): Vondra V, Jurak P, Halamek J, Viscor I
 Official Gazette of the United States Patent and Trademark Office Patents,
 Granted: NOV 2015

Intracerebral EEG recordings and analysis – brain structures involvement in cognition process, pathological and functional connectivity

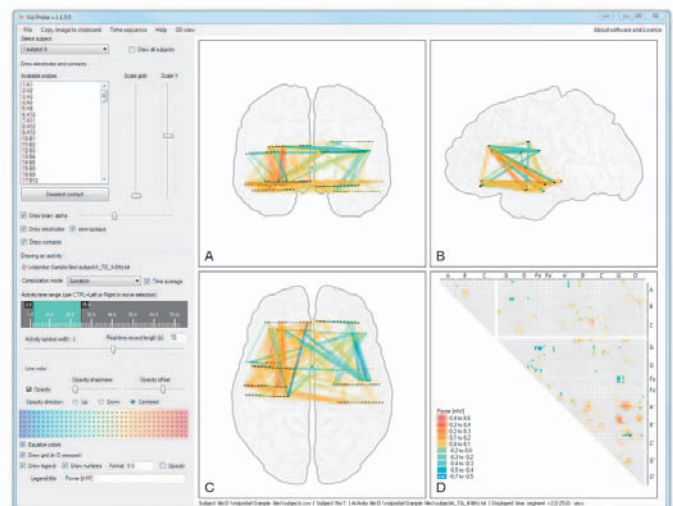
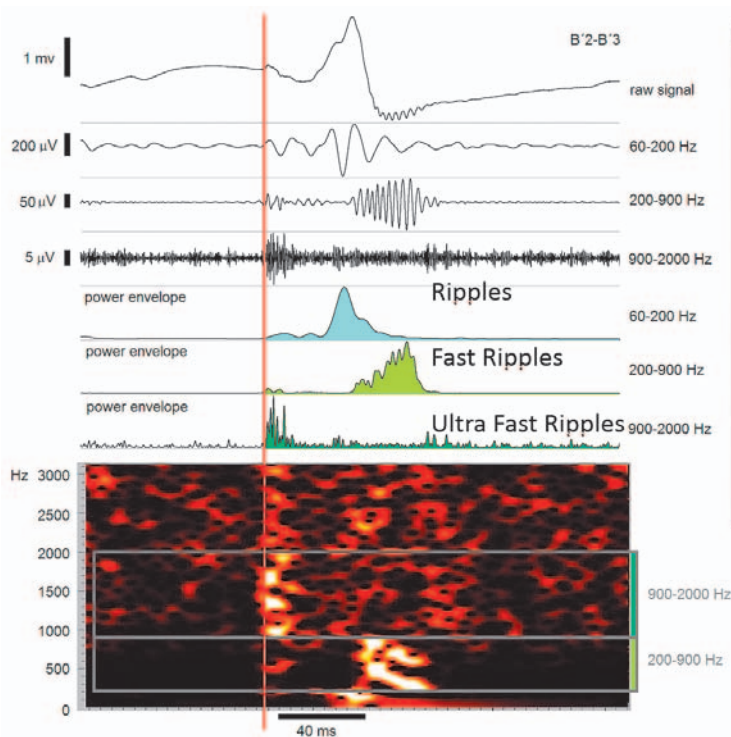

■ **PCT patent submission: Electrocardiogram (ECG) signal processing method for heart diagnosing.**

Patent Number: WO2015090260-A2 CZ201301052-A3, 2014
Patent Assignee: USTAV PRISTROJOVE TECHNIKY AVCR; FAKULTNI NEMOCNICE U SV ANNY V BRNE; M & I SPOL SRO
Inventor(s): Jurak P; Halamek J; et al.

■ **US Patent: Method of ventricular repolarization analysis**

Patent Number: US 8,600,485 B2
Group Author(s): INSTITUTE OF SCIENTIFIC INSTRUMENTS AS CR, V. V. I
Inventor(s): Halamek, J; Jurak, P.
Official Gazette of the United States Patent and Trademark Office Patents,
Granted: DEC 3 2013

■ **US and EU submitted patent: Method of EKG signal processing and apparatus for performing the method**

Inventor(s): Jurak, P. et al.
<https://patents.google.com/patent/WO2015090260A3/en>

MAIN COLLABORATING PARTNERS

Collaboration with academic partners

Mayo Clinic, Rochester (MN, USA)
University of Rochester (Rochester, NY, USA)
Imperial College London (London, UK)
International Clinical Research Centre (St. Anne's University Hospital, Brno, CZ)
Brno University of Technology (Brno, CZ)
Masaryk University (Brno, CZ)
Institute for Clinical and Experimental Medicine (Prague, CZ)
National Institute of Mental Health (Klecany, CZ)

Collaboration with companies

M&I (Prague, CZ)
Cardion (Brno, CZ)
AMV medical (Brno, CZ)
MDT – medical data transfer (Brno, CZ)

EXPECTATIONS

Offers

We offer collaboration in the areas of our expertise:

- Biomedical signal acquisition and analysis
- Development of diagnostic technologies and data processing methods
- Cooperation in clinical evaluation of new technologies
- Partnership in international scientific and technology-transfer projects

Requirements

We look for cooperation with academic partners as well as companies in the fields of signal processing and application of new analysis and technologies especially in neurology and cardiology.

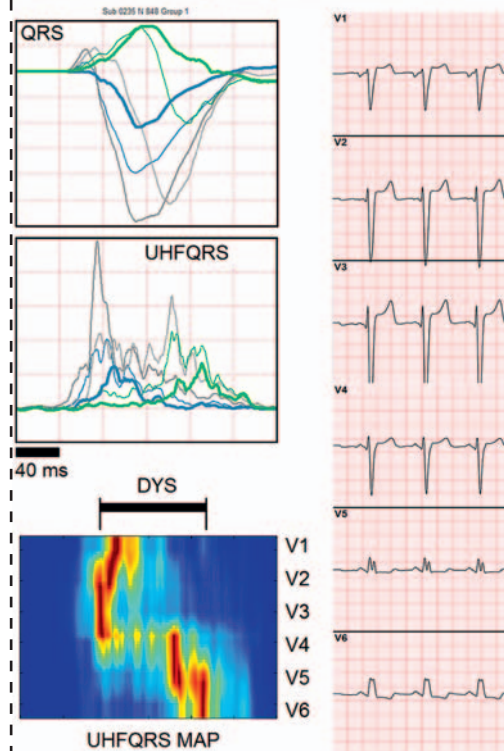

*Ultra-high frequency ECG technology.
Measurement of ventricular
depolarization distribution and
identification of dyssynchrony*

THEMATIC RESEARCH FOCUS

Research area

- Optics
- Photonics
- Light-matter interaction
- Stochastics in optical landscape
- Micro(nano) technologies

Excellence

- Force interaction between light and objects (theoretical and experimental aspects)
- Applications of focused laser beams (laser microdissection, optical tweezers, optical cell sorters, long-range optical delivery of micro(nano)objects, polymerization of micro-structures)
- Laser beam shaping by spatial light modulators
- Design and manufacturing of on demand systems using laser beams

Mission

To be at the forefront in developing new optical methods appropriate for contactless, nondestructive investigation of living or inanimate parts of the micro, nano and quantum worlds.

UP-TO-DATE ACTIVITIES

Research orientation

- Investigation of underdamped and overdamped stochastic object motion in nonlinear optical potentials
- Investigation of colloidal photonic crystals assembled by light.
- Laser cooling of nanoparticles at low pressures
- Optically-induced rotation and self-arrangement of several objects
- Optical trapping and characterization of plasmonic nanoparticles
- Mastered technology of photopolymerization, soft-lithography, reactive ion etching, micro-optics-electro-mechanical systems

Main capabilities

Basic research

- Theoretical and experimental activities related to optical micromanipulations with microobjects and nanoobjects

Applied research

- Manufacturing of on-demand opto-mechanical systems using laser beams
- Photopolymerization of microstructures
- Employment of reactive ion etching for surface modifications

Innovations

- Licence agreement on compact optical tweezers and sorters

Institute of Scientific Instruments
of the CAS, v.v.i.

The Czech Academy of Sciences
Královopolská 147, 612 64 Brno,
The Czech Republic
[https://www.isibrno.cz/
en/levitational-photonics](https://www.isibrno.cz/en/levitational-photonics)

Head of the group: Dr. Oto Brzobohatý

Phone: +420 541 514 283

E-mail: otobrzo@isibrno.cz

Head of the Department:

Prof. Pavel Zemánek

Phone: +420 541 514 202

E-mail: zemanek@isibrno.cz

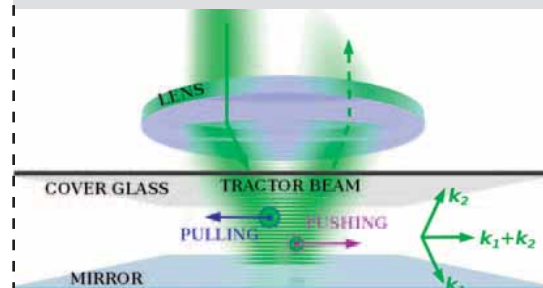

Geometrical configuration of the tractor beam setup and visualization of the pulling and pushing optical force acting upon particles of different sizes

Experimental setup of the tractor beam

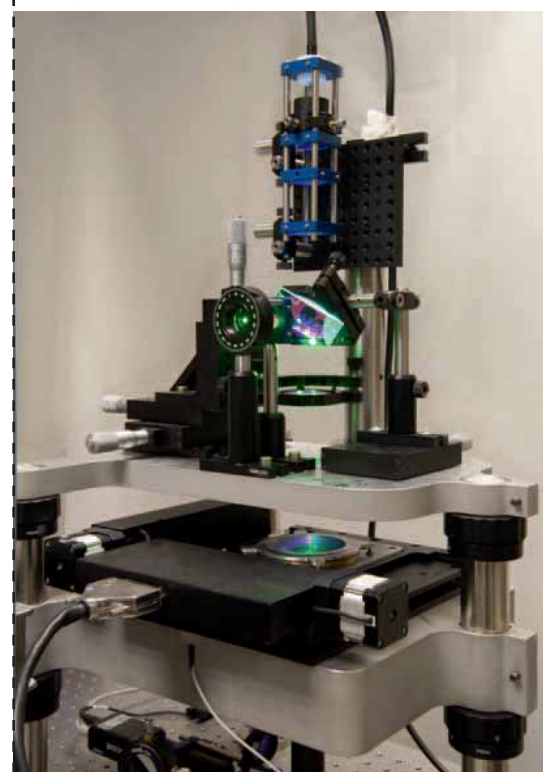

Sub-fields of group activities

- Optical microscopy
- Microtechnology, nanotechnology
- Colloidal chemistry
- Laser spectroscopy

KEY RESEARCH EQUIPMENT

List of devices

- Various CW high power lasers working at 1550 nm, 980 nm, 785 nm, 532nm, 680-1000 nm (Coherent, Spectra Physics, IPG, Sacher).
- Femtosecond laser systems Mira 800 HP, Mai Tai HP Deep See (NKT, Coherent, ...)
- Several different flexible systems for advanced optical micromanipulation experiments (holographic tweezers, dual-beam holographic traps)
- Fast CCD cameras (thousands fps)
- Reactive ion etching system (Plasmalab System 100)

ACHIEVEMENTS

Awards

- Werner von Siemens Excellence Award for the best result of the basic research in 2013
- Oto Brzobohatý was awarded the Otto Wichterle Award for talented young scientists by the Czech Academy of Sciences in 2014
- Zdeněk Pilát was awarded the best Ph.D. Thesis in 2015 by the Czechoslovak Microscopy Society
- Jana Damková was awarded Young Scientist Award 2016 by the Czech and Slovak Society for Photonics

Publications

We deepened the understanding of the force interaction between light and micro/nanoobjects and developed original methods how to manipulate with individual particles or even thousands of particles, how to sort and self-arrange them. We published more than 40 papers in impacted journals with very good citation response in the period 2012–2017.

■ **Experimental demonstration of optical “tractor” beam and its utilization in optical sorting and self-arrangement of microobjects.**

- O. Brzobohatý, V. Karásek, M. Šiler, L. Chvátal, T. Čížmár & P. Zemánek: “Experimental demonstration of optical transport, sorting and self-arrangement using a ‘tractor beam’”, *Nature Photonics* **7**, 123–127, 2013
This result attracted strong interest of media all over the world:
http://www.isibrno.cz/index.php?lang=_an&co=/intranet/novinky.php&nalogovan=&id_druh_menu=3&Nerolovat=1

■ **Enhancement of the ‘tractor-beam’ pulling force on an optically bound structure.**

- Jana Damková, Lukáš Chvátal, Jan Ježek, Jindřich Oulehla, Oto Brzobohatý and Pavel Zemánek: “Enhancement of the ‘tractor-beam’ pulling force on an optically bound structure”, *Light: Science & Applications* **7**, 17135, 2018

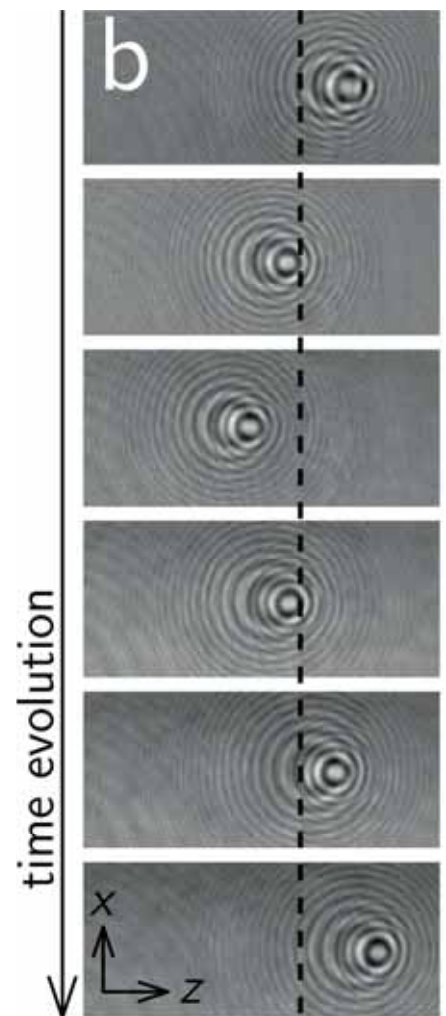

Enhancement of the ‘tractor-beam’ pulling force on an optically bound structure

Transport of multiple microobjects using the optical ratchet

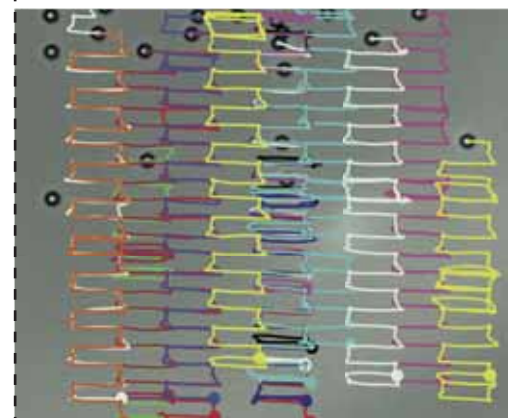

■ **Confirmation of an extraordinary optical momentum and force directed perpendicular to the wavevector, and proportional to the optical spin (degree of circular polarization), introduced by Belinfante in field theory 75, and revealing a new type of transverse force, exhibiting polarization-dependent contribution, determined by the imaginary part of the complex Poynting vector.**

- M. Antognozzi, C. R. Bermingham, R. L. Harniman, S. Simpson, J. Senior, R. Hayward, H. Hoerber, M. R. Dennis, A. Y. Bekshaev, K. Y. Bliokh, F. Nori: "Direct measurements of the extraordinary optical momentum and transverse spin-dependent force using a nano-cantilever", *Nature Physics*, **12**, 731-735, 2016

■ **Omnidirectional transport in fully reconfigurable 2D optical ratchets**

- Alejandro V. Arzola, Mario Villasante-Barahona, and Karen Volke-Sepúlveda, Petr Jákł and Pavel Zemánek "Omnidirectional Transport in Fully Reconfigurable Two Dimensional Optical Ratchets", *Phys. Rev. Lett.* **118**, 138002

■ **Description of stochastic behaviour of a Brownian particle in nonlinear potential**

- R. Filip, P. Zemánek: "Noise-to-signal transition of a Brownian particle in the cubic potential: I. general theory", *Journal of Optics* **18**, 065401, 2016
- P. Zemánek, M. Šiler, O. Brzobohatý, P. Jákł, R. Filip: "Noise-to-signal transition of a Brownian particle in the cubic potential: II. optical trapping geometry", *Journal of Optics* **18**, 065402, 2016
- A. Ryabov, P. Zemánek, R. Filip: "Thermally induced passage and current of particles in a highly unstable optical potential". *Phys. Rev. E* **94**, 042108, 2016
- M. Šiler, P. Jákł, O. Brzobohatý, A. Ryabov, R. Filip, P. Zemánek. "Thermally induced micro-motion by inflection in optical potential", *Scientific Reports*, **7**, 1697, 2017

■ **Pioneering results related to optically induced alignment or rotation of microobjects and nanoobjects**

- Stephen H. Simpson, Pavel Zemánek, Onofrio M. Maragò, Philip H. Jones, and Simon Hanna: "Optical Binding of Nanowires", *Nano Lett.*, **17** (6), 3485–3492, 2017
- A. V. Arzola, P. Jákł, L. Chvátal, P. Zemánek: "Rotation, oscillation and hydrodynamic synchronization of optically trapped oblate spheroidal microparticles", *Optics Express* **22**, 16207-1622, 2014
- O. Brzobohatý, A. V. Arzola, M. Šiler, L. Chvátal, P. Jákł, S. Simpson, P. Zemánek "Complex rotational dynamics of multiple spheroidal particles in a circularly polarized, dual beam trap", *Optics Express* **22**, 7273-7287, 2015
- S. H. Simpson, L. Chvátal, P. Zemánek: "Synchronization of colloidal rotors through angular optical binding", *Physical Review A* **93**, 023842, 2016
- O. Brzobohatý, M. Šiler, J. Trojek, L. Chvátal, V. Karásek, A. Paták, Z. Pokorná, F. Mika, P. Zemánek: "Three-Dimensional Optical Trapping of a Plasmonic Nanoparticle using Low Numerical Aperture Optical Tweezers", *Scientific Reports* **5**, 8106, 2015
- A. Irrera, A. Magazzu, P. Artoni, S. H. Simpson, S. Hanna, P. H. Jones, F. Priolo, P. G. Gucciardi, and O. M. Marago: "Photonic Torque Microscopy of the Nonconservative Force Field for Optically Trapped Silicon Nanowires", *Nano Lett.* **16** 4181-4188, 2016
- J. Trojek, L. Chvatal and P. Zemanek: "Optical alignment and confinement of an ellipsoidal nanorod in optical tweezers: a theoretical study" *J. Opt. Soc. Am. A* **29**, 1224-1236, 2012

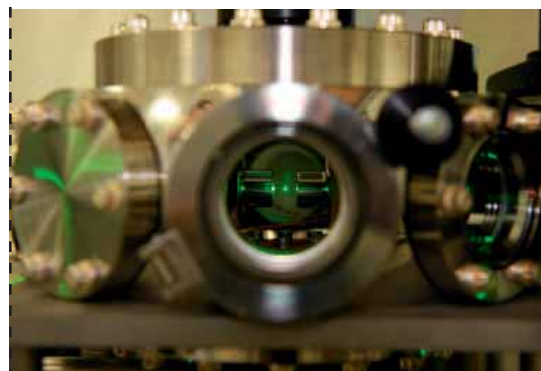

An optically trapped nanoparticle inside the vacuum chamber.

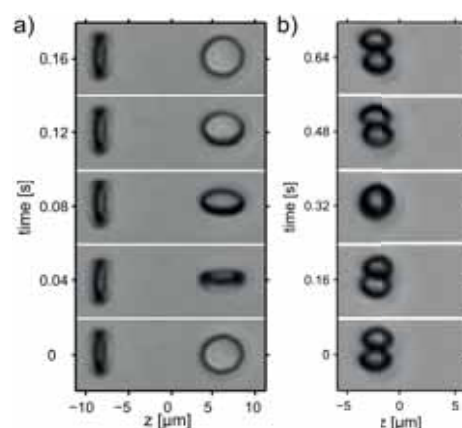

An example of simultaneous trapping and rotation of disc-like objects in counter-propagating laser beams with circular polarizations.

An example of optically self-arranged colloidal waveguide. The distance between the particles is tuneable by the width of two counter-propagating beams which is followed with different spectral properties of the whole structure shown at red, yellow and green wavelengths.



■ **Optical sorting of microobjects**

- P. Jákł, A. V. Arzola, M. Šiler, L. Chvátal, K. Volke-Sepúlveda, P. Zemánek: "Optical sorting of nonspherical and living microobjects in moving interference structures", *Optics Express* **22**, 29746-29760, 2014
- Optical cell-sorter based on fluorescences or Raman spectra of microorganisms (utility model in cooperation with Photon Systems Instruments)

■ **Compact optical tweezers modules compatible with majority of optical microscopes (utility model awarded, in cooperation with Meopta-Optika)**

MAIN COLLABORATING PARTNERS

Collaboration with academic partners

- Brno University of Technology (Brno, CZ)
- Consiglio Nazionale delle Ricerche (Messina, IT)
- Institute of Experimental Physics, Slovak Academy of Sciences (Košice, SK)
- Istanbul Technical University (Istanbul, TR)
- Koc University (Istanbul, TR)
- Lehigh University (Bethlehem, USA)
- Masaryk University (Brno, CZ)
- Palacky University (Olomouc, CZ)
- Universidad Nacional Autonoma de Mexico (Mexico City, MX)
- University of Bristol (Bristol, UK)
- University of Dundee (Dundee, GB)
- University of Naples Federico II (Naple, IT)
- University of St. Andrews (St. Andrews, GB)

Collaboration with companies

- IQ Structures (Praha, CZ)
- Measurement Technic Moravia Ltd. (Zastávka u Brna, CZ)
- Meopta (Přerov, CZ)
- Photon Systems Instruments (Drásov, CZ)
- Tescan Orsay Holding (Brno, CZ)

EXPECTATIONS

Offers

- We offer collaboration in the areas of our expertise.
- Partnership in international projects.
- Custom manufacturing of opto-memechanical systems using laser beams.

Requirements

We look for cooperation with academic partners as well as companies in the fields of optics, biophotonics, microtechnologies, nanotechnologies, applications of optical methods.

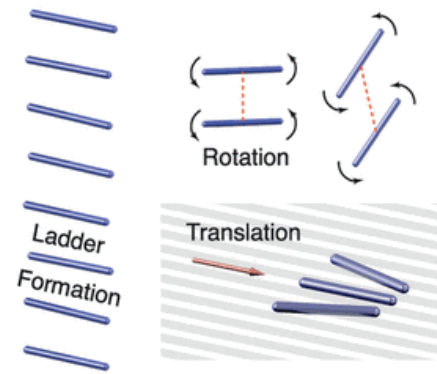

Optical Binding of Nanowires

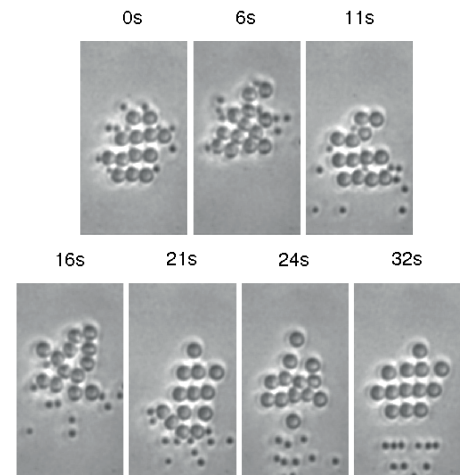

Example of optical sorting of suspension of polystyrene particles of sizes 800 nm and 1600 nm in travelling interference fringes.



A visualization of compact optical tweezers

Custom-made selective plane illumination microscope (OpenSPIM)

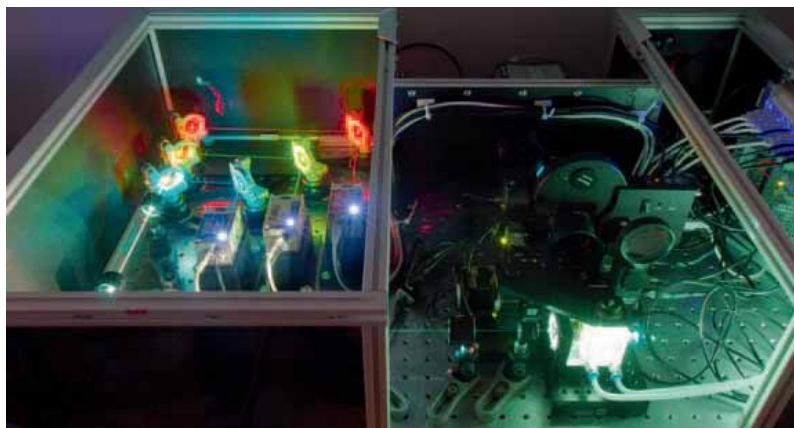

R&D PROFILE

Research area

- Optics
- Holography
- Microscopy
- *In-vivo* imaging technology
- Endoscopy
- Lasers
- Neuroscience
- Immunology

Excellence

- Light propagation and image formation in optical fibres
- Effects of fibre bending or heating on image formation and recovery
- Laser beam shaping by spatial light modulators and digital micro-mirror devices
- On demand design and manufacturing of imaging systems
- Chemical micro-endoscopy (Raman spectroscopy, CARS or SRS)
- Imaging of biological tissues including brain and lymphoid organs

Mission

Our understanding of (biological) life has huge repercussions for our health and wellbeing. The tremendous complexity of living organisms poses challenging scientific questions. In particular, multiple scattering effects prevent current technologies from retrieving sufficiently detailed information from deep within biological tissue.

Amongst other activities we develop a new class of endoscopes that can break through this barrier. This technology can potentially go as far as reaching super-resolution with instruments having a footprint comparable to the dimensions of a single cell.

UP-TO-DATE ACTIVITIES

New technologies in holographic endoscopy

- Employ multimode fibres for holographic endoscopic techniques. Study the image formation and degradation due to fibre bending or inhomogeneous heating.
- Software development for fast reconstruction of images obtained by multimode fibres (CUDA, OpenCL, Matlab, LabView).
- Design and employ new types of fibre probes, materials and new endings for broadening spectrum of imaging techniques.
- Design and prototype a new type of Digital Micromirror Device that allows fast modulation of the light spatial phase profile with small phase steps.

Broadening the understanding and control possibilities of light propagation in optical waveguides

- Linear propagation and shaping of light in ideal, cylindrically symmetric multimode optical fibres including continuous wave and pulse propagation, with applications to non-linear Raman and light sheet imaging.

**Institute of Scientific Instruments
of the CAS, v. v. i.**
Czech Academy of Sciences
Královopolská 147, 612 64 Brno,
Czech Republic
<http://complexphotonics.isibrno.cz>
<http://www.isibrno.cz/omitec/>

Head: Prof. Tomáš Čížmár
Phone: +420 541 514 131
E-mail: cizmart@isibrno.cz

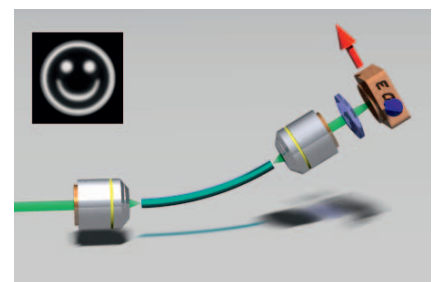

Schematic description of fibre bending experiments.

- Effects of small, geometric or optical perturbations, how they influence image formation and how these effects can be ameliorated.
- Methods for efficient optical fibre calibration and measurement.
- Image reconstruction via mode separation and processing.

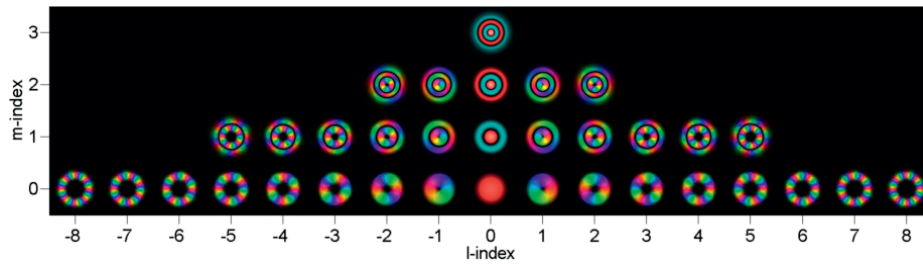

Discrete modes in a multimode optical fibre.

Micro-endoscopy with chemical contrast

- Raman microscopy is a form of label-free imaging with chemical contrast, which means that we can detect the composition of the tissue without staining it.
- Raman imaging and spectroscopy is useful for applications such as identifying bacteria and imaging lipid distribution in cells (relevant for cell metabolism and related disease conditions). Combined with holographic endoscopy, it has promise as a method for diagnosing tumors in situ, without performing a biopsy and associated time consuming histopathology.
- We will implement Raman imaging in a light sheet configuration, for faster imaging than point scanning allows.
- We aim to develop non-linear Raman imaging, in the form of CARS or SRS, through a multimode fibre.
- We aim to apply this for diagnosing tumors in sensitive locations such as the brain or pancreas.

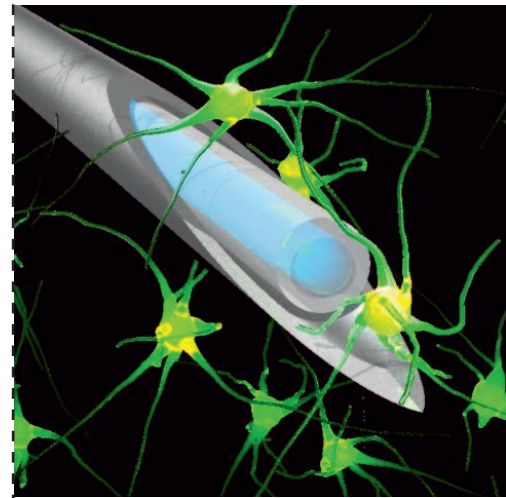

An artist's impression of endoscopic imaging of neurons in the brain. The fibre is inserted using a hypodermic needle.

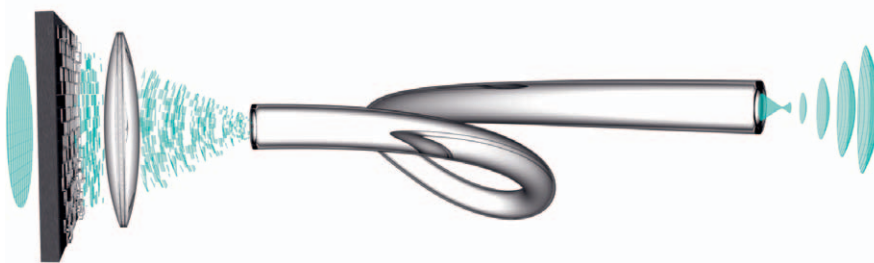

Synthesis of laser focus through a randomizing optical fibre.

In-vivo imaging for neuroscience and immunology

- One of the primary challenges facing bio-medical research today is imaging cells and cell functions in native tissues which is typically absorbing and scattering light and therefore appears opaque.
- Imaging of structures and functions deep in the tissue often requires invasive procedures including removal of the above-lying layers.
- We are developing imaging strategies for multimode optical fibres to be used as endoscopic probes. Such endoscopes have very small footprints and can therefore interrogate and image regions of the sample which would, otherwise, be inaccessible. Simultaneously they provide high-resolution images.
- Using these endoscopes we aim to study the function of two systems *in vivo*: brain and lymphoid organs.
- We will take advantage of well-defined stimulation such as selective, optogenetically-evoked activation of different cell populations, pharmacological manipulations as well as behaviour/memory-related tasks.

- Our ultimate goal is to have a versatile tool for online, high-resolution observation of 1. fundamental neurological processes such as neurovascular coupling, memory formation and neuronal plasticity in awake, freely moving animals; 2. immune processes in tissues inaccessible by classical multiphoton microscopy.

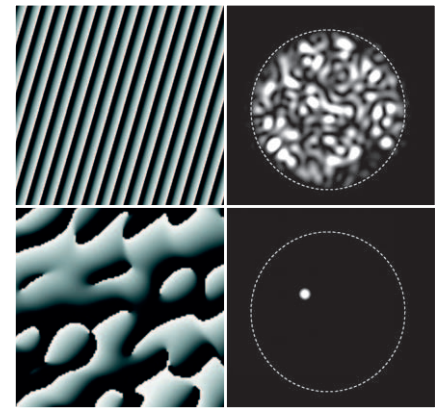
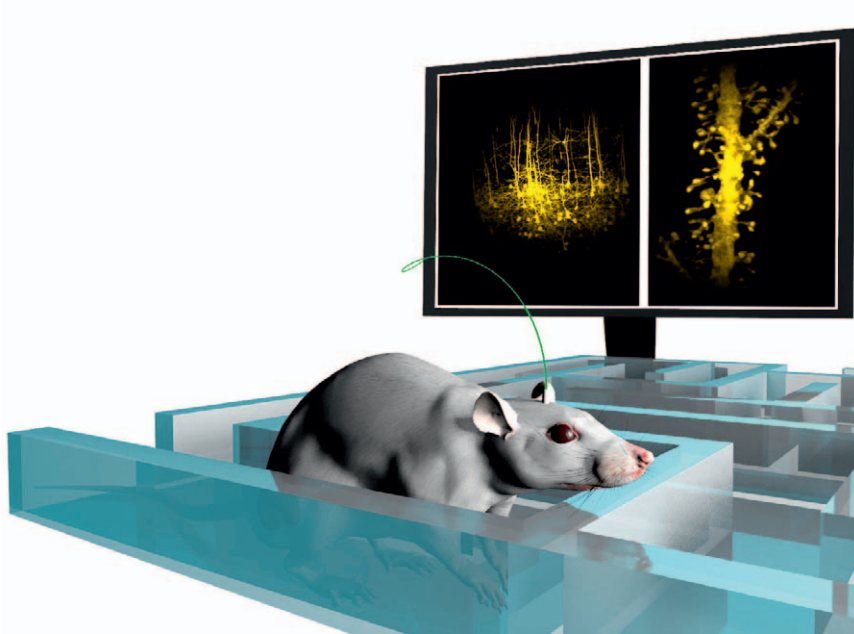

The fibre scrambles the light from a plane wave illumination to a speckle pattern (↗). The plane wave is created by the phase grating on the SLM (↖). By applying an appropriate pattern on the SLM (↙) we create a focus at the output of the fibre (↘).

KEY RESEARCH EQUIPMENT

List of devices

- High power CW laser & tunable single frequency Ti:sapphire laser
- Multiphoton/confocal microscope centre (2019 onwards)
- Femtosecond laser system (2019 onwards)
- Various liquid crystal Spatial Light Modulators and Digital Micromirror Devices
- Centre of 3D printing enabling various 3D print techniques: Polyjet printing (Stratasys Objet Prime) including biocompatible materials, Fused Deposition Modelling (Zortax M300, Felix Pro 2) and Digital Light Processing (Dwarf 3)
- Surgical equipment for *in-vivo* imaging studies (IVC rack, isoflurane anaesthetic centre, stereotactic frame, stereo microscope, autoclave, homeothermic blanket, MouseOx mouse monitoring system, dental drill)
- Cell-culture equipment (laminar flow-box, CO₂ incubator, centrifuge)
- Equipment for *in-vivo* microscopy and endoscopy (pneumatic pico pump, pulse stimulator, pipette puller, micro-manipulators)

ACHIEVEMENTS

- **Sergey Turtaev, Ivo T. Leite, Kevin J. Mitchell, Miles J. Padgett, David B. Phillips, & Tomáš Čižmár, "Comparison of nematic liquid-crystal and DMD based spatial light modulation in complex photonics," Opt. Express 25, 29874-29884 (2017)**
- **Ivo T. Leite, Sergey Turtaev, Xin Jiang, Martin Šiler, Alfred Cuschieri, Philip St.J. Russell, & Tomáš Čižmár, "3-D holographic optical manipulation through high-NA soft-glass multimode fibre," Nature Photonics 12, 33-39 (2018)**

Experimental setup for fibre imaging

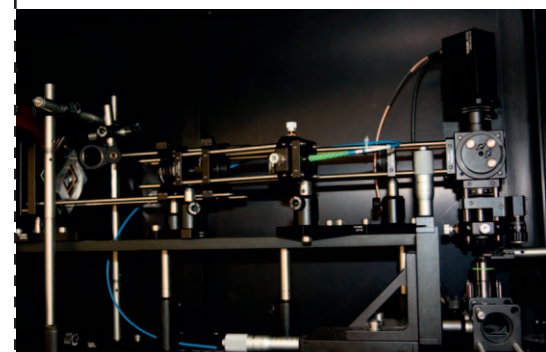

- **Dirk E. Boonzajer Flaes, Jan Stopka, Sergey Turtaev, Johannes F. de Boer, Tomáš Tyc, & Tomáš Čižmár, "Robustness of Light-Transport Processes to Bending Deformations in Graded-Index Multimode Waveguides," Phys. Rev. Lett. 120, 233901 (2018)**

MAIN COLLABORATING PARTNERS

Collaboration with academic partners

- Leibniz-Institut für Photonische Technologien (Jena, DE)
- University of Edinburgh (Edinburgh, UK)
- Oxford University (Oxford, UK)
- University of Exeter (Exeter, UK)
- Stanford University (Stanford, USA)
- Max Planck Institute for the Science of Light (Erlangen, DE)
- Vrije Universiteit Amsterdam (Amsterdam, NL)
- Masaryk University (Brno, CZ)
- University of Dundee (Dundee, UK)
- University of Glasgow (Glasgow, UK)
- University of St. Andrews (St. Andrews, UK)

EXPECTATIONS

Offers

We offer to share our expertise in the areas of waveguide optics, fluorescence imaging, nonlinear microscopy and digital holography.

Requirements

We look for cooperation with academic partners in the fields of *in-vivo* imaging, neuroscience, & optical manipulation.

FUNDING

European Regional Development Fund,
Project No. CZ.02.1.01/0.0/0.0/15_003/0000476



EUROPEAN UNION
European Structural and Investing Funds
Operational Programme Research,
Development and Education



MINISTRY OF EDUCATION,
YOUTH AND SPORTS

THEMATIC RESEARCH FOCUS

Research area

- Optics
- Laser spectroscopy
- Biophotonics
- Nanophotonics
- Lab-on-a-chips
- Optofluidics

Excellence

- Applications of focused laser beams (optical tweezers, optical cell sorters)
- Raman micro-spectroscopy combined with optical manipulations (Raman tweezers)
- Manufacturing of tailored microfluidic chips

Mission

Our main goal is to design and develop analytical techniques based on microfluidic and Raman spectroscopy to solve emerging tasks targeted on basic and applied biological research ranging from microorganisms to enzymes.

UP-TO-DATE ACTIVITIES

Research orientation

- Optical trapping
- Design of novel microfluidic chips for biological research
- Characterization of living microorganisms (e.g. bacteria, yeast and algae cells) using Raman microspectroscopy, Raman tweezers and microfluidic chips.
- Optical monitoring of chemical reactions running in emulsion droplets and lab-on-a-chip

Main capabilities

Basic research

- Determination of selected chemical content in living microorganisms using Raman microspectroscopy combined with optical micromanipulation and microfluidic techniques

Applied research

- Design and manufacturing of microfluidic chips
- Monitoring of polymers inside the cells with industrial biotechnological applications
- Identification of bacteria with clinical applications

Innovations

- Tailored microfluidic chips for clinical investigations of microorganisms

Institute of Scientific Instruments
of the CAS, v. v. i.

The Czech Academy of Sciences

Královopolská 147, 612 64 Brno,
Czech Republic

<http://www.isibrno.cz/>

[en/biophotonics-and-optofluidics](http://www.isibrno.cz/en/biophotonics-and-optofluidics)

Head: Dr. Ota Samek

Phone: +420 541 514 284

E-mail: osamek@isibrno.cz

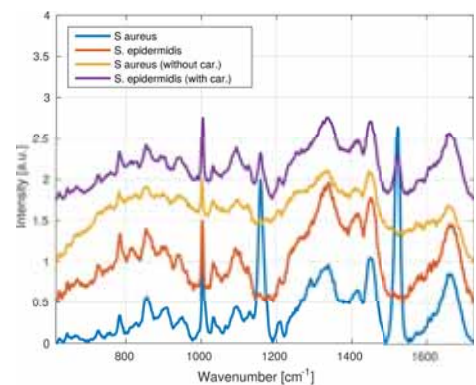

Raman spectra of bacteria showing the differences between the strains.

2D presentation of Raman spectra for different bacterial strains.

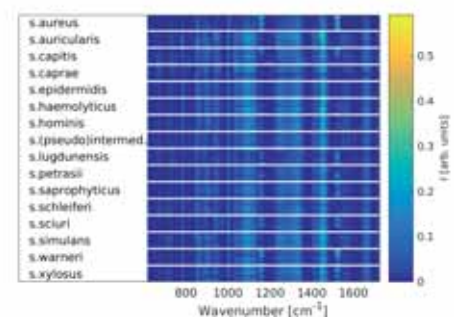

Sub-fields of group activities

- Optical microscopy
- Microtechnology, nanotechnology
- Biophotonics
- Cell biology
- Biochemistry
- Laser spectroscopy
- Microfluidics
- Lab-on-a-chip systems
- Microbiology

KEY RESEARCH EQUIPMENT

List of devices

- Renishaw In Via Reflex Raman microspectrometer
- Raman tweezers made by the research team
- Optical cell sorters made by the research team
- Fast CCD cameras (thousands fps)

ACHIEVEMENTS

Awards

- Zdeněk Pilát was awarded the best Ph.D. Thesis in 2015 by the Czechoslovak Microscopy Society

Publications

We are in the forefront of application of Raman spectroscopy to clinical praxis and biotechnological/industrial applications. Our latest research on identification and differentiation of bacteria is well recognized in scientific community and microbiological labs. Moreover, we contributed to the basic and applied research of polymer containing microorganisms and also in monitoring of chemical reactions directly on the microfluidic chip. We published more than 15 papers in impacted journals with very good citation response in the period 2013–2017. Combination of Raman microspectroscopy and optical tweezers offers a unique tool that provides contactless and nondestructive manipulation and diagnostics of living microorganisms. Optical tweezers provides 3D manipulation with objects and Raman microscopy represents one of a few contactless and nondestructive methods that provides information about the chemical bonds inside microobjects (even living cells).

■ Identification and differentiation of bacteria and yeast

- D. Procházka, M. Mazura, O. Samek, K. Rebrošová, P. Pořízka, J. Klus, P. Procházková, J. Novotný, K. Novotný, J. Kaiser: "Combination of laser-induced breakdown spectroscopy and Raman spectroscopy for multivariate classification of bacteria", *Spectrochimica Acta Part B* 139, 6-12, 2018.
- K. Rebrošová, M. Šiler, O. Samek, F. Růžička, S. Bernatová, V. Holá, J. Ježek, P. Zemánek, J. Sokolová, P. Petráš: "Rapid identification of staphylococci by Raman spectroscopy", *Scientific Reports* 7, 14846, 2017.
- K. Rebrošová, M. Šiler, O. Samek, F. Růžička, S. Bernatová, J. Ježek, P. Zemánek, V. Holá: "Differentiation between *Staphylococcus aureus* and *Staphylococcus epidermidis* strains using Raman spectroscopy", *Future Microbiology* 12, 881-890, 2017.
- O. Samek, S. Bernatová, J. Ježek, M. Šiler, M. Šerý, V. Krzyžánek, K. Hrubanová, P. Zemánek, V. Holá, F. Růžička: "Identification of individual biofilm-forming bacterial cells using Raman tweezers", *J. Biomed. Opt.* 20, 051038, 2015.

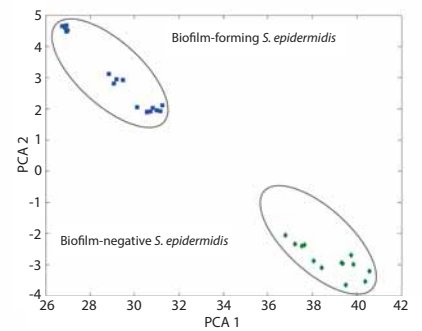

PCA plot demonstrating differentiation of the biofilm-forming and biofilm-negative bacterial staphylococcal strains.

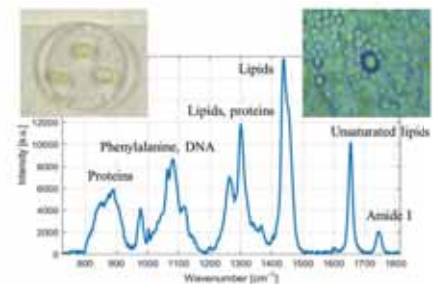

Raman spectrum of an oil drop produced by yeast *Metschnikowia*. Left inset shows pipetted sample, magnified detail is shown on the right inset.

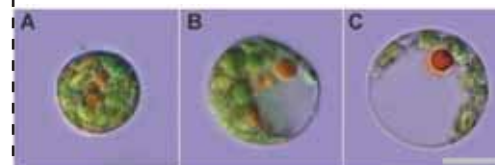

Living alga cells *Trachydiscus minutus* cultivated at different light conditions and having different contents of lipid bodies.

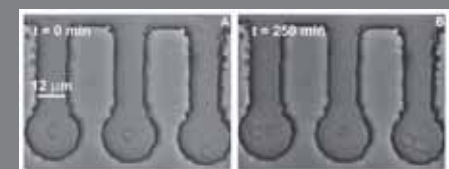

Microfluidic chambers used for separation of cells out of the main channel. Cells are introduced to the chamber using the optical tweezers.

- O. Samek, K. Mlynáriková, S. Bernatová, J. Ježek, V. Krzyžánek, M. Šiler, P. Zemánek, F. Růžička, V. Holá, M. Mahelová: "Candida parapsilosis biofilm identification by Raman spectroscopy", *Int. J. Mol. Sci.* 15, 23924-23935, 2014.
- K. Mlynáriková, O. Samek, S. Bernatová, F. Růžička, J. Ježek, A. Haroniková, M. Šiler, P. Zemánek, V. Holá: "Influence of culture media on microbial fingerprints using Raman spectroscopy", *Sensors* 15(11), 29635-29647, 2015.
- S. Bernatová, O. Samek, Z. Pilát, M. Šerý, J. Ježek, P. Jákl, M. Šiler, V. Krzyžánek, P. Zemánek, V. Holá, M. Dvořáčková, F. Růžička: "Following the mechanisms of bacteriostatic versus bactericidal action using Raman spectroscopy", *Molecules* 18(11), 13188-13199, 2013.

■ Applications to microorganisms containing polymers and algae

- S. Obruča, P. Sedláček, F. Mravec, V. Krzyžánek, J. Nebesářová, O. Samek, D. Kučera, P. Benešová, K. Hrubanová, M. Milerová, I. Márová: "The presence of PHB granules in cytoplasm protects non-halophilic bacterial cells against the harmful impact of hypertonic environments", *New Biotechnology* 39, 68-80, 2017.
- Z. Pilát, A. Jonáš, J. Ježek, P. Zemánek: "Effects of Infrared Optical Trapping on *Saccharomyces cerevisiae* in a Microfluidic System", *Sensors* 17, 2640, 2017.
- F. Mravec, S. Obruča, V. Krzyžánek, P. Sedláček, K. Hrubanová, O. Samek, D. Kučera, P. Benešová, J. Nebesářová: "Accumulation of PHA granules in *Cupriavidus necator* as seen by confocal fluorescence microscopy", *FEMS Microbiology Letters* 363(10), 2016.
- S. Obruča, P. Sedláček, V. Krzyžánek, F. Mravec, K. Hrubanová, O. Samek, D. Kučera, P. Benešová, I. Márová: "Accumulation of Poly(3-hydroxybutyrate) helps bacterial cells to survive freezing", *PLoS ONE* 11, e0157778, 2016.
- S. Obruča, P. Sedláček, F. Mravec, O. Samek, I. Márová: "Evaluation of 3-hydroxybutyrate as an enzyme-protective agent against heating and oxidative damage and its potential role in stress response of poly(3-hydroxybutyrate) accumulating cells", *Appl Microbiol Biotechnol* 100, 1365-1376, 2016.
- P. Pořízka, P. Procházková, D. Procházka, L. Sládková, J. Novotný, M. Petrílek, M. Brada, O. Samek, Z. Pilát, P. Zemánek, V. Adam, R. Kizek, K. Novotný, J. Kaiser: "Algal biomass analysis by laser-based analytical techniques—A review", *Sensors* 14, 17725-17752, 2014.
- Z. Pilát, J. Ježek, M. Šerý, M. Trtílek, L. Nedbal, P. Zemánek: "Optical trapping of microalgae at 735-1064 nm: Photodamage assessment", *Journal of Photochemistry and Photobiology B: Biology* 121, 27-31, 2013.
- Z. Pilát, S. Bernatová, J. Ježek, M. Šerý, O. Samek, P. Zemánek, L. Nedbal and M. Trtílek: "Raman microspectroscopy of algal lipid bodies: beta-carotene quantification", *Journal of Applied Phycology* 24, 541-546, 2012.
- P. Pořízka, D. Procházková, Z. Pilát, L. Krajcarová, J. Kaiser, R. Malina, J. Novotný, P. Zemánek, J. Ježek, M. Šerý, S. Bernatová, V. Krzyžánek, K. Dobranská, K. Novotný, M. Trtílek, O. Samek: "Application of laser-induced breakdown spectroscopy to the analysis of algal biomass for industrial biotechnology", *Spectrochimica Acta Part B: Atomic Spectroscopy* 74-75, 169-176, 2012.

■ Optical monitoring of biochemical reactions running in emulsion droplets in microfluidic chips

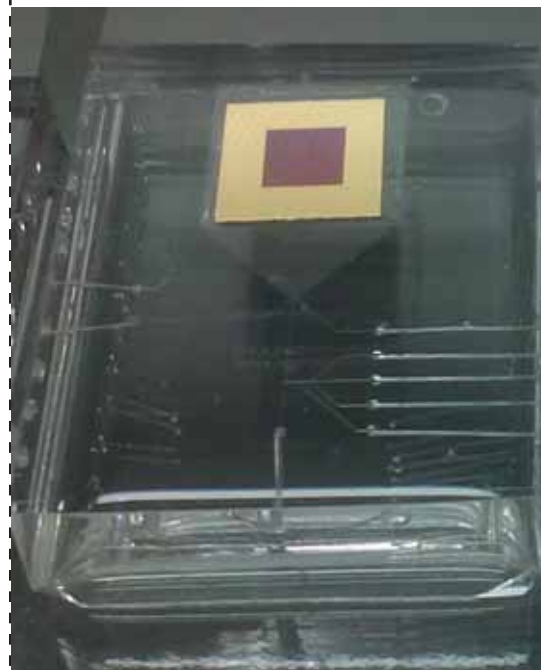

Microfluidic chip with Au/Si substrate for surface enhanced Raman spectroscopy (SERS) of low concentrations of various halogenated hydrocarbons.

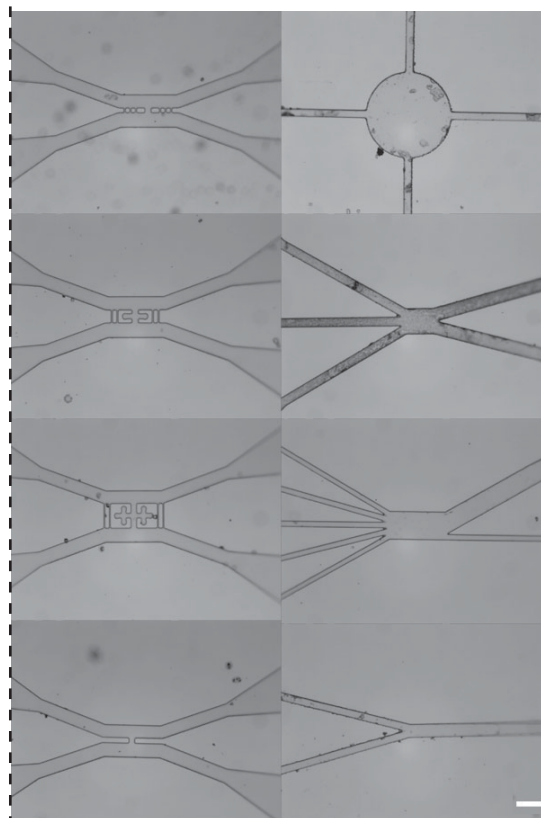

Various microchannel designs for flow routing, cell sorting, and storage.

MAIN COLLABORATING PARTNERS

Collaboration with academic partners

- Brno University of Technology (Brno, CZ)
- Consiglio Nazionale delle Ricerche (Messina, IT)
- Institute of Experimental Physics, Slovak Academy of Sciences (Košice, SK)
- Masaryk University (Brno, CZ)
- Universität für Bodenkultur (Wien, Austria)
- University of Graz (Graz, Austria)
- University of Life Sciences (As, Norway)
- University of Naples Federico II (Naples, IT)
- University of Jena (Jena, Germany)
- IPHT Jena (Jena, Germany)

Collaboration with companies

- Meopta (Přerov, CZ)
- Photon Systems Instruments (Drásov, CZ)

EXPECTATIONS

Offers

- We offer collaboration in the areas of our expertise.
- Partnership in international projects
- Custom manufacturing of microfluidic chips.

Requirements

We would like to cooperate with academic partners as well as companies in the fields of optics, biophotonics, biotechnology, microtechnologies and applications of microfluidic chips.

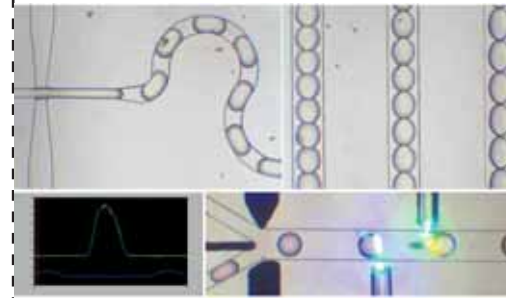

An example of droplet microfluidics. Top left: droplet generation, top right: parallel channels, bottom: fluorescent characterization of the droplet content.

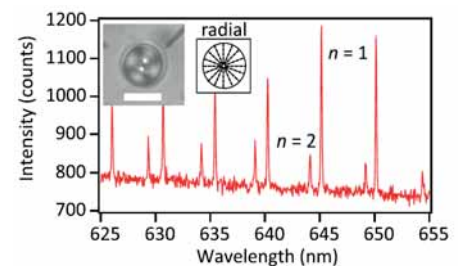

WGM spectra from thermally tuned optically trapped liquid crystal droplet resonator. Scale bar: 10 μm

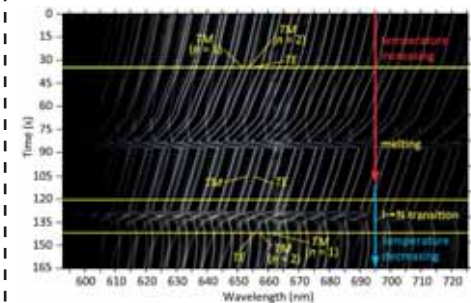

Thermal tuning of WGM emission of liquid crystal droplets, mapping of the transitions between isotropic and nematic phases.

Group of Coherent Lasers and Interferometry

Department of Coherence Optics



Institute of Scientific
Instruments
The Czech Academy
of Sciences

THEMATIC RESEARCH FOCUS

Research area

Fundamental optical metrology

- Optical ion clocks
- Femtosecond laser based optical frequency synthesis
- Standards of optical frequencies and distribution of highly stable optical frequencies
- High resolution interferometry and nanometrology

Industrial metrology and measuring methods

- Industrial interferometry
- Optical sensing and measuring techniques
- Fibre Bragg grating based fibre-optic sensors

Special instrumentation in optics and electronics

Excellence

- Quantum mechanics with trapped Calcium ions with the goal of development of optical laser oscillator
- Optical frequency synthesis with a technique of locking optical frequency to a mechanical standard
- Technology of time and frequency transfer through long haul optical networks
- Contactless gauge blocks calibration and diagnostics combining through novel interferometric technique
- High resolution interferometry for nanometrology
- Refractometry and interferometry with compensation for variations of the refractive index of air
- World leader in technology of high purity absorption cells for fundamental metrology
- Methods and techniques for industrial dimensional optical metrology
- Fibre strain and deformation sensing via a of FBG strain sensors
- Real-time dissemination of process values via industrial networks (CANbus and Ethernet)

Institute of Scientific Instruments
of the ASCR, v. v. i.

The Czech Academy of Sciences
Královopolská 147, 612 64 Brno,
Czech Republic
www.isibrno.cz/kgs

Head: Dr. Ondřej Číp

Phone: +420 541 514 254

E-mail: Ondrej.Cip@isibrno.cz

Head of the department: Prof. Josef Lazar

Phone: +420 541 514 253

E-mail: Josef.Lazar@isibrno.cz

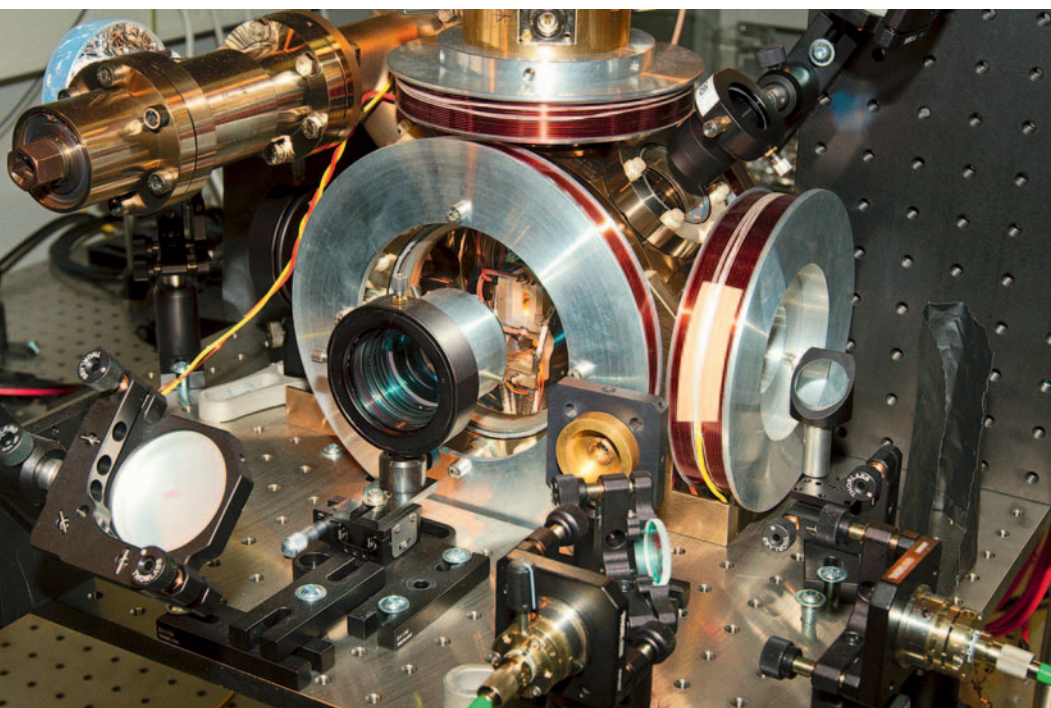

Experimental arrangement of the ion trap for Calcium ions oriented to development of ultrastable laser optical frequency standard

Mission

Our mission is research on the border between physics and technical sciences, which includes fundamental, targeted and applied research as well. Our research is methodologically oriented. The goal of most of our projects is an introduction of a novel method, technique or approach and its experimental verification. This includes design of often highly complex and sophisticated experimental assemblies. In optical metrology it often means pushing the limits of resolution and precision. Fundamental research in our case means predominantly research in fundamental metrology. Our involvement in applied research is motivated by the tradition of the institute, which has always tried to promote technology transfer and applications of its research in practice.

DEVELOPED TECHNOLOGIES

Content of research

- Stabilized lasers – standards of optical frequencies for fundamental and industrial metrology and interferometry
- Laser interferometric systems for coordinate measurement and various special applications
- References of optical frequencies – absorption cells for metrology and laser spectroscopy
- Technology and electronic control systems for femtosecond laser based optical frequency synthesis
- Special optical sensors for various applications
- Technology and electronic control of phase coherent optical frequency transfer via fiber links
- Laser induced fluorescence for body fluid level measurement and tissue necrosis detection
- Electronics and control electronics for experiments and special instrumentation
- Methodology and instrumentation for contactless gauge blocks calibration and diagnostics
- Design, fabrication and employment of Fibre Bragg Grating (FBG) elements for length measurement

Main capabilities

- Technology of ultra-precise measurement of lengths with stable, tuneable and femtosecond lasers
- Methods of suppression of fluctuation of the refractive index of air for length measurement in the air
- Interferometry using a novel digital derivative technique for detection of the interference signal
- Method for scale linearization of interference fringe for ultra-precise laser interferometry
- Techniques of locking tuneable lasers to optical frequency components of femtosecond laser spectrum
- Technology of high purity absorption gas cell production (also custom-made) and high purity gas production.
- Methods for real-time dissemination of process values through network (CAN-bus and Ethernet)

Fields of research results application

- Optics
- Precision engineering
- Medical technology
- Automotive industry
- Software
- Telecommunications



Operation of the Hydrogen maser – a radiofrequency reference

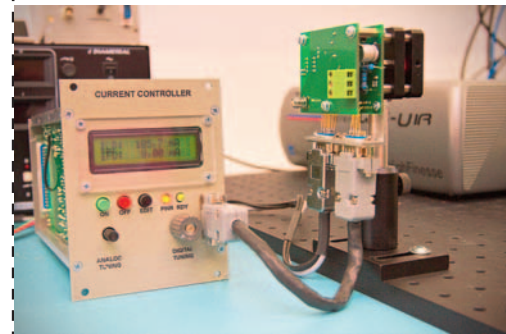

Controller and supporting circuitry for single-frequency laser diode operating in the visible spectral range

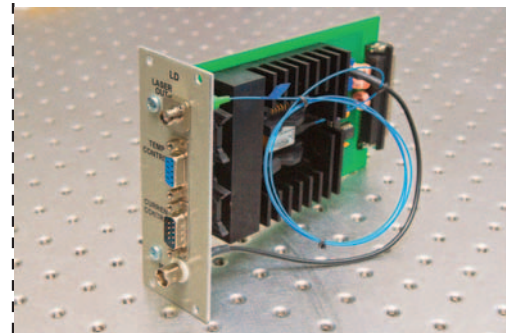

Highly coherent semiconductor laser for the telecommunication applications

Stabilized laser source designed as optical frequency reference in the near-infrared spectral range

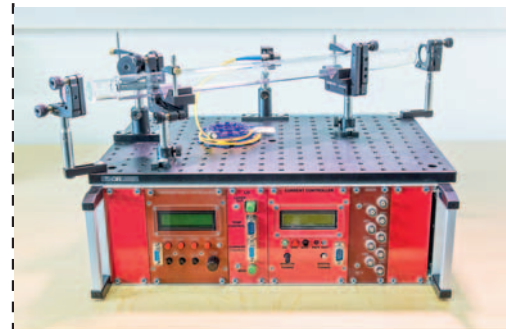

KEY RESEARCH EQUIPMENT

List of devices

- Optical frequency synthesizers (optical “combs”) based on femtosecond lasers (visible and IR)
- Set of optical frequency standards operating at 532 nm, 633 nm and 1550 nm wavelengths
- Active H-maser – highly stable radiofrequency time and frequency standard
- Laboratory instrumentation for experiments with optics, vacuum technology and electronics



Nanocomparator for interferometric calibration of displacement sensors for the automotive industry

ACHIEVEMENTS

■ A method for non-linearity compensation of interference fringes in homodyne laser interferometer

- O. Číp, F. Petrů: “A scale-linearization method for precise laser interferometry”, MEASUREMENT SCIENCE & TECHNOLOGY **11**, 133-141, 2000

■ A method for the suppression of refractive index of air fluctuation in interferometric measurement of precise length

- J. Lazar, M. Holá, O. Číp, M. Čížek, J. Hrabina, Z. Buchta: “Displacement interferometry with stabilization of wavelength in air”, OPTICS EXPRESS **20**, 27830–27837, 2012

■ Tunable extended cavity laser (ECL) as an optical frequency standard working at 633 nm

- J. Lazar, O. Číp, P. Jedlička: “Tunable extended cavity laser (ECL) as an optical frequency standard working at 633 nm”, APPLIED OPTICS **39**, 3085-3088, 2000

■ A method for the measurement of coefficient of thermal expansion of stable materials (Zerodur, ULE)

- O. Číp, R. Šmíd, M. Čížek, J. Lazar: “Study of the thermal stability of Zerodur glass ceramics suitable for a scanning probe microscope”, CENTRAL EUROPEAN JOURNAL OF PHYSICS, **10**, 447–453, 2012

■ A novel method of contactless gauge block calibration by combination of coherent light and white light produced by mode-locked laser

- Z. Buchta, S. Řeřucha, B. Mikel, M. Čížek, J. Lazar, O. Číp: “Novel Principle of Contactless Gauge Block Calibration”, SENSORS **12**, 3350-3358, 2012

■ Gold medal of 54th International Engineering Fair in Brno (2012) for Contactless laser interferometer system for gauge block calibration by combination of coherent light and white light produced by picosecond laser (in cooperation with an industrial partner – the Mesing company)

■ Werner von Siemens Excellence Award (2012) for Novel method of contactless gauge block calibration by combination of coherent light and white light produced by mode-locked laser

■ The editors of the Technický týdeník (Technical Weekly) along with the editors of the periodical Automatizace (Automatization) awarded their prize at the 50th International Engineering Fair in Brno (2008) to the joint team of researchers that developed the Laser nano-comparator. The research group for the first time presented a unique method for



Fibre-optic hub for distribution of precise optical frequencies

Positioning platform with six-axis interferometric measurement and motion control for nanometrology

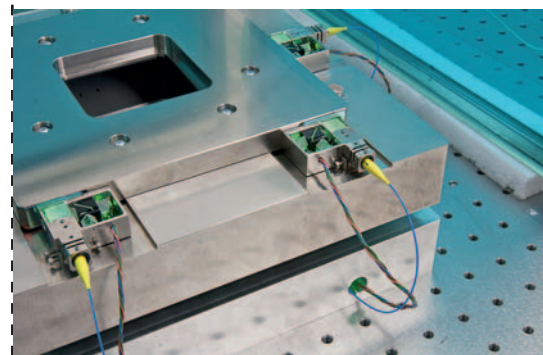



Contactless laser interferometer system for gauge block calibration awarded Gold medal of 54th International Engineering Fair in Brno

the active stabilization of the laser beam position which improves the reproducibility of the calibration process at the nanometer level.

- **In the past ten years, three scientists from the group were awarded by the international community URSI (International Union of Radio Science), IMEKO (International Measurement Confederation) and SPIE (International Society for Optics and Photonics) for their work in the field of precise measurement of lengths and methods of laser optical frequency stabilization.**

MAIN COLLABORATING PARTNERS

Collaboration with academic partners

- Czech Metrology Institute (Brno, CZ)
- Brno University of Technology (Brno, CZ)
- Palacky University in Olomouc (Olomouc, CZ)
- PTB Braunschweig (Braunschweig, D)
- VSL Delft (Delft, NL)
- CESNET (Prague, CZ)
- NPL (Teddington, UK)

Collaboration with companies

- MESING (Brno, CZ)
- TESCAN ORSAY HOLDING (Brno, CZ)
- Meopta-Optika (Přerov, CZ)
- PROFComms (Brno, CZ)
- NETWORK GROUP (Brno, CZ)
- ÚJV Řež (Prague, CZ)

EXPECTATIONS

Offers

- A number of excellent fundamental research results in these fields:
- High-resolution laser interferometry for length measurement in vacuum and air
- Optical measurement of concentration of various gases
- Detection of stress and length changes by FBG grating technology
- Scientific instrumentation for real-time processing of signals in laser interferometers and length measurement

Requirements

Cooperation in joint collaborative projects where we are looking for a partner able to concentrate on technical and technological development following the research phase.

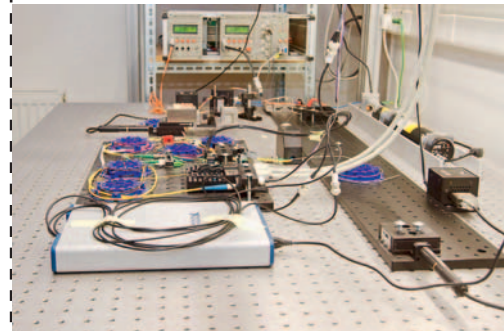

Testbed for fiber-optic displacement sensors based on FBG technology and evaluation through spectrum analysis

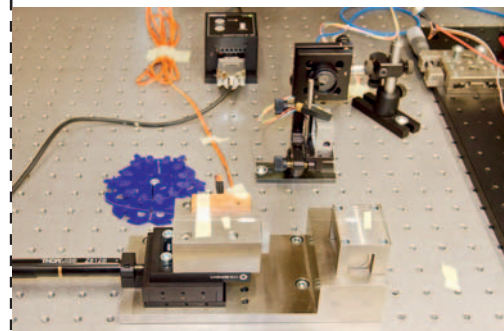

Calibration setup for FBG sensors with laser interferometer as a reference

THEMATIC RESEARCH FOCUS

Research area

- Laser welding
- Laser 2D/3D cutting
- Process diagnostic
- Visualizations of process gas flowing
- High power beam shaping

Excellence

- Diagnostics of laser welding process
- Visualization of gas flowing in laser welding and laser cutting process

Mission

- Theoretical and experimental study of the laser welding process
- Control of the laser welding process
- Application of the laser welding technology for the manufacturing of heat exchangers and solar absorbers
- Thin optical coatings for high-power laser optics

UP-TO-DATE ACTIVITIES

Research orientation/focus

- Correlation of the penetration depth and the frequency characteristics of the light emissions produced during the welding process
- Numeric modeling of the laser welding process
- Analysis of the welding process dynamics by means of image processing
- Analysis of the laser weld microstructure by means of electron microscopy
- Development of optical components adjusting the intensity distribution and the focal geometry of the laser beam
- Theoretical and experimental study of laser induced damage threshold of thin film optical coatings

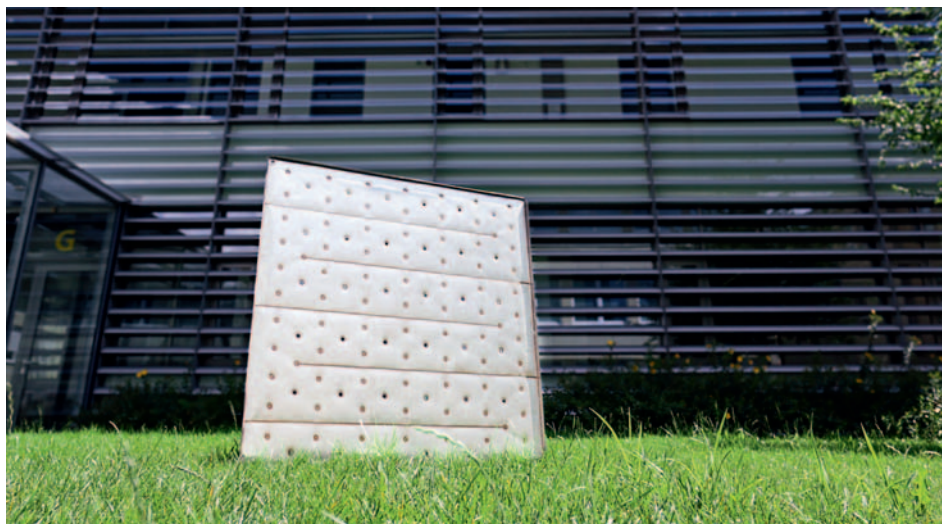

Laser welded solar collectors

**Institute of Scientific Instruments
of the CAS, v. v. i.**

The Czech Academy of Sciences
Královopolská 147, 612 64 Brno,
Czech Republic
<http://www.isibrno.cz/omitec/>

Head: Assoc. Prof. Libor Mrňa
Phone: +420 541 514 369,
+420 731 462 192
E-mail: mrna@isibrno.cz

Main capabilities

Basic research

- Study of the welding process using a method based on frequency analysis of the light oscillations produced during the process
- Numeric modeling of the welding process depending on the welding parameters and the focal geometry of the laser beam

Applied research

- New type of a sensor monitoring the quality of the laser welding process
- System for continuous control and optimization of the laser beam geometry during the welding process
- Heat exchangers and solar absorbers with controlled circulation
- Laser induced damage threshold test station

Innovations

- Licence agreement about utilization of methods of monitoring laser welding process based on patent CZ303797

Sub-fields of group activities

- Engineering industry related to modern methods of material processing
- Renewable energy
- Materials science
- Optics for high-power lasers

KEY RESEARCH EQUIPMENT

List of devices

- Laser YLS2000 (IPG photonics)
- Welding head YW30 (Precitec)
- Cutting head YRC100, (Precitec)
- Scanning welding head Fiber RHINO (ARGES)
- Robotic arm IRB2400 and 2-axis rotary positioner IRBP250 (ABB)
- Infrared Camera FLIR A310
- BeamWatch BW-NIR-2-55 (Ophir)
- PIAD Electron beam evaporation coating system SYRUSpro 710 (Leybold Optics)
- Electron beam evaporation coating system Balzers BAK550
- Spectrophotometer Varian CARY 5E

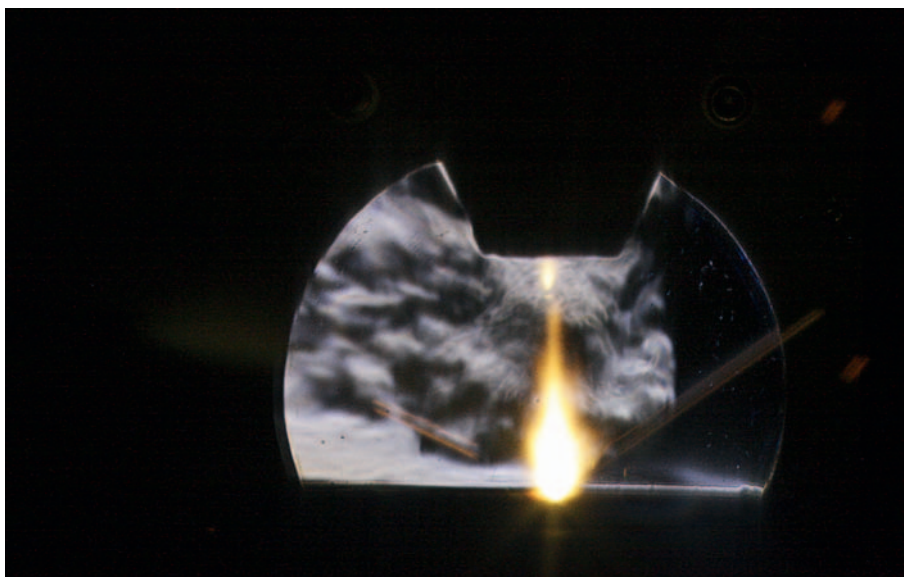

Displaying the flow of shielding gas and plasma plume in the schlieren field

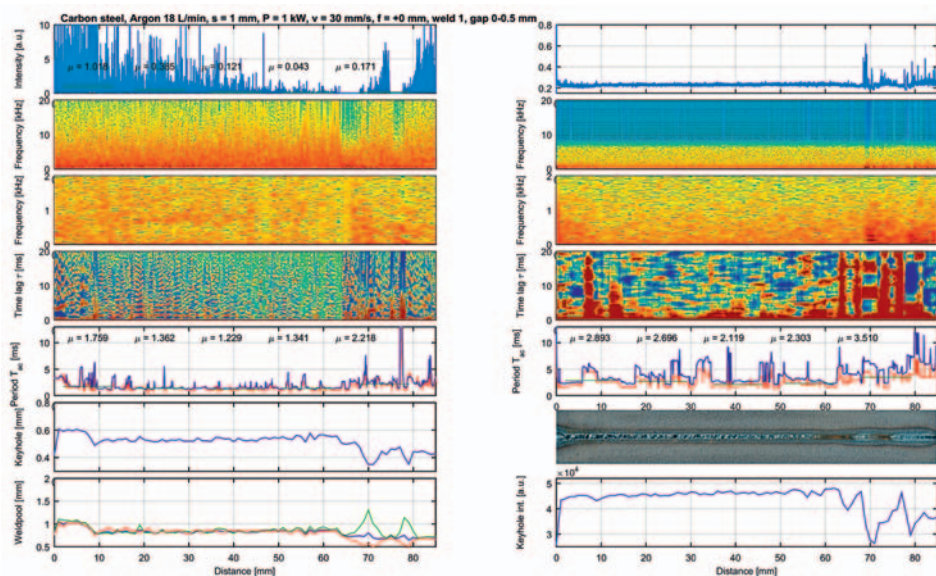

An example of a complex evaluation of the radiation of plasma plume through the laser weld

ACHIEVEMENTS

■ We study the laser welding process using frequency and time analysis of plasma plume radiation and using the schlieren methods for visualizes the interaction between plasma and shielding gas.

- L. Mrňa, P. Horník: "Autocorrelation Function for Monitoring the Gap between The Steel Plates During Laser Welding" *Physics Procedia*. **83**, 1223-1232, 2016
- L. Mrňa, M. Šarbort, Š. Řeřucha: "Autocorrelation analysis of plasma plume oscillations in deep penetration laser welding", *Lasers in Manufacturing (LiM)*, Munich: WLT, 75, 2015
- L. Mrňa, M. Šarbort: "Plasma bursts in deep penetration laser welding", *Physics Procedia*. 8th International Conference on Laser Assisted Net Shape Engineering (LANE 2014), 1-1436, 2014

■ We designed the optics to change the profile of the power of the laser beam.

- L. Mrňa, M. Šarbort, Š. Řeřucha, P. Jedlička: "Adaptive optics for control of the laser welding process", *OaM 2012 - Optics and Measurement International Conference*. Proceedings of a meeting **48**. Liberec: EDP Sciences, 00017:1-6, 2013

■ We participate in the design and construction of new types of solar absorbers, where it uses laser welding technology.

- L. Mrňa, Z. Lidmila, K. Podaný, M. Forejt, J. Kubiček: "Manufacturing of Solar Absorber by Unconventional Methods", *METAL 2012 Conference Proceedings* 21st International Conference on Metallurgy and Materials, Ostrava: TANGER Ltd, 2012

MAIN COLLABORATING PARTNERS

Collaboration with academic partners

Brno University of Technology (Brno, CZ)
Masaryk University (Brno, CZ)

Collaboration with companies

- Tescan Orsay (Brno, CZ)
- Aquadem (Brno, CZ)
- Matex PM (Plzeň, CZ)
- HIWIN (Brno, CZ+South Korea)
- Thermacut (Uherské Hradiště, CZ+USA)

EXPECTATIONS

Offers

- Licensing of the patent for automatic optimization of the laser beam geometry in laser welding
- Partnership in international projects
- Contractual research in laser welding, cutting, etc.
- Consulting in the field of laser welding, cutting, surface hardening etc.
- Cooperation in the development of solar absorbers and heat exchangers
- Design and production of custom thin film optical coatings
- Consulting in the field of optical coating deposition

Requirements

- Real interest in applied research and innovation
- Knowledge of grant projects
- Collaboration with industrial partners in common projects dedicated to applied science
- New complementary technologies



Laser cutting in action