

TECHNICAL STUDY OF JEWELLERY FROM THE “LUMBE GARDEN” CEMETERY AT PRAGUE CASTLE

ESTELLE OTTENWELTER, JIŘÍ DĚD, LUDMILA BARČAKOVÁ

1. INTRODUCTION

The technical study of the “Lumbe Garden” cemetery jewellery aims to investigate metal composition, construction, and decorative techniques displayed, considering each type of jewel present in the set: *gombiky*¹ (hollow, spherical pendants), earrings, beads, *kaptorgy* (amulet containers), temple-rings, chains, and jingle bells. The artefacts were first examined using an Olympus SZX7 stereomicroscope (10-40x magnification). X-ray radiography was undertaken to investigate the internal construction of the jewellery. Analyses were conducted by scanning electron microscopy with energy-dispersive X-ray spectrometry (SEM/EDS) (TESCAN VEGA 3 equipped with an Oxford INCA 350 EDS system and PHILIPS XL30 equipped with an EDAX system) on the different components of the jewels, on chosen areas selected previously by examination under stereomicroscope, and on unvarnished and cleaned surfaces. They were performed by the Department of Metals and Corrosion Engineering at the Institute of Chemical technology in Prague and by the Department of Structure and Phase Analyses from the Faculty of Mechanical Engineering BUT in Brno.

The dimensions of the different components of the jewellery were measured with the Olympus SZX7 stereomicroscope and Olympus QuickPHOTO camera 3.0 software.

Metallographic analysis was conducted on available samples to characterize metal composition, solder, metallic coatings, and corrosion processes (see *Kolářová - Děd - Ottenwelter* in this volume for metallography of silver samples). Cross-sections were examined and documented using an Olympus BX60 reflected light metallographic microscope and an Olympus E-450 digital camera.

Finally, replicas of the main types of jewellery present in the set were manufactured by a professional goldsmith (see *Barčaková* in this volume) in order to understand the different steps of manufacture, compare approximate time of manufacture, level of difficulty, and weight of precious metal used for each type of jewellery.

2. CONDITION OF THE ANALYSED ARTEFACTS

The metal chemical composition on the surface of the artefacts appeared to be affected not only by corrosion during burial but also by past restoration treatments applied to the artefacts in the seventies and partly in 2001 as well as decades of inappropriate handling and storage. Use of alkaline cyanides solutions to clean the silver artefacts has led to an almost complete dissolution of corrosion products formed during burial, including internal corrosion products, and to severe leaching of the remaining metallic surface. A newly formed layer of tarnish was covering the surface of the silver and gilt silver artefacts before re-restoration. Copper gilded artefacts appeared to be almost completely mineralized. In some cases, however, the gilding layer was still covered by remains of past corrosion products and newly formed copper corrosion products. Past treatment using EDTA[®] dissolved external but also internal corrosion products leading to a considerable loss of the gilding layer and limit of the original surface. In this context, the possibility of using available fragments to proceed with metallographic examinations and analyses allowed us to obtain more accurate results than surface analyses.

¹ *gombik(y)*: sing/pl *kaptorga-kaptorgy*: sing/pl

3. GOMBIKY

Gombiky are hollow, spherical pendants mainly found in the graves of wealthy individuals. Their function is still not clear. They may be prestigious clothing fasteners, symbolizing affiliation to the upper social classes or a luxurious amulet. They are found in the graves of both men and women as well as children, usually in pairs (*Galuska 2013*, p. 182-183). If we consider mainly the material used, the shape of the shells, and the technique of decoration as distinguishing parameters, five main types of *gombiky* can be distinguished in the set of the “Lumbe Garden” cemetery (*Fig. 4/1*). Each type of *gombik* is represented by a single pair of identical *gombiky*, except the third type which contains six sub-groups, each represented by an identical pair of *gombiky*, each one distinguished from the other mainly by the motifs displayed in the decoration and their size.

All *gombiky* are constructed around a similar central unit consisting of two identical shells (usually hemispheres) joined together (A_1, A_2) (*Fig. 4/5*). The upper shell is pierced on the top (*Fig. 4/5-A*). In most cases, the suspension system includes a loop (*Fig. 4/5-D*) fixed with a clamp with straight legs flattened on the internal side, inserted in a hole, and fixed with a ring (*Fig. 4/5-B*) of plain circular-section wire soldered to the top hemisphere. *Gombiky* are differentiated from each other by the shape and size of their shell, the type of their suspension loop fitting, the decorative technique used, the motifs depicted on their surface, and the material used to manufacture them. *Gombiky* are usually found in pairs. One, if not both, contain a small metallic pellet (*Fig. 4/5-E*) inside which makes them chime like jingle bells (*Fig. 4/6d*).



Fig. 4/1: Summarizing table of the analysed *gombiky*: type 1 - Au-Ag-Cu alloy, glass cabochons (H16-14), 9 different kinds of components; type 2 - Ag-Cu alloy (H115-7), 4 different kinds of components; type 3 - gilded copper alloys (H84-1, H115-8, H104-3, H108-2, H104-4, H99-5), 3 to 4 different kinds of components; type 4 - gilded copper alloy, glass cabochons (H74B-2), 6 different kinds of components; type 5 - gilded copper alloys, glass cabochons (H53-14), 8 different kinds of components.

Obr. 4/1: Souhrnný přehled typů analyzovaných gombíků: typ 1 – slitina Au-Ag-Cu, skleněné vložky (H16-14), složen z devíti různých druhů komponent; typ 2 – slitina Ag-Cu (H115-7), složen ze čtyř různých druhů komponent; typ 3 – zlacená slitina mědi (H84-1, H115-8, H104-3, H108-2, H104-4, H99-5), složen ze tří až čtyř různých druhů komponent; typ 4 – zlacená slitina mědi, skleněné vložky (H74B-2), složen ze šesti různých druhů komponent; typ 5 – zlacená slitina mědi, skleněné vložky (H53-14), složen z osmi různých druhů komponent.

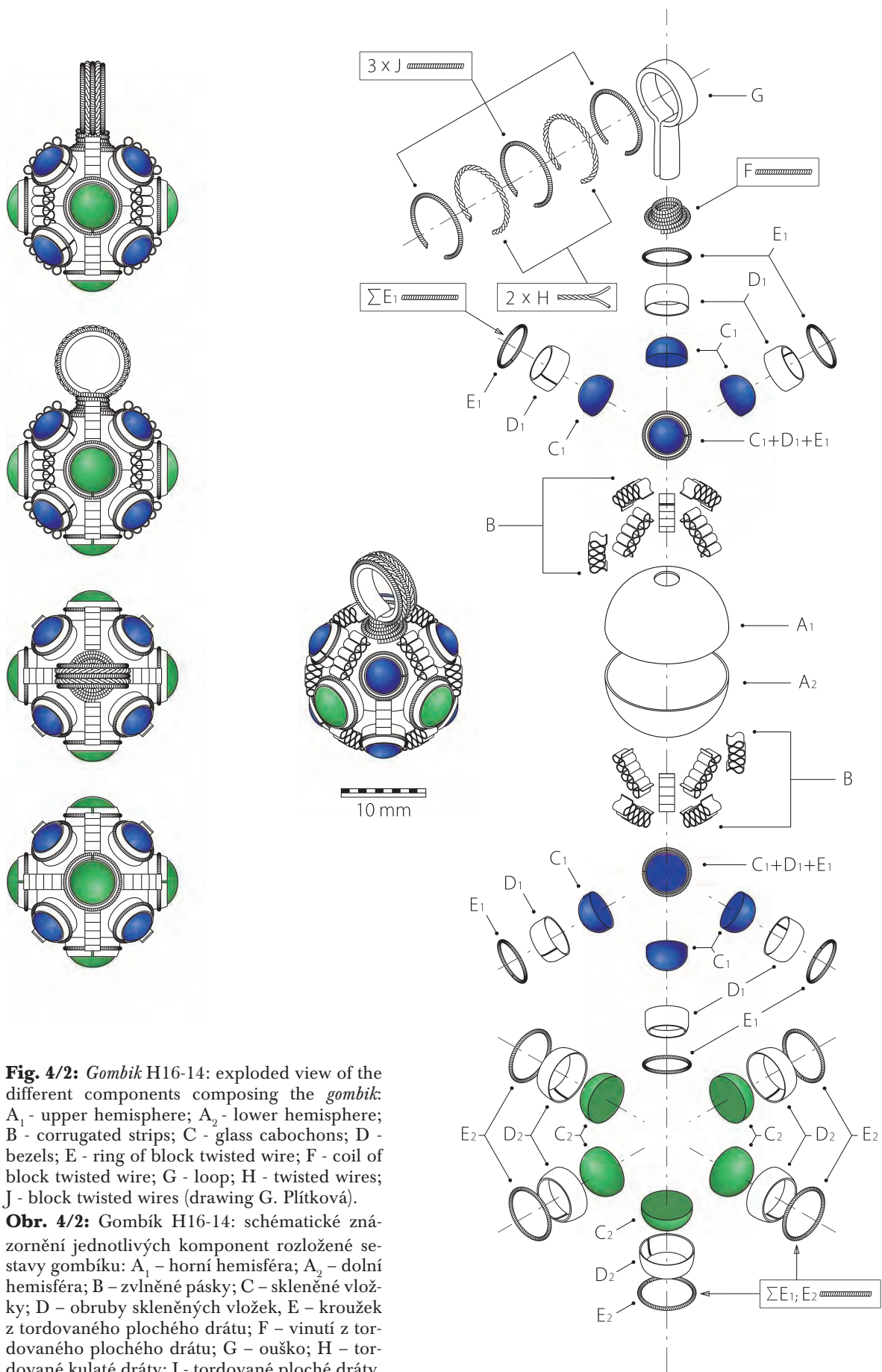

Fig. 4/2: *Gombík* H16-14: exploded view of the different components composing the *gombík*: A_1 - upper hemisphere; A_2 - lower hemisphere; B - corrugated strips; C - glass cabochons; D - bezels; E - ring of block twisted wire; F - coil of block twisted wire; G - loop; H - twisted wires; J - block twisted wires (drawing G. Plítková).

Obr. 4/2: Gombík H16-14: schématické znázornění jednotlivých komponent rozložené sestavy gombíku: A_1 - horní hemisféra; A_2 - dolní hemisféra; B - zvlněné pásy; C - skleněné vložky; D - obruby skleněných vložek; E - kroužek z torzovaného plochého drátu; F - vinutí z torzovaného plochého drátu; G - ouško; H - torzované kulaté dráty; J - torzované ploché dráty.

3.1. GOLD „TWO-LAYERED GOMBIK” WITH CORRUGATED STRIPS AND COLORED GLASS CABOCHON DECORATION (TYPE 1)

This type of *gombik* was found as a pair in grave H16 where a young woman was buried. Other graves goods included thirteen zoomorphic earrings in solid ternary Au-Ag-Cu alloy, a highly decorated silver *kaptorga*, three metallic beads in solid ternary Au-Ag-Cu alloy, and a knife (*Frolík - Smetánka 2014*, p. 64-68).

Description of the *gombik* H16-14 (grave 16 – item number 14; Fig. 4/2)

The central part of the *gombik* consists of two hemispheres joined together (Fig. 4/2-A₁-A₂, 4/3e). The upper hemisphere is pierced in the middle. The suspension loop fitting is composed of a circular loop with two elongated legs (Fig. 4/2-G) made of a strip of metal of 3,1 mm width decorated by three block twisted wires² (Fig. 4/2-J) of 0,4 mm in diameter alternating with two loosely twisted double wire (Fig. 4/2-H) of 0,6 mm in diameter (Fig. 4/3c). The suspension loop is inserted into the upper hemisphere and soldered to the hemisphere together with a rope of block twisted wire forming six circles of increasing diameter (F) (Fig. 4/3d). The *gombik* is decorated with blue (Fig. 4/2-C₁) and green (Fig. 4/2-C₂) glass cabochons inserted in bezels (Fig. 4/2-D, 4/3a). The bezels are decorated with a ring of block twisted wire (Fig. 4/2-E, 4/3g) of 0,4 mm in diameter. Four blue glass cabochons (Fig. 4/2-C₁) must have been placed on each hemisphere, although one is missing and has been replaced by a small, irregular, green cabochon which is probably a clumsy attempt of repair (Fig. 4/3a). Four green glass cabochons (Fig. 4/2-C₂) must have originally been placed on the joining area of the two hemispheres but one is presently missing. The bottom cabochon is also missing. According to the diameter of the bezel, it was probably a blue cabochon because it is a bezel of smaller diameter, green cabochons having a larger diameter (table 1).

Twelve corrugated strips (Fig. 4/2B, 4/3f) are placed between the bezels with glass cabochons. They are placed vertically, joining the blue cabochons together and following along the joining area of the two hemispheres. Corrugated strips are also vertically joining the green cabochons to the suspension loop and to the bottom bezel. A total of nine different types of components and a total of fifty-eight components had to be manufactured to produce this *gombik*. The bezels, the loop, wires (Fig. 4/2-J), and the corrugated strip were manufactured from strips of metal. The hemispheres are embossed discs. The wires (Fig. 4/2H) were probably drawn and then twisted. All the components were soldered together.

Condition of the artefact and quality of work

The *gombik* is in a good state of preservation, although the corrugated strips have been mechanically deformed by overburden (Fig. 4/3a, d, f). Two glass cabochons are missing and a bezel was filled with a tiny fragment of green glass probably in an unsuccessful attempt to replace the lost original cabochon. The overall quality of the artefact is very high.

<i>Gombik</i> H16-14		Dimensions [mm]
hemisphere (A)	Ø	18
Loop (G)	Ø	7
Loop (G)	width	2.8
Block twisted wire (J, E ₁ , E ₂)	Ø	0.4
Loosely twisted double wire (H)	Ø	0.6
Corrugated strip (B)	width	1.4
Corrugated strip (B)	thickness	0.1
Bezel (D)	width	3.1
Bezel (D)	thickness	0.1
Green glass cabochon (C ₂)	Ø	6.1
Blue glass cabochon (C ₁)	Ø	5.1

Table 1: Dimensions of the *gombik* H16-14 and its components.

Tab. 1: Rozměry gombíku H16-14 a jeho částí.

² Block twisted wires are wires made from a single strip of metal twisted (*Ogden 1982*, p. 46-57)

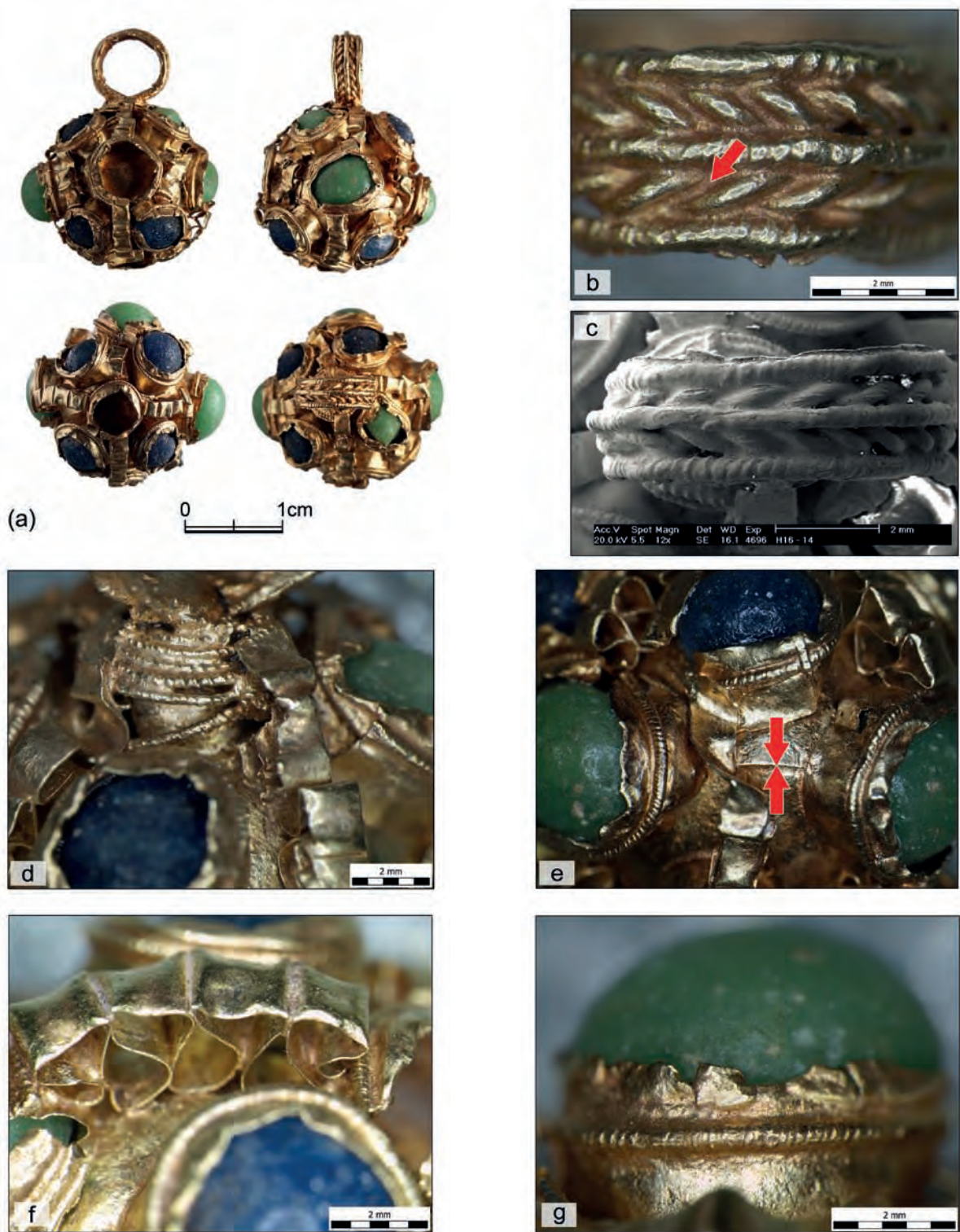

Fig. 4/3: *Gombík* H16-14: a - general view of the *gombík* (photo J. Sobek); b - decorated loop with reddish color solder area between the wires (photo E. Ottenwelter); c - SEM micrograph (SE image) of the decorated loop showing different kind of wires decorating the loop (photo D. Janová); d - detail of the coil of block twisted wire (photo E. Ottenwelter); e - detail of the joining area of the two hemispheres (photo E. Ottenwelter); f - detail of the corrugated strip (photo E. Ottenwelter); g - detail of a green cabochon in its bezel (photo E. Ottenwelter).
Obr. 4/3: *Gombík* H16-14: a - celkové pohledy na *gombík* z různých stran (foto J. Sobek); b - ozdobné ouško s načervenalou oblastí pájky mezi tordovanými drátky (foto E. Ottenwelter); c - mikrosnímek z rastrovacího elektronového mikroskopu (zobrazení SE) zdobeného závěsného oka, zachycující různé druhy filigránových drátků použitých k jeho zhotovení (snímek D. Janová); d - detail vinutí z tordovaného plochého drátu (foto E. Ottenwelter); e - detail části spoje obou hemisfér (foto E. Ottenwelter); f - detail zvlněného pásku (foto E. Ottenwelter); g - detail zelené skleněné vložky a jeho obruby (foto E. Ottenwelter).

Scanning electron microscopy and microanalyses

Electron microanalyses performed on the surface of the *gombik* have shown that ternary alloys of gold-silver-copper were used to manufacture the different metallic components of the *gombik* (Table 2). The composition of the alloy used is probably closer to the results of the analyses performed on the corrugated strip (B) (80.2 % Au, 15.2 % Ag, 4.6 % Cu) because the areas analysed were far from solder areas. This composition matches the composition of a gold “two-layered” *gombik* found in grave 505 from Mikulčice (*Kavánová 2009*, p. 133) The higher content of copper and silver detected on other components could be explain either by a real change in bulk metal used to manufacture these components, by contamination of smeared solder, or the presence of a tarnish layer containing silver and copper corrosion products distorting the results. Analyses performed on solder areas, in particular between the different wires decorating the loop as well as between the corrugated strips and the bezels, evidenced a higher percentage of copper and more than 30 % of silver.

Components forming the <i>gombik</i> H16-14	Chemical composition [Wt. %]		
	Au	Ag	Cu
Hemisphere (A ₁)	55.7	31.1	13.2
Hemisphere (A ₂)	59.9	26.5	13.6
Corrugated strip (B ₁)	61.4	30.8	7.8
Corrugated strip (B ₂)	80.2	15.2	4.6
Bezel (D ₁)	57.6	30.5	11.9
Bezel (D ₂)	51.6	30.6	17.8
Wire (E)	53.4	31.4	15.2
Wire (H)	54.3	31.4	14.3
Wire (J)	51.1	32.7	16.2
Suspension loop fitting (G)	58.1	35.2	6.7
Solder area between (D) and (B)	52.2	33.8	14
Solder area between (J) and (H)	51	35	14

Table 2: Chemical composition of the different elements composing the *gombik* H16-14.

Tab. 2: Chemické složení různých částí gombíku H16-14.

3.2. SILVER GOMBIKY WITH REPOUSSÉ AND CHASED DECORATION (TYPE 2)

A pair of identical *gombiky* of this type was found in grave H115 (H115-6 and H115-7) in which a wealthy, young woman was buried. Grave goods also included eleven grape-shaped earrings and another pair of copper gilded *gombiky* (*Frolík - Smetánka 2014*, p. 186-190).

These *gombiky* are very similar to the *gombiky* from grave H84 from a technical point of view and in terms of motifs used. The only major difference is in the material used which is in this case almost pure silver.

Description of the *gombik* H115-7 (Fig. 4/4)

The surface of the *gombik* is divided into three diamond panels, in the middle of which a bird is depicted holding a drop of blood (?) in the beak (Fig. 4/4a). A foliate ornament is filling the spaces between the panels (Fig. 4/4c). Dots are filling the space around them. A Maltese cross inside a circle is depicted on the bottom (Fig. 4/4b). The *gombik* consists of two hemispheres of 46 mm in diameter made from blank discs of metal embossed in a lead block (see *Barčáková* in this volume). The decoration was made principally by chasing but also by repoussé work. Both hemispheres were soldered together. A loop made with a wire of 1.5 mm in diameter is fixed with a clamp made of a strip of metal of 2.7 mm in width inserted into a ring made of a smooth, round-sectioned wire soldered to the upper hemisphere. The *gombik* is made out of four different kinds of components and of five components in total.

<i>Gombik</i> H115-7		Dimensions [mm]
Hemisphere	max. Ø	46
Loop	Ø	11.9
Loop's wire	Ø	1.5
Ring	Ø	5
Ring wire	Ø	1
Clamp	width	2.7
Hemisphere	thickness	0.1

Table 3: Dimensions of the *gombik* H115-7 and its components.

Tab. 3: Rozměry gombíku H115-7 a jeho částí.



Fig. 4/4: *Gombik* H115-7: a - general view of the *gombik* (photo J. Sobek); b - Maltese cross (photo E. Ottenwelter); c - tarnished foliate ornament (photo E. Ottenwelter); d - detail of the repoussé and chased decoration (photo E. Ottenwelter).

Obr. 4/4: Gombík H115-7: a - celkový pohled na gombík (foto J. Sobek); b - maltézský kříž (foto E. Ottenwelter); c - akantový ornament pokrytý vrstvou korozních produktů stříbra (foto E. Ottenwelter); d - detail dekorace zhotovené technikou repoussé a tepáním (foto E. Ottenwelter).

Condition of the artefact, quality

Both *gombiky* in this pair are in a very poor condition. Only 30 % of this *gombik* has been preserved. It was broken in many extremely brittle fragments because of severe intergranular corrosion attack.

The surface is tarnished (*Fig. 4/4c*) and fragments are almost completely mineralized. It was not possible to clean the surface to remove the tarnish on preserved fragments due to their very poor condition. *Gombiky* of this type are of high quality.

Scanning electron microscopy and microanalysis

Electron microanalysis performed on the surface of the *gombik* and on a cross-section of an available fragment of one hemisphere has shown that almost pure silver with a small amount of copper (less than 2.6 %) was used to manufacture the different components (Table 4). Analysis of the loop detected silver only.

Components forming the <i>gombik</i> H115-7	Chemical composition [Wt. %]	
	Ag	Cu
Hemisphere, cross section	97.4	2.6
Loop	100	-
Ring	98.1	1.9
Clamp	97.7	2.3

Table 4: Chemical composition of the different elements composing the *gombik* H115-7.

Tab. 4: Chemické složení jednotlivých částí gombíku H115-7.

3.3 GILDED COPPER ALLOY GOMBIKY WITH REPOUSSÉ AND CHASED WORK DECORATION (TYPE 3)

This type of *gombik* represents the most numerous group of *gombik* from the “Lumbe Garden” cemetery. They all consist of two symmetrical hemispheres (*Fig. 4/5-A₁-A₂*) made of two blank disks of copper shaped on a lead block with a doming tool (see *Barčáková* in this volume). The upper hemisphere (*Fig. 4/5-A₁*) is pierced on the top; a loop (*Fig. 4/5-D*) fixed with a clamp (*Fig. 4/5-C*) is placed through a ring (*Fig. 4/5-B*) soldered to the upper hemisphere. The hemispheres bear a decoration made by both repoussé and chasing techniques. In the repoussé technique, the sheet metal is shaped by stretching, incidentally thinning the metal outward from the reverse side. In the chasing technique the sheet metal is undercut and textured mainly by pushing the sheet back from the obverse or front side (*Untracht 1982*, p. 118). A chaser’s pitch placed inside the hemisphere was holding the metal to allow work on the exterior of the object. Remains of pitch were clearly identified on the internal side of fragments of *gombiky* H115-8 and H115-9 (*Fig. 4/9h*).

All these *gombiky* were gilded by fire-gilding. A gold amalgam was prepared by grinding together gold leaf in mercury to create a paste of Au₂Hg with an overall composition of 80 - 90 % mercury and 10 - 20 % gold. This paste was spread on the clean surface to be gilded and heated for a few minutes to about 250° - 350° C until the surface turns from gray to dull yellow as mercury volatilizes. The resulting surface is porous and dull because it has lost more than two thirds of its weight through the evaporation of mercury. It must be then burnished with an agate or steel burnishing tool to compress the porous structure and to give a smooth and reflective surface. The gilding layer is firmly bonded to the substrate by interdiffusion of copper in the plating. The amalgam paste had to be applied in combination with a corrosive agent to remove the thin copper oxide layer that was formed on the surface when exposed to air (*Anheuser 1997*, pp. 58-59).

Several subgroups can be distinguished according to the motifs depicted on the *gombik*’s surface.

3.3.1. GOMBIKY WITH GEOMETRICAL AND CROSS DECORATIONS

These *gombiky* (H104-4 and H104-1) were found in the grave of a two-and-a-half-year-old infant. They were found with two other *gombiky* and six temple rings with an eyelet, a necklace of glass

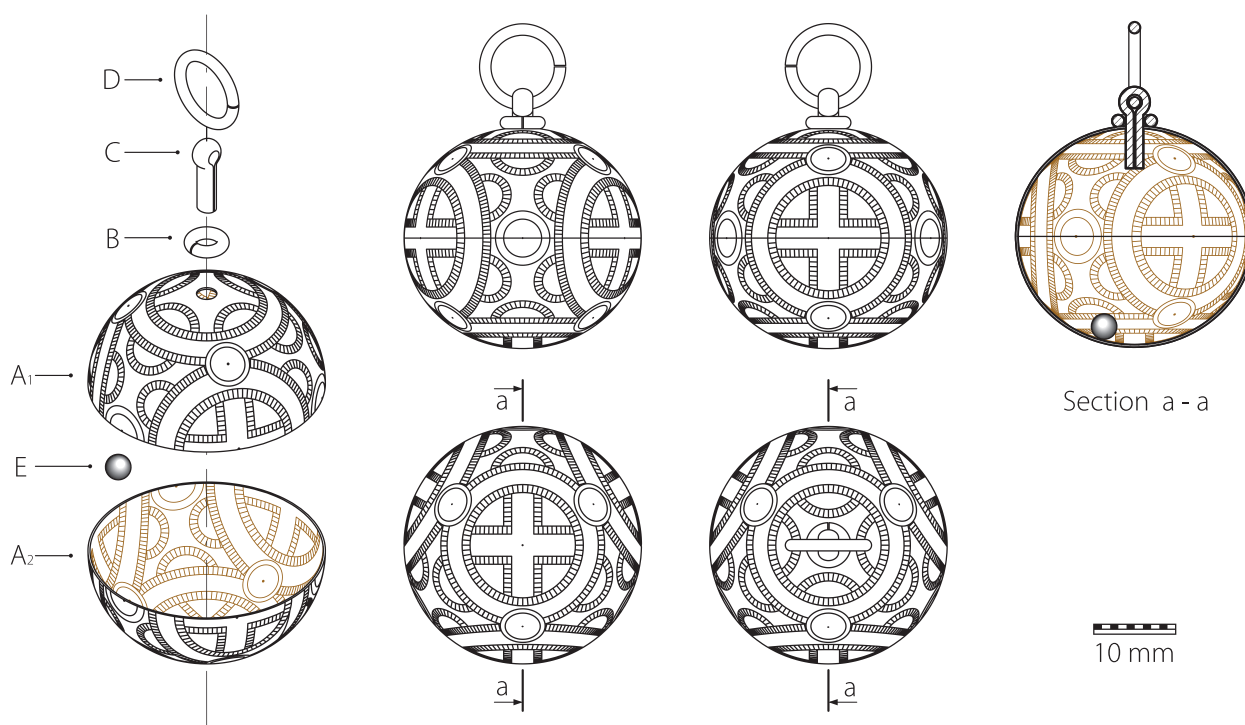

Fig. 4/5: *Gombik* H104-4: Exploded view of the different components composing the *gombik*: A₁ - upper hemisphere; A₂ - lower hemisphere; B - ring; C - clamp; D - loop; E - pellet (drawing G. Plítková).

Obr. 4/5: *Gombik* H104-4: schématické znázornění jednotlivých komponent rozložené sestavy *gombíku*: A₁ - horní hemisféra; A₂ - dolní hemisféra; B - kroužek; C - poutko; D - ouško; E - kulička (kresba G. Plítková).

beads, a knife, and a silver gilded, grape-shaped earring with rich granulation (Frolík - Smetánka 2014, p. 175-176).

Description of the *gombik* H104-4 (Fig. 4/5, 4/6)

The *gombik* is composed of two hemispheres (Fig. 4/5-A₁-A₂) of almost 30 mm in diameter joined together in which was put a small pellet (Fig. 4/5-E, 4/6d). The suspension system is formed from a loop (Fig. 4/5-D) fixed by a clamp (Fig. 4/5-C) inserted into the upper hemisphere through a small ring (Fig. 4/5-B).

The *gombik* is decorated across its entire surface (Fig. 4/6a). Five crosses in a circle (Fig. 4/6b) are placed on the body of the *gombik*: one on the top, another one on the bottom, and three of them are placed along the joining area of the two hemispheres. Each cross ornament is surrounded by four small circles. The small top and bottom circles are adjoined to neighbouring small circles and define three registers filled with a circle in the middle and six semi-circles. The craftsman used a drawing compass to outline the decoration. A depression caused by the compass is present in the center of each of the circles and crosses (Fig. 4/6c). The composition was perfectly drawn and realized. Five different types of components had to be firstly made to manufacture the *gombik*. A total of six components comprise the *gombik*.

Condition of the artefact, quality

The *gombik* H104-4 is almost complete, though a loss of material is present on the top part of the upper hemisphere (Fig. 4/6a). The bulk metal of the *gombik* is almost entirely mineralized. The gilding layer has worn away in many places where internal corrosion products were dissolved by previous chemical treatment (Fig. 4/6e). A silvery surface is visible on the area where the gilding layer has worn away (Fig. 4/6e) as if the *gombik* had initially been silver plated. *Gombiky* of this type are of excellent quality. The chased decoration is perfect.

Scanning electron microscopy and microanalysis.

Electron microanalyses were performed on the surface and on a cross-section of an available fragment of *gombik* H104-1. They have shown that pure copper was used to manufacture the hemispheres (Table 6). White particules of lead were present in the corroded matrix. The two hemispheres were

<i>Gombik H104-4</i>		Dimensions [mm]
Hemisphere (A1, A2)	Ø	29.5
Gombik	height	26
Loop (D)	Ø	11
Loop's wire	Ø	1.3
Ring (B)	Ø	5.3
Ring wire	Ø	1.4
Pellet	Ø	2.2
Clamp (C)	width	2.7
Gilding layer	thickness	8-10.4 µm

Table 5: Dimensions of the *gombik* H104-4 and its components.

Tab. 5: Rozměry gombíku H104-4 a jeho částí.

soldered (*Fig. 4/6b*) together with a hard solder containing silver (66.8 %) and copper (33.2 %) which have smeared on the surrounding areas. Observation under stereomicroscope has revealed silvery areas in the vicinity of the connecting region where the gilded layer has worn away (*Fig. 4/6e*). Surface analyses performed on these areas exhibit a higher percentage of silver. Analyses performed on silvery surfaces on the edge of the worn gilded layer evidenced an initial layer of silver. However a cross-section of a fragment of *gombik* H104-1 (*Fig. 4/6g*) showed that these *gombiky* were not originally silver plated but only gilded. The silver coating appearing locally under the worn gilded layer must be interpreted as smeared solder.

Components of the suspension system analysed on *gombik* H104-1 are made from copper alloy with a small amount of tin containing antimony for the ring and arsenic for the clamp.

The polished, unetched cross-section (*Fig. 4/6g*) of an available fragment of *gombik* H104-1 showed that the *gombik* was gilded by fire-gilding. The gilding layer contains about 2 % of silver. The gilding layer was observed in recesses where it was best preserved because it was protected by wear damage. It has a porous structure (*Fig. 4/6f*) since it has been partly burnished due to its difficult access.

3.3.2. GOMBIKY WITH WILD LILY AND FLORAL MOTIFS

Components forming the <i>gombik</i> H104-4	Chemical composition [Wt. %]										
	Au	Ag	Hg	Cu	O	Cl	Sn	Pb	As	Sb	Si
Hemisphere (A), bulk metal, point 1	-	-	-	83.8	13.9	2.3	-	-	-	-	-
Loop (D), point 2	-	-	-	84.8	11.4	-	3.8	-	-	-	-
Clamp (C) surface, H104-1, point 3	-	-	-	73.4	-	-	22.2	4.2	0.2	-	-
Ring (B), point 4	-	-	-	81.4	12.9	0.4	4	-	-	1.1	0.2
Gilding layer, cross section H104-1, point 5	84	2.3	12	1.7	-	-	-	-	-	-	-
Metallic core, cross section H104-1, point 6	-	-	-	98.9	1.1	-	-	-	-	-	-
White metallic particules in corroded core, cross section H104-1, point 7	-	-	-	4.8	-	-	-	95.2	-	-	-
Solder area between hemispheres, point 8	-	66.8	-	33.2	-	-	-	-	-	-	-

Table 6: Chemical composition of analysed points.

Tab. 6: Chemické složení analyzovaných míst

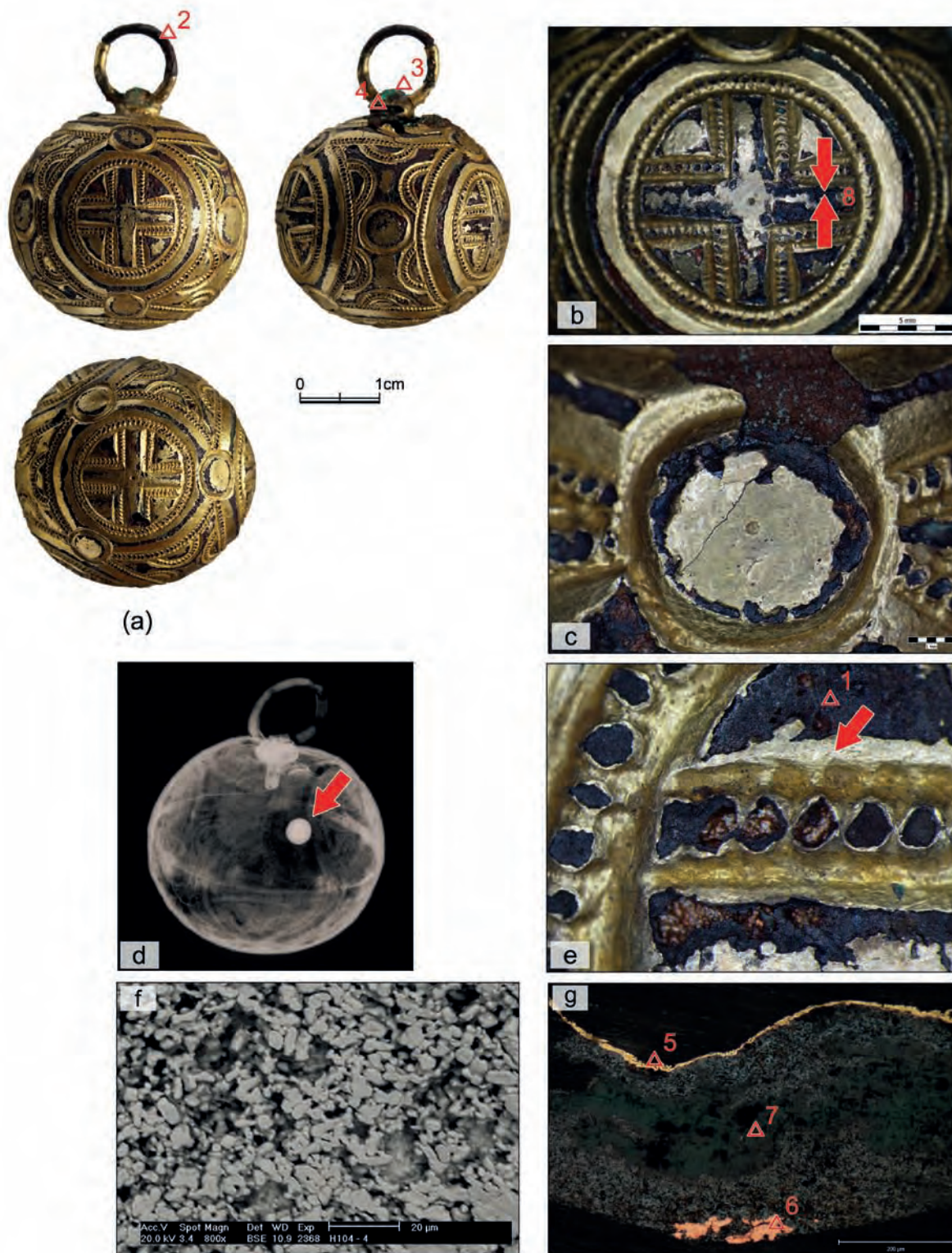

Fig. 4/6: *Gombik* H104-4: a - general view of the *gombik* (photo J. Sobek); b - solder area and cross ornament (photo E. Ottenwelter); c - drawing compass depression (photo E. Ottenwelter); d - X-radiograph of the *gombik* (D. Perlík); e - silvery area underneath the worn gilding layer (photo E. Ottenwelter); f - SEM micrograph (BSE image) of the gilding layer (photo D. Janová); g - polished cross-section of a fragment of the *gombik* H104-1 showing analysed points under optical microscopy (photo E. Ottenwelter).

Obr. 4/6: Gombík H104-4: a - celkový pohled na gombík (foto J. Sobek); b - oblast pájeného spoje hemisféry a křížový ornament (foto E. Ottenwelter); c - jamka po kružítku (foto E. Ottenwelter); d - rentgenový snímek gombíku (D. Perlík); e - stříbrná oblast pod odřenou vrstvou zlacení (foto E. Ottenwelter); f - vrstva pozlacení - mikrosnímek z rastrovacího elektronového mikroskopu (zobrazení BSE, snímek D. Janová); g - příčný metalografický výbrus fragmentu stěny pláště gombíku s vyznačenými body SEM analýzy (snímek z optického mikroskopu E. Ottenwelter).

Two identical specimens (H108-1, H108-2) of this type of *gombik* were recovered in grave H108 where a three-year-old child was buried. Grave goods also included three beads in amber, one silver temple-ring with an eyelet, a knife, and two metallic silver beads with granulation work (Frolík - Smetánka 2014, p. 180-182).

Description of the *gombik* H108-2 (Fig. 4/7)

The *gombik* consists of two identical hemispheres of 35.5 mm in diameter joined together to create a sphere. The upper hemisphere is pierced. The suspension loop system includes a ring of 10.9 mm in diameter made out of a smooth round-sectioned wire fixed with a clamp inserted in the hole of the hemisphere and fixed by a smaller ring of 6 mm in diameter soldered on the top hemisphere.

The entire *gombik* surface is decorated by chasing and repoussé work (Fig. 4/7a). Three panels delimited by inverse palmettes form a rhombus in which a wild lily with a bud between two hanging leaves-symbol of eternal life (Pekarska 2011, p. 93-95) is depicted. Alternating foliate palmettes fill the spaces between them. A three-petaled flower is depicted on the top and the bottom of the *gombik*. A cross is depicted in a medaillon on the bottom (Fig. 4/7b). Dots fill the spaces between the wild lily motifs and the flower on the top and the bottom. The *gombik* is composed of four different types of components (loop, clamp, ring, hemisphere) and a total of five components. No pellet was detected on the x-radiograph (Fig. 4/7e).

Condition of the *gombik* and quality of the work

The *gombik* is almost complete, though holes are present in several places where the bulk mineralized metal was dissolved entirely by drastic past chemical treatment (Fig. 4/7b).

The gilding layer has disappeared in many places where it obviously was displaced by corrosion products of copper dissolved by chemicals used in past restoration. The gilding layer has worn away in some regions revealing silvery tarnished areas (Fig. 4/7c). The quality of the *gombik* is very high. The chased and repoussé decoration was perfectly achieved.

<i>Gombik</i> H108-2		Dimensions [mm]
Hemisphere	Ø	35.5
Hemisphere	average thickness	0.25
Loop	Ø	10.9
Loop's wire	Ø	1.7
Ring	Ø	6
Ring wire	Ø	1.3
Clamp	width	2.6
Gilding layer	average thickness	7 µm

Table 7: Dimensions of the *gombik* H108-2 and its components.

Tab. 7: Rozměry gombíku H108-2 a jeho částí.



Fig. 4/7: *Gombík* H108-2: a - general view of the *gombík* (photo J. Sobek); b - detail of the cross on the bottom of the *gombík* (photo E. Ottenwelter); c - silvery and tarnished area under worn gilding layer (photo E. Ottenwelter); d - polished, unetched cross-section of *gombík* H108-1 under optical microscopy (photo E. Ottenwelter); e - X-radiograph of the *gombík* (D. Perlík).

Obr. 4/7: *Gombík* H108-2: a - celkový pohled na gombík (foto J. Sobek); b - detail kříže na dně gombíku (foto E. Ottenwelter); c - zašlá stříbřitá oblast pod odřenou vrstvou zlacení (foto E. Ottenwelter); d - příčný metalografický výbrus fragmentu stěny pláště gombíku H108-1 (snímek z optického mikroskopu E. Ottenwelter); e - rentgenový snímek gombíku (D. Perlík).

Components forming the <i>gombik</i> 108-2	Chemical composition [Wt. %]							
	Au	Ag	Hg	Cu	O	Sn	Pb	Cl
Gilding layer, cross section 108-1, point 1	78.6	5.2	13.7	2.5	-	-	-	-
Hemisphere, bulk corroded matrix, cross-section 108-1, area 2	-	-	-	83.8	14.4	1.8	-	-
Hemisphere, metallic red particles, cross-section 108-1, point 3	-	-	-	98.1	-	1.9	-	-
Hemisphere, white particules in corroded matrix 108-1, point 4	-	-	-	7,5	-	-	92,5	-
Loop, corroded surface, point 5	-	-	-	89.4	8.8	1.5	-	0.3
Clamp, corroded surface, point 6	-	1.4	-	95.8	-	2 8	-	-
Ring, corroded surface, point 7	-	1.4	-	89.9	6.7	2	-	-
Solder between the two hemispheres, point 8	-	81.1	-	18.9	-	-	-	-

Table 8: Chemical composition of the different elements composing the *gombik* H108-2.

Tab. 8: Chemické složení jednotlivých částí gombíku H108-2.

Scanning electron microscopy and microanalysis

Electron microanalyses performed on a polished, unetched cross-section of a fragment from a hemisphere (*gombik* H108-1), as well as surface analyses performed on the different components of the suspension system, have shown that almost pure copper with a little amount of tin (around 2 %) (Table 8) was used to manufacture the different components of the *gombik*. The *gombik* was gilded by fire-gilding. The gilding layer also contains about 5 % of silver.

Metallographic analysis (*Fig. 4/7d*) of the fragment did not reveal the presence of silver plating underneath the gold layer as expected by observation under stereomicroscope (*Fig. 4/7c*).

The two hemispheres were soldered together with a hard solder made of silver and copper (point 8). It is possible that the solder was partially smeared on the surface of the hemispheres which would explain why the hemispheres look initially silvered in some places.

3.3.3. GOMBIKY WITH FLORAL MOTIFS

A pair of this type of *gombik* was found in the grave H104 where a two-and-a-half-year-old infant was buried. Grave goods also included two other *gombiky* (H104-1 and H104-4) and six temple rings with an eyelet, a necklace of glass beads, a knife, and a silver gilded, grape-shaped earring (*Frolík - Smetánka 2014*, p. 180-182).

Description of the *gombik* H104-3

Two hemispheres of 0.2 mm in thickness form a spherical shape of 23 mm in diameter. The surface of the *gombik* is divided into three panels in which a flower with four petals is depicted (*Fig. 4/8a*). The three flowers are connected by their horizontal petals. The petals are filled with dots. The verti-

→ **Fig. 4/8:** *Gombik* H104-3: a - general view of the *gombik* (photo J. Sobek); b, d - copper corrosion products and tarnish layer on the surface (photo E. Ottenwelter); c - polished cross-section of the *gombik* under optical microscopy (photo E. Ottenwelter); e - SEM micrograph (BSE image) of the same area as in *Fig. 4/8c* from the polished cross-section with analysed points and areas (photo D. Janová); f - detail of the solder between the two hemispheres (photo E. Ottenwelter); g - polished cross-section with preserved analysed islands of metal (photo E. Ottenwelter); h - analysed solder between the two hemispheres, SEM micrograph (BSE image - photo D. Janová).

→ **Obr. 4/8:** Gombík H104-3: a - celkové pohledy na gombík z různých stran (foto J. Sobek); b, d - korozní produkty mědi a vrstva korozních produktů stříbra na povrchu zlacení (foto E. Ottenwelter); c - příčný metalografický výbrus fragmentu stěny pláště gombíku (snímek z optického mikroskopu E. Ottenwelter); e - mikrosnímek z rastrovacího elektronového mikroskopu (zobrazení BSE) stejné oblasti jako u Obr. 4/8c s vyznačením míst bodové a plošné mikroanalýzy (snímek D. Janová); f - detail pájky spoje obou hemisfér (foto E. Ottenwelter); g - příčný metalografický výbrus fragmentu stěny pláště gombíku s ostrůvky zachovaného kovu s vyznačeným místem SEM bodové analýzy (snímek z optického mikroskopu E. Ottenwelter); h - mikrosnímek z rastrovacího elektronového mikroskopu (zobrazení BSE) s vyznačením místa bodové analýzy pájky, spojující obě hemisféry (snímek D. Janová).

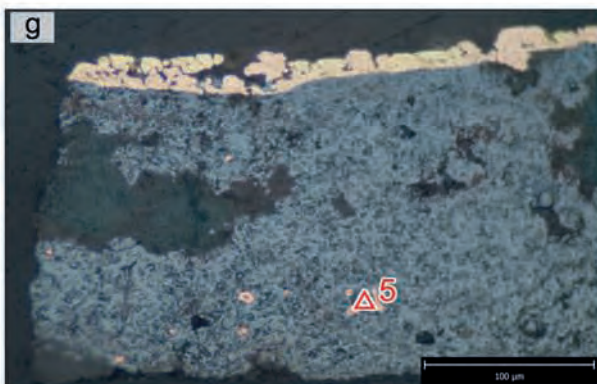
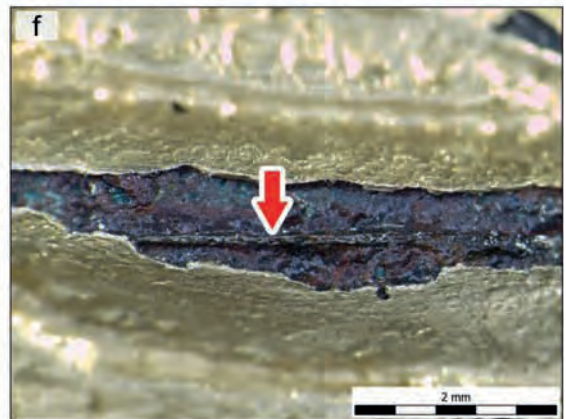
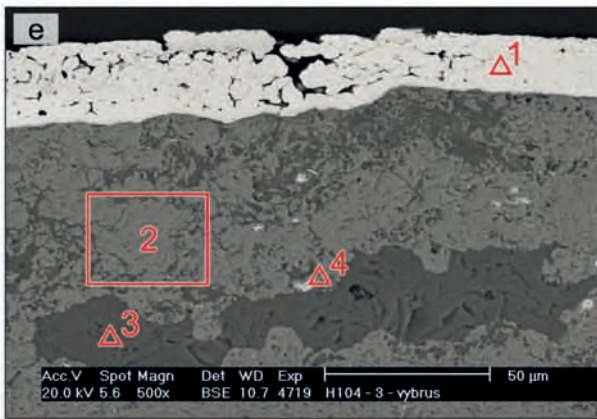
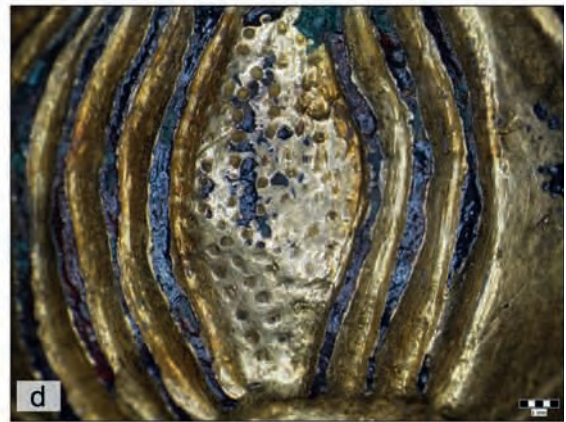
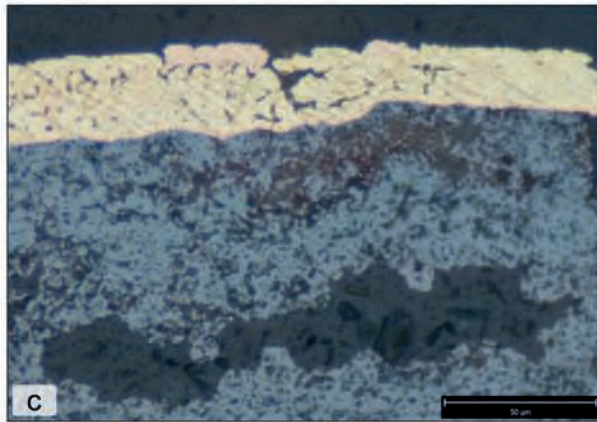
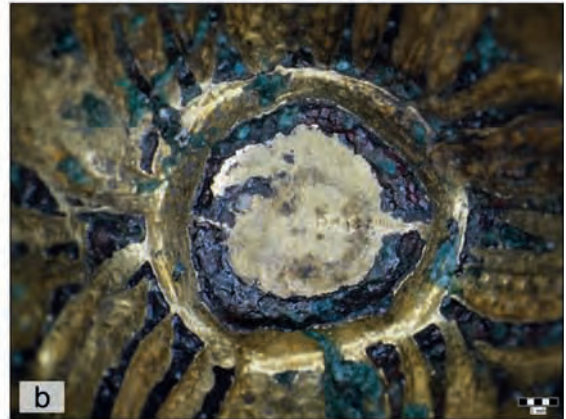

cal petals create a flower with three petals on the top and on the bottom of the *gombik*. The system of suspension is identical to other *gombiky* of this group. It is composed of a loop (not entirely preserved) fixed by a clamp inserted in a ring soldered around a hole on the top hemisphere. The *gombik* is composed of four different kinds of components and a total of five components.

<i>Gombik</i> H104-3		Dimensions [mm]
Hemisphere	Ø	23
Loop's wire	Ø	1.1
Ring	Ø	3.4
Ring's wire	Ø	0.7
Clamp	Ø	0.7
Hemisphere	thickness	0.2
Gilding layer	thickness	19-28.8 µm

Table 9: Dimensions of the *gombik* H104-3 and its components.

Tab. 9: Rozměry gombíku H104-3 a jeho částí

Condition of the *gombik* and quality of work

Gombik H104-4 is not complete (*Fig. 4/8a*). The loop is missing as well as the bottom of the lower hemisphere. Regions of the surface were covered by copper corrosion products and a tarnishing layer composed of silver and copper sulphides (*Fig. 4/8b, d*). The chased decoration is rather clumsy.

Scanning electron microscopy and microanalysis

Electron microanalysis performed on the cross-section (*Fig. 4/8e*) of a fragment from one hemisphere showed that a copper alloy particules containing lead and antimony was used to manufacture the hemisphere (Table 10). Analyses performed on corroded part (point 2 and 3), which represented the majority of the surface, detected only copper while analyses performed on the very rare metallic particules still preserved in the corroded matrix (*Fig. 4/8g, point 5*) revealed the presence of copper alloy with lead and antimony. White particules present in the corroded matrix (point 4) contained 50.9 % of lead, 27.4 % of antimony and 6.9 % of copper.

A hard solder containing silver and copper was used to join the two hemispheres together (*Fig. 8f, h*).

Components forming the <i>gombik</i> H104-3	Chemical composition [Wt. %]									
	Au	Ag	Hg	Cu	Pb	Sn	Sb	O	Cl	S
Gilding layer, cross section, point 1	75.2	2.3	20.8	1.7	-	-	-	-	-	-
Hemisphere, bulk corroded metal, cross section, area 2	-	-	-	81.9	-	-	-	17.1	-	1
Hemisphere, bulk corroded metal, cross section, point 3	-	-	-	54	-	-	-	39.4	-	6.6
Hemisphere, bulk corroded metal, cross section, white particles, point 4	-	-	-	6.9	50.9	-	27.4	14.8	-	-
Hemisphere, metallic islands, cross section, point 5	-	-	-	80.3	11.1	-	7	-	1.6	-
Clamp, point 6	-	-	-	96.1	-	3.1	-	-	0.3	0.5
Solder area between the hemispheres, point 7	3.5	89.3	-	7.2	-	-	-	-	-	-

Table 10: Chemical composition of the different elements composing the *gombik* H104-3.

Tab. 10: Chemické složení jednotlivých částí gombíku H104-3.

After the two decorated halves were joined together, the *gombik* was gilded by fire-gilding. A little bit of silver (2.3 %) was detected in the gilding layer. The detected copper content in the gilded layer can be explained by the interdiffusion of the bulk metal in the gilded layer. The gilding layer is two to three times thicker (19.2 to 28.8 μm) in comparison with other *gombiky*.

Analyses of all the different components of the suspension system were not possible because the loop was missing and because the ring around the clamp was completely covered by the gilding layer. However, it was possible to analyse the clamp which turned out to be a copper alloy with a small amount of tin (3.1 %).

3.3.4. GOMBIKY WITH ROSETTES, INTERLACED AND ARM MOTIFS DECORATION

Two specimens of these *gombiky* were recovered from grave H115 in which a teenage girl was buried. Grave goods also included two silver *gombiky*, eleven silver, grape-shaped earrings with rich granulation work, and two knives (Frolík - Smetánka 2014, p. 186-190).

Description of the *gombik* H115-8

The *gombik* has a spherical shape of approximately 30 mm in diameter. It consists of two hemispheres joined together. The upper hemisphere is pierced to allow the suspension system to be inserted. A loop of 10.3 mm in diameter is fixed with a clamp of 1.9 mm in width. The clamp is inserted through the top hemisphere and fixed by a ring of 5.9 mm in diameter. No pellet is present inside the *gombik*.

The entire *gombik* surface is decorated (Fig. 4/9a) by chasing and repoussé work. Three panels are defined by interlaced motifs. In the middle of each panel an eightfold rosette is depicted (Fig. 4/9b) surrounded by a crown with chevron motifs. A triangle is depicted on the bottom in which is a flower with three petals. An arm (Fig. 4/9f) is depicted along the three sides of the triangle. The *gombik* was made from four different kinds of components and a total of five components.

Condition of the *gombik* and quality of the work

Both *gombiky* in the pair are in very poor condition. They are incomplete, *gombik* H115-8 being in the best condition with about 50 % of the original *gombik* preserved. It was broken in many extremely brittle, completely mineralized fragments. The surface was covered by silver chlorides and copper corrosion products (Fig. 4/9b, d, f). No attempt to clean the surface was done because the fragments were too fragile. Therefore analyses concerning the hemispheres were conducted on a polished, unetched cross-section of available fragments from *gombik* H115-8 and H115-9 (Fig. 4/9c, e, g). Remains of pitch used while chasing the decoration to avoid deformation of the thin hemispheres are still present inside the fragments (Fig. 4/9h).

The quality of the chasing and repoussé work is exceptional.

<i>Gombik</i> H115-8		Dimensions [mm]
Hemisphere	\emptyset	30
Hemisphere	thickness	0.2
Loop	\emptyset	10.3
Loop's wire	\emptyset	1.5
Ring	\emptyset	5.9
Ring wire	\emptyset	1.3
Clamp	width	1.9
Gilding layer	average thickness	7.5 μm

Table 11: Dimensions of the *gombik* H115-8 and its components.

Tab. 11: Rozměry gombíku H115-8 a jeho částí.

Components forming the <i>gombik</i> H115-8	Chemical composition [Wt. %]						
	Au	Ag	Hg	Cu	O	Sn	Cl
Gilding layer, cross section, point 1	80.5	3.3	12.7	3.5	-	-	-
Hemisphere, bulk corroded matrix, cross section, area 2	-	-	-	62.1	21.4	6.7	9.8
Hemisphere, metallic islands, matrix, cross section, area 3	-	-	-	74.2	15	10	0.7
Silver plating internal side, cross section, point 4	-	87	-	13	-	-	-
Solder between the two hemispheres (cross section H115-9), area 5	-	57.5	-	42.5	-	-	-
Hemisphere, metallic particules in corroded matrix, cross section H115-9	-	-	-	97	-	3	-
Loop, corroded surface, point 6	-	-	-	85.4	11.6	3	-
Clamp, corroded surface, point 7	-	-	-	96	4	-	-
Ring, corroded surface, point 8	-	-	-	88	8.4	3.6	-

Table 12: Chemical composition of the different elements composing the *gombik* H115-8.

Tab. 12: Chemické složení různých částí gombíku H115-8.

Scanning electron microscopy and microanalysis

Electron microanalysis performed on the surface of the different elements of the suspension system detected the presence of a small amount of tin in the loop and the ring (Table 12). Tin was also detected in the corroded and partly mineralized matrix from a fragment of the hemisphere (*Fig. 4/9e*) at levels of up to 10 % (areas 2, 3). The high content of tin detected is probably the result of the corrosion process and phenomena of enrichment of tin on the surface and in corrosion products. Analyses performed on a metallic particule preserved in the corroded matrix of a fragment of *gombik* H115-9 detected tin at a level of 3 % which is closer to the tin content detected on the elements of the suspension system. This was probably also closer to the composition of the material used to manufacture the hemisphere, keeping in mind that pure copper is easier to work by cold working than bronze, and therefore a more appropriate material to manufacture *gombiky*. Solder area analysed on a fragment from *gombik* H115-9 (*Fig. 4/9g*) evidenced the use of a binary Ag-Cu hard solder to join the two hemispheres together. The solder has smeared on the internal side (point 4) (*Fig. 4/9e*). The *gombik* was gilded by fire-gilding (*Fig. 4/9c, e*). The gilding layer contains a small amount of silver (point 1).

→ **Fig. 4/9:** *Gombik* H115-8: a - general view of the *gombik* (photo J. Sobek); b - eightfold rosette ornament (photo E. Ottenwelter); c - detail of the gilding layer from a polished cross-section under optical microscopy (photo E. Ottenwelter); d - interlaced motifs (photo E. Ottenwelter); e - polished cross-section of a fragment from *gombik* H115-8 with analysed points and areas (photo E. Ottenwelter); f - detail of the arm motif (photo E. Ottenwelter); g - cross-section of a fragment of *gombik* H115-9 showing the solder under the gilding layer, SEM micrograph (BSE image, photo D. Janová); h - remains of pitch on the internal wall of the *gombik* (photo E. Ottenwelter).
→ **Obr. 4/9:** Gombík H115-8: a - celkový pohled na gombík (foto J. Sobek); b - ornament osmilistě růžice (foto E. Ottenwelter); c - detail vrstvy zlacení na příčném metalografickém výbrusu fragmentu stěny pláště gombíku (snímek z optického mikroskopu E. Ottenwelter); d - dekorační pletencový motiv (foto E. Ottenwelter); e - příčný metalografický výbrus fragmentu stěny pláště gombíku s vyznačenými místy bodové a plošné SEM analýzy (snímek z optického mikroskopu E. Ottenwelter); f - detail motivu ruky (foto E. Ottenwelter); g - příčný výbrus fragmentu stěny pláště gombíku H115-9 - na mikrosnímku z rastrovacího elektronového mikroskopu (zobrazení BSE) je dokumentována vrstva pájky pod zlacením (snímek D. Janová); h - zbytky pryskyřice na vnitřní straně *gombíku* (foto E. Ottenwelter).

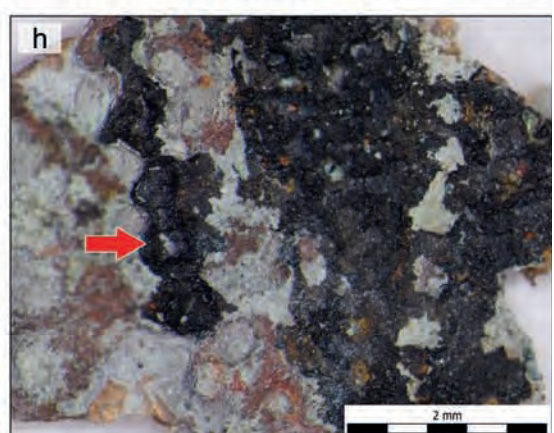
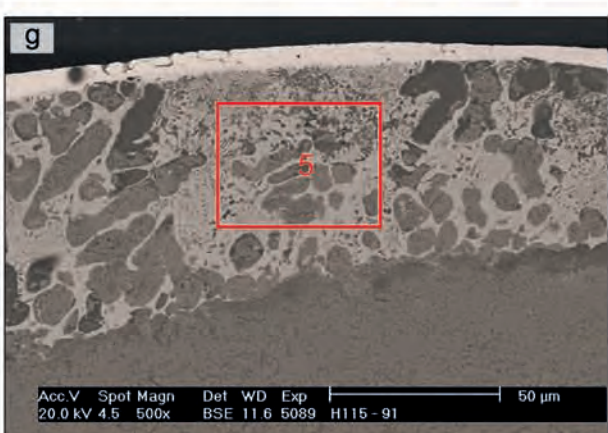
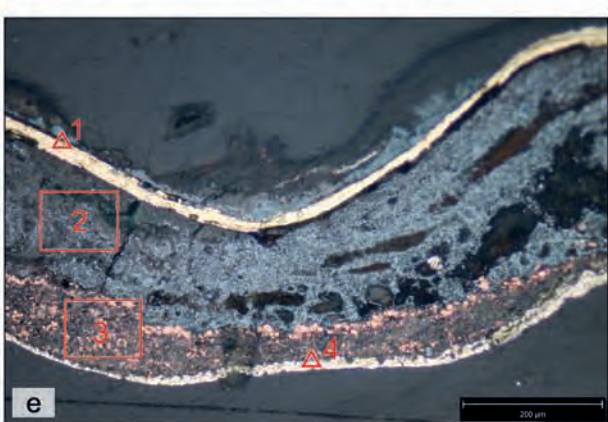
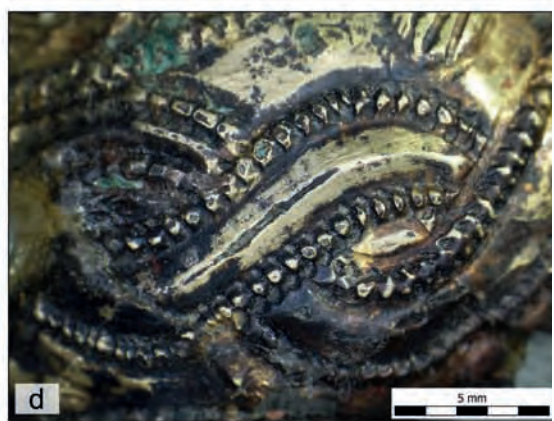
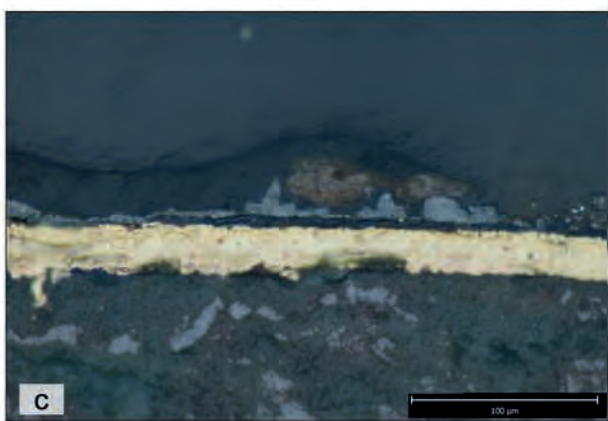
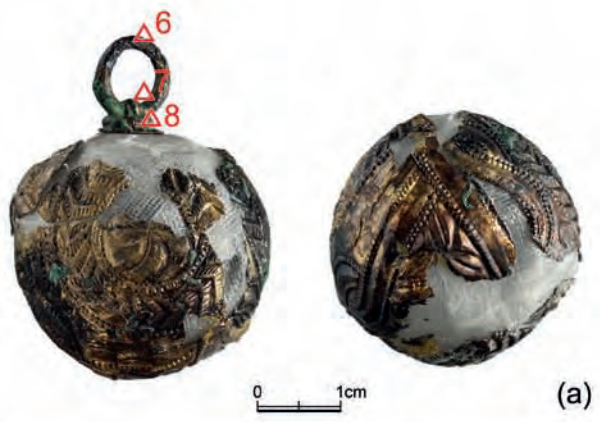

3.3.5. GOMBIKY WITH FOLIATE, BIRD AND CROSS ORNAMENT

These *gombiky* form an identical pair and were recovered from the child grave H84. Grave goods also included five silver, grape-shaped earrings, two S-shaped temple rings, a knife, a copper alloy ring, and a necklace of semi-precious stone and glass beads (Frolík - Smetánka 2014, p. 152-156).

Description of the *gombik* H84-1

The *gombik* surface is divided into three diamond panels in the middle of which a bird is depicted holding a cloth in its beak or having a droop of blood falling from it (Fig. 4/10 a, c). A foliate ornament fills the spaces between the panels. A cross in a circle decorated with chevrons (Fig. 4/10e) is depicted on the bottom. A circle with chevron decorations is also depicted around the suspension loop fitting. The size and the motif depicted on the surface of the *gombik* is very similar to the *gombiky* from grave H115. It is constructed from two hemispheres of 44 mm of diameter and 0.2 mm of thickness. The suspension system is similar to previous *gombiky*. A pellet is present inside the *gombik* (Fig. 4/10b). The *gombik* is composed of five different kinds of components and a total of six components.

<i>Gombik</i> H84-1		Dimensions [mm]
Hemisphere	max. Ø	44
Loop	Ø	11.6
Loop's wire	Ø	2
Ring	Ø	6.7
Ring wire	Ø	1.2
Clamp	width	2.9
Hemisphere	thickness	0.2
Gilding layer	thickness	8.3-11 µm

Table 13: Dimensions of the *gombik* H84-1 and its components.

Tab. 13: Rozměry gombíku H84-1 a jeho částí.

Condition of the *gombik* and quality of the work

The condition of both *gombiky* in the pair is rather poor. *Gombik* H84-2 is the best preserved of the two. It is almost complete, although it has broken into many fragments. *Gombik* H84-1 is only 75 % preserved. The upper hemisphere is incomplete. Both of them are almost completely mineralized. Though, islands of preserved metallic copper were present on observed cross-sections (Fig. 4/10d, g, f). The gilding layer is preserved mainly in recesses and is covered by copper corrosion products. The quality of work of this kind of *gombik* is very good.

Scanning electron microscopy and microanalysis

Electron microanalysis was performed on a polished, unetched cross-section of a fragment from one hemisphere (Fig. 4/10d, f) as well as on the surface of the different components of the suspension system. The solder area on the surface of the *gombik* between the two hemispheres (Fig. 4/10g) was analysed. Analyses performed on the islands of metallic core (Fig. 4/10f, point 3) have shown that pure copper was used to manufacture the hemispheres. Lead was detected in all the components of the suspension loop fitting, showing that another material was used to manufacture these components. It is impossible to state the exact content of lead present in the alloy originally because analyses were made on a corroded surface. Analyses performed on a preserved area of the loop of the *gombik* H84-2 where metallic core was visible detected a lead content of 2 %.

The *gombik* was gilded by fire-gilding (point 1) (Table 14). The gilded layer is between 8.3 and 11 µm thick. Diffusion of copper from the bulk metal into the gilding layer is visible on the cross-section (Fig. 4/10d). The gilding layer appears to be quite porous due to probable incomplete burnishing (Fig. 4/10d). No silver was detected in the gilding layer, contrary to previous gilded *gombiky* mentioned above. In this case, silver was not present in the gilding layer.

The solder used (Fig. 4/10g) is very close to the eutectic mixture of silver and copper (Ag 71.9 %, 28.1 % Cu) having a melting point of 779°C, which, being a much lower melting point than pure copper (1084°C) (Scott 2012, p. 38-39), allowed safe soldering of the two pure copper hemispheres.

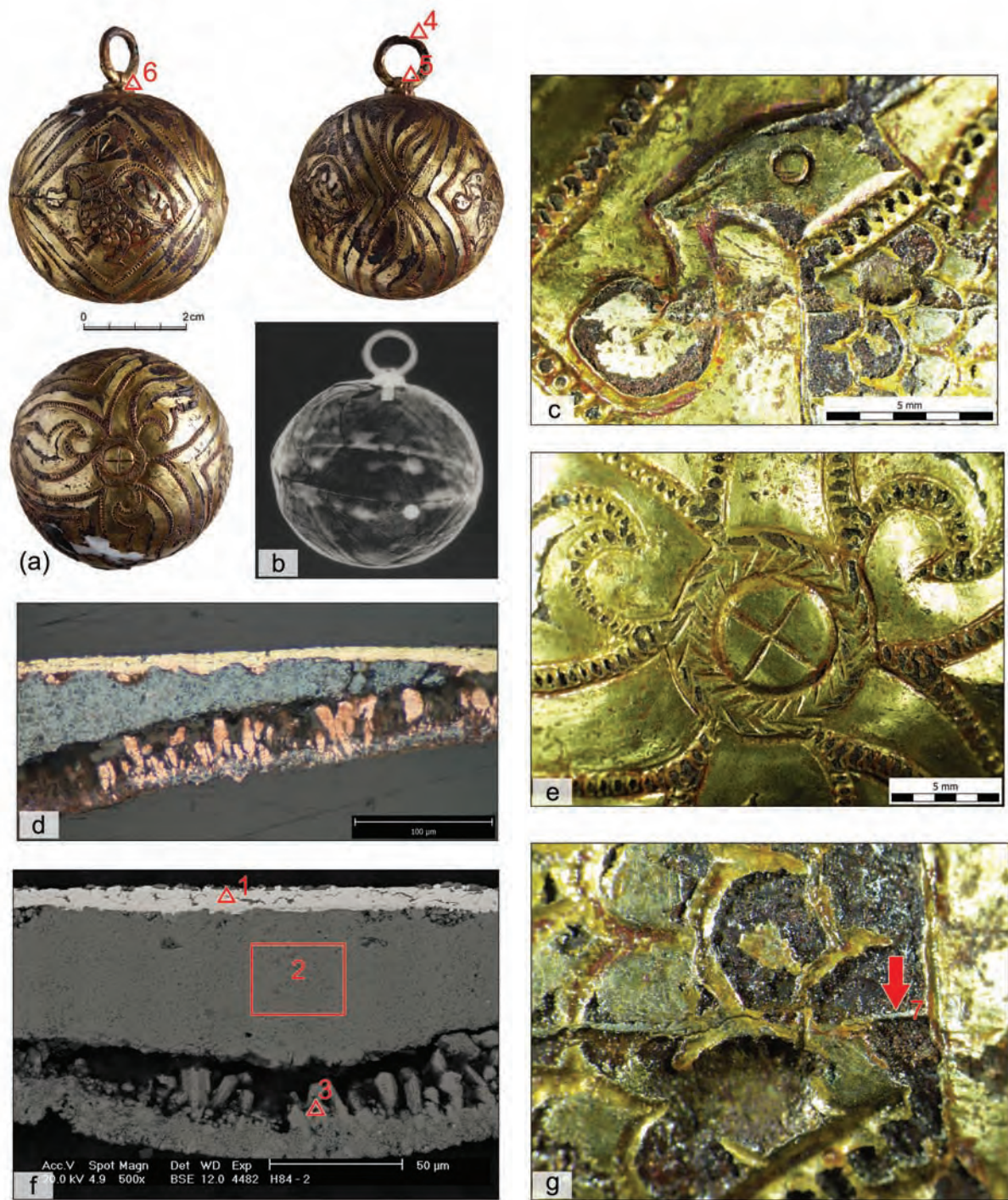

Fig. 4/10: Gombík H84-1: a - general view of the gombík (photo J. Sobek); b - X-radiograph of the gombík (I.Nacherová); c - detail of the bird holding a necklace/?/ or drop of blood/?/ (photo E. Ottenwelter); d - polished, unetched cross-section under optical microscopy (photo E. Ottenwelter); e - detail of the cross motif inside a chevron crown (photo E. Ottenwelter); f - polished, unetched cross-section of a fragment from the gombík with analysed points and areas SEM micrograph (BSE image, photo D. Janová); g - analysed solder between the two hemispheres (photo E. Ottenwelter).

Obr. 4/10: Gombík H84-1: a - celkový pohled na gombík (foto J. Sobek); b - rentgenový snímek gombíku (I.Nacherová); c - detail ptáčka s náhrdelníkem /?/ nebo kapkou krve /?/ v zobáčku (foto E. Ottenwelter); d - nenaleptaný příčný metalografický výbrus fragmentu stěny pláště gombíku (snímek z optického mikroskopu E.Ottenwelter); e - detail motivu kříže uvnitř ševronového věnce (foto E. Ottenwelter); f - mikrosnímek příčného výbrusu fragmentu stěny pláště gombíku z rastrovacího elektronového mikroskopu (zobrazení BSE) s vyznačením míst bodové a plošné EDS analýzy (snímek D. Janová); g - analyzovaná pájka mezi dvěma hemisférami (foto E. Ottenwelter).

Components forming the <i>gombik</i> H84-1	Chemical composition [Wt. %]					
	Au	Ag	Cu	Pb	Hg	O
Gilding layer, cross-section, point 1 (H84-2)	80	-	3.4	-	16.6	-
Hemisphere, cross section, point 2 (H84-2)	-	-	86.9	-	-	13.1
Hemisphere, cross section, point 3 (H84-2)	-	-	97.2	-	-	2.8
Loop, point 4	-	-	86.1	2.9	-	11
Clamp, point 5	-	-	86.5	2	-	11.5
Ring, point 6	-	-	86.4	3.1	-	10.5
Solder area between the two hemispheres, point 7	-	70.9	29.1	-	-	-

Table 14: Chemical composition of the different elements composing the *gombik* H84-1.

Tab. 14: Chemické složení jednotlivých částí gombíku H84-1.

3.3.6. GOMBIKY WITH FLORAL MOTIFS

This group represents two identical *gombiky*. They were found in grave H99 where a three-year-old child was buried. The grave goods also included five silver temple rings, two copper alloy temple rings, a knife, and one semi-precious bead (Frolík - Smetánka 2014, p. 165-167).

Description of *gombik* H99-5

The *gombik* consists of two slightly flattened hemispheres soldered together to form an oval shape. Its surface is divided into three panels defined by three arcades forming a triangle on the bottom (Fig. 4/11a). A floral motif is depicted in the middle of each panel.

The suspension loop system is formed only by a strip of metal forming a loop with long legs inserted into a hole pierced through the middle of the upper hemisphere and fixed mechanically by a ring of smooth circular-section wire. No pellet was detected on the X-radiograph.

It is a small *gombik* with a diameter of 27.3 mm. On the whole, three different kinds of components were used to manufacture the *gombik* (hemisphere, loop, ring) while four components in total were used.

→ **Fig. 4/11:** *Gombik* H99-5: a - general view of the *gombik* (photo J. Sobek); b - tarnished and underlying silvery areas (photo E. Ottenwelter); c - polished, unetched cross-section of a fragment with solder, SEM micrograph (BSE image, photo D. Janová); d - detail of the polished, unetched cross-section showing the soldered area and remains of metallic islands in the corroded matrix (photo E. Ottenwelter); e - detail of the analysed gilding layer and solder area, SEM micrograph (BSE image - photo D. Janová); f - same area under optical microscopy (photo E. Ottenwelter); g - analysed metallic particles in the matrix, SEM micrograph (BSE image, photo D. Janová); h - analysed gilding layer and spread solder on the polished, unetched cross-section, SEM micrograph (BSE image, photo D. Janová).

→ **Obr. 4/11:** Gombík H99-5: a - celkový pohled na gombík (foto J. Sobek); b - c - zašlé a stříbřité podložní oblasti (foto E. Ottenwelter); c - mikrosnímek nenaleptaného příčného výbrusu fragmentu stěny pláště gombíku s pájkou z rastrovacího elektronového mikroskopu (zobrazení BSE, snímek D. Janová); d - nenaleptaný příčný metalografický výbrus fragmentu stěny pláště gombíku, dokumentující oblast pájky a zbylé ostrůvky kovu ve zkorodované matici (snímek z optického mikroskopu E. Ottenwelter); e - detail analyzované zlaté vrstvy a oblasti pájky, mikrosnímek z rastrovacího elektronového mikroskopu (zobrazení BSE - snímek D. Janová); f - stejná oblast na snímku z optického mikroskopu (snímek E. Ottenwelter); g - analyzované částice kovu ve zkorodované matici, mikrosnímek z rastrovacího elektronového mikroskopu (zobrazení BSE, snímek D. Janová); h - mikrosnímek detailu příčného výbrusu fragmentu stěny pláště gombíku s vyznačením míst bodové EDS analýzy vrstvy zlacení a pájky (elektronový mikroskop, zobrazení BSE, snímek D. Janová).

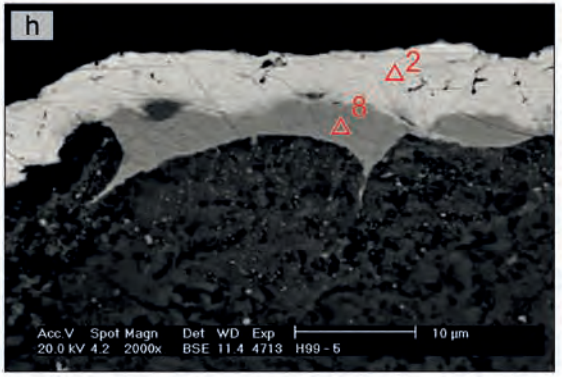
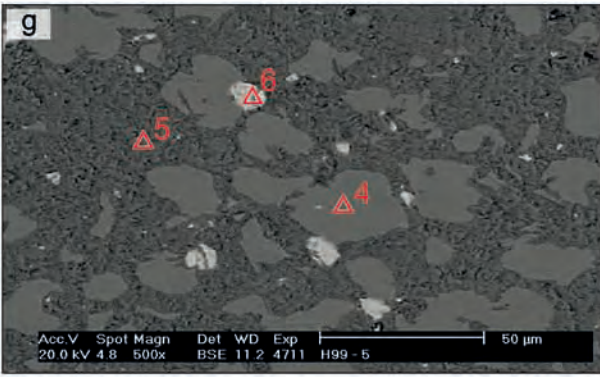
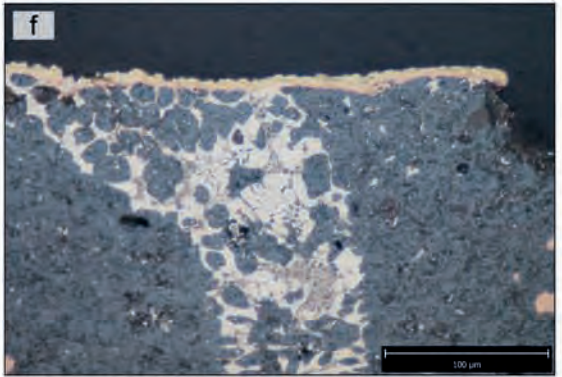
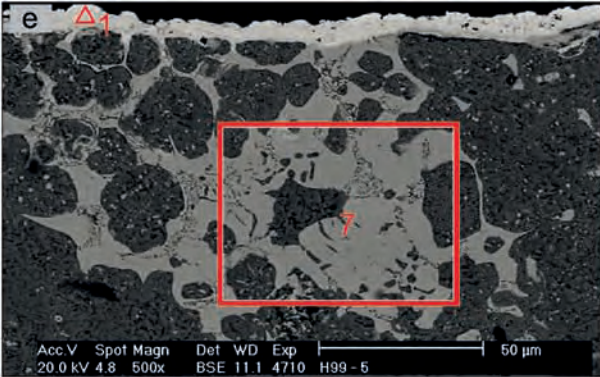
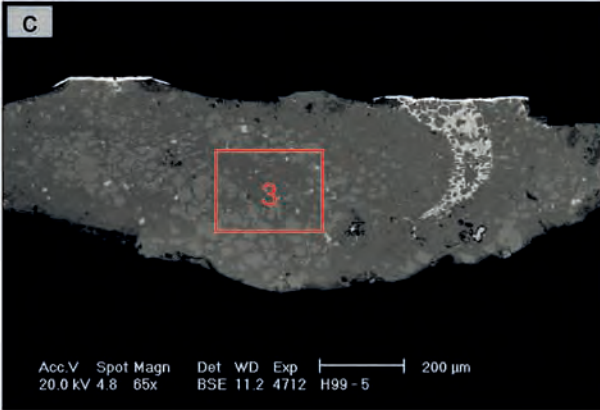
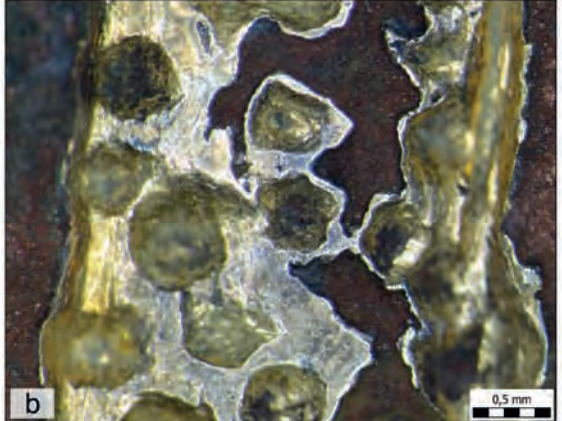

<i>Gombik</i> H99-5		Dimensions [mm]
Hemisphere	Ø	27.3
Hemisphere	height	23.4
Hemisphere	thickness	0.4
Loop	Ø	nd.
Strip forming the loop	width	2.2
Ring	Ø	4.5
Ring wire	Ø	1.5
Gilding layer	thickness	7-10 µm

Table 15: Dimensions of the *gombik* H99-5 and its components.

Tab. 15: Rozměry gombíku H99-5 a jeho částí.

Condition of the *gombik* and quality of the work

The *gombik* is almost complete but the suspension loop is missing. A loss of material is also present on the joining area. The bulk metal is in an advanced state of mineralization (*Fig. 4/11c, d*). The plating of the *gombik* has worn away in many places but it is well preserved in recesses. The limit of the original surface is lost where the gilding layer is missing.

The gilded layer is tarnished by silver and copper sulphides (*Fig. 4/11b*). The solder has smeared on the surrounding areas revealing a coating of silver underneath the gilding layer (*Fig. 4/11h*). It is an average quality work.

Scanning electron microscopy and microanalysis

Electron microanalysis was performed on a fragment from the soldered hemispheres embedded in resin and polished (*Fig. 4/11c, h*) as well as on the surface of the *gombik*. The bulk metal is in an advanced state of mineralization. Analyses (area 3) performed on the polished, unetched cross-section of a fragment of the hemisphere (*Fig. 4/11c*) revealed the presence of a copper alloy mixed with corrosion products containing tin and lead (Table 16). Two types of particles were present in the matrix (*Fig. 4/11g*). The red particles (point 4) are copper with 3.2 % of tin whereas the white one (point 6) were identified as lead with a small amount of copper. The solder used to join the two hemispheres together and observed on a cross-section (*Fig. 4/11d, f*) is a hard solder of silver (49.2 %) and copper (50.8 %). The *gombik* was gilded by fire-gilding (point 1). The gilding layer contains about 6 % of silver. Analyses in the middle of the gilding layer evidenced a higher content of mercury than on the surface. The solder has smeared on several areas on the surface and is found under the gilding layer in several places (*Fig. 4/11h*). The preserved plating has a thickness of 7 to 10µm.

Components forming the <i>gombik</i> H99-5	Chemical composition [Wt. %]						
	Au	Ag	Hg	Cu	Sn	Pb	O
Gilding layer, cross section, point 1	65	10.3	20.7	4	-	-	-
Gilding layer, cross section, point 2	67.4	6.5	23.2	2.9	-	-	-
Gilding layer surface analysis	74.9	8.4	13.8	2.9	-	-	-
Hemisphere corroded matrix, cross section, area 3	-	-	-	84	4.9	2.8	8.3
Hemisphere, red metallic islands in corroded matrix, cross section, point 4	-	-	-	96.8	3.2	-	-
Hemisphere, corroded matrix, point 5	-	-	-	89	-	-	11
Hemisphere, white metallic islands in corroded matrix, cross section, point 6	-	-	-	6.8	-	75.7	17.5
Solder area, cross section, area 7	-	72.7	-	22	-	5.3	-
Smeared solder under gilding, cross section, point 8	-	88.2	-	11.8	-	-	-
Solder between hemisphere, surface, point 9	-	49.2	-	50.8	-	-	-

Table 16: Chemical composition of the different elements composing the *gombik* H99-5.

Tab. 16: Chemické složení jednotlivých částí gombíku H99-5.

3.4. GILDED COPPER ALLOY GOMBIKY WITH OCTOLOBED SHELLS AND GLASS CABOCHONS (TYPE 4)

This type of *gombik* was found in grave H74B where a two-year-old child was buried. The grave goods also included a glass *gombik*, a small axe, a knife, and one jingle bell (Frolík - Smetánka 2014, p. 133-134). There was actually a pair of similar *gombiky* in the grave, except that the second *gombik* 74B-1 does not have a glass cabochon sitting inside a filigree ring on the bottom as does *gombik* 74B-2.

Description of the *gombik* H74B-2 (Fig. 4/12)

The *gombik* has a pumpkin shape of 14.5 mm in diameter and a total height of 18.8 mm. It is composed of two octolobed shells soldered together (Fig. 4/12-A₁-A₂). The top shell is perforated (Fig. 4/12-A₂). A suspension loop fitting (Fig. 4/12-D) forming a loop with two straight ends and made of a wire of 1.5 mm in diameter is inserted into an opening at the top of the upper hemisphere. A ring (Fig. 4/12-C₂) made with two round-sectioned twisted wires of 0.5 mm in diameter decorates and maintains the suspension loop in the hemisphere. The *gombik* is decorated on its base by a similar ring (Fig. 4/12-C₁) made of two round-sectioned twisted wires surrounding a bezel (Fig. 4/12B) in which a blue, glass cabochon (Fig. 4/12E) of 3.3 mm in diameter is inserted. The *gombik* is made of six different kinds of components and has seven components in total. It does not contain any pellet (Fig. 4/13b).

Condition of the *gombik* and quality of the work

The *gombik* is complete but is in a rather poor condition (Fig. 4/13a). Past chemical treatment using complexing agent (Chelaton®) has dissolved all corrosion products including internal corrosion products leading to the loss of the gilding layer, in particular on the top of the lobes (Fig. 4/13c, e). The *gombik* is in advanced state of mineralization. The two shells of the *gombik* are not sitting well together (Fig. 4/13a).

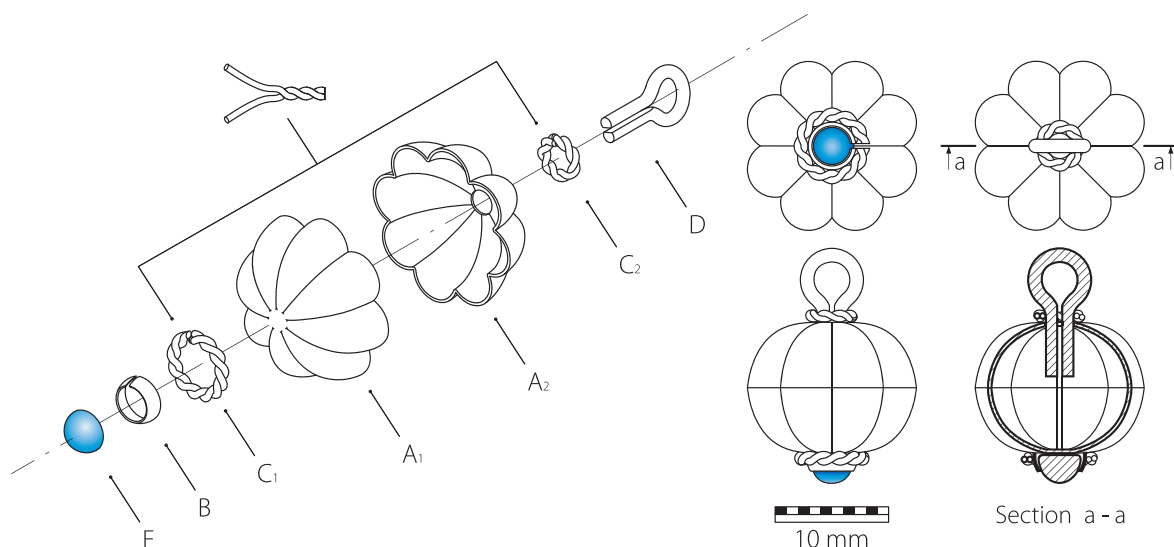

Fig. 4/12: *Gombik* H74B-2: exploded view showing the different components composing the *gombik*: A₁ - lower octolobed shell; A₂ - upper octolobed shell; B - bezel; C₁ - lower ring of twisted wire; C₂ - upper ring of twisted wire; D - loop; E - glass cabochon (drawing G. Plítková).

Obr. 4/12: *Gombik* H74B-2: schématické znázornění jednotlivých částí rozloženého *gombíku*: A₁ - osmilaločná spodní část pláště; A₂ - osmilaločná horní část pláště; B - obruba skleněné vložky; C₁ - spodní kroužek z tor-dovaného drátu; C₂ - horní kroužek z tor-dovaného drátu; D - ouško; E - skleněná vložka (kresba G. Plítková).

Scanning electron microscopy and microanalysis

Electron microanalysis performed on the surface of the different components of the *gombik* showed that almost pure copper was used to manufacture the hemispheres (Table 18). A higher content of tin was found by surface analyses performed on the bezel and the twisted ring, but these areas being corroded, it is very probable that the higher content of tin observed is due to the enrichment of tin of the surface and do not correspond to a higher concentration of tin in the alloy used. The bulk metal used to manufacture the different components of the *gombik* was certainly almost pure copper. Nevertheless, a difference has to be noted for the alloy used for the bezel, as arsenic was detected. The *gombik* was gilded by fire-gilding. Mercury was detected. Silver is also present according to analyses performed on the gilding layer. The silver content measured on the gilding layer is higher on surface areas where tarnishing was observed under stereomicroscope (Fig. 4/13c). Silver may have been part of the amalgam used to gild the *gombik*, or the object may have been initially silvered and then gilded. No fragment was available for a metallographic analysis to check this hypothesis. The solder used to join the two shells together (Fig. 4/13 d, f, g) is a hard solder of silver and copper alloy (82.8 % Ag, 17.2 % Cu).

Components forming the <i>gombik</i> H74B-2	Chemical composition [Wt. %]						
	Au	Ag	Cu	Hg	As	Sn	P
Shell, bulk metal (A ₂)	-	1.2	98.2	-	-	0.6	-
Twisted ring (C ₂)	-	5.8	91.4	-	-	2.3	0.5
Bezel (B)	-	0.6	95.1		0.9	3.4	-
Solder area between shells	-	82.8	17.2	-	-	-	-
Gilding layer (A ₁)	83.6	7.1	2	7.3	-	-	-
Gilding layer (C ₁)	82.8	6.1	1.7	9.4	-	-	-

Table 18: Chemical composition of different elements forming the *gombik* H74B-2.

Tab. 18: Chemické složení jednotlivých částí *gombíku* H74B-2.

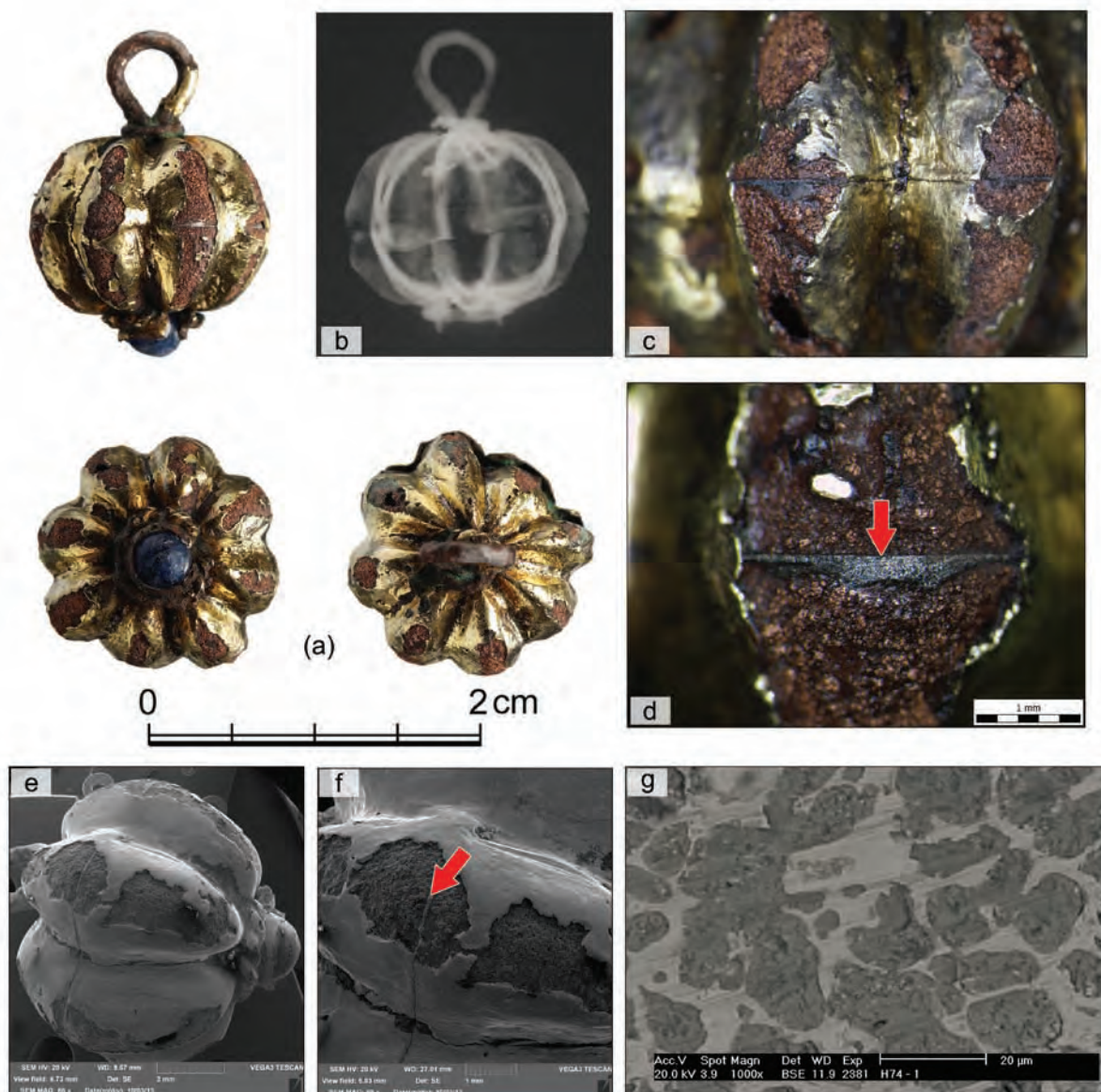

Fig. 4/13: *Gombík* H74B-2: a - general view of the *gombík* (photo J. Sobek); b - X-radiograph of the *gombík* (I. Nacherová); c - tarnished gilding layer (photo E. Ottenwelter); d - solder area between the two shells (photo E. Ottenwelter); e - SEM micrograph (SE image) of the *gombík* (photo Š. Msallamová); f - SEM micrograph (SE image) of the solder area (photo Š. Msallamová); g - SEM micrograph (BSE image) of the solder area between the two hemispheres *gombík* H74B-1 (photo D. Janová).

Obr. 4/13: Gombík H74B-2: a - celkový pohled na gombík (foto J. Sobek); b - rentgenový snímek gombíku (I. Nacherová); c - vrstva korozních produktů stříbra na povrchu zlacení (foto E. Ottenwelter); d - oblast pájeného spoje mezi dvěma polopláští (foto E. Ottenwelter); e - mikrosnímek gombíku z rastrovacího elektronového mikroskopu (zobrazení SE, snímek Š. Msallamová); f - mikrosnímek oblasti pájeného spoje z rastrovacího elektronového mikroskopu (zobrazení SE, snímek Š. Msallamová); g - oblast pájky mezi dvěma hemisférami gombíku H74B-1 - mikrosnímek z rastrovacího elektronového mikroskopu (zobrazení BSE, snímek D. Janová).

3.5. GILDED COPPER ALLOY GOMBIKY WITH GRANULATION WORK AND GLASS CABOCHONS (TYPE 5)

These *gombiky* are represented by a pair of identical *gombiky* found in grave H53 where a wealthy woman was buried. Grave goods included also two gilt silver, two ternary Au-Ag-Cu alloy, and four silver globular earrings, a silver *kaptorga* with filigree zoomorphic decoration, three silver beads, a knife, and two glass beads (Frolík - Smetánka 2014, p. 107-111).

Description of *gombik* H53-14 (Fig. 4/14)

This *gombik* consists of two hemispheres (Fig. 4/14A) of 15 mm in diameter and soldered together. The upper hemisphere is pierced to allow a loop with long legs (Fig. 4/14-G) made from a bended strip of metal to be inserted. A ring of circular section is soldered around it (Fig. 4/14-F). A piece of wire fills the gap between the loop and the hole (Fig. 4/15e, 4/14-H). The *gombik* is decorated with granulation work (Fig. 4/14-I) and blue, glass cabochons (Fig. 4/14-D) of 4.5 mm in diameter fixed inside bezels (Fig. 4/14-E, 4/15a, d). Beaded wires (Fig. 4/14-C) are placed on the top and the bottom hemispheres (Fig. 4/15e) and around each bezel (Fig. 4/15d). Four blue glass cabochons (Fig. 4/14-D, 4/15d) were placed in a bezel along the connecting region in equidistant positions. One of them was placed on the bottom of the *gombik*. Straight wires (Fig. 4/14-B) with round-sectioned wire of 0.3 mm in diameter (Fig. 4/15c) placed vertically define four equal panels on each hemisphere. Straight wires (Fig. 4/14-B) are also placed on the joining area and are joining the glass cabochons together horizontally. Each hemisphere has four equal hexagonal panels decorated by a cross made with granules (Fig. 4/15b). A line of granules of 0.7 mm in diameter runs along the internal side of the hexagonal panels. This type of *gombik* is made with eight different kinds of components (hemisphere, loop, ring, bezel, cabochon, granule, round smooth wire, beaded wire).

Condition of the *gombik* and quality of the work

The *gombik* is not complete. Most of the loop is missing as well as a glass cabochon. The gilding layer is missing on the majority of the granules (Fig. 4/15b, c). It is well preserved on the hemispheres. The gilding layer was covered by a thin layer of copper oxides and possibly silver sulphides. It had a reddish and sometimes dark color. The glass cabochons are well preserved (Fig. 4/15d). The granules are almost all completely mineralized. They have been partly dissolved by previous chemical cleaning. A few of them still contain a metallic core (Fig. 4/15c). The quality of the work is high.

<i>Gombik</i> H53-14		Dimensions [mm]
Hemisphere (A)	Ø	15
Glass cabochon (D)	Ø	4.5
Granule (I)	Ø	0.7
Wire delimiting registers (B)	Ø	0.3
Wire, ring around perforation (F)	Ø	0.6
Beaded wire (C)	Ø	0.7
Strip, loop (G)	Ø	1.2

Table 19: Dimensions of the *gombik* H53-14 and its different components.

Tab. 19: Rozměry *gombíku* H53-14 a jeho jednotlivých částí.

Scanning electron microscopy and microanalysis

Electron microanalysis performed on the surface of the different components showed that a copper alloy containing a small amount of tin was used to manufacture the *gombik*. It is most probable that the tin content is coming from the copper ore used and was not deliberately added (analysis performed on similar *gombik* H53-15 revealed use of almost pure copper (Sn 0.6 %) on the surface of a granule metallic bulk matrix).

The analysis also showed that the *gombik* was fire-gilded with an amalgam containing silver as well (Table 20). An analysis performed on the broken loop has reveal a highly mineralized material in which tin was present at a higher percentage. This may be explained by enrichment of the surface in tin due to the corrosion process.

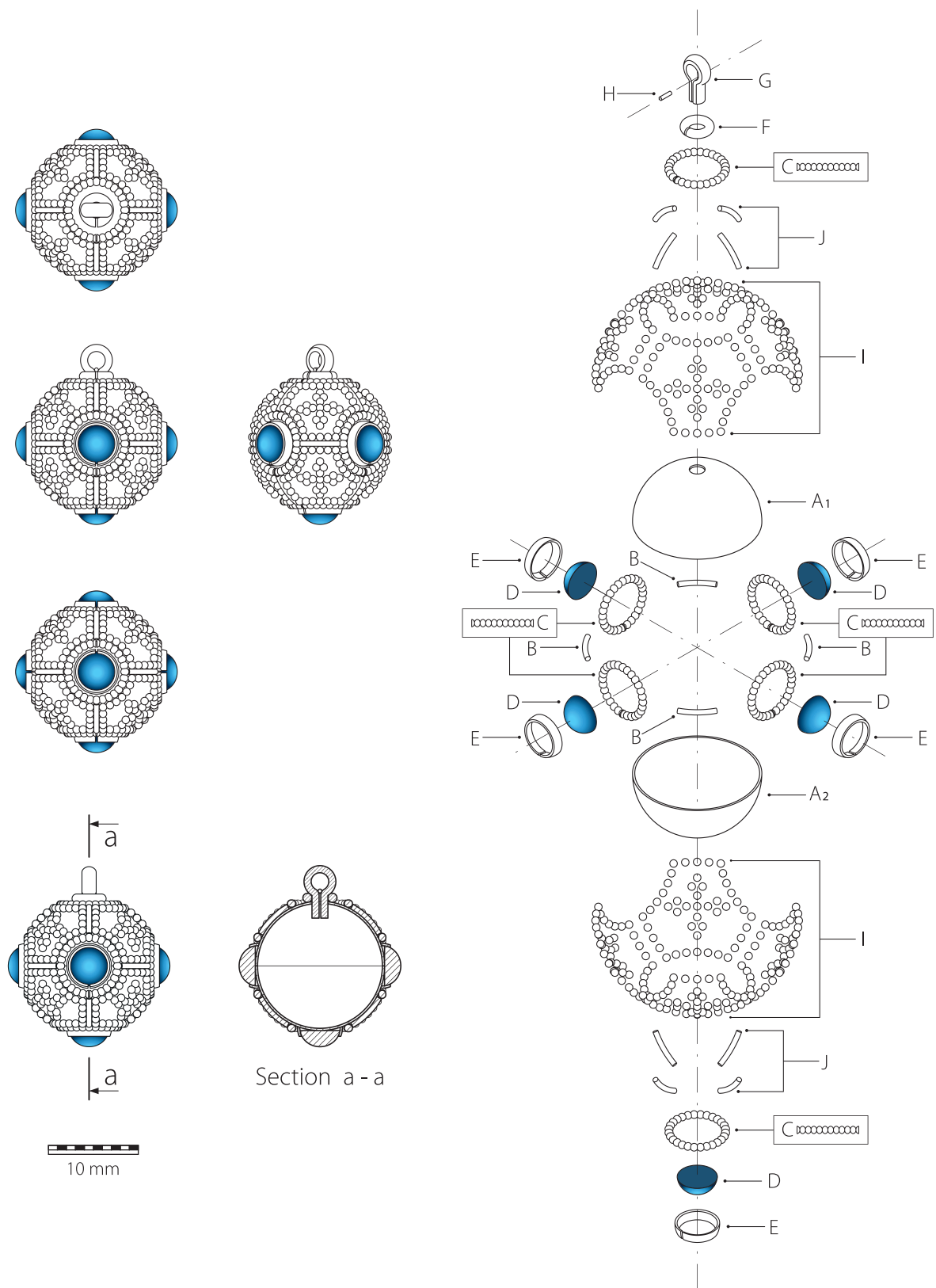

Fig. 4/14: *Gombík* H53-14: exploded view showing the different components composing the *gombík*: A₁ - upper hemisphere; A₂ - lower hemisphere; B - wires; C - beaded wires; D - glass cabochons; E - bezels; F - ring; G - loop; H - fragment of wire; I - granules; J - wires (drawing G. Plítková).

Obr. 4/14: Gombík H53-14: schématické znázornění jednotlivých komponent rozložené sestavy gombíku: A₁ - horní hemisféra; A₂ - dolní hemisféra; B - dráty; C - perlencové dráty; D - skleněné vložky; E - obruby skleněných vložek; F - kroužek; G - ouško; H - fragment drátu; I - granule; J - dráty (kresba G. Plítková).

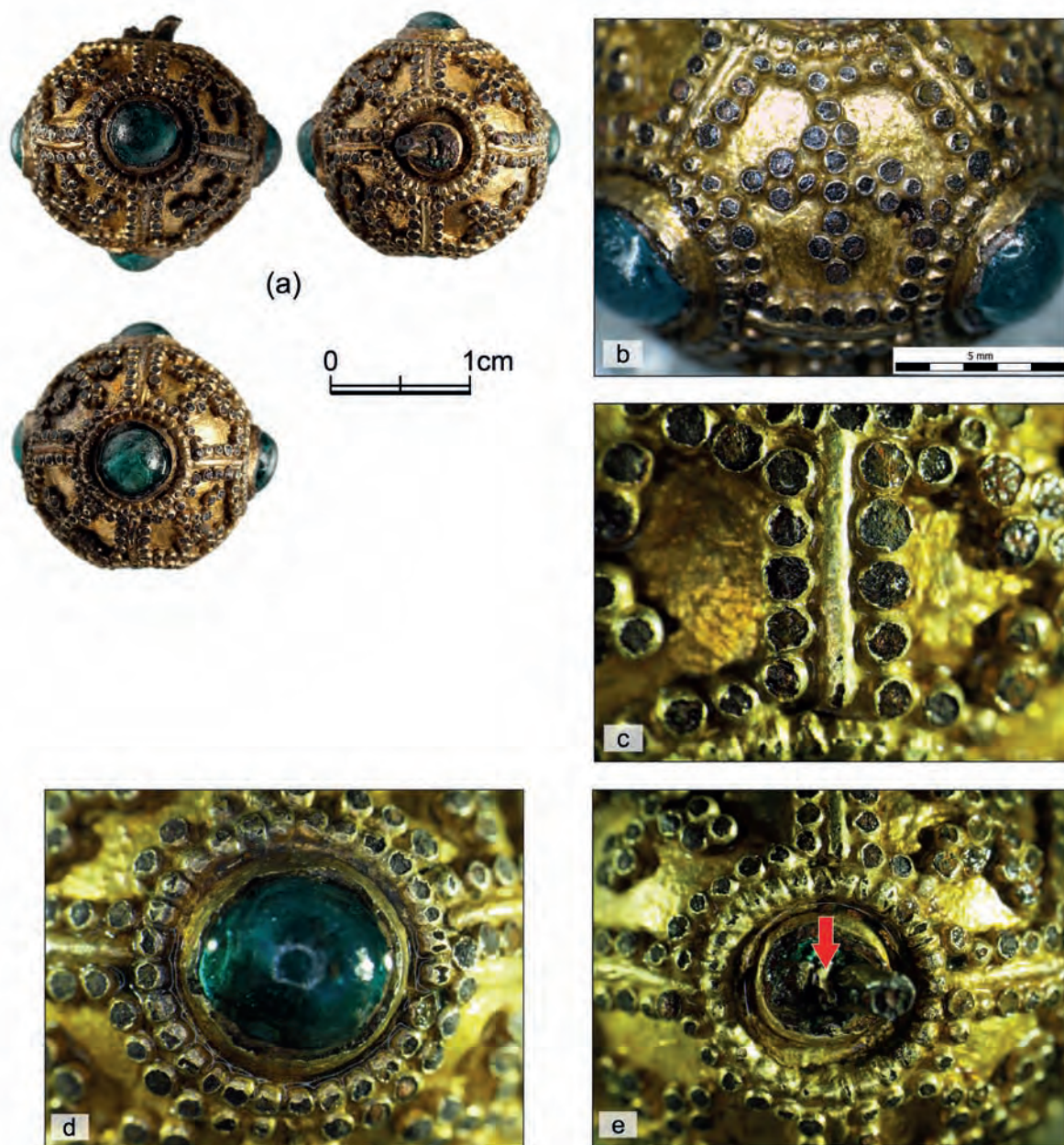

Fig. 4/15: *Gombík* H53-14: a - general view of the *gombík* (photo J. Sobek); b - cross ornament in granulation work (photo E. Ottenwelter); c - small islands of remaining metal are still present in the corroded granules (photo E. Ottenwelter); d - blue glass cabochon in a bezel surrounded by a beaded wire (photo E. Ottenwelter); e - suspension system (photo E. Ottenwelter).

Obr. 4/15: *Gombík* H53-14: a - celkový pohled na *gombík* (foto J. Sobek); b - křížový ornament v granulaci (foto E. Ottenwelter); c - ve zkorodovaných granulích jsou stále ještě přítomné malé ostrůvky zachovalého kovu (foto E. Ottenwelter); d - modrá skleněná vložka v obrubě, usazené v kroužku z perlovcového drátu (foto E. Ottenwelter); e - závěsný systém (foto E. Ottenwelter).

Components forming the <i>gombík</i> H53-14	Chemical composition [Wt. %]										
	Au	Hg	Ag	Cu	Sn	O	Si	P	S	Cl	Ca
Gilded layer on the hemisphere (A)	85.2	6.2	5.5	3.1	-	-	-	-	-	-	-
Bulk metal, granule (I)	-	-	-	97.3	2.7	-	-	-	-	-	-
Bulk metal, loop (G)	-	-	-	74.3	7	12.4	1	1	1	1.3	2

Table 20: Chemical composition of the analysed components forming the *gombík* H53-14.

Tab. 20: Chemické složení analyzovaných částí *gombíku* H53-14.

4. EARRINGS

There are four main types of earrings in the set of the “Lumbe Garden“ cemetery: globular earrings (type 1), pseudoglobular earrings (type 2), zoomorphic earrings (type 3), and grape-shaped earrings (type 4). The majority of the earrings belong to the last type which includes many variants. In total, four specimens of globular earrings, one specimen of “pseudoglobular earring“, one specimen of zoomorphic earring, and ten specimens of grape-shaped earrings were analyzed (*Fig. 4/16*).

4.1. GLOBULAR EARRINGS (TYPE 1)

Three kinds of globular earrings were found in the “Lumbe Garden“ cemetery. All of them were retrieved from grave H53 where a woman was buried together with prestigious grave goods (*Frolík - Smetánka 2014*, p. 107-111).

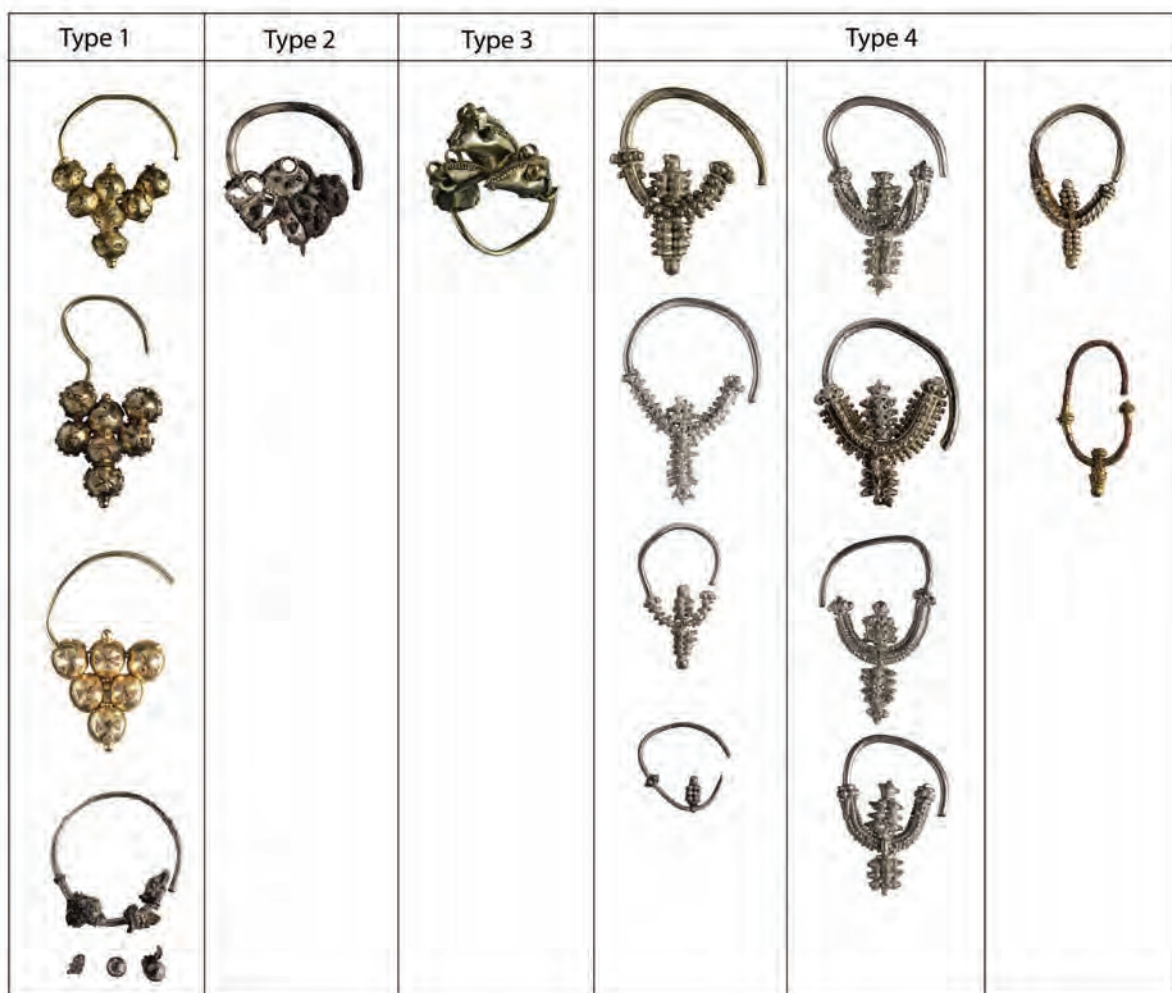

Fig. 4/16: Table summarizing the different types of earrings analysed: type 1 - globular earrings: Au-Ag-Cu alloy (H53-3, H53-4), gilded silver (H53-1), Ag-Cu alloy (H53-5), from 5 to 7 different kinds of components; type 2 - pseudoglobular earrings (H82-5): Ag-Cu alloy, 7 different kinds of components; type 3 - zoomorphic earrings: Au-Ag-Cu alloy (H16-3), 5 different kinds of components; type 4 - grape-shaped earrings: Ag-Cu alloy (H115-14, H84-3, H89-3, H116-1, H84-5, H115-1, H84-8b, H115-2), gilded copper alloy (H31-1), gilded silver (H104-14), from 5 to 9 different kinds of components.

Obr. 4/16: Souhrnný přehled různých typů analyzovaných náušnic: typ 1 – bubínkové náušnice: slitina Au-Ag-Cu (H53-3, H53-4), zlacené stříbro (H53-1), slitina Ag-Cu (H53-5), složené z pěti až sedmi různých druhů komponent; typ 2 - pseudobubínkové náušnice: slitina Ag-Cu (H82-5), složené ze sedmi různých druhů komponent; typ 3 - zoomorfní náušnice: slitina Au-Ag-Cu (H16-3), složené z pěti různých druhů komponent; typ 4 – hrozničkové náušnice: slitina Ag-Cu (H115-14, H84-3, H89-3, H116-1, H84-5, H115-1, H84-8b, H115-2), zlacená slitina mědi (H31-1), zlacené stříbro (H104-14), složené z pěti až devíti různých druhů komponent.

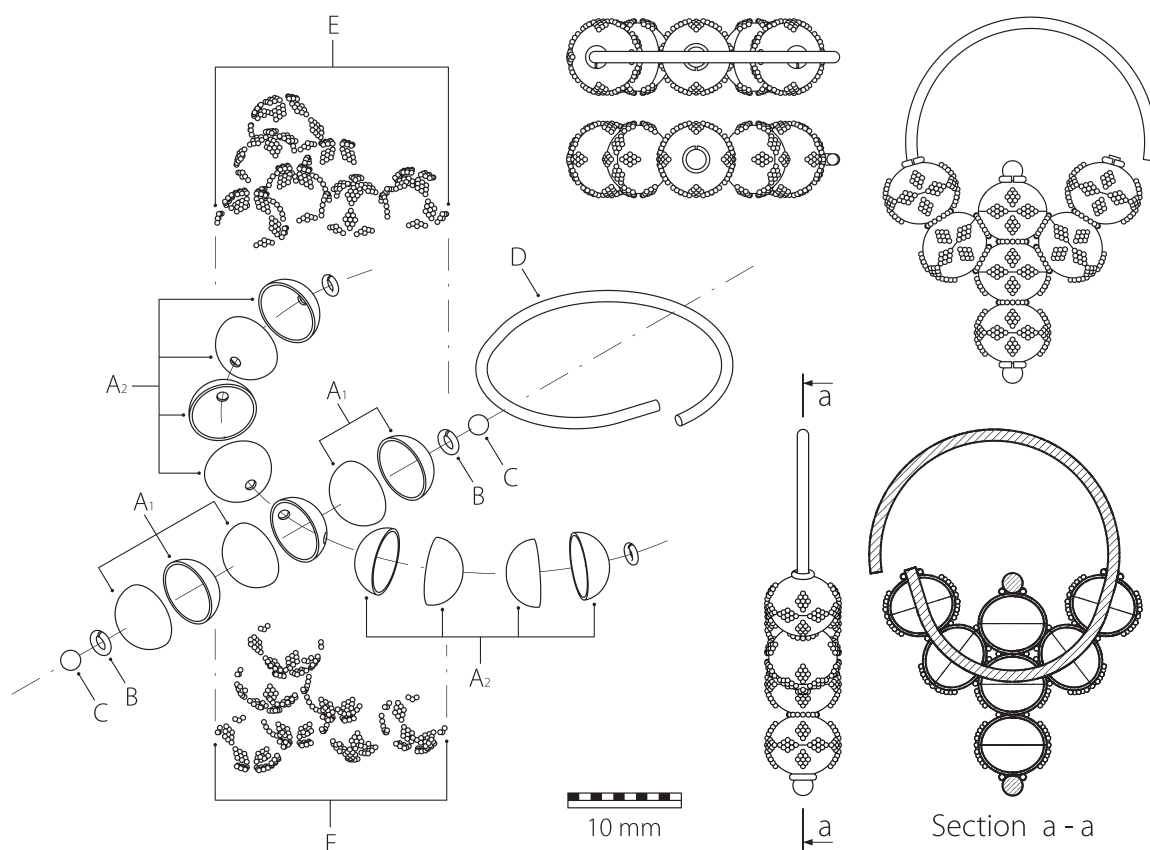

Fig. 4/17: Earring H53-3: exploded view: A - hemispheres forming globes; B - filigree rings; C - big granules; D - central wire; E - small granules (drawing G. Plítková).

Obr. 4/17: Náušnice H53-3: schématické znázornění jednotlivých komponent rozložené sestavy náušnice: A - hemisféry tvořící bubínky; B - filigránové kroužky; C - velké granule; D - středový drát; E - malé granule (kresba G. Plítková).

4.1.1. SEVEN GLOBES GOLD EARRINGS

This type of earring is represented by two specimens (H53-3 and H53-4) creating a pair but which differentiate themselves greatly by the quality of their production as well as the type of granulation work decorating their surface. Both will be considered below.

Description (H53-3 and H53-4, Fig. 4/17)

Both earrings have the same construction. They are made of a central round-sectioned wire (Fig. 4/17-D) on which five globes are threaded (Fig. 4/18c). Each globe is formed by two pierced hemispheres (Fig. 4/17-A) soldered together (Fig. 4/18d). Top and bottom globes are soldered vertically on the lower arch. Both are topped by a big granule (Fig. 4/17-C) sitting in a filigree ring (Fig. 4/17-B) of smooth round-sectioned wire. The same filigree ring (Fig. 4/17-B) is soldered on the ends of the lower arch on each globe to fix them and hide the hole by which the globes are threaded. The globes are soldered to each other. A ring of granules (Fig. 4/17-E) is placed between them. Each globe is decorated by granules (Fig. 4/17-E) massed in rhombi (H53-4) or with granules massed in triangles (H53-3) forming crosses. Five³ kinds of components were used to manufacture this earring.

Condition of the earrings and quality of the work

Both earrings are complete but were covered by a tarnish layer which had to be removed before analyses. The central wire forming the upper arch was mechanically deformed, in particular for earring 53-4. A globe placed at one end of the lower arch is separated from the rest of the earring (Fig. 4/19 a, b).

³ Small discs used to repair the holes are not counted.

Earring H53-3		Dimensions [mm]
Central wire (D)	\emptyset	0.9
Globe hemisphere (A)	\emptyset	6
Small granule (E)	\emptyset	0.3
Big granule (C)	\emptyset	1.5
Filigree ring (B)	\emptyset	1.8
Filigree ring wire	\emptyset	0.3

Table 21: Dimensions of the globular earring H53-3 and its components.

Tab. 21: Rozměry jednotlivých částí bubínkové náušnice H53-3.

The quality of manufacture of earring H53-4 is very high (*Fig. 4/19a, d*) and comparable to earrings H53-1 and H53-2, unlike earring H53-3 which shows many defects. It is obvious that another craftsman manufactured the latter and that he was not so experienced. The earring was heated over the melting point of the bulk metal. Holes in globes are visible (*Fig. 4/18b, f*) and the surface is oxidized (*Fig. 4/18f*). The craftsman repaired arisen holes by soldering small circular (*Fig. 4/18b-f*) or square pieces of metallic sheet of the same material on them. The granulation work is also of poor quality. Many granules were not soldered well and have fallen off (*Fig. 4/18a, e*). Those still in place are not properly positioned (*Fig. 4/18f*). However, the material in which the earring was manufactured as well as the size of the different components are showing that it was produced with the same material and in the same workshop as the other globular earring H53-4. We may think that it was the work of an apprentice. Earring H53-4 is also made from the same material but is perfectly manufactured.

Scanning electron microscopy and microanalysis

Electron microanalysis performed on the surface of the different components of the earring H53-3 showed that all the components of the earring were manufactured from ternary Au-Ag-Cu alloys (Table 22). Slight variations in metal composition can be noted from one component to the other. These variations may be explained by the influence of smeared solder which contained more copper or by the fact that components were prepared with slightly different alloys. Mercury was not detected on the surface; observation on fracture surfaces did not reveal any difference in colour between the surface and the metallic core. We can therefore conclude that this earring was manufactured in solid ternary Au-Ag-Cu alloy. Analyses of globular earrings H53-4 show similar results (Table 23).

Components forming the globular earring H53-3	Chemical composition [Wt. %]			
	Au	Ag	Cu	Hg
Central wire (D)	59.8	31.2	9	-
Filigree ring (B)	58.6	34.9	6.5	-
Upper hemisphere globe (A)	57.3	36.3	6.4	-
Lower hemisphere globe (A)	55.8	36.9	7.3	-
Small granule (E)	59.2	33.1	7.7	-
Big granule (C)	55.7	35.3	9	-
Sheet metal repair	58.2	29.9	11.9	-
Solder area between granules	52.7	31.3	16	-
Solder area between two hemispheres	52.3	33.3	14.4	-

Table 22: Chemical composition of the different components of earring H53-3.

Tab. 22: Chemické složení jednotlivých částí náušnice H53-3.

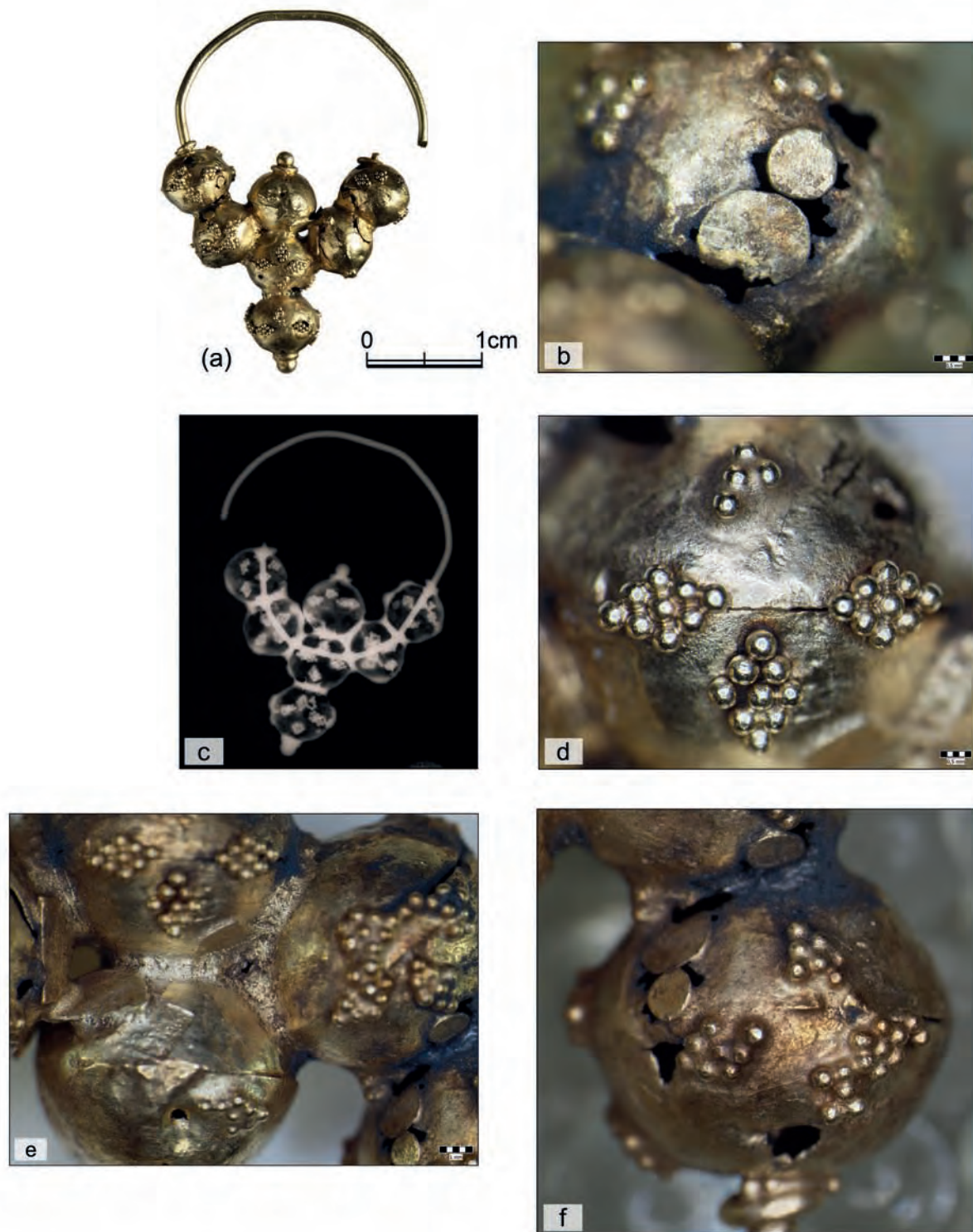

Fig. 4/18: Earring H53-3: a - general view of the earring (photo J. Sobek); b - detail of a repaired area (photo E. Ottenwelter); c - X-radiograph of the earring (D. Perlík); d - detail of two soldered hemispheres decorated by rhombi of granulation work (photo E. Ottenwelter); e - solder areas between the globes (photo E. Ottenwelter); f - repairs of melted-through globe (photo E. Ottenwelter).

Obr. 4/18: Bubínková náušnice H53-3: a - celkový pohled na náušnici (foto J. Sobek); b - detail opravované oblasti (foto E. Ottenwelter); c - rentgenový snímek náušnice (D. Perlík); d - detail dvou spájených hemisfér, dekorovaných granulací ve tvaru kosočtverců (foto E. Ottenwelter); e - oblasti pájených spojů mezi bubínky (foto E. Ottenwelter); f - oprava protavených bubínků (foto E. Ottenwelter).

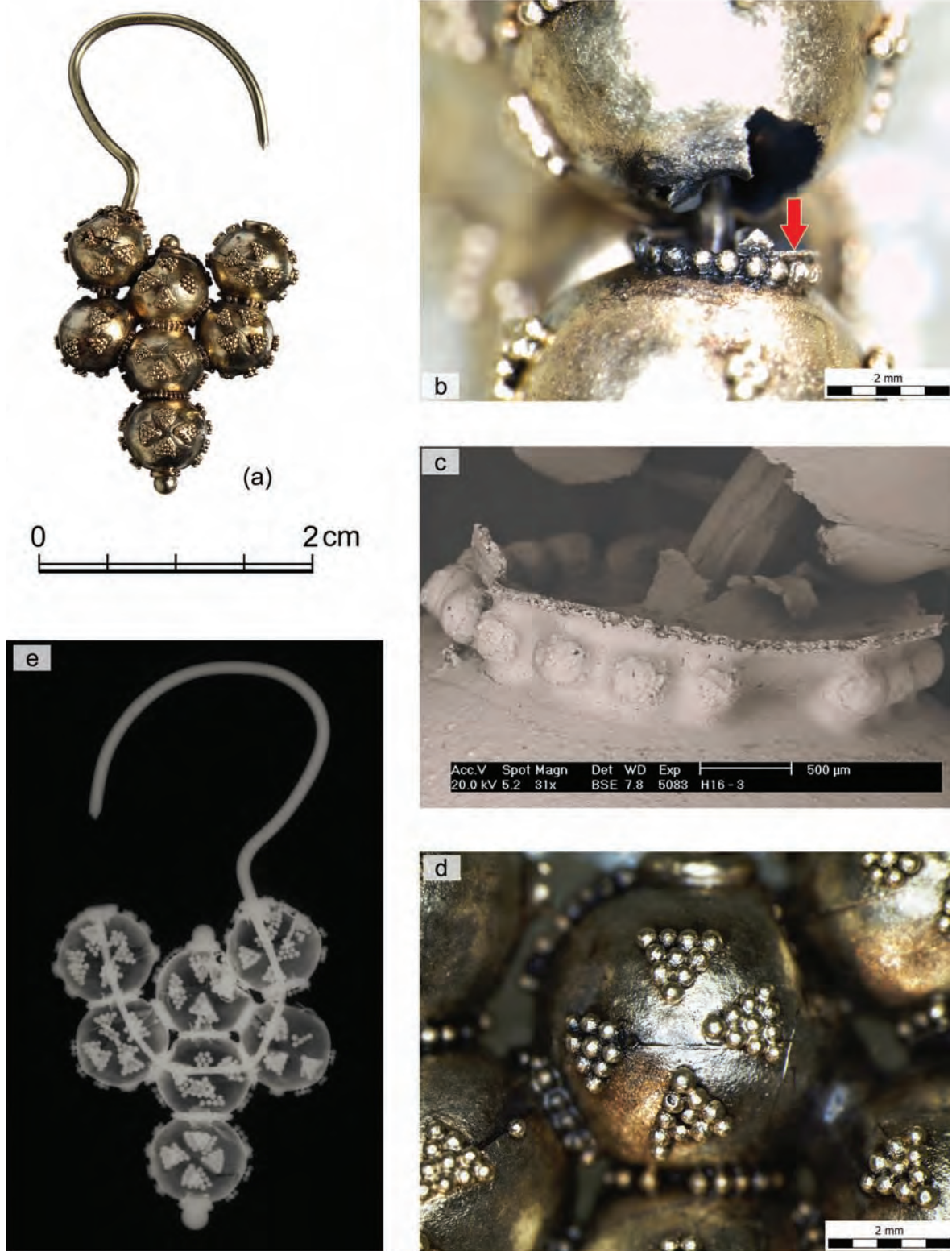

Fig. 4/19: Earring H53-4: a - general view of the earring (photo J. Sobek); b - detail of the broken globe (photo E. Ottenwelter); c - detail of the broken globe, SEM micrograph (BSE image, photo D. Janová); d - detail of granulation work on the globes (photo E. Ottenwelter); e - X-radiograph of the earring (I. Nacherová).

Obr. 4/19: Bubínková náušnice H53-4: a - celkový pohled na náušnici (foto J. Sobek); b - detail odlomeného bubínku (foto E. Ottenwelter); c - detail místa odlomení bubínku, mikrosnímek z rastrovacího elektronového mikroskopu (zobrazení BSE, snímek D. Janová); d - detail granulované dekorace na povrchu bubínků (foto E. Ottenwelter); e - rentgenový snímek náušnice (I. Nacherová).

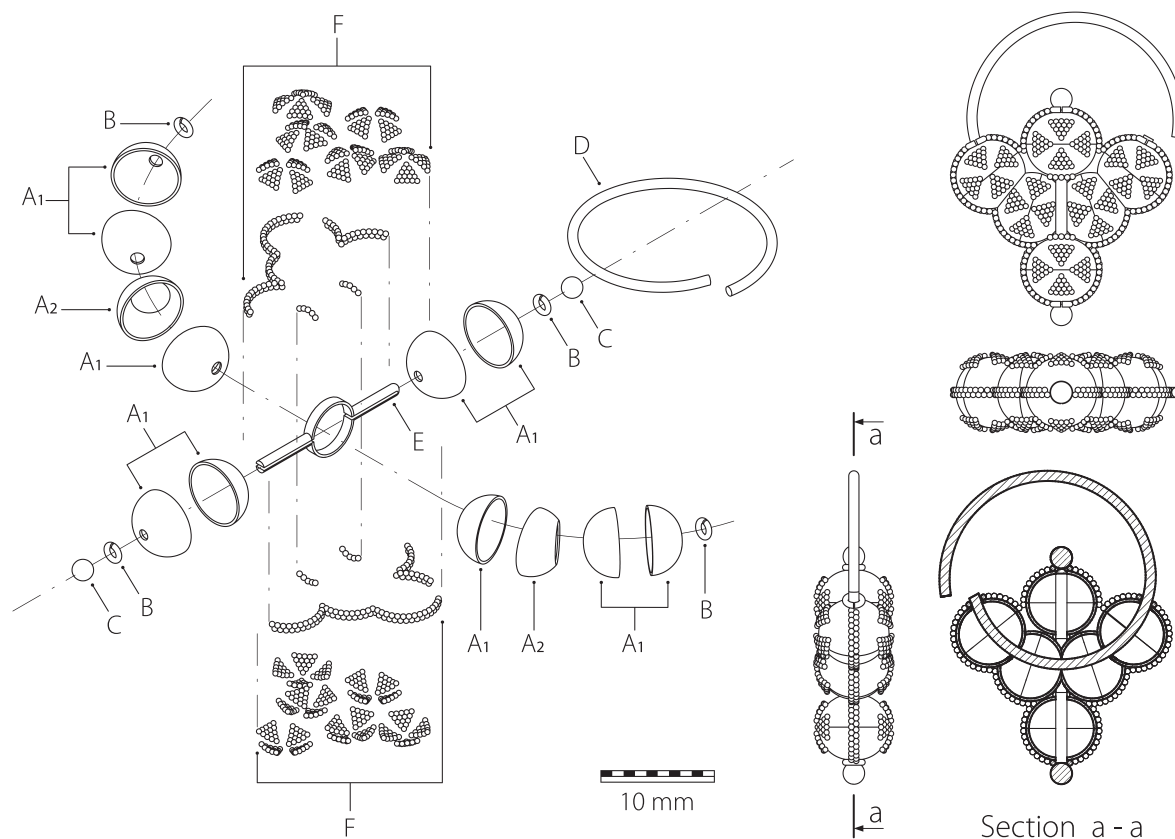

Fig. 4/20: Six globes earring: exploded view: A - hemispheres forming the globes; B - filigree ring; C - big granule; D - central wire; E - clamp; F – granules (drawing G.Plátková).

Obr. 4/20: Náušnice se šesti bubínky: schématické znázornění jednotlivých komponent rozložené sestavy náušnice: A - hemisféry tvořící bubínky; B - filigránové kroužky; C - velké granule; D – středový drát; E – poutko; F – granule (kresba G. Plátková).

Components forming the globular earring H53-4	Chemical composition [Wt. %]			
	Au	Ag	Cu	Hg
Central wire (D)	58.8	36.4	4.8	-
Filigree ring (B)	56.9	30.4	12.7	-
Upper hemisphere globe (A)	53.4	33.1	13.5	-
Lower hemisphere globe, fracture (A)	54.1	38.7	7.2	-
Lower hemisphere, surface (A)	56.8	34.9	8.3	-
Small granule (E)	59.3	31	9.7	-
Big granule (C)	57.7	34	8.3	-
Solder area under fallen granule	67.4	32.6	-	-

Table 23: Chemical composition of the different components of earring H53-4.

Tab. 23: Chemické složení jednotlivých částí náušnice H53-4.

4.1.2. SIX GLOBES GILT SILVER EARRINGS

This subgroup of earring from type 1 is represented by two specimens (H53-1 and H53-2)

Description of the earrings (Fig. 4/20)

This type of earring is constructed on a central round-sectioned wire (Fig. 4/20-D) of 0.9 mm in diameter on which four globes made of two hemispheres (Fig. 4/20-A) soldered together are threaded. Two hemispheres (Fig. 4/20-A₂) were slightly grinded before soldering in the case of earring H53-2. A clamp (Fig. 4/20-E) formed by a semi-round-sectioned wire bent in two and flattened in the middle is placed around the globes of the lower arch and is holding the two globes to form a perpendicular axis on the lower arch. Top and bottom globes of the perpendicular axis are topped by a filigree ring (Fig. 4/20-B) upon which a big granule (Fig. 4/20-C) sits. Globes placed at the ends of the lower arch are topped by a filigree ring (Fig. 4/20-B) of round-sectioned wire.

X-radiography of earring H53-1 (Fig. 4/21c) revealed a different internal structure. Instead of the expected central wire going through all the earring, the craftman used several small pieces of smaller diameters to hold the four globes together and economize precious metal. The internal pieces with exposed ends have the same diameter as the central wire to give the illusion that the same wire is going through all the earring. The globes are decorated with granules (Fig. 4/20-F) of 0.3 mm in diameter which are assembled into triangles forming crosses (Fig. 4/21b). A double line of granules runs along the side of the earring (Fig. 4/21d). Several slightly bigger granules (0.6 mm in diameter) are placed between the clamp and top and bottom globe to fix them tight on the clamp (Fig. 4/21b, f). Seven different kinds of components were used to manufacture the earring.

Condition of the earring and quality of the work

The earring is complete (Fig. 4/21). Only a few decorative granules are missing. It was covered by a thick tarnish layer which had to be cleaned prior to analyses.

The quality of the earring is very high. The earring was manufactured very precisely. Analyses and revealed that it was not a gold earring as it was probably sold, but a silver gilded earring; a perfect imitation of a solid gold earring! The hemispheres and granules are gilded silver. The central wire is a gold alloy. The authenticity of the material was certainly checked on the central wire.

Scanning electron microscopy and microanalysis

Electron microanalysis performed on the surface of the different components of the earring and observation under scanning electron microscope revealed defects on the gilding layer (Fig. 4/21g, h) which show that the earring was not made of solid gold but was gilded. Different materials were used to manufacture the different components of the earrings. A binary alloy of gold (90.2 %) and silver (9.8 %) was used to manufacture the central wire. The hemispheres, the granules, and the clamp were made from different silver alloys containing a little amount of copper (from 3.3 to 5.1 %). They were gilded by fire-gilding with an amalgam probably containing a small amount of silver as well (Table 25).

Earring H53-1		Dimensions [mm]
Central wire (D)	Ø	0.9
Globe hemisphere (A)	Ø	6
Small granule (F)	Ø	0.3
Medium granule	Ø	0.6
Big granule (C)	Ø	1.6
Filigree ring (B)	Ø	1.8
Ring's wire (B)	Ø	0.3
Clamp (E)	width	1.3

Table 24: Dimensions of the globular earring H53-1 and its components.

Tab. 24: Rozměry jednotlivých částí bubínkové náušnice H53-1.

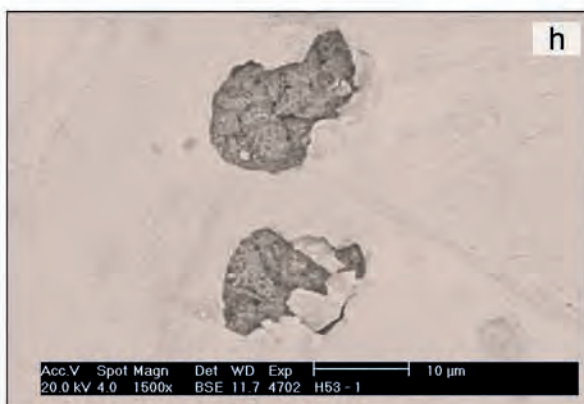
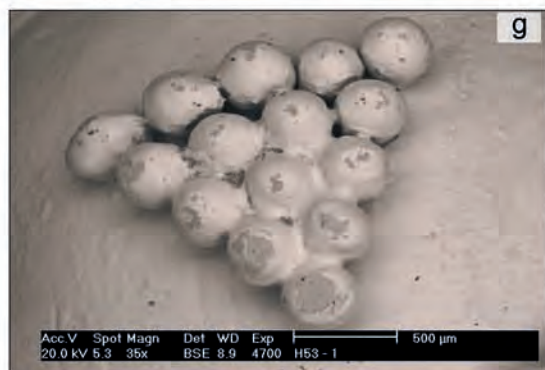
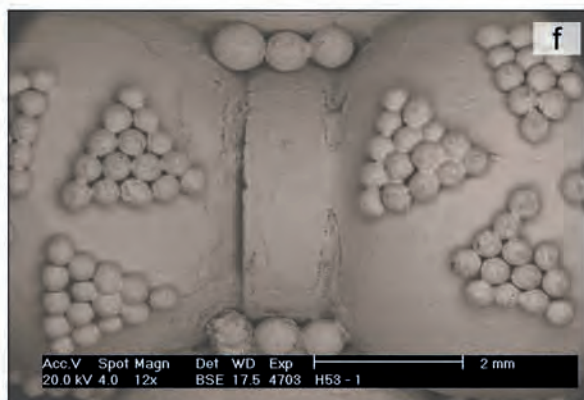
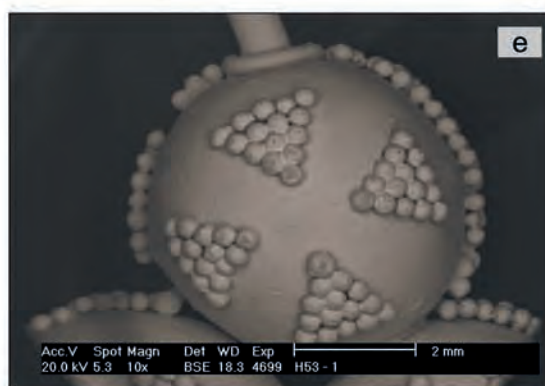
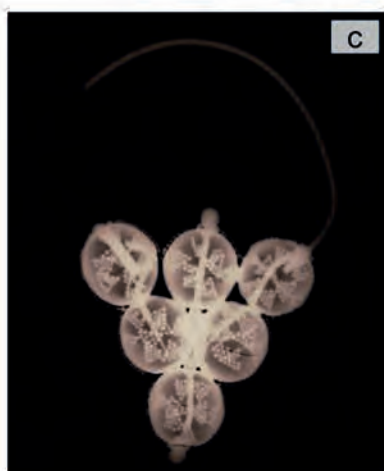
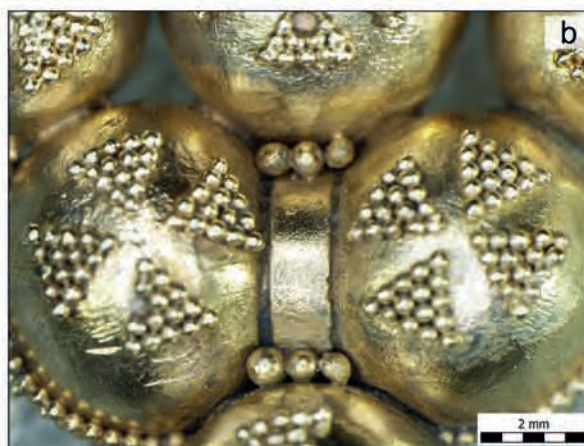

Components forming the globular earring H53-1	Chemical composition [Wt. %]			
	Au	Ag	Cu	Hg
Central wire (A)	90.2	9.8	-	-
Filigree ring, gilding layer (B)	85	5.5	-	9.5
Hemisphere globule, gilding layer (A)	88.1	7.3	-	4.6
Hemisphere globule, bulk metal (A)	14.7	80.2	5.1	-
Small granule, gilding layer (F)	83.4	4.1	0.6	11.9
Small granule, bulk metal (F)	-	95.6	4.4	-
Big granule, bulk metal	-	96.7	3.3	-
Clamp, bulk metal (E)	3.3	92	4.7	-

Table 25: Chemical composition of analysed components forming earring H53-1.

Tab. 25: Chemické složení analyzovaných částí náušnice H53-1.

4.1.3. SILVER GLOBULAR EARRINGS

Description (Fig. 4/22)

Four silver globular earrings were also retrieved from grave H53. They are, however, in very poor condition; none of them have a complete archaeological profile. The best preserved is earring H53-5 (Fig. 4/22a). According to the remaining preserved fragment we can deduce that it was probably a seven globe earring of the same basic composition as globular earrings H53-3 and H53-4, though, with a difference in the granulation work. In this type of earring, globes were entirely covered by granules sitting in a filigree ring as were silver beads H100-18 and H100-29 from grave H100. The central wire has a round section of 1.2 mm in diameter. The hemispheres which form the globes have a diameter of 5 mm. The small granules sitting in a filigree ring have a diameter of 0.3 mm. Big granules topping the upper and lower globes which form the perpendicular axis of the earring have a diameter of 2 mm. The small filigree wire's ring on which the small granules sit have a diameter of 1 mm. The hemispheres have a wall thickness of 0.1 mm.

Condition of the earring and quality of manufacture

The earring is in very poor condition (Fig. 4/22a). It is incomplete and most of the globules are missing. The remaining fragments of the globules are almost completely mineralized and are extremely brittle because of intergranular corrosion and thinness of the globules walls. The surface is heavily etched by a previous restoration treatment with alkaline cyanides. The metallographical structure showing recrystallized and twinned grains typical for annealed after cold-working material (Scott 1991, p. 7) is visible by observation under stereomicroscope (Fig. 4/22b). It is hard to evaluate the quality of the earring because of its poor condition, but we can presume that it was high considering the very small size of filigree rings and granules which were soldered on the globes.

← **Fig. 4/21:** Earring H53-1: a - general view of the earring (photo J. Sobek); b - detail of the clamp and the granulation work (photo E. Ottenwelter); c - X-radiograph revealing the internal structure of the earring (D. Perlík); d - detail of the granulation work (photo E. Ottenwelter); e - detail of the granulation work, SEM micrograph (BSE image, photo J. Janová); f - detail of the clamp holding upper and lower globes, SEM micrograph (BSE image, photo D. Janová); g - detail of the granulation with worn gilding layer, SEM micrograph (BSE image, photo J. Janová); h - flaking gilding layer revealing bulk metal of the granules micrograph (BSE image, photo J. Janová).

← **Obř. 4/21:** Náušnice H53-1: a - celkový pohled na náušnici (foto J. Sobek); b - detail poutka a granulace (foto E. Ottenwelter); c - rentgenový snímek, odhalující vnitřní strukturu náušnice (D. Perlík); d - detail granulace (foto E. Ottenwelter); e - detail granulace, mikrosnímek z rastrovacího elektronového mikroskopu (zobrazení BSE, snímek D. Janová); f - detail poutka, upevňujícího horní a spodní bubínek, mikrosnímek z rastrovacího elektronového mikroskopu (zobrazení BSE, snímek D. Janová); g - detail granulace se sedřenou vrstvou zlacení, mikrosnímek z rastrovacího elektronového mikroskopu (zobrazení BSE, snímek D. Janová); h - odlupující se vrstva zlacení a odhalený základní kov granulí, mikrosnímek z rastrovacího elektronového mikroskopu (zobrazení BSE, snímek D. Janová).

Earring H53-5		Dimensions [mm]
Central wire	Ø	1.2
Globe hemisphere	Ø	5
Small granule	Ø	0.3
Big granule	Ø	2.8
Big filigree ring	Ø	2
Big filigree ring's wire	Ø	0.5
Small filigree ring	Ø	0.6
Small filigree ring's wire	Ø	0.1
Hemisphere	thickness	0.1

Table 26: Dimensions of the globular earring H53-5 and preserved components.

Tab. 26: Rozměry bubínkové náušnice H53-5 a jejich dochovaných částí.

Scanning electron microscopy and microanalysis

Electron microanalysis performed on the surface and on the cross section of a fragment of the hemisphere with small granule sitting in a filigree ring showed that binary Ag-Cu alloys with a small amount of copper were used to manufacture the different components of the earring (Table 27). The central wire, small filigree ring decorating the hemispheres, as well as the hemispheres were manufactured with a silver alloy containing about 3 % of copper, while the elbow ring and the small granules were manufactured with a silver alloy containing a little less copper (2.2 %). The bottom granule contains more copper (4 %). The solder area analysed on the unetched polished cross-section between two granules has detected only pure silver. The area is completely mineralized. The copper phase has probably been removed by corrosion process.

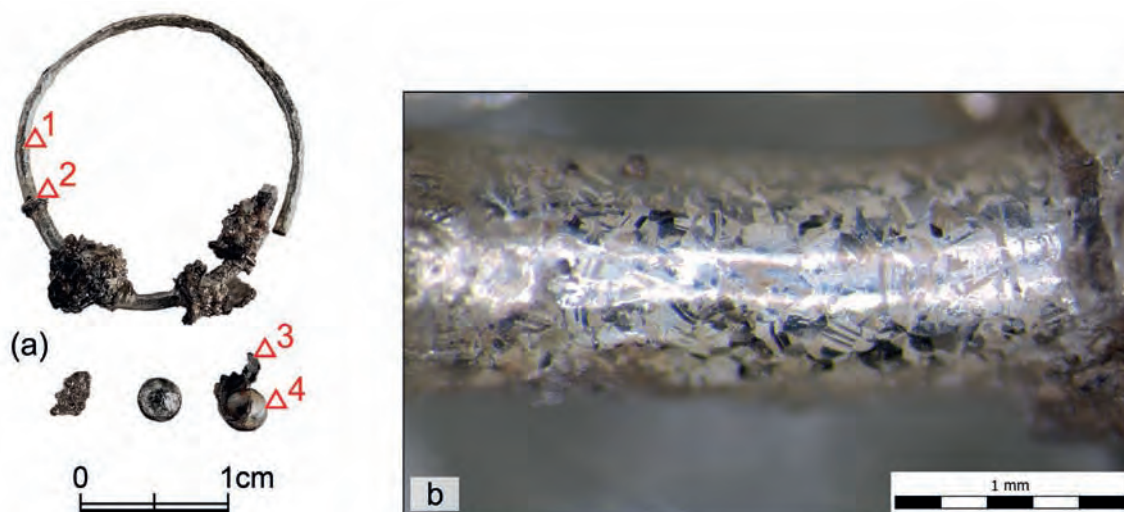

Fig. 4/22: Earring H53-5: a - general view of the earring (photo J. Sobek); b - etched surface by previous chemical treatment revealing microstructure of the metal visible under stereomicroscope (photo E. Ottenwelter).

Obr. 4/22: Náušnice H53-5: a - celkový pohled na zachované fragmenty náušnice (foto J. Sobek); b - naleptaný povrch po předchozím chemickém čištění; mikrostruktura kovu je patrná i při pozorování stereomikroskopem (foto E. Ottenwelter).

Components forming the globular earring H53-5	Chemical composition [Wt. %]	
	Ag	Cu
Central wire, point 1	96.9	3.1
Elbow filigree ring, point 2	97.8	2.2
Small filigree ring, point 3	97.1	2.9
Hemisphere, cross-section	97	3
Small granule, cross-section	97.7	2.3
Big granule, point 4	96	4
Solder area between two granules, cross section	100	-

Table 27: Chemical composition of analysed components forming the earring H53-5.

Tab. 27: Chemické složení analyzovaných částí náušnice H53-5.

4.2. PSEUDOGLOBULAR EARRING (TYPE 2)

This type of earring was found exclusively in grave H82 where a woman was buried together with a metallic necklace including filigree beads and two *kaptorgy*. At least eleven earrings of this type were recovered from the grave (Frolík - Smetánka 2014, p. 146-151), the majority of which are in a very bad condition. The shells with the globes have, in most cases, disappeared. Specimen H82-5 was the best preserved, although not entirely complete (Fig. 4/24). The complete profile of the earrings was, nevertheless, found on photographs taken in situ during excavations (Frolík - Smetánka 2014, p. 147).

Description of the earring (Fig. 4/23)

The earring is composed of two shells which have the shape of five hemispheres pressed together with another hemisphere placed on the bottom (Fig. 4/23-A₁, A₂). One of the shells has an additional semi-circular plate on the top part (Fig. 4/23-A₂). These shells were probably fabricated by using a lead block on which the shape was previously formed with doming tools to create semi-circular depressions (see Barčáková in this volume). These two shells are soldered together and pierced at each end to allow the central wire to go through (Fig. 4/23-C). A small ring made of round-sectioned, plain wire (Fig. 4/23-B) was then soldered into the two perforations to fasten the central wire to the earring's body. The central wire was hammered and elongated at the part which was inserted into the earring, most likely to save some material, this part being invisible once the two shells were soldered together. The bottom hemisphere is topped with a big granule (Fig. 4/23-F) sitting inside a small filigree ring (Fig. 4/23-E) made of plain, smooth round-sectioned wire. The semi-circular plate on the top part of one of the shells (Fig. 4/23-A₂) is pierced and two filigree rings (Fig. 4/23-D) are soldered around it. The earring surface is decorated by granulation work (Fig. 4/23-G) displayed in triangles forming a cross on each hemisphere. A line of granules also frames each hemisphere while a double line of granules frames the semi-circular plate on the top part which also bears a decoration made of three granules soldered together. The joining area of the two shells is decorated by a double line of granules. This earring was manufactured with seven different kinds of components (central wire, two kinds of shells, two types of filigree rings, and two types of granules).

Condition of the earring and quality of the work

The earring is in a very poor condition. It is not complete. The second shell is missing as well as the bottom part of the earring (Fig. 4/24a). Furthermore, it is extremely brittle because of intergranular corrosion (Fig. 4/24b, c). This fragility is also due to the thickness of the metal sheet used to manufacture the earring which is extremely thin (0.1 mm). The earring was treated in the past by immersion in alkaline cyanides which heavily etched the surface (Fig. 4/24d). Some corrosion products, mainly silver chlorides and sulphides, are still covering the surface, in particular the granules. Surface analyses of the granules was, therefore, not possible because it would have analysed only the corrosion products. It is hard to evaluate the quality of the work because the earring is in very poor condition, but according to the goldsmith who made replicas of this type of earring (see Barčáková in this volume), it was a difficult jewel to manufacture.

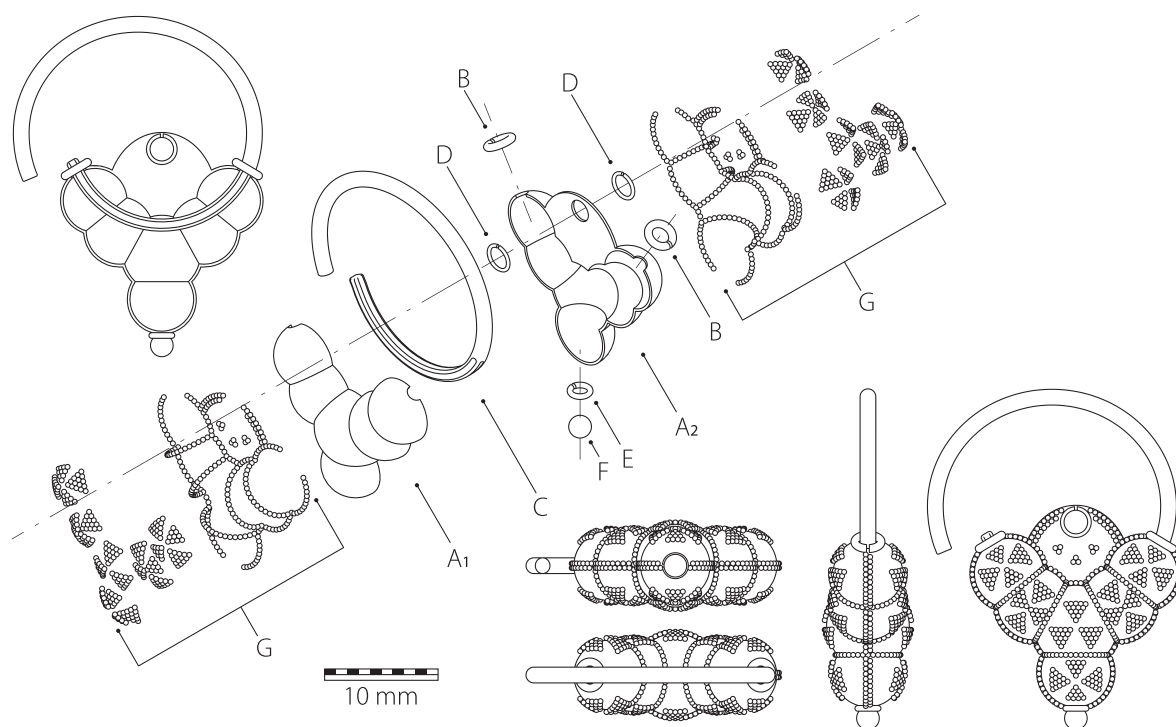

Fig. 4/23: Earring H82-5: exploded view showing the different components composing the earring: A₁ - embossed half shell; A₂ - embossed half shell with upper semi-circular plate; B - small ring; C - central wire; D - ring; E - small ring; F - big granule; G - small granules (drawing G. Plítková).

Obr. 4/23: Náušnice H82-5: schématické znázornění jednotlivých komponent rozložené sestavy náušnice: A₁ - vytepaný poloplášť náušnice; A₂ - vytepaný poloplášť náušnice s horní půlkruhovou destičkou; B - malý kroužek; C - středový drát; D - kroužek; E - malý kroužek; F - velká granule; G - malé granule (kresba G. Plítková).

Earring H82-5		Dimensions [mm]
Total length		25.6
Total width		18.8
Small granule (G)	Ø	0.4
Wire (D)	Ø	0.3
Ring (D)	Ø	2.5
Wire (B)	Ø	0.5
Ring (B)	Ø	2.5
Shell (A)	thickness	0.1
Central wire (C)	external Ø	1.4
Central wire (C)	internal Ø	1.1

Table 28: Dimensions of the earring H82-5 and its components.

Tab. 28: Rozměry jednotlivých částí náušnice H82-5.

Scanning electron microscopy and microanalysis

Electron microanalyses performed on the surface of the different components of the earring (Table 29) showed that silver with a small amount of copper from 4 % up to 6.3 % was used to manufacture the different elements of the earring (Table 29). Analyses performed on the solder area showed a slightly higher concentration of copper.

Analyses performed on the cross section of two fragments of an identical type of earring (H82-7 and H82-8) have shown that the matrix of the metal sheet of both earring H82-7 and H82-8 was a binary alloy of 95.8 % of silver and 4.2 % of copper, while the alloy used to manufactured the granules had a slightly lower content of copper (3.6 % - Table 29) (see *Kolářová – Děd – Ottenwelter* in this volume).

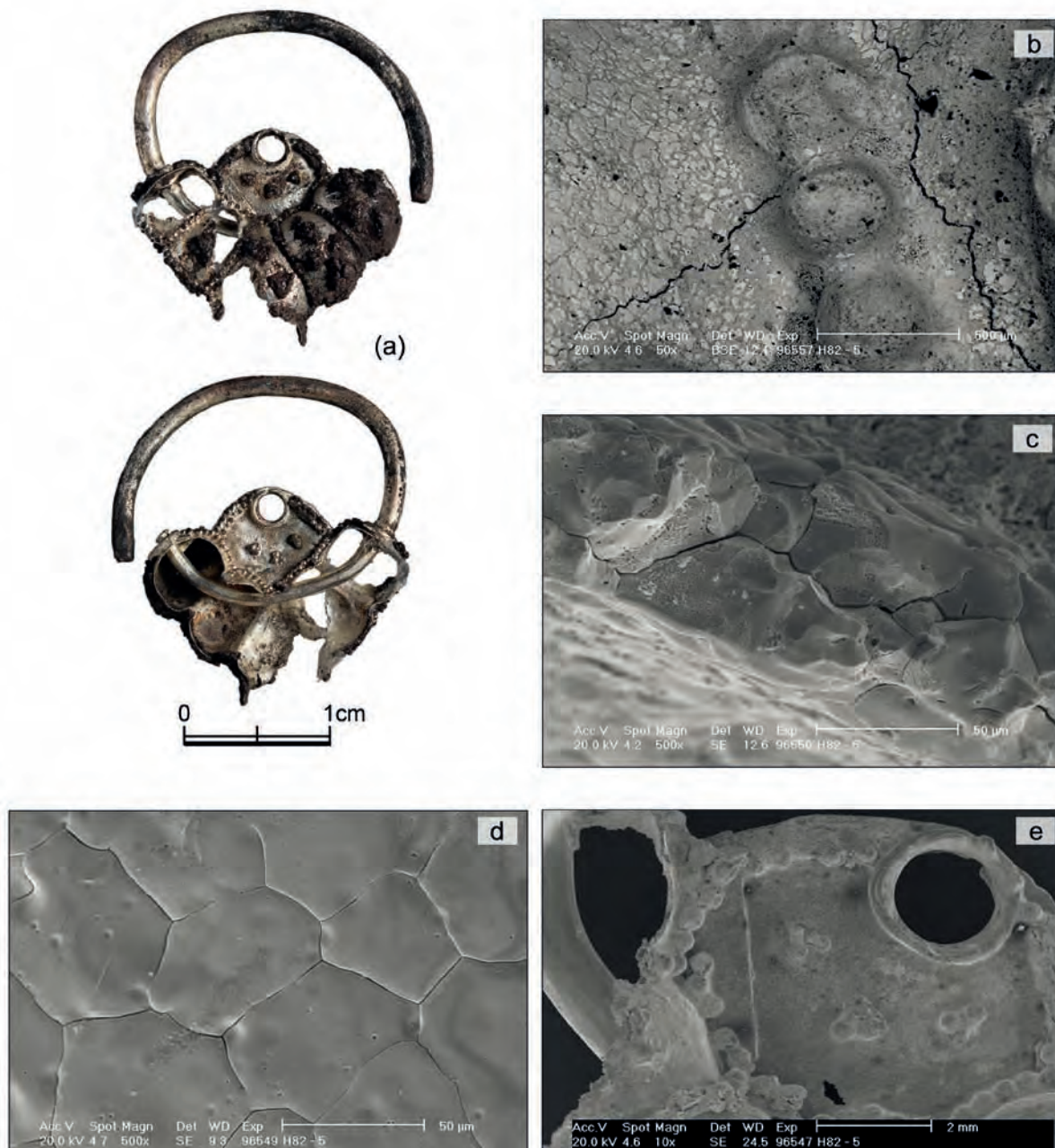

Fig. 4/24: Earring H82-5: a - general view of the earring (photo J. Sobek); b - intercrystalline cracks on earring shell surface, SEM micrograph (BSE image, photo D. Janová); c - fracture resulting from severe intergranular corrosion, SEM micrograph (SE image, photo J. Janová); d - etched surface, SEM micrograph (SE image, photo J. Janová); e - detail of the semi-circular plate, SEM micrograph (SE image, photo D. Janová).

Obr. 4/24: Náušnice H82-5: a - celkový pohled na náušnici (foto J. Sobek); b - interkrystalické trhliny na povrchu pláště náušnice, mikrosnímek z rastrovacího elektronového mikroskopu (zobrazení BSE, snímek D. Janová); c - interkrystalická lomová fazeta, lom v důsledku mezikrystalového korozního napadení, mikrosnímek z rastrovacího elektronového mikroskopu (zobrazení SE, snímek D. Janová); d - naleptaný povrch, mikrosnímek z rastrovacího elektronového mikroskopu (zobrazení SE, snímek D. Janová); e - detail půlkruhové destičky, mikrosnímek z rastrovacího elektronového mikroskopu (zobrazení SE, snímek D. Janová).

Components forming the earring H82-5	Chemical composition [Wt. %]	
	Ag	Cu
Central wire (C)	94.3	5.7
Front shell (A ₁), crack	93.7	6.3
Semi-circular plate (A ₂)	95.3	4.7
Ring (D)	96	4
Front shell (A ₁), corroded	95	5
Solder area between granules	93.3	6.7
Solder area between central wire and upper sheet	92.7	7.3

Table 29: Chemical composition of the different element composing the earring H82-5.

Tab. 29: Chemické složení různých částí náušnice H82-5.

4.3. GOLD ZOOMORPHIC EARRINGS (TYPE 3)

This type of earring was found exclusively in grave H16 where a young woman was buried. Burial goods included thirteen of these earrings, all identical, as well as a pair of similar gold “two-layered *gombiky*“, a highly decorated *kaptorga*, three gold beads, and a knife (*Frolík - Smetánka 2014*, p. 64-68).

Description of the earring H16-3 (*Fig. 4/25*)

This type of earring is constructed on a central wire (*Fig. 4/25-A*) with a round section of 0.7 mm in diameter, hammered into a square section wire on the lower part (*Fig. 4/26c*). Three similar decorative ornaments resembling a mouse or a horse head are threaded on the lower part of the wire. Each of these decorative ornaments are formed by two identical tear-shaped shells (*Fig. 4/25-B₁, B₂*) formed on a die (see *Barčáková* in this volume). These two shells are soldered together (*Fig. 4/26f*). A strip of metal of 0.9 mm in width and 0.1 mm in thickness forming the ears of the animal (*Fig. 4/25-C, 4/26b*) mechanically joins the two shells of the body through holes. The central wire is inserted in two holes pierced at the base of the mice. The mice are decorated by three parallel double lines of granules (*Fig. 4/25-D₂*) of 0.3 mm in diameter along their back (*Fig. 4/26g*). A little hook (*Fig. 4/26f*) at the end of the central wire as well as little granules (*Fig. 4/25-D₁*) soldered on the main wire between them fastens the three mice onto the main wire. The solder area between the granules on the back has a reddish color (*Fig. 4/26d*) suggesting presence of copper. The thickness of the shells and the strip forming the ears is 0.1 mm. A total of five kinds of components were manufactured to form this earring. The earring weights 0.74 grams.

Earring H16-3		Dimensions [mm]
Total length		14.2
Total width		12.7
Main wire (A)	Ø	0.7
Granule (D)	Ø	0.3
Tear shaped shell (B)	length	9.1
Tear shaped shell (B)	thickness	0.1
Strip (C)	thickness	0.1
Strip (C)	width	0.9

Table 30: Dimensions of the earring H16-3 and its different components.

Tab. 30: Rozměry náušnice H16-3 a jejich částí.

Condition and quality of the work

The earring is well preserved, but a layer of tarnish made of copper and silver corrosion products was covering the surface. It was cleaned before analyses. The quality of the work is good.

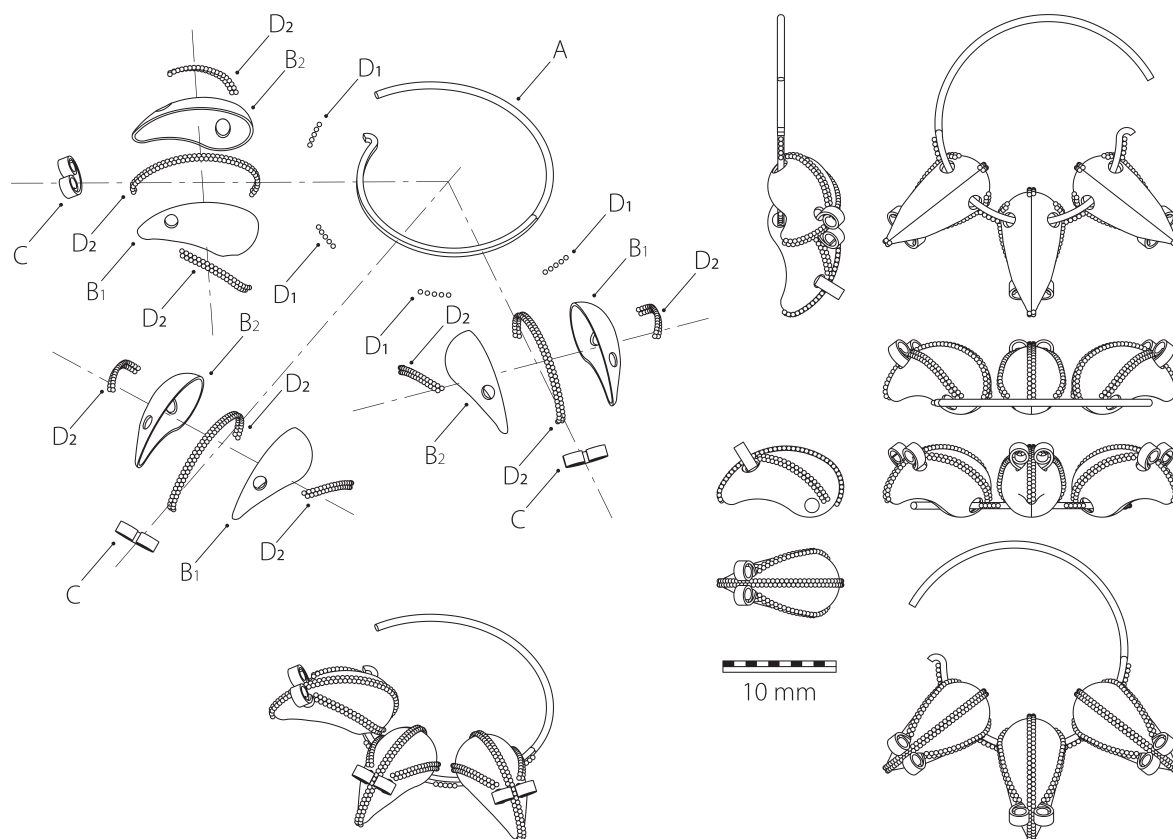

Fig. 4/25: Earring H16-3: exploded view showing the different components composing the earring: A - central wire; B - „tear-shaped“ half shell; C - strip; D - granules (drawing G. Plítková).

Obr. 4/25: Náušnice H16-3: schématické znázornění jednotlivých komponent rozložené sestavy náušnice: A – středový drát; B – poloplášť kapkovitého tvaru; C - pásek; D - granule (kresba G. Plítková).

Scanning electron microscopy and microanalysis

Electron microanalyses performed on the surfaces of the different components of the earring show that all the components of the earrings were made with two types of ternary Au-Ag-Cu alloys. The first contains approximately 54 % of gold, 35 % of silver, and 11 % of copper. It was used to manufacture the “tear” shaped shells, granules, and strips. The second exhibits a higher percentage of silver (40 %) and slightly lower percentage of gold and copper and was used to manufacture the central wire. Analyses of the solder area between the granules evidenced a higher percentage of copper (about three times more than in bulk metal) which shows that copper compounds were added deliberately to create a solder with bulk metal which has a lower melting point temperature than the metal used to manufacture the components.

Components forming the earring H16-3	Chemical composition [Wt. %]		
	Au	Ag	Cu
Central wire (A)	52.8	40	7.2
Tear shaped shell (B)	54	34	12
granule (D)	55	34.4	10.6
Strip (C)	53.6	36	10.4
Solder area between granules	51.7	16.6	31.7

Table 31: Chemical composition of the different components composing the earring H16-3.

Tab. 31: Chemické složení jednotlivých částí náušnice H16-3.

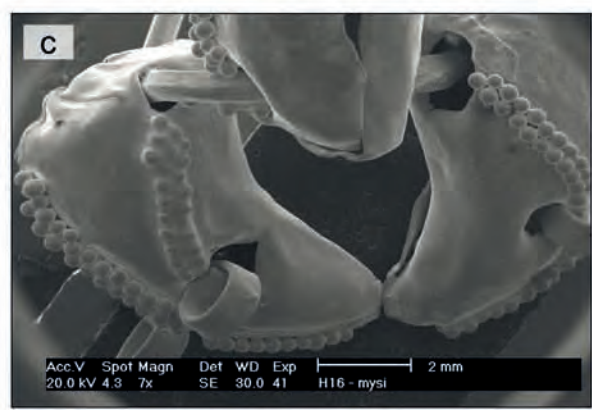
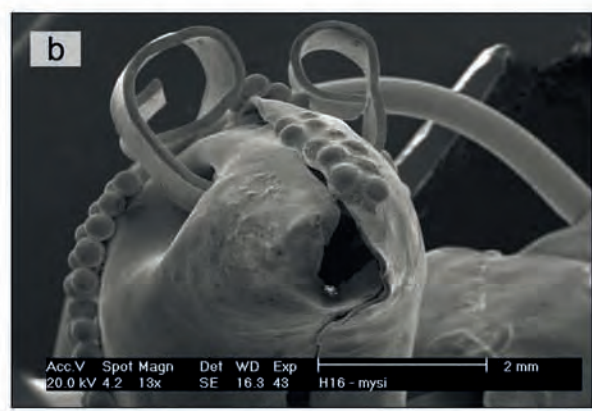

4.4.GRAPE-SHAPED EARRINGS (TYPE 4)

Grape-shaped earrings are forming the most numerous type of earrings from the “Lumbe Garden” cemetery.

They are all formed on a central, smooth round-sectioned wire, which is hammered into a square-sectioned wire on the lower arch while the latter is decorated by granulation and filigree work. They all bear grape-shaped ornaments made, most of the time, from rings of several rows of granules soldered together, sitting on a filigree ring, and topped by a bigger granule sitting in a filigree ring. Most of the time, the grape-shaped ornaments are double-sided, creating a vertical axis on the lower arch. Both grapes are either soldered directly on the lower arch or fixed with a folded strip inserted through both grapes, shaped around, and soldered to the lower arch. Two elbows composed of a ring of granules between two filigree rings are placed on the ends of the lower arch. The lower arch is always decorated in various ways by granulation and filigree work. It was left smooth in only one case (H116A-1). In the set of the “Lumbe Garden” cemetery, the majority of grape-shaped earrings were manufactured of solid silver alloy with a small amount of copper. One specimen was made of gilt silver and two specimens forming a pair were made in gilded copper alloy. A total of ten specimens were examined under stereomicroscope and analysed.

4.4.1.SILVER GRAPE-SHAPED EARRING WITH RICH GRANULATION WORK

This group represents the majority of the grape-shaped earrings of the “Lumbe Garden“ cemetery. Several variants can be distinguished according to the level of complexity displayed in the decoration of the lower arch as well as the size of the different components forming the earrings.

4.4.1.1. DOUBLE-SIDED GRAPE-SHAPED EARRINGS WITH LOWER ARCH DECORATED BY LINES OF GRANULES SITTING IN A FILIGREE RING

This subgroup represents seven specimens excavated from grave H115 (H115-3, H115-4, H115-5, H115-11, H115-13, H115-14, H115-16), three specimens from grave H81 (H81-1, H81-3, H81-9), one specimen from grave 84 (H84-3), and four smaller specimens from grave H89 (H89-3, H89-4, H89-5, H89-6). The earrings of this type have a central round-sectioned wire hammered into a square-sectioned wire on the lower arch. The lower arch is decorated at each end by an elbow comprising a ring of six granules placed between two smooth circular filigree rings. In two cases (H115-13 and H115-16), the bottom and top filigree wire forming the elbow is not a smooth round-sectioned wire but a ring made of two twisted wires. The lower arch of this type of earring is decorated on each side by rows of granules sitting in a small filigree, made of smooth, round-sectioned wire. Top and bottom grapes comprise rings of six granules soldered above each other and topped with a smaller granule sitting in a filigree ring. Top and bottom grapes are sitting on a ring. The lower and upper grapes are usually made of four (sometimes three) stacked rings of granules. Sometimes the upper grape has only three rows of rings. Both top and bottom grapes are topped by a big granule sitting on a filigree ring which is decorated by five smaller granules sitting on a small filigree ring. In all cases, the top and bottom grapes are directly soldered on the lower arch except for earrings from grave H84-3 and earring H89-3, which have a clamp inserted in both grapes made of a folded metallic strip shaped around the lower arch and soldered to it.

Three specimens of this group are presented below (H115-14, H84-3 and H89-3).

← **Fig. 4/26:** Earring H16-3: a - general view of the earring (photo J. Sobek); b - detail, SEM micrograph (SE image, photo D. Janová); c - detail, SEM micrograph (SE image, photo D. Janová); d - solder area between the granulation work (photo E. Ottenwelter); e - detail (photo E. Ottenwelter); f - detail showing the two embossed half shells soldered together (photo E. Ottenwelter); g - detail of the granulation work on the back of the animal (photo E. Ottenwelter).

← **Obr. 4/26:** Náušnice H16-3: a - celkový pohled na náušnici (foto J. Sobek); b - detail, mikrosnímek z rastrovacího elektronového mikroskopu (zobrazení SE, snímek D. Janová); c - detail, mikrosnímek z rastrovacího elektronového mikroskopu (zobrazení SE, snímek D. Janová); d - oblast s pájkou mezi granulací (foto E. Ottenwelter); e - detail (foto E. Ottenwelter); f - detail dokumentující dva vytepané polopláště spájené dohromady (foto E. Ottenwelter); g - detail granulace na hřbetě zvířete (foto E. Ottenwelter).

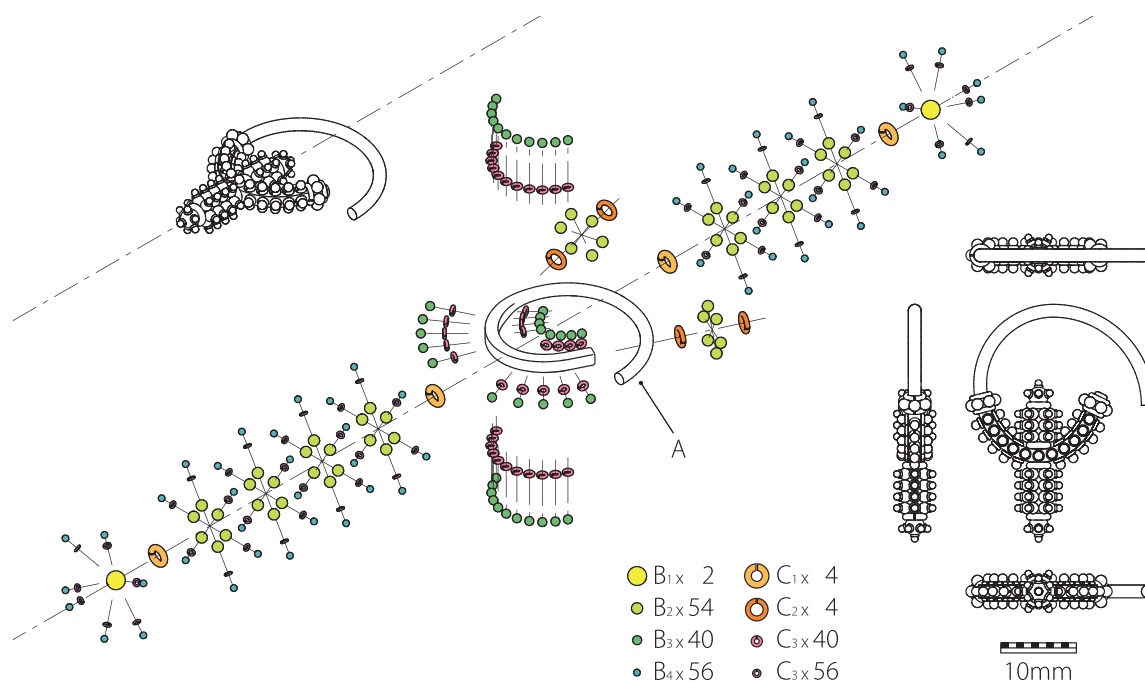

Fig. 4/27: Earring H115-14: exploded view: A - central wire; B₁ - big granules; B₂ - granules forming the rings of granules; B₃ - granules decorating the lower arch; B₄ - granules decorating the grapes; C₁ - rings placed between the grapes and lower arch and between the grapes and big granules; C₂ - rings forming the elbows; C₃ - filigree rings on central wire; C₄ - filigree ring decorating the grapes (drawing G. Plítková).

Obr. 4/27: Náušnice H115-14: schématické znázornění jednotlivých komponent rozložené sestavy náušnice: A – středový drát; B₁ – velké granule; B₂ – granule tvořící věnečky; B₃ – granule zdobící spodní oblouk; B₄ – granule zdobící hrozničky; C₁ – kroužky umístěné mezi hrozničky a spodní oblouk a mezi hrozničky a velké granule; C₂ – kroužky tvořící uzlíky na spodním oblouku; C₃ – filigránové kroužky na středovém drátu; C₄ – filigránové kroužky zdobící hrozničky (kresba G. Plítková).

4.4.1.1.1. Earring H115-14

This earring was found in a grave where a wealthy girl of approximately fourteen years was buried. Graves goods included ten other silver grape-shaped earrings, a pair of silver *gombiky*, a pair of gilded copper *gombiky*, and a knife (Frolík - Smetánka 2014, p. 186-190).

Description of grape-shaped earring H115-14 (Figs. 4/27, 4/28)

The earring is constructed on a central round-sectioned wire of 1.5 mm in diameter, hammered into a square-sectioned wire on the lower arch (Fig. 4/27-A). The lower arch is decorated on each side by a row of granules (Fig. 4/27-B₃) of 1.2 mm in diameter sitting in a filigree ring (Fig. 4/27-C₃) made with a wire of 0.2 mm in diameter (Fig. 4/28 b). Each end of the lower arch is decorated by an elbow comprising a ring of six granules of 1.6 mm in diameter (Fig. 4/27-B₂) between two smooth round-sectioned wire rings (Fig. 4/27-C₁) of 0.7 mm in diameter. Top and bottom grapes comprise stacked rings of granules (Fig. 4/27-B₂) topped by a big granule (Fig. 4/27-B₁) sitting in a filigree ring (Fig. 4/27-C₁) and decorated by five smaller granules (Fig. 4/27-B₄) of 0.7 mm in diameter sitting on a small filigree ring (Fig. 4/27-C₄). Both top and bottom grapes sit on a ring (Fig. 4/27-C₁) and are vertically soldered onto the central wire. A total of four wires with different diameters were used to manufacture the central wire of the earring and different filigree rings decorating the earring (1.5 - 0.2 - 0.1 - 0.7 mm). Four sizes of granules had to be manufactured to complete the earring (0.7 - 1.2 - 1.6 - 2.6 mm). A total of nine different kinds of components had to be manufactured to form this type of earring.

Earring H115-14		Dimensions [mm]
Total length of the earring		29
Central wire (A)	Ø	1.5
Granule on central wire (B ₃)	Ø	1.2
Granule in elbow (B ₂)	Ø	1.6
Small granules on grapes (B ₄)	Ø	0.7
Big granule on top grape (B ₁)	Ø	2.6
Filigree wire on central wire (C ₃)	Ø	0.2
Filigree ring wire surrounding grape small granules (C ₄)	Ø	0.1
Filigree ring wire on which is sitting big top granule (C ₁)	Ø	0.7
Filigree ring wire of the elbow (C ₁)	Ø	0.7

Table 32: Dimensions of the earring H115-14 and its components.

Tab. 32: Rozměry náušnice H115-14 a jejích částí.

Condition of the earring and quality of the work

The earring is relatively well preserved, although it is heavily etched by past treatment in alkaline cyanides (*Fig. 4/27d*). It is almost complete, but some granules are missing on the lower arch and on the top big granule (*Fig. 4/27-B, 4/28a*). It was covered by a thick layer of tarnish and the remains of aged, smeared adhesive. The earring had to be cleaned before analyses. The earring was perfectly manufactured.

Scanning electron microscopy and microanalysis

Electron microanalysis performed on clean surfaces showed that probably two types of silver alloys were used to manufacture the earring. The central wire, and decorative elements soldered on the lower arch were made from a silver alloy containing approximately 4.5 % of copper while elements composing the grapes were made from a purer silver with about 2 % of copper (Table 33). Pure silver was detected in the case of the decorative granules on grape rings. Analyses on solder areas did not detect a higher content of copper. As often noticed on other earrings, the solder area has a dendritic structure (*Fig. 4/28c*).

Components forming the grape-shaped earring H115-4	Chemical composition [Wt. %]	
	Ag	Cu
Central wire (A)	95.6	4.4
Filigree ring elbow (C ₁)	95.7	4.3
Small filigree ring central wire (C ₃)	95.2	4.8
Granule, central wire (B ₃)	95.7	4.3
Granule, elbow (B ₂)	95.2	4.8
Big granule (B ₁)	98.2	1.8
Granule, ring grape (B ₂)	98	2
Decorative granule on grape rings (C ₄)	100	-
Ring, under and above grape (C ₁)	97.4	2.6
Solder area, fallen filigree ring on central wire	99.1	0.9

Table 33: Chemical composition of the different elements composing the earring H115-4 and solder areas.

Tab. 33: Chemické složení různých částí náušnice H115-4 a složení pájených částí.

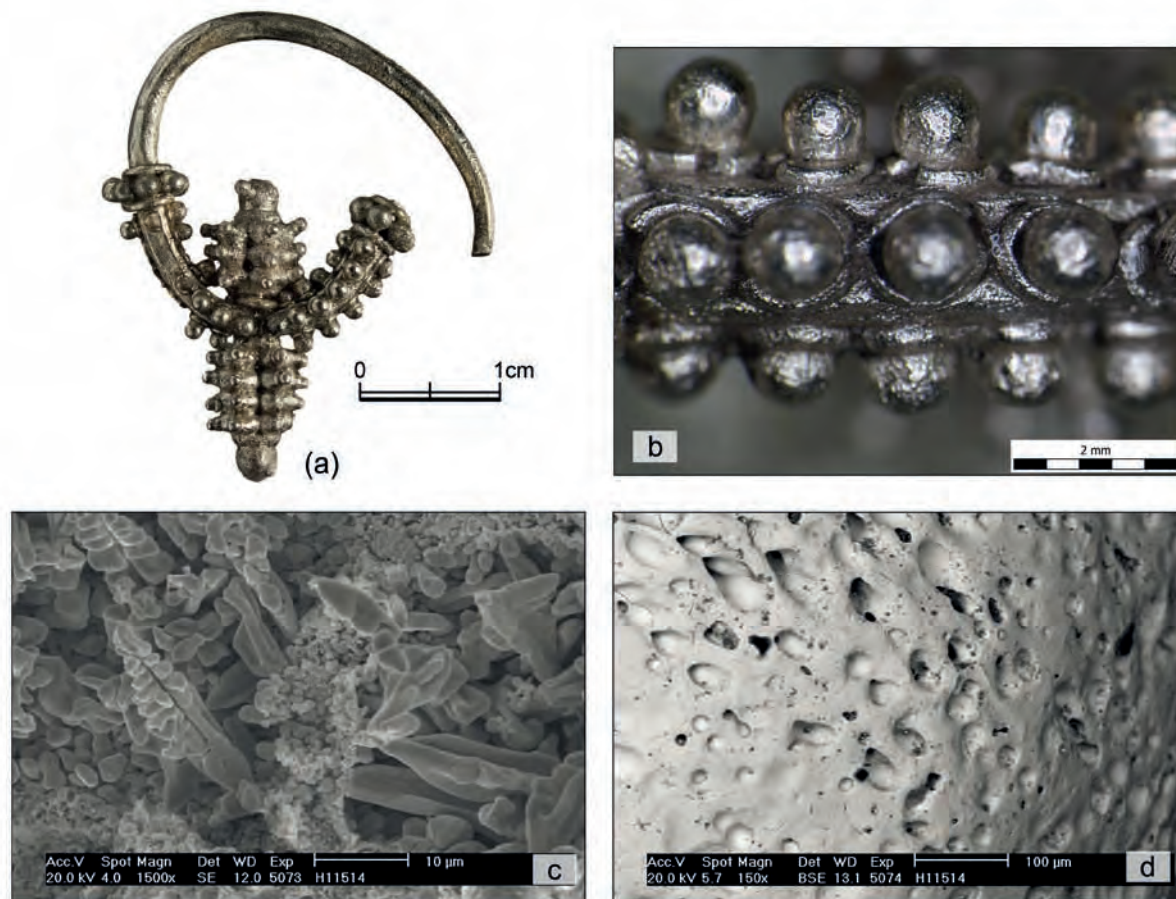

Fig. 4/28: Earring H115-4: a - general view of the earring (photo J. Sobek); b - detail of the granulation work on the lower arch (photo E. Ottenwelter); c - dendritic structure of the solder area, SEM micrograph (SE image, photo D. Janová); d - pitted surface of the top granule resulting from past treatment with alkaline cyanides, SEM micrograph (BSE image, photo D. Janová).

Obr. 4/28: Náušnice H115-14: a - celkový pohled na náušnici (foto J. Sobek); b - detail granulace na spodním oblouku (foto E. Ottenwelter); c - dendritická struktura v oblasti pájky, mikrosnímek z rastrovacího elektronového mikroskopu (zobrazení SE, snímek D. Janová); d - důlkovitý povrch na vrcholu granule - následek předchozího čištění alkalickými kyanidy, mikrosnímek z rastrovacího elektronového mikroskopu (zobrazení BSE, snímek D. Janová).

4.4.1.1.2. Earring H84-3

This earring belonged to a three-year-old child who was buried with very prestigious grave goods. In total, grave goods included five silver grape-shaped earrings, a pair of gilded copper alloy *gombiky*, two silver S-shaped temple rings, a bronze ring, a knife, and a necklace made of semi-precious and glass beads (Frolík - Smetánka 2014, p. 152-154).

Description (Fig. 4/29)

This earring has the same construction as the previous one, but decorative elements on the central wire are of reduced size. Granules placed on the lower arch are only of 0.5 mm in diameter while the filigree rings on which they sit are manufactured with a wire of 0.1 mm in diameter. The other difference is the way the top and bottom grapes are fixed to the lower arch. Here a clamp (Fig. 4/29b) made of a folded, metallic strip first enters one grape, surrounds the central wire, and finally enters the second grape. The clamp is decorated with two granules sitting in a filigree ring (Fig. 4/29b). The earring is made of eight different components (four wires of different diameters, three types of granule with different diameters, and a strip of metal folded in two).

Condition of the earring and quality of the work

The earring is almost complete (Fig. 4/29a). A few decorative granules are missing on the top and bottom grape (Fig. 4/29b) as well as the big granule on the top grape. The surface is heavily etched by previous chemical treatment (Fig. 4/29c, d). The granules are not precisely placed (Fig. 4/29b). The

earring is not well proportioned. The size of the elbow filigree rings and granules on the lower arch as well as the granule forming the grapes are too small for the total size of the earring. The quality of the work is rather low.

Scanning electron microscopy and microanalysis

Electron microanalysis performed on clean surfaces showed that two types of silver alloys were probably used to manufacture the earring. The central wire, and decorative elements soldered on the lower arch are made from silver with around 3.5 % of copper while the clamp was made with silver with a slightly higher content of copper (4.6 %) (Table 35).

Earring H84-3		Dimensions [mm]
Total length of the earring		30.6
Central wire	Ø	1.4
Granule on central wire	Ø	0.5
Granule in elbow	Ø	1
Small granules on grapes	Ø	0.5
Big granule on top grape	Ø	2.2
Filigree wire on central wire	Ø	0.2
Filigree ring wire surrounding grape small granules	Ø	0.1
Filigree ring wire on which is sitting big top granule	Ø	0.5
Filigree ring wire of the elbow	Ø	0.5
Clamp	width	0.9

Table 34: Dimensions of the earring H84-3 and its components.

Tab. 34: Rozměry jednotlivých částí náušnice H84-3.

Components forming the grape-shaped earring H84-3	Chemical composition [Wt. %]	
	Ag	Cu
Central wire, point 1	96.6	3.4
Filigree ring elbow, point 2	96.3	3.7
Granule elbow, point 3	96.9	3.1
Big filigree ring on grape, point 4	96.3	3.7
Granule central wire, point 5	96.5	3.5
Small filigree ring central wire, point 6	96.9	3.1
Big granule, point 7	96.6	3.4
Decorative granule on grape rings, point 8	97.1	2.9
Clamp, point 9	95.4	4.6

Table 35: Chemical composition of the different elements composing the earring H84-3 and solder areas.

Tab. 35: Chemické složení různých částí náušnice H84-3 a složení pájených částí.

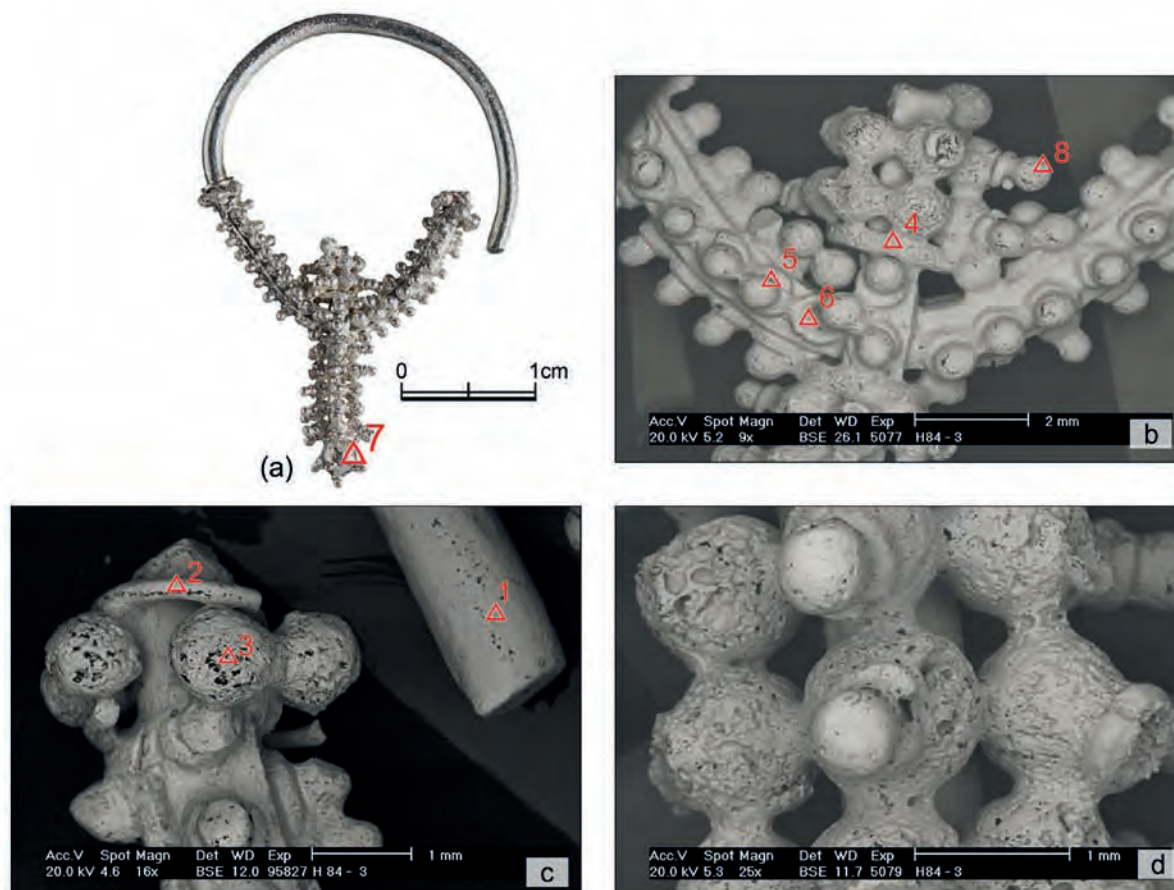

Fig. 4/29: Earring H84-3: a - general view of the earring (photo J. Sobek); b - analysed components, SEM micrograph (BSE image, photo. D. Janová); c - analysed components, SEM micrograph (BSE image, photo. D. Janová); d - pitted surface of granules resulting from past treatment with alkaline cyanides, SEM micrograph (BSE image, photo. D. Janová).

Obr. 4/29: Náušnice H84-3: a - celkový pohled na náušnici (foto J. Sobek); b - mikrosnímek z rastrovacího elektronového mikroskopu (zobrazení BSE) s vyznačením míst bodové mikroanalýzy jednotlivých komponent (snímek D. Janová); c - mikrosnímek z rastrovacího elektronového mikroskopu (zobrazení BSE) s vyznačením míst bodové mikroanalýzy jednotlivých komponent (snímek D. Janová); d - důlkovitý povrch granulí - následek předchozího čištění alkalickými kyanidy, mikrosnímek z rastrovacího elektronového mikroskopu (zobrazení BSE, snímek D. Janová).

4.4.1.1.3. Earring H89-3

This small size earring was recovered in grave H89 where was a woman buried with three other similar silver grape-shaped earrings, a knife, and a silver bead. It weighs less than 1g (0.6 g) which is much less than earring H115-14, which weighs about 4 g, or earring H84-3, which weighs about 2.5 g.

Description (Fig. 4/30)

The construction is basically the same as previous earrings from this type, but here again, a clamp of metal (Fig. 4/30b) links top and bottom grapes around the lower arch as was the case with earring H84-3. The clamp surface was left plain and was not decorated by granules (Fig. 4/30b). Furthermore, the elbows (Fig. 4/30d) only have one ring of plain round-sectioned wire instead of two. The earring is much smaller than previous ones (Fig. 4/30a). Its total length is 20.6 mm. It is made with components of smaller size too (Table 36). Granules of 0.4 mm in diameter are sitting in filigree rings of 0.1 mm in diameter, while the central wire has a diameter of 0.8 mm. Three kinds of wires of different diameters as well as four different size of granules were used to manufacture the earring. On the whole, eight different kinds of elements were used to manufacture the earring.

Condition of the earring and quality of the work

The earring is almost complete, though decorative granules on the top and bottom big granules are missing (Fig. 4/30a). It is heavily etched by previous chemical treatment (Fig. 4/30e).

The quality of the earring is very good considering the size of the components soldered, although defects are visible on SEM micrograph (BSE image - Fig. 4/30b).

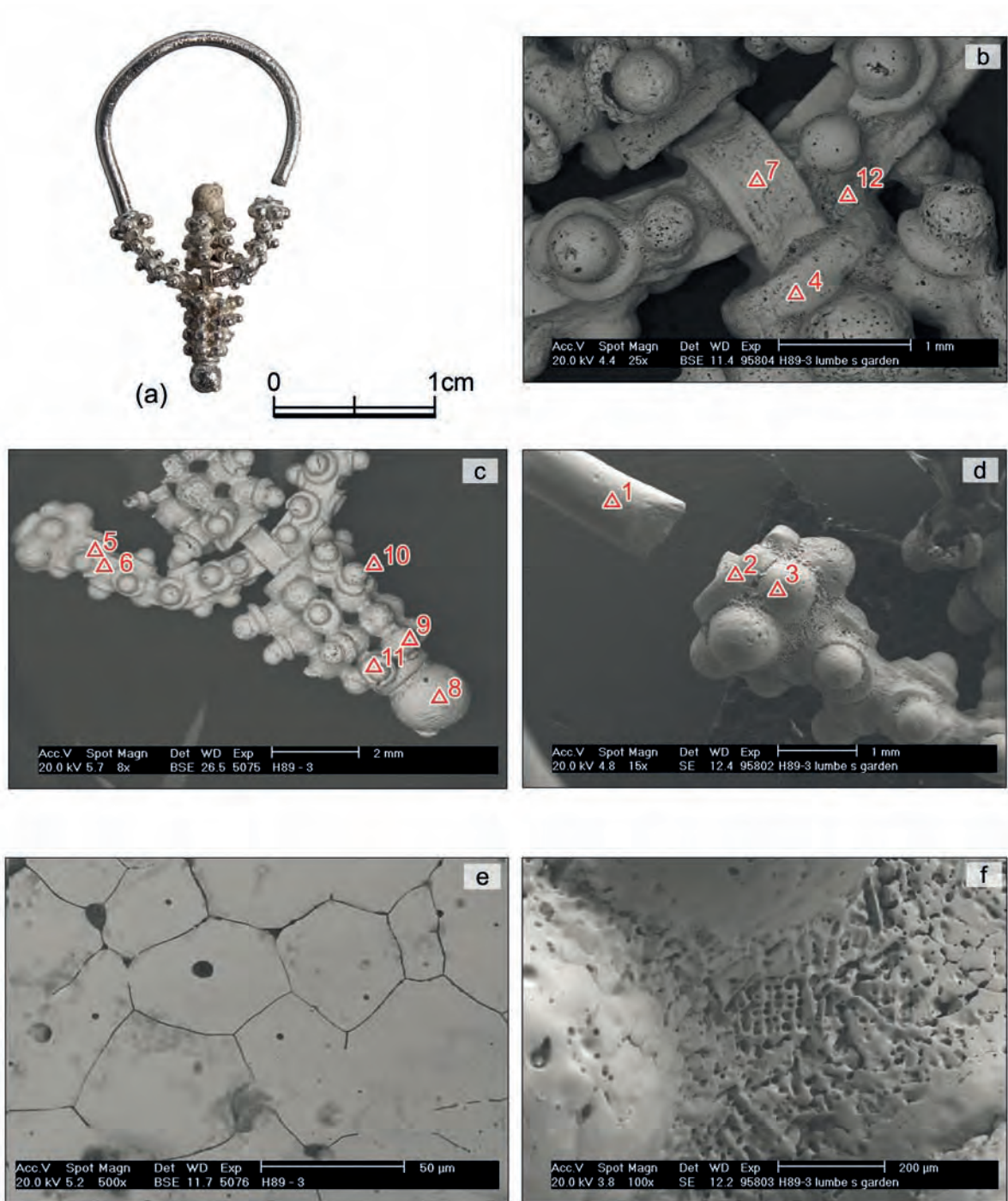

Fig. 4/30: earring H89-3: a - general view of the earring (photo J. Sobek); b - analysed components, SEM micrograph (BSE image, photo. D. Janová); c - analysed components, SEM micrograph (BSE image, photo. D. Janová); d - analysed components, SEM micrograph (SE image, photo. D. Janová); e - heavily etched surface due to past chemical treatment, SEM micrograph (BSE image, photo. D. Janová); f - dendritic structure of the soldered area SEM micrograph (SE image, photo. D. Janová).

Obr. 4/30: Náušnice H89-3: a - celkový pohled na náušnici (foto J. Sobek); b - mikrosnímek z rastrovacího elektronového mikroskopu (zobrazení BSE) s vyznačením míst bodové mikroanalýzy jednotlivých komponent (snímek D. Janová); c - mikrosnímek z rastrovacího elektronového mikroskopu (zobrazení BSE) s vyznačením míst bodové mikroanalýzy jednotlivých komponent (snímek D. Janová); d - mikrosnímek z rastrovacího elektronového mikroskopu (zobrazení SE) s vyznačením míst bodové mikroanalýzy jednotlivých komponent (snímek D. Janová); e - silně naleptaný povrch v důsledku předchozího chemického čištění, mikrosnímek z rastrovacího elektronového mikroskopu (zobrazení BSE, snímek D. Janová); f - dendritická struktura pájené oblasti, mikrosnímek z rastrovacího elektronového mikroskopu (zobrazení SE, snímek D. Janová).

Earring H89-3		Dimensions [mm]
Total length of the earring		20.6
Central wire	Ø	0.8
Granule on central wire	Ø	0.4
Granule in elbow	Ø	0.6
Small granules on grapes	Ø	0.4
Big granule on top grape	Ø	1.8
Granule forming rings of the grape	Ø	0.8
Filigree wire on central wire	Ø	0.1
Filigree ring wire surrounding grape small granules	Ø	0.1
Filigree ring wire on which is sitting big top granule	Ø	0.3
Filigree ring wire of the elbow	Ø	0.3
Clamp	width	0.6

Table 36: Dimensions of the earring H89-3 and its components.

Tab. 36: Rozměry jednotlivých částí náušnice H89-3.

Scanning electron microscopy and microanalysis

Electron microanalysis performed on the surface of the earring (*Fig. 4/30b, c, d*) showed the majority of the different components of the earrings were manufactured from an identical binary Ag-Cu alloy containing from 1.9 to 2.6 % of copper (Table 37). The alloy used to manufacture the clamp and the small filigree rings on the grape contain more copper - almost 4 %. The alloy used to manufacture the granules forming the rings of the grape as well as the big top and bottom granules contain less copper (1.6 %). A higher content of copper was detected in the solder area between the clamp and the lower arch showing that copper was added to lower the melting point temperature of the soldered material. The solder area has a dendritic structure (*Fig. 4/30f*).

Components forming the grape-shaped earring H89-3	Chemical composition [Wt. %]	
	Ag	Cu
Central wire, point 1	97.8	2.2
Filigree ring from the elbow, point 2	97.5	2.5
Granule from the elbow, point 3	97.9	2.1
Filigree ring under and above grape, point 4	97.4	2.6
Small granule on lower arch, point 5	98	2
Filigree ring on lower arch, point 6	97.5	2.5
Clamp, point 7	96.1	3.9
Big bottom granule, point 8	98.3	1.7
Granule forming the rings of the grape, point 9	98.4	1.6
Small granule decorating rings of the grape, 10	98.1	1.9
Small filigree under small granule, grape, point 11	96.3	3.7
Solder area between clamp and lower arch, 12	91.7	8.3

Table 37: Chemical composition of the different element composing the earring H89-3 and solder area.

Tab. 37: Chemické složení náušnice H89-3 a složení pájených částí.

4.4.1.1.4. Double-sided grape-shaped earrings with slightly twisted lower arch decorated with beaded wires.

This type of earring represents a single specimen retrieved from grave H84 where a ten-year-old girl was buried along with five other silver grape-shaped earrings, a pair of S-shaped temple rings, a copper alloy ring, a knife, and a necklace of glass and semi-precious stones beads (Frolík - Smetánka 2014, p. 152-154).

Description of the grape-shaped earring H84-5

The earring is formed on a central round-sectioned wire of 0.8 mm in diameter hammered into a square-sectioned wire and slightly twisted on the lower arch (Fig. 4/31a). Two elbows comprising a ring of six granules of 1mm in diameter and threaded on the main wire between two rings of round-sectioned wires of 0.3 mm in diameter are placed at the ends of the lower arch. The lower arch is decorated with four beaded wires soldered on each of its sides (Fig. 4/31d). The grapes are formed with rows of rings of granules of 0.9 mm in diameter decorated by a small granule of 0.6 mm in diameter sitting in a filigree ring made with a wire of 0.3 mm in diameter (Fig. 4/31b). The bottom grape has four rows of granule rings while top grape has three of them (Fig. 4/30a). Both grapes are topped by big filigree rings in which a bigger granule (2 mm of diameter) is sitting, itself decorated by five smaller granules sitting in a small filigree ring (Fig. 4/31b). Top and bottom grapes are soldered on the lower arch. Four different type of wires and four different sizes of granules were used to manufacture the earring. On the whole, nine different types of components were used to manufacture the earring.

Earring H84-5		Dimensions [mm]
Total length of the earring		26.3
Central wire, upper arch	Ø	0.8
Beaded wire on lower arch	Ø	0.5
Granule in elbow	Ø	1
Small granules on grapes	Ø	0.6
Big granule on top grape	Ø	2
Granule forming rings of the grape	Ø	0.9
Filigree ring wire surrounding grape small granules	Ø	0.3
Filigree ring wire on which is sitting big top granule	Ø	0.4
Filigree ring wire of the elbow	Ø	0.3

Table 38: Dimensions of the earring H84-5 and its components.

Tab. 38: Rozměry jednotlivých částí náušnice H84-5.

Condition of the earring and quality of the work

The earring is almost complete. A small granule sitting in a small filigree ring is missing from the top big granule on the top grape (Fig. 4/31a). The surface is heavily etched by previous chemical treatment - soldered areas in particular (Fig. 4/31e, f).

The overall quality of the earring is excellent.

Scanning electron microscopy and microanalysis

Electron microanalysis performed on the surface of the earring (Fig. 4/31a, b, c, d) showed that the different components of the earring were manufactured from silver with an average of 4 % of copper (Table 39). The material used to manufacture the big granule and the small filigree ring on the grape exhibits a slightly higher content of copper.

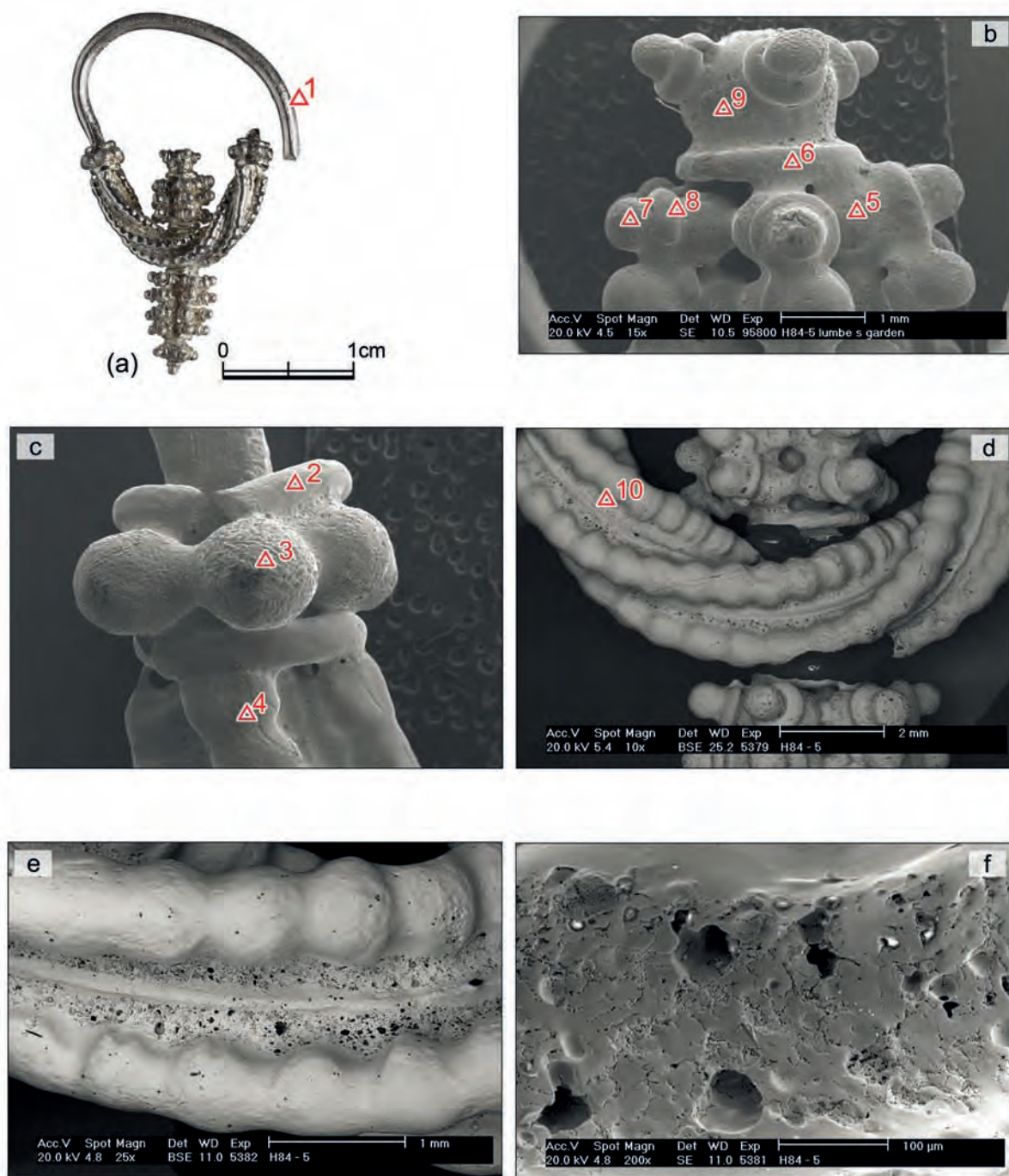

Fig. 4/31: Earring H84-5: a - general view of the earring (photo J. Sobek); b - analysed components, SEM micrograph (SE image, photo D. Janová); c - analysed components, SEM micrograph (SE image, photo D. Janová); d - analysed component, SEM micrograph (BSE image, photo D. Janová); e - solder area between the beaded wires and the central wire, SEM micrograph (BSE image, photo D. Janová); f - pitted solder area, SEM micrograph (SE image, photo D. Janová).

Obr. 4/31: Náušnice H84-5: a - celkový pohled na náušnici (foto J. Sobek); b - mikrosnímek z rastrovacího elektronového mikroskopu (zobrazení SE) s vyznačením míst bodové mikroanalýzy jednotlivých komponent (snímek D. Janová); c - mikrosnímek z rastrovacího elektronového mikroskopu (zobrazení SE) s vyznačením míst bodové mikroanalýzy jednotlivých komponent (snímek D. Janová); d - mikrosnímek z rastrovacího elektronového mikroskopu (zobrazení BSE) s vyznačením místa bodové mikroanalýzy (snímek D. Janová); e - oblast spájení perlovcových drátů a centrálního drátu, mikrosnímek z rastrovacího elektronového mikroskopu (zobrazení BSE, snímek D. Janová); f - důlky v oblasti pájky, mikrosnímek z rastrovacího elektronového mikroskopu (zobrazení SE, snímek D. Janová).

Components forming the grape-shaped earring H84-5	Chemical composition [Wt. %]	
	Ag	Cu
Central wire, point 1	96.4	3.6
Filigree ring elbow, point 2	96	4
Granule, elbow, point 3	96.6	3.4
Beaded wire, point 4	96.3	3.7
Granule, grape ring, point 5	96.3	3.7
Big filigree ring grape, point 6	96	4
Small granule, grape, point 7	96.1	3.9
Small filigree ring grape, point 8	95.3	4.7
Big granule, point 9	95.2	4.8
Solder area, point 10	93.6	6.4

Table 39: Chemical composition of the different elements composing the earring H84-5 and solder areas.

Tab. 39: Chemické složení různých částí náušnice H84-5 a složení pájených částí.

4.4.1.1.5 Double-sided grape-shaped earrings with two-layered rows of granules and plain wire on the lower arch

This variant of grape-shaped earring represents one specimen recovered in grave H115.

Description of the grape-shaped earring H115-1 (*Fig. 4/32*)

This type of earring is differentiating from the standard type of this kind of earring by the decoration of its lower arch. Here, each side of the square-sectioned lower arch wire is decorated by a row of granules between two plain straight wires, topped by a second layer of smaller granules sitting in a small filigree wire (*Fig. 4/32a, b, c*). The top grape is made of four stacked rings of granules while the bottom grape must have count five rings originally. Both grapes were topped by a big granule sitting on a ring and decorated by five small granules in a filigree ring. Four different diameters of granules were used and three types of wires. A total of eight different kinds of components were used to manufacture the earring.

Earring H115-1		Dimensions [mm]
Preserved length of the earring		26.5
Central wire, upper arch	Ø	1.7
Wire on lower arch	Ø	0.4
Big granule top grape	Ø	2
Granule from the elbow	Ø	1.3
Medium granule composing first row	Ø	0.8
Small granule composing second row	Ø	0.6
Elbow ring wire	Ø	0.4
Filigree ring wire under small granules	Ø	0.2
Ring's wire at ends of each grape	Ø	0.4

Table 40: Dimensions of the earring H115-1 and its components.

Tab. 40: Rozměry jednotlivých částí náušnice H115-1.

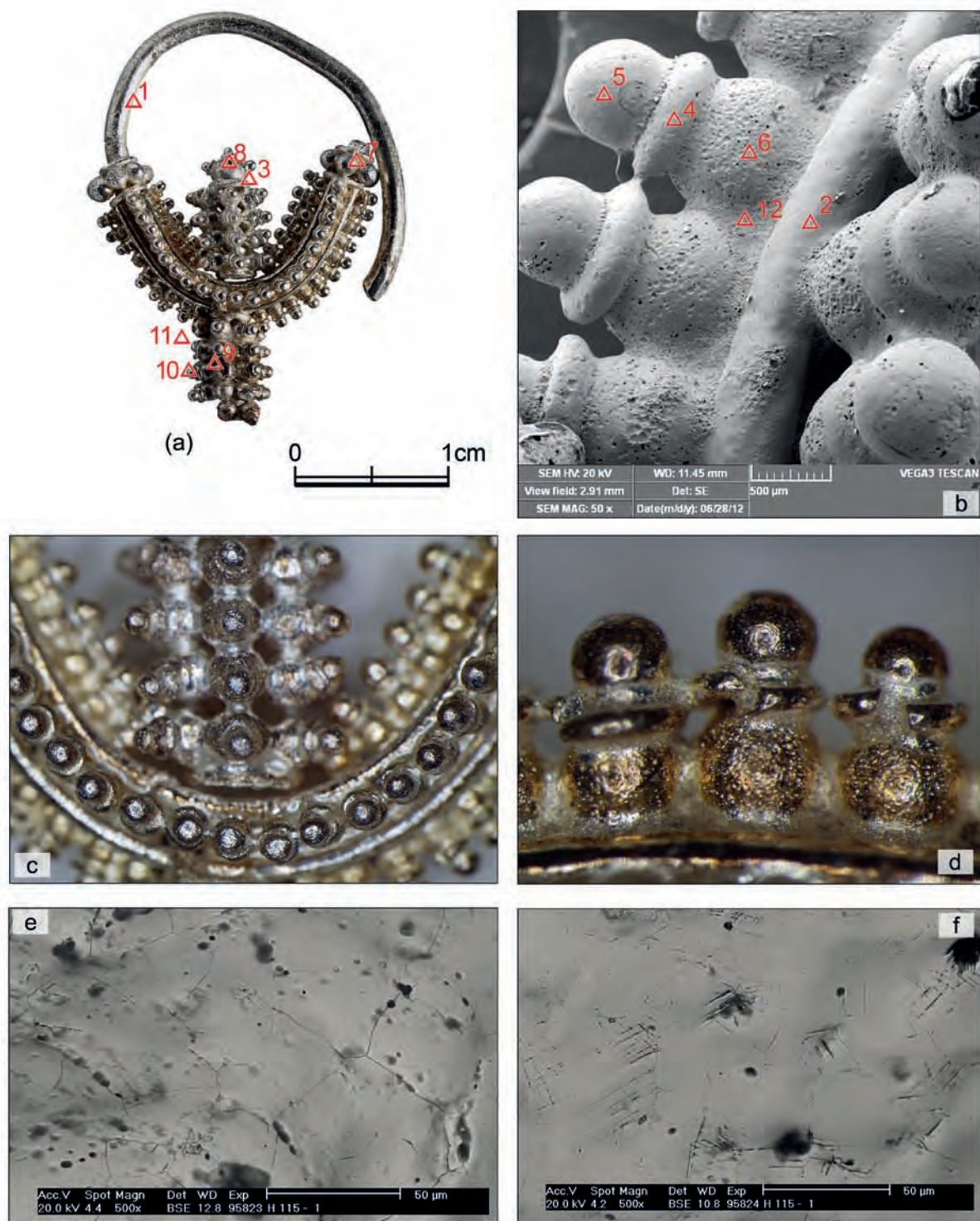

Fig. 4/32: Earring H115-1: a - general view of the earring (photo J. Sobek); b - analysed components, SEM micrograph (SE image, photo J. Děd); c - detail of the granulation work (photo E. Ottenwelter); d - detail of the two rows of granulation work stacked on the lower arch (photo E. Ottenwelter); e - etched surface by past chemical treatment, SEM micrograph (BSE image, photo D. Janová); f - etched surface revealing microstructure of the metal, SEM micrograph (BSE image, photo D. Janová).

Obr. 4/32: Náušnice H115-1: a - celkový pohled na náušnici (foto J. Sobek); b - mikrosnímek z rastrovacího elektronového mikroskopu (zobrazení SE) s vyznačením míst bodové mikroanalýzy jednotlivých komponent (snímek J. Děd); c - detail granulace (foto E. Ottenwelter); d - detail dvou řad granulí vyskládaných ve dvou patrech na centrálním drátu (foto E. Ottenwelter); e - naleptaný povrch v důsledku předchozího chemického čištění, mikrosnímek z rastrovacího elektronového mikroskopu (zobrazení BSE, snímek D. Janová); f - mikrostruktura kovu, patrná na naleptaném povrchu, mikrosnímek z rastrovacího elektronového mikroskopu (zobrazení BSE, snímek D. Janová).

Condition of the earring and quality of the work

The earring is almost complete except for the bottom grape which has lost part of its last granule ring and the big granule.

The earring was tarnished. It was interesting to notice that the granules of the first row decorating the lower arch were tarnished in a different way than the other elements composing the earring (*Fig. 4/32d*). The results of analyses evidenced that they were manufactured with a different silver alloy than the other elements that contained more copper. The resulting tarnish layer was, therefore, also different because of the presence of more copper sulphides. The surface of the earring is heavily etched by past treatment. Coarse equiaxed recrystallized grains as well as twinned grains and strain lines are visible (*Fig. 4/32e, f*).

The quality of the earring is very high. The different components are very successfully placed and soldered together without flooding and movement having displaced the granules. The size of the granules and filigree rings are very regular for each kind of components. This earring is a masterpiece.

Scanning electron microscopy and microanalysis

Electron microanalysis performed on the surface of the earring (*Fig. 4/32a, b*) showed that almost all of the different components of the earrings were manufactured from a silver alloy containing approximately 97 % of silver and 3 % of copper except granules from the first row and granules forming the grape ring which have a higher content of copper (4 %) (Table 41). The solder area evidenced a slightly higher percentage of copper.

Components forming the grape-shaped earring H115-1	Chemical composition [Wt. %]	
	Ag	Cu
Central wire (point 1)	97.3	2.7
Straight decorative wire on lower arch (point 2)	97	3
Grape big ring wire (point 3)	97	3
Filigree ring wire under second row granules (point 4)	96.8	3.2
Small granule, second row (point 5)	97.3	2.7
Granule from first row (point 6)	96	4
Granule, elbow (point 7)	96.7	3.3
Big granule (point 8)	97.5	2.5
Granule from grape ring (point 9)	96.1	3.9
Small filigree ring, grape (point 10)	97.4	2.6
Small granule, grape (point 11)	97.5	2.5
Solder area (point 12)	94.1	5.9
Solder area between grape granule and filigree	93	7

Table 41: Chemical composition of the different element composing the earring H115-1 and solder areas.

Tab. 41: Chemické složení různých částí náušnice H115-1 a složení pájených částí.

4.4.1.1.6. Double-sided grape-shaped earrings with beaded wires decoration on the lower arch

This subgroup of grape-shaped earrings is represented by a single specimen found in grave H84.

Description of the earring H84-8b (Fig. 4/33)

This type of earring is distinguished from the other grape-shaped earring types by the decoration of the lower arch. The hammered square-sectioned wire is decorated on each of its sides by a beaded wire of 0.6 mm in diameter (Fig. 4/33b). Top and bottom grapes are fixed on the lower arch with a clamp of 0.7 mm in width (Fig. 4/33d). The lower grape is composed of four rows of granule rings while the top grape has three of them (Fig. 4/33a). Three sizes of granules were used. Granules to manufacture the grape rings and elbows are of 1.2 mm in diameter while small granules on the grape rings are of 0.5 mm in diameter and the big granule topping the grapes are of 2 mm in diameter. Four kinds of wires were used to manufacture the earring. The rings from the elbows which top the grapes were manufactured from a smooth round-sectioned wire of 0.4 mm, while the central wire is made with a smooth round-sectioned wire of 0.9 mm in diameter. The filigree rings in which small granules sit are made from a round sectioned wire of 0.1 mm in diameter. Finally, beaded wire of 0.6 mm in diameter were used to decorate the lower central arch. On the whole, nine different kinds of components were used in the manufacture of this earring.

Earring H84-8b		Dimensions [mm]
Preserved length of the earring		26
Central wire	Ø	0.9
Filigree ring elbow	Ø	0.4
Granule, elbow	Ø	1.2
Beaded wire	Ø	0.6
Granule, grape ring	Ø	1.2
Small granule on ring	Ø	0.5
Small filigree ring on grape	Ø	0.1
Big filigree ring on grape	Ø	0.4
Big granule on grape	Ø	2
Clamp	width	0.7

Table 42: Dimensions of the earring H84-8b and its components.

Tab. 42: Rozměry jednotlivých částí náušnice H84-8b.

Condition of the earring and quality of the work

The earring is almost complete, though a few granules are missing from the top granule as well as the grape rings (Fig. 4/33a). It was tarnished and had to be cleaned before analyses. The surface is heavily etched by previous restoration treatments (Fig. 4/33b, d).

The quality of the work is high. The different components were successfully soldered without flooding.

Scanning electron microscopy and microanalysis

Electron microanalyses performed on the surface of the earring (Fig. 4/33a, b, d) showed that almost all different components of the earrings were manufactured from a binary Ag-Cu alloy containing approximately from 2.5 to 3 % of copper apart from a granule from the elbow, which exhibits a lower content of copper (1.5 %). The solder area (Fig. 4/33c) analysed on the lower arch between a beaded wire and the main wire exhibited a higher content of copper (Table 43).

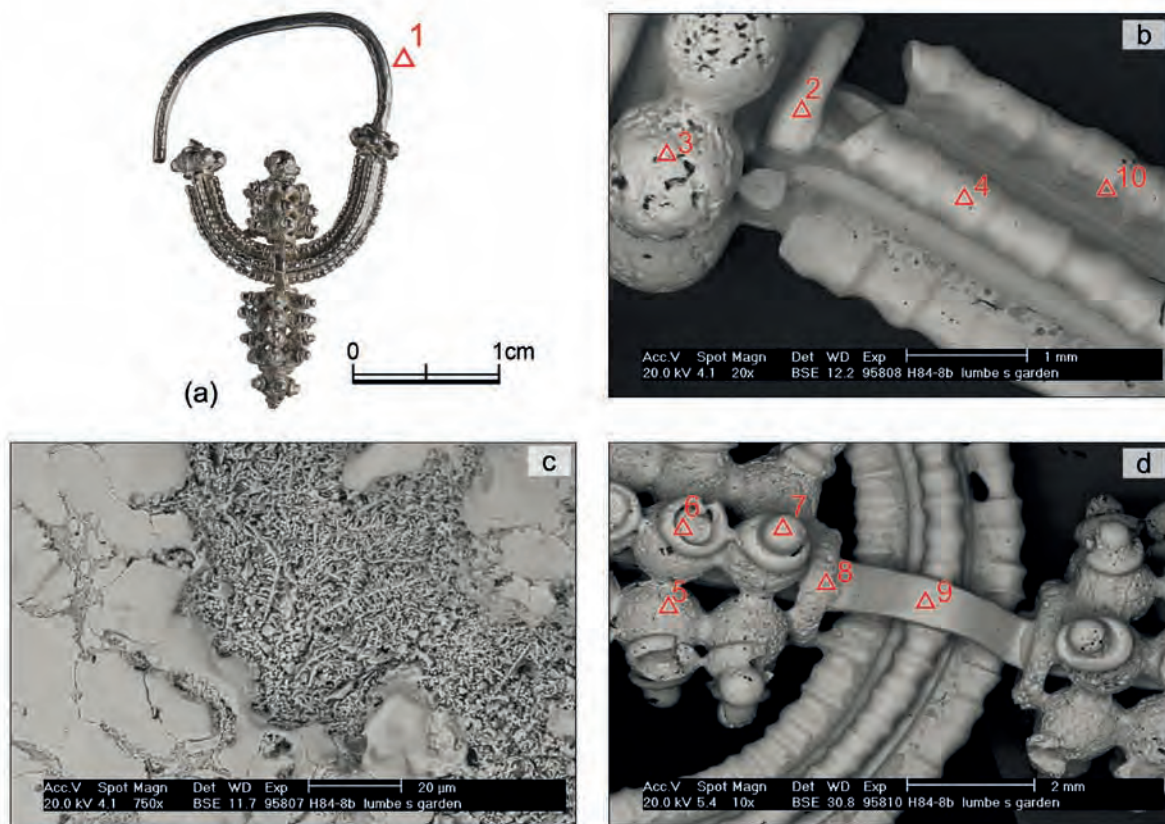

Fig. 4/33: Earring H84-8b: a - general view of the earring (photo J. Sobek); b - analysed components, SEM micrograph (BSE image, photo D. Janová); c - dendritic structure in the solder area, SEM micrograph (BSE image, photo D. Janová); d - analysed components, SEM micrograph (BSE image, photo D. Janová).

Obr. 4/33: Náušnice H84-8b: a - celkový pohled na náušnici (foto J. Sobek); b - mikrosnímek z rastrovacího elektronového mikroskopu (zobrazení BSE) s vyznačením míst bodové mikroanalýzy jednotlivých komponent (snímek D. Janová); c - dendritická struktura v oblasti pájky, mikrosnímek z rastrovacího elektronového mikroskopu (zobrazení BSE, snímek D. Janová); d - mikrosnímek z rastrovacího elektronového mikroskopu (zobrazení BSE) s vyznačením míst bodové mikroanalýzy jednotlivých komponent (snímek D. Janová).

Components forming the grape-shaped earring H84-8b	Chemical composition [Wt. %]	
	Ag	Cu
Central wire, point 1	97.2	2.8
Elbow ring wire, point 2	98.5	1.5
Elbow granule, point 3	97.7	2.3
Beaded wire, point 4	97.5	2.5
Granule forming grape rings, point 5	97.2	2.8
Filigree ring on grape's ring, point 6	97.3	2.7
Small granule on ring's grape, point 7	97.3	2.7
Ring under grape, point 8	97	3
Clamp, point 9	97.3	2.7
Solder area between beaded wires and main wire, 10	93.6	6.4

Table 43: Chemical composition of the different element composing the earring H84-8b and solder area.

Tab. 43: Chemické složení jednotlivých částí náušnice H84-8b a složení pájených částí.

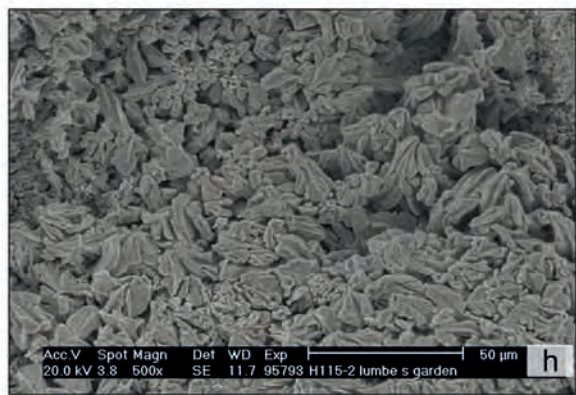
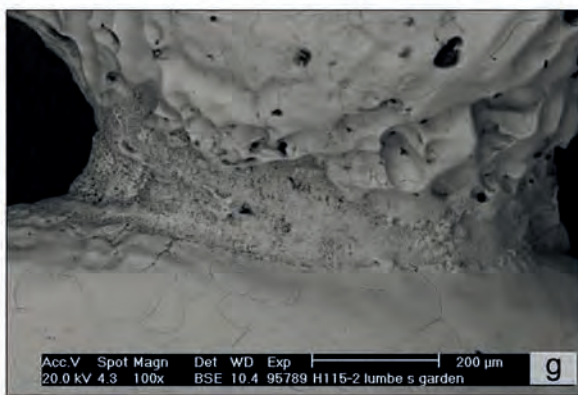
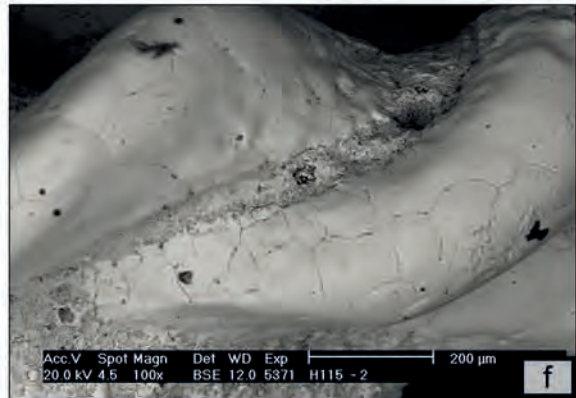
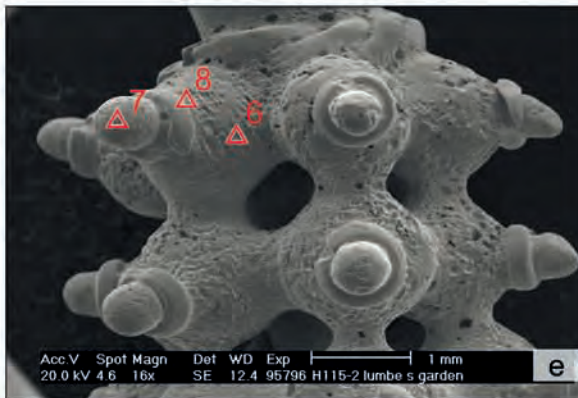
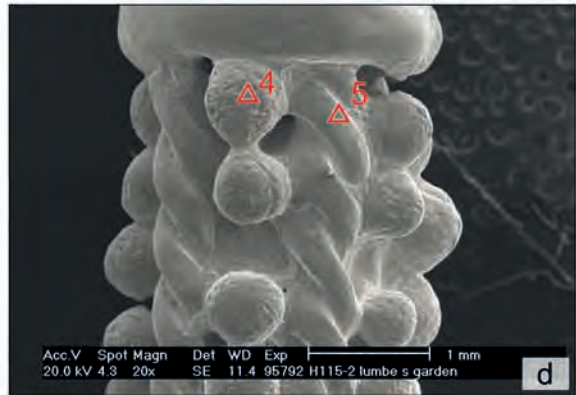
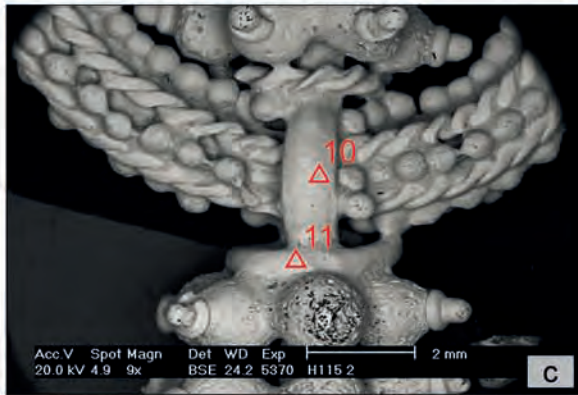
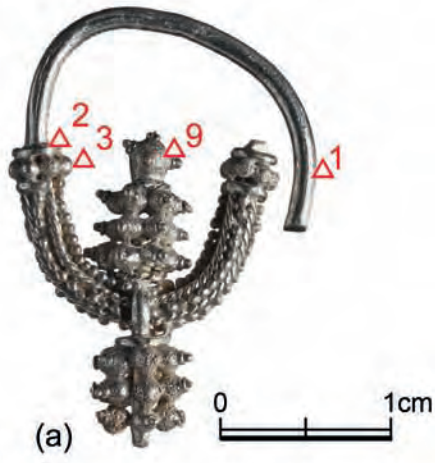

4.4.1.1.7. Double-sided grape-shaped earrings with decoration of lines of granules and double twisted wires on the lower arch.

This variant of grape-shaped earring represents three specimens: two coming from grave H115 (H115-2, H115-15) and a small-size earring coming from grave H84 (H84-8b).

Description of grape-shaped earring H115-2 (Fig. 4/34)

This type of grape-shaped earring differs from previous types by the decoration of the lower arch. It is decorated alternately with four rows of granules and four wires made of double-twisted round-section wires (Fig. 4/34b, c, d). Top and bottom grapes are fixed to the lower arch with a clamp (Fig. 4/34c) made of a double strip of half round-sectioned wire of 0.9 mm in width. The top grape ring (Fig. 4/34c) is made of two single round-sectioned wires of 0.3 mm loosely twisted together. The lower grape has a plain, smooth round-sectioned wire ring of 0.5 mm in diameter. The earring was manufactured with three different sizes of wires and four different diameters of granules.

On the whole, nine different kinds of components were used to manufacture this earring.

Earring H115-2		Dimensions [mm]
Preserved length of the earring		26.2
Central wire, upper arch	Ø	1.4
Filigree ring elbow	Ø	0.5
Granule, elbow	Ø	1.2
Small granule on lower arch		0.5
Twisted wire	Ø	0.6 (0.3 single wire)
Granule from rings grape	Ø	1.5
Small granule on ring	Ø	0.5
Small filigree ring on rings	Ø	0.2
Big filigree ring on grape	Ø	0.5
Big granule on grape	Ø	2.5
Clamp	width	0.9

Table 44: Dimensions of the earring H115-2 and its components.

Tab. 44: Rozměry jednotlivých částí náušnice H115-2.

← **Fig. 4/34:** Earring H115-2: a - general view of the earring with analysed points (photo J. Sobek); b - detail of the elbow and alternating row of granules and twisted wire on the central wire (photo E. Ottenwelter); c - detail of the clamp, lower arch decoration, and analysed points, SEM micrograph (BSE image, photo D. Janová); d - analysed components, SEM micrograph (SE image, photo D. Janová); e - analysed points on the grape, SEM micrograph (SE image, photo D. Janová); f - etched twisted wire surface, SEM micrograph (BSE image, photo D. Janová); g - solder area between ring and granule, SEM micrograph (BSE image, photo D. Janová); h - dendritic structure of the soldered area, SEM micrograph (SE image, photo D. Janová).

← **Obr. 4/34:** Náušnice H115-2: a - celkový pohled na náušnici s vyznačením míst bodové mikroanalýzy (foto J. Sobek); b - detail uzlíčku a střídajících se řad granulí a tordovaného drátu na středovém drátu (foto E. Ottenwelter); c - detail poutka a dekorace spodního oblouku s vyznačením míst bodové mikroanalýzy, mikrosnímek z rastrovacího elektronového mikroskopu (zobrazení BSE, snímek D. Janová); d - mikrosnímek z rastrovacího elektronového mikroskopu (zobrazení SE) s vyznačením míst bodové mikroanalýzy jednotlivých komponent (snímek D. Janová); e - vyznačení míst bodové mikroanalýzy na hrozničku, mikrosnímek z rastrovacího elektronového mikroskopu (zobrazení SE, snímek D. Janová); f - naleptaný povrch tordovaného drátu, mikrosnímek z rastrovacího elektronového mikroskopu (zobrazení BSE, snímek D. Janová); g - oblast pájky mezi kroužkem a granulí, mikrosnímek z rastrovacího elektronového mikroskopu (zobrazení BSE, snímek D. Janová); h - dendritická struktura oblasti pájení, mikrosnímek z rastrovacího elektronového mikroskopu (zobrazení SE, snímek D. Janová).

Condition of the earring and quality of the work

The earring is almost complete, though the lower part of the bottom grape is missing. The surface is heavily etched by past treatment (*Fig. 4/34f*).

The manufacture of this earring is of high quality. The different components were successfully soldered together without flooding and with minimum movement of the components.

Scanning electron microscopy and microanalysis

Electron microanalyses performed on different components of the earring (*Fig. 4/34a, c, d, e*) showed that different silver alloys with a small amount of copper were used to manufacture the earring (Table 45). The elbow's ring wire, the lower arch twisted wires, and small filigree ring on the grape have been manufactured with a binary Ag-Cu alloy with approximately 97 % of silver and 3 % of copper. The elbow's granules, granules forming the grape ring, the clamp, and the big ending grape rings were manufactured with a binary Ag-Cu alloy with approximately 3.4 % of copper. Small granules decorating the lower arch were manufactured with a silver alloy containing less copper (2.4 %), while small granules from the grapes and big granules topping the grapes exhibit a higher content of copper with up to 4.7 % of copper. Analyses performed on different solder areas detected only silver. Solder areas exhibit porous dendritic structures (*Fig. 4/34g, h*). We can assume that the less noble phase of the solder area, namely copper, was leached by previous chemical treatment.

Components forming the grape-shaped earring H115-2	Chemical composition [Wt. %]	
	Ag	Cu
Central wire, point 1	96.4	3.6
Elbow ring wire, point 2	97.1	2.9
Elbow granule, point 3	96.7	3.3
Small granule lower arch, point 4	97.6	2.4
Twisted wire, lower arch, point 5	96.9	3.1
Medium granule forming grape, point 6	96.6	3.4
Small granule grape, point 7	95.3	4.7
Small filigree ring, grape, point 8	97.1	2.9
Big granule, point 9	96.1	3.9
Clamp, point 10	96.7	3.3
Smooth big ending grape's ring, point 11	96.6	3.4
Solder areas	100	-

Table 45: Chemical composition of the different element composing the earring H115-2 and solder areas.

Tab. 45: Chemické složení různých částí náušnice H115-2 a složení pájených částí.

4.4.1.1.8. Double-sided grape-shaped earrings on a smooth wire arch

This type of earring is a variant of grape-shaped earring. It is represented by a single specimen retrieved from grave H116A (H116A-1) where a young woman was buried with another double-sided grape-shaped earring on a smooth wire arch but with grapes formed with filigree rings as well as a silver bead and a knife (*Frolík - Smetánka 2014*, p. 190-191).

Description of the earring (H116A-1)

This small size earring (*Fig. 4/35*) has a smooth round-sectioned main wire of 0.7 mm in diameter which was not hammered onto the lower arch and does not bear any decoration except elbows and a top grape attached to the lower arch with a clamp of 0,5 mm in width. The grape consists of plain rings of six granules of 1 mm in diameter topped by a slightly bigger granule (1.5 mm in diameter) sitting in a filigree ring. A total of five different kinds of components were used to manufacture this earring.

Earring H116A-1		Dimensions [mm]
Length of the earring		n. d
Central wire, upper arch	Ø	0.7
Filigree ring elbow wire	Ø	0.3
Granule, elbow	Ø	0.9
Granule from rings grape	Ø	1
Big filigree ring wire on grape	Ø	0.5
Big granule on grape	Ø	1.5
Clamp	width	0.5

Table 46: Dimensions of the earring H116A-1 and its components.

Tab. 46: Rozměry náušnice H116A-1 a jejích částí.

Condition of the earring and quality of the work

The earring is not complete, one elbow is missing (Fig. 4/35). The surface is heavily etched by past chemical cleaning in alkaline cyanides.

The earring is a very simple specimen of grape-shaped earring.

Scanning electron microscopy and micro-analysis

Electron microanalysis performed on the surface of the earring (Fig. 4/35) showed that the different components of the earrings were manufactured from two silver alloys with a small amount of copper (Table 47). The central wire, the elbow granules, and the granule from the grapes and the clamp are made of a silver alloy with about 3.8 to 4.2 % of copper while the filigree ring from the grape and the big granule topping the grape were made from silver with about 2 % of copper.



Fig. 4/35: Earring H116A-1: general view of the earring with analysed points (photo J. Sobek).

Obr. 4/35: Náušnice H116A-1: celkový pohled na náušnici s vyznačením míst bodové mikroanalýzy (foto J. Sobek).

Components forming the grape-shaped earring H116A-1	Chemical composition [Wt. %]	
	Ag	Cu
Central wire, point 1	96.2	3.8
Elbow granule, point 2	96.6	3.4
Filigree ring, grape, point 3	98.2	1.8
Granule, grape, point 4	95.8	4.2
Big granule, grape, point 5	97.8	2.2
Clamp, point 6	95.9	4.1

Table 47: Chemical composition of the different element composing the earring H116A-1 and solder areas.

Tab. 47: Chemické složení různých částí náušnice H116A-1 a složení pájených částí.

4.4.1.2. GILT SILVER GRAPE-SHAPED EARRINGS WITH RICH GRANULATION WORK

This type grape-shaped earring represents only one specimen (H104-14) found in a grave of a two-and-a-half-year-old child buried with two pairs of copper gilded *gombiky*, six silver temple rings with eyelet, a necklace of glass beads, and a knife (*Frolík - Smetánka 2014*, p. 175-176).

Description of grape-shaped earring H104-14 (*Fig. 4/36*)

The earring has the same main construction as the previous types of grape-shaped earrings. It is also constructed on a main wire hammered into a square section on the lower arch. It has two elbows with the same construction as the previous type (*Fig. 4/36a*). The grapes are constructed by plain rings of granules and are not decorated by smaller granules sitting in a filigree ring (*Fig. 4/36c*). The lower arch is decorated by four twisted double wires of round-sectioned wire of 0.3 mm in diameter. The top and bottom big granules are also left plain (*Fig. 4/36c*). Top and bottom grapes are fixed with a clamp (*Fig. 4/36c*). Three kinds of wires were manufactured to produce this earring as well as three different sizes of granule. In total eight different kinds of components were manufactured to produce this earring.

Earring H104-14		Dimensions [mm]
Preserved length of the earring		23
Central wire, upper arch	Ø	1.2
Filigree ring elbow	Ø	0.3
Granule, elbow	Ø	0.5
Twisted wire	Ø	0.6 (0.3 one wire)
Granule from rings grape	Ø	0.8
Big filigree ring on grape	Ø	0.3
Big granule	Ø	1.7
Clamp	width	0.6

Table 48: Dimensions of the earring H104-14 and its components.

Tab. 48: Rozměry jednotlivých částí náušnice H104-14.

Condition of the earring and quality of the work

The earring is complete but was covered by a layer of tarnish made of silver corrosion products, mainly chlorides and sulphides, and the gilding layer has worn away in many places revealing the underlying mineralized silver bulk (*Fig. 4/36e*).

Scanning electron microscopy and microanalysis

Electron microanalysis performed on the surface of the earring (*Fig. 4/36a, c, e*) showed that the earring was made of silver and that it was gilded by fire-gilding (Table 49). Silver was detected on the surface at a high concentration because the gilding layer has worn away in many places (*Fig. 4/36b, c*) revealing the bulk metal of the earring which certainly contained a small amount of copper. Copper was not detected in analyses of the bulk metal on the section of the wire because the analysed material was highly corroded. The gilding layer observed in recesses with the scanning electron microscopy showed the typical, porous structure of unburnished gilding obtained by fire-gilding (*Fig. 4/36f*).

→ **Fig. 4/36:** Earring H104-14: a - general view of the earring (photo J. Sobek); b - detail of the worn gilding layer on the grapes (photo E. Ottenwelter); c - detail of the clamp, lower arch decoration, and analysed points (photo E. Ottenwelter); d - detail of the gilded silver central wire (photo E. Ottenwelter); e - analysed bulk metal of the central wire, SEM micrograph (BSE image, photo D. Janová); f - gilding layer observed in recesses, SEM micrograph (SE image, photo D. Janová); g - gilded solder areas, SEM micrograph (BSE image, photo D. Janová).

→ **Obr. 4/36:** Náušnice H104-14: a - celkový pohled na náušnici (foto J. Sobek); b - detail odřené vrstvy zlatení na hrozníčcích (foto E. Ottenwelter); c - detail pouťka a dekorace spodního oblouku s vyznačením míst bodové mikroanalýzy (foto E. Ottenwelter); d - detail stříbrného pozlaceného středového drátu (foto E. Ottenwelter); e - analyzované místo základního kovu středového drátu, mikrosnímek z rastrovacího elektronového mikroskopu (zobrazení BSE, snímek D. Janová); f - vzhled vrstvy zlatení v prohlubních, mikrosnímek z rastrovacího elektronového mikroskopu (zobrazení SE, snímek D. Janová); g - zlatené oblasti pájky, mikrosnímek z rastrovacího elektronového mikroskopu (zobrazení BSE, snímek D. Janová).

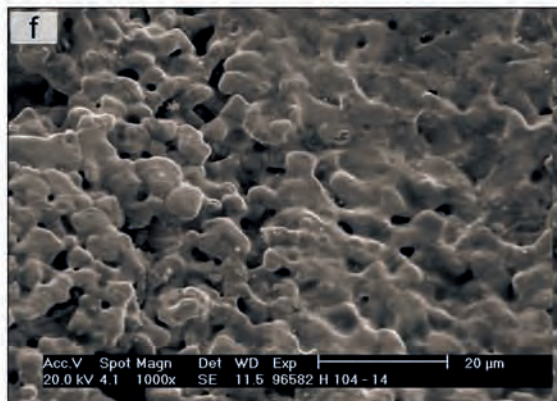
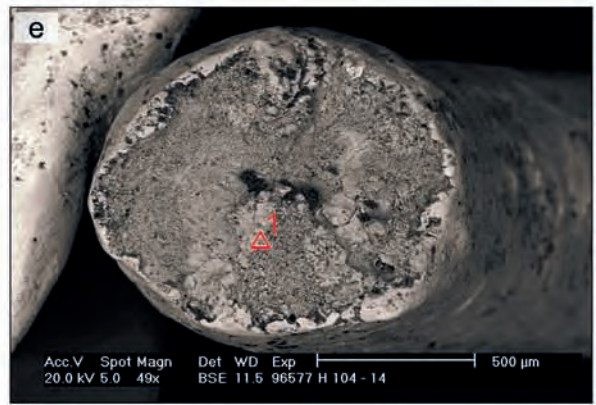
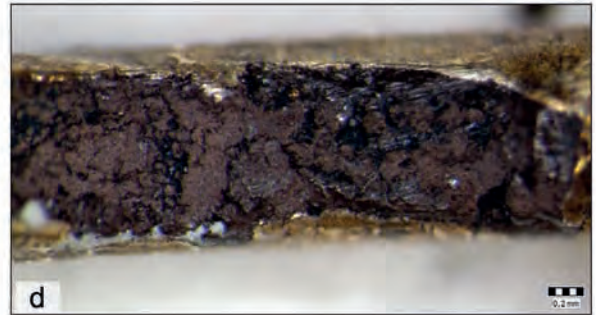
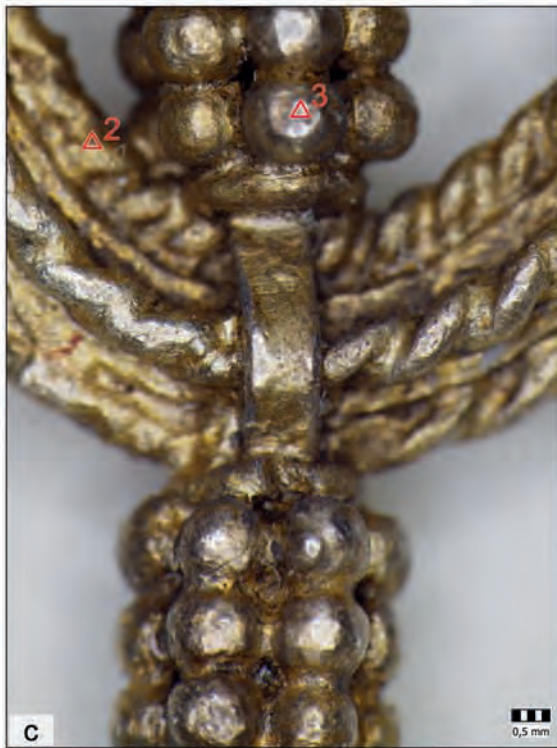
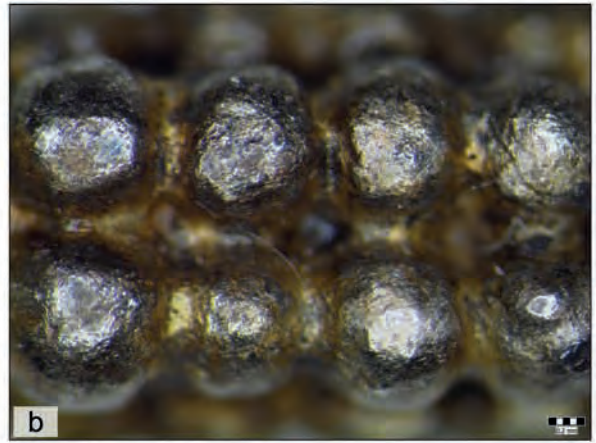

Components forming the grape-shaped earring H104-14	Chemical composition [Wt. %]			
	Au	Ag	Cu	Hg
Central wire, bulk metal, fresh fracture, point 1	-	94.2	5.8	-
Gilding layer in recess, point 2	79.3	14.4	3.7	2.6
Worn gilding layer, granule point 3	31	60.7	5.7	2.6
Worn gilding layer, top granule, point 4	29.1	66	4.9	-

Table 49: Chemical composition of the different element composing the earring H104-14 and solder areas.

Tab. 49: Chemické složení různých částí náušnice H104-14 a složení pájených částí.

4.4.1.3. GILT COPPER GRAPE-SHAPED EARRINGS WITH FILIGREE WORK AND SMOOTH CIRCULAR LOWER ARCH

This type of earring represents two specimens (H31-1, H31-2), both excavated in grave H31 where a woman was buried (*Frolík - Smetánka 2014*, p. 82-83). The earring was the only metallic grave good from the grave. The earrings are identical.

Description of the earring H31-1 (*Fig. 4/37*)

The earring is constructed on a central round-sectioned wire of 1.4 mm in diameter. The lower arch was left smooth and has a round section (*Fig. 4/37a*). Elbows and grapes are constructed from two types of filigree rings (*Fig. 4/37c, e*). One of them is made from a smooth circular-sectioned wire of 0.5 mm and forms rings of 2.4 mm while the second type is made from a beaded wire of 1 mm in diameter and forms rings of 3 mm in diameter. Elbows are formed with a ring of beaded wire between two rings of smooth circular-sectioned wire. The lower arch is decorated by double-sided grapes fixed on the lower arch with a clamp of 0.7 mm in width (*Fig. 4/37e*). The lower grape is longer than the top grape. It is formed by four smooth filigree rings soldered in pairs between which a beaded wire is added. The top grape is made as the elbows with a beaded wire in between two smooth rings. A smooth big granule of 2 mm in diameter sits on the end of both top and bottom grapes. The earring is made with a total of five different types of components.

Earring H31-1		Dimensions [mm]
Preserved length of the earring		25.7
Central wire, upper arch	Ø	1.4
Smooth filigree ring	Ø	2.4
Beaded filigree ring	Ø	3
Beaded wire from filigree wire	Ø	1
Smooth wire from filigree wire	Ø	0.5
Clamp	width	0.7
Big granule	Ø	2

Table 50: Dimensions of the earring H31-1 and its components.

Tab. 50: Rozměry jednotlivých částí náušnice H31-1.

Condition of the earring and quality of the work

The earring is in a poor condition. The bulk metal is very brittle because of intercrystalline corrosion. Moreover, it was over-cleaned with a complexing agent (EDTA) in past treatment. As a result, corrosion products of copper were entirely dissolved including internal corrosion products leading to a loss of the gilding layer which was lying on the corroded material. The remaining gilding layer is tarnished. The big granule on the top of the upper grape is missing.

It is a good quality work.