

A giant externally-occulted coronagraph for the PROBA-3 formation flight mission

P. Lamy, S. Vivès (philippe.lamy@oamp.fr, sebastien.vives@oamp.fr)

Laboratoire d'Astrophysique de Marseille, 38, rue Frédéric Joliot-Curie, 13388 Marseille Cedex 13, France

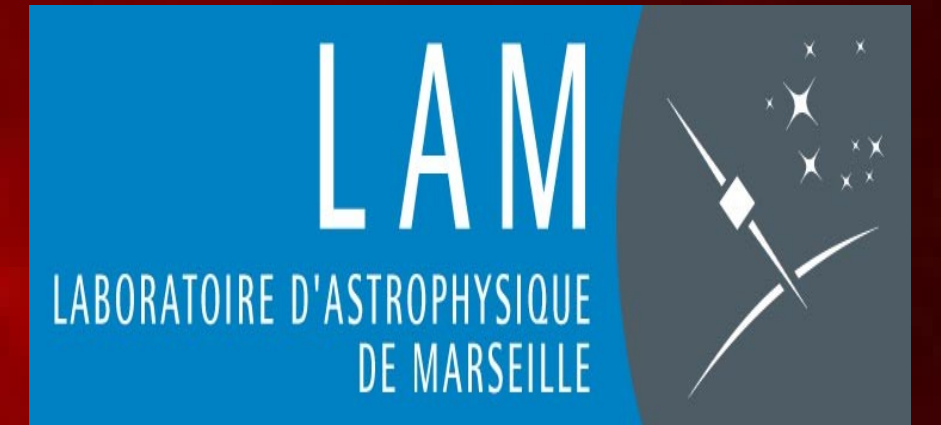

Introduction

Classical externally-occulted coronagraphs are presently limited in their performances by the distance between the external occulter and the front objective. The diffraction fringe from the occulter and the vignetted pupil which degrades the spatial resolution prevent useful observations of the white light corona inside typically 2-2.5 R_{\odot} . Formation flying offers an elegant solution to these limitations and allows conceiving giant, externally-occulted coronagraphs using a two-component space system with the external occulter on one spacecraft and the optical instrument on the other spacecraft at a distance of hundred meters. Such an instrument has been selected by the European Space Agency (ESA) to fly on its PROBA-3 mission of formation flying demonstration which is presently in phase B. It will perform both high spatial resolution imaging of the solar corona as well as 2-dimensional spectroscopy of several emission lines (in particular the forbidden line of FeXIV at 530.285 nm) from the coronal base out to 3 R_{\odot} using an étalon Fabry-Pérot interferometer. The classical design of an externally-occulted coronagraph is adapted to the formation flying configuration allowing the detection of the very inner corona as close as 0.05 R_{\odot} from the solar limb. By tuning the position of the occulter spacecraft, it may even be possible to reach the chromosphere and the upper part of the spicules.

Observing the Inner Corona in white light

After 40 years of space coronagraphy, the inner corona remains poorly observed. Images from the internally occulted coronagraphs SOHO/LASCO-C1 (Fig. 1) and STEREO/SECCHI-COR1 (Fig. 2) are affected by high levels of stray light which severely limit their contrast (i.e., S/N ratio) and consequently degrade their spatial resolution.

Images from ground-based coronagraphs are generally affected by seeing and atmospheric conditions (Fig. 3a). The ultimate white light images of the inner corona remain those obtained during the rare and exceptional eclipses (Fig. 3b). An externally-occulted coronagraph in formation flying will attempt to reproduce conditions close to a solar eclipse so as to routinely achieve observations of similar quality.

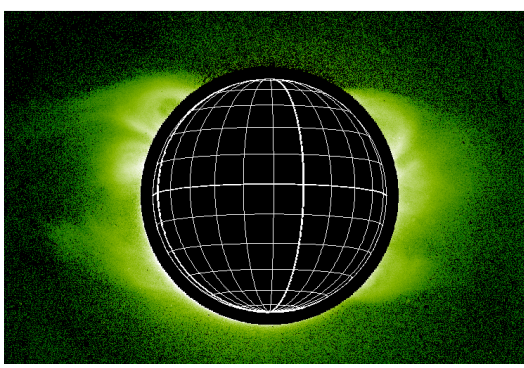

Fig. 1 – The inner corona as seen by the LASCO-C1 coronagraph in the light of the green line of Fe XIV.

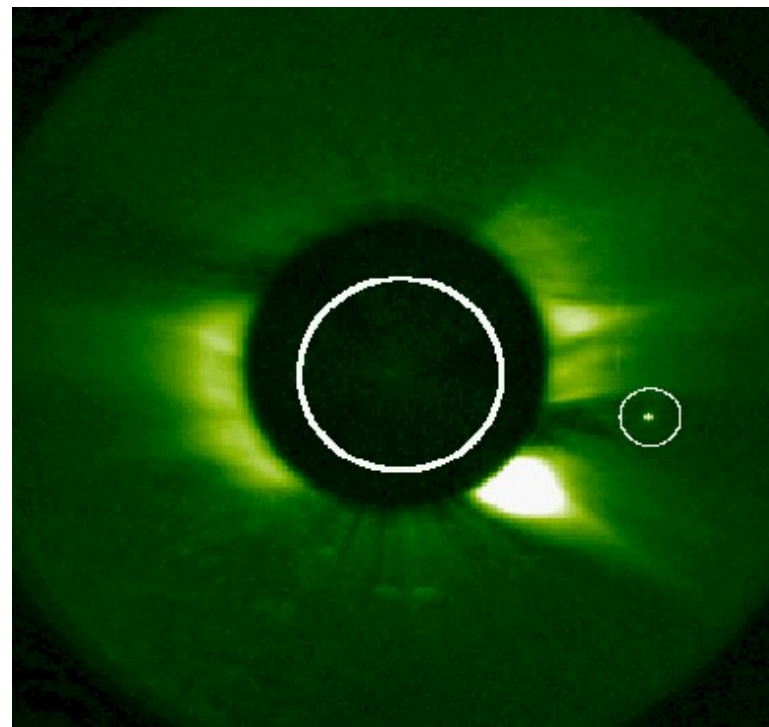

Fig. 2 – The inner corona as seen by STEREO/SECCHI-COR 1.

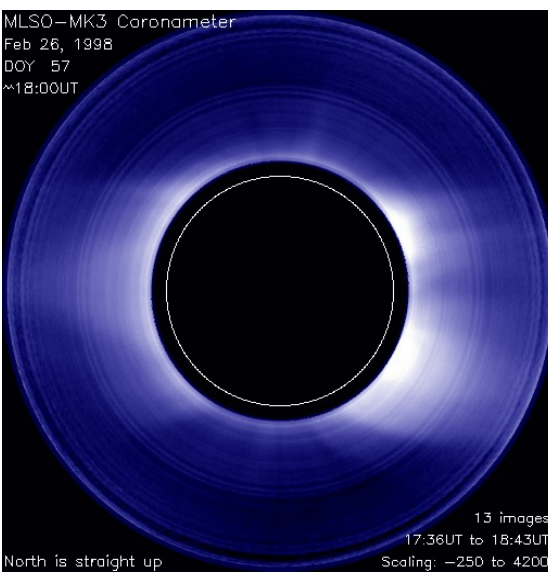
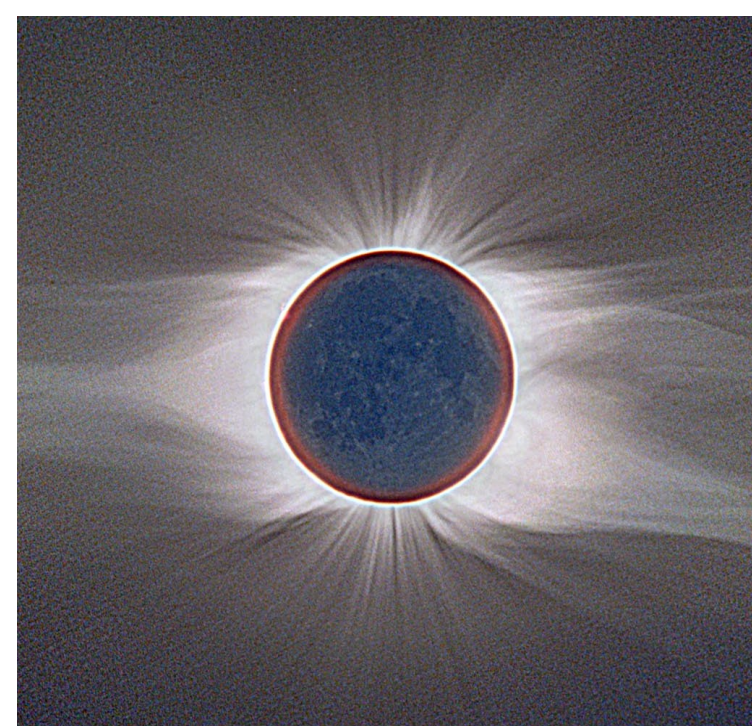

Fig. 3a/b – top, the inner corona as seen by the ground-based coronagraph Mk III (Hawaii). At right, the corona as seen at the same time during the solar eclipse of 26 February 1998 (Guadeloupe).



Science Objectives

By performing high spatial resolution imaging of the corona as well as 2-dimensional spectroscopy of several emission lines from the coronal base out to 3 R_{\odot} , the PROBA-3 coronagraph will address many fundamental questions of coronal physics such as:

- The heating of the corona: are there different physical mechanisms ? what is the role of waves ?
- The origin of the slow solar wind: at the boundaries of CH/steamers ? non-stationary mass loss (“blobs”) ?
- The acceleration of the slow and fast winds: are there different mechanisms ?
- The onset and acceleration of CMEs ?

Methodology

- High spatial resolution imaging at a scale of 1.5 arcsec/pixel of the continuum corona (540-570 nm)
- Two-dimensional spectroscopy of coronal emission lines (CEL)

We have selected the CEL listed in the following Table. The forbidden line of FeXIV, at 530.285 nm, is our prime choice since it is the strongest in the corona, and since its profile is directly reflecting line-of-sight velocities inside the corona. Additional emission lines will be included to better address different coronal regions. For the physics of prominences and chromosphere, the most interesting lines are He I (587.6 nm), H β (486.13 nm) and the K line of Ca II (854.3 nm).

Line	Wavel. (nm)	Temp.	Coronal structures
Fe XIV	530.3	1.8×10^6	Hot matter
Fe X	637.4	1.0×10^6	Coronal holes
He I	587.6	1.0×10^5	Cold matter
Continuum	540-570	---	K-Corona

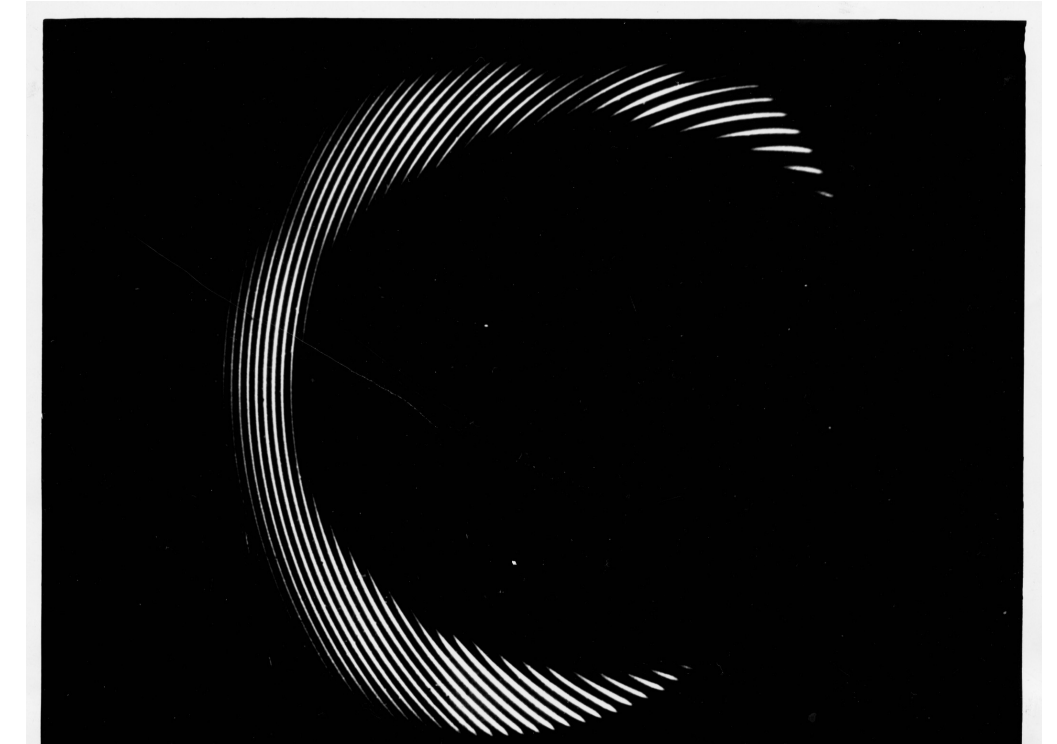

Fig. 4 – Fabry-Perot interferogram obtained by Desay et al. (1981) during the solar eclipse of Feb. 16th 1980.

Note that their interferometer was so tilted (center on the solar disk) that only ~2/3 of the corona was covered by the fringe network. The fringes at the bottom (south) are not broadened but actually split.

The method consists in analyzing the bi-dimensional distribution of line profiles by a set of quasi concentric fringes generated by a Fabry-Pérot (F-P) interferometer working in the so-called etalon mode which does not require any adjustment, contrary to the scanning F-P implemented on SOHO/LASCO-C1. The etalon will be mechanically tilted to displace the set of fringes and increase the spatial resolution. The fringes have an instrumental profile of typically 0.02 nm, narrower than the width of the line (~0.1 nm for Fe XIV) so that the observed profiles are not significantly affected by the instrumental function and directly give the real profiles of the coronal emission lines to a very good accuracy.

PROBA-3 : Formation flying configuration and specifications

The basic configuration of the coronagraph corresponds to a “rigid” long baseline instrument, and the formation can be considered as the instrument. The nominal occultation of the Sun is $1.015 \pm 0.005 R_{\odot}$. This specification allows deriving both the geometry of the formation (i.e. the Inter-Satellite Distance, ISD = 150 m), and the absolute pointing of the formation (i.e. the Relative Displacement Errors, or RDE, of one of the S/C compared to the other).

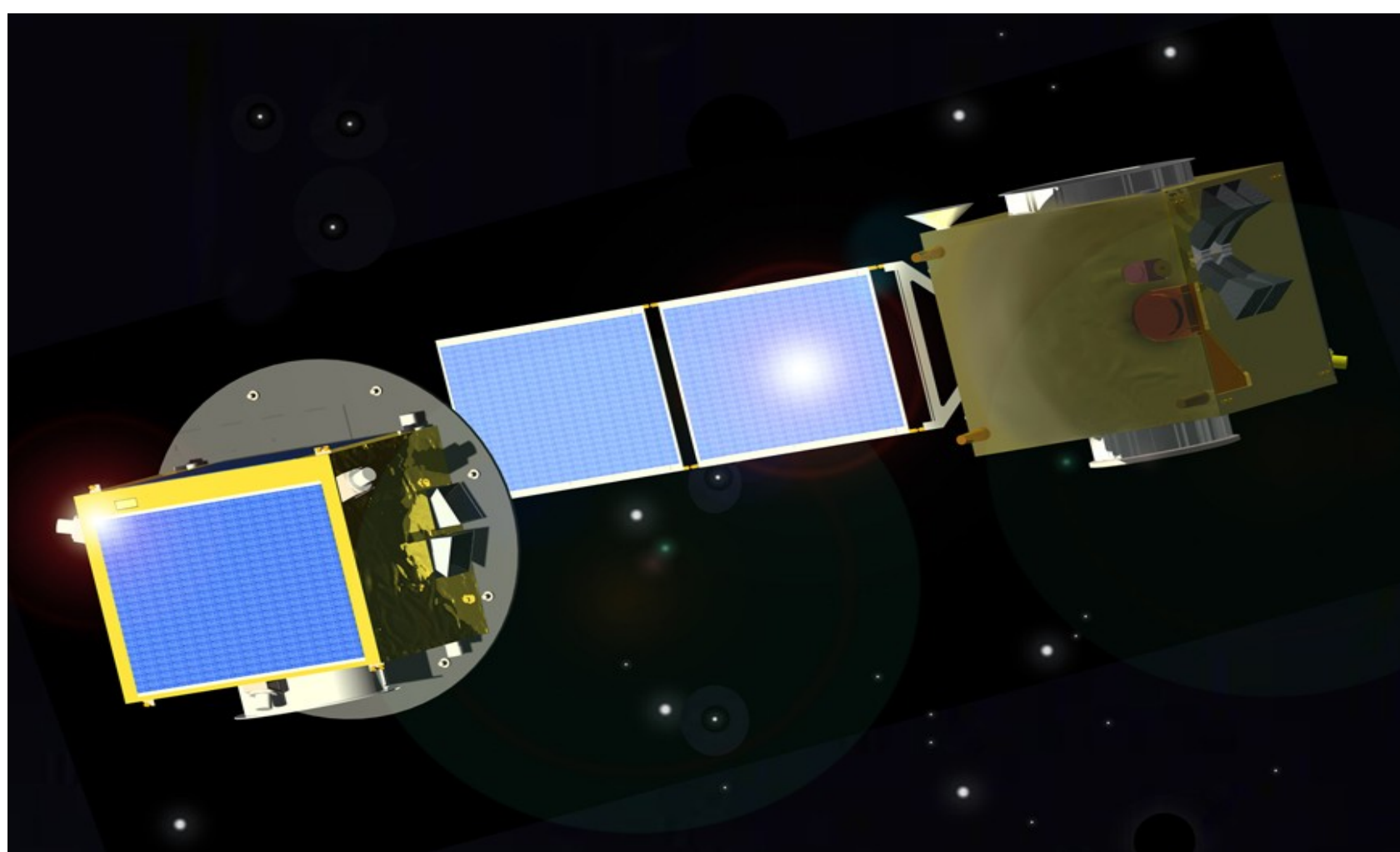

Fig. 5 - Artistic view of the two-component space system realizing the PROBA-3 giant externally-occulted coronagraph. The occulting disc is hosted by one spacecraft while the optical instrument is on the other spacecraft at 150 m from the first one (Courtesy Swedish Space Center).”

SCHEDULE

Phase B is running until March 2010 (PDR)
 PHASE C/D: March 2010 to February 2012
 Launch and commissioning: late 2012/early 2013
 Operations: 2013-2014

Coronagraph concept and implementation

The coronagraph is conceptually composed of three parts: the coronagraphic part (from the pupil to the internal occulter), the spectral part (including the Fabry-Pérot) and the re-imaging part (the camera and the detector).

- The classical design of an externally-occulted coronagraph is adapted to the detection of the very inner corona as close as 1.05 R_{\odot} from the Sun centre with high spatial resolution. An unobstructed three-mirror anastigmat (TMA) combination acts as the primary objective and forms an aberration-free image of the diffraction fringe surrounding the external occulter, thus allowing its optimal blocking by the inner occulter.
- The objective O2 forms an afocal system which produces a real 1:10 image of the pupil at the Lyot stop. The collimated beam leaving O2 goes through a Fabry-Pérot (F-P) interferometer, and associated blocking filters mounted on a wheel. A separate wheel contains several linear polarizers.
- The final image is formed by the objective O3 on the CCD detector I such that a circular field of view with a radius of 3 Rs forms an inscribed circle on the 2k x 2k pixel detector where one pixel subtends 2.5 arcsec in the corona.

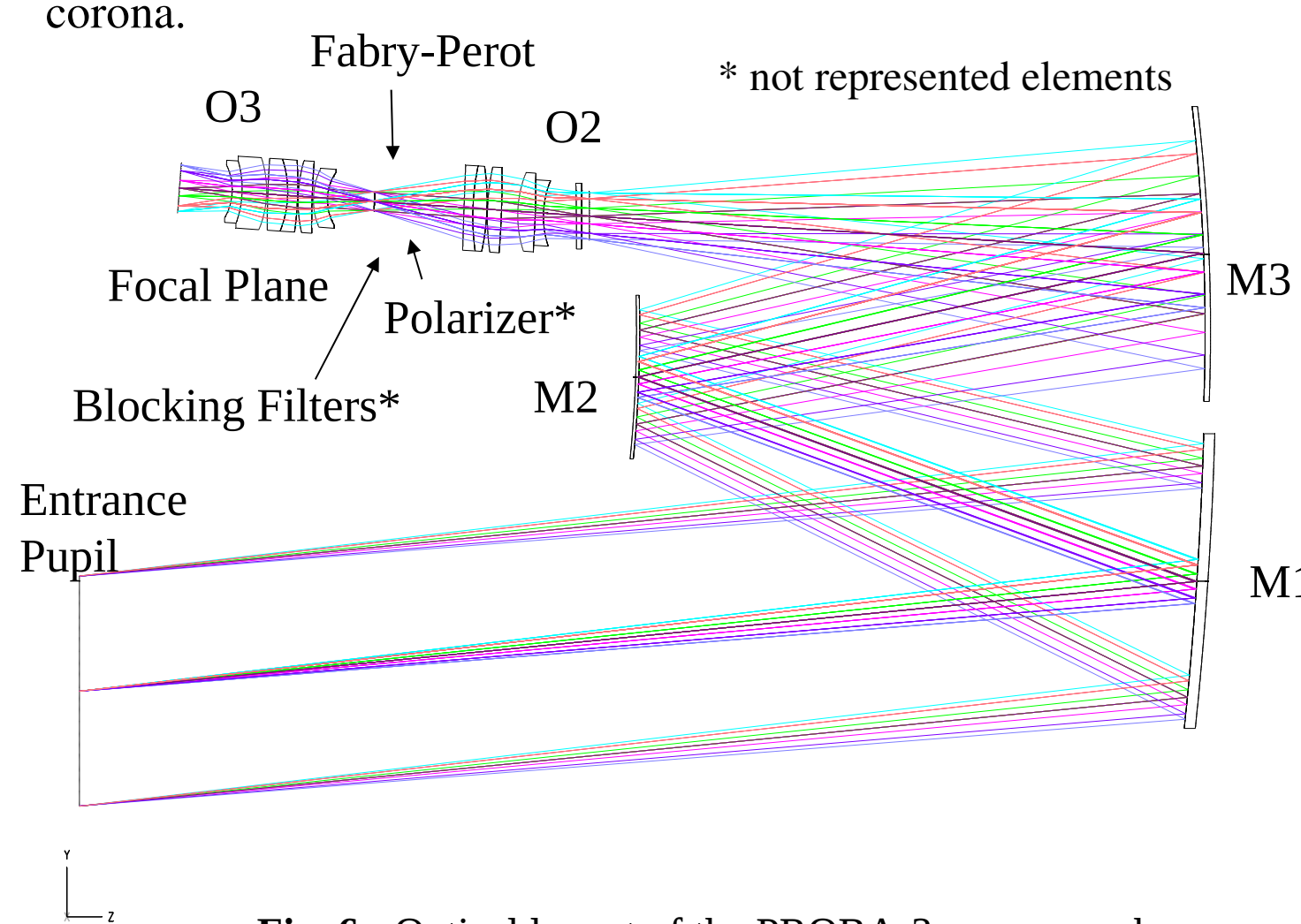

Fig. 6 - Optical layout of the PROBA-3 coronagraph

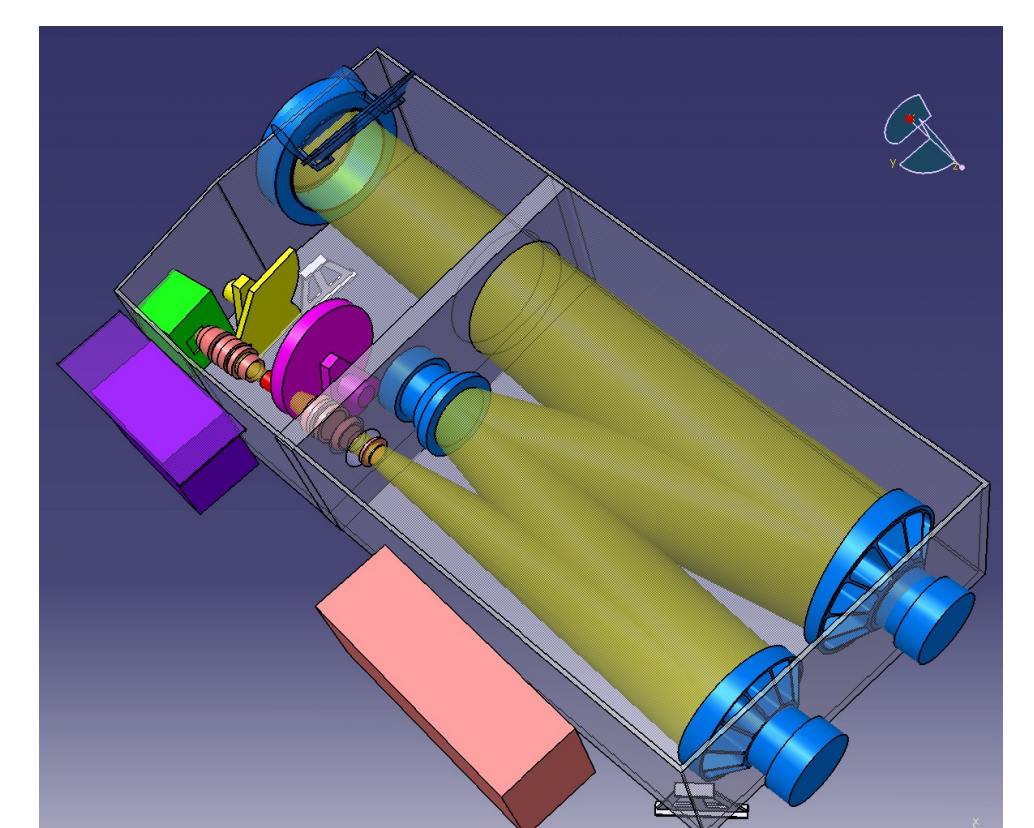

Fig. 7 - Opto-mechanical view of the Coronagraph Optical Box decoupled from the S/C thanks to titanium bipods.