

Institute of Economic Studies, Faculty of Social Sciences  
Charles University in Prague

# Czech Bankruptcy Procedures: Ex-post Efficiency View

Ondřej Knot  
Ondřej Vychodil

IES Working Paper: 3/2006



Institute of Economic Studies,  
Faculty of Social Sciences,  
Charles University in Prague

[UK FSV – IES]

Opletalova 26  
CZ-110 00, Prague  
E-mail : [ies@fsv.cuni.cz](mailto:ies@fsv.cuni.cz)  
<http://ies.fsv.cuni.cz>

Institut ekonomických studií  
Fakulta sociálních věd  
Univerzita Karlova v Praze

Opletalova 26  
110 00 Praha 1

E-mail : [ies@fsv.cuni.cz](mailto:ies@fsv.cuni.cz)  
<http://ies.fsv.cuni.cz>

**Disclaimer:** The IES Working Papers is an online paper series for works by the faculty and students of the Institute of Economic Studies, Faculty of Social Sciences, Charles University in Prague, Czech Republic. The papers are peer reviewed, but they are *not* edited or formatted by the editors. The views expressed in documents served by this site do not reflect the views of the IES or any other Charles University Department. They are the sole property of the respective authors. Additional info at: [ies@fsv.cuni.cz](mailto:ies@fsv.cuni.cz)

**Copyright Notice:** Although all documents published by the IES are provided without charge, they are licensed for personal, academic or educational use. All rights are reserved by the authors.

**Citations:** All references to documents served by this site must be appropriately cited.

**Bibliographic information:**

Knot, O. and O.Vychodil (2006). "Czech Bankruptcy Procedures: Ex-Post Efficiency View" IES Working Paper 3/2006, IES FSV. Charles University.

This paper can be downloaded at: <http://ies.fsv.cuni.cz>

# Czech Bankruptcy Procedures: Ex-post Efficiency View

Ondřej Knot\*  
Ondřej Vychodil#

January 2006

## **Abstract:**

The paper presents facts on the ex-post efficiency of the Czech bankruptcy procedures. First, it briefly summarizes in what aspects bankruptcy systems differ across countries and introduces the main observations made about the Czech case so far. Second, international data are presented to assess the Czech standings in four aspects of bankruptcies' ex-post efficiency – duration, recovery rate, administrative costs, and continuation/liquidation decision. Third, the paper provides a summary of statistical observations on ex-post efficiency based on data on 903 Czech companies whose bankruptcies were completed during 2004 by the distribution of returns to the claim-holders. In the paper, understanding the ex-post efficiency is meant as an important prerequisite for an analysis from the ex-ante efficiency prospective.

## **Abstrakt:**

Autoři předkládají fakta o ex-post efektivnosti českých konkurzních řízení. Nejprve shrnují, v jakých aspektech se liší režimy úpadkového práva nepřič zeměmi, a prezentují hlavní z dosud učiněných pozorování o české realitě. Dále, na základě mezinárodních dat, hodnotí české konkurzy v porovnání s jinými zeměmi ve čtyřech aspektech ex-post efektivnosti – doba trvání, výtěžnost, administrativní náklady a rozhodnutí o pokračování/likvidaci. Na závěr autoři předkládají statistiky ex-post efektivnosti založené na datech o všech 903 českých společnostech, jejichž konkurzní řízení bylo ukončeno schválením rozvrhového usnesení v roce 2004. Porozumění ex-post efektivnosti je podstatným předpokladem pro analýzu českého úpadkového práva z hlediska ex-ante efektivnosti.

**Keywords:** bankruptcy, liquidation, ex-post efficiency

**JEL Classification:** G33, K39

## **Acknowledgements:**

Financial support from the Global Development Network under the regional Research Competition Grant and from the IES (Institutional Research Framework 2005-2010, MSM0021620841) is gratefully acknowledged.

---

\* CERGE-EI, email: [ondrej.knot@cerge-ei.cz](mailto:ondrej.knot@cerge-ei.cz).

# Institute of Economic Studies, Charles University, Opletalova 26, Prague 1, 110 00, Czech Republic and CERGE-EI; e-mail: [ondrej.vychodil@cerge-ei.cz](mailto:ondrej.vychodil@cerge-ei.cz).



# IES Working Paper Series

2005

1. František Turnovec: *New Measure of Voting Power*
2. František Turnovec: *Arithmetic of Property Rights: A Leontief-type Model of Ownership Structures*
3. Michal Bauer: *Theory of the Firm under Uncertainty: Financing, Attitude to Risk and Output Behaviour*
4. Martin Gregor: *Tolerable Intolerance: An Evolutionary Model*
5. Jan Zápál: *Judging the Sustainability of Czech Public Finances*
6. Wadim Strielkowski, Cathal O'Donoghue: *Ready to Go? EU Enlargement and Migration Potential: Lessons from the Czech Republic in the Context of the Irish Migration Experience*
7. Roman Horváth: *Real Equilibrium Exchange Rate Estimates: To What Extent Are They Applicable for Setting the Central Parity?*
8. Ondřej Schneider, Jan Zápál: *Fiscal Policy in New EU Member States: Go East, Prudent Man*
9. Tomáš Cahlík, Adam Geršl, Michal Hlaváček and Michael Berlemann: *Market Prices as Indicators of Political Events- Evidence from the Experimental Market on the Czech Republic Parliamentary Election in 2002*
10. Roman Horváth: *Exchange Rate Variability, Pressures and Optimum Currency Area Criteria: Implications for the Central and Eastern European Countries*
11. Petr Hedbávný, Ondřej Schneider, Jan Zápál: *A Fiscal Rule That Has Teeth: A Suggestion for a "Fiscal Sustainability Council" Underpinned by the Financial Markets*
12. Vít Bubák, Filip Žikeš: *Trading Intensity and Intraday Volatility on the Prague Stock Exchange: Evidence from an Autoregressive Conditional Duration Model*
13. Peter Tuchyňa, Martin Gregor: *Centralization Trade-off with Non-Uniform Taxes*
14. Karel Janda: *The Comparative Statics of the Effects of Credit Guarantees and Subsidies in the Competitive Lending Market*
15. Oldřich Dědek: *Rizika a výzvy měnové strategie k převzetí eura*
16. Karel Janda, Martin Čajka: *Srovnání vývoje českých a slovenských institucí v oblasti zemědělských finance*
17. Alexis Derviz: *Cross-border Risk Transmission by a Multinational Bank*
18. Karel Janda: *The Quantitative and Qualitative Analysis of the Budget Cost of the Czech Supporting and Guarantee Agricultural and Forestry Fund*
19. Tomáš Cahlík, Hana Pessrová: *Hodnocení pracovišť výzkumu a vývoje*
20. Martin Gregor: *Committed to Deficit: The Reverse Side of Fiscal Governance*
21. Tomáš Richter: *Slovenská rekodifikace insolvenčního práva: několik lekcí pro Českou republiku*
22. Jiří Hlaváček: *Nabídková funkce ve vysokoškolském vzdělávání*
23. Lukáš Vácha, Miloslav Vošvrda: *Heterogeneous Agents Model with the Worst Out Algorithm*
24. Kateřina Tsolov: *Potential of GDR/ADR in Central Europe*
25. Jan Kodera, Miroslav Vošvrda: *Production, Capital Stock and Price Dynamics in a Simple Model of Closed Economy*
26. Lubomír Mlčoch: *Ekonomie a štěstí – proč méně může být více*

27. Tomáš Cahlík, Jana Marková: *Systém vysokých škol s procedurální racionalitou agentů*
28. Roman Horváth: *Financial Accelerator Effects in the Balance Sheets of Czech Firms*
29. Natálie Reichlová: *Can the Theory of Motivation Explain Migration Decisions?*
30. Adam Geršl: *Political Economy of Public Deficit: Perspectives for Constitutional Reform*
31. Tomáš Cahlík, Tomáš Honzák, Jana Honzáková, Marcel Jiřina, Natálie Reichlová: *Convergence of Consumption Structure*
32. Luděk Urban: *Koordinace hospodářské politiky zemí EU a její meze*

## 2006

1. Martin Gregor: *Globální, americké, panevropské a národní rankingy ekonomických pracovišť*
2. Ondřej Schneider: *Pension Reform in the Czech Republic: Not a Lost Case?*

All papers can be downloaded at: <http://ies.fsv.cuni.cz>



# 1 Introduction

Economic theories of bankruptcy have been vividly growing over the last decade, building on the achievements of various, mutually intersecting research areas, in particular law and economics, contract theory, property rights economics, theory of finance, and new institutional economics.<sup>1</sup> In the Czech Republic, inefficient bankruptcies have been considered to be a crucial barrier to the economic growth. It can be argued that after the wave of massive asset-stripping hit companies and investment funds within privatization in early nineties, it moved to the banking sector in mid-nineties and after the large banks have been fully privatized, it found its ground in bankruptcy procedures.

After twenty amendments to the 1991-Act on Bankruptcy and Composition, the Czech economy is still waiting for a fundamental reform of the bankruptcy system to come. However, empirical research on Czech bankruptcies is lacking. Although it has been generally documented that a typical bankruptcy procedure takes some four or five years to be completed and brings only negligible returns to the debtor's claimants, we are missing a more in-depth analysis of what is going on in Czech bankruptcies and why. This paper does not represent such an in-depth analysis but rather an important step towards it.

In the paper, we systematically present some facts on the ex-post efficiency of the Czech bankruptcy procedures. In Section 2, we briefly summarize in what aspects bankruptcy systems differ across countries and introduce the main observations made about the Czech case so far. In Section 3, we deal with ex-post efficiency as consisting of four aspects and generally present the standing of the Czech system in the world context. In Section 4, we present some facts based on data on 903 Czech companies whose bankruptcies were completed during 2004 by the distribution of returns to the claim-holders. Finally, in Section 5, we conclude our paper.

---

<sup>1</sup>For an up-to-date survey of economic literature on both personal and corporate bankruptcy see White (2005). In our paper, we deal with corporate bankruptcy only.

## 2 Variations of Bankruptcy Laws

There is a consensus in the literature that a bankruptcy law is needed. In the first step, the law introduces a stay on claims collection by individual creditors. Next, it provides a framework for:

- reallocation of claims against the firm, i.e., new design of the firm's capital structure, and
- redistribution of control rights in the firm among the debtor, creditors, and the judge/trustee.

It is much less clear what should be the goal of bankruptcy and how an optimal law should look like. There are many aspects in which bankruptcy laws may vary; and, in fact, they do across countries around the world.<sup>2</sup> These aspects include, besides differing procedures of the above-mentioned claims' reallocation and control redistribution, questions like "Who should be entitled to initiate bankruptcy procedure?", "What is the role of the firm's management?", or "What is the optimal degree of judge's discretion?" Yet, the most often discussed distinction is between debtor-oriented and creditor-oriented bankruptcy laws,<sup>3</sup> with an especially high attention devoted to reorganizations *à la* the U.S. Chapter 11.<sup>4</sup>

---

<sup>2</sup>For empirical evidence on bankruptcy law design in various countries see, for example, Rajan and Zingales (1995), Franks and Sussman (1999), Berglof and Rosenthal (2000), White (1992), Atiyas (1995), Franks, Nyborg and Torous (1994), Franks and Sussman (2000), Franks and Torous (1989), Franks and Torous (1994), Fisher and Martel (1995), Fisher and Martel (1999), Biais and Malecot (1996), Kordana and Posner (1998), Bayer (2003).

<sup>3</sup>We can also find a notation "tough vs. soft law" in the literature. See Biais and Recasens (2002).

<sup>4</sup>Advocates of Chapter 11 include Warren (1992), Warren (1993), LoPucki (2003a), LoPucki (2003b), Berglof, Roland and von Thadden (2003), Giammarino and Nosal (1996), Bris, Welch and Zhu (2004), Brown (1989), Gertner and Scharfstein (1991), Gilson, John and Lang (1990), Berkovitch, Israel and Zender (1998). The critiques of Chapter 11 include Baird and Rasmussen (2002), Baird and Rasmussen (2003), Bradley and Rosenzweig (1992), Bebchuk (1988), Aghion, Hart and Moore (1992), Hart (2000), Schwartz (1998).



## 2.1 The Importance of Country-Specific Factors

In the last decade, La Porta, Lopez-de-Silanes, Shleifer and Vishny (hereinafter LLSV)<sup>5</sup> have come up with an innovative approach to cross-country comparison of laws, including debtor-creditor laws. They apply a regression analysis to study the relationship between the legal protection of investors and the development of capital markets in a sample of 49 countries. Concerning debtor-creditor relationship, LLSV find that the German legal family provides creditors with the highest level of protection, while the creditors in French civil law countries enjoy the weakest protection. As a result, the capital markets – both equity and debt markets – are generally smaller and narrower in countries with French legal origin.

However, as Berkowitz, Pistor and Richard (2003) convincingly point out on the same sample of countries,

the way in which the law was initially transplanted is a more important determinant of legality [i.e., the efficiency of legal norms – authors’ note] than the supply of a particular legal family. (p. 16)

This finding directs attention towards the general observation that only such law can be efficient that accounts for complementarity among institutions (both formal and informal) in each particular country. Such an observation fully applies to bankruptcy legislation.

As Hart (2000) argues,

it is unlikely that “one size fits all.” That is, although some bankruptcy procedures can probably be rejected as being manifestly bad, there is a class of procedures that satisfy the main criteria of efficiency. Which procedure a country chooses or should choose may then depend on other factors, e.g., the country’s institutional structure and legal tradition. (p. 1)

---

<sup>5</sup>See La Porta, Lopez-de Silanes, Shleifer and Vishny (1997), La Porta, Lopez-de Silanes, Shleifer and Vishny (1998).

Scholars analyzing the functioning of bankruptcies suggest various country-related specific factors that should be taken into account when designing an optimal bankruptcy law. For instance, Baird and Rasmussen (2002) and Baird and Rasmussen (2003) stress the importance of capital structure and the functioning of asset markets, Berkovitch and Israel (1998) emphasize information structure, while Lambert-Mogiliansky, Sonin and Zhuravskaya (2003) and Biais and Recasens (2002) study the effects of corruption among judges.<sup>6</sup>

Claessens and Klapper (2002) provide an empirical analysis of the use of bankruptcy procedures on a panel of 35 countries. They investigate how often bankruptcy procedures are being used and how this depends on specific legal design and judicial performance. Bankruptcies are generally found to appear more frequently in countries with Anglo-Saxon legal origin, market-oriented rather than bank-oriented financial systems and higher judicial efficiency.

The most discussed examples of bankruptcy legislation from the real world are those of the U.S., U.K., Germany, and France. Generally, the French law is considered to be extremely soft, while the U.K. and German laws as tough. In the U.S., basically, liquidation under Chapter 7 is taken as tough, while reorganization under Chapter 11 as soft. Adding the fact that Chapter 11 is used quite extensively, the U.S. bankruptcy code can be thought of as rather soft.

Wihlborg (2002), referring to Wood (1995), sorts several bankruptcy laws on the scale from extremely pro-creditor to extremely pro-debtor (see Table 1). Certainly, this ranking gives just a very rough description and does not account for many other differences and similarities among various bankruptcy regimes. However, it illustrates that bankruptcy laws do differ in reality and reinforces the theoretical statement that there is no “one size fits all” bankruptcy law.

---

<sup>6</sup>See Knot and Vychodil (2005b) for a summary of factors examined in the optimal bankruptcy law design literature.

Table 1: Creditor/Debtor Orientation of Bankruptcy Laws Around the World

pro- -creditor	1	former British colonies in Africa
	2	<b>U.K. (England)</b> , Australia, Ireland
	3	<b>Germany</b> , NL, Sweden, Switzerland, Poland, Indonesia
	4	<b>U.K. (Scotland)</b> , Norway, Japan, Korea, New Zealand
	5	<b>U.S.A.</b> , Canada
	6	Denmark, Austria, <b>Czech Rep.</b> , Slovakia, South Africa
	7	Italy
	8	Greece, Portugal, Spain, Latin America
pro- -debtor	9	Belgium, former French colonies in Africa
	10	<b>France</b>

Source: Wihlborg (2002).

## 2.2 The Czech Bankruptcy Law

The current state of the bankruptcy legislation in the Czech Republic is highly unsatisfactory, mainly because of the weak position of creditors, the absence of time limits for certain decisions, and unclear legal provisions. There is a general consensus that a bankruptcy reform is needed.<sup>7</sup> The government has prepared a draft of a brand new Insolvency Act, which attempts to introduce the possibility of reorganization and, in the same time, to strengthen creditors' protection. However, it is still unclear whether and when a new Insolvency Act will be passed by the Parliament, as well as what the final Act will look like.<sup>8</sup>

Although the current Czech bankruptcy law, as on the books, is rather creditor-oriented, it performs very poorly in the actual protection of creditors. According to the common knowledge, this is due to its inefficient application by the judiciary, which stems from a non-negligible problem of incompetence

<sup>7</sup>For a critique of the current Czech bankruptcy law and of the early drafts of its reform see Richter (2004).

<sup>8</sup>For a brief description of the main building blocks of the draft see Richter (2005).

and, to some extent, corruption among Czech judges. In fact, the failures of the law's application enable an operation of Mafia-like groups that specialize in asset-stripping of firms in bankruptcy at the expense of creditors.<sup>9</sup>

Economic literature on Czech bankruptcies has been rather poor so far. Some empirical evidence was provided by Lizal (2001) and Mitchell (1998). A broader overview of the Czech bankruptcy practice from the economic perspective can be found in Klimes (2004), Diblik (2004), and Sotak (2005).

Mitchell (1998) emphasized, regarding the Czech case, that “not only the terms of the bankruptcy codes matter, a key factor is also the application practice.” Taking into account just the formal signs, the Czech bankruptcy law resembles in many aspects the German law, which is characterized as rather creditor-oriented. However, as Mitchell notes, it resembles the U.S. law in the important aspect that it makes the initiation of bankruptcy difficult. Taking into account the application of the law, we can say that it is heavily debtor-oriented.

### **3 Ex-post Efficiency: Czechs in an International Comparison**

Scholars studying particular bankruptcy designs vary in their approach to efficiency. Some authors examine what happens with a firm already in bankruptcy.<sup>10</sup> This analysis, however, is not complete, as it deals with the *ex-post efficiency* only, not accounting for the effects on actions taken prior to bankruptcy, i.e., neglecting the problem of *ex-ante efficiency*. Moreover, it has been argued that the ex-ante efficiency view is superior to that of the ex-post efficiency view as the latter serves just as an instrument to achieve the

---

<sup>9</sup> The most striking case was that of a medium-sized bank, Union banka. This case sparked an investigation that uncovered an existence of a network reaching high levels of the state administration.

<sup>10</sup>See, for example, Bebchuk (1988), Aghion et al. (1992), or Hart (2000) for proposals of ex-post efficient bankruptcy designs and Kordana and Posner (1998) for a positive analysis of the ex-post efficiency under the U.S. bankruptcy law.

former.<sup>11</sup>

For instance, an expected danger of creditors' expropriation in bankruptcy has adverse effects on their willingness to lend money ex ante.<sup>12</sup> Similarly, when debtors know that they will lose both control and cash-flow rights once bankruptcy is declared, they may tend to excessive risk-taking and delaying bankruptcy filing once they privately observe that the firm might be soon on the verge of bankruptcy – a perverse behavior known also as “gambling on resurrection” or “fourth-quarter football”.<sup>13</sup>

In the remainder of this paper we deal with ex-post efficiency criterion. That is, we are concerned about what happens with the firm once it has gone bankrupt. Thus, in this paper, we neglect the ultimate ex-ante effects of the way that Czech bankruptcy procedures look like but we claim that if we want to understand ex-ante effects of the Czech bankruptcy law, understanding the ex-post efficiency is a necessary first step.

Based on the literature on bankruptcy it can be argued that a bankruptcy procedure is ex-post efficient if it does not last too long, if the administrative costs are not too high, if the recovery of the claims is sufficiently high, and if the liquidation/continuation decision is made efficiently. Observing the empirical evidence on bankruptcy procedures around the world, one finds out that the Czech Republic is lagging behind other industrial economies in all of these measures.

This picture is persuasively documented by the results of the World Bank's research project called Doing Business, based on the methodology developed in Djankov, Hart, Nenova and Shleifer (2003). There are seven mentions of the Czech Republic in the Chapter "Closing Business" of the World Bank's *Doing Business 2004: Understanding Regulation* (WorldBank

---

<sup>11</sup>See, for example Bebchuk (2001).

<sup>12</sup>See, for example, Biais and Recasens (2002) for the analysis of a tradeoff between ex-ante credit rationing and ex-post socially inefficient liquidation or Berglof et al. (2003) for the analysis of a tradeoff between ex-ante benefits and ex-post costs of having multiple creditors.

<sup>13</sup>See, for example, Akerlof and Romer (1994), Opler, Pinkowitz, Stulz and Williamson (1999), Hart (2000), Janda (2004), and Knot and Vychodil (2005a).

(2004)). All of these mentions are negative and include statements about long duration, high costs, or low priority to new debt issued within bankruptcy. In this section we summarize the position of the Czech bankruptcy procedures as concerns (1) duration, (2) administrative cost, (3) recovery rate, and (4) liquidation/continuation decision.

### 3.1 Duration

Czech Bankruptcy procedures are very lengthy. World Bank (2004) provides estimates for the average time to complete a procedure in 142 countries over the world. As shown in Figure 1, according to this time measure (which takes into account delays due to legal derailment tactics that parties to the insolvency may use, in particular extension of response periods or appeals) Czech bankruptcy procedures are the fourth lengthiest in the world, lasting 9.2 years.<sup>14</sup> Figure 2 then provides a tragical comparison of Czech procedures with those of other EU-member states and EU-candidate states.

Figure 1: Duration – 142 Countries of the World

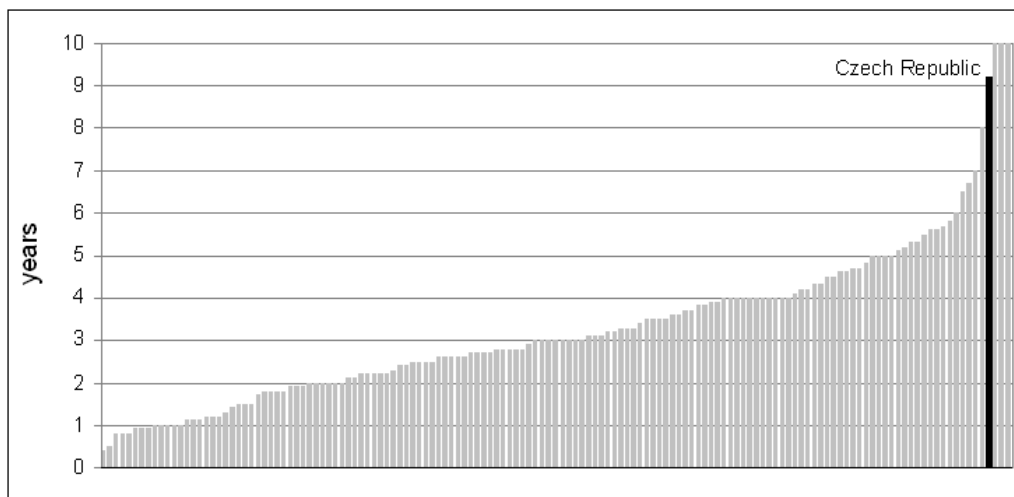

Source: World Bank’s data on ‘Closing Business 2004’.

<sup>14</sup>Only Brazil, Chad and India are worse off with the duration estimate of 10 years.

Figure 2: Duration – 22 EU-members and 4 EU-candidates

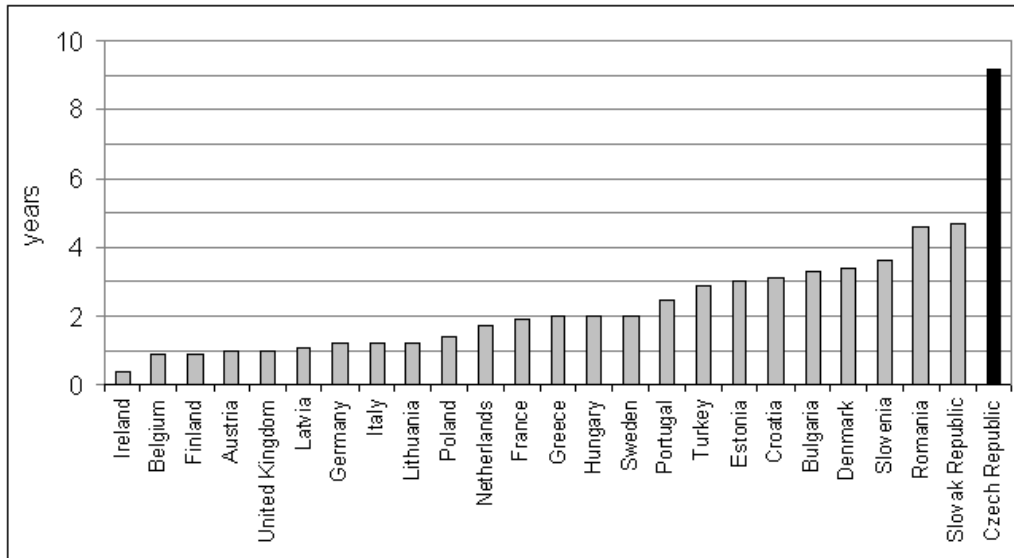

Source: World Bank's data on 'Closing Business 2004'.

Note: As of today, there are 25 members in the EU and 4 candidates. Malta, Cyprus and Luxembourg are not included in the sample of the World Bank.

Many observers of the Czech reality point out that the estimate of 9.2 years is rather overstated.<sup>15</sup> Nevertheless, even these observers emphasize that Czech bankruptcies do take excessively long time to be completed. Indeed, inspecting the data of the Ministry of Justice on Czech bankruptcies in 2002, we can observe that the composition of almost 9,000 cases pending as of the end of that year was as depicted in Figure 3. This suggests that the time measure of 9.2 years represents the maximum rather than the average duration – this actually complies with the World Bank's methodology which includes all possible delays. However, having half of all cases pending older than three years and half of those even older than five years is not a positive result either.

<sup>15</sup>See, for example, Klimes (2004).

Figure 3: Composition of Pending Cases in 2002

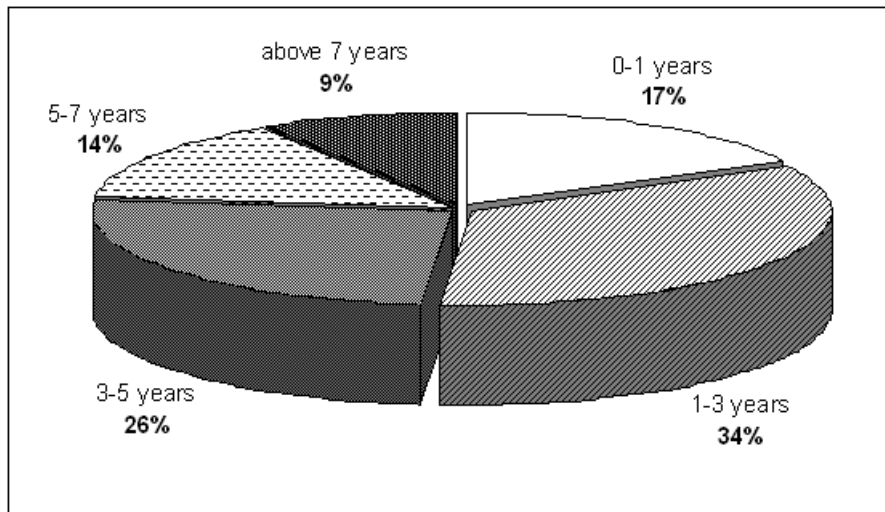

Source: Ministry of Justice and [www.ejustice.cz](http://www.ejustice.cz).

Note: In total 8802 cases pending (after bankruptcy declaration and before bankruptcy completion) as of the end of 2002.

### 3.2 Administrative Costs

Another aspect that determines the ex-post efficiency of a bankruptcy procedure is its administrative cost. Once bankruptcy is declared, the realized returns on the assets left in the company are not used solely for repaying the creditors (or pleasing other stakeholders such as employees and trade partners via preserving going concern). Certain portion must be also paid to the bankruptcy trustee, to the court, independent assessors, lawyers, accountants, etc. These costs are included in the cost measure as reported for 142 countries by the World Bank (2004).

As Figure 4 shows, Czech procedures swallow something between sixteen and twenty percent of the estate, which is comparable to some of the other new EU-member states but is significantly above the average of all EU-members and EU-candidates. Within the sample of 142 countries in the world, the Czech Republic shares the 73rd-113th position.



Figure 4: Administrative Cost – 22 EU-members and 4 EU-candidates

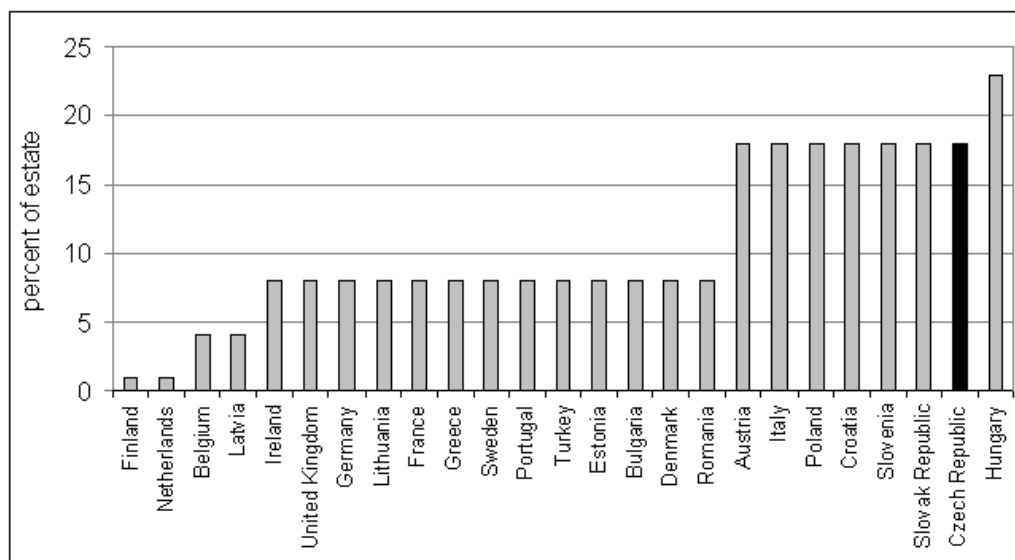

Source: World Bank’s data on ‘Closing Business 2004’.

Note: The cost figures are averages of the estimates in a multiple-choice question, where the respondents choose among the following options: 0-2 percent, 3-5 percent, 6-10 percent, 11-15 percent, 16-20 percent, 21-25 percent, 26-50 percent, and more than 50 percent of the estate value of the bankrupt business. Thus values 1, 4, 8, 18, and 23 denote the first, second, third, fifth, and sixth band.

### 3.3 Recovery Rate

Even if a bankruptcy procedure is rather lengthy and demands high administrative costs, it may still bring high returns to the creditors. This might be the case when:

1. the declaration of bankruptcy does not come too late so that the value of the firm’s assets in the beginning of the procedure still represents a reasonable portion of the firm’s debt, and
2. the work of the judges, trustees, assessors etc. is efficient so that the payment of administrative cost is worth it.

The World Bank’s estimates of how many cents on the dollar claimants – creditors, tax authorities, and employees – recover from an insolvent firm

assign to the Czech Republic the 104th position within the world ranking. Standing within the EU context is provided in Figure 5. 16.8 percent estimate of the Czech recovery rate is far the lowest within the EU. Of the four candidate countries only Romania performs worse.

Figure 5: Recovery Rate – 22 EU-members and 4 EU-candidates

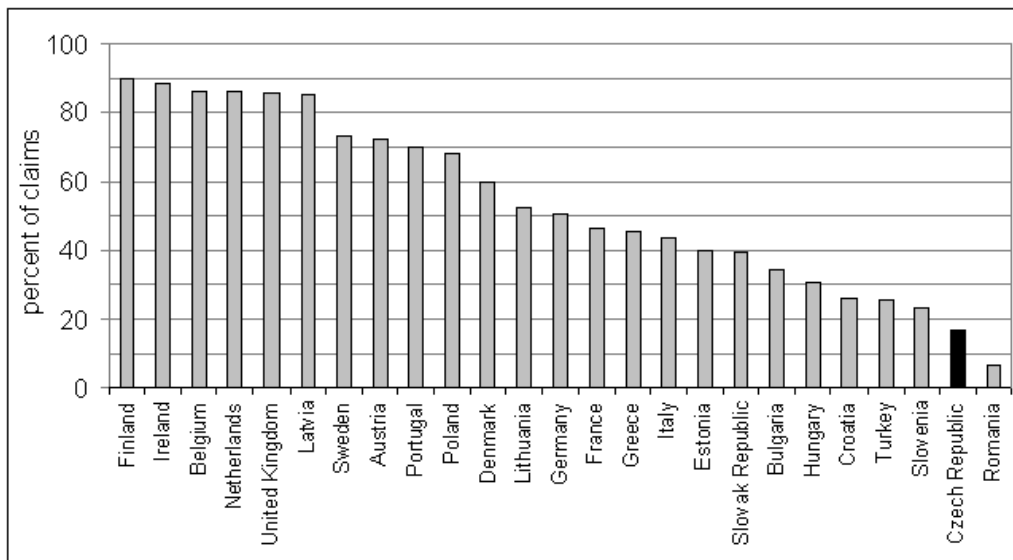

Source: World Bank’s data on ‘Closing Business 2004’.

Note: The calculation takes into account whether the business is kept as a going concern during the proceedings, as well as court, attorney and other related costs, and the discounted value due to the time spent closing down. If the business keeps operating, no value is lost on the initial claim, set at 100 cents on the dollar.

Before moving to the fourth aspect, something can be said about the relationship between the three mentioned so far. Intuitively, one can assume that the longer a bankruptcy procedure lasts, the more costly it is and the lower recovery to the claims it produces (although cost and recovery are not exact opposites as mentioned in the beginning of this section). Figure 6 confirms this logic using again the World Bank’s sample of 142 observations.

Figure 6: Cost, Time, Recovery

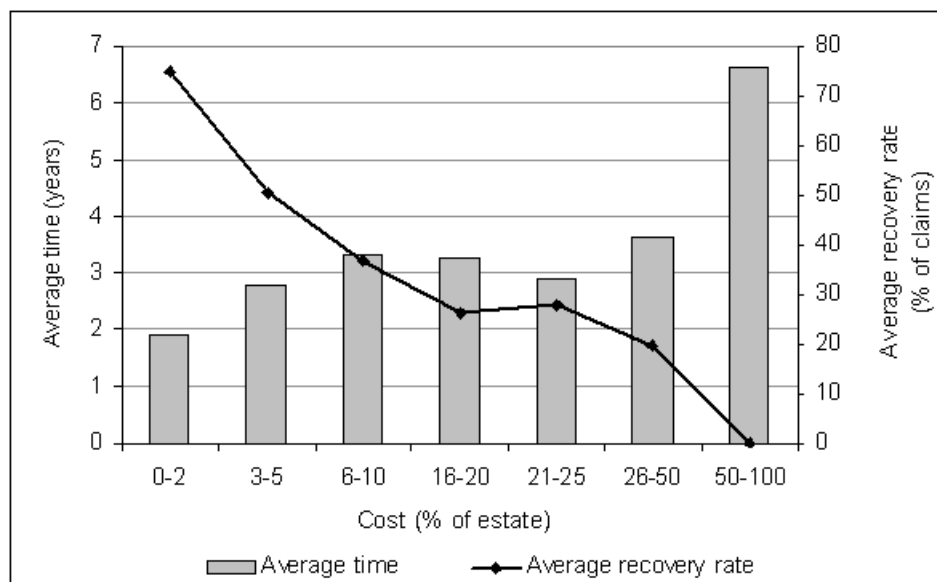

Source: World Bank's data on 'Closing Business 2004'.

Note: Based on the sample of 142 countries. There is no observation within the band of costs between 11 and 15. The numbers of observations within the reported bands of costs are 5, 20, 48, 41, 4, 21, and 3, respectively.

### 3.4 Liquidation/Continuation Decision

Apart from the three above-mentioned characteristics measured by the World Bank (2004), an equally important one is whether the choice between liquidating the firm or preserving the going concern value by continuation of its operation is made efficiently. It has been empirically documented that in some countries bankruptcy procedures are biased towards liquidation, while in others we can rather observe over-continuation.<sup>16</sup> Throughout the literature, the scope of liquidation is considered ex-post efficient if only those firms whose liquidation value exceeds the value of continuation are liquidated. Liquidation value is simply the sum of the assets when sold on the market. However, authors differ in understanding the value of continuation.

<sup>16</sup>See, for example, Franks and Sussman (1999), Franks et al. (1994) or Bayer (2003).

Some researchers<sup>17</sup> limit their consideration to the continuation value for the firm's residual claimants, i.e., for creditors. These authors talk about *going concern value* which might exceed the liquidation value when the assets are to a large extent specific to the firm and/or when the insolvency is the result of financial rather than economic distress.

Other authors<sup>18</sup> approach the value of continuation more broadly as including *social costs* (i.e., negative externalities) *of liquidation*, such as firm-specific capital acquired by employees, firm-specific investment made by suppliers/customers, and damages to citizens' everyday life linked to the existence of the firm (reduced employment, consumption, supply of the firm's products, demand for the firm's inputs etc.).

No matter which approach is chosen, it is evident that the Czech bankruptcy system is biased towards liquidation. The Czech law defines two types of procedures:

- bankruptcy (Czech term *konkurs*) – framework for liquidation,
- composition (Czech term *vyrovnani*) – framework for continuation.

Composition, being in general more flexible and more debtor-friendly than bankruptcy, represents a faster and less costly solution to the situation of insolvency. However, it is much less frequent, as it requires an agreement on the redesign of property rights over the debtor's assets to be reached between the debtor and the creditors.

Only the debtor can file for composition and he can do so unless the court has already adjudicated a bankruptcy proceeding. A composition can consist in issuance of new shares or other securities issued by the debtor or even in kind, e.g., in surrendering of a part of values not immediately connected with the debtor's entrepreneurial activity. Within the composition application, creditors who have no priority must be offered payment of at least 30% of their claims within two years from submission of the application. Necessary

---

<sup>17</sup>See, for example, Baird and Rasmussen (2003).

<sup>18</sup>See, for example, Biais and Recasens (2002).

conditions for the court to confirm the composition include that priority claims have been paid or their payment has been assured and that creditors of other claims have been satisfied to the same extent unless they agreed to a more advantageous satisfaction of a certain creditor.

Insolvent debtors in the Czech Republic opt for composition very rarely. The reason for virtually no use of composition is the fact that only a few debtors are able to fulfill strict legal requirements while proposing a solution acceptable for creditors. This did not change even after the amendment to the Act made in May 2000 which reduced the minimum that has to be offered to creditors without priority from 45% to 30%. And as the returns from bankruptcy proceedings very rarely reach 30% debtors lack reasons for opting for composition. Thus, as shown in Table 2, bankruptcy proceedings have been used as an almost exclusive solution to insolvency situations in the Czech economy.

Table 2: Bankruptcy vs. Composition

Year	Unresolved from past		New petitions filed		Petitions approved	
	B	C	B	C	B	C
1998	6,013	14	4,289	17	2,019	3
2000	9,694	10	4,618	32	2,489	2
2002	10,370	17	3,985	17	2,146	9
2004	9,724	20	3,627	16	1,435	6

Note: “B” denotes bankruptcy, “C” denotes composition.  
Source: Ministry of Justice and [www.ejustice.cz](http://www.ejustice.cz).

## 4 Ex-Post Efficiency:

### Data on Czech Procedures in 2004

To make a more in-depth analysis of the Czech case from the ex-post efficiency viewpoint, we have collected recent data on Czech firms in bankruptcy. We

used data publicly available in the Commercial Register (*Obchodni rejstrik*) and Register of Bankrupts (*Evidence upadcu*) and data available in a paid database Commercial Bulletin (*Obchodni vestnik*) which includes also data gathered in the Collection of Deeds (*Sbirka listin*).<sup>19</sup>

We collected data on all cases that were completed during 2004 by the distribution of returns among claim-holders. In 2004, there were 1158 bankruptcies completed by the distribution of bankruptcy returns among the firm's claimants. Out of these, we excluded 255 bankruptcies of individuals to get a sample of 903 companies. To present our sample in the whole context, we illustrate Czech bankruptcy procedure by the following simplified scheme.

In general, a petition can be filed by the debtor or a creditor. The court either rejects it for one of the reasons listed in the law or declares bankruptcy. After bankruptcy is declared, it can basically have two alternative fates. Either the bankruptcy is stopped for lack of assets, or – and these are the cases in our sample – it is completed by the distribution of returns among the claimants.

Table 3: Bankruptcies and Compositions in 2004

	B	C	B+C
New petitions filed	3,627	16	3,643
- by debtor	2,318	16	2,334
- by creditor	1,309	-	1,309
Petitions approved	1,435	6	1,441
Procedures completed	1,997	5	2,002
- for lack of assets	795	-	795

Source: Ministry of Justice.

---

<sup>19</sup>Some data that the law prescribes to be submitted to the Collection of Deeds are available electronically within the Commercial Bulletin database, some are only archived at the courts in a paper form (and have not been made electronically accessible yet), and some have not been submitted at all. Our sample includes only the electronically reported ones. Even these must be collected manually, as the databases on the Internet do not allow for an automatic export of the data.

As documented by Table 3 which summarizes some data of the Ministry of Justice on bankruptcies in 2004, there were about 3,600 petitions filed in that year – 64% by the debtor, 36% by a creditor. The number of bankruptcies declared in 2004 was about 1,400. Out of about 2,000 completed cases in 2004, 40% were stopped for the lack of assets. Thus the number of cases completed by the distribution of returns among claimants was at most sixty percent of all completed cases. One should have this in mind while analyzing the sample.

## 4.1 Variables

The data that we know for each of these 903 companies include:

- Legal form – corporation, limited liability, partnership, cooperative, other.
- Jurisdiction – 7 court dummies.
- Ruling judge – 85 judge dummies.
- Bankruptcy trustee(-s) – dummy indicating whether trustee was replaced during bankruptcy or not.
- Liquidation – dummy indicating whether the company was in liquidation when it entered bankruptcy or not.<sup>20</sup>
- Duration – months elapsed between the month of bankruptcy declaration and the month of the bankruptcy proceeds' division among creditors.

Other characteristics are available for a subset of observations only:

- Equity – available for 877 companies. The remaining 26 companies, which do not report any equity in the Commercial Register, include all 13 "v.o.s." companies, 7 of 61 cooperatives, and 6 of 20 "other" companies.

---

<sup>20</sup>Here liquidation is meant in the sense that the Czech law understands it.

- Who filed bankruptcy petition – available for 431 companies and missing for the other 472 companies.
- Debt repayment for the second class creditors (in percent) – available for 544 companies. For the remaining 359 companies, the court did not publish the distribution list neither in the electronic version of Sbirka listin, nor in the electronic version of Obchodni vestnik.

## 4.2 Sample Statistics

Let us now provide a description of the sample via these variables.

**Legal form.** The sample includes 110 corporations (*a.s.*), 697 limited liability companies (*s.r.o.*), 12 "v.o.s." companies, 3 "k.s." companies (these 15 we can call together partnerships),<sup>21</sup> 61 cooperatives (*druzstvo*), and 20 other companies (these include also 16 state enterprises and 1 national enterprise).

**Courts and judges.** There are seven bankruptcy courts in the Czech Republic – five in Bohemia (Prague, Plzen, Ceske Budejovice, Hradec Kralove, and Usti nad Labem) and two in Moravia (Brno and Ostrava). We will also refer to these courts as Pr, Pl, C, H, U, B, and O, respectively. Although the number of cases varies across the seven courts, none of the courts seems to be more overloaded than others as higher number of cases is connected with adequately higher number of judges. In each court there are roughly ten cases per judge. As shown in Figure 7, Plzen, Ceske Budejovice and Usti nad Labem constitute a cluster with the number of judges between 5 and 8 and a low number of cases, Hradec Kralove, Brno and Ostrava another cluster with 12 to 15 bankruptcy judges and a medium number of cases, and the Prague's court has 24 judges and 236 cases.

---

<sup>21</sup>v.o.s. and k.s. denote verejna obchodni spolecnost and komanditni spolecnost, respectively.



Figure 7: Judges and Cases per Court

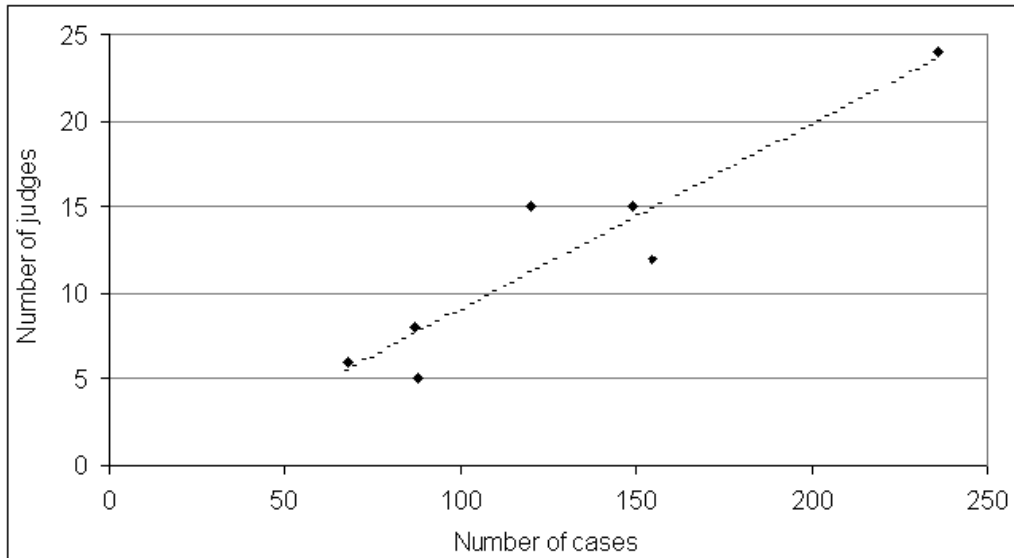

Note: Depicted points refer (from left to right) to bankruptcy courts of Ceske Budejovice, Usti nad Labem, Plzen, Brno, Hradec Kralove, Ostrava, and Praha.

**Bankruptcy trustees.** According to the Czech law, the power to appoint and replace a bankruptcy trustee is entrusted to the judge. Creditors may suggest a trustee's replacement but the judge has the final word. Within the sample a trustee was replaced in 88 cases (10%).

**Liquidation.** 192 of the companies (21%) were already in the procedure of liquidation (i.e., a voluntary dissolution) when entering bankruptcy.

**Duration.** Duration ranges from 11 to 127 months with the mean at 50.6 months. Figure 8 illustrates the variance of the sample as for duration.

**Equity.** As shown in Figure 9, two fifths of the 877 companies (for which entity is reported) have equity of exactly CZK 100 thousand which is the minimum requirement for limited liability companies, one third moves between CZK 100 thousand and CZK 1 million, and one quarter of the companies are larger.

Figure 8: Histogram of Duration

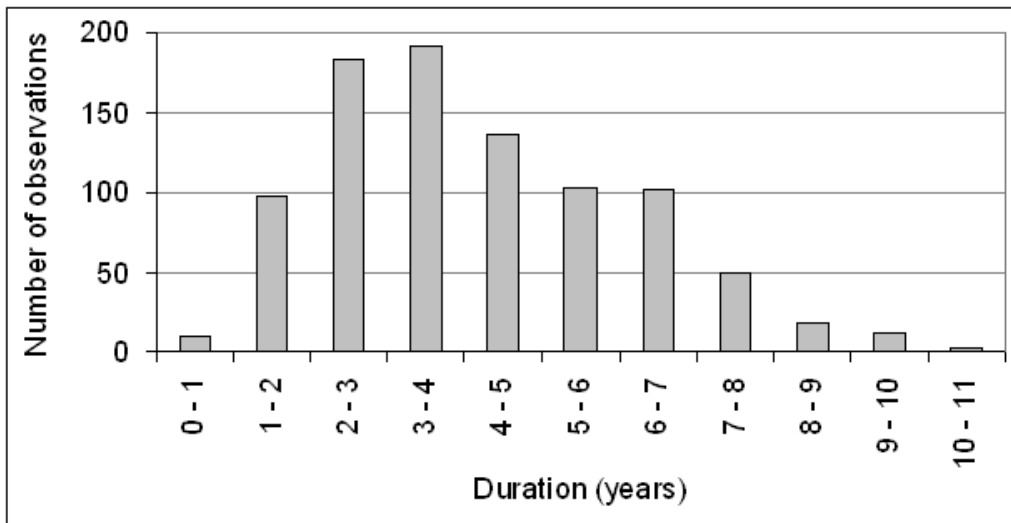
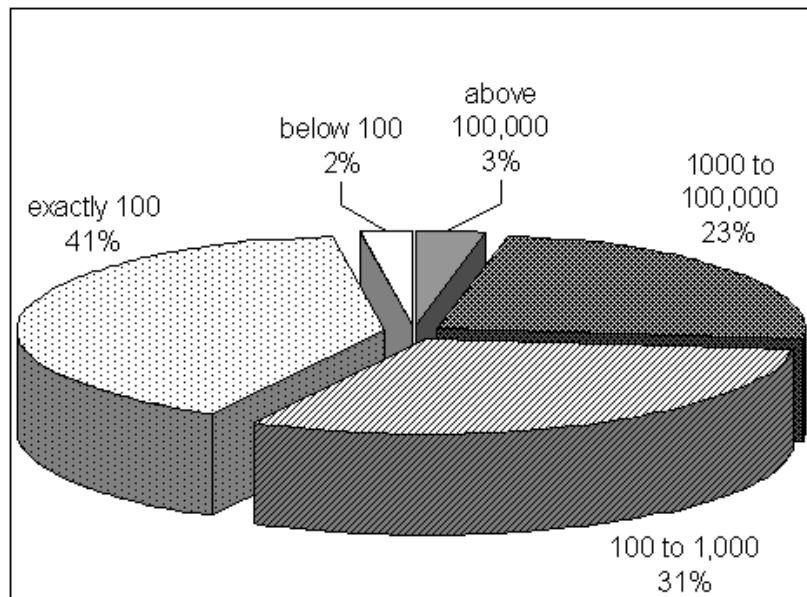

Figure 9: Cases by Equity



**Who filed bankruptcy petition.** In 275 cases of the 431 reported cases the petition was filed by the company itself, while in the remaining 156 cases

by its creditors.

**Debt repayment.** The returns to the second class creditors are available for 544 firms. The average duration for these firms (i.e., firms whose final distribution lists were published on the web) is 49.8 months, while that for the remaining 359 firms is 51.9. Only in 102 out of the 544 observed returns to the second class creditors (19%) exceed 10 percent, while the average return for the other 442 firms (81%) is 2.2 percent. The distribution of returns is illustrated in Figure 10.

Figure 10: Distribution of Returns to the Second Class Creditors

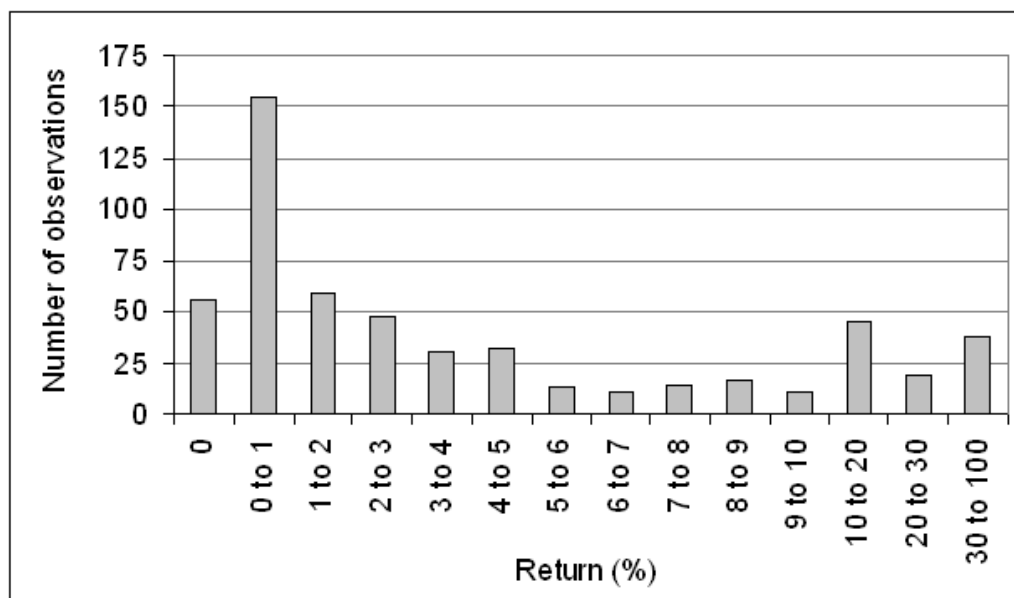

An interesting statistical observation is provided in Figure 11 – average duration of the cases differs across courts. While an average bankruptcy case of in the whole sample lasted just a bit more than four years, an average case in Usti nad Labem took full six years which is almost by fifty percent above the average. Besides this negative deviation in Usti, we observe a somewhat smaller positive deviation in Plzen and Ostrava with about three and a half

year on average. When comparing medians instead of means, the difference of Usti from the other courts gets even more obvious.

Figure 11: Duration by Courts

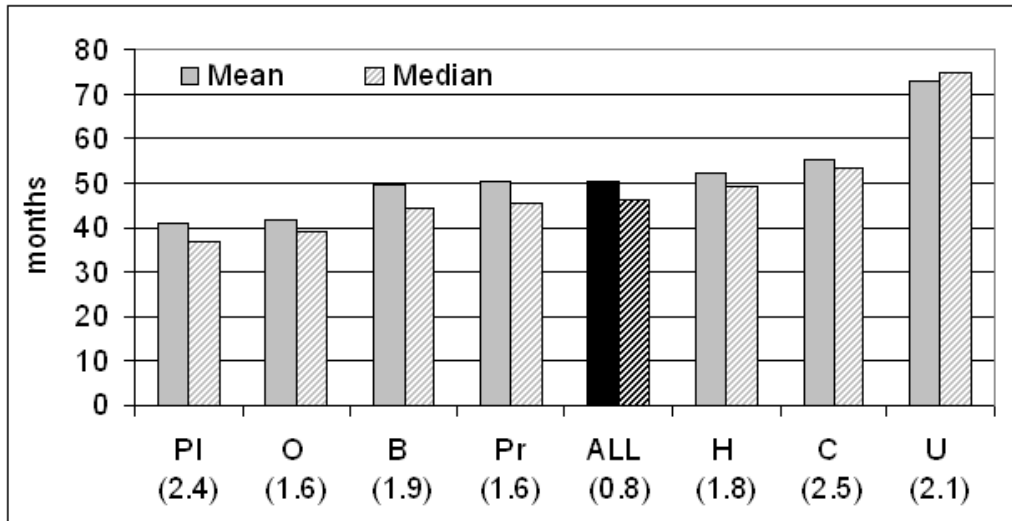

Note: Standard errors in parentheses.

## 5 Conclusion

In this paper, we provided some facts on Czech bankruptcy procedures that can support the claim made by many that the procedures are very inefficient in the ex-post viewpoint. We observe that it takes on average from four to five years after bankruptcy is declared to reach the final division of the “remnants” to the creditors. These “remnants” are in a vast majority of cases an insignificant fraction of the initial claims. It is still to be inspected, to what extent this is due to the factor of time and to what extent high administrative costs play a role.

In general, other steps to be done for better understanding of the ex-post inefficiency of Czech bankruptcy procedures would be analysis of determinants of the bankruptcy outcomes (i.e., of duration and returns) and closer inspection of the differences across courts or maybe even across judges to carefully address the issues of judicial discretion, capability of judges to make commercial decisions and maybe even judicial corruption. For this analysis of what happens in Czech bankruptcy procedures and why, other variables than those that we deal with are needed.

All in all, we have dealt with ex-post efficiency only, which means that we provided some clues for answering the question *How efficiently are the assets of a firm reallocated once the firm has gone bankrupt*. Yet more important questions to be answered are those related to the ex-ante efficiency of the Czech bankruptcy procedures: What does the (in)efficiency of this reallocation imply for all other firms that are not in bankruptcy? How the incentives for agents in the economy – such as those for entrepreneurs to start new projects, managers to gamble on resurrection, companies to trigger bankruptcy early enough, banks to provide credit, or creditors in general to monitor their debtors – are affected?

## References

- Aghion, P., Hart, O. and Moore, J.: 1992, The Economics of Bankruptcy Reform, *Journal of Law, Economics and Organization* **8**(3), 523–46.
- Akerlof, G. A. and Romer, P. M.: 1994, Looting: The Economic Underworld of Bankruptcy for Profit, NBER Working Paper No. 1869.
- Atiyas, I.: 1995, Bankruptcy Policies: A Comparative Perspectives, Private Sector Development Department, The World Bank, Working Paper.
- Baird, D. G. and Rasmussen, R. K.: 2002, The End of Bankruptcy, *Stanford Law Review* .
- Baird, D. G. and Rasmussen, R. K.: 2003, Chapter 11 at Twilight, *Stanford Law Review* **56**(3), 673–700.
- Bayer, J. D.: 2003, Troubled Company Investments in Germany, BBvR Restructuring Briefs.
- Bebchuk, L.: 1988, A New Approach to Corporate Reorganizations, *Harvard Law Review* **101**, 775–804.
- Bebchuk, L. A.: 2001, Ex Ante Costs of Violating Absolute Priority in Bankruptcy, CEPR Discussion Paper No. 2914.
- Berglof, E., Roland, G. and von Thadden, E.-L.: 2003, Optimal Debt Design and the Role of Bankruptcy, Universit de Lausanne, Ecole des HEC, DEEP, Working Paper.
- Berglof, E. and Rosenthal, H.: 2000, The Political Economy of American Bankruptcy: The Evidence from Roll Call Voting, 1800-1978, Princeton University Working Paper.
- Berkovitch, E. and Israel, R.: 1998, Optimal Bankruptcy Laws Across Different Economic Systems, William Davidson Institute at the University of Michigan Business School, Working Paper.

- Berkovitch, E., Israel, R. and Zender, J. F.: 1998, The Design of Bankruptcy Law: A Case for Management Bias in Bankruptcy Reorganizations, *Journal of Financial and Quantitative Analysis* **33**(4).
- Berkowitz, D., Pistor, K. and Richard, J.-F.: 2003, Economic Development, Legality, and the Transplant Effect, *European Economic Review* **47**(1), 165–195.
- Biais, B. and Malecot, J.-F.: 1996, Incentives and Efficiency in the Bankruptcy Process: The Case of France., World Bank, Private Sector Development Department, Occasional Paper No. 23.
- Biais, B. and Recasens, G.: 2002, Corrupt Judges, Credit Rationing and the Political Economy of Bankruptcy Laws, Bank of England, Conference Proceedings, September 2002.
- Bradley, M. and Rosenzweig, M.: 1992, The Untenable Case for Chapter 11, *Yale Law Journal* **101**(5), 1043–95.
- Bris, A., Welch, I. and Zhu, N.: 2004, The Costs of Bankruptcy Chapter 7 Cash Auctions vs. Chapter 11 Bargaining.
- Brown, D. T.: 1989, Claimholder Incentive Conflicts in Reorganization: The Role of Bankruptcy law, *Review of Financial Studies* **2**(1), 109–23.
- Claessens, S. and Klapper, L. F.: 2002, Bankruptcy Around the World: Explanations of Its Relative Use, World Bank Policy Research Working Paper No. 2865.
- Diblik, J.: 2004, Konkurz a vyrovnani – teorie a ceska praxe (Bankruptcy and Composition – Theory and the Czech Reality), Charles University in Prague, Institute of Economic Studies, Working Paper.
- Djankov, S., Hart, O., Nenova, T. and Shleifer, A.: 2003, Efficiency in Bankruptcy, Harvard University, Department of Economics, Working Paper.

- Fisher, T. and Martel, J.: 1995, The Creditors' Financial Reorganization Design: New Evidence from Canadian Data, *Journal of Law, Economics and Organization* (11), 112–26.
- Fisher, T. and Martel, J.: 1999, Should We Abolish Chapter 11: Evidence from Canada, *Journal of Legal Studies* (28), 233–57.
- Franks, J. R., Nyborg, K. and Torous, W.: 1994, A Comparison of U.S., U.K. and German Insolvency Codes, *Financial Management* pp. 86–101.
- Franks, J. R. and Sussman, O.: 1999, Financial Innovations and Corporate Insolvency, London Business School, Working Paper.
- Franks, J. R. and Sussman, O.: 2000, An Empirical Study of Financial Distress of Small Bank-Financed U.K. Companies: A Reassessment of English Insolvency Law, London Business School, Working Paper.
- Franks, J. R. and Torous, W. N.: 1989, An Empirical Investigation of U.S. Firms in Reorganization, *The Journal of Finance* **44**(3), 747–67.
- Franks, J. R. and Torous, W. N.: 1994, A Comparison of Financial Recontracting in Distressed Exchanges and Chapter 11 Reorganizations, *Journal of Financial Economics* **35**(3), 349–70.
- Gertner, R. and Scharfstein, D.: 1991, A Theory of Workouts and the Effects of Reorganization Law, *Journal of Finance* **46**(4), 1189–1222.
- Giammarino, R. M. and Nosal, E.: 1996, The Efficiency of Judicial Discretion in Bankruptcy Law, University of British Columbia, mimeo.
- Gilson, S. C., John, K. and Lang, L.: 1990, Troubled Debt Restructuring: An Empirical Study of Private Reorganization of Firms in Default, *Journal of Financial Economics* **27**(2), 315–353.
- Hart, O.: 2000, Different Approaches to Bankruptcy, NBER Working Paper No. 7921.



- Janda, K.: 2004, Bankruptcy Procedures with Ex Post Moral Hazard, In: Kotabova, V., Prazova, I., and Schneider, O. (eds.): *The Development of the Czech Society in the European Union*, Matfyzpress, Praha, 199–217.
- Klimes, J.: 2004, Bankrot: teorie, ceska uprava a praxe (Bankruptcy: Theory, Czech Law and Reality), Charles University in Prague, Institute of Economic Studies, Working Paper.
- Knot, O. and Vychodil, O.: 2005a, Contracting and Monitoring Prior to Bankruptcy: The Uneasy Case for the Violation of Absolute Priority Rule, CERGE-EI Prague, mimeo.
- Knot, O. and Vychodil, O.: 2005b, What Drives the Optimal Bankruptcy Law Design?, *Czech Journal of Economics and Finance (Finance a uver)* **55**(3-4), 110–123.
- Kordana, K. A. and Posner, E. A.: 1998, A Positive Theory of Chapter 11, University of Chicago Law School, John M. Olin Law and Economics Working Paper No. 61.
- La Porta, R., Lopez-de Silanes, F., Shleifer, A. and Vishny, R.: 1997, Legal Determinants of External Finance, *The Journal of Finance* **52**(3), 1131–50.
- La Porta, R., Lopez-de Silanes, F., Shleifer, A. and Vishny, R.: 1998, Law and Finance, *Journal of Political Economy* **106**(6), 1113–1155.
- Lambert-Mogiliansky, A., Sonin, C. and Zhuravskaya, E.: 2003, Capture of Bankruptcy: A Theory and Evidence from Russia, Center for Economic and Financial Research in Moscow, Working Paper.
- Lizal, L.: 2001, Determinants of Financial Distress: What Drives Bankruptcy in a Transition Economy? The Czech Republic Case, CERGE-EI Prague Discussion Paper.

- LoPucki, L. M.: 2003a, A Team Production Theory of Bankruptcy Reorganization, UCLA Law School, Law and Econ Research Paper No. 3-12.
- LoPucki, L. M.: 2003b, The Nature of the Bankrupt Firm: A Reply to Baird and Rasmussen's The End of Bankruptcy, *Stanford Law Review* **56**(3).
- Mitchell, J.: 1998, Bankruptcy Experience in Hungary and the Czech Republic, William Davidson Institute Working Paper, University of Michigan Business School.
- Opler, T., Pinkowitz, L., Stulz, R. and Williamson, R.: 1999, The Determinants and Implications of Corporate Cash Holdings, *Journal of Financial Economics* **52**(1), 3–46.
- Rajan, R. G. and Zingales, L.: 1995, What Do We Know about Capital Structure? Some Evidence from International Data, *The Journal of Finance* **50**(5), 1421–60.
- Richter, T.: 2004, Studie k návrhu zákona o upadku a způsobech jeho řešení (Paper on the Draft of a New Czech Insolvency Act), Rada pro rozvoj podnikatelského prostředí, Praha.
- Richter, T.: 2005, Základní stavební kameny vládního návrhu insolvenčního zákona (Building Blocks of the Government Draft of Insolvency Act), *Právní fórum* (11/2005), 442–447.
- Schwartz, A.: 1998, A Contract Theory Approach to Corporate Bankruptcy, *The Yale Law Journal* **107**(6), 1807–51.
- Sotak, M.: 2005, Specifickost aktiv a české insolvenční právo (Asset Specificity and the Czech Insolvency Law), Charles University in Prague, Institute of Economic Studies, M.A. Thesis.
- Warren, E.: 1992, The Untenable Case for Repeal of Chapter 11, *The Yale Law Journal* **102**(2), 437–82.

- Warren, E.: 1993, Bankruptcy Policy Making in an Imperfect World, University of Pennsylvania, mimeo.
- White, M. J.: 1992, The Corporate Bankruptcy Decision, *Journal of Economic Perspectives* **3**(2), 129–62.
- White, M. J.: 2005, Economic Analysis of Corporate and Personal Bankruptcy and Law, NBER Working Paper No. 11536.
- Wihlborg, C.: 2002, Insolvency and Debt Recovery Procedures in Economic Development – An Overview of African Law, WIDER Discussion Paper No. 2002/27, United Nations University.
- Wood: 1995, Principles of International Insolvency, London Sweet and Maxwell, London.
- WorldBank: 2004, Doing Business 2004: Understanding Regulation, Database available at <http://rru.worldbank.org/DoingBusiness>.

# IES Working Paper Series

2005

1. František Turnovec: *New Measure of Voting Power*
2. František Turnovec: *Arithmetic of Property Rights: A Leontief-type Model of Ownership Structures*
3. Michal Bauer: *Theory of the Firm under Uncertainty: Financing, Attitude to Risk and Output Behaviour*
4. Martin Gregor: *Tolerable Intolerance: An Evolutionary Model*
5. Jan Zápál: *Judging the Sustainability of Czech Public Finances*
6. Wadim Strielkowski, Cathal O'Donoghue: *Ready to Go? EU Enlargement and Migration Potential: Lessons from the Czech Republic in the Context of the Irish Migration Experience*
7. Roman Horváth: *Real Equilibrium Exchange Rate Estimates: To What Extent Are They Applicable for Setting the Central Parity?*
8. Ondřej Schneider, Jan Zápál: *Fiscal Policy in New EU Member States: Go East, Prudent Man*
9. Tomáš Cahlík, Adam Geršl, Michal Hlaváček and Michael Berlemann: *Market Prices as Indicators of Political Events- Evidence from the Experimental Market on the Czech Republic Parliamentary Election in 2002*
10. Roman Horváth: *Exchange Rate Variability, Pressures and Optimum Currency Area Criteria: Implications for the Central and Eastern European Countries*
11. Petr Hedbávný, Ondřej Schneider, Jan Zápál: *A Fiscal Rule That Has Teeth: A Suggestion for a "Fiscal Sustainability Council" Underpinned by the Financial Markets*
12. Vít Bubák, Filip Žikeš: *Trading Intensity and Intraday Volatility on the Prague Stock Exchange: Evidence from an Autoregressive Conditional Duration Model*
13. Peter Tuchyňa, Martin Gregor: *Centralization Trade-off with Non-Uniform Taxes*
14. Karel Janda: *The Comparative Statics of the Effects of Credit Guarantees and Subsidies in the Competitive Lending Market*
15. Oldřich Dědek: *Rizika a výzvy měnové strategie k převzetí eura*
16. Karel Janda, Martin Čajka: *Srovnání vývoje českých a slovenských institucí v oblasti zemědělských finance*
17. Alexis Derviz: *Cross-border Risk Transmission by a Multinational Bank*
18. Karel Janda: *The Quantitative and Qualitative Analysis of the Budget Cost of the Czech Supporting and Guarantee Agricultural and Forestry Fund*
19. Tomáš Cahlík, Hana Pessrová: *Hodnocení pracovišť výzkumu a vývoje*
20. Martin Gregor: *Committed to Deficit: The Reverse Side of Fiscal Governance*
21. Tomáš Richter: *Slovenská rekodifikace insolvenčního práva: několik lekcí pro Českou republiku*
22. Jiří Hlaváček: *Nabídková funkce ve vysokoškolském vzdělávání*
23. Lukáš Vácha, Miloslav Vošvrda: *Heterogeneous Agents Model with the Worst Out Algorithm*
24. Kateřina Tsolov: *Potential of GDR/ADR in Central Europe*
25. Jan Kodera, Miroslav Vošvrda: *Production, Capital Stock and Price Dynamics in a Simple Model of Closed Economy*
26. Lubomír Mlčoch: *Ekonomie a štěstí – proč méně může být více*

27. Tomáš Cahlík, Jana Marková: *Systém vysokých škol s procedurální racionalitou agentů*
28. Roman Horváth: *Financial Accelerator Effects in the Balance Sheets of Czech Firms*
29. Natálie Reichlová: *Can the Theory of Motivation Explain Migration Decisions?*
30. Adam Geršl: *Political Economy of Public Deficit: Perspectives for Constitutional Reform*
31. Tomáš Cahlík, Tomáš Honzák, Jana Honzáková, Marcel Jiřina, Natálie Reichlová: *Convergence of Consumption Structure*
32. Luděk Urban: *Koordinace hospodářské politiky zemí EU a její meze*

## 2006

1. Martin Gregor: *Globální, americké, panevropské a národní rankingy ekonomických pracovišť*
2. Ondřej Schneider: *Pension Reform in the Czech Republic: Not a Lost Case?*

All papers can be downloaded at: <http://ies.fsv.cuni.cz>

