

Doktorandské dny '07

**Ústav informatiky
Akademie věd České republiky, v. v. i.**

**Malá Úpa
17. – 19. září 2007**

vydavatelství Matematicko-fyzikální fakulty
Univerzity Karlovy v Praze

Ústav informatiky AV ČR, v. v. i., Pod Vodárenskou věží 2, 182 07 Praha 8

Všechna práva vyhrazena. Tato publikace ani žádná její část nesmí být reprodukována nebo šířena v žádné formě, elektronické nebo mechanické, včetně fotokopíí, bez písemného souhlasu vydavatele.

© Ústav informatiky AV ČR, v. v. i., 2007
© MATFYZPRESS, vydavatelství Matematicko-fyzikální fakulty
Univerzity Karlovy v Praze 2007

ISBN – *not yet* –

Obsah

<i>Jana Adášková:</i> Computational Systems for Selection and Prioritization of Candidate Genes that Underlie Human Hereditary Disease	2
<i>Václav Faltus:</i> Population Characteristics in Forensic Genetics	8
<i>Kateřina Jurková:</i> Graph Partitioning Driven by Elimination Structures	13
<i>Pavel Juruš:</i> Utilization of the Data Assimilation Infrastructure for Coupled Environmental Forecasts	19
<i>Ondřej Konár:</i> Nelineární model se smíšenými efekty pro odhad spotřeby zemního plynu	25
<i>David Kozub:</i> Learning of Multilayer Perceptrons with Piecewise-Linear Activation Functions	29
<i>Zdeňka Linková:</i> Schema Matching in the Semantic Web Environment	36
<i>Miroslav Nagy:</i> Communication Problems Among Heterogenous EHR Systems	43
<i>Radim Nedbal:</i> Various Kinds of Preferences in Database Queries	49
<i>Vendula Papíková:</i> Online vyhledávání lékařských doporučení pomocí cílených (vertikálních) vyhledávačů	60
<i>Martin Plešinger:</i> Úplný problém nejmenších čtverců v úlohách s násobnou pravou stranou	70

<i>Petra Přečková:</i> Jazyk lékařských zpráv	75
<i>Martin Řimnáč:</i> Redukce datových modelů	80
<i>Stanislav Stušný:</i> Neural Networks for Evolutionary Robotics	87
<i>Roman Špánek:</i> Maintaining Trust in Large Scale Environments	94
<i>David Štefka:</i> Confidence of Classification in Classifier Combining	103
<i>Pavel Tyl:</i> Problematika integrace ontologií	110
<i>Martin Vejmelka:</i> Detecting Synchronized States from Bivariate Time Series	116

Doktorandské dny Ústavu informatiky AV ČR, v. v. i., se konají již podvanácté, nepřetržitě od roku 1996. Tento seminář poskytuje doktorandům, podílejícím se na odborných aktivitách Ústavu informatiky, možnost prezentovat výsledky jejich odborného studia. Současně poskytuje prostor pro oponentní připomínky k přednášené tematice a použité metodologii práce ze strany přítomné odborné komunity.

Z jiného úhlu pohledu, toto setkání doktorandů podává průřezovou informaci o odborném rozsahu pedagogických aktivit, které jsou realizovány na pracovištích či za spoluúčasti Ústavu informatiky.

Jednotlivé příspěvky sborníku jsou uspořádány podle jmen autorů. Uspořádání podle tematického zaměření nepovažujeme za účelné, vzhledem k rozmanitosti jednotlivých témat.

Vedení Ústavu informatiky jakožto organizátor doktorandských dnů věří, že toto setkání mladých doktorandů, jejich školitelů a ostatní odborné veřejnosti povede ke zkvalitnění celého procesu doktorandského studia zajišťovaného v součinnosti s Ústavem informatiky a v neposlední řadě k navázání a vyhledání nových odborných kontaktů.

1. září 2007

Computational Systems for Selection and Prioritization of Candidate Genes that Underlie Human Hereditary Disease

Post-Graduate Student:

MGR. JANA ADÁŠKOVÁ

Department of Medical Informatics
Institute of Computer Science of the ASCR, v. v. i.
Pod Vodárenskou věží 2
182 07 Prague 8, CZ
adaskova@euromise.cz

Supervisor:

PROF. RNDR. JANA ZVÁROVÁ , DRSc.

Department of Medical Informatics
Institute of Computer Science of the ASCR, v. v. i.
Pod Vodárenskou věží 2
182 07 Prague 8, CZ
zvarova@euromise.cz

Field of Study:
Biomedical Informatics

The work was supported by the grant 1M06014 of the Ministry of Education of the Czech Republic.

Abstract

The aim of this paper is to present an overview of six independent computational methods for the selection and prioritization of candidate genes for human diseases and, rather than selecting a best method, to offer the prospective user a better understanding of the inputs, outputs and functionality of each available method. A survey of these methods also offers the bioinformatics community an opportunity to assess the efficacy of current computational approaches to disease gene identification, and informs future directions for research in this field.

Keywords: candidate gene selection, prioritization, data mining, text mining, human hereditary disease.

1. Introduction

Few areas have moved as fast as human disease gene identification. Before 1980, very few human genes had been identified as disease loci. In the 1980s, advances in recombinant DNA technology allowed a new approach, positional cloning, sometimes given the rather meaningless label "reverse genetics" [11]. The number of disease genes identified started to increase quickly. Now the human and other genome projects have made available a vast range of resources - maps, clones, sequences, expression data and phenotypic data. Identifying novel disease genes has become commonplace and is currently occurring on a weekly basis. Some of the routes that have been followed to identify human disease genes summarizes Figure 1. If the figure seems complicated, that is because there is no standard procedure for gene identification. All pathways converge on mutation testing in a candidate gene, but there is not one single entry point, and there is no unique pathway to the candidate gene. For discussion of the principles, we can divide the methods into those that do not require us to know the chromosomal location of the disease locus and those that depend on this knowledge. Most genes are identified by defining a candidate gene on the basis of both its

chromosomal location and its properties [11].

Unlike Mendelian traits, in which a mutation in one gene is causative, or oligogenic traits, where several genes are sufficient but not necessary, complex traits are caused by variation in multiple genetic and environmental factors, none of which are sufficient to cause the trait [8]. The contribution of any given gene to a complex trait is usually modest. In addition, complex traits often encompass a variety of phenotypes and biological mechanisms, making it difficult to determine which genes to study [7].

As a result, traditional methods of genetic discovery, such as linkage analysis and positional cloning, while widely successful in identifying the genes for Mendelian traits, have had more limited success in identifying genes for complex traits. Candidate gene studies have had encouraging success, yet this approach requires an effective method for deciding a priori which genes have the greatest chance of influencing susceptibility to the trait [3]. Recent advances in genotyping technology have provided researchers with the ability to test association in hundreds of genes relatively quickly, and even the entire genome through a genome-wide association study.

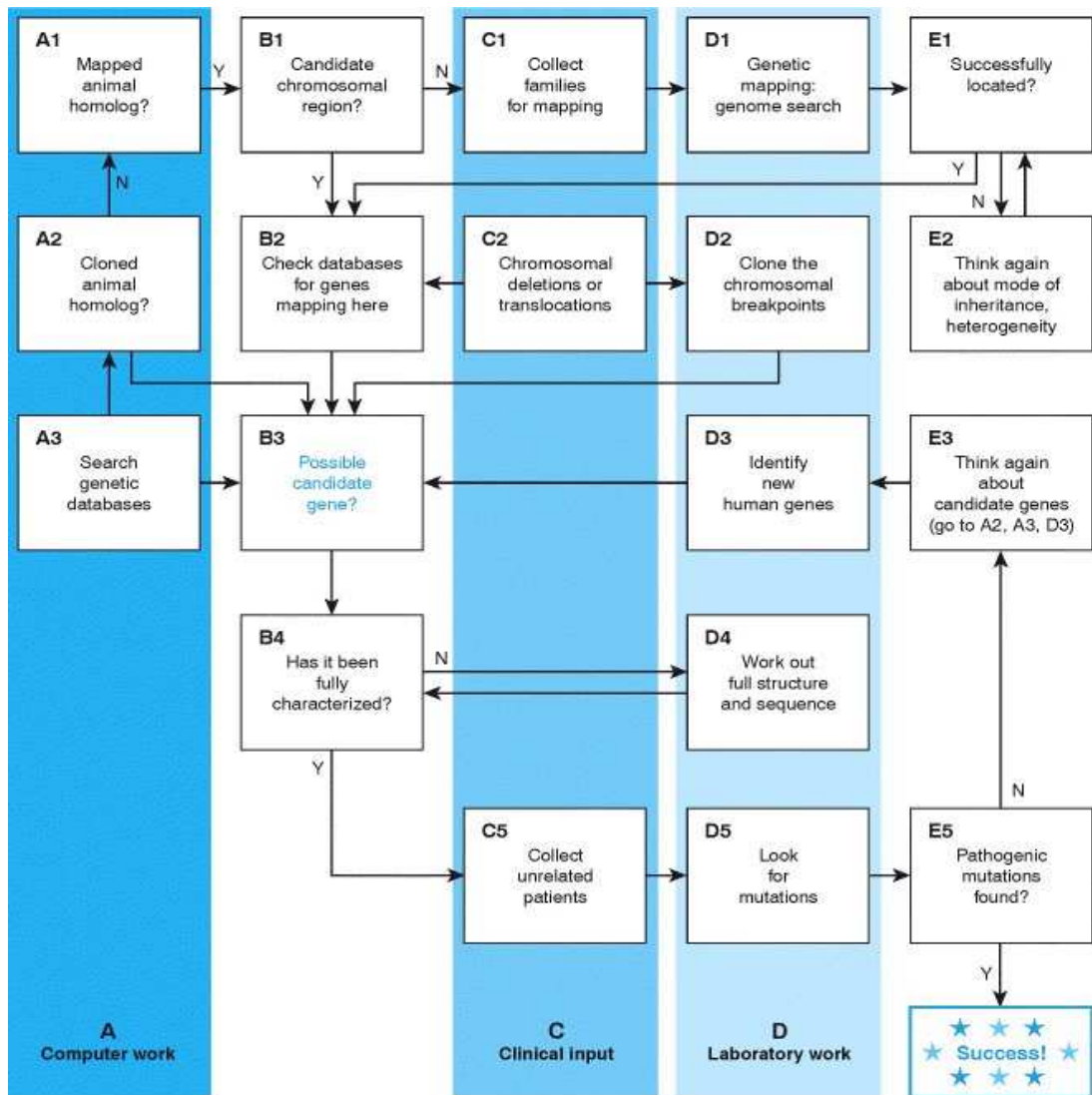

Figure 1: Scheme of the routes to identify human disease genes.

Therefore, one of the greatest challenges in disease association study design remains the intelligent selection of candidate genes. For this reason, during the past five years, the problem of automating the prioritization of candidate genes to inherited diseases has received increasing attention from the bioinformatics community. Computational approaches were made possible due to the availability of the complete human genome sequence and to considerable developments on database annotation and data integration for molecular biology databases [10]. As a result, a number of methods that address this problem have been published. These methods apply a variety of approaches exploiting known or deduced pieces of information that range from using only the genomic sequence of the target region to data mining analysis that include literature and different annotation systems. In this paper we present more details about six

independent methods and what we believe to be useful illustration of application of these methods.

2. Existing methods

Note: Detail information about data sources and ontologies used in methods are listed in Table 1 at the end.

2.1. PROSPECTR

It can be shown that genes implicated in disease share certain patterns of sequence based features that can provide a good basis for automatic prioritization of candidate genes by machine learning [2]. PROSPECTR (PRIorization by Sequence & Phylogenetic Extent of CandidaTe Regions) is an alternating decision tree which has been trained to differentiate between genes

likely to be involved in disease and genes unlikely to be involved in disease. This alternating decision tree with fifteen nodes was produced by training on the training set of genes. PROSPECTR requires only basic sequence information and by using this sequence-based features like gene length, protein length and the percent identity of homologs in other species as input a score (ranging from 0 to 1) can be obtained for any gene of interest. The score itself is a measure of confidence in the classification. Genes with scores over a certain threshold, 0.5, are classified as likely to be involved in some form of human hereditary disease while genes with scores under that threshold are classified as unlikely to be involved in disease. Given this score we can also roughly estimate how much more or less likely it is that a particular gene is involved in human hereditary disease.

Tests on an independent data set of genes taken from the Human Gene Mutation Database suggest that PROSPECTR will, on average, enrich a list of about 200 genes two-fold 74 % of the time, five-fold 33 % of the time and twenty-fold 8 % of the time. 95 % of the time the list was enriched one and a half fold - that is to say that the target gene was in the top three-quarters of the ranked list [2].

The web interface of PROSPECTR allows researchers to obtain a ranked list of genes ordered by the scores for regions of the genome or individual gene of interest. The software is now freely accessible together with training and test sets of genes at URL: www.genetics.med.ed.ac.uk/prospectr/.

2.2. SUSPECTS

SUSPECTS is a consolidated candidate gene approach that combines the increased precision of annotation-based methods with the better recall of sequence-based methods. Given a set of existing candidate genes for a particular complex or oligogenic disease, it effectively automates further candidate gene selection from large regions on the principle that genes involved in that disease will tend to share the same or similar annotation, reflecting common biological pathways [1]. In principle SUSPECTS is built on top of the PROSPECTR candidate prioritization system by incorporating annotation data from Gene Ontology (GO), InterPro and expression libraries.

The server takes two inputs - firstly, the coordinates of the genomic region that you are interested in. You can specify this using markers, bands, chromosomal coordinates or genes. The second input is a list of genes thought to be involved in pathogenesis of the same complex disease as the one you are interested in (as a shortcut,

you may simply enter the name of the disease; The software will automatically retrieve genes implicated in that disorder from databases OMIM, the HGMD and GAD). This list is known as the "training set".

Each gene in the region of interest is then scored automatically on its suitability as a candidate for further study based on four lines of evidence: first by PROSPECTR (*see above*) on the basis of its sequence features, second by the extent of coexpression with the training set based on GNF (Genomics Institute of the Novartis Research Foundation) expression data (scores depend on how well correlated any matching profiles are), third by the number of rare (found in <5 % of all proteins) InterPro domains shared with the training set and finally by the level of semantic similarity that the GO (Gene Ontology) terms assigned to it share with the GO terms assigned to genes in the training set [1]. The four scores are then combined. Each score is weighted depending on the amount of information available for each line of evidence. If little or no information is available then the importance of that score is decreased accordingly. This ensures that the scores of genes which lack sufficiently detailed GO terms or expression profiles do not suffer from annotation bias.

The final score ranges from 0 to 100. Higher scores represent better candidates. The list of candidate genes ranked by score is presented as the graphical overview of region of interest which is a hyperlinked image map that can be used to obtain more detailed information about each candidate gene and the reasoning behind its score.

SUSPECTS significantly improves on the performance on candidate prioritization methods which use annotation or sequence data alone and is of value to researchers faced with large regions of interest. SUSPECTS is freely available on the World Wide Web at www.genetics.med.ed.ac.uk/suspects/.

2.3. Disease Gene Prediction (DGP)

DGP (Disease Gene Prediction) is a database of human genes with their probability of being involved in a hereditary disease. The genes that are already known to be involved in monogenic hereditary disease have been shown to follow specific sequence property patterns that would make them more likely to suffer pathogenic mutations. Based on these patterns, DGP is able to assign probabilities to all the genes that indicate their likelihood to mutate solely based on their sequence properties. This probability has been assigned with a data mining algorithm using parameters that have been shown to follow specific trends in the already known disease genes. In particular, the properties analysed by DGP are

protein length, degree of conservation, phylogenetic extent and paralogy pattern [6].

The performance of this method has been assessed previously on a test dataset by building a model with a part of the data (learning set: 75 %) and testing with the rest (test set: 25 %). On average 70 % of the disease genes in the test set were predicted correctly with 67% precision [6]. Genes involved in complex diseases, similarly to monogenic disease genes, need to have mutations or variations in the gene sequence that impair or modify the function or expression of the protein they encode, leading to a disease phenotype. Thus, we believe that, although DGP has been designed for the prediction of Mendelian diseases, it can also be useful for the identification of complex-disease genes as it will identify those genes with higher likelihood of suffering mutations. DGP is freely available on the World Wide Web at <http://cgg.ebi.ac.uk/services/dgp/>.

2.4. GeneSeeker

GeneSeeker is a web-based data mining tool that filters positional candidate disease genes based on expression and phenotypic data from both human and mouse. It queries nine different databases through the web, guaranteeing that the most recent data are used at all times and removing the need for local repositories, and then combines this information using Boolean operators. This results in a quick overview of candidate genes in the genetic region of interest. The GeneSeeker system is built in a modular fashion, making it easy to maintain and expand [4]. The GeneSeeker is freely available via the web interface at www.cmbi.ru.nl/geneseeker/.

The input for GeneSeeker is the genetic mapping information. This can be a chromosome, a chromosome arm, or a range and if necessary, a combination of genetic localization can be also entered. Second input is the tissue names where either direct RNA expression or phenotypic expression of the candidate gene is expected. The query entered by the user is pre-processed for Human and Mouse databases and subsequently reformulated into the format appropriate for each database. GeneSeeker uses the Genome Database (GDB) and the Online Mendelian Inheritance in Man (OMIM) to obtain human mapping data. Genes searched in specified chromosome location in humans are also translated with the aid of an "Oxford-grid", to search the appropriate Mouse databases (e.g. Mouse Genome Database (MGD)). The key tissues affected by the genetic disorder are used to query phenotypic or expression related databases, including the OMIM phenotype fields, Swissprot, and Medline for data on human phenotypes and the Gene Expression Database (GXD), the Transgenic/Targeted Mu-

tation Database (TBASE), and the Mouse Locus Catalog (MLC) for gene expression patterns and phenotypes in mice [4]. The output of the analysis is presented in four tables: (1) A list of human genes in the correct genetic region and matching the specified expression profile, (2) a list of mouse genes matching the syntenic region as well as the expression profile, but with no matching human gene name, (3) a list of mouse genes found in the syntenic region in mouse, for which the homologous human gene is found to map outside the critical interval, and (4) a list of all the remaining human genes that are present in the genetic interval, but which do not match the expression profile.

In a test using 10 syndromes, GeneSeeker reduced the candidate gene lists from an average of 163 position-based candidate genes to an average of 22 candidates based on position and expression or phenotype [4]. Though particularly well suited for syndromes in which the disease gene shows altered expression patterns in the affected tissues, it can also be applied to more complex diseases.

2.5. Genes to Disease (G2D)

G2D (Genes to Diseases) is a web resource for prioritizing genes as candidates for inherited diseases using a combination of data mining on biomedical databases and gene sequence analysis. It uses three algorithms based on different prioritization strategies. The input to the server is the genomic region where the user is looking for the disease-causing mutation, plus an additional piece of information depending on the algorithm used. This information can either be the disease phenotype (described as an Online Mendelian Inheritance in Man (OMIM) identifier), one or several genes known or suspected to be associated with the disease (defined by their Entrez Gene identifiers), or a second genomic region that has been linked as well to the disease. In the latter case, the tool uses known or predicted interactions between genes in the two regions extracted from the STRING (Search Tool for the Retrieval of Interacting Proteins) database [9].

The G2D system scores all terms in GO (Gene Ontology) according to their relevance to each disease starting from MEDLINE queries featuring the name of the disease. This is done by relating symptoms to GO terms through chemical compounds, combining fuzzy binary relations between them previously inferred from the whole MEDLINE and RefSeq databases. Then, to identify candidate genes in a given a chromosomal region, G2D (Genes to Diseases) performs BLASTX (search protein databases using a translated nucleotide query) searches of the region against all the (GO annotated) ge-

nes in RefSeq. All hits in the region with an E-value $< 10e^{-10}$ are registered and sorted according to the GO-score of the RefSeq gene they hit (the average of the scores of their GO annotations) [10].

The output in every case is an ordered list of candidate genes in the region of interest. For the first two of the three methods, the candidate genes are first retrieved through sequence homology search, then scored accordingly to the corresponding method. This means that some of them will correspond to well-known characterized genes, and others will overlap with predicted genes, thus providing a wider analysis [9]. G2D is publicly available at <http://coot.embl.de/g2d/>. Additionally, it is possible to access from this server a database of pre-calculated results for more than 550 monogenic diseases on published linkage regions using the phenotype method.

In a test with 100 diseases chosen at random from OMIM (Online Mendelian Inheritance in Man), using bands of 30 Mb [the average size of linkage regions], G2D detected the disease gene in 87 cases. In 39 % of these it was among the best three candidates, and in 47 % among the best 8 candidates [9].

2.6. CAESAR

CAESAR (CandidatE Search And Rank) represents a novel selection strategy in that it combines text and data mining to associate genetic information with extracted trait knowledge in order to prioritize candidate genes. CAESAR exploits the knowledge of complex traits in literature by using ontologies to semantically map the trait information to gene and protein-centric information from several different public data sources, including tissue-specific gene expression, conserved protein domains, protein-protein interactions, metabolic pathways and the mutant phenotypes of homologous genes [5]. CAESAR uses four possible methods of integration to combine the results of data searches into a prioritized candidate gene list. In contrast to PROSPECTR, SUSPECTS, DGP and GENESEEKER, gene selection is not limited to one or more genomic regions, as all genes annotated in one of the databases are potential candidates.

CAESAR is comprised of three main steps: text mining, data mining and data integration. It requires a body of text (referred to as corpus) describing the biology of a trait as its only input. Recommended forms of input text include published trait review articles and trait OMIM records. First, genes mentioned in the input text are identified and ontology terms are ranked based on their similarity to an input text. Second, genes are ranked for each

data source independently based on the relevance of the ontology terms with which they are annotated. Third, the individual gene lists are integrated to provide a single ranked list of candidate genes that combines evidence from all data sources [5].

CAESAR can be used to prioritize a smaller number of candidates within a region of linkage, or to prioritize among polymorphisms annotated with ranked genes that show significant association in a genome-wide study. However this method is particularly valuable for complex traits, which may be affected by a wider array of biological processes, some of which may not have been directly implicated by previous studies. CAESAR also reports the evidence supporting the prioritization rank of each gene, allowing an investigator to trace the line of reasoning and to exercise his or her own judgment as to its validity. Thus, it can be seen as a very sophisticated aid to prioritization [5]. Currently, CAESAR can only be accessed by downloading and running locally. Test data can be downloaded from <http://visionlab.bio.unc.edu/caesar/>.

In a test of its effectiveness, CAESAR successfully selected 7 out of 18 (39 %) complex human trait susceptibility genes within the top 2 % of ranked candidates genome-wide, a subset that represents roughly 1 % of genes in the human genome and provides sufficient enrichment for an association study of several hundred human genes [5].

3. Conclusion and future work

This short overview of six independent computational methods for identifying candidate disease genes was given together with references to available literature and web tools. As shown here, computational prediction of disease relevant genes must be regarded as an extremely hard problem, with probably no biomedical optimal solution attainable at all. No computational system can select candidate genes with certainty. More than ever, one cannot expect to predict these genes with high confidence by one single method. Instead, information about candidate genes gained by different independent methods has to be combined. Candidate genes selected by more methods with very diverse data inputs may carry more weight than a candidate genes selected only by using one single method.

The presented paper should be seen as a small step of our ongoing work, using computational methods to select a subset of the most likely candidate genes in cardiovascular disease for their next empirical validation.

Source		URL	Records	Content
Ontology				
MP	Mammalian phenotype ontology	www.informatics.jax.org	3 850	Phenotype
eVOC	eVOC anatomical ontology	www.evoontology.org/	394	Anatomy
GO bp	Gene ontology biological process	www.geneontology.org/	9 687	Function
GO mf	Gene ontology molecular function	www.geneontology.org/	7 055	Function
Database				
OMIM	Online Mendelian Inheritance in Man	www.ncbi.nih.gov/	16 564	Disease
Gene	Entrez Gene	www.ncbi.nih.gov/	32 859	Gene
Ensemble		www.ensembl.org/	20 134	Gene
SwissProt		www.ebi.ac.uk/uniprot/	13 434	Expression
TrEMBL	Nucleotide sequence database	www.ebi.ac.uk/uniprot/	57 551	Expression
InterPro	Protein domain database	www.ebi.ac.uk/interpro/	12 542	Domain
BIND	Biomolecular interaction	www.bind.ca/	35 661	Interaction
HPRD	Human protein reference database network database	www.hprd.org/	33 710	Interaction
KEGG	Kyoto encyclopedia of genes genomes pathway database	www.genome.jp/kegg/	209	Pathway
MGD	Mouse genome database	www.informatics.jax.org/	7 705	Phenotype
GAD	Genetic association database	http://hpcio.cit.nih.gov/gad.html	8 176	Association
GOA	Gene ontology annotation database	www.ebi.ac.uk/goa/	27 768	Function
RefSeq	Reference sequence	www.ncbi.nlm.nih.gov/RefSeq/	10 329	Gene
HGMD	Human gene mutation database	www.hgmd.cf.ac.uk/ac/index.php		Gene Mutation
GNF	Genomics Institute of the Novartis Research Foundation database	www.hgmd.cf.ac.uk/ac/index.php		Expression
MEDLINE		http://medline.cos.com/	10 752 796	References

Table 1: Information about data sources and ontologies used in methods.

References

- [1] E. A. Adie, R. R. Adams, K. L. Evans, D. J. Porteos, B. S. Pickard, "SUSPECTS: Enabling Fast and Effective Prioritization of Positional Candidates", *Bioinformatics*, vol. 22 (6), pp. 773–774, 2006.
- [2] E. A. Adie, R. R. Adams, K. L. Evans, D. J. Porteos, B. S. Pickard, "Speeding Disease Gene Discovery by Sequence Based Candidate Prioritization", *BMC Bioinformatics*, vol. 6, pp. 55, 2005.
- [3] M. Dean, "Approaches to Identify Genes for Complex Human Diseases: Lessons from Mendelian Disorders", *Hum. Mutat.*, vol. 22, pp. 261–274, 2003.
- [4] M. A. van Driel, K. Cuelenaere, P. Kemmeren, J. Leunissen, H. Brunner, "A New Web-based Data Mining Tool for the Identification of Candidate Genes for Human Genetic Disorders", *European Journal of Human Genetics*, vol. 11, pp. 57–63, 2003.
- [5] K. J. Gaulton, K. L. Mohlke, T. J. Vision, "Computational System to Select Candidate Genes for Complex Human Traits", *Bioinformatics*, vol. 23 (9), pp. 1132–1140, 2007.
- [6] N. López-Bigas, Ch. A. Ouzonis, "Genome-wide Identification of Genes Likely to be Involved in Human Genetic Disease", *Nucleic Acids Research*, vol. 32, pp. 3108–3114, 2004.
- [7] C. Newton-Cheh, J. Hirschhorn, "Genetic Association Studies of Complex Traits: Design and Analysis Issues", *Mutation Research*, vol. 573, pp. 54–69, 2005.
- [8] L. Peltonen, V. McKusick, "Genomics and Medicine: Dissecting Human Disease in the Postgenomic Era", *Science*, vol. 291, pp. 1224–1229, 2001.
- [9] C. Perez-Iratxeta, P. Bork, M. A. Andrade, "G2D: a Tool for Mining Genes Associated with Disease", *BMC Genetics*, vol. 6, pp. 45, 2005.
- [10] C. Perez-Iratxeta, P. Bork, M. A. Andrade, "Update of the G2D Tool for Prioritization of Gene Candidates to Inherited Diseases", *Nucleic Acids Research*, vol. 35, pp. W1–W5, 2007.
- [11] T. Strachan, A. Read, "Human Molecular Genetics 2", *BIOS Scientific Publishers Ltd*, 1999.

Population Characteristics in Forensic Genetics

Post-Graduate Student:

MGR. VÁCLAV FALTUS, MSc.

Department of Medical Informatics
Institute of Computer Science of the ASCR, v. v. i.
Pod Vodárenskou věží 2

182 07 Prague 8, CZ

faltus@euromise.cz

Supervisor:

PROF. RNDR. JANA ZVÁROVÁ, DRSc.

Department of Medical Informatics
Institute of Computer Science of the ASCR, v. v. i.
Pod Vodárenskou věží 2

182 07 Prague 8, CZ

zvarova@euromise.cz

Field of Study:
Biomedical Informatics

The work was supported by the grant 1M06014 of the Ministry of Education of the Czech Republic.

Abstract

The aim of this paper is to present some methods used in forensic genetics. Forensic genetics is only one part of a wide spectrum of sciences called forensics. It includes identification of victims of natural disasters, mass transportation accidents and industry accidents. It also includes identification of offenders of a crime and determination of paternity. Our current work involves analysis of the genetic data from the Czech population. Therefore and in concordance with other international studies, we focus on methods used in analysis of the genetic profiles of the STR (short tandem repeat) polymorphisms.

Keywords: forensic genetics, identification, STR, statistical methods.

1. Introduction

Within cells, DNA is organized into structures called chromosomes and the set of chromosomes within a cell is called genome. All genes are arranged linearly along the chromosomes. There are 23 pairs of chromosomes in a human body. Almost every cell then contains two sets of chromosomes, one from each parent, 23 chromosomes inherited from mother and 23 from father. One chromosome is the sex chromosome and the others are called autosomal chromosomes. There are areas at chromosomes that we call loci. One locus can contain a gene, part of a gene or only short sequence of nucleotides - letters of the genetic code. Accordingly locus is only an area on particular chromosome described by its unique number. The genes are, what give us lungs, brains, bones, hair-color, allow us to reproduce and think. But there is also plenty of DNA which is proved or believed to have no effect on any processes in our body - the junk DNA.

In DNA there are places (loci) where patterns of two or more nucleotides repeat and where the repeated sequences are adjacent to each other. STR (Short Tandem Repeat) loci are loci, where we observe not very large count of those repetitions. The pattern repetition length (x) usually varies from 2 to 10 letters of the genetic code. The number of adjacent sequences usually varies from 1 to 35. These counts do not need to be integers. If there is only few (say r) first letters (less than n) of the pattern sequence at the end of the loci we write the length

of the STR as decimal number $x.r$. Although is it not very common, the different lengths of the STR loci can be called alleles. As it was already mentioned one autosomal chromosome consists of two parts, one from each parent. Therefore there are two corresponding STR loci and one allele is maternal and one paternal. By combining an information from several STR loci we get the genotype of the individual. In forensic genetics this is usually called the genetic profile. You can see one example in Table 1.

locus	a_f	a_s	locus	a_f	a_s
D3S1358	17	18	D16S539	12	13
TH01	8	9.3	CSF1PO	10	12
D21S11	28	30	PentaD	10	13
D18S51	13	14	Amelo	X	Y
PentaE	5	10	vWA	16	16
D5S818	8	11	D8S1179	13	13
D13S317	12	13	TPOX	11	11
D7S820	8	10	FGA	21	23.2

Table 1: Example genetic profile

Since the STR loci are very polymorphic, they are sometimes called STR polymorphisms instead of STR loci. This polymorphous nature makes them very useful in forensic genetics. Second characteristics is that the STR loci typically lie in the non-coding region of DNA which makes them the junk DNA. Therefore it is believed that selection pressure does not influence these loci.

The genetics profiles are useful in situations when we are looking for particular individuals. In other situations the individual profile information can be neglected and the database helps to estimate the allele frequencies. Let n denote the total number of alleles existing on one locus. The information from that locus can then be summarized into a Table 2 where g_{ij} ($i, j = 1, \dots, n, i \leq j$) are the counts of observed genotypes in the population. Because it is usually not possible to determine which allele was inherited from which parent, the the upper right corner of the table is empty with the genotype counts added to the bottom left corner of the table.

	a_1	a_2	\dots	a_n
a_1	g_{11}			
a_2	g_{12}	g_{22}		
\vdots	\vdots	\vdots	\ddots	
a_n	g_{1n}	g_{2n}	\dots	g_{nn}

Table 2: General genotype table

In this paper we start with explaining the terms homo- and heterozygosity. Then we turn to average match probability, discrimination power, polymorphic information content, average exclusion probability and typical paternity index. All statistics presented here will also be demonstrated on one locus from [1] and as future work will be implemented into the R package forensic [2]. We take the STR locus denoted $D13S317$. All information from this locus is summarized in Table 3.

	8	9	10	11	12	13	14	15
8	16							
9	20	8						
10	19	3	3					
11	124	64	47	131				
12	69	51	30	192	70			
13	26	23	18	64	61	12		
14	10	7	5	27	24	8	0	
15	0	0	0	0	2	0	0	0

Table 3: STR locus D13S317

2. Population Statistics

Homo- and heterozygosity, average match probability, discrimination power, polymorphic information content, average exclusion probability and typical paternity index are all straightforward statistics used in forensic genetics. They help in planning and performing genetic experiments as well as in national programs for identification of victims and crime offenders.

2.1. Homo- and heterozygosity

An individual is called homozygote when its both alleles of one gene are the same and it is called heterozygote if the alleles differ. When analysing the STR data, the individual is homozygous if it inherited both alleles of the same length. The individual is heterozygous if the allele lengths differ. The proportions of homo- and heterozygous individuals in population is called homo- and heterozygosity.

Let us assume that there are either heterozygotes or homozygotes in the population. Let X be the number of successes (either choosing heterozygote or homozygote from population). Then X might be supposed to be a random variable with binomial distribution taking values $0, 1, \dots, n_g$, where n_g is the total sample size.

As long as the proportion of heterozygotes (or either homozygotes) is usually not close to 0 or 1 and we expect the sample size n_g be more than 30 with $n_g p$ being more than 5, the normal approximation should perform well. Let $\hat{p} = r/n_g$, where r is the number of successes and n_g number of observed genotypes, be the proportion of successes estimated from the sample. The confidence interval is then

$$\left(\hat{p} - z_{1-\alpha/2} \sqrt{\frac{\hat{p}(1-\hat{p})}{n_g}}, \hat{p} + z_{1-\alpha/2} \sqrt{\frac{\hat{p}(1-\hat{p})}{n_g}} \right), \tag{1}$$

where $z_{1-\alpha/2}$ is the $1 - \alpha/2$ quantile of a standard normal distribution $N(0, 1)$.

2.1.1 Example: Suppose we have collected genotype data from 1134 people. Suppose the locus of our interest is the $D13S317$ (see Tab.3) and that we observed 894 heterozygous genotypes. The estimated heterozygosity is then

$$\hat{h}e = \frac{894}{1134} = 0.7884 \tag{2}$$

with 95% confidence interval being (0.7634, 0.8118). Estimated homozygosity is analogously

$$\hat{h}o = 1 - \hat{h}e = \frac{240}{2000} = 0.2116 \tag{3}$$

with 95% confidence interval being (0.1882, 0.2369).

2.2. Average match probability

Let us assume that the innocent suspect is drawn from the same population as the offender but the two are not closely related. DNA profiles of two individuals are declared to be a match if they exhibit identical genotypes. For an polymorphic locus with k alleles the average

match probability [3][4] is

$$\hat{p}_m = \sum_{i=1}^n \widehat{p}_m^{ho}(i) + \sum_{i=1, j=1, i < j}^n \widehat{p}_m^{he}(i, j), \quad (4)$$

where n is the number of possible alleles at the locus and $\widehat{p}_m^{ho}(i)$ and $\widehat{p}_m^{he}(i, j)$ are estimated probabilities of match with individuals being homozygous or heterozygous. Basically it is a sum of weighted probabilities of homozygous and heterozygous genotypes. Since we assume the innocent suspect and the criminal to be drawn from the same population, the weights are simply the same probabilities as the probabilities of drawing the offender genotypes.

$$\begin{aligned} \widehat{p}_m^{ho}(i) &= \omega_i \psi_i \\ \widehat{p}_m^{he}(i, j) &= \omega_{ij} \psi_{ij} \end{aligned} \quad (5)$$

with

$$\begin{aligned} \omega_i &= \hat{p}_i [\theta + (1 - \theta) \hat{p}_i] \\ \psi_i &= \frac{[2\theta + (1 - \theta) \hat{p}_i][3\theta + (1 - \theta) \hat{p}_i]}{(1 + \theta)(1 + 2\theta)} \end{aligned}$$

and

$$\begin{aligned} \omega_{ij} &= 2(1 - \theta) \hat{p}_i \hat{p}_j \\ \psi_{ij} &= \frac{2[\theta + (1 - \theta) \hat{p}_i][\theta + (1 - \theta) \hat{p}_j]}{(1 + \theta)(1 + 2\theta)}, \end{aligned}$$

where \hat{p}_i and \hat{p}_j are the estimated allele frequencies and $i, j = 1, \dots, n$.

The quantity θ is a number from the interval $[0, 1)$. It is the coancestry coefficient and describes variation in allele proportions among subpopulations. When $\theta = 0$ the whole population is in Hardy-Weinberg equilibrium. Hardy-Weinberg (HW) equilibrium assumes random mating and random segregation of alleles in large population, where there is no genetic drift and mutations occur randomly. For more details about HW equilibrium please see [5] and [6]. For populations such as USA, the recommended value of θ is 0.01 and for small isolated subpopulations it is 0.03.

By taking θ equal to 0 the first formula from (5) simplifies to \hat{p}_i^4 which is equivalent of drawing four times the i^{th} allele from very large population. The second formula from (5) then simplifies to $4\hat{p}_i^2 \hat{p}_j^2$ and this is equivalent to twice drawing the i^{th} and j^{th} allele in pair.

2.3. Average discrimination power

Average discrimination power [7] is a potential power to differentiate between any two people drawn at random from population. Here we see that it is the exact

opposite to the average match probability. The average discrimination power is therefore defined as

$$\hat{p}_d = 1 - \hat{p}_m, \quad (6)$$

where \hat{p}_m is the estimated match probability from (4).

2.3.1 Example (cont.): The average match probability and average discrimination power for the *D13S317* locus are shown in Table 4. We can see that with increasing coancestry coefficient the average match probability increases too and the average discrimination power decreases.

	$\theta = 0$	$\theta = 0.01$	$\theta = 0.03$
AMP	0.0780	0.0833	0.0943
ADP	0.9220	0.9167	0.9057

Table 4: Average match probability (AMP) and Average discrimination power (ADP)

2.4. Polymorphic information content

The main contribution of polymorphic information content (PIC) is in the genetic mapping, which plays very important role in genetics and particularly in genetic counseling and research of hereditary diseases or disorders. For more details, please see [8]. Informativeness in this context is represented by the probability that a given offspring of a parent carrying the rare allele at the index locus will allow deduction of the parental genotype at the marker locus. The marker locus is then the polymorphic locus where the informativeness has to be determined.

Polymorphic information content can then be calculated as a sum of the probability of an offspring being informative multiplied by mating frequencies. The probabilities of mating and probabilities of an offspring being informative are given in [8]. The sum of their products is

$$\widehat{pic} = 1 - \sum_{i=1}^n \hat{p}_i^2 - \sum_{i=1}^{n-1} \sum_{j=i+1}^n 2\hat{p}_i^2 \hat{p}_j^2, \quad (7)$$

where n is the number of possible alleles at the locus and \hat{p}_i is the estimated frequency of the i^{th} allele ($i = 1, \dots, n$) at that locus.

The value of PIC varies from 0 to 1. the loci with $PIC \geq 0.5$ are according to (7) called highly informative. Reasonably informative are loci with $0.25 \leq PIC < 0.5$ and only slightly informative are loci with $PIC < 0.25$. Loci with PIC near 1 are most desirable. In here we considered the index and the marker locus to be in nuclear families (one generation). Multigenerational studies will probably allow more extensive computation.

2.4.1 Example (cont.): The estimated PIC for the *D13S317* polymorphisms is 0.7507 which means that it is highly informative. The other loci from [1] are highly informative too. Their estimated PIC varies from 0.5755 to 0.8832.

2.5. Paternity testing

In paternity testing we first try to exclude men not being fathers of the selected child. After we have only few men left we try to determine if the selected man is the father of the selected child. In the following subsections we will assume that a mother of selected child is undoubtedly known and that there were no mutations occurred at alleles.

2.5.1 Average exclusion probability: The selected man is certainly not a father of the selected child in two cases: The child does not have any allele that could be inherited from selected man. Knowing the allele inherited from mother, the child's second allele does not come from selected man. From previous words we see that the exclusion probability closely corresponds to heterozygosity. The ability to exclude selected man from being father higher as the proportion of heterozygotes in population rises. In remaining cases we can compute the probability of excluding any person from being father. This assumes reliable estimate of allele frequencies.

The calculation is given in [9]. Computation of the expected exclusion probability is not difficult having estimated the heterozygosity (proportion of heterozygotes). Then

$$\begin{aligned} \hat{p}_{exclusion} &= \hat{h}e^2[(1 - \hat{h}e + \hat{h}e^2)] \\ &+ \hat{h}e^4[\hat{h}e(1 - \hat{h}e)], \end{aligned} \quad (8)$$

where $\hat{h}e$ is the estimated heterozygosity.

Rougher approximations of this formula are given in [9]. Here they assume the heterozygosity being large enough, or close to 1, and subsequently take $1 + \hat{h}e \approx 2$. Then

$$\hat{p}_{exclusion} = \hat{h}e^2(1 - 2\hat{h}e(1 - \hat{h}e)^2). \quad (9)$$

This approximation is very often used in forensic articles but proves unsatisfying when $\hat{h}e$ diverges from 1. Another even rougher approximation is taking $(1 - \hat{h}e) \approx 0$. This gives

$$\hat{p}_{exclusion} = \hat{h}e^2. \quad (10)$$

For multilocus testing let us denote the estimated exclusion probability $\hat{p}e_i$, where the $i = 1, 2, \dots, n_l$

denotes the i^{th} locus examined and let us assume the n_l loci being independent. The overall probability of exclusion is then

$$\hat{P}E = 1 - [(1 - \hat{p}e_1) \dots (1 - \hat{p}e_{n_l})]. \quad (11)$$

2.5.2 Example (cont.): The estimated average exclusion probability and its approximations for the *D13S317* locus are shown in Table 5.

	acc. to (8)	acc. to (9)	acc. to (10)
AEP	0.5823	0.5776	0.6215

Table 5: Average exclusion probability (AEP)

The most accurate estimate of AEP is 0.5823

2.5.3 Typical paternity index: Typical paternity index [9] is defined as

$$\hat{P}I = \frac{1}{1 - \hat{p}_{exclusion}}, \quad (12)$$

where $\hat{p}_{exclusion}$ is the estimated average exclusion probability.

Unfortunately, very often only the roughest approximation of $\hat{p}_{exclusion}$ (10) is taken into account when calculating the typical paternity index. Further taking $1 + \hat{h}e \approx 2$ leads to

$$\begin{aligned} \hat{P}I &= \frac{1}{(1 + \hat{h}e)(1 - \hat{h}e)} \\ \hat{P}I &= \frac{1}{2(1 - \hat{h}e)}, \end{aligned} \quad (13)$$

where the $\hat{h}e$ is the estimated heterozygosity.

Taking the estimate of $\hat{p}_{exclusion}$ (8) we derive

$$\begin{aligned} \hat{P}I &= \frac{1}{1 - \hat{h}e^2[(1 - \hat{h}e + \hat{h}e^2)] - \hat{h}e^4[\hat{h}e(1 - \hat{h}e)]} \\ \hat{P}I &= \frac{1}{1 - \hat{h}e^2 + \hat{h}e^3 - \hat{h}e^4 - \hat{h}e^5 + \hat{h}e^6}, \end{aligned} \quad (14)$$

where the $\hat{h}e$ is the estimated heterozygosity.

2.5.4 Example (cont.): The estimated typical paternity indices and its approximations for the *D13S317* locus are shown in Table 6. Unfortunately, although the computation of (14) is very simple, some of the approximations is used.

	acc. to (12) & (9)	acc. to (12) & (10)
TPI	2.3675	2.6421
	acc. to (13)	acc. to (14)
TPI	2.3625	2.3939

Table 6: Typical paternity index (TPI)

The most accurate estimate of the TPI is 2.3939.

3. Conclusions

Short overview of population statistics used in forensic genetics was given together with some discussion and references to available literature. As the areas of forensic sciences and forensic genetics are very wide and it is only recently that most of the genotype information is available, there is lots of matters to explore and investigate. In my prospective Ph.D. thesis I would like to focus on statistical aspects of these statistics, testing assumption under which they hold and possibly developing new method for their estimation.

Indispensable is also the development of R [10] - the statistical software and its building blocks - R-packages. Those separate ones usually contain methods and functions for more specific topics of statistics. There are currently two main R-packages available for genetic computations: *genetics* [11] and *gap* [12]. *Genetics* focuses on classes and methods for handling genetic data. *Gap* focuses on data analysis of both population and family data. Even though the R-package *forensic* [2] uses some methods from the two packages mentioned above, its purpose rests on forensic genetics. In future I would like to cooperate with it's authors to develop and include more methods.

References

- [1] Halina Šimková, Václav Faltus, Richard Marvan, Tomáš Pexa, Vlastimil Stenzl, Jaroslav Brouček, Ivan Mazura, Jana Zvárová, "Allele frequency data for 17 short tandem repeats in a Czech population sample", *Forensic Science International*, submitted 05/2007.
- [2] Miriam Marusiakova (2007), "forensic: Statistical Methods in Forensic Genetics. R package version 0.2.", (Center of Biomedical Informatics, Institute of Computer Science and Academy of Sciences of the Czech Republic).
- [3] David J. Balding and Richard A. Nichols, "DNA profile match probability calculation: how to allow for population stratification, relatedness, database selection and single bands", *Forensic Science International*, vol. 64, pp. 125–140, 1994.
- [4] Guangyun Sun, Stephen T. McGarvey, Riad Bayoumi, Connie J. Mulligan, Ramiro Barrantes, Salmo Raskin, Yixi Zhong, Joshua Akey, Ranajit Chakraborty and Ranjan Deka "Global genetic variation at nine short tandem repeat loci and implications on forensic genetics", *European Journal of Human Genetics*, vol. 11, pp. 39–49, 2003.
- [5] Sun Wei Guo and Elizabeth A. Thompson, "Performing the Exact Test of Hardy-Weinberg Proportion for Multiple Alleles", *Biometrics*, vol. 48, pp. 361–372, June 1992.
- [6] Mark Huber, Yuguo Chen, Ian Dinwoodie, Adrian Dobra, Mike Nicholas, "Monte Carlo Algorithms for Hardy-Weinberg Proportions", *Biometrics*, vol. 62, pp. 49–53, March 2006.
- [7] Sérgio D. J. Pena, "Single-tube single-colour multiplex PCR amplification of 10 polymorphic microsatellites (ALF10): a new powerful tool for DNA profiling", *Pure Appl. Chem.*, vol. 71, pp. 1683–1690, 1999.
- [8] David Botstein, Raymond L. White, Mark Skolnick, Ronald W. Davis, "Construction of a Genetic Linkage Map in Man Using Restriction Fragment Length Polymorphisms", *Am J Hum Genet*, vol. 32, pp. 314–331, 1980.
- [9] Charles Brenner and Jeffrey W. Morris, "Paternity testing calculation in single locus hypervariable DNA probes: Validation and other studies", *Proceeding for The International Symposium on Human Identification*, pp. 21–53, 1989.
- [10] R Development Core Team (2007), "R: A language and environment for statistical computing", *R Foundation for Statistical Computing, Vienna, Austria*, ISBN 3-900051-07-0, www.R-project.org.
- [11] Gregory Warnes and Friedrich Leisch, "genetics: Population Genetics. R package version 1.2.1".
- [12] Jing Hua Zhao in collaboration with other colleagues, and with help from Kurt Hornik and Brian Ripley of the R core development team (2007), "gap: Genetic analysis package. R package version 1.0-11", www.mrc-epid.cam.ac.uk/Personal/jinghua.zhao/.

Graph Partitioning Driven by Elimination Structures

Post-Graduate Student:

MGR. KATEŘINA JURKOVÁ

Faculty of Mechatronics and Interdisciplinary Engineering Studies
Technical University of Liberec
Hálkova 6

461 17 Liberec, CZ

katerina.jurkova@tul.cz

Supervisor:

PROF. ING. MIROSLAV TŮMA, CSc.

Institute of Computer Science of the ASCR, v. v. i.
Pod Vodárenskou věží 2

182 07 Prague 8, CZ

tuma@cs.cas.cz

Field of Study:
Scientific Computing

Abstract

In this paper we deal with the problem of parallel solution of sparse linear systems. In particular, we are interested in close coupling of the techniques which are typically considered separately. On one side we have the graph partitioning, on the other side we can obtain information from the decompositions of partitioned systems on individual domains which typically represent the most time consuming components of the whole solver. Our approach exploits analysis of the decompositions performed on these domains. Fortunately, a lot of this analysis can be performed only symbolically, and before any decomposition starts. We believe that it is possible to get much more balanced decomposition, and significantly to improve the overall computation in this way.

This paper presents the main idea of this new approach and describes its basic building blocks. Our final goal is to transfer all these techniques to the field of preconditioned iterative solvers, where we will face other challenging problems related to proper partitioning of combinatorial properties of matrices.

1. Introduction

It is well-known that graph partitioners and load balancing techniques in general, suffer from many drawbacks of different kind. One of them is connected with the fact that the goal of the graph partitioning do not exactly coincide with the best balancing of the computation. Graph partitioning typically do include into its objective function only very simple criteria as balancing sizes of domains, minimizing domain separator, balancing parallel load [4]. Multiobjective partitioning can include more *explicit* criteria but a problem arises in the case when the best load balancing is determined mainly by an *implicit* criterion. This exactly happens in our case.

Our case of interest is solving large and sparse linear systems by direct methods or by preconditioned iterative methods. In this situation, for a perfect balancing of the computation we need to achieve similar operation counts in decompositions of smaller systems on the domains, at least. Fortunately, direct solvers and some incomplete decompositions offer a couple of tools which are useful for estimating of operation counts. If we are able to exploit these tools during the partitioning we can successfully balance the computation. As mentioned above, this paper mainly formulates our problems

and summarizes our tools. We consider it as a starting point in an interesting and unexplored direction.

It is well-known that the elimination is directed by implicit data structures like the elimination tree (in the symmetric and positive definite case) and dag (in the general nonsymmetric case). These data structures provide very inexpensively many quantities which can be used for balancing the partitioning. In particular, we can compute row counts and column counts of factors of the decomposed matrix, supernodal structure of the matrix etc. Based on those quantities, we can compute the number of floating-point operations needed for the decomposition. We believe that this information can be exploited in order to get better partitioning by an a posteriori correction of the initial partitioning provided by a black-box efficient software like Metis. In this case we repartition the matrix still before the decomposition starts. We assume that the future theoretical results will extend those given in [12]. The case of incomplete decompositions seems to be even more challenging. There are two reasons why this is so. First, the data structures which we have available in complete decompositions are of limited use here. Second, incomplete decompositions are typically much faster, and the strategy of the repartitioning should be very fast as well, in order to be practical.

The structure of the paper is as follows. In the first section we will describe the problem of graph partitioning. We will emphasize the problems which the standard “undirected” paradigm of the graph partitioning may face. Second section summarizes some basic tools related to the sparse direct decompositions. Then we will mention incomplete decompositions in Section 3 and explain our ideas related to the partitioning in Section 4. We will conclude the paper by some notes on the algorithmic and theoretical development of the ideas which we introduced in this paper.

2. Graph partitioning

Graph partitioning is one of very important auxiliary problems for solving large, sparse systems of linear equations of the form $Ax = b$. In its most general form, the graph partitioning problem asks how best to divide a graph’s vertices into a specified number of subsets such that the number of vertices per subsets are roughly equal and the number of edges crossing the subsets is minimized. In the following we will explain its basic features using a simple notation.

Consider an undirected graph $G = (V, E)$ with possible weights on its vertices and edges. The decomposition of V into k disjoint subsets V_1, V_2, \dots, V_k , such that $\bigcup_i V_i = V$ is called the k -way partitioning of V . We will use the terms *subdomain* or *partition* interchangeably to refer to any one of these k vertex sets. The k -way partitioning of V is described by a vector P such that $P[i]$ indicates the partition number to which the vertex i belongs to. The partitioning is said to *cut an edge* e , if its incident vertices belong to different partitions. The *edge-cut* of a partitioning P is equal to the sum of the weights of the edges that are cut by the partitioning. The *partition weight* of the i -th partition is equal to the sum of the weights of the vertices assigned to V_i . The *total vertex weight* of a graph is equal to the sum of the weights of all the vertices in the graph. The *load-imbalance* of the k -way partitioning P is the ratio of the highest partition weight over the average partition weight. *Bisection* of graph is a division of its vertex set into two subsets of comparable sizes.

The most commonly used approach for k -way partitioning is to recursively bisect the graph. It first optimally divides the graph into two similarly-sized parts and then recursively divides the parts, until there are as many pieces as processors in parallel machine. Some other heuristics have been proposed that applies quadsectioning or octsectioning in place of the bisection [7].

But the bisection may, in the worst case, produce a

partition that is very far away from being optimal. In other words, optimal recursive bisection may not lead to a good k -way partition [14]. Bisection techniques have several inherent shortcomings. For instance, bisection algorithms are unable to accept a less attractive initial cut which would allow lot of savings in later cuts.

A specific class of graph partitioning algorithms which includes other techniques as special cases is called the multilevel algorithm [6]. The basic structure of the multilevel algorithm is very simple. The graph G is first coarsened to a reduced quantity of vertices, then a bisection of this much smaller graph is computed, and then this partition is projected back towards the original graph (finer graph), by periodically refining the partition. Since the finer graphs have more degrees of freedom, such refinements usually decrease the edge-cut.

Formally, the multilevel graph bisection algorithm can be described as follows: Consider a weighted graph $G_0 = (V_0, E_0)$, with weights both on vertices and edges. A multilevel graph bisection algorithm consists of the following three phases.

Coarsening Phase: The graph G_0 is transformed into a sequence of smaller graphs G_1, G_2, \dots, G_n such that $|V_0| > |V_1| > |V_2| > \dots > |V_n|$.

Partitioning Phase: A 2-way partition P_n of the graph $G_n = (V_n, E_n)$ is computed that partitions V_n into two parts, each containing half the vertices of G_0 .

Uncoarsening Phase: The partition P_n of G_n is projected back to G_0 by going through intermediate partitions $P_{n-1}, P_{n-2}, \dots, P_1, P_0$.

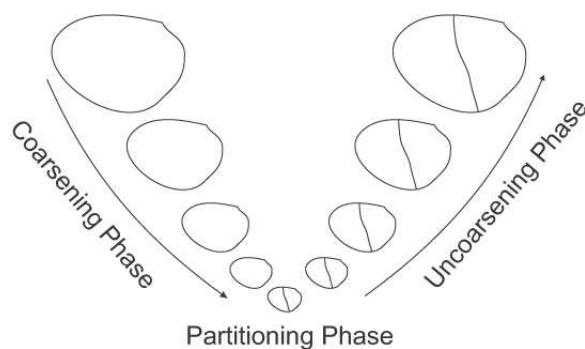

Figure 1: Multilevel bisection

Two approaches have been developed for computing the k -way partitioning using the multilevel paradigm. The first, already mentioned, called the *multilevel recursive bisection*, computes the k -way partitioning by using the multilevel paradigm by nested recursive bisections.

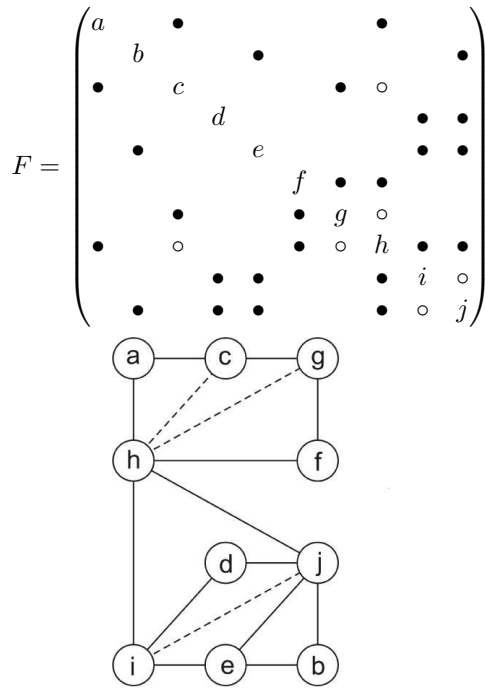

Figure 3: Matrix F and the graph $G(F)$ associated with it

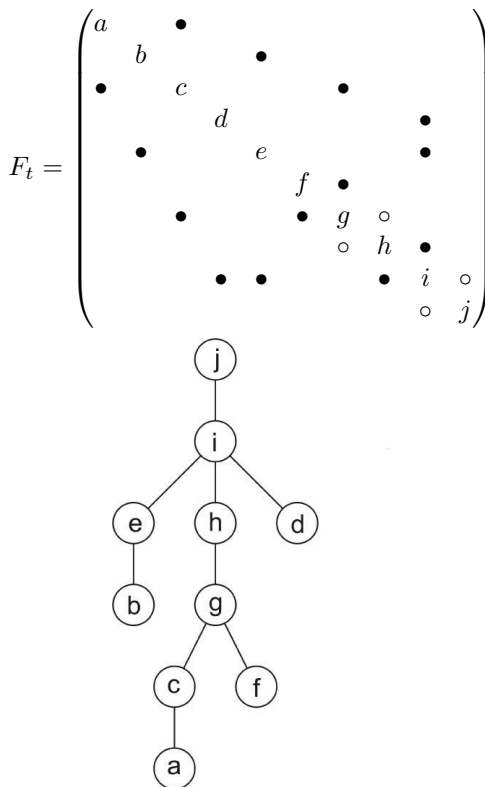

Figure 4: Matrix F_t and the elimination tree $T(A)$

Note that some of the tree edges in $T(A)$ are filled edges belonging to $G(F)$ (for example, the tree edge between nodes g and h). And finally here is the resulting matrix F_t and corresponding elimination tree $G(F_t) = T(A)$

The elimination tree $T(A)$ has the same node set as $G(A)$ and it is a spanning tree of the filled graph $G(F)$ of A . We define the node x_n to be the root of this tree $T(A)$. This tree structure can also be obtained from a depth-first search exploration of the undirected filled graph $G(F)$.

As we mentioned above, the elimination tree plays the central role in the Cholesky factorization of sparse symmetric and positive definite matrices. In the case of sparse LU factorization of nonsymmetric matrices, its generalization can be used. We seek a structure that characterizes the lower and upper triangular factors in the same way that elimination trees characterize Cholesky factor [3]. Our generalization consists of a pair of special directed acyclic graphs, called *elimination dags*.

Let A be a nonsingular sparse unsymmetric n -by- n matrix with nonzero diagonal that can be factored as $A = LU$, where L is unit lower triangular and U is upper triangular. The *filled* matrix of A is $A^+ = L + U + I$. The *filled graph* of A is the directed graph $G(A^+)$ of its filled matrix. The lower triangular matrix L has directed acyclic graph $G(L)$, which has the unique transitive reduction $G^\circ(L)$. This exactly means that we can find another directed graph with fewer edges, but with the same path structure. More in detail, the *transitive reduction* G° of a given directed graph G satisfies the following two conditions.

1. G° has a directed path from u to v if and only if G has a directed path from u to v .
2. No graph with fewer edges that G° satisfies the condition (1).

Similarly, the upper triangular matrix U has directed acyclic graph $G(U)$, which also has a unique transitive reduction $G^\circ(U)$. We call the two reduced directed acyclic graphs $G^\circ(L)$ and $G^\circ(U)$ the *lower* and *upper elimination directed acyclic graphs*, respectively. We also refer to them collectively as *elimination dags* of the matrix A .

The dags for a given matrix A and its LU factorization will be demonstrated in the following example.

$$A = \begin{pmatrix} a & \bullet & & & & \\ & b & & & & \\ \bullet & & c & & & \bullet \\ & \bullet & \bullet & d & \bullet & \\ & \bullet & & \bullet & e & \\ \bullet & \bullet & & & & f \end{pmatrix} = \begin{pmatrix} a & & & & & \\ & b & & & & \\ \bullet & & c & & & \\ & \bullet & \bullet & d & & \\ & \bullet & \bullet & \bullet & e & \\ \bullet & \bullet & \circ & & & f \end{pmatrix} \begin{pmatrix} a & \bullet & & & & \\ & b & & & & \\ & & c & & & \bullet \\ & & & d & \bullet & \circ \\ & & & & e & \circ \\ & & & & & f \end{pmatrix}$$

The LU factorization of this matrix creates three fill-in entries, one in L a two in U . The fills are represented in the figure by "o". The figures 5 and 6 show directed graph $G(L)$ and corresponding elimination dag $G^\circ(L)$ and the figures 7 and 8 present the directed graph $G(U)$ and the corresponding elimination dag $G^\circ(U)$.

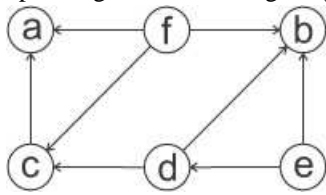

Figure 5: Directed graph $G(L)$

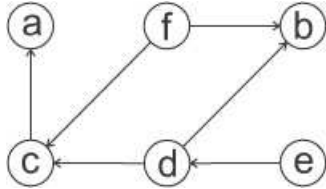

Figure 6: Elimination dag $G^\circ(L)$

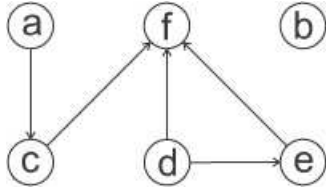

Figure 7: Directed Graph $G(U)$

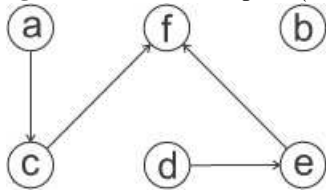

Figure 8: Elimination dag $G^\circ(U)$

4. Incomplete decompositions

Incomplete factorization preconditioning belongs to important techniques useful for solving linear systems of equations by iterative methods. Incomplete LU factorization, in short ILU , where L and U are the lower and upper incomplete triangular factors of the coefficient

matrix. ILU preconditioning is based on computation factors L and U , where $LU \approx A$.

First common type of an incomplete factorization is based on choosing of a set of matrix positions, and keeping all positions outside this set equal to zero during the factorization. The resulting factorization is incomplete in the sense that fill is suppressed. This approach is sometimes called incomplete factorization *by mask*. Its special case is the ILU factorization technique with no fill-in, denoted by $ILU(0)$, considers the zero pattern, so that the factors need exactly as much space to store as the original matrix. More accurate ILU factorizations differ from $ILU(0)$ by allowing some fill-in. Thus, $ILU(1)$ keeps the "first order fill-ins", a term that will be explained briefly. The Incomplete Fill Path Theorem describes a close relationship between the fill entries in $ILU(k)$ factors and path lengths in graphs [9] [13]. At the completion of the ILU process, a fill-in entry in position (i, j) has level of fill k iff there exists a fill path of length $p + 1$ between i and j . Second basic type is the incomplete factorization *by value*, which exactly means, that if the magnitude of any computed entry is smaller than a given *drop tolerance* τ , we will keep it equal to zero.

The basic idea of incomplete factorizations can be modified as follows: If the entry is nonzero, and fill is not allowed in the corresponding position, dropped elements are added to the diagonal elements. Such a factorization scheme is usually called a *modified incomplete factorization*.

5. Graph partitioning and decompositions

The key questions which we would like to answer in our work by further developing our ideas is in its simple form as follows. Are we able to decide which part of one partition can be moved to another one to achieve better balance of the decompositions? Are we able to do this by analyzing the elimination tree or dag? Can this knowledge be plugged-in into a graph partitioner? How can be the balance restored by equivalent fill-in minimizing reorderings? Are we able to be better in practice than standard parallel techniques?

The incomplete fill path theorem mentioned above may imply a suitable basis for graph partitionings for which one of the objectives is to balance the incomplete decompositions. May be that a preliminary analysis may provide enough information for balanced partitionings. Very cheap analysis may be based on matrix sparsifications. A strategy may be as follows. Let us the matrix A sparsified into A' . This means that some small entries of A were removed. Next step determines the elimination tree and counts nonzeros in the factor. This information can be not only compared with the original matrix but may be used for direct graph partitioning, or its repartitioning explained above. In general, matrix elimination structures offer several additional structures, like skeleton graph, which may be used for graph partitioning in addition to $G(A)$. Understanding their potential, both theoretically and practically, will be our main goal.

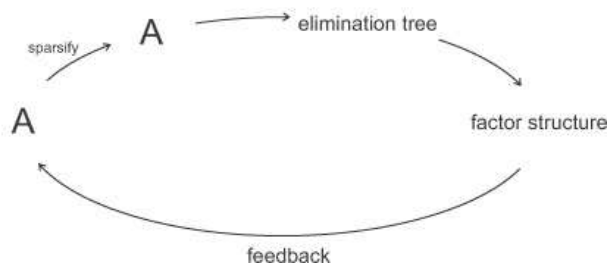

Figure 9: Incomplete decomposition employing elimination trees

6. Conclusions

We have described main approaches to graph partitioning. We have shown the basic problems connected to this well-understood technology if we would like perform decompositions on the domains. We also mentioned how the symbolic analysis can be exploited before any factorization starts. To demonstrate the potential, we described the implicit graph structures like elimination trees in symmetric case and elimination dags in case of unsymmetric matrices. Closely related incomplete decompositions were briefly introduced mainly in order to show a bunch of interesting possibilities which may be very useful for contemporary decomposition-aware partitioning algorithms.

References

- [1] S.C. Eisenstat and J.W.H. Liu “Algorithmic Aspects of Elimination Trees for Sparse Unsymmetric Matrices”, *Technical report, Department of Computer Science, York University, Toronto, Canada*, 2004.
- [2] S.C. Eisenstat and J.W.H. Liu “The Theory of Elimination Trees for Sparse Unsymmetric Matrices”, *SIAM J. Matrix Anal. Appl.*, 26, pp. 686-705, 2005.
- [3] J.R. Gilbert and J.W.H. Liu “Elimination Structures for Unsymmetric Sparse LU Factors”, *CS-90-11, North York, Ontario*, 1991.
- [4] B. Hendrickson, “Graph Partitioning and Parallel Solvers: Has the Emperor No Clothes?”, *Springer-Verlag, Proc. Irregular’98. Lecture Notes in Computer Science*, 1457, pp. 218-225, 1998.
- [5] B. Hendrickson and T. Kolda “Graph Partitioning Models for Parallel Computing”, *Parallel Computing*, 2000.
- [6] B. Hendrickson and R. Leland “A multilevel algorithm for partitioning graphs”, *Technical Report SAND93-1301, Sandia National Laboratories*, 1993.
- [7] B. Hendrickson and R. Leland “An Improved Spectral Graph Partitioning Algorithm for Mapping Parallel Computations”, *SIAM J. Sci. Stat. Comput.*, 16(2):452-469, 1995.
- [8] D. Hysom and A. Pothen “A scalable parallel algorithm for incomplete factor preconditioning”, *Technical Report (preprint), Old-Dominion University, Norfolk, VA*, 2000.
- [9] D. Hysom and A. Pothen “Efficient Parallel Computation of $ILU(k)$ Preconditioners”, *In Proceedings of Supercomputing 99. ACM, New York, NY*, 1999.
- [10] G. Karypis and V. Kumar “Multilevel Algorithms for Multi-Constraint Graph Partitioning”, 98-019, 1998.
- [11] J.W.H. Liu “The Role of Elimination Trees in Sparse Factorization”, *SIAM J. Matrix Anal. Appl.*, 11, pp. 134-172, 1990.
- [12] T. Pěnička “Dělení rozsáhlých a řídkých grafů v numerické lineární algebře”, *draft of PhD. Thesis*, 2006.
- [13] Y. Saad “Iterative Methods for Sparse Linear Systems”, *SIAM*, 2nd ed. 2003.
- [14] H. D. Simon and S.-H. Teng “How Good is Recursive Bisection”, *Report RNR-93-012, NASA Ames Research Center, Moffett Field, CA 94035, August 1993, SIAM J. Sci. Computing*, 1996.
- [15] K. Schloegel and G. Karypis and V. Kumar “A New Algorithm for Multi-objective Graph Partitioning”, *European Conference on Parallel Processing*, pp. 322-331, 1999.

Utilization of the Data Assimilation Infrastructure for Coupled Environmental Forecasts

Post-Graduate Student:

MGR. PAVEL JURUŠ

Institute of Computer Science of the ASCR, v. v. i.
Pod Vodárenskou věží 2

182 07 Prague 8, CZ

Czech Technical University in Prague
Faculty of Transportation Sciences
Konviktská 20

110 00 Prague 1, CZ

jurus@cs.cas.cz

Supervisor:

DOC. ING. EMIL PELIKÁN, CSC.

Institute of Computer Science of the ASCR, v. v. i.
Pod Vodárenskou věží 2

182 07 Prague 8, CZ

emil@cs.cas.cz

Field of Study:
Engineering Informatics in Transportation and Telecommunications

This work was supported by the Grant Agency of the Academy of Sciences of the Czech Rep. (grant No. 1ET400300414, framework "Information Society") and by the Institutional research plan AV02 10300504 Computer Science for the Information Society "Models, Algorithms, Applications".

Abstract

Modern data assimilation techniques are being implemented in the popular NWP (numerical weather prediction) models. The most popular are either variational data assimilation (3- or 4- dimensional) or various variants the ensemble Kalman filter. This paper investigates the possibility of taking advantage of already existing data assimilation software for the probabilistic forecasts. Special attention is given to the case when weather forecast is used as the input to another environmental model. The first results for the 3D-Var case are included.

1. Introduction

State of the art numerical weather prediction (NWP) and to some extent also chemistry transport models (CTM) are used in a growing number of applications. NWP model is often used merely as the first step and NWP output is used as one of inputs to another model. This coupling with another model is often designed with the "perfect" weather forecast as the intended input. However the output from NWP model is never perfect. Usual sources of errors involved in the NWP modelling are the imperfect initial and boundary conditions, simplified model physics and finite resolution due to state space discretization.

Construction of initial conditions (so called "analysis" in NWP) is typically domain of the data assimilation. Various kinds of observations are used together with the numerical model to get as good estimate as possible of real state of atmosphere. Modern methods of data assimilation usually work, directly or indirectly, with a statistical model of model and observation errors. Construction of analysis can be seen as an estimation of the true state, given stochastic model and inaccurate measurements. Analysis is defined on grid of numerical model, thus even hypothetical perfect analysis would differ from

continuous true state of atmosphere.

It is worth noting that model physics depends on the model resolution as well. Different resolutions of model grids can require different set of equations describing the atmosphere. Classical example is the convective storm modelling in NWP models (see e.g., [1]). When horizontal model resolution is larger than 10 kilometers, storms are of subgrid scale and parameterizations have to be used to capture convective behavior of atmosphere. On the other hand convective storms can be modelled directly by the dynamical equations for a resolution finer than 5 kilometers – parameterization shouldn't be used in this case. Horizontal resolution 5-10 km brings complications because the part of convection is resolved by model dynamics and the rest should be parameterized. Incidentally, many recent developments in cloud physics parameterizations lead to stochastic models (e.g., [6]).

If the model resolution is very fine (hundreds of meters), turbulent character of airflow impedes the deterministic resolution of the time evolution. This is just another example illustrating that even when we ignore other sources of errors, results of models of atmosphere will always be inexact. It is well known fact that accu-

rate long term weather prediction is not possible due to sensitive dependence of atmosphere on initial conditions. Aforesaid arguments show that even errors of a short term forecasts are not just the result of simplified description of reality. Even the fastest computers of the future assimilating huge number of observations, using the best physics descriptions, and computing on very fine grid will produce imperfect forecasts of atmospheric state regardless on prediction horizon.

2. Coupling examples

To illustrate situations when imperfect NWP and/or CTM model output is used as the input to another (coupled) model, let's consider following examples:

1. Wind direction and speed in location of wind farm or even specific wind turbine.
2. Prediction of road ice in given location.
3. Prediction of pollutant concentration in a specified place in an urban area.
4. Short-term prediction of wind field and of tracer dispersion in the vicinity of accidental release during dangerous goods transport.

All four cases are very useful applications of environmental modelling that show several common features. We are interested in local properties of atmosphere and locality is of essential importance in these cases. While mesoscale NWP models and/or CTM are the best sources of information available, they lack required space resolution. We need another model whose role is to downscale the prediction to the required location and resolution.

Models used for the downscaling vary depending on application and available data. The most widely investigated case of model output statistics is perhaps the first case and models used in literature range from purely statistical regression and neural networks models to fine resolution CFD (Computer Fluid Dynamics) models.

Important aspects of aforementioned problems is that the finer the scale is, the more relevant is to predict the not only the value, but also its confidence interval or even to predict the whole probability distribution for non-gaussian quantities (e.g., road ice). Since the predicted quantity can be highly sensitive to the state of atmosphere (in atmospheric chemistry for example) and we lack the space averaging that helps in mesoscale models, the prediction errors might be very large in some

cases. This means that sometimes the information about prediction error is even more important than the value itself.

The first of listed cases is the example where a number of classical methods of downscaling is being used in practice. Assimilation of measurements (of wind or power production) back to the models is probably not important. Prediction of power production for a number of spatially distributed wind turbines can even help to cancel local wind fluctuation and improve forecast skill. Prediction is useful even without confidence intervals but probabilistic forecast would be certainly an enhancement.

Importance of probabilistic forecast is the main difference between the first and the second case. We are definitely interested in probability of road ice and a statistical model based on meteorological precursors could be appropriate solution. The design of a statistical model will depend on availability of historical measurements and it could take into account the uncertainty in meteorological data.

The third case is an example when it makes sense to assimilate local measurements back into the mesoscale model. This case is treated extensively in [4] and [5].

Final example is the most difficult among listed cases. There is usually not enough information to construct either deterministic or statistical downscaling model. There is no fine resolution model of terrain for CFD modelling and there is no history of model and observations values for statistical models – at least not at the time of occurrence of an accident. Classical downscaling methods are not applicable in this case. We could profit from the probabilistic forecast even without the downscaling model however. For example the information about mesoscale wind field uncertainty could be useful albeit it omits local factors (orography, landuse etc.). Such a probabilistic forecast is the topic of the next section.

3. Ensemble based modification of real-time NWP/CTM couple

There is a running NWP/CTM couple in the Institute of Computer Science in Prague [7]. It uses MM5 [8] as the weather model and CAMx [3] for the air quality. Current system computes 3 day ahead forecast of weather and air quality every 6 hours. Actual forecast is available online on web address <http://www.medard-online.cz/>. Forecasts are usual deterministic forecasts with two nested domains. Larger domain contains Central Europe and

has horizontal resolution 27 kilometers; nested domain gives more detailed prediction for the Czech Republic with horizontal resolution 9 kilometers.

Ongoing development of the Medard project concentrates on the assimilation of the pollutant concentrations into the air quality model ([4]). Data assimilation method used is a variant of ensemble Kalman filter [9]. Ensemble represents the error covariance matrix of the state space. So far only the errors of selected chemical species are considered. This means that the ensemble contains flow dependent information about the error in the concentrations of the selected species, but there is no information about uncertainty in weather.

Going back to the examples of coupling with downscaling models, there are two basic benefits of the assimilation framework. It gives us information about mesoscale state error statistics – this is especially straightforward for the data assimilation based on ensemble methods. The simplest approach would be to perform downscaling for each ensemble member and regard the output as a sample for downscaled prediction. This approach is perhaps oversimplified because the resulting ensemble will lack the information about error statistics of the downscaling model. The second benefit of data assimilation framework is the possibility to feed back the measurements into either mesoscale or downscaling model. This possibility is perhaps less pronounced for mesoscale NWP models where the analyses usually use so many various observations and quality is so high that assimilation of local observation might even deteriorate rather than improve the prediction.

Since we don't have any information about the error of the NWP part in our case, we should augment our system by some data assimilation framework for the NWP model. Three-dimensional variational data assimilation was chosen, because the code is already a part of MM5 and also of WRF (which is the successor of MM5 model) distribution [2]. Three-dimensional variational data assimilation uses error covariance that doesn't evolve with the time and doesn't depend on current state of atmosphere. This simplification makes the error model less accurate, on the other hand it greatly speeds up the

computation of forecast compared to more sophisticated methods as the 4-d variational assimilation or the ensemble Kalman filter.

Ensemble was created by the perturbation of deterministic forecast. Perturbation was done by Monte-Carlo method in such a way that resulting ensemble has sample covariance matrix close to the error covariance matrix used in three-dimensional variational data assimilation. Variables in following images are selected to emphasize the similarity in the first case and the differences in the second case. Note that vectors in the second case are not the wind vectors itself but perturbation of wind (difference between ensemble member and ensemble mean) – relatively small variation in the direction can mean quite a big perturbation vector if the original wind speed is large.

4. Conclusions and outlook

Simple ensemble-based modification of existing system for real-time weather and air quality prediction was proposed. This modification is based on existing three-dimensional variational data assimilation framework. Coupling of the mesoscale probabilistic forecasts and downscaling models is planned, with the capability of probabilistic forecasts in contrast to classical deterministic forecasts as one of design goals. Ensemble-based modification is based on error covariance which is constant in time, this simplification can be overcome by using more sophisticated assimilation framework.

Probabilistic mesoscale forecast is just one small part of the system that should ultimately produce local probabilistic forecasts. Other aspects are either in development or discussed in other papers. Considering the whole problem as the task of information system design and implementation, one of the biggest challenges remaining is the final presentation of probabilistic forecasts. State of the atmosphere has three spatial and one time dimension, with different features in different scales. Visualization and presentation of various aspect of weather and air quality is already quite a difficult task. Seeing the results not as single numbers but as probability distributions adds another layer of complexity.

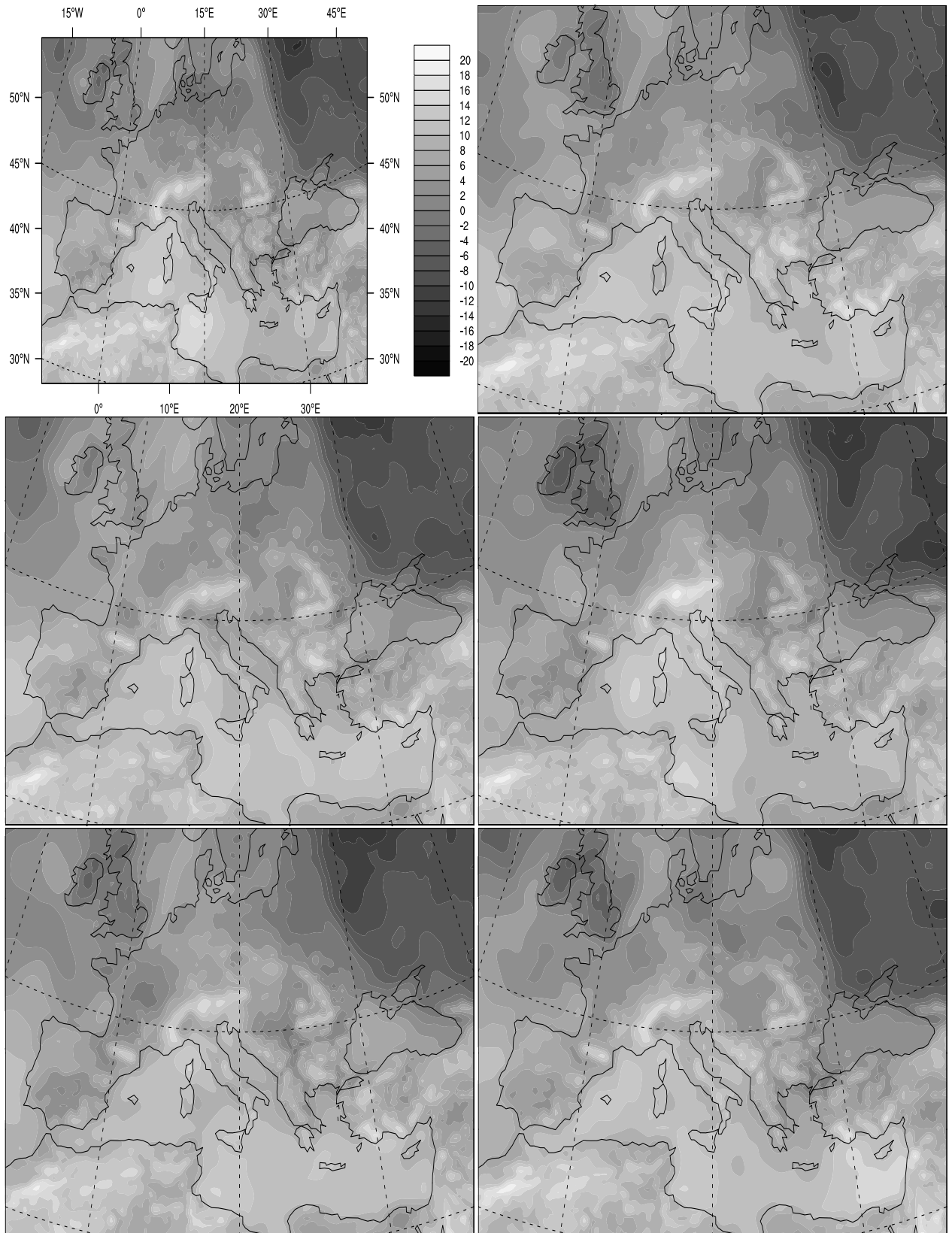

Figure 1: Potential temperature at the lowest sigma level – the first six ensemble members

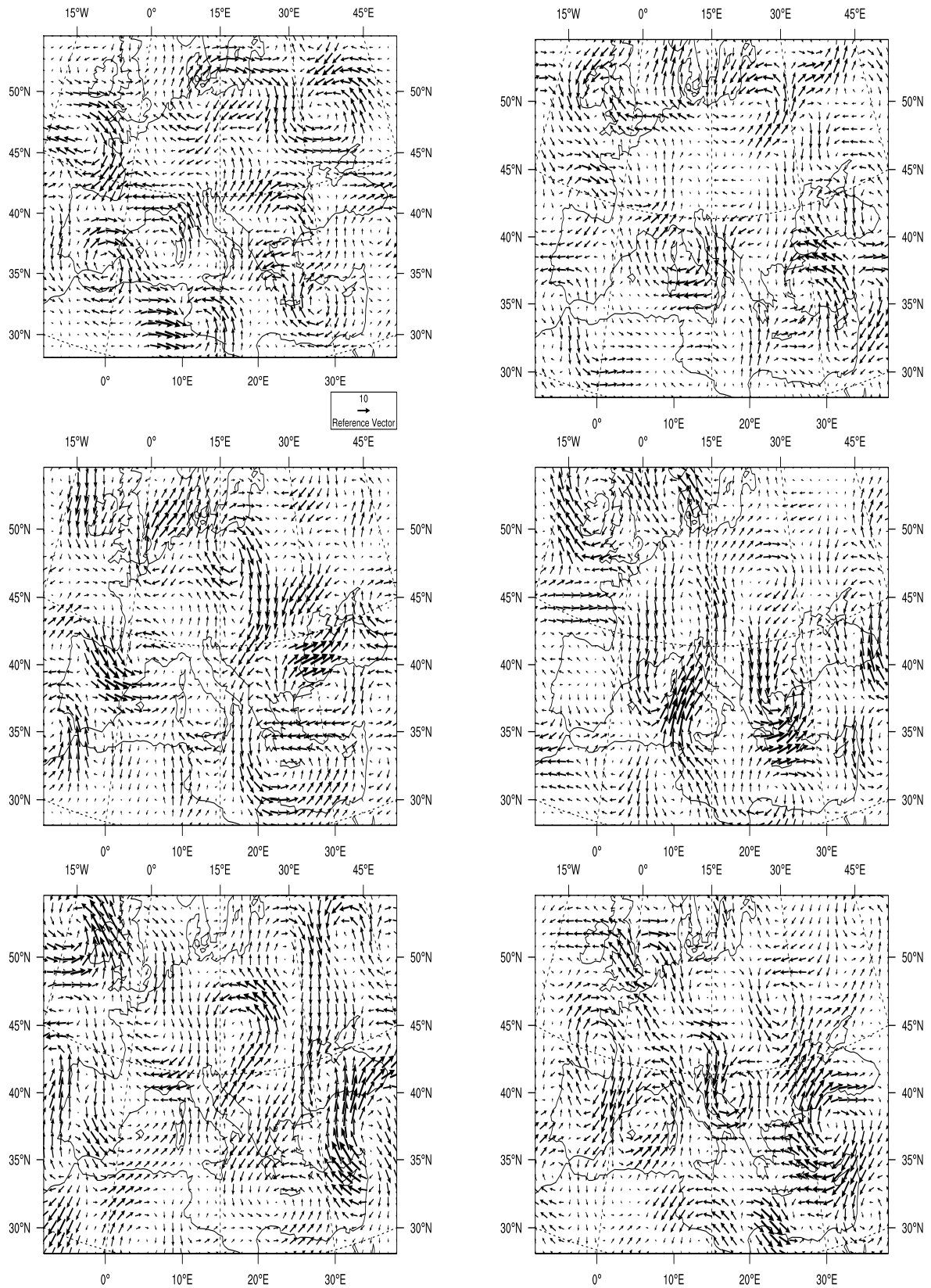

Figure 2: Wind field perturbation at the lowest sigma level – the first six ensemble members

References

- [1] A. Arakawa, “The Cumulus Parameterization Problem: Past, Present, and Future”, *Journal of Climate.*, Vol. 17, No. 13, pp. 2493–2525, 2004.
- [2] D. M. Barker, W. Huang, Y.-R. Guo, A. J. Bourgeois, Q. N. Xiao, “A Three-Dimensional Variational Data Assimilation System for MM5: Implementation and Initial Results”, *Monthly Weather Review.*, Vol. 132, No. 4, pp. 897–914, 2004.
- [3] “CAMx model”, ENVIRON USA. website: <http://www.camx.com>, 2007/1/1
- [4] K. Eben, P. Juruš, J. Resler, M. Belda, E. Pelikán, B. C. Krüger, J. Keder, “An Ensemble Kalman Filter for Short Term Forecasting of Tropospheric Ozone Concentrations”, *Q. J. R. Meteorol. Soc.*, Vol. 131, pp.3313–3322, 2005.
- [5] P. Juruš, “Downscaling in the Context of Data Assimilation” In: *Hakl, F. (ed) Doktorandský den 06.*, Ústav informatiky AV ČR + MATFYZPRESS, Praha, pp. 35–43, 2006.
- [6] J. W. B. Lin, J. D. Neelin, “Considerations for Stochastic Convective Parameterization”, *Journal of the Atmospheric Sciences.*, Vol. 59, No. 5, pp. 959–975, 2002.
- [7] “Medard project”, Institute of Computer Science Czech Academy of Sciences, Prague. website: <http://www.medard-online.cz>, 2007/1/1.
- [8] “MM5 model”, Pennsylvania State University/NCAR. website: <http://www.mmm.ucar.edu/mm5>, 2007/1/1.
- [9] J. S. Whitaker, T. M. Hamill “Ensemble data assimilation without perturbed observations”, *Mon. Weather Rev.*, vol. 130, pp. 1913–1924, 2002.

Nelineární model se smíšenými efekty pro odhad spotřeby zemního plynu

doktorand:

MGR. ONDŘEJ KONÁR

Ústav informatiky AV ČR, v. v. i.

Pod Vodárenskou věží 2

182 07 Praha 8

konar@cs.cas.cz

školitel:

DOC. ING. EMIL PELIKÁN, CSc.

Ústav informatiky AV ČR, v. v. i.

Pod Vodárenskou věží 2

182 07 Praha 8

pelikan@cs.cas.cz

obor studia:

Inženýrská informatika v dopravě a spojích

Tato práce vznikla za podpory grantu GA AV ČR č. 1ET400300513 a výzkumného záměru ÚI AV ČR č. AV0Z10300504.

Abstrakt

Kvalitní odhad spotřeby zemního plynu v daném časovém období (např. den, měsíc atd.) může být velice užitečný pro společnost obchodující s plynem. Důvodem je skutečnost, že spotřeba některých zákazníků není měřena na denní bázi. Takové měření není zvláště v případě malých zákazníků (díky jejich vysokému počtu a nízké spotřebě) pro obchodníky s plynem přijatelné. Zatímco průměrná délka období mezi odečty u malých zákazníků je přibližně jeden rok, pro některé účely je zapotřebí větší časové rozlišení. Odhady denních spotřeb můžeme získat pomocí různých vyvíjených statistických modelů. V oddělení nelineárního modelování ÚI AV ČR je vyvíjen statistický model zvaný Gamma, který je provozně využíván v Západočeské plynárenské, a.s. (ZČP). V tomto modelu považujeme všechny koeficienty za neznámé, ale pevné veličiny. Nabytá zkušenost ale ukazuje, že použití pevných efektů může být mírně problematické zejména v oblasti odhadu individuální roční spotřeby jako jednoho z parametrů modelu. V datech se mohou vyskytovat nezanedbatelné chyby měření a proto by odhady individuálních ročních spotřeb měly být "smrštěny" k průměru zákaznického segmentu (segmenty odpovídají předdefinovaným skupinám zákazníků s podobnými vlastnostmi). Náš nový model je formulován jako nelineární regresní model se smíšenými efekty a je rozšířením stávajícího modelu Gamma. Roční spotřeba je zde brána jako náhodná veličina s logaritmicke-normálním rozdělením. Příspěvek zobrazuje současný stav výzkumu, který zdaleka není u konce. Bude též prezentováno porovnání nového přístupu se stávajícím. V závěru jsou uvedeny některé směry dalšího výzkumu.

1. Úvod

Spotřeba zemního plynu domácností a maloobděratelů je (narozdíl od velkoobděratelů a středních odběratelů, kteří jsou měřeni po hodinách) odečítána z plynoměru v intervalu přibližně jeden rok. Odečty plynoměru probíhají z technických a ekonomických důvodů cyklicky v průběhu celého roku, tzn. že je každý den v roce odečtena část zákazníků. Spotřeby jednotlivých zákazníků jsou tedy známy za přibližně roční období, která se mezi zákazníky překrývají.

V některých situacích je ale užitečné znát přesnou spotřebu k danému dni nebo za dané období. Příkladem může být změna ceny plynu, kdy potřebujeme znát pro každého zákazníka spotřebu od předchozího odečtu k datu změny ceny a spotřebu od data změny ceny k následujícímu odečtu. Dále např. při odhadu zisků obchodníka s plynem potřebujeme znát objem prodaného plynu k danému dni. Neměřené části spotřeby je třeba

odhadnout vhodným modelem. Druhá možnost je pochopitelně provedení mimořádného odečtu, to však bývá zpravidla finančně i technicky náročnější.

V oddělení nelineárního modelování byl vyvinut nelineární regresní model spotřeby zemního plynu, nazvaný Gamma, [4, 6]. Model je provozně využíván v Západočeské plynárenské, a.s. Zkušenosti s provozem tohoto modelu byly popsány např. v [1, 2]. Cílem tohoto příspěvku je popsat současný stav vývoje modelu, konkrétně jeho modifikace na bázi *nelineárních modelů se smíšenými efekty*, [3, 5].

2. Model Gamma

Zákazníci jsou tříděni podle tzv. *typu klienta* (domácnost nebo maloobděratel), který víceméně souvisí s výší odběru, a podle tzv. *typu smlouvy*. Ten je dán způsobem užívání zemního plynu, přičemž se uvažují kombinace těchto způsobů využití: vaření, ohřev vody (TUV),

vytápění a (pouze pro maloodběr) technologie. Celkem je uvažováno 16 zákaznických segmentů (7 pro domácnosti a 9 pro maloodběr). Parametry modelu se odhadují zvlášť pro každý segment zákazníků.

Model se mírně liší pro neotopové a otopové segmenty (tj. segmenty neobsahující, resp. obsahující, zákazníky, kteří využívají zemní plyn k vytápění). Spotřebu Y_{ikt} zákazníka i z neotopového segmentu k ve dni t modelu jeme vztahem

$$Y_{ikt} = \mu_{ik}(\Psi_t e^{-\gamma_k \varphi(T_t, N_t)} + p_k) + \varepsilon_{ikt}, \quad (1)$$

kde μ_{ik} je individuální parametr zákazníka i (v podstatě násobek jeho roční spotřeby), $\Psi(t)$ je sezónní složka modelu společná pro všechny segmenty (odhadnutá v minulosti z agregovaných dat za celou ZČP, v současnosti k ní přistupujeme jako k pozorované), γ_k je parametr určující míru teplotní závislosti spotřeby v segmentu k , p_k je stálá složka spotřeby zákazníků ze skupiny k , T_t je skutečná a N_t normálová teplota ve dni t . Funkce φ je rozdíl teplot (skutečné a normálové) oříznutý pro hodnoty vyšší než 14°C. K tomuto oříznutí přistupujeme proto, že teplotní závislost spotřeby je porovávána pouze v teplotách nižších než 14°C. Člen ε_{ikt} je považován za náhodnou veličinu s nulovou střední hodnotou a rozptylem úměrným systematické složce spotřeby. Nejsou kladeny žádné předpoklady o rozdělení ε_{ikt} .

Pro otopové segmenty je model mírně modifikován:

$$Y_{ikt} = \mu_{ik} [I_t (\Psi_t e^{-\gamma_k \varphi(T_t, N_t)} + p_k) + (1 - I_t) q_k] + \varepsilon_{ikt}, \quad (2)$$

kde q_k je konstanta určující průměrnou výši spotřeby v “létě” a $I_t = 1$, je-li průměrná teplota za poslední tři dny (tj. za dny $t, t-1, t-2$) nižší než 14°C. V opačném případě je $I_t = 0$.

Navrhovaná modifikace Gamma modelu spočívá ve znárodnění individuálního parametru μ_{ik} . V současné fázi je tato modifikace spojena i se změnou předpokladů o náhodném členu ε_{ikt} . Pro jednoduchost budeme v následujícím textu uvažovat pouze modifikaci modelu (1). Modifikace modelu (2) pro otopové segmenty je zcela analogická.

3. Model se smíšenými efekty

3.1. Popis modelu

Pro spotřebu Y_{ikt} zákazníka i z (neotopového) segmentu k ve dni t uvažujeme nový model

$$Y_{ikt} = (\mu_k e^{b_{ik}})(\Psi_t e^{-\gamma_k \varphi(T_t, N_t)} + p_k) + \varepsilon_{ikt}, \quad (3)$$

kde μ_k je pevná část individuální složky (společná pro celý segment), b_{ik} je náhodná veličina, u níž předpokládáme normální rozdělení s nulovou střední hodnotou a rozptylem σ_b^2 , z čehož plyne logaritmicke-normální rozdělení nového individuálního “parametru” $\mu_k e^{b_{ik}}$. U náhodného členu ε_{ikt} předpokládáme rovněž normální rozdělení s nulovou střední hodnotou a rozptylem σ^2 .

3.2. Odhad parametrů

Parametry modelu odhadujeme ve dvou krocích:

1. Odhadneme parametry $\beta_k = (\mu_k, \gamma_k, p_k)^T$ a b_{ik} metodou penalizovaných nelineárních nejmenších čtverců (PNLS), tj. minimalizací funkce

$$\sum_{i \in k} \left[\|Y_{ik} - f_{ik}(\beta_k, b_{ik})\|^2 + (\hat{\Delta} b_{ik})^2 \right], \quad (4)$$

kde Y_{ik} je vektor spotřeb i -tého zákazníka ze segmentu k za příslušné období (které je ovlivněno dostupností dat – chybějící pozorování jsou vynechána), $f_{ik}(\beta_k, b_{ik})$ je vektor hodnot regresní funkce

$$f_{ikt}(\beta_k, b_{ik}) = (\mu_k e^{b_{ik}})(\Psi_t e^{-\gamma_k \varphi(T_t, N_t)} + p_k)$$

za totéž období a $\hat{\Delta}$ je aktuální odhad poměru $\Delta = \sigma_b^2 / \sigma^2$.

2. S využitím odhadů $\hat{\beta}_k$ a \hat{b}_{ik} získaných v předchozím kroku odhadneme rozptyly σ_b^2 a σ^2 pomocí výběrových rozptylů $\hat{\sigma}_b^2 = \text{var}(\hat{b}_{ik})$ a

$$\hat{\sigma}^2 = \text{var} \left[Y_{ik} - f_{ik}(\hat{\beta}_k, \hat{b}_{ik}) \right]$$

a zopakujeme předchozí krok s aktualizovaným odhadem poměru Δ .

Minimalizaci funkce (4) lze snadno převést na problém nelineárních nejmenších čtverců tak, že položíme $\tilde{Y}_{ik} = (Y_{ik}, 0)^T$ a $\tilde{f}_{ik}(\beta_k, b_{ik}) = (f_{ik}(\beta_k, b_{ik}), \hat{\Delta} b_{ik})^T$ a pak minimalizujeme funkci

$$\sum_{i \in k} \|\tilde{Y}_{ik} - \tilde{f}_{ik}(\beta_k, b_{ik})\|^2. \quad (5)$$

K tomu je již možné použít libovolný hotový software, v našem případě se jednalo o *Optimization toolbox* k *MATLABu* (konkrétně o funkci `lsqnonlin`).

Optimalizaci začínáme PNLS s počátečním odhadem $\hat{\Delta} = 1$ a počátečními hodnotami parametrů β , b_{ik} takovými, aby odpovídaly parametrům z poslední verze stávajícího Gamma modelu. Vyše uvedené dva kroky opakujeme, dokud rozdíl mezi po sobě následujícími odhady

nejdou menší než stanovená mez (v této fázi byla mez nastavena na 10^{-7} pro 5 po sobě následujících odhadů). Rozdíly jsou ve většině segmentů dostatečně malé již v prvních pěti krocích. Z toho důvodu (také s ohledem na výpočetní náročnost) byl maximální počet iterací nastaven na poměrně nízkou hodnotu 20.

3.3. Použitá data

Výše uvedené metody vyžadují data v denním rozlišení. Byla proto použita data z náhodného výběru cca 700 zákazníků z celé ČR, jejichž spotřeby byly měřeny v období délky dvou let (říjen 2004 - září 2006) v rámci projektu "Tvorba typových diagramů dodávky" (TDD) organizovaném Českou plynárenskou unií. Data obsahují nemalé množství chybějících (nebo chybných) hodnot, které byly pro účely odhadu parametrů vypuštěny. Tento datový soubor je vhodný pro výzkumné účely. Pro případný provoz modelu je však nutné model upravit tak, aby mohly být parametry odhadovány z dat agregovaných za větší časové úseky. K dispozici máme např. soubor cca 1700 měsíčně odečítaných zákazníků získaný v rámci grantu GA AV ČR č. 1ET400300513. Minimálně odhad náhodného parametru b_{ik} je však nutné v případě provozního využití počítat přímo z pravidelných (zpravidla ročních) odečtů daného zákazníka. Pořizování dat s vyšší frekvencí odečtu (i např. měsíčních) je totiž finančně i technicky příliš náročné.

4. Porovnání obou modelů

4.1. Rozptyl reziduí

Rozptyl reziduí z modelu se smíšenými efekty je dle očekávání nižší než rozptyl reziduí původního modelu Gamma. Ke snížení rozptylu došlo ve všech zákaznických segmentech. Na celém vzorku zákazníků došlo ke snížení rozptylu o cca 21 %. Rozptyly reziduí z obou modelů v jednotlivých segmentech zákazníků jsou uvedeny v tabulce 1.

Na obrázku 1 jsou histogramy reziduí z obou modelů pro vybraný segment zákazníků. I zde je viditelné snížení rozptylu, byť je třeba přiznat, že v ostatních segmentech toto není z histogramů patrné v takové míře.

Typ	Užití ZP	Rozptyl rez.		Rozdíl (%)
		Gamma	NLME	
D	O	24.7043	16.6759	32.4977
D	T	25.3028	10.6976	57.7215
D	O+T	77.9285	60.8689	21.8913
D	O+V	20.0326	13.0108	35.0518
D	V+T	1.7415	0.681	60.8984
D	O+T+V	24.9684	20.8241	16.5981
M	T	510.0277	331.0669	35.0884
M	O+T	636.4539	527.0364	17.1917
M	V	73.5877	61.4379	16.5107
M	O+V	241.1401	193.8942	19.5927
M	V+T	625.567	625.5272	0.0064
M	O+T+V	803.7484	603.7964	24.8774
M	Tc	1914.7845	1420.1211	25.8339
M	Tc+O	1328.3279	1158.1101	12.8144
Total		479.2681	378.6474	20.9947

Tabulka 1: Rozptyl reziduí ve vybraných segmentech, D – domácnost, M – malooběh, O – vytápění, T – ohřev vody, V – vaření, NLME – model se smíšenými efekty, Gamma – model s pevnými efekty.

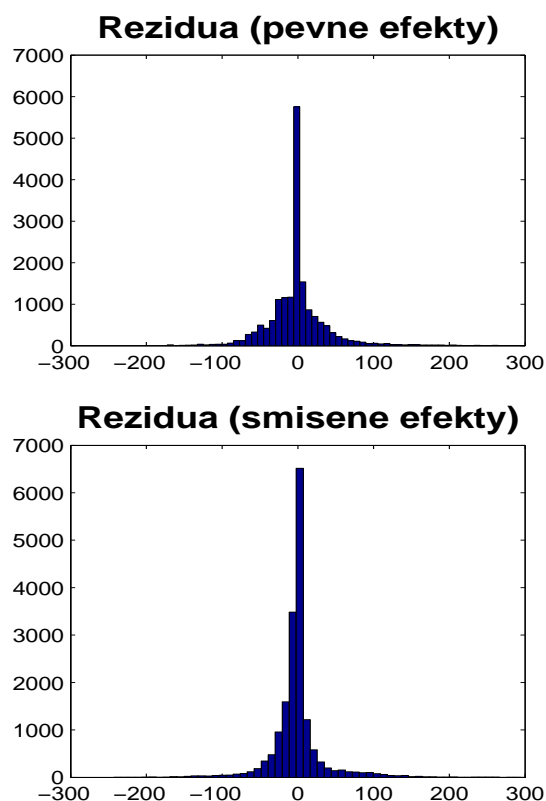

Obrázek 1: Histogram reziduí stávajícího modelu Gamma a modelu se smíšenými efekty – segment malooběh-technologie

4.2. Časový průběh odhadů

Na obrázku 2 vidíme porovnání časových průběhů původního Gamma modelu a nového modelu se smíšenými efekty. Lze pozorovat mírné vylepšení odhadu v případě modelu se smíšenými efekty. Jedná se o segment otopový. Průběh v ostatních otopových segmentech je podobný. V neotopových segmentech je vylepšení rovněž pozorovatelné, avšak rozdíl je o něco větší. Na uvedený obrázek je však třeba pohlížet s určitou rezervou, neboť v této chvíli není zcela jasné, jaký podíl na zlepšení má volba modelu a jaký volba optimalizačních metod (parametry původního Gamma modelu byly odhadovány metodou váženého nejmenšího součtu absolutních hodnot reziduí, narozdíl od penalizovaných nejmenších čtverců použitých v případě modelu se smíšenými efekty.)

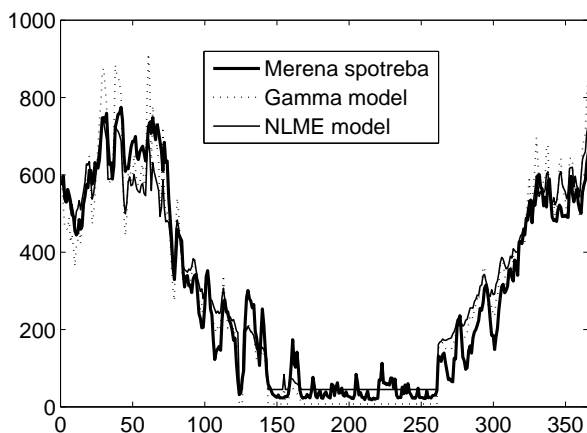

Obrázek 2: Porovnání modelových spotřeb a měřené spotřeby za rok 2005 (na ose x jsou dny tak, že 1=1.1.2005), segment domácnosti-vytápění

5. Závěr a výhledy

Byl prezentován nelineární regresní model pro odhad spotřeby zemního plynu domácností a maloodběratelů a především jeho modifikace na bázi nelineárního regresního modelu se smíšenými efekty. Oba přístupy (pevné a smíšené efekty) byly porovnány dle vybraných kritérií, přičemž bylo pozorováno určité vylepšení odhadu v případě modelu se smíšenými efekty.

V rámci dalšího výzkumu je třeba prošetřit zejména ná-

sledující oblasti:

1. Úprava metod odhadování tak, aby mohla být využívána data z měsíčních, resp. ročních odečtů (alespoň pro individuální parametr zákazníka).
2. Analýza předpokladu o konstantním rozptylu reziduí, prozkoumat možnosti proměnlivosti rozptylu v čase či závislosti na výši spotřeby.
3. Analýza možností modifikace sezónní složky modelu (v současné době považované za pozorovanou).
4. Analýza teplotní závislosti spotřeby (případná modifikace závislostní funkce).

Literatura

- [1] J. Čermáková, J. Matějovic, O. Naxerová, J. Bečvář, M. Brabec, T. Brabec, O. Konár, M. Malý, E. Pelikán, M. Šimůnek, J. Vondráček "Matematické modelování spotřeby zemního plynu zákazníků bez průběhového měření", *Plyn*, č. 2/2005, ISSN 0032-1761, pp. 34–37, 2005.
- [2] J. Čermáková, O. Volfová-Naxerová, J. Bečvář, "Stanovení objemu nevyfakturovaného plynu pomocí virtuální fakturace a matematického modelu GAMMA", *Plyn*, č. 4/2005, ISSN 0032-1761, pp. 76–79, 2005.
- [3] M. Davidian, D. M. Giltinan, "Nonlinear Models for Repeated Measurement Data", Chapman & Hall, London, 1995.
- [4] O. Konár, "Matematické modelování spotřeby zemního plynu domácností a maloodběratelů", *sborník konference ROBUST 2006*, ISBN 80-7015-073-4, pp. 151–158, 2006.
- [5] J. C. Pinheiro, D. M. Bates, "Mixed-Effects Models in S and S-PLUS", Springer-Verlag, New York, 2000.
- [6] J. Vondráček, E. Pelikán, O. Konár, J. Čermáková, K. Eben, M. Malý, M. Brabec, "A statistical model for the estimation of natural gas consumption", *accepted for publication in Applied Energy*

Learning of Multilayer Perceptrons with Piecewise-Linear Activation Functions

Post-Graduate Student:

ING. DAVID KOZUB

Department of Mathematics
Faculty of Nuclear Science and Physical Engineering
Czech Technical University
Trojanova 13

120 00 Prague 2, CZ

zub@linux.fjfi.cvut.cz

Supervisor:

ING. RNDR. MARTIN HOLEŇA, CSC.

Institute of Computer Science of the ASCR, v. v. i.
Pod Vodárenskou věží 2
182 07 Prague 8, CZ

martin@cs.cas.cz

Field of Study:
Mathematical Engineering

Abstract

This paper deals with learning of neural networks with piecewise-linear activation functions. Two approaches are discussed. The first approach works solely with networks with piecewise-linear activation functions. Both a generic method, searching for division points of the activation function, its tangent and its constant terms using a generic optimization method is used, and a specific algorithm for learning with fixed activation function is developed. The second approach uses a network with smooth transfer function. The network is then approximated using a network with piecewise-linear activation function.

1. Introduction

Multilayer perceptrons with piecewise-linear activation functions are theoretically important and have been successfully used in data mining. In the training process neural networks with smooth activation functions were used and only after the training were the smooth activation functions approximated by piecewise-linear activation functions. In the year 2000 a specific method for perceptrons with one hidden layer and a specific piecewise-linear activation function (symmetric saturating activation function) was published.

2. Notational Preliminaries

Let A be a matrix from $\mathbb{R}^{m,n}$, that is an m by n matrix with real components. Then \hat{A} denotes a matrix from $\mathbb{R}^{m+1,n}$ that is created from A by prepending a row of ones above the original matrix A :

$$\hat{A} = \begin{pmatrix} 1 & \dots & 1 \\ a_{1,1} & \dots & a_{1,n} \\ \vdots & \ddots & \vdots \\ a_{m,1} & \dots & a_{m,n} \end{pmatrix} = \begin{pmatrix} 1 \dots 1 \\ A \end{pmatrix}$$

Likewise for vector \vec{b} from \mathbb{R}^n :

$$\hat{b} = \begin{pmatrix} 1 \\ b_1 \\ \vdots \\ b_n \end{pmatrix}$$

Furthermore, the rows of \hat{A} and the components of \hat{b} will be indexed from zero.

Let $\vec{a}, \vec{b} \in \mathbb{R}^n$. Then $\langle \vec{a}, \vec{b} \rangle$ denotes the dot product in \mathbb{R}^n :

$$\langle \vec{a}, \vec{b} \rangle = \sum_{i=1}^n a_i b_i$$

3. Piecewise-linear functions

Definition 1 Function $f: D \rightarrow \mathbb{R}^N$, where $D \subseteq \mathbb{R}^M$ is piecewise-linear (PWL) iff there exist $P \in \mathbb{N}$ and convex polytopes R_1, \dots, R_P with the following properties:

1. $(\forall i \in \{1, \dots, P\}) R_i \subseteq D$
 2. $\bigcup_{i=1}^P R_i = D$
 3. $(\forall i, j \in \{1, \dots, P\}, i \neq j) R_i \cap R_j \subseteq \partial R_i \cap \partial R_j$
 4. $(\forall i \in \{1, \dots, P\}) f|_{R_i}$ is linear,
- where ∂R_i denotes the boundary of the set R_i .

It follows from the definition that for arbitrary PWL

function $f : \mathbb{R}^M \rightarrow \mathbb{R}^N$ there exist a finite set of hyperplanes defining the dividing polytopes. Let \mathcal{H}_f denote the system of such hyperplanes of the PWL function f .

Each member of the system \mathcal{H}_f can be described by an equation of the form $\langle \vec{a}, \vec{x}_k \rangle = b$ for some vector $\vec{a} \in \mathbb{R}^M$ and some scalar $b \in \mathbb{R}$.

4. The Forward Approach

The forward approach works as would be naturally expected: we are given a feed-forward neural network with piecewise-linear (PWL) activation function and we train this network.

The goal of this chapter is to use the specific properties of the network and devise a learning algorithm that would use this fact.

This chapter is based on the algorithm *Piecewise-Linear Optimization* (PWLO) introduced in [1].

4.1. PWLO

The algorithm of piecewise-linear optimization is an algorithm designed for a very specific feed-forward neural network: The network has one hidden layer with the saturating linear transfer function; it has one node in the output layer and the output layer uses the identity as its transfer function. (See the figure 1.)

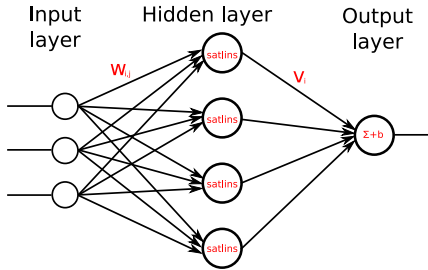

Figure 1: Scheme of the network used in the PWLO method.

One of the interesting properties of PWLO is that it is not a gradient algorithm.

4.1.1 Basic idea of PWLO: The principle of the method is based on the following theorem:

Theorem 1 ([1]) *Let $f : \mathbb{R}^N \rightarrow \mathbb{R}$ be a PWL function and L be a set of local minima of f . Furthermore let L be connected and bounded. Then there is an $\vec{x}_0 \in L$ such that \vec{x}_0 is the intersection of at least N hyperplanes from the set \mathcal{H}_f .*

This theorem implies that in search for a local minimum of f it is possible to restrict the search only to points that lie on the intersection of at least N hyperplanes from the system \mathcal{H}_f . This reduces the problem to efficient enumeration of such points.

We now describe the PWLO algorithm in a way that can be used for generic PWL objective function. Let $E : \mathbb{R}^N \rightarrow \mathbb{R}$ (for some $N \in \mathbb{N}$) be a continuous and bounded below PWL function.

The algorithm works in two stages:

4.1.2 Stage A: The goal of stage A is to find a point that is an intersection of at least N hyperplanes from \mathcal{H}_E . Stage A starts in randomly chosen point $\vec{x} \in \mathbb{R}^N$. We take a step in the direction opposite to the direction of the gradient until we hit the nearest hyperplane of the system \mathcal{H}_E . Then we take another step in the direction of projection of the gradient onto the hyperplane found. This way we continue to eventually find a point that is the intersection of N hyperplanes.

It can be assumed (in accordance with definition 1) that the following equations hold:

$$\langle \vec{a}_j, \vec{x}_k \rangle = b_j \quad (1)$$

for all $j \in \{1, \dots, k\}$, where \vec{x}_k denotes the point found after k steps.

The system of equations (1) can be rewritten:

$$A^{(k)} \vec{x}_k = \vec{b}^{(k)} \quad (2)$$

where:

$$A^{(k)} = \begin{pmatrix} \vec{a}_1 \\ \vdots \\ \vec{a}_k \end{pmatrix} \quad \vec{b}^{(k)} = \begin{pmatrix} b_1 \\ \vdots \\ b_k \end{pmatrix}$$

Let \vec{P}_k denote the projection of the gradient onto the intersection of the hyperplanes contained in equation (2). Then the new point is found as follows:

$$\vec{x}_{k+1} = \vec{x}_k - \eta_{min} \vec{P}_k$$

where η_{min} is the smallest positive value needed to intersect a hyperplane from the set \mathcal{H}_E .

The description of the hyperplanes in the system \mathcal{H}_E and the value of η_{min} depends on the specific function E .

4.1.3 Stage B: Stage B starts at a point that is the intersection of at least N linearly independent hyperplanes. Let that point be \vec{x}_N and let the following equation hold:

$$A^{(N)}\vec{x}_N = \vec{b}^{(N)} \quad (3)$$

We want to move to another point that is again the intersection of at least N linearly independent hyperplanes. We do this by perturbing the k -th component of $\vec{b}^{(N)}$ by some small constant ν :

$$\vec{b}_\nu = \vec{b}^{(N)} + \nu\vec{e}_k$$

where \vec{e}_k is the k -th vector of the standard basis of \mathbb{R}^N .

The system (3) then changes into

$$\langle \vec{a}_i, \vec{x} \rangle - b_i = 0 \quad (\forall i \in \{1, \dots, N\} - \{k\}) \quad (4)$$

$$\langle \vec{a}_k, \vec{x} \rangle - b_k = \nu \quad (5)$$

Let \vec{x}_ν be the solution of that system of equations. The hyperplane (5) is generally not a member of the system \mathcal{H}_E , but the new solution \vec{x}_ν helps us in finding new search direction:

$$\vec{h} = \frac{\vec{x}_\nu - \vec{x}_N}{\|\vec{x}_\nu - \vec{x}_N\|}$$

The line $\vec{x}_N + [\vec{h}]_\lambda$ is the intersection of at least $N-1$ hyperplanes from the system \mathcal{H}_E . This means we can now use the same procedure that we used in stage A to get a new point that is the intersection of at least N linearly independent hyperplanes.

Such new point does not guarantee the decrease of the value of the objective function E . If the value of E is higher for the new point, we discard the new point and retry the procedure with a different value of k . There are $2N$ total options (N for positive ν and N for negative ν). If we succeed in finding a point in which the value of the objective function decreases, we accept that point and execute the same procedure again.

The increase of the objective for all $2N$ directions necessarily means (see theorem 1) we have reached a local minimum of E .

If there are points that retain the same value of E then such point can be accepted, but care must be taken to avoid possible endless loop: We store the point in a list and each time we accept a step that doesn't change the value of E we make sure that the point is not yet in the list.

The application of this algorithm with further details is described in [1].

4.2. GPWLO

The goal of this chapter is to generalize the PWLO method to a larger class of feed-forward networks. First we need to specify the network we used and we need to devise more convenient description of an arbitrary PWL activation function.

4.2.1 The Network Used: In this chapter we use feed-forward neural network with single hidden layer and with one output node with identity transfer function. But we allow for arbitrary continuous PWL transfer function in the hidden layer. Let the topology of the network be I - H -1 (I being the number of inputs and H being the number of hidden neurons).

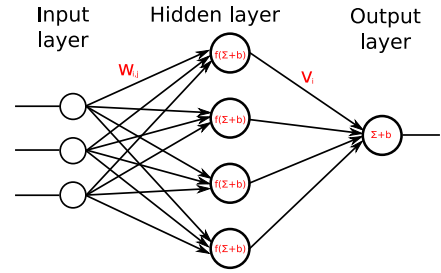

Figure 2: Scheme of the network used in the GPWLO method. The meaning of the symbols used is as follows: f – the transfer function (continuous and PWL), $w_{i,j}$ – weight of the connection of j -th input to i -th neuron in hidden layer, $w_{i,0}$ – bias of i -th neuron in hidden layer, v_i – weight of the connection of i -th neuron in hidden layer to neuron in output layer, v_0 – bias of the output neuron.

The network is depicted in figure (2).

We use the following notation:

$$\begin{aligned} \vec{v} &= (v_0, \dots, v_H) \\ \vec{w}_i &= (w_{i,0}, w_{i,1}, \dots, w_{i,I}) \\ W &= \begin{pmatrix} \vec{w}_1 \\ \vdots \\ \vec{w}_H \end{pmatrix} \end{aligned}$$

Let N denote the total number of parameters (weights and biases) of the network:

$$N = H(I + 1) + H + 1 = (I + 2)H + 1$$

The output of the network for the input $\vec{u} \in \mathbb{R}^I$ is:

$$y(\vec{u}) = \sum_{i=1}^H v_i f \left(\sum_{j=1}^I w_{i,j} u_j + w_{i,0} \right) + v_0$$

That can be written in a more compact form using our notation like this:

$$y(\vec{u}) = \sum_{i=1}^H v_i f \left(\langle \vec{w}_i, \widehat{\vec{u}} \rangle \right) + v_0 \quad (6)$$

We assume in the following text that there is a set of M training examples $\vec{u}(1), \dots, \vec{u}(M)$ and each example $\vec{u}(m)$ has a corresponding target $T(m)$.

The following convention is used throughout this paper: Instead of writing $y(\vec{u}(m))$ we just write $y(m)$ with the same meaning.

4.2.2 PWL Activation Function: Activation function is a function $\mathbb{R}^1 \rightarrow \mathbb{R}^1$. In this chapter we introduce a compact and useful description of arbitrary $\mathbb{R}^1 \rightarrow \mathbb{R}^1$ PWL functions.

Let $f : \mathbb{R}^1 \rightarrow \mathbb{R}^1$ be a continuous PWL function. It follows from the definition of PWL functions that there exist $L \in \mathbb{N}$ and $\gamma_1 < \dots < \gamma_{L-1} \in \mathbb{R}$ so that on each interval defined by the the division of \mathbb{R} by those points the corresponding restriction of f is linear.

Let $\Gamma_1, \dots, \Gamma_L$ denote the intervals created by dividing \mathbb{R} by the points $\gamma_1, \dots, \gamma_{L-1}$ (see figure (3)).

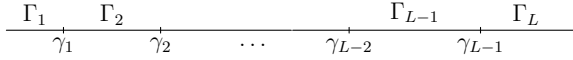

Figure 3: Division of \mathbb{R} using the points $\gamma_1, \dots, \gamma_{L-1}$.

Then for all $l \in \{1, \dots, L\}$, there exist $c_l, d_l \in \mathbb{R}$ such that

$$(\forall x \in \Gamma_l) f(x) = c_l x + d_l$$

This means that arbitrary PWL $\mathbb{R}^1 \rightarrow \mathbb{R}^1$ function can be described by the scalar L and the vectors $\vec{c} = (c_1, \dots, c_L)$, $\vec{d} = (d_1, \dots, d_L)$ and $\vec{\gamma} = (\gamma_1, \dots, \gamma_{L-1})$.

4.2.3 Output of the network: The input to the activation function of i -th neuron ($i \in \{1, \dots, H\}$) for m -th input ($m \in \{1, \dots, M\}$) is $\langle \vec{w}_i, \widehat{\vec{u}}(m) \rangle$. We define matrix $R(\vec{x})$ in the following way: Let l be the index of the interval that $\langle \vec{w}_i, \widehat{\vec{u}}(m) \rangle$ belongs to (so that $\langle \vec{w}_i, \widehat{\vec{u}}(m) \rangle \in \Gamma_l$). Then:

$$R(\vec{x})_{i,m} = l \quad (7)$$

The matrix $R(\vec{x})$ contains information about which interval ($\Gamma_1, \dots, \Gamma_L$) each hidden neuron is activated in by each input. Obviously $R(\vec{x}) \in \{1, \dots, L\}^{H,M}$.

We use the matrix $R(\vec{x})$ to construct the activation matrices C and D as follows:

$$C(\vec{x}) = \begin{pmatrix} C_{1,1} & \dots & C_{1,M} \\ \vdots & \ddots & \vdots \\ C_{H,1} & \dots & C_{H,M} \end{pmatrix} = \begin{pmatrix} c_{R(\vec{x})_{1,1}} & \dots & c_{R(\vec{x})_{1,M}} \\ \vdots & \ddots & \vdots \\ c_{R(\vec{x})_{H,1}} & \dots & c_{R(\vec{x})_{H,M}} \end{pmatrix} \quad (8)$$

$$D(\vec{x}) = \begin{pmatrix} D_{1,1} & \dots & D_{1,M} \\ \vdots & \ddots & \vdots \\ D_{H,1} & \dots & D_{H,M} \end{pmatrix} = \begin{pmatrix} d_{R(\vec{x})_{1,1}} & \dots & d_{R(\vec{x})_{1,M}} \\ \vdots & \ddots & \vdots \\ d_{R(\vec{x})_{H,1}} & \dots & d_{R(\vec{x})_{H,M}} \end{pmatrix} \quad (9)$$

To distinguish the components of \vec{c} and $C(\vec{x})$ we use capital letters for components of the matrix C and lower case letters for components of the vector \vec{c} . Likewise with the matrix D .

Using those matrices the term for the output of the network can be rewritten

$$\begin{aligned} y(m) &= \sum_{i=1}^H v_i f \left(\langle \vec{w}_i, \widehat{\vec{u}}(m) \rangle \right) = \\ &= \sum_{i=1}^H v_i \left(c_{R_{i,m}} \langle \vec{w}_i, \widehat{\vec{u}}(m) \rangle + d_{R_{i,m}} \right) = \\ &= \sum_{i=1}^H v_i \left(C_{i,m} \langle \vec{w}_i, \widehat{\vec{u}}(m) \rangle + D_{i,m} \right) \quad (10) \end{aligned}$$

4.2.4 The Error Function: We use the L1 norm as the error function:

$$E = \sum_{m=1}^M |y(m) - T(m)| \quad (11)$$

It will be shown in the following paragraph that such choice makes is possible to transform E into a PWL function. This in turn makes it feasible to apply the idea of the PWLO algorithm to this more general problem.

The output of the network (10) is piecewise-quadratic. But it is possible to transform the coordinates so that y becomes PWL. We use the following transformation:

$$\Phi = \Phi_1 \circ \Phi_2 \circ \dots \circ \Phi_H$$

where:

$$\Phi_i \begin{pmatrix} \vec{w}_i \\ v_i \end{pmatrix} = \begin{pmatrix} v_i \vec{w}_i \\ v_i \end{pmatrix}$$

Let \vec{w}'_i denote the transformed value of \vec{w}_i . In the new coordinates y is PWL:

$$\begin{aligned} y(m) &= \sum_{i=1}^H v_i \left(C_{i,m} \langle \vec{w}_i, \hat{u}(m) \rangle + D_{i,m} \right) = \\ &= \sum_{i=1}^H \left(C_{i,m} \langle \vec{w}'_i, \hat{u}(m) \rangle + v_i D_{i,m} \right) = \\ &= \langle \hat{D}_{\cdot,m}, \vec{v} \rangle + \langle C_{\cdot,m}^T \cdot W', \hat{u}(m) \rangle \end{aligned}$$

The choice of E ensures E in the new coordinates is PWL, too.

It can be shown that the hyperplane system \mathcal{H}_E describing E consists of two types of hyperplanes. One type, referred to as "A" in this paper, arises from the PWL nature of the activation function f . The other type, referred to as "B" in this paper, is caused by the presence of absolute value in (11).

Analytical description of the hyperplanes, including the

value of η_{min} can be seen in the table 1.

The information in table 1 describes a generalization of the PWLO method. We use the name *Generalized Piecewise-Linear Optimization* for this generalized algorithm throughout the paper.

4.3. Further generalization of GPWLO

In the previous chapter we derived an algorithm that works for arbitrary continuous PWL activation functions. But the function had to be fixed – it was specified at the beginning of the training process and it never changed. An interesting question is: can the GPWLO algorithm be further generalized so that the activation function itself is a result of network training? This is the question we answer in this section.

4.3.1 Continuous PWL activation functions:

Assume f is continuous. Then:

$$\lim_{x \rightarrow \gamma_l^-} f(x) = \lim_{x \rightarrow \gamma_l^+} f(x)$$

i.e.:

$$c_l \gamma_l + d_l = c_{l+1} \gamma_l + d_{l+1} \quad (12)$$

Table 1: Hyperplanes in the GPWLO method (\vec{h} is the search direction and η is the multiplier of \vec{h} needed to intersect corresponding hyperplane).

Type A
$\vec{a}_{i,l,m}^A = \left(\underbrace{0, \dots, 0}_{(I+1)(i-1)}, \underbrace{\hat{u}(m)}_{(I+1)(H-i)}, \underbrace{0, \dots, 0}_i, -\gamma_l, \underbrace{0, \dots, 0}_{H-i} \right)$
$b_{i,l,m}^A = 0$
$\eta_{i,l,m}^A = \frac{\gamma_l v_i - \langle \vec{w}'_i, \hat{u}(m) \rangle}{\langle \vec{h}_{\vec{w}'_i}, \hat{u}(m) \rangle - \gamma_l h_{v_i}}$
$H_{i,l,m}^A = \left\{ \vec{x} \in \mathbb{R}^N \mid \langle \vec{a}_{i,l,m}^A, \vec{x} \rangle = b_{i,l,m}^A \right\} \quad (\forall i \in \{1, \dots, H\}, \forall l \in \{1, \dots, L-1\}, \forall m \in \{1, \dots, M\})$
Type B
$\vec{a}_m^B(R) = \left(C(R)_{1,m} \left(\hat{u}(m) \right)^T, \dots, C(R)_{H,m} \left(\hat{u}(m) \right)^T, \left(\hat{D}(R)_{\cdot,m} \right)^T \right)$
$b_m^B = T(m)$
$\eta_m^B(R) = -\frac{y(m) - T(m)}{\langle \vec{h}_{\vec{v}}, \hat{D}(R)_{\cdot,m} \rangle + \langle h_{W'} \hat{u}(m), C(R)_{\cdot,m} \rangle}$
$H_m^B(R) = \left\{ \vec{x} \in \mathbb{R}^N \mid \langle \vec{a}_m^B(R), \vec{x} \rangle = b_m^B \right\} \quad (\forall m \in \{1, \dots, M\}, \forall R \in \{1, \dots, L\}^{H,M})$

We can ensure the continuity of f by a set of constraints in the form (12). But due to simplicity of the constraints it is possible to ensure the continuity by modifying the set of variables describing the function f . Lets define for all $l \in \{1, \dots, L-1\}$:

$$\begin{aligned}\Delta_l^C &= c_{l+1} - c_l \\ \Delta_l^D &= d_{l+1} - d_l\end{aligned}$$

The constrains now have the form

$$\Delta_l^C \gamma_l + \Delta_l^D = 0 \quad (\forall l \in \{1, \dots, L-1\})$$

Consequently the following parameters are sufficient for description of any continuous PWL activation function:

$$\begin{aligned}c_1 \\ d_1 \\ \vec{\gamma} &= (\gamma_1, \dots, \gamma_{L-1}) \\ \vec{\Delta}^C &= (\Delta_1^C, \dots, \Delta_{L-1}^C)\end{aligned}$$

The original parameters \vec{c} and \vec{d} can be obtained using

$$\begin{aligned}c_l &= c_1 + \sum_{i=1}^{l-1} \Delta_i^C \\ d_l &= d_1 - \sum_{i=1}^{l-1} \gamma_i \Delta_i^C\end{aligned}$$

This way we eliminated the need for constrains ensuring the continuity of f . But we must not forget the constrains on $\vec{\gamma}$ mentioned in section 4.2.2:

$$\gamma_1 < \gamma_2 < \dots < \gamma_{L-1} < \gamma_{L-1} \quad (13)$$

4.3.2 Formulation of the generalized problem:

We start from the output of the network:

$$y = v_0 + \sum_{i=1}^H v_i f(\langle \vec{w}_i, \hat{\vec{u}}(m) \rangle)$$

All the parameters together form a vector \vec{x} :

$$\vec{x} = (W, \vec{v}, c_1, d_1, \vec{\Delta}^C, \vec{\gamma})^T$$

where the matrix W is decomposed row-wise.

The value of \vec{x} describes both the weights and biases in the network and the parameters of the activation function.

Let ν denote the number of parameters of the activation function and Ξ the set of feasible values of \vec{x} :

$$\nu = 2(L-1) + 2 = 2L \quad (14)$$

$$\Xi = \left\{ \vec{x} = (W, \vec{v}, c_1, d_1, \vec{\Delta}^C, \vec{\gamma}) \mid \gamma_1 < \gamma_2 < \dots < \gamma_{L-1} \right\} \quad (15)$$

Total number of parameters of the error function then is $N + \nu$.

Similarly to the GPWLO we define the matrix R : Let $\vec{x} = (W, \vec{v}, c_1, d_1, \vec{\Delta}^C, \vec{\gamma})^T \in \Xi$. Then:

$$R_{i,m}(\vec{x}) = l \iff \langle \vec{w}_i, \hat{\vec{u}}(m) \rangle \in \Gamma_l \quad (16)$$

for each $i \in \{1, \dots, H\}$ and for each $m \in \{1, \dots, M\}$.

In contrast to GPWLO (see (7)) $R(\vec{x})$ now depends not only on the weight matrix W but also on the parameter of activation function $\vec{\gamma}$.

Our task is to find the minimum of E as a function of \vec{x} :

$$E(\vec{x}) = \sum_{m=1}^M E_m(\vec{x}) \quad (17)$$

where:

$$E_m(\vec{x}) = \frac{1}{p} \|y(m, \vec{x}) - T(m)\|_p^p$$

and \vec{x} is constrained to the feasible set Ξ . In this case it is not obvious that the L1 norm would be as useful as it was in (11).

It can be shown, unfortunately, that the problem (17) with the constraints (13) leads to quadratically constrained quadratic programming. To make the problem even worse, the matrices of the quadratic part of the objective function and the constrains are in general not positive definite, so that there are no specific methods to handle this problem.

This means we're stuck with generic optimization algorithms to solve this problem.

4.3.3 ATFO: The method of adaptive transfer function optimization (ATFO) solves the same problem as was discussed in the previous chapter, but instead of trying to use a specific method, we directly apply generic methods to the problem described in equation (17).

This way we lose the specificity of the approach, but still we can train a feed-forward neural network in the intended way: the transfer function is adapted during the training process.

5. Backward approach

The backward approach handles the learning of a PWL feed-forward neural network in a different way: In this approach we start with a feed-forward neural network with smooth sigmoid transfer function. We apply arbitrary learning algorithm to the network. Then we perform a PWL approximation of the transfer function.

This approach was used in [2]. The algorithm was named REBUP (rule extraction by backpropagation of unions of polyhedra).

5.1. The REBUP algorithm

Let σ denote the smooth activation function. We describe the approximation used in the REBUP algorithm to obtain a PWL activation function.

Let $\mathcal{I} = \langle \omega_L, \omega_U \rangle$ be a subset of the domain of f and let $k \in \mathbb{N}$. The algorithm approximates the function σ on the interval \mathcal{I} by a piecewise-linear function with $k + 2$ linear segments.

Denote:

$$\begin{aligned} h_L &= \sigma(\omega_L) \\ h_U &= \sigma(\omega_U) \end{aligned}$$

We define k -tuple of points y_1, \dots, y_k in this way:

$$y_i = h_L + i \frac{h_U - h_L}{k + 1}$$

i.e. the points y_1, \dots, y_k equidistantly cover the interval \mathcal{I} .

We also need the vector $\vec{t} = (t_1, \dots, t_k)$ that is defined like this:

$$t_i = \sigma^{-1}(y_i)$$

The approximated function f is then defined as a PWL function described by the following vectors:

$$\begin{aligned} \vec{\gamma}(\vec{t}) &= (t_1, \dots, t_k) \\ \vec{c}(\vec{t}) &= \left(0, \frac{\sigma(t_2) - \sigma(t_1)}{t_2 - t_1}, \dots, \right. \\ &\quad \left. \frac{\sigma(t_k) - \sigma(t_{k-1})}{t_k - t_{k-1}}, 0 \right) \\ \vec{d}(\vec{t}) &= \left(h_L, \sigma(t_1) - \frac{\sigma(t_2) - \sigma(t_1)}{t_2 - t_1} t_1, \dots, \right. \\ &\quad \left. \sigma(t_{k-1}) - \frac{\sigma(t_k) - \sigma(t_{k-1})}{t_k - t_{k-1}} \sigma(t_{k-1}), h_U \right) \end{aligned}$$

We use the distance of the functions $f_{\vec{t}|_{\mathcal{I}}}$ and $\sigma|_{\mathcal{I}}$ as the error of the approximation:

$$E(\vec{t}) = \int_{\mathcal{I}} (f_{\vec{t}}(s) - \sigma(s))^2 ds$$

The last step is numerical minimization of the term $E(\vec{t})$. This way we get the final approximation of the smooth function σ on the interval \mathcal{I} .

6. Conclusion

The method PWLO was generalized to any arbitrary PWL activation function. The option of adapting the parameters of the PWL function during learning is discussed. Unfortunately this approach leading to quadratically constrained quadratic programming can not be solved using any specific algorithm. Still, the problem can be solved using generic optimization methods.

References

- [1] E. F. Gad, A. F. Atiya, S. Shaheen, A. El-Dessouki, "A new algorithm for learning in piecewise linear neural networks", *Neural Networks*, vol. 13, pp. 485–505, 2000.
- [2] F. Maire, "Rule-extraction by backpropagation of polyhedra.", *Neural Networks*, vol 12, pp. 717–725, 1999.
- [3] D. Kozub, "Learning of multilayer perceptrons with piecewise-linear activation functions" (in Czech), *Master Thesis at CTU*, 2007.

Schema Matching in the Semantic Web Environment

Post-Graduate Student:

ING. ZDEŇKA LINKOVÁ

Department of Mathematics
Faculty of Nuclear Science and Physical Engineering
Czech Technical University
Trojanova 13
120 00 Prague 2, CZ

Institute of Computer Science of the ASCR, v. v. i.
Pod Vodárenskou věží 2

182 07 Prague 8, CZ

linkova@cs.cas.cz

Supervisor:

ING. JÚLIUS ŠTULLER, CSC.

Institute of Computer Science of the ASCR, v. v. i.
Pod Vodárenskou věží 2

182 07 Prague 8, CZ

stuller@cs.cas.cz

Field of Study:
Mathematical Engineering

The work was supported by the project 1ET100300419 of the Program Information Society (of the Thematic Program II of the National Research Program of the Czech Republic) "Intelligent Models, Algorithms, Methods and Tools for the Semantic Web Realization" and partly by the Institutional Research Plan AV0Z10300504 "Computer Science for the Information Society: Models, Algorithms, Applications".

Abstract

The paper deals with one step of the non-materialized data integration - the schema matching task. The proposal is for data sources on the Semantic Web; the crucial assumption for the considered task is the availability of the ontologies describing data to integrate. These ontologies are used to find correspondences between source schemas elements. For this, the techniques from ontology alignment and ontology merging field are used.

1. Introduction

Data integration [1] is a task of combining data residing at different sources and enabling a user to process these data as a one whole. When data integration is non-materialized [2], the issue usually is to provide an unified view over the data sources. This view is then accessed as a new - integrated - data source containing all the data. However, in fact, the view is only virtual and does not store any data; the data physically stay stored in the original sources. In order to enable accessing them through the integrated view, connections between the schema of such an "integrated" view and the schemas of the data sources have to be established.

The integration process can be seen as a collection of several tasks, which together brings the required result. The basic steps of such a data integration are following:

- **Schema matching** - Under an assumption the data sources to integrate have been constructed independently, and their schemas were designed by different designers for different purposes, the data schemas are in general heterogeneous. Therefore, it is crucial, for their processing together, to find

correspondences between them. The problem of *finding* schemas correspondences is called schema matching [4], [5].

- **Schema mapping** - A usual way to *describe* the correspondences between schemas of the integrated data sources is to use mappings.

A mapping can be seen as a structure, e.g. a set of assertions, that establishes a connection between elements of the view schema (usually called global schema) and the data source schemas (local schemas).

Two basic approaches [6], [7] have been used in order to specify the mappings: *a Global As View* (GAV) approach consisting in defining the global schema as a set of views over the local schemas and *a Local As View* (LAV) approach consisting in defining the local sources as a set of views made on the global schema.

- **Query processing** - The composition of mapping is an essential task. It plays a crucial role in querying - another important process of a data integration. Within a data integration (system), a user poses his query on the global view in terms of the glo-

bal view. In order to execute the query over the sources, where data are stored, query processing [3] is needed.

There are two approaches to query processing. The first one is *query rewriting* - a query is decomposed to parts referring to local sources and reformulated to be expressed in local source background. The other one is *query answering* - it does not pose any limitations on how a query is processed, the only goal is to exploit all possible information to compute the answer, for example find the set of data such that the knowledge represented in the data logically implies that it is an answer to the query.

This paper deals with the first step of the integration process. It considers web data sources. In general, data of the current World Wide Web are distributed in many sources, having different formats, heterogeneous (or none) schemas, etc., and so, processing of them is very difficult. Therefore, the data taken into consideration in this approach are restricted to the Semantic Web environment.

Semantic Web [8], [9], [10] is intended as a semantic extension of the current web. Nowadays, the main techniques for the Semantic Web data description are:

- XML language [11] for the data structuring
- RDF(S) [12], [13] for the metadata description
- OWL [14] for the ontology specification

Taking only the Semantic Web data into consideration, data sources with defined ontologies [15] represent a natural assumption for the approach.

The paper is organized as follows: Section 2 introduces the matching operation and brings a brief review of schema matching approaches. Section 3 is concerned with ontology-based schema matching approach; it deals not only with matching discovery, but also with expression of found mappings. Finally, Section 4 summarizes the paper.

2. Schema Matching

The matching operation takes two schemas as an input and produces as an output mappings describing schemas relationships. The task of finding corresponding mappings is a topic of many research projects. Unfortunately, in many projects and implementations, it has been

solved mainly manually [16]. This has significant limitations - it is time consuming, prone to errors and expensive. An effort to automatize this as much as possible resulted at most in providing the so-called match candidates, and the user needs to (manually) adjust the assignment to guarantee their suitability. This is because the schemas have very often some not expressed semantics that affects the matching.

Many ways how to search for schema correspondences were investigated in the past. The approaches can be basically distinguished according to the information level, at which the schemas have been compared:

- **Instance** - At an instance level, matching approaches consider instance data to find the correspondences between the schemas describing these data.
- **Term** - Approaches working at a term level are linguistic-based (e.g., based on names and textual descriptions of schema elements). They can work with terms relations (synonyms, homonyms, etc.) or can be string-based (considering used terms as a character string and comparing them in order to find their relations as prefix, suffix, root, etc.).
- **Structure** - Matching can be performed for individual schema elements, such as attributes, or for combinations of elements, such as complex schema structures. At this level, for instance, graph-based techniques are used.

For example, approaches comparing particular schema attributes can be based on their names (optionally taking into account also known synonym relationships or using lexical techniques), data types, active domains; some of them deal also with the structures of the sources.

A matching possibility obtained by this is often expressed using some similarity function. This similarity can be based on probability [17], on the cosine measure of particular attribute feature vectors [18], or some other measure describing the number of explored aspects in which they correspond [19]. These measures can be further used for selecting matching from found candidates. Sometimes, some additional techniques like candidates refinement [20] or machine learning [21] are used.

3. Ontology-based Schema Matching

In the proposed approach to schema matching, available ontologies describing data in the integrated sources are supposed. From them, required correspondences between particular schema elements will be derived.

Generally, an element can participate in zero, one or many correspondences searched within the matching data schemas. Moreover, an individual element (of some schema) can match one or more elements (of another schema). Therefore, also a term *matching cardinality* is usually used. With respect to a mapping element, matching can be of a cardinality 1:1, 1:N, N:1, N:M. Most existing approaches match each element of one schema to the element of another schema with cardinality 1:1 or 1:N.

This approach considers correspondences of cardinality:

- **1:1** when matching two schemas. This means that one element of the first schema is matched to one element of the other schema.
- **1:N** when matching one schema to more schemas. This can be seen as a set of matching used in the case above. Mentioned 1:N matching is often used in data integration for matching a schema of a global virtual view and schemas of local data sources.

To formalize the notion of the required matching correspondences, a matching of a cardinality 1:1 is an assertion:

$$\varepsilon_1 \rho \varepsilon_2$$

where

ε_1 is an element of one schema

ε_2 is an element of the other schema

ρ is a relation between ε_1 and ε_2 expressing their correspondence.

A matching of a cardinality 1:N is a set of assertions of 1:1 cardinality:

$$\{\varepsilon_1 \rho_i \varepsilon_i\}$$

where

ε_1 is an element of one schema

ε_i is an element of another schema

ρ_i is a relation between ε_1 and ε_i expressing their correspondence.

The relation ρ can be one of the following kinds of correspondence:

- **Is-a** hierarchical relationship (i.e. one element is more general than the other or vice versa). This kind is denoted as \supseteq , respective \subseteq .
- **Equivalence** between the elements. This kind is denoted as $=$.

- **Disjointness**, i.e. elements cannot be matched in any way.

3.1. Schema Mapping

A result of the matching task, found schema correspondences, is often called *schema mapping*. In general, for schema mapping, an arbitrary structure can be used. Mapping can be done in a broad scale from the simplest *one-to-one mapping rules* expressing direct correspondences between elements, through *mapping a concept to a query or a view* [22] (e.g. respecting GAV or LAV approach), to some additional mapping structures (e.g. a reference model in [23]). Different projects usually use their own notion of mapping.

However, instead of using for instance mapping rules as assertions for global and local schemas elements that are particular approach oriented, a more complex and even standardized structure covering all mapping can be employed. An *OWL ontology* will be used to describe the mapping between elements of the global view and the local sources.

The use of an ontology for the mapping brings a possibility to reuse it in other tasks or situations. Also, when deriving further correspondences, taking another schema (of another data source) into account for instance, mapping described in an ontology can be seen as another ontology available for compared sources. Moreover, for the future, considering also other kinds of correspondences, an ontology can be employed, because it can capture various relation types.

To capture the mapping, according to the type of the matching, an appropriate OWL [14] construct is used. In OWL, classes provide an abstraction mechanism for grouping described resources. On the Web, resource is every thing or entity that can be identified. A notion of `owl:Class` is therefore used for elements correspondences:

- For the **is-a** relationship, i.e. $\varepsilon_1 \subseteq \varepsilon_2$, the notion of subclass can be employed. An appropriate OWL feature for this is `rdfs:subClassOf`, which allows one to say that an extension of a class description is a subset of an extension of another class description.
- For the **equivalence** relationship, i.e. $\varepsilon_1 = \varepsilon_2$, an OWL feature `owl:equivalentClass` can be used. `owl:equivalentClass` allows one to say that a class description has exactly the same class extension as another class description.

However, also in this case `rdfs:subClassOf` can be used: defining ε_1 as subclass of ε_2 and at the same time ε_2 as subclass of ε_1 , it is possible to say that ε_1 and ε_2 are equivalent classes.

- The **disjointness** (i.e. to say that an extension of a class description has no members in common with an extension of another class description) can be expressed by `owl:disjointWith`.

3.2. Matching with Shared Ontology Available

In the simplest case, a description of all the sources is covered by the only one ontology. This ontology is shared by the sources and captures all the data description. Schema elements correspondences can be directly find in the given ontology.

For this, following assumption is adopted:

The semantic relationship between terms defined in the ontology implies the same relationship between schema elements labeled by these terms.

Considering previously stated correspondences types class-subclass and class equivalence, an is-a hierarchy defined by the shared ontology is used. When matching two data source schemas, for each element of the first schema and for each element of the other one, their relationship is searched in the ontology - if an is-a relationship is defined in the ontology, the appropriate correspondence is between the compared elements.

Some relationships need not be in the ontology directly expressed, however, they can be obtained using transitivity of subclass relationship. For example, when approaching an ontology as a graph with classes as nodes and is-a relationship labeled edges, found correspondence between two elements means not only an existing edge of that label, but also an oriented path between the classes appropriately labeled.

When classes are disjoint, it means that there should not be any is-a hierarchy relationship between them, and, therefore, it is not needed to search it. However, this situation leads in practice to the same effect as relationships had been searched, but none has been found.

As, to capture the mapping, an OWL expression is used, the given shared ontology can be seen as a "superontology" of the searched mapping, in that sense that it describes all the classes and their relationships as stated in the mapping.

Note that all correspondences derived from the given ontology are adopted; they are not considered only as

matching candidates, because there is no correspondence estimation - all of them are defined in the ontology. This step demand no (human) user interaction.

3.3. General Matching with Ontologies

Generally, for definitions of terms in the sources, more ontologies are used. Some sources can use for some terms a shared ontology, but it does need to cover all the terms, and the use of a shared ontology cannot be assumed. Instead of it, all supported ontologies have to be considered.

By merging all given ontologies, a "new" shared ontology is obtained, and this general case can be transformed to the previous one. For doing this, ontology alignment or ontology merging methods can be employed.

In the context of ontologies, terms alignment and merging are closely related [24]. For both, also matching and mapping are relevant. *Ontology alignment* usually means a task of establishing a collection of binary relations between two ontologies. This allows to define a way for merging of ontologies. *Ontology merging* results in a new, integrated ontology.

Methods for *matching in the field of ontology merging* or *ontology alignment* are of *similar principles* to the *methods for schema matching*. That is, because ontologies and data schemas are closely related. The main difference is a purpose. An ontology is developed in order to define a meaning of terms used in some domain, whereas a schema is developed in order to model some particular data. Especially for schemas using a semantic data model, there is often no obvious difference and way to identify which representation is a schema and which is an ontology. In practise, schemas and ontologies usually have both well defined terms and contexts of their occurrence. Because data schemas often do not provide explicit semantics for their data, matching is usually performed with the help of techniques trying to guess the meaning of used terms. When assuming available data source ontologies, this is not needed.

Methods for ontology alignment or ontology merging are performed, as methods for schema matching, at different levels: *instance* (e.g. comparing set of instances), *element* (e.g. lexical techniques), and *structure* (e.g. graphs techniques), and use syntactic and semantic approach.

Also similarity with so-called match candidates can be found. Methods therefore require user interaction or use some heuristics based on user earlier decisions. Note, although in the case of a shared ontology, there are no candidates, and correspondences are strictly derived, the

candidates can arise from this subtask.

Ontology merging methods are topics of many research projects:

- **Chimaera** [25] - The Chimaera system tool provides *support for merging of different ontologies* that may have been written by different authors using different vocabularies. It is based on a Ontolingua ontology editor [26], and considers only the class-subclass relation.

Chimaera is an interactive merging tool that demand user interaction: it generates name resolution lists that help the user in the merging task by suggesting terms each of which is from a different ontology that are candidates to be merged or to have taxonomic relationships not yet included in the merged ontology. Chimaera leaves the decision of what to do entirely to the user and does not make any suggestions itself.

- **PROMPT** [27] - The PROMPT is an algorithm for *semi-automatic ontology merging and alignment*. It performs some tasks automatically and guides the user in performing other tasks for which his intervention is required. It also determines possible inconsistencies, which result from user actions, and suggests ways to resolve these inconsistencies.

First, PROMPT creates an initial list of matches based on class names. Then follows the cycle of selecting candidates (by the user) and automatically executed actions - the algorithm works with data types, considers linguistically similar names and subclass hierarchy.

The PROMPT ontology merging algorithm was implemented as an *extension to the Protégé-2000* [28] ontology editor.

- **FCA-MERGE** [29] - The FCA-MERGE is a method for merging ontologies following a *bottom-up approach* which offers a *structural description of the merging process*.

For the source ontologies, it extracts instances from a given set of domain-specific text documents relevant to the merged ontologies by applying natural language processing techniques.

Based on the extracted instances, mathematically founded techniques taken from Formal Concept Analysis [30] are applied to derive a lattice of concepts as a structural result of FCA-MERGE. Instance extraction and the FCA-MERGE core algorithm are fully automatic. The generated result

is then explored and transformed into the merged ontology with human interaction.

- **HCONE** [31] - HCONE approach on ontology merging *exploits WordNet* [32], which is an external natural language information source. The HCONE method consults WordNet for lexical information. Linguistic and structural knowledge about ontologies are exploited by the Latent Semantics Indexing method (LSI - a vector space technique for information retrieval and indexing) [33] for associating concepts to their informal, human-oriented intended interpretations realized by WordNet senses.

Using concept intended semantics, the proposed method translates formal concept definitions to a common vocabulary and exploits the translated definitions by means of description logics reasoning services. The goal is to validate the mapping between ontologies and to find a minimum set of axioms for the merged ontology. The HCONE approach is not completely automated; human involvement is placed at the early stages of the mapping/ merging process.

4. Summary and Conclusion

Schema matching is a crucial part of a data integration process. The matching result, a mapping, is then used when accessing integrated data. For schema matching, several techniques based on various information about data sources are employed. With source ontologies available, it is possible to derive the requested correspondences between data schemas.

An important issue is a way how to express the found mapping. In this approach, an OWL ontology is used. This brings a possibility to share or reuse the derived mapping. The mapping expressed in a standardized way can be further used in other situations and accessed also by various tools. In particular, this mapping allows to use techniques developed for ontology processing.

If an ontology shared by all the data sources is supported, mapping of source schemas can be easily obtained from this ontology. Generally, if there are two or more ontologies used for data description, these ontologies are merged. Ontology merging results in getting a shared ontology as stated earlier, and the mapping can be then obtained. So, by this approach, the task of schema matching is transformed to the ontology merging task, for which, there are available methods and tools that can be employed.

An ontology-based schema matching is a subtask of

ontology-based data integration which will be studied more in my thesis.

References

- [1] Z. Bellahsene, "Data integration over the Web", *Data & Knowledge Engineering*, 44 (2003), pp. 265-266.
- [2] J. D. Ullman, "Information integration using logical views", *Theoretical Computer Science* 239 (2000), pp. 189-210.
- [3] R. Pottinger and A. Levy, "A Scalable Algorithm for Answering Queries Using Views", In the Proceedings of the *26th VLDB Conference*, Cairo, Egypt (2000).
- [4] E. Rahm and P. A. Bernstein, "A survey of approaches to automatic schema matching", In *VLDB Journal: Very Large Data Bases*, 10(4), pp. 334-350, 2001.
- [5] P. Shvaiko and J. Euzenat, "A survey of schema-based matching approaches", 3730, pp. 146-171, 2005.
- [6] M. Lenzerini, "Data Integration: A Theoretical Perspective", In Proceedings of the *21st ACM SIGMOD - SIGACT - SIGART symposium on Principles of database systems*, ACM Press, pp. 233-246, 2002.
- [7] A. Cali, D. Calvanese, G. De Giacomo, and M. Lenzerini, "On the Expressive Power of Data Integration Systems", In Proceedings of the *21st Int. Conf. On Conceptual Modeling (ER 2002)*, LNCS 2503, Springer, pp. 338-350, 2002.
- [8] T. Berners-Lee, J. Hendler and O. Lassila, "The Semantic Web", *Scientific American*, vol. 284, 5, pp. 35-43, 2001.
- [9] M.-R. Koivunen and E. Miller, "W3C Semantic Web Activity", in the proceedings of the *Semantic Web Kick/off Seminar*, Finland, 2001.
- [10] J. Euzenat. "Research challenges and perspectives of the Semantic Web". Report of the EU-NSF Strategic Research Workshop, Sophia-Antipolis, France, October, 2001.
- [11] Extensible Markup Language (XML), <http://www.w3.org/XML/>.
- [12] Resource Description Framework (RDF), <http://www.w3.org/RDF/>.
- [13] RDF Vocabulary Description Language 1.0: RDF Schema, *W3C Recommendation*, <http://www.w3.org/TR/2004/REC-rdf-schema-20040210>.
- [14] Web Ontology Language (OWL), <http://www.w3.org/2004/OWL>.
- [15] Y. Ding, D. Fensel, M. Klein, and B. Omelayenko, "The semantic web: yet another hip?", *Data & Knowledge Engineering*, 41 (2002), pp. 205-227.
- [16] P. Mitra, G. Wiederhold, and J. Jannink, "Semi-automatic integration of knowledge sources", In Proceeding of the *2nd Int. Conf. On Information FUSION'99*, 1999.
- [17] H. Nottelmann and U. Straccia, "Information retrieval and machine learning for probabilistic schema matching", *Inf. Process. Manage.*, 43(3), pp. 552-576, 2007.
- [18] X. Su and J. A. Gulla, "An information retrieval approach to ontology mapping", *Data & Knowledge Engineering* 58(1), pp. 47-69, 2006.
- [19] S. Yi, B. Huang, and W. T. Chan, "Xml application schema matching using similarity measure and relaxation labeling", *Inf. Sci.*, 169(1-2), pp. 27-46, 2005.
- [20] H.-H. Doa and E. Rahmb, "Matching large schemas: Approaches and evaluation", *Information Systems*, (in print), 2007.
- [21] L. Xu and D. W. Embley, "A composite approach to automating direct and indirect schema mappings", *Inf. Syst.*, 31(8), pp. 697-732, 2006.
- [22] D. Calvanese, G. De Giacomo, and M. Lenzerini, "Ontology of integration and integration of ontologies", In Proceedings of the *2001 Description Logic Workshop (DL 2001)*, 2001.
- [23] H. T. Uitermark, P. J. M. van Oosterom, N. J. I. Mars, and M. Molenaar, "Ontology-based integration of topographic data sets", *International Journal of Applied Earth Observation and Geoinformation* 7 (2005), pp. 97-106.
- [24] Y. Kalfoglou and M. Schorlemmer, "Ontology mapping: the state of the art", *The Knowledge Engineering Review* 18(1), pp. 1-31, 2003.
- [25] D. L. McGuinness, R. Fikes, J. Rice, and S. Wilder, "An Environment for Merging and Testing Large Ontologies", In Proceedings of the *Seventh International Conference*, 2000.
- [26] A. Farquhar, R. Fikes, and J. Rice, "The Ontolingua Server: a Tool for Collaborative Ontology Construction", Technical report, Stanford KSL 96-26, 1996.
- [27] N. F. Noy and M. A. Musen, "PROMPT: Algorithm and Tool for Automated Ontology Merging and Alignment", In *AAAI/IAAI*, pp. 450-455, 2000.

- [28] The Protégé Ontology Editor and Knowledge Acquisition System,
<http://protege.stanford.edu/>.
- [29] G. Stumme and A. Maedche “FCA-MERGE: Bottom-Up Merging of Ontologies”, In *IJCAI*, pp. 225-234, 2001.
- [30] U. Priss, “Formal Concept Analysis in Information Science (draft)”,
<http://www.upriss.org.uk/papers/arist.pdf>.
- [31] K. Kotis and G. A. Vouros, “The HCONE Approach to Ontology Merging”, In *ESWS, LNCS 3053*, Springer, pp. 137-151, 2004.
- [32] WordNet, a lexical database for the English language,
<http://wordnet.princeton.edu/>.
- [33] S. C. Deerwester, S. T. Dumais, T. K. Landauer, G. W. Furnas, and R. A. Harshman, “Indexing by Latent Semantic Analysis”, *Journal of the American Society of Information Science* 41(6), pp. 391-407, 1990.

Communication Problems Among Heterogenous EHR Systems

Post-Graduate Student:

MGR. MIROSLAV NAGY

Department of Medical Informatics
Institute of Computer Science of the ASCR, v. v. i.
Pod Vodárenskou věží 2

182 07 Prague 8, CZ

nagy@euromise.cz

Supervisor:

RNDR. ANTONÍN ŘÍHA, CSc.

Department of Medical Informatics
Institute of Computer Science of the ASCR, v. v. i.
Pod Vodárenskou věží 2

182 07 Prague 8, CZ

riha@euromise.cz

Field of Study:
Biomedical Informatics

This work was supported by the project number 1ET200300413 of the Academy of Sciences of the Czech Republic.

Abstract

This paper describes the problem of medical information transportation among heterogenous Electronic Health Record (EHR) systems. First we describe the details of the problematics and mention some examples. After that we show a proposed solution methodology and a pilot application of an EHR system called AdamekJ capable of interchanging data via HL7 message standard. Finally some future work will be presented in the field of EHR systems' models comparison and synchronization possibilities of these models.

1. Introduction

Nowadays the EHR is becoming an integral part of patients' health documentation. On the basis of computerized form of health information it is possible to personalize the health care and make better use of medical knowledge and guidelines. However, there are difficulties applying traditional approaches in the field of information system development, the best results in standardization and computer science must be employed.

Since in the praxis it is very difficult to abandon current systems or modify them completely, the openness and modularity of used systems enabling integration of heterogenous medical data originating from different sources becomes crucial. To create such a distributed healthcare environment, where medical information, is commonly shared the use of communication standards is inevitable. One of such standards is e.g. HL7, which has its origin in U.S.A. European standard CEN EN 13606 deals with EHR architecture as well as interoperability via messaging. In the rest of the paper we consider messaging services among EHR systems rather than the methodologies of building of EHR systems. Since the HL7 standard dominates in the field of communication, we aim our interest to it.

In the Czech Republic there are many commercial medical information systems on the market. Most of them do not concern the storage of medical data in a form that

would conform the definition of EHR according to [1]. These systems are mainly used to manage the health services, financing and ensure the functioning of the whole health providing facility. However, storing information about patient's health in computerized form is gradually getting into the center of the interest.

2. Motivation

One could ask why we need a distributed healthcare. As the European Union accepted new members, people started to migrate in a bigger scale than it was in the past, and therefore the importance of interoperable access and integration of the distributed information arose. Another field of application of distributed medical information is the case of an emergency rescue, when every information about patient's health or treatment is of vital importance.

Since there exist more than one communication standard, the first step in simplifying the data exchange process is to use the same standard on both sides of the communication channel. If different medical standards are used, it is necessary to map and transform the messages to each other.

Usually, the greatest problem is to agree on the same standard. This situation prevails because there is no universally accepted standard for the electronic represen-

tation of clinical data. One of many reasons of disagreement is the economical and political background, since governments invested huge resources into research and the development of their national standards.

When two parties reach an agreement and healthcare providers communicate the same standard, it is usually a country dependent standard and thus new problems arise when its exposed to international use. For example in the Czech Republic, there was developed a data standard named DASTA [2]. This standard was designed for laboratory results interchange in the first place. In the course of time the range of structured data broadened but it still does not cover most concepts in medical domain. However, it is under continual development, it is still incompatible with other EHR standards, thus unsuitable for application in international scope.

For example, the project called ARTEMIS [3] dealt with interoperability problems among medical information systems storing clinical information in various proprietary formats.

The definitions of the terms "archetype" and "template" are necessary for proper understanding of the further text. In the paper [4] they are stated as follows:

- *archetype* – a computable expression of a domain content model in the form of structured constraint statements, based on some reference model. openEHR [5] archetypes are based on the openEHR reference model. Archetypes are all expressed in the same formalism. In general, they are defined for wide re-use, however, they can be specialized to include local particularities. They can accommodate any number of natural languages and terminologies.
- *template* – a directly, locally usable definition which composes archetypes into a larger structure logically corresponding to a screen form. A templates may add further local constraints on the archetypes it mentions, including removing or mandating optional sections, and may define default values.

Some examples of archetypes can be found at [6]. In the Figure 1, the structure of archetype representing blood pressure concept is depicted. The part *data* contains values of the actual pressure, i.e. systolic, diastolic, mean arterial pressure, pulse pressure and textual comment on blood pressure reading. *State* is a list of information describing conditions of the measurement, e.g. the position of the patient at the time of measuring blood pressure. *History* covers separate measurements and adds

temporal data in the implicit form, i.e. base measurement in the history, another reading after 5 minutes of rest, 10 minutes etc. Finally, the *protocol* holds technical data such as size of a sphygmomanometer's cuff if it is used or a specification of an instrument used to measure the blood pressure. For the sake of further computerized processing, archetypes are defined in ADL (Archetype Definition Language) [7].

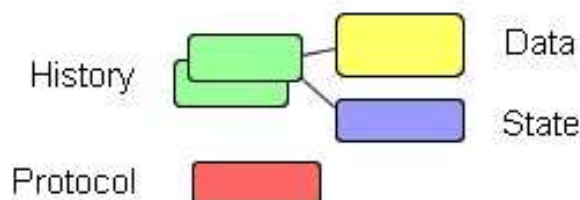

Figure 1: Structure of blood pressure archetype
(id openEHR-EHR-OBSERVATION.blood_pressure.v1)

The solution of the ARTEMIS project contained an idea of wrapping and exposing the existing healthcare applications as Web Services [8]. The semantic interoperability was achieved by using OWL [9] (Web Ontology Language) mappings of archetypes based on reference models of, possibly, different standards (e.g. openEHR, HL7 RIM). These archetypes semantically enrich the Web Services messages. The interoperability was realized through a mediator that transformed the source message using mapping definitions into appropriate form to be accepted by the destination system and its Web Service.

3. Using heterogenous models

Another problem in sharing medical data is the possibility of different definitions of concepts despite using the same modeling methodology (the term modeling methodology comprises all steps necessary to create the resulting model).

Heterogeneity in models occurs when there is a disagreement about the meaning, interpretation or intended use of the same or related data. Usually two separated individuals (experts, developers etc.) model the same domain in more or less different way, even when using the same methodology.

The similarity or heterogeneity of the models can occur on two levels. The first one is *the functional* (implementational) level where information systems use to communicate different network protocols (e.g. IP - Internet Protocol), transport binding (e.g. HTTP, FTP) or message format (e.g. XML, ASCII text). The second le-

vel is *the semantical* where systems have to understand each other's formal definitions of domain concepts. The latter will be the one of our concern.

3.1. MUDR EHR and WinMedicalc 2000 comparison

In the project "Information technologies for development of continuous shared healthcare" (no. 1ET200300413), we deal with the problem of sharing medical information among EHR system developed by various vendors. To fulfil the project's objectives we decided to implement the medical data exchange between two particular EHR systems using HL7 v.3 standard. One of used EHR systems is the MUDR EHR developed at the EuroMISE Center in the Institute of Computer Science of the Academy of Science of the Czech Republic and the second is a commercial application called WinMedicalc 2000 created by Medicalc Software s.r.o.

MUDR EHR uses so called knowledge trees to model stored information [10]. The WinMedicalc 2000 stores its data in a relational database and thus uses Entity-Relationship model [11] to represent its information model. Development of both EHR's started from the same modeling basis. Each originally used the so called minimal data model of cardiology [12].

In MUDR EHR, the modeling process resulted in creating of a knowledge domain called *PATIENT*, consisting of basic administrative data, allergy information, family history, social history, subjective information, physical examination, lab examination, personal history, treatment information and history of cardio-vascular diseases.

The model of WinMedicalc 2000 system consists of basic administrative information, cardiological examinations (e.g. ECG examination, Holter monitor, stress test ECG etc.), lab examination, physical examination and family history. Each of these data (except administrative information) are connected to a clinical event, that binds together the object and subject of the event, i.e. the patient and the physician. Clinical event that contains yet another information such as place where the event took place (e.g. ward, emergency room).

Moreover, WinMedicalc 2000 system covers a broader scope than just clinical data (e.g. catering services, bed management), but these are out of our concern so we leave them out. To illustrate the similarity and difference between MUDR EHR and WinMedicalc 2000 system, the Figure 2 shows the screenshots of client applications.

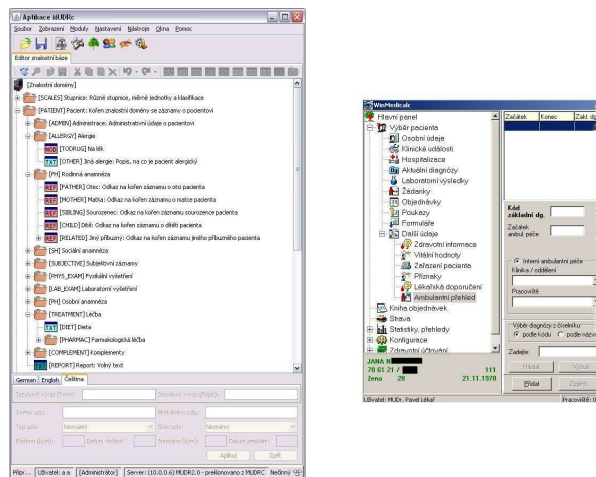

Figure 2: MUDR client, application MUDRc, and WinMedicalc GUI

3.2. Message interchange

The result of solving partial tasks in the project "Information technologies for development of continuous shared healthcare" is a proposal of communication schema between MUDR EHR and WinMedicalc 2000 system using HL7 messaging standard. In these days the communication schema is being implemented and partially tested. The communication between these two health information systems (HIS) can be divided into following steps:

1. **HIS1** retrieves the required data from its repository.
2. Retrieved data are written into the template based on R-MIM that models the content of the message and origins in the information model of the **HIS1**. HL7 template filled with data is sent to the **Translator1**.
3. **Translator1** transforms the template filled with data into HL7 message and sends it back to **HIS1**.
4. The received HL7 message is sent through the network to the receiver.
5. The receiver, the **HIS2**, gets the HL7 message. Since the data is still in the form that **HIS2** does not understand it is posted to the **Translator2**.
6. **HIS2** gets back a template that is derived from R-MIM of **HIS2** and is filled with data that correspond to the structure of desired message.
7. Finally the required data is stored to the repository of **HIS2**.

The algorithm mentioned before is graphically represented in the Figure 3.

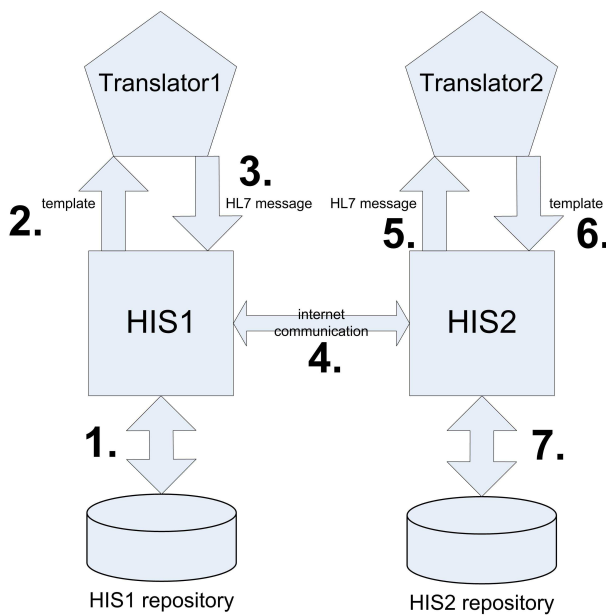

Figure 3: Communication algorithm between MUDR EHR and WinMedicalc 2000

4. Models' comparison on semantical level

Schemagic [13], a synchronizing tool formerly designed to compare and synchronize database schemas stored in relational databases, will be extended by a plug-in capable of processing archetypes. The input of the plug-in are two archetypes described in ADL (Archetype Definition Language) [7]. The extended tool would be helpful in finding differences between two given archetypes describing the same concept but originating from different sources, e.g. two professionals or two EHR systems developed by different vendors.

The rough version of methodology used to establish communication between two EHR systems is described in the following steps:

1. Take models formalizing EHR systems which want to communicate.
2. If chosen models were created using different modeling techniques, transform one model into the same form as the other and go to the next step, else go to next step immediately.
3. Use some comparing tool to find differences between models.
4. To remove differences alter models in appropriate way.

5. Create transforming modules for messages corresponding to both models.
6. The communication can be established.

The first step assumes that both EHR systems do have a formal description in a form of a model. If one or both miss such a model, it is necessary to create one, using the same procedure, i.e. methodology if possible. The step number 2 checks if the same modelling methodology (the same standard or formalism) is used. If not, an extra transformation is needed. This transformation covers modifications on syntactical level. The result of step 2 should be based on the same grounds. Semantical modifications will be discussed later on. The Schemagic extension mentioned above will be helpful in step 3. Alterations mentioned in step 4 will be accomplished manually, since no model manipulating language (such as data definition language – DDL in SQL) in the domain of EHR standards exists.

The next planned extension of the Schemagic would ease the EHR interoperability by simplifying the development of the EHR system modules implementing communication, data exchange, based on some standard such as HL7. This extension is bound in step 5 of the methodology mentioned above. Our pilot implementation will take into account only HL7 version 3 standard. The task of the Schemagic's extension is to map HL7 templates derived from R-MIM model with HL7 message fragments called CMETs (Common Message Element Types). Using this tool will result in much shorter implementation time of translator module (see **Translator1/2** in Figure 3) of EHR system translating specific HL7 template into HL7 message.

5. Pilot application implementation

A pilot application has been developed to test ideas discussed above. Its name is AdamekJ and comes from an abbreviation of ADAMEK (stands for "Aplikace Datoveho Modelu EuroMISE-Kardio" – Application of Data-Model EuroMISE Cardio) [14]. The letter 'J' stands for Java, since AdamekJ is a Java application.

We test communication between WinMedicalc 2000 system and AdamekJ rather than MUDR EHR, because MUDR EHR contains only testing data that are sufficient for determination of HL7 standard usability in the Czech environment. The AdamekJ application will be deployed in the ambulance of preventive cardiology, thus it will contain real "production data" which can more precisely show convergence or divergence of clinical content of communicated messages.

5.1. AdamekJ

Application ADAMEK [14] was developed to collect data in the ambulance of preventive cardiology run under Institute of Computer Science, Academy of Sciences of the Czech Republic. It was created in 2002 and is still in use. Since the application was implemented as a standalone MS Access 2000 program, it reached the limits of the used database. As soon as suitable tools to implement a more advanced version were available, we started the development of the AdamekJ application as the successor of ADAMEK. Both applications, ADAMEK and AdamekJ, are based on the minimal data model of cardiologic patient [12].

During the design process an indispensable emphasis was layed on usage of modern technologies. AdamekJ is a two-layer application consisting of the data layer and the user interface. Application domain objects are persistently stored into relational database Oracle 10g [15]. Objects' persistency is achieved by using the Hibernate framework [16]. The framework is configured by XML mapping files (HBM – Hibernate Mapping). HBM files map objects from application's domain object model to relational tables in the database.

Core classes of the application are implemented using Spring Framework [17]. Spring is a layered Java/J2EE [18] application framework. J2EE (Java 2 platform, Enterprise Edition) is the industry standard for developing portable, robust, scalable and secure server-side Java applications. Building on the solid foundation of the Java Platform, Standard Edition (Java SE), Java EE provides web services, component model, management, and communications APIs that make it the industry standard for implementing enterprise-class service-oriented architecture (SOA) and next-generation web applications. Spring Framework provides automated configuration and wiring of application objects. Spring is well integrated with Hibernate and simplifies the configuration of domain objects' persistent storage.

User interface is implemented using Spring RCP (Rich Client Project). Spring RCP is based on Java Swing, thus the resulting application is a Swing application. The main advantage of the Spring RCP project is providing an elegant way to build highly-configurable, GUI-standards-following rich-client applications faster by leveraging the Spring Framework, and a rich library of UI factories and support classes.

The AdamekJ application is in its testing phase and being prepared for deployment. The screenshot in the Figure 4 shows the detailed view on physical examination of a patient.

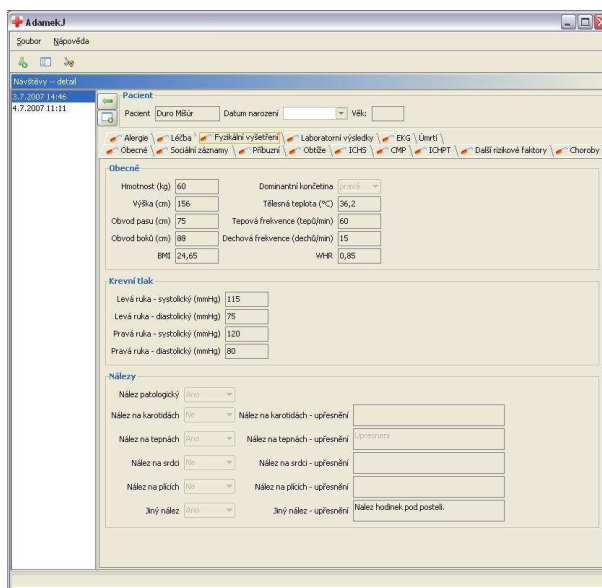

Figure 4: User interface of AdamekJ application

An integral part of each EHR is its communication with other systems in health care environment. Some systems are just limited to import and export data, but AdamekJ stands before the phase of implementation of HL7 messaging standard. When this phase is finished, we will be able to evaluate the communication in the form of HL7 messages between two heterogenous EHRs based on minimal data model of cardiological patient.

6. Conclusion

The first step towards fulfilling the goal of interoperable EHRs is making the implementation of messaging standards easier. We proposed an extension of the system Schemagic that would find appropriate balloted HL7 message fragments corresponding to clinical content of given EHR. This will result in significant reduction of time needed to develop a transforming module, i.e. translator depicted in Figure 3.

Next, the archetype comparison and harmonization will be studied and implemented as further extension of the Schemagic system. However, there still remains the difficulty how to decide whether two archetypes model the same concept or not. This problem will be under further systematic exploration.

References

- [1] P. Schloeffel, "Electronic Health Record Definition, Scope, and Context", *ISO/TC 215 Discussion Paper*, 2002.

- [2] Ministry of Health of the Czech Republic - MZ ČR, "Datový standard MZ ČR v.4" *Ministry of Health of the Czech Republic*, <http://ciselniky.dasta.mzcr.cz>, (last accessed on 8.7.2007).
- [3] ARTEMIS Consortium, "The Artemis Project Home Page", <http://www.srdc.metu.edu.tr/webpage/projects/artemis>, 2004.
- [4] T. Beale, S. Heard, "Archetype Definitions and Principles", *The openEHR foundation*, Rev. 0.6, 2006.
- [5] The openEHR Foundation, "openEHR Home-page", *CHIME at University College London*, <http://www.openehr.org/>, (last accessed on 8.7.2007).
- [6] Ocean Informatics, "Archetype Finder" *Health Informatics, Central Queensland University and Ocean Informatics Pty. Ltd.*, <http://www.archetypes.com.au/archetypefinder/archetypefinder>, (last accessed on 8.7.2007).
- [7] T. Beale, S. Heard, "Archetype Definition Language (ADL)", *The openEHR foundation*, Rev. 1.3.1, 2004.
- [8] V. Bicer, O. Kilic, A. Dogac, G. B. Laleci, "Archetype-Based Semantic Interoperability of Web Service Messages in the Health Care Domain", *Int'l Journal of Semantic Web & Information Systems*, 1(4), pp. 1–22, 2005.
- [9] Ed.: D. L. McGuinness, F. van Harmelen, "OWL Web Ontology Language", *W3C Recommendation*, <http://www.w3.org/TR/owl-features/>, 2004.
- [10] J. Spidlen, "Databázová reprezentace medicínských informací a lékařských doporučení" (In Czech), *Master Thesis at Faculty of Mathematics and Physics, Charles University in Prague*, pp. 32–34, 2002.
- [11] P. Chen, "The Entity-Relationship Model – Toward a Unified View of Data", *ACM Transactions on Database Systems*, Vol. 1, No. 1, pp. 9–36, 1976.
- [12] M. Tomeckova, "Minimální datový model kardiologického pacienta" (In Czech), *Cor et Vasa*, Vol. 44, No. 4, pp. 123, 2002.
- [13] M. Nagy, "Synchronization of Relational Schemas", *Master Thesis at Faculty of Mathematics and Physics, Charles University in Prague*, 2005.
- [14] R. Mares, M. Tomeckova, J. Peleska, P. Hanzlicek, J. Zvarova, "Uživatelská rozhraní patientských databázových systémů – ukázka aplikace pro sběr dat v rámci minimálního datového modelu kardiologického pacienta" (In Czech), *Cor et Vasa*, Vol.44, No. 4, pp. 76, 2002.
- [15] K. Loney, B. Bryla, "Mistrovství v Oracle Database 10g" (In Czech), *Computer Press*, 2006.
- [16] Ch. Bauer, G. King, "Hibernate in Action", *Manning*, 2004.
- [17] C. Walls, R. Breidenbach, "Spring in Action", *Manning*, 2005.
- [18] Sun Corporation, "Java EE at a Glance", *Sun Corp.*, <http://java.sun.com/javaee/>, (last accessed on 8.7.2007).

Various Kinds of Preferences in Database Queries

Post-Graduate Student:

RADIM NEDBAL

Institute of Computer Science of the ASCR, v. v. i.
Pod Vodárenskou věží 2
182 07 Prague 8, CZ,

Department of Mathematics
Faculty of Nuclear Science and Physical Engineering
Czech Technical University
Trojanova 13

120 00 Prague 2, CZ

radned@seznam.cz

Supervisor:

ING. JÚLIUS ŠTULLER, CSC.

Institute of Computer Science of the ASCR, v. v. i.
Pod Vodárenskou věží 2
182 07 Prague 8, CZ

stuller@cs.cas.cz

Field of Study:
Mathematical Engineering

This work was supported by the project 1ET100300419 of the Program Information Society (of the Thematic Program II of the National Research Program of the Czech Republic) “Intelligent Models, Algorithms, Methods and Tools for the Semantic Web Realization”, and by the Institutional Research Plan AV0Z10300504 “Computer Science for the Information Society: Models, Algorithms, Applications”.

Abstract

The paper resumes recent advances in the field of logic of preference and presents their application in the field of database queries. Namely, non-monotonic reasoning mechanisms including various kinds of preferences are reviewed, and a way of suiting them to practical database applications is shown: reasoning including sixteen strict and non-strict kinds of preferences, inclusive of *ceteris paribus* preferences, is feasible. However, to make the mechanisms useful for practical applications, the assumption of preference specification consistency has to be relinquished. This is achieved in two steps: firstly, all kinds of preferences are defined so that some uncertainty is inherent, and secondly, not a notion of a total pre-order but a partial pre-order is used in the semantics, which enables to indicate some kind of conflict among preferences. Most importantly, the semantics of a set of preferences is related to that of a disjunctive logic program.

1. Introduction

All too often no reasonable answer is returned by an SQL-based search engine though one has tried hard writing query to match one’s personal preferences closely. The case of repeatedly receiving *empty query result* is extremely disappointing to the user. On the other hand, leaving out some conditions in the query often leads to another unpleasant extreme: an *overloading* with lots of mostly *irrelevant information*. This observation stems from the fact that traditional database query languages treat all the requirements on the data as mandatory, hard ones. However, it is natural to express queries in terms of both hard as well as soft requirements, i.e., preferences, in many applications.

In the “real world”, preferences are understood in the sense of wishes: in case they are not satisfied, database users are usually prepared to accept worse alternatives. Thus preferences require a paradigm shift from exact matches towards a best possible matchmaking.

The paper presents a work in progress aiming at **simultaneous usage of various kinds of preferences in database queries**. The semantics of preferences is defined according to recent advances in the field of preference logic. Consequently, the preferences under consideration, in general, are set preferences. The objective is to provide database users with a language that is declarative, can be used to define such database queries that not necessarily all answers but rather the best, the most preferred ones are returned, includes various kinds of preferences, and has an intuitive, well defined semantics allowing for conflicting preferences.

In section 2, the basic notions of logic of preference and non-monotonic reasoning are briefly summarized. In section 3, basic concepts and key features of the proposed approach are introduced: preference operator is defined and its basic properties presented, inclusive of algebraic properties important for algebraic optimization of database queries. Section 4 gives a short overview of related work and the 5th section concludes the paper.

2. Preliminaries

The logic of preference has been studied since the sixties as a branch of philosophical logic: Logicians and philosophers have been attempting to define the one well-formed logic that people should follow when expressing preferences.

2.1. Logic of preference

It is Von Wright's essay [1] that tries to give the first axiomatization of a logic of preference. The general idea is that the expression “ a is preferred to b ” should be understood as the preference of a state (a world) where a occurs over a state where b occurs. Von Wright expressed a theory based on five axioms. The problem is that empirical observation of human behavior provides counterexamples of this axiomatization.

Later, Von Wright [2] introduced a more general frame to define preferences, updating also the notion of *ceteris paribus* preferences. Ceteris paribus principle is meant to yield a notion of unconditional preferences, in the sense that a change in the world might influence the preference order between two states of affairs, but if all the conditions stay constant in the world, then so does the preference order.

In this approach, he considers a set S of n logically independent states of affairs and the set $W = 2^S$ of 2^n combinations of the elements of S . An s -world is called any element of W that holds when s holds. In the same way is defined a C_i -world, where C_i is a combination of elements of S . Now, von Wright gives two definitions (strong and weak) of “ s is preferred to t under the circumstances C_i ”:

1. (strong): s is preferred to t under the circumstances C_i iff every C_i -world that is also an s -world and not a t -world is preferred to every C_i -world that is also a t -world and not an s -world.
2. (weak): s is preferred to t under the circumstances C_i iff some C_i -world that is also an s -world is preferred to some C_i -world that is also a t -world, and no C_i -world which is a t -world is preferred to any C_i -world which is an s -world.

Finally, if s is preferred to t under all circumstances C_i , according to either definition, then s is said to be preferred to t ceteris paribus.

It can be concluded that the philosophical discussion about preferences failed the objective to give a unify-

ing frame of generalized preference relations that could hold for any kind of states, based on well-defined axiomatization.

More recently, Von Wright's ideas and the discussion about “logical representation of preferences” attracted attention again. For instance Doyle and Wellman [3] give a modern treatment of preferences ceteris paribus. On the other hand, Boutilier [4] pioneers a new way of looking at preference logic by augmenting a basic modal language. His work is the base of the recent work of van Benthem, Otterloo and Roy [5], who reduce preference logic to a basic (multi)modal language augmented with the so-called *existential modality*. Their semantics does not include ceteris paribus property of preferences.¹

2.2. Logic of preferences

A drawback of the present state of the art in the logic of preference is that proposed logics typically formalize only preference of one kind. Consequently, when formalizing preferences, one has to choose which kind of preference statements are used for all preferences under consideration.

To study the interaction among kinds of preferences, a non-monotonic preference logic for various kinds of preferences, *logic of preferences* – in contrast to the usual reference to the *logic of preference*, has been recently developed by Kaci and Torre [7, 8]. They have developed algorithms for a non-monotonic preference logic for sixteen kinds of preferences: four basic types, each of them strict or non-strict, with or without ceteris paribus proviso.

To describe ceteris paribus preference, a general construction proposed by Doyle and Wellman [3] is employed. Their language for preference built over a set of propositions is defined inductively from propositional variables. They mean by *proposition* a set of individual objects, elements of a set W . These individual objects can be understood as worlds, i.e., truth assignments for propositional variables. In other words, a propositional formula is identified with worlds – fulfilling truth assignments, and the powerset 2^W is taken to be the set of all propositional formulas.

Their ceteris paribus preferences are based on a notion of contextual equivalence:

Definition 1 (Contextual equivalence)[3, Def.4] Let W be a set of worlds and $\xi(W)$ be the set of equivalence relations on W . A contextual equivalence on W is a function $\eta : 2^{2^W} \rightarrow \xi(W)$ assigning to each set of

¹For more detailed survey of the origin of preference logic in the work of von Wright refer to [6].

propositional formulas $\{\varphi, \psi, \dots\}$ equivalence relation $\eta(\varphi, \psi, \dots)$.

If $w \eta(\varphi, \psi, \dots) w'$, we usually write

$$w \equiv w' \quad \text{mod } \eta(\varphi, \psi, \dots) .$$

Definition 2 (Preference model) A preference model $\mathcal{M} = \langle W, \succeq, \eta \rangle$ is a triplet in which W is a set of worlds, \succeq is a total pre-order, i.e., a relation which is complete, reflexive, and transitive, over W , and η is a contextual equivalence function on W .

Definition 3 (Comparative greatness)[3, Def.5] We say that “ φ is weakly greater than ψ ,” written $\varphi \succeq \psi$, is satisfied in the model \mathcal{M} , written $\mathcal{M} \models \varphi \succeq \psi$, iff $w_1 \succeq w_2$ whenever

1. $w_1 \models \varphi \wedge \neg\psi$,
2. $w_2 \models \neg\varphi \wedge \psi$, and
3. $w_1 \equiv w_2 \quad \text{mod } \eta(\varphi \wedge \neg\psi, \neg\varphi \wedge \psi)$.

This definition of ceteris paribus preferences seems very close to the intended semantics behind von Wright’s principles. Preferences of φ over ψ are defined as preferences of $\varphi \wedge \neg\psi$ over $\neg\varphi \wedge \psi$, which is standard and known as von Wright’s expansion principle [1]. Also, note that if the equivalence relation $\eta(\varphi \wedge \neg\psi, \neg\varphi \wedge \psi)$ is the universal relation, i.e., an equivalence relation with only one equivalence class, then the ceteris paribus preference reduces to strong condition (φ is preferred to ψ when each $\varphi \wedge \neg\psi$ is preferred to all $\neg\varphi \wedge \psi$).

The following proposition [8] shows that Def.3 reduces a preference with ceteris paribus proviso to a set of preferences for each equivalence class of the equivalence relation.

Proposition 1 [8, Prop.2] *Assume a finite set of propositional variables, and let $\epsilon(\eta, \varphi, \psi)$ be the set of propositional formulas which are true in all worlds of an equivalence class of $\eta(\varphi, \psi)$, but false in all others: $\{\chi \mid \exists w \forall w' : w \equiv w' \quad \text{mod } \eta(\varphi, \psi) \iff w' \models \chi\}$. We have that “ φ is weakly greater than ψ ” is satisfied in the model $\mathcal{M} = \langle W, \succeq, \eta \rangle$ iff for all propositions $c \in \epsilon(\eta, \varphi \wedge \neg\psi, \neg\varphi \wedge \psi)$, we have that $w_1 \succeq w_2$ whenever*

1. $w_1 \models \varphi \wedge \neg\psi \wedge c$,
2. $w_2 \models \neg\varphi \wedge \psi \wedge c$.

The logical language introduced in by Kaci and Torre [8] extends propositional logic with sixteen kinds of preferences:

Definition 4 (Language) [8, Def.3] Given a finite set of propositional variables p, q, \dots , the set L_0 of propositional formulas and the set L of preference formulas is defined as follows:

$$\begin{aligned} L_0 \ni \varphi, \psi: & p \mid (\varphi \wedge \psi) \mid \neg\varphi \\ L \ni \Phi, \Psi: & \varphi \succ^x \psi \mid \varphi \succeq^x \psi \mid \varphi \succ_c^x \psi \mid \varphi \succeq_c^x \psi \mid \\ & \neg\Phi \mid (\Phi \wedge \Psi) \quad \text{for } x, y \in \{m, M\} \end{aligned}$$

Definition 5 (Monotonic semantics)[8, Def.4] Let \mathcal{M} be a preference model. When $x = M$ we write $x(\varphi, \mathcal{M})$ for

$$\begin{aligned} \max(\varphi, \mathcal{M}) = \\ \{w \in W \mid w \models \varphi \wedge (\forall w' \in W : w' \models \varphi \Rightarrow w \succeq w')\} , \end{aligned}$$

and analogously when $x = m$ we write $x(\varphi, \mathcal{M})$ for

$$\begin{aligned} \min(\varphi, \mathcal{M}) = \\ \{w \in W \mid w \models \varphi \wedge (\forall w' \in W : w' \models \varphi \Rightarrow w' \succeq w)\} . \end{aligned}$$

$$\begin{aligned} \mathcal{M} \models \varphi \succ^x \psi \text{ iff } & \forall w \in x(\varphi \wedge \neg\psi, \mathcal{M}), \\ & \forall w' \in y(\neg\varphi \wedge \psi, \mathcal{M}) : w \succ w' \\ \mathcal{M} \models \varphi \succeq^x \psi \text{ iff } & \forall w \in x(\varphi \wedge \neg\psi, \mathcal{M}), \\ & \forall w' \in y(\neg\varphi \wedge \psi, \mathcal{M}) : w \succeq w' \\ \mathcal{M} \models \varphi \succ_c^x \psi \text{ iff } & \forall c \in \epsilon(\eta, \varphi \wedge \neg\psi, \neg\varphi \wedge \psi), \\ & \forall w \in x(\varphi \wedge \neg\psi \wedge c, \mathcal{M}), \\ & \forall w' \in y(\neg\varphi \wedge \psi \wedge c, \mathcal{M}) : w \succ w' \\ \mathcal{M} \models \varphi \succeq_c^x \psi \text{ iff } & \forall c \in \epsilon(\eta, \varphi \wedge \neg\psi, \neg\varphi \wedge \psi), \\ & \forall w \in x(\varphi \wedge \neg\psi \wedge c, \mathcal{M}), \\ & \forall w' \in y(\neg\varphi \wedge \psi \wedge c, \mathcal{M}) : w \succeq w' \end{aligned}$$

Moreover, logical notions are defined as usual, in particular:

$$S \models \Phi \iff \forall \mathcal{M} : \mathcal{M} \models S \Rightarrow \mathcal{M} \models \Phi .$$

Note that $\varphi \stackrel{m}{\succeq}_c^M \psi$ is the Doyle and Wellmans’s comparative greatness (Def.3).

In this paper, we are interested in a special kind of theories, namely preference specifications:

Definition 6 (Preference specification) [8, Def.5] Let $\mathcal{P}_{\triangleright}$ be a set of preferences of the form $\{\varphi_i \triangleright \psi_i : i = 1, \dots, n\}$. A preference specification \mathcal{P} is a tuple:

$$\langle \mathcal{P}_{\triangleright} \mid \triangleright \in \{ \succ^x, \succeq^x, \succ_c^x, \succeq_c^x \mid x, y \in \{m, M\} \} \rangle ,$$

and \mathcal{M} is its model iff it models all $\mathcal{P}_\triangleright$:

$$\mathcal{M} \models \mathcal{P}_\triangleright \iff \forall (\varphi_i \triangleright \psi_i) \in \mathcal{P}_\triangleright : \mathcal{M} \models \varphi_i \triangleright \psi_i .$$

Corollary 1 *Observe that by Prop.1, we can replace ceteris paribus preferences, written $x \succ_c^y$ or $x \succeq_c^y$, by sets of ordinary preferences without a ceteris paribus proviso. Consequently, we can restrict ourselves to the eight types of preferences without ceteris paribus clauses.*

2.3. Non-monotonic logic of preferences

Non-monotonic reasoning has been characterized by Shoham [9] as a mechanism that selects a subset of the models of a set of formulas, which we call distinguished models. Thus non-monotonic consequences of a logical theory are defined as all formulas which are true in the distinguished models of the theory.

An attractive property occurs when there is only one distinguished model, as then all non-monotonic consequences can be found by calculating the unique distinguished model and characterizing all formulas satisfied by this model. It has been proved in the literature that a unique distinguished model can be defined for the following sets of preferences: $\mathcal{P}_{m>M}$, $\mathcal{P}_{m>_c^y}$, and $\mathcal{P}_{M>M}$.

Moreover, Kaci and Torre [8] have defined a distinguished model and proved its uniqueness for

$$\langle \mathcal{P}_\triangleright | \triangleright \in \{x > y, x \succeq^y, x >_c^y, x \succeq_c^y \mid x \in \{m, M\}, y = M\} \rangle$$

and also for

$$\langle \mathcal{P}_\triangleright | \triangleright \in \{x > y, x \succeq^y, x >_c^y, x \succeq_c^y \mid x = m, y \in \{m, M\}\} \rangle$$

They have also provided algorithms to calculate these two unique models and presented a way to combine these models to find a distinguished model of all the types of preferences given together. Their algorithms also capture all the algorithms for handling all the kinds of preferences separately.

It should be pointed out, that the consistency of preference specification, i.e., no conflict among preferences, has been assumed by now. This assumption, however, is hard to fulfil in practical applications. In order not to restrict the use of the logic of preference, Boella and Torre [10] have proposed a minimal logic of preference in which *any* preference specification is consistent. They have achieved the consistency by means of:

- formalizing a preference φ over ψ as the **absence** of a ψ world that is preferred over a φ world;
- amending the preference model definition by using **partial pre-order** instead of total pre-order

on worlds, which enables to indicate some kind of conflict among worlds (by their incomparability).

Their non-monotonic reasoning is based on distinguished models called *most connected models*.

Definition 7 Most connected model [10, Def.4] A model $\mathcal{M} = \langle W, \succeq, \eta \rangle$ is at least as connected as another model $\mathcal{M}' = \langle W, \succeq', \eta \rangle$, written as $\mathcal{M} \sqsubseteq \mathcal{M}'$, if $\succeq' \subseteq \succeq$, i.e.,

$$\forall w_1, w_2 \in W : w_1 \succeq' w_2 \Rightarrow w_1 \succeq w_2 .$$

A model \mathcal{M} is most connected if there is no other model \mathcal{M}' s.t. $\mathcal{M}' \sqsubset \mathcal{M}$, i.e., s.t. $\mathcal{M}' \sqsubseteq \mathcal{M}$ without $\mathcal{M} \sqsubseteq \mathcal{M}'$.

In comparison with Kaci and Torre's language [8], their language is by far less expressive, having only one kind of preference.

3. Preferences in database queries

To improve the readability, $x \succeq y \wedge \neg(y \succeq x)$, $\succeq(x, y) \wedge \neg \succeq(y, x)$, and $\succeq(x, y) \wedge \succeq(y, x)$ is substituted by $x \succ y$, $\succ(x, y)$, and $=(x, y)$, resp., henceforth.

3.1. Basic concepts and key features

To reach the target, we need to accommodate an expressive language with various kinds of preferences in the RDM framework. We propose to base its model-theoretic semantics on those of preference logic languages.

In the following list of basic concepts, the key features are boldfaced.

- User preferences are expressed in a **preference logic language**.
- Semantics of a set of (possibly conflicting) preferences is related to that of a **disjunctive logic program** (DLP).
- **Non-monotonic reasoning mechanisms** about preferences has to be employed to reason about preferences that are defined in such a way that consistency is ensured under all circumstances.
- A preference operator returning only the best tuples in the sense of user preferences is used to embed preferences into relational query languages.

We identify propositional variables with tuples, i.e., facts over relations. A subset of a relation instance, i.e., a set of facts, creates a world, an element of a set W , and propositions are logically implied by worlds in which they hold true.

3.2. User preferences

Our starting point is the language (Def.4) introduced by Kaci and Tore [8] who extend propositional language with sixteen kinds of preferences. The aim is to accommodate this expressive language in the RDM framework so that any set of (possibly conflicting) preferences has a well defined semantics.

To define the semantics without the consistency assumption, the definition (Def.2) of the preference model has to be extended. For this reason, Boella and Torre [10] have replaced the total pre-order with *partial pre-order*, i.e., a binary relation which is reflexive and transitive, on worlds in the preference model definition. Indeed, it shows that their definition provides a sufficient space of models.

Definition 8 (Preference model) A preference model $\mathcal{M} = \langle W, \succeq \rangle$ over a relation schema R is a couple in which W is a set of worlds, relation instances of R , and \succeq is a *partial pre-order* over W , the *preference relation*.

Observe that as preferences with *ceteris paribus* provisos can be reduced in accordance with Cor.1 to sets of preferences without such provisos, we have neglected the contextual equivalence in the definition of the preference model.

Definition 9 (Models of preferences) Let \mathcal{M} be a preference model and w, w' elements of W s.t. $w \models \neg\varphi \wedge \psi$ and $w' \models \varphi \wedge \neg\psi$. Then:

$\mathcal{M} \models \varphi^{M>M} \psi$ iff $\exists w' \text{ s.t. } \forall w : \text{if } \varphi \wedge \neg\psi \not\models_W \text{ false, we have } \neg(w \succeq w')$.

$\mathcal{M} \models \varphi^{M \geq M} \psi$ iff $\exists w' \text{ s.t. } \forall w : \text{if } \varphi \wedge \neg\psi \not\models_W \text{ false, we have } \neg(w \succ w')$.

$\mathcal{M} \models \varphi^{m>M} \psi$ iff $\forall w \forall w', \text{ we have } \neg(w \succeq w')$.

$\mathcal{M} \models \varphi^{m \geq M} \psi$ iff $\forall w \forall w', \text{ we have } \neg(w \succ w')$.

$\mathcal{M} \models \varphi^{M>m} \psi$ iff $\exists w \exists w' : \text{if } \neg\varphi \wedge \psi \not\models_W \text{ false and } \varphi \wedge \neg\psi \not\models_W \text{ false, we have } \neg(w \succeq w')$.

$\mathcal{M} \models \varphi^{M \geq m} \psi$ iff $\exists w \exists w' : \text{if } \neg\varphi \wedge \psi \not\models_W \text{ false and } \varphi \wedge \neg\psi \not\models_W \text{ false, we have } \neg(w \succ w')$.

² $\varphi \wedge \neg\psi \not\models_W \text{ false}$ denotes that there is a model in W for $\varphi \wedge \neg\psi$.

³Elements of E_i and E_j fulfill $\varphi \wedge \neg\psi$ and $\neg\varphi \wedge \psi$, resp. in the following list

$\mathcal{M} \models \varphi^{m>m} \psi$ iff $\exists w \forall w' : \text{if } \neg\varphi \wedge \psi \not\models_W \text{ false, we have } \neg(w \succeq w')$.

$\mathcal{M} \models \varphi^{m \geq m} \psi$ iff $\exists w \forall w' : \text{if } \neg\varphi \wedge \psi \not\models_W \text{ false, we have } \neg(w \succ w')$.

3.3. Preference specification semantics

Definition 10 (Preference specification) Let R be a relation schema. Given the set $L_0(R)$ from the definition (Def.4) of the language in which propositional variables are identified with facts over the relation R , $\mathcal{P}_\triangleright(R)$ is a set of preferences over the relation schema R of the form $\{\varphi_i \triangleright \psi_i : i = 1, \dots, n\}$ for $\varphi_i, \psi_i \in L_0(R)$. A preference specification \mathcal{P} over the relation schema R is a tuple $\langle \mathcal{P}_\triangleright(R) | \triangleright \in \{x>y, x \geq y \mid x, y \in \{m, M\}\} \rangle$, and $\mathcal{M}(\mathcal{P})$ is its model, i.e., a *preference specification model*, iff it models all $\mathcal{P}_\triangleright(R)$:

$$\mathcal{M}(\mathcal{P}) \models \mathcal{P}_\triangleright(R) \iff \forall (\varphi_i \triangleright \psi_i) \in \mathcal{P}_\triangleright(R) : \mathcal{M}(\mathcal{P}) \models \varphi_i \triangleright \psi_i .$$

To calculate a preference specification model, we associate the preference specification \mathcal{P} with a DLP, then employ optimal model semantics of the DLP and finally compute the model by means of iteration of the *immediate consequence operator* for a positive logic program.

3.3.1 Disjunctive logic program: First, we associate the preference specification \mathcal{P} with a DLP in three steps:

First step: Create a partition $E_W = (E_1, \dots, E_n)$ of W so that $w, w' \in E_i$ iff any of the following conditions is fulfilled for every preference $\varphi \triangleright \psi$:

1. $w \models \varphi \wedge \neg\psi$ and $w' \models \varphi \wedge \neg\psi$,
2. $w \models \neg\varphi \wedge \psi$ and $w' \models \neg\varphi \wedge \psi$,
3. $w \models (\varphi \wedge \psi) \vee (\neg\varphi \wedge \neg\psi)$ and $w' \models (\varphi \wedge \psi) \vee (\neg\varphi \wedge \neg\psi)$.

Second step: Substitute each preference type by a logical formula³:

$\varphi^{M>M} \psi$: if $\varphi \wedge \neg\psi \not\models_W \text{ false, we have: } \exists E_i \text{ s.t. } \forall E_j : \not\models (E_j, E_i)$.

$\varphi^{M \geq M} \psi$: if $\varphi \wedge \neg\psi \not\models_W \text{ false, we have: } \exists E_i \text{ s.t. } \forall E_j : \not\models (E_j, E_i)$.

$\varphi^{m>M} \psi$: $\forall E_j \forall E_i : \not\models (E_j, E_i)$.

$$\varphi^{m \geq M} \psi: \quad \forall E_j \forall E_i : \not\prec (E_j, E_i).$$

$$\varphi^{M > m} \psi: \text{ if } \varphi \wedge \neg \psi \not\equiv_W \text{false, we have:}$$

$$\exists E_j \exists E_i : \not\prec (E_j, E_i).$$

$$\varphi^{M \geq m} \psi: \text{ if } \varphi \wedge \neg \psi \not\equiv_W \text{false, we have:}$$

$$\exists E_j \exists E_i : \not\prec (E_j, E_i).$$

$$\varphi^{m > m} \psi: \quad \exists E_j \forall E_i : \not\prec (E_j, E_i).$$

$$\varphi^{m \geq m} \psi: \quad \exists E_j \forall E_i : \not\prec (E_j, E_i).$$

The above formulae can be expressed as disjunctions.

Third step: Furthermore, formulae expressing properties of the above predicates and their relations have to be added:

$$\not\prec (A, B) \vee \succ (A, B) \leftarrow \not\prec (B, A).$$

$$\not\prec (B, A) \vee [\succ (A, B) \wedge \succ (B, A)] \leftarrow \not\prec (B, A).$$

$$\succ (A, C) \leftarrow \succ (A, B) \wedge \succ (B, C).$$

$$\parallel (A, B) \leftarrow \not\prec (A, B) \wedge \not\prec (B, A).$$

$$\succ (A, B) \leftarrow \neg \not\prec (A, B).$$

$$\text{false} \leftarrow \not\prec (A, B) \wedge \succ (A, B).$$

$$\succ (A, A) \leftarrow .$$

3.3.2 Optimal model semantics: To define the meaning of the DLP, we employ *optimal model semantics* [11].

Definition 11 (Atomic weight assignment) [11, Def.2] An atomic weight assignment, \wp , for a program P , is a map from the Herbrand Base B_P of P to \mathbb{R}_0^+ , where \mathbb{R}_0^+ denotes the set of nonnegative real numbers (including zero).

Definition 12 (Aggregation strategy) [11, Def.3] An aggregation strategy \mathcal{A} is a map from⁴ $M^{\mathbb{R}_0^+}$ to \mathbb{R} .

Definition 13 (Herbrand Objective function)[11, Def.4] The Herbrand Objective Function, $\text{HOF}(\wp, \mathcal{A})$ is a map from 2^{B_P} to \mathbb{R}_0^+ defined as follows:

$$\text{HOF}(\wp, \mathcal{A})(M) = \mathcal{A}(\{\wp(A) \mid A \in M\}) .$$

Definition 14 (Optimal model)[11, Def.5] Let P be a logic program, \wp an atomic weight assignment, and \mathcal{A} an aggregation strategy. Suppose that \mathcal{F} is a family of models of P . We say that M is an optimal \mathcal{F} -model of P with regard to (\wp, \mathcal{A}) if:

⁴Given a set X , M^X denotes the set of all multisets whose elements are in X .

1. $M \in \mathcal{F}$;
2. $\nexists M' : M' \in \mathcal{F} \wedge \text{HOF}(\wp, \mathcal{A})(M') < \text{HOF}(\wp, \mathcal{A})(M)$.

We use the notation $\text{Opt}(P, \mathcal{F}, \wp, \mathcal{A})$ to denote the set of all optimal \mathcal{F} -models of P with regard to (\wp, \mathcal{A}) .

Applying a variant of the connectivity principle (c.f. Def.7), distinguished models, defining the meaning of the program P , can be selected from stable models $\text{ST}(P)$ of P so that the intensional relation \parallel of incomparable elements is minimal in the sense of set inclusion. Accordingly, we get the intended optimal model semantics of our program when we extend the notions of aggregation strategy and Herbrand objective function so that the relation of set inclusion can be captured.

It is important to point out that

$$\text{Opt}(P, \text{ST}(P), \wp_0, \mathcal{A}_0) ,$$

in general, contains more than one optimal model.

For every intensional relation \succ_k that is subsumed in an optimal model $M_P \in \text{Opt}(P, \text{ST}(P), \wp_0, \mathcal{A}_0)$, we define the preference relation as follows:

$$\forall w, w' \in W \text{ with } w \in E_i, w' \in E_j :$$

$$w \succeq_k w' \iff E_i \succ_k E_j$$

and get a preference specification model $\mathcal{M}_k(\mathcal{P}) = \langle W, \succeq_k \rangle$.

3.3.3 Computing the model: Ordering the partition of W according to the intensional relation \succ_k that is subsumed in an optimal model $M_P \in \text{Opt}(P, \text{ST}(P), \wp_0, \mathcal{A}_0)$, the most preferred worlds ultimately are located in maximal elements of the partition. To find the maximal elements, the ordered partition is associated with a positive datalog program consisting of one rule:

$$M(A) \leftarrow M(B) \wedge \succ_k (A, B).$$

and facts: $\succ_k (E_i, E_j) \in M_P$.

Observe that M_P is the least, trivial model of the above program. Nevertheless, least nontrivial models of the above program yield the interpretations of the predicate M identifying the maximal elements and thus also the most preferred worlds according to the model $\mathcal{M}_k(\mathcal{P}) = \langle W, \succeq_k \rangle$.

3.4. Preference operator

To embed preferences into relational query languages, a *preference operator* $\omega_{\mathcal{P}}$ returning only the best tuples in the sense of user preferences \mathcal{P} is defined.

Definition 15 (Preference operator) If R is a relation schema, \mathcal{P} a preference specification over R , and $\mathcal{M}(\mathcal{P})$ the set of its models; then the preference operator $\omega_{\mathcal{P}}$ is defined for all instances $I(R)$ of R as follows:

$$\begin{aligned} \omega_{\mathcal{P}}(I(R)) &= \{w \in W \mid \\ &w \subseteq I(R) \wedge \exists \mathcal{M}_k(\mathcal{P}) \in \mathcal{M}(\mathcal{P}) \text{ s.t. } \forall w' \in W : \\ &w' \subseteq I(R) \wedge \succeq_k(w', w) \Rightarrow \succeq_k(w, w')\} . \end{aligned}$$

3.4.1 Basic properties:

Proposition 2 Given a relation schema R , a preference specification \mathcal{P} over R , for all instances $I(R)$ of R the following properties hold:

$$\begin{aligned} \omega_{\mathcal{P}}(I(R)) &\subseteq 2^{I(R)} , \\ \omega_{\mathcal{P}}(\omega_{\mathcal{P}}(I(R))) &= \omega_{\mathcal{P}}(I(R)) , \\ \omega_{\mathcal{P}_{\text{empty}}}(I(R)) &= 2^{I(R)} , \end{aligned}$$

where $\mathcal{P}_{\text{empty}}$ is the empty preference specification, i.e., containing no preference.

Theorem 1 (Non-emptiness) Given a relation schema R , a preference specification \mathcal{P} over R , then for every finite, nonempty instance $I(R)$ of R , $\omega_{\mathcal{P}}(I(R))$ is non-empty.

3.4.2 Multidimensional composition: The most common ways of defining a preference on the Cartesian product of two relations are Pareto and lexicographic composition.

Definition 16 (Pareto composition) Given two relation schemas R_1 and R_2 , preference specifications \mathcal{P}_1 over R_1 and \mathcal{P}_2 over R_2 , and its sets of models $\mathcal{M}(\mathcal{P}_1)$ and $\mathcal{M}(\mathcal{P}_2)$, respectively, the *Pareto composition* $P(\mathcal{P}_1, \mathcal{P}_2)$ of \mathcal{P}_1 and \mathcal{P}_2 is a preference specification \mathcal{P}_0 over the Cartesian product $R_1 \times R_2$, whose preference relation \succeq_m is defined as:

$$\begin{aligned} \forall w_1, w'_1 \in W_1, \forall w_2, w'_2 \in W_2, \\ \exists \mathcal{M}_k(\mathcal{P}_1) \in \mathcal{M}(\mathcal{P}_1), \exists \mathcal{M}_l(\mathcal{P}_2) \in \mathcal{M}(\mathcal{P}_2) : \\ \succeq_m(w_1 \times w_2, w'_1 \times w'_2) \equiv \succeq_k(w_1, w'_1) \wedge \succeq_l(w_2, w'_2) , \end{aligned}$$

where $\mathcal{M}_k(\mathcal{P}_1) = \langle W_1, \succeq_k \rangle$ and $\mathcal{M}_l(\mathcal{P}_2) = \langle W_2, \succeq_l \rangle$.

Definition 17 (Lexicographic composition) Given two relation schemas R_1 and R_2 , preference specifications \mathcal{P}_1 over R_1 and \mathcal{P}_2 over R_2 , and its sets of models $\mathcal{M}(\mathcal{P}_1)$ and $\mathcal{M}(\mathcal{P}_2)$, respectively, the *lexicographic composition* $L(\mathcal{P}_1, \mathcal{P}_2)$ of \mathcal{P}_1 and \mathcal{P}_2 is a preference specification \mathcal{P}_0 over the Cartesian product $R_1 \times R_2$, whose preference relation \succeq_m is defined as:

$$\begin{aligned} \forall w_1, w'_1 \in W_1, \forall w_2, w'_2 \in W_2, \\ \exists \mathcal{M}_k(\mathcal{P}_1) \in \mathcal{M}(\mathcal{P}_1), \exists \mathcal{M}_l(\mathcal{P}_2) \in \mathcal{M}(\mathcal{P}_2) : \\ \succeq_m(w_1 \times w_2, w'_1 \times w'_2) \equiv \\ \succ_k(w_1, w'_1) \vee (=_k(w_1, w'_1) \wedge \succeq_l(w_2, w'_2)) , \end{aligned}$$

where $\mathcal{M}_k(\mathcal{P}_1) = \langle W_1, \succeq_k \rangle$ and $\mathcal{M}_l(\mathcal{P}_2) = \langle W_2, \succeq_l \rangle$.

3.4.3 Algebraic properties: The set of algebraic laws that govern the commutativity and distributivity of winnow with respect to relational algebra operations constitutes a formal foundation for rewriting preference queries using the standard strategies like *pushing selection down*.

The following theorem identifies a sufficient condition under which the preference operator and relational algebra selection commute.

Theorem 2 (Commuting with selection) Given a relation schema R , a preference specification \mathcal{P} over R , the set of its preference models $\mathcal{M}(\mathcal{P})$, and a selection condition φ over R , if the formula

$$\begin{aligned} \forall \mathcal{M}_k(\mathcal{P}) \in \mathcal{M}(\mathcal{P}), \forall w, w' \in W : \\ \succ_k(w', w) \wedge w = \sigma_{\varphi}(w) \Rightarrow w' = \sigma_{\varphi}(w') \end{aligned}$$

is valid, then for all instances $I(R)$:

$$\sigma_{\varphi}(\omega_{\mathcal{P}}(I(R))) = \omega_{\mathcal{P}}(\sigma_{\varphi}(I(R))) .$$

The following theorem identifies a sufficient condition under which the preference operator and relational algebra projection commute.

Definition 18 (Restriction of a preference relation) Given a relation schema R , a set of attributes X of R , and a preference relation \succeq over R , the restriction $\theta_X(\succeq)$ of \succeq to X is a preference relation \succeq_X over $\pi_X(R)$ defined using the following formula:

$$\begin{aligned} \succeq_X(w_X, w'_X) \equiv \forall w, w' \in W : \\ \pi_X(w) = w_X \wedge \pi_X(w') = w'_X \Rightarrow \succeq(w, w') . \end{aligned}$$

Definition 19 (Restriction of a preference model) Given a relation schema R , a set of attributes X of R , and

a preference model (Def.8) $\mathcal{M} = \langle W, \succeq \rangle$ over R , the restriction $\theta_X(\mathcal{M})$ of \mathcal{M} to X is a preference model $\mathcal{M}_X = \langle W_X, \succeq_X \rangle$ where $W_X = \{\pi_X(w) \mid w \in W\}$ and \succeq_X is defined as above.

Definition 20 (Restriction of a preference operator)

Given a relation schema R , a set of attributes X of R , the restriction $\theta_X(R)$ of R to X , a preference specification \mathcal{P} , and the set of its restricted models $\mathcal{M}_X(\mathcal{P})$; then the restriction $\theta_X(\omega_{\mathcal{P}})$ of a preference operator $\omega_{\mathcal{P}}$ to X is a preference operator $\omega_{\mathcal{P}}^X$ defined as follows:

$$\begin{aligned} \omega_{\mathcal{P}}^X(I(\theta_X(R))) &= \{w_X \in W_X \mid \\ &\exists \mathcal{M}_{Xk}(\mathcal{P}) \in \mathcal{M}_X(\mathcal{P}) \text{ s.t. } \forall w'_X \in W_X : \\ &\succeq_{Xk}(w'_X, w_X) \Rightarrow \succeq_{Xk}(w_X, w'_X)\} . \end{aligned}$$

Theorem 3 (Commuting with projection) *Given a relation schema R , a set of attributes X of R , the restriction $\theta_X(R)$ of R to X , a preference specification \mathcal{P} over R , and the set of its preference models $\mathcal{M}(\mathcal{P})$, if the following formulae*

$$\begin{aligned} \forall \mathcal{M}_k(\mathcal{P}) \in \mathcal{M}(\mathcal{P}), \forall w_1, w_2, w_3 \in W : \\ \pi_X(w_1) = \pi_X(w_2) \wedge \pi_X(w_1) \neq \pi_X(w_3) \\ \wedge \succeq_k(w_1, w_3) \Rightarrow \succeq_k(w_2, w_3) , \end{aligned}$$

$$\begin{aligned} \forall \mathcal{M}_k(\mathcal{P}) \in \mathcal{M}(\mathcal{P}), \forall w_1, w_3, w_4 \in W : \\ \pi_X(w_3) = \pi_X(w_4) \wedge \pi_X(w_1) \neq \pi_X(w_3) \\ \wedge \succeq_k(w_1, w_3) \Rightarrow \succeq_k(w_1, w_4) \end{aligned}$$

are valid, then for any relation instance $I(R)$ of R :

$$\{\pi_X(w) \mid w \in \omega_{\mathcal{P}}(I(R))\} = \omega_{\mathcal{P}}^X(\pi_X(I(R))) ,$$

where $\omega_{\mathcal{P}}^X = \theta_X(\omega_{\mathcal{P}})$ is the restriction of $\omega_{\mathcal{P}}$ to X .

For preference operator to distribute over the Cartesian product of two relations, the preference specification, which is the parametr of the preference operator, needs to be decomposed into the preference specifications that will distribute into the argument relations.

Theorem 4 (Distributing over Cart. product) *Given two relation schemas R_1 and R_2 , and preference specifications \mathcal{P}_1 over R_1 and \mathcal{P}_2 over R_2 , for any two relation instances $I(R_1)$ and $I(R_2)$ of R_1 and R_2 , respectively, the following property holds:*

$$\begin{aligned} \omega_{\mathcal{P}_0}(I(R_1) \times I(R_2)) = \\ \{w_1 \times w_2 \mid w_1 \in \omega_{\mathcal{P}_1}(I(R_1)) \wedge w_2 \in \omega_{\mathcal{P}_2}(I(R_2))\} , \end{aligned}$$

where $\mathcal{P}_0 = P(\mathcal{P}_1, \mathcal{P}_2)$ is a Pareto composition of \mathcal{P}_1 and \mathcal{P}_2 .

⁵We call two relation schemas *compatible* if they have the same number of attributes and the corresponding attributes have identical domains.

Theorem 4 makes it possible to derive the transformation rule that pushes preference operator with a one-dimensional preference specification down the appropriate argument of the Cartesian product:

Corollary 2 *Given two relation schemas R_1 and R_2 , a preference specifications \mathcal{P}_1 over R_1 , and an empty preference specification \mathcal{P}_2 over R_2 , for any two relation instances $I(R_1)$ and $I(R_2)$ of R_1 and R_2 , respectively, the following property holds:*

$$\begin{aligned} \omega_{\mathcal{P}_0}(I(R_1) \times I(R_2)) = \\ \{w_1 \times w_2 \mid w_1 \in \omega_{\mathcal{P}_1}(I(R_1)) \wedge w_2 \subseteq I(R_2)\} , \end{aligned}$$

where $\mathcal{P}_0 = P(\mathcal{P}_1, \mathcal{P}_2)$ is a Pareto composition of \mathcal{P}_1 and \mathcal{P}_2 .

For lexicographic composition, we obtain the same property as for Pareto composition:

Theorem 5 (Distributing over Cart. product) *Given two relation schemas R_1 and R_2 , and preference specifications \mathcal{P}_1 over R_1 and \mathcal{P}_2 over R_2 , for any two relation instances $I(R_1)$ and $I(R_2)$ of R_1 and R_2 , respectively, the following property holds:*

$$\begin{aligned} \omega_{\mathcal{P}_0}(I(R_1) \times I(R_2)) = \\ \{w_1 \times w_2 \mid w_1 \in \omega_{\mathcal{P}_1}(I(R_1)) \wedge w_2 \in \omega_{\mathcal{P}_2}(I(R_2))\} , \end{aligned}$$

where $\mathcal{P}_0 = L(\mathcal{P}_1, \mathcal{P}_2)$ is a lexicographic composition of \mathcal{P}_1 and \mathcal{P}_2 .

The following theorem shows how the preference operator distributes over the union of two relations:

Theorem 6 (Distributing over union) *Given two compatible relation schemas⁵ R and S , and a preference specification \mathcal{P} over R (and S), for any two relation instances $I(R)$ and $I(S)$ of R and S , respectively, the following property holds:*

$$\omega_{\mathcal{P}}(I(R) \cup I(S)) = \omega_{\mathcal{P}}(\omega_{\mathcal{P}}(I(R)) \cup \omega_{\mathcal{P}}(I(S))) .$$

Only in the trivial case, it is possible to distribute the preference operator over difference:

Theorem 7 (Distributing over difference) *Given two compatible relation schemas R and S , and a preference specification \mathcal{P} over R (and S), for any two relation instances $I(R)$ and $I(S)$ of R and S , respectively, the following property holds:*

$$\omega_{\mathcal{P}}(I(R) - I(S)) = \omega_{\mathcal{P}}(I(R)) - \omega_{\mathcal{P}}(I(S))$$

iff the preference specification \mathcal{P} is empty.

The next theorem shows that some kind of nontrivial distributivity of preference operator over difference exists:

Theorem 8 (Distributing over difference) *Given two compatible relation schemas R and S , and a preference specification \mathcal{P} over R (and S), for any two relation instances $I(R)$ and $I(S)$ of R and S , respectively, the following property holds:*

$$\omega_{\mathcal{P}}(I(R) - I(S)) = \omega_{\mathcal{P}}\left(\bigcup_{k=1}^n \omega_{\mathcal{P}}^{(k)}(I(R)) - I(S)\right),$$

where $n \in \mathbb{N}$ is a minimal number s.t.

$$\omega_{\mathcal{P}}\left(\bigcup_{k=1}^n \omega_{\mathcal{P}}^{(k)}(I(R)) - I(S)\right) = \omega_{\mathcal{P}}\left(\left(\bigcup_{k=1}^n \omega_{\mathcal{P}}^{(k)}(I(R)) - I(S)\right) \cup \omega_{\mathcal{P}}^{(n+1)}(I(R))\right)$$

and $\omega_{\mathcal{P}}^{(k)}$ is the k -th iteration of the preference operator in $I(R)$ defined as:

$$\begin{aligned} \omega_{\mathcal{P}}^{(1)}(I(R)) &= \omega_{\mathcal{P}}(I(R)), \\ \omega_{\mathcal{P}}^{(n+1)}(I(R)) &= \omega_{\mathcal{P}}\left(I(R) - \bigcup_{k=1}^n \omega_{\mathcal{P}}^{(k)}(I(R))\right). \end{aligned}$$

4. Related work

The study of preferences in the context of database queries has been originated by Lacroix and Lavency [12]. Following this work, *preference datalog* was introduced in [13] where it was shown that the concept of preference provides a modular and declarative means for formulating optimization and relaxation queries in deductive databases.

Nevertheless, only at the turn of the millennium this area attracted broader interest again. Kießling et al. [14, 15, 16, 17, 18] and Chomicki et al. [19, 20, 21, 22] have pursued independently a similar, *qualitative* approach within which preferences between tuples are specified directly, using binary *preference relations*. The embedding into relational query languages they have used is identical to the presented approach: They have defined an operator returning only the best preference matches. However, they haven't considered preferences between *sets* of elements. A special case of this embedding represents *skyline operator* introduced by Börzsönyi et al. [23].

A slightly different approach was proposed in [24], where the relational data model was extended to incor-

porate partial orderings into data domains. A similar approach to preference modeling in the context of web repositories was presented in [25]. Also in [26], actual values of an arbitrary attribute were allowed to be partially ordered according to user preferences. Accordingly, relational algebra operations, aggregation functions and arithmetic were redefined. However, some of their properties were lost, and the the query optimization issues were not discussed. A comprehensive work on partial order in databases, presenting the partially ordered sets as the basic construct for modeling data, is [27].

Other contributions aim at exploiting linear order inherent in many kinds of data, e.g., time series: in the context of statistical applications systems SEQUIN [28], SRQL [29], Aquery [30, 31].

By contrast to the above qualitative approach, in the *quantitative* approach [32, 33, 34] preferences are specified indirectly using *scoring functions* that associate a numeric score with every tuple.

5. Conclusions

Pursuing the goal of embedding preference queries in the relational data model, it has been shown that **user preferences can be captured in a logical language containing sixteen kinds of preferences**, and the semantics of the language can be defined with respect to the recent advances in logical representation of preferences allowing for **conflicting preferences**.

Embedding preferences into relational query languages has been implemented through a **preference operator returning the most preferred sets of tuples**. This operator has a formal semantics defined by means of optimal models of a DLP. To reason about preferences that might be inconsistent, non-monotonic reasoning about preferences has been used.

Sufficient conditions for commuting the preference operator with relational algebra selection or projection and for distributing over Cartesian product, set union, and set difference has been identified. Thus key rules for rewriting the preference queries using the standard algebraic optimization strategies have been established.

Future work directions include developing algorithms for evaluating the preference operator and identification of other algebraic properties, in order to lay the foundation for the optimization of preference queries. Also, complexity issues have to be addressed in detail.

References

- [1] G. von Wright, *The logic of preference*. Edinburgh University Press, Edinburgh, 1963.
- [2] G. von Wright, "The logic of preference reconsidered," *Theory and Decision*, vol. 3, pp. 140–169, 1972.
- [3] J. Doyle and M. P. Wellman, "Representing preferences as ceteris paribus comparatives," in *Decision-Theoretic Planning: Papers from the 1994 Spring AAAI Symposium*, pp. 69–75, AAAI Press, Menlo Park, California, 1994.
- [4] C. Boutilier, "Toward a logic for qualitative decision theory," in *Principles of Knowledge Representation and Reasoning* (J. Doyle, E. Sandewall, and P. Torasso, eds.), pp. 75–86, 1994.
- [5] J. van Benthem, S. van Otterloo, and O. Roy, "Preference logic, conditionals and solution concepts in games." Prepublication Series PP-2005-28, October 2005.
- [6] P. Girard, "Von Wright's preference logic reconsidered." <http://www.stanford.edu/~pgirard/Survey.pdf>, March 2006.
- [7] S. Kaci and L. W. N. van der Torre, "Algorithms for a nonmonotonic logic of preferences.," in *ECSQARU* (L. Godo, ed.), vol. 3571 of *Lecture Notes in Computer Science*, pp. 281–292, Springer, 2005.
- [8] S. Kaci and L. W. N. van der Torre, "Nonmonotonic reasoning with various kinds of preferences," in *IJCAI-05 Multidisciplinary Workshop on Advances in Preference Handling* (Ronen I. Brafman and U. Junker, eds.), pp. 112–117, August 2005.
- [9] Y. Shoham, "Nonmonotonic logics: Meaning and utility," in *Proc. of the 10th IJCAI*, (Milan, Italy), pp. 388–393, 1987.
- [10] G. Boella and L. W. N. van der Torre, "A nonmonotonic logic for specifying and querying preferences.," in *IJCAI* (L. P. Kaelbling and A. Saffioti, eds.), pp. 1549–1550, Professional Book Center, 2005.
- [11] N. Leone, F. Scarcello, and V. Subrahmanian, "Optimal models of disjunctive logic programs: Semantics, complexity, and computation," *IEEE Transactions on Knowledge and Data Engineering*, vol. 16, pp. 487–503, April 2004.
- [12] M. Lacroix and P. Lavency, "Preferences; Putting More Knowledge into Queries.," in *VLDB* (P. M. Stocker, W. Kent, and P. Hammersley, eds.), pp. 217–225, Morgan Kaufmann, 1987.
- [13] K. Govindarajan, B. Jayaraman, and S. Mantha, "Preference datalog," Tech. Rep. 95-50, 1, 1995.
- [14] B. Hafenrichter and W. Kießling, "Optimization of relational preference queries," in *CRPIT '39: Proceedings of the sixteenth Australasian conference on Database technologies*, (Darlinghurst, Australia, Australia), pp. 175–184, Australian Computer Society, Inc., 2005.
- [15] W. Kießling, "Foundations of Preferences in Database Systems," in *Proceedings of the 28th VLDB Conference*, (Hong Kong, China), pp. 311–322, 2002.
- [16] W. Kießling, "Preference constructors for deeply personalized database queries," Tech. Rep. 2004-07, Institute of Computer Science, University of Augsburg, March 2004.
- [17] W. Kießling, "Preference Queries with SV-Semantics.," in *COMAD* (J. Haritsa and T. Vijayarajan, eds.), pp. 15–26, Computer Society of India, 2005.
- [18] W. Kießling and B. Hafenrichter, "Algebraic optimization of relational preference queries," Tech. Rep. 2003-01, Institute of Computer Science, University of Augsburg, February 2003.
- [19] J. Chomicki, "Preference Formulas in Relational Queries," *ACM Trans. Database Syst.*, vol. 28, no. 4, pp. 427–466, 2003.
- [20] J. Chomicki, "Semantic optimization of preference queries.," in *CDB* (B. Kuijpers and P. Z. Revesz, eds.), vol. 3074 of *Lecture Notes in Computer Science*, pp. 133–148, Springer, 2004.
- [21] J. Chomicki and J. Song, "Monotonic and nonmonotonic preference revision," 2005.
- [22] J. Chomicki, S. Staworko, and J. Marcinkowski, "Preference-driven querying of inconsistent relational databases," in *Proc. International Workshop on Inconsistency and Incompleteness in Databases*, (Munich, Germany), March 2006.
- [23] S. Börzsönyi, D. Kossmann, and K. Stocker, "The skyline operator," in *Proceedings of the 17th International Conference on Data Engineering*, (Washington, DC, USA), pp. 421–430, IEEE Computer Society, 2001.
- [24] W. Ng, "An Extension of the Relational Data Model to Incorporate Ordered Domains," *ACM Transactions on Database Systems*, vol. 26, pp. 344–383, September 2001.
- [25] S. Raghavan and H. Garcia-Molina, "Complex queries over web repositories," tech. rep., Stanford University, February 2003.

- [26] R. Nedbal, "Relational Databases with Ordered Relations," *Logic Journal of the IGPL*, vol. 13, no. 5, pp. 587–597, 2005.
- [27] D. R. Raymond, *Partial-order databases*. PhD thesis, University of Waterloo, Waterloo, Ontario, Canada, 1996. Adviser-W. M. Tompa.
- [28] P. Seshadri, M. Livny, and R. Ramakrishnan, "The design and implementation of a sequence database system," in *VLDB '96: Proceedings of the 22th International Conference on Very Large Data Bases*, (San Francisco, CA, USA), pp. 99–110, Morgan Kaufmann Publishers Inc., 1996.
- [29] R. Ramakrishnan, D. Donjerkovic, A. Ranganathan, K. S. Beyer, and M. Krishnaprasad, "Srq: Sorted relational query language," in *SSDBM '98: Proceedings of the 10th International Conference on Scientific and Statistical Database Management*, (Washington, DC, USA), pp. 84–95, IEEE Computer Society, 1998.
- [30] A. Lerner, *Querying Ordered Databases with AQuery*. PhD thesis, ENST-Paris, France, 2003.
- [31] A. Lerner and D. Shasha, "Aquery: Query language for ordered data, optimization techniques, and experiments," in *29th International Conference on Very Large Data Bases (VLDB'03)*, (Berlin, Germany), pp. 345–356, Morgan Kaufmann Publishers, September 2003.
- [32] R. Agrawal and E. Wimmers, "A Framework for Expressing and Combining Preferences.," in *SIGMOD Conference* (W. Chen, J. F. Naughton, and P. A. Bernstein, eds.), pp. 297–306, ACM, 2000.
- [33] R. Fagin, A. Lotem, and M. Naor, "Optimal aggregation algorithms for middleware," in *Symposium on Principles of Database Systems*, 2001.
- [34] R. Fagin and E. L. Wimmers, "A formula for incorporating weights into scoring rules," *Theor. Comput. Sci.*, vol. 239, no. 2, pp. 309–338, 2000.

Online vyhledávání lékařských doporučení pomocí cílených (vertikálních) vyhledávačů

doktorand:

MUDR. VENDULA PAPÍKOVÁ

Oddělení medicínské informatiky
Ústav informatiky AV ČR, v. v. i.
Pod Vodárenskou věží 2
182 07 Praha 8

papikova@euromise.cz

školitel:

DOC. PHDR. RUDOLF VLASÁK

Ústav informačních studií a knihovnictví
Filozofická fakulta Univerzity Karlovy
U Kříže 8

158 00 Praha 5

rudolf.vlasak@ff.cuni.cz

obor studia:
Informační věda

Práce byla podpořena výzkumným záměrem AV0Z10300504.

Abstrakt

V době pokračující informační exploze a stále rostoucího množství webových stránek je pro odborníky důležité více než kdykoliv předtím pečlivě vážit, jaký způsob pro jejich vyhledávání zvolí. Problém nedostatečné relevance a spolehlivosti informací vyhledaných tradičními horizontálními webovými vyhledávači je jednou z překážek pro širší využití internetu jako užitečného a důvěryhodného informačního zdroje pro odborníky ze všech odvětví. Tato práce se zaměřuje na vyhledávání lékařských doporučení nezbytných pro podporu rozhodování v klinické praxi pomocí cílených (vertikálních) vyhledávačů. Byly sestaveny a porovnány tři specializované vyhledávače, které jsou přístupné pro další využití na uvedených webových adresách.

Klíčová slova: online vyhledávání informací, vertikální vyhledávače, cílené vyhledávače, relevance, internet, lékařská doporučení, podpora klinického rozhodování.

1. Úvod

V době, kdy čelíme nelimitovanému a stále rostoucímu množství webových stránek, je pro odborníky více než kdykoliv předtím důležité pozorně a pečlivě vážit, jaký způsob zvolí pro vyhledávání informací na volném internetu.

Internet je domovem biliónů webových stránek uložených na miliónech počítačů ve více než 200 zemích. Obsahuje široký záběr témat a oborů psaných renomovanými odborníky, stejně jako začátečníky či amatéry. Prohledávání této neuspořádané sbírky neorganizovaných informací rozdílné kvality je obtížným úkolem, který se pokouší více či méně úspěšně řešit celá řada internetových vyhledávacích nástrojů. V současnosti však ani ty nejúspěšnější z nich nedokáží své výsledky přizpůsobit konkrétním informačním potřebám jednotlivých uživatelů nebo uživatelských skupin. Stejně tak nedokáží vybrat validní informace z důvěryhodných zdrojů. Kromě žádaných a spolehlivých dokumentů tak uživatelé současně nabízejí informace, které mohou být neplatné, zastaralé a/nebo mají neznámý či otazný původ.

Problém nedostatečné relevance a spolehlivosti informací vyhledaných tradičními horizontálními vyhledá-

vači je jednou z překážek pro širší využití internetu jako užitečného a důvěryhodného informačního zdroje pro odborníky ze všech odvětví. Tato práce se zabývá řešením uvedené situace v oblasti klinické medicíny, konkrétně vyhledáváním lékařských doporučení nezbytných pro podporu rozhodování v klinické praxi.

2. Relevance a horizontální vyhledávací nástroje

Relevance je parametr charakterizující kvalitu vyhledávání informací. Je definována jako shoda mezi obsahem dokumentu a informační potřebou, která uživatele vedla k jeho vyhledání. Avšak při podrobnějším průzkumu zjistíme, že relevance není tak docela objektivní pojem [12].

Relevance je systematicky zkoumána od poloviny 50. let 20. století. Od té doby pojetí tohoto termínu doznalo řadu změn. Jedna z dnes přijímaných klasifikací, která přímo ukazuje na slabé místo současných horizontálních vyhledávačů, je klasifikace popsána Schamberem a kol. (1990). Podle ní se relevance dělí na relevanci tematickou (z pohledu systému, „topical relevance“) a na relevanci situační (z pohledu uživatele, „situational relevance“) [12].

Tematická relevance odráží původní obsah tohoto pojmu. Z perspektivy tematické relevance je vyhledaný dokument odpovídající proto, že jeho dosah se úplně nebo částečně překrývá s tématem uživatelské informační potřeby. Meadow (1985) upozornil na fakt, že základem tematického pohledu na relevanci je domněnka, že vztah mezi dotazem a dokumentem je neměnný. Ta však je základem nedokonalosti tematické relevance jako parametru pro hodnocení vyhledávacích systémů. Pouhá skutečnost, že dokument je „o“ uživatelské informační potřebě, v praxi totiž ještě neznamená, že dokument skutečně je relevantní. Například lékař, který hledá informace o antihypertenzním léku pro svého pacienta, pravděpodobně nebude chtít prohledávat články zabývající se použitím tohoto léku v pokusech na zvířecím modelu. Podobně farmakolog zabývající se výzkumem mechanismu redukce krevního tlaku pomocí tohoto léku na molekulární úrovni pravděpodobně nebude mít zájem o články publikující klinické studie provedené s tímto lékem. Uvedený aspekt je vyjádřen výše zmíněnou situační relevancí, která zohledňuje kontext, v němž se uživatel se svou informační potřebou nachází. Koncept situační relevance tedy vychází z předpokladu, že při hodnocení relevance vyhledaných informací nemůže být oddělena informační potřeba uživatele od situace, v rámci které vyhledávání informací provádí [12].

V současné době rozšířené internetové vyhledávací nástroje založené na algoritmickém vyhledávání jsou limitovány neschopností zohlednit aspekt situační relevance. Studie hodnotící spokojenost uživatelů internetu s výsledky vyhledávání informací pomocí horizontálních vyhledávačů ukazují, že méně než polovina uživatelů vždy najde to, co skutečně potřebuje, a to i po několika pokusech [6].

Mezi hlavní příčiny nedostatečné situační relevance dokumentů vyhledaných tradičními horizontálními vyhledávači patří mnohoznačnost klíčových slov a neschopnost horizontálních vyhledávačů detekovat kontext a přesně identifikovat informační potřebu uživatele nachazejícího se v určité konkrétní situaci pouze na základě vyhledávaného dotazu [6]. Je-li například do vyhledávače zadáno klíčové slovo „diabetes“, vyhledávač neví, zda dotaz položil lékař hledající data z klinického výzkumu nebo pacient hledající obecné informace o této nemoci a o možnostech její léčby nebo kontakty na komunitu sdružující pacienty s touto chorobou. Upřesňování dotazu pomocí dalších klíčových slov řeší situaci pouze částečně a navíc je časově náročné.

3. Současné přístupy k řešení limitů horizontálních vyhledávačů

Výše uvedený nedostatek tradičních horizontálních internetových vyhledávačů je možné řešit pomocí tří základních přístupů:

- a. upřesňováním vyhledávaného dotazu (search query refinements),
- b. personalizací vyhledávání (personal search),
- c. pomocí přizpůsobených, vertikálních vyhledávačů (custom search, vertical search).

Upřesňování vyhledávaného dotazu urychluje vyhledání situačně relevantních informací ve srovnání s intuitivním doplňováním dalších klíčových slov tím, že automaticky nabízí vybrané kategorie systémem vyhodnocené jako patřičné pro dané téma (např. knihy, články, zprávy, obrázky atd.) a umožňuje tak uživateli rychle zacílit vyhledávání směrem k jeho konkrétní informační potřebě. Tyto nástroje však umožňují spíše hrubé třídění na obecně často vyhledávané kategorie a z hlediska požadavku precizního vyhledávání oborově specifických informací jsou proto málo efektivní. Příkladem uvedeného řešení jsou Yahoo Shortcuts nebo Google One-Box [6].

Personalizace vyhledávání je na internetu relativně novou oblastí. Obsah tohoto pojmu je definován nejednotně [22], v některých případech je dokonce zaměňován s níže uvedenými vertikálními vyhledávači. V zásadě však zahrnuje tyto klíčové charakteristiky:

- a. přizpůsobení obsahu (customization) tematickým preferencím uživatele (uživatel explicitně uvedeným a/nebo systémem automaticky odvozeným na základě monitorace chování uživatele při vyhledávání informací),
- b. schopnost aplikace nabízet uživateli významy specifické pro daný problém (contextualization) na základě „vlastní znalosti“ tématu a „schopnosti dedukovat“ zaměření z jeho chování [23].

Uvedený koncept však přináší řadu komplikací od neochoty uživatelů vyplňovat formuláře, přes problém sdílených počítačů až po skutečnost, že vyhledávání je proces vázaný na daný čas nebo jen okamžik. Pouhé vyhledání určité informace neznamená, že uživatel se o danou oblast skutečně zajímá [22]. K příkladům personalizovaného vyhledávání patří Google Personalized Search nebo Microsoft Live Search.

Specializované (vertikální) vyhledávače, jinak nazývané také cílené nebo tematické vyhledávače (specialty, targeted, topical search engines) umožňují přizpůsobit zaměření vyhledávače konkrétním požadavkům uživatele.

Specifika vertikálních vyhledávačů je možné pozorovat na třech úrovních:

- Deskriptivní název*: Nekonstantní, zato však významná charakteristika specializovaného vyhledávače, která a priori selektuje uživatele a zvyšuje tak relevanci vyhledaných informací (např. Diabetes Web Search nebo Health Professional's Medical Search).
- Výběr oborově specifických webových stránek zaručující prohledávání situačně (kontextově) relevantního obsahu*: Důležitým faktorem na tomto místě je technologická úroveň poskytovatele vyhledávacího software. Pro konstrukci kvalitního a precizního vertikálního vyhledávače je nezbytné, aby vyhledávací software byl schopen manuálně vybrané webové stránky prohledávat přesně tak, jak uživatel a/nebo autor vyžaduje. Méně sofistikované vyhledávací technologie umožňují prohledávání celých domén, nikoliv však subdomén či konkrétních „URL vzorců“ potřebných pro přesné vymezení obsahu, který má být prohledáván, a nelze tedy od nich očekávat precizní výsledky.
- Další faktory specifické pro jednotlivé vyhledávací technologie*, např. umožnění preference nebo restrikce vybraných webových stránek, zákaz reklamy, úprava pořadí algoritmicky vyhledaných webových stránek s ohledem na jejich hodnocení danou komunitou uživatelů atp.

Vertikální vyhledávače lze rozdělit na dvě skupiny:

- „Vyhledávače poskytovatelů vyhledávací služby“*: Poskytovatel určí, jaké webové stránky (a ev. další databáze) bude prohledávat a jakou technologii pro tento účel zakoupí nebo sám vyvine.
Mezi vyhledávače z této skupiny patří například: *MedHunt* (www.hon.ch/MedHunt) - kvalitní a respektovaný profesionální medicínský vyhledávač, *OmniMedicalSearch* (www.omnimedicalsearch.com) - prohledávající hlavní medicínské portály a databáze, *Scirus* (www.scirus.com) - známý vyhledávač vědecko-výzkumné literatury, který kombinuje

cílené prohledávání internetu pomocí technologie FAST s informačními zdroji pocházejícími z nakladatelství Elsevier, nebo *CiteSeer* (<http://citeseer.ist.psu.edu>) - vyhledávač zaměřený na oblast počítačové vědy.

- „Vyhledávače uživatelů“* (jednotlivců či organizací, institucí, týmů ap.): Uživatel - specialista v určitém oboru - specifikuje obsah, který má být prohledáván s použitím některé z vertikálních platform tradičních horizontálních vyhledávačů nebo pomocí nových webových technologií.

Mezi uvedené technologie patří například:

Live Search Macros (Microsoft)

(<http://search.live.com/macros>),

Yahoo! Search Builder

(<http://builder.search.yahoo.com>),

Google Co-op (Google Custom Search Engine)

(www.google.com/coop),

Rollyo (www.rollyo.com) a

Swicki (*Eurekster*) (www.eurekster.com).

4. Lékařská doporučení na volném internetu

Dostupnost vědeckých lékařských informací je základem předpokladem pro úspěšnou implementaci vědecko-výzkumných poznatků do medicínské praxe. V době, kdy se elektronická verze odborných sdělení a dokumentů stala již běžnou normou, je internet jedním z hlavních kanálů jejich šíření mezi odbornou veřejností. Díky své flexibilitě a dnes již také snadné dostupnosti je v klinické praxi také velmi žádaný a mnoha lékaři používáný [9].

Z hlediska medicínské praxe založené na důkazech (EBM) musí informace splňovat následující kritéria: aktuálnost, správnost, spolehlivost a užitečnost (tj. musí reflektovat praktické klinické otázky). Z tohoto hlediska patří mezi klíčové dokumenty lékařská doporučení (guidelines) vytvářená týmy odborníků na mezinárodní, národní a lokální úrovni.

Lékařská doporučení jsou odborně posouzené a schálené postupy pro náležitou péči a léčbu u lidí s určitým onemocněním nebo zdravotním stavem. Vycházejí z nejlepších vědeckých důkazů dostupných v dané době a jsou cennou oporou v procesu klinického rozhodování [14].

Lékařská doporučení jsou dnes běžně dostupná na internetu. V současné době existuje celá řada různě velkých databází lékařských doporučení a webových stránek umožňujících jejich prohledávání. V této práci byla věnována pozornost volně dostupným dokumentům. Mezi

hlavní instituce umožňující přístup k lékařským doporučením bez licenčních omezení i bez registrace patří:

- *National Guideline Clearinghouse* [13] - komplexní databáze doporučení a souvisejících dokumentů pro klinickou praxi založená (ve spolupráci s American Medical Association a American Association of Health Plans/nyní American Health Insurance Plans) a spravovaná americkou Agency for Healthcare Research and Quality.
- Lékařská doporučení publikovaná americkými Centry pro kontrolu a prevenci nemocí - *Centers for Disease Control and Prevention* (Atlanta, USA) [4].
- *The National Library of Guidelines* [15] - databáze doporučení pro klinickou praxi přijatých ve Spojeném království Velké Británie a Severního Irsku, spravovaná Lékařskou knihovnou Univerzity v Sheffieldu ve spolupráci s Národní lékařskou knihovnou Spojeného království Velké Británie a Severního Irsku. Je založena na doporučeních vytvářených National Institute for Health and Clinical Excellence (NICE), Scottish Intercollegiate Guidelines Network (SIGN), Department of Health (DH) a řadou dalších institucí.
- *New Zealand Guidelines Group* [16] - Knihovna lékařských doporučení přijatých v rámci Nového Zélandu.
- Doporučení pro kontrolu a prevenci šíření infekčních nemocí (*Infection control guidelines for the prevention of transmission of infectious diseases in the health care setting*) přijatá australskou vládou (Australian Government Department of Health and Ageing 2004) [1].
- *Doporučení pro klinickou praxi přijatá australskou Národní radou pro zdraví a medicínský výzkum (Australian National Health and Medical Research Council)* [2].
- Klinická doporučení publikovaná v *The Medical Journal of Australia* [21].
- *Modrá kniha* - Doporučení pro prevenci a kontrolu infekčních nemocí vytvořená australskou vládou [20].
- *Infobase* - Lékařská doporučení pro klinickou praxi Asociace lékařů Kanady [3].

- *Lékařská doporučení* publikovaná kanadskou federální institucí *Health Canada* [11].
- *Lékařská doporučení kanadské Public Health Agency* [17].
- *Klinická doporučení pro primární péči* vytvořená na *Lékařské fakultě University of California, San Francisco* [24].
- *Lékařská doporučení* publikovaná *Světovou zdravotnickou organizací* [25].

5. Vytvoření a optimalizace nástroje pro online vyhledávání lékařských doporučení

Pro vytvoření vyhledávače specializovaného na vyhledávání lékařských doporučení bylo vybráno 13 na internetu volně dostupných databází vytvářených a spravovaných důvěryhodnými a respektovanými zdravotnickými institucemi a vydavatelstvími [13], [4], [15], [16], [1], [2], [21], [20], [3], [11], [17], [24], [25]. Byly vytvořeny tři vyhledávače, a to pomocí technologie Rollyo [5], Swicki (Eurekster) [19] a Google Co-op [10], [7], [8].

5.1. Rollyo Clinical Guidelines

Rollyo (www.rollyo.com) je technologie stejnojmenné společnosti, která byla uvedena do provozu v září 2005. Umožňuje vytváření vlastních vyhledávačů založených na webových stránkách dle vlastního výběru, které jsou prohledávány pomocí Yahoo! Search.

Vyhledávač s názvem Clinical Guidelines (obr. 1) byl vytvořen pomocí formulářového rozhraní [5] a je dostupný na adrese www.rollyo.com/evidencebasedsources/clinical_guidelines.

5.2. Clinical Guidelines Swicki

Technologie Swicki pro tvorbu vlastních, cílených vyhledávačů, je služba společnosti Eurekster dostupná od listopadu 2005. Jak název aplikace napovídá - kromě vyhledávání (search) je její podstatou princip spolupráce komunity (analogie wiki), která daný vyhledávač (Swicki) využívá [18]. Vyhledávač nazvaný Clinical Guidelines Swicki (obr. 2, 3) byl vytvořen pomocí formulářového rozhraní [19] a je dostupný na adrese <http://clinical-guidelines-swicki.eurekster.com>.

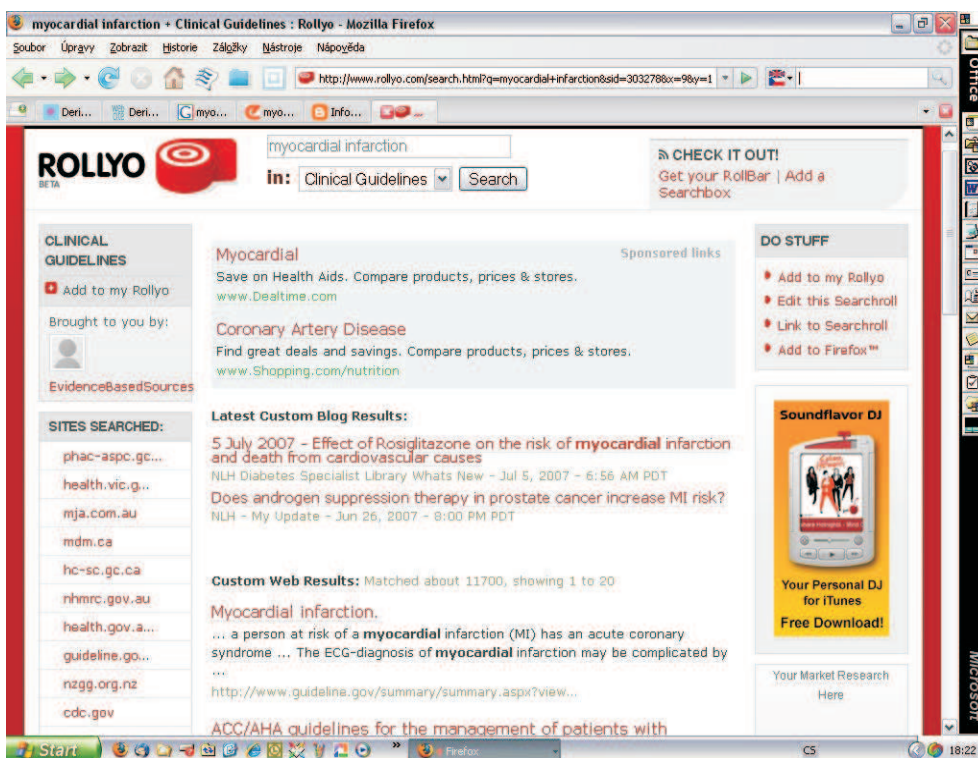

Obrázek 1: Výsledky vyhledávání lékařských doporučení na internetu pomocí vyhledávače Rollyo.

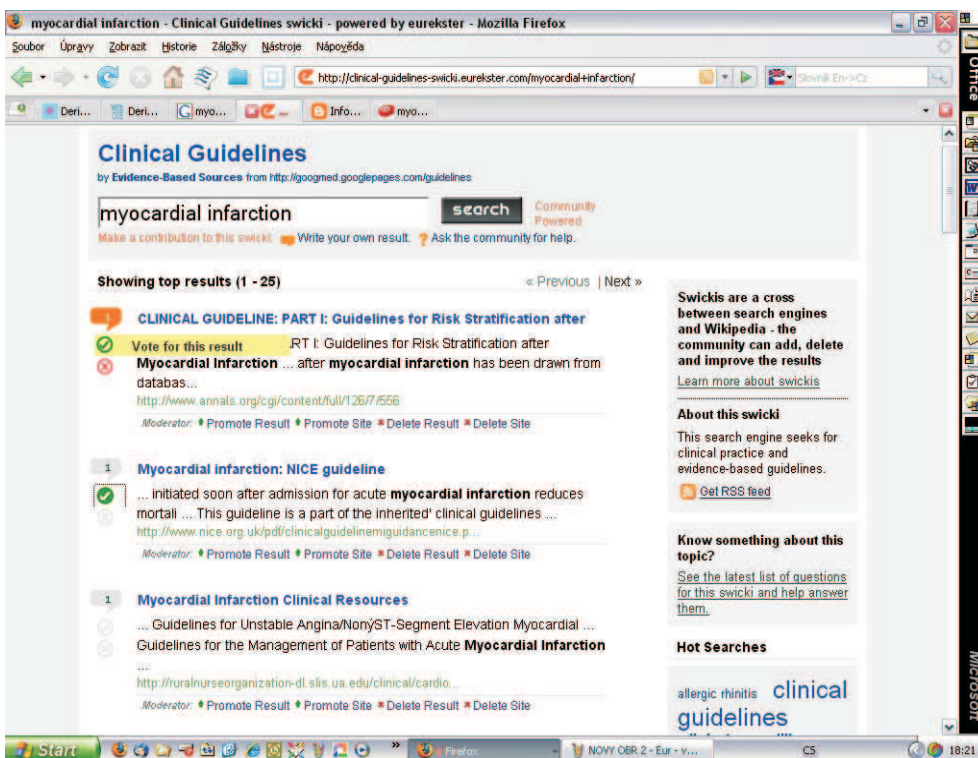

Obrázek 2: Výsledky vyhledávání lékařských doporučení na internetu pomocí vyhledávače Swicki (Eurekster).



Obrázek 3: Hlasování uživatelů o užitečnosti vyhledaných webových stránek pomocí vyhledávače Swicki (Eurekster) umožňuje postupné zvyšování relevance výsledků vyhledávání („učící se vyhledávač“).

5.3. Google Clinical Guidelines Custom Search Engine (CSE)

Google Co-op je vertikální platforma v současné době nejmocnějšího horizontálního vyhledá-

vacího nástroje na internetu zpřístupněná uživatelům v říjnu 2006. Vyhledávač s názvem Clinical Guidelines CSE (obr. 4) byl sestaven pomocí formulářového rozhraní [10], [7], [8] a je dostupný na <http://googmed.googlepages.com/guidelines>.

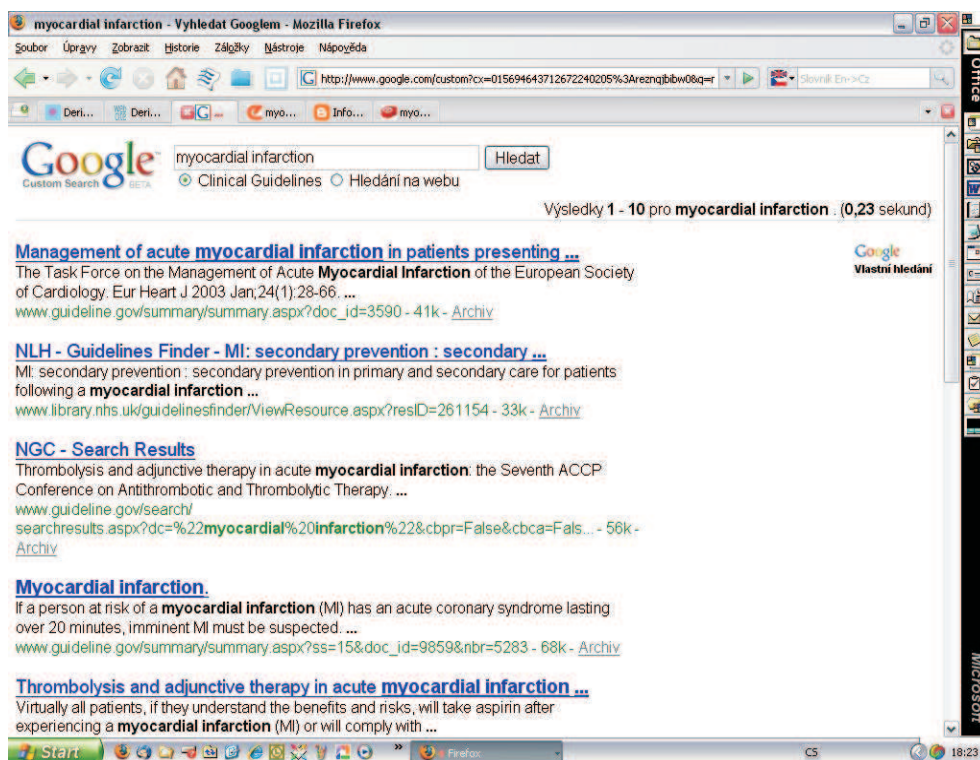

Obrázek 4: Výsledky vyhledávání lékařských doporučení na internetu pomocí Google Custom Search Engine jsou tematicky i situačně (kontextově) vysoce relevantní.

	Rollyo Medical Guidelines	Medical Guidelines Swicki (Eurekster)	Medical Guidelines CSE (Google)
Myocardial infarction	11 800	43 160	120
Hypertension	33 500	177 855	97
Diabetes mellitus	21 900	24 529	93
Chronic renal failure	12 400	34 265	91
Hepatitis C	38 800	195 039	96
Osteoporosis	12 600	138 701	101
Phenylketonuria	952	3 720	30

Tabulka 1: Počet webových stránek vyhledaných pomocí cílených vyhledávačů Rollyo, Swicki (Eurekster) a Google CSE při zadání základních klinických diagnóz.

6. Vyhodnocení vytvořených vyhledávačů

Výše uvedené vyhledávače jsou založeny v principu na zcela odlišných vyhledávacích strategiích, což ve svém důsledku znesnadňuje jejich striktní porovnání. Pro účely této práce byl kladen důraz především na vlastnosti a funkce přímo ovlivňující nejenom tematickou, ale především situační relevanci vyhledaných dokumentů. Srovnání vytvořených vyhledávačů shrnují tabulky 1 a 2.

Při zadání klíčových slov zachycujících vybrané klinické diagnózy počet vyhledaných dokumentů vždy odpovídal následujícímu vzoru:

Swicki (Eurekster) > Rollyo > Google CSE

Jak dokládá tabulka 1, je množství dokumentů vyhledaných pomocí Swicki a Rollyo s ohledem na 13 vybraných internetových zdrojů nepříjemně vysoké. V případě vyhledávače **Rollyo** je tato skutečnost dána tím, že vyhledávač neprohledává přesně zadané stránky nebo jejich části, ale celé domény, což značně snižuje relevanci. Druhým důvodem je fakt, že systém neumožňuje zadání implicitně vyhledávaných klíčových slov, jako tomu je v případě Swicki a Google CSE (při jejichž sestavování byla zadána tato klíčová slova: clinical, medical, guidelines). Tato klíčová slova jsou systémem automaticky zadávána do každého vyhledávaného dotazu.

V případě „komunitně“ orientovaného vyhledávače **Swicki** je vysoký počet dokumentů způsoben tím, že tento nástroj prohledává kromě požadovaných stránek současně také celý internet, přičemž neumožňuje (na rozdíl od Rollyo a Google CSE) samostatné prohle-

dávání pouze zadaných stránek. Přestože konstrukce vyhledávače umožňuje požadované stránky ve výsledcích preferovat, současné prohledávání celého webu významně snižuje relevanci vyhledaných výsledků. V dlouhodobém horizontu tento nedostatek vyvažuje funkce umožňující hlasování uživatelů o užitečnosti jednotlivých stránek (obr. 3). Nerelevantní nebo nedůvěryhodné výsledky jsou tak znevýhodňovány před validními a relevantními záznamy. Skutečnost, že spolu s preferovanými webovými stránkami je prohledáván také celý internet, tak může být přínosem v tom, že vyhledávání je obohaceno o další relevantní zdroje, které při výběru základní sady webových odkazů byly opomenuty. Tímto způsobem komunitou „objeveny“ a oceněny mohou být autorem a současně moderátorem vyhledávače přidány mezi preferované odkazy a dostávat se tak na přední pozice ve výsledcích vyhledávání. Uvedená technologie tak respektuje skutečnost, že situační relevanci nejlépe mohou posoudit jedině sami uživatelé [22], kteří svým chováním (prohlížením nebo opomíjením jednotlivých webových odkazů a event. hlasováním o jejich užitečnosti) dávají vyhledávači zpětnou vazbu, na základě které pak algoritmicky vyhledávané výsledky mohou být korigovány („učící se vyhledávač“).

Nejpřesnějších výsledků bylo dosaženo pomocí **Google CSE**. Technologie **Google Co-op** se ukázala jako nejvíce flexibilní. Ze systémů zde zmíněných umožňuje nejpřesnější definování obsahu, který má být prohledáván (tzv. URL vzorce [10]), a zadávání parametrů ovlivňujících pořadí výsledků vyhledávání [7]. Tuto skutečnost dokládají tabulka 1 a obrázek 4, které dokumentují nejlepší zacílení na požadované téma ve srovnání s ostatními zde zmiňovanými vyhledávači.

	Rollyo	Swicki (Eurekster)	Google Custom Search Engine (Google Co-op)
Limit prohledávaných webových adres	25	Není udán.	Není udán.
Možnosti zadávání webových adres	Adresy automaticky redukuje na hlavní domény, neumožňuje přesnější specifikaci obsahu, který má být prohledáván.	Respektuje adresy tak, jak byly zadány (vč. subdomén), neumožňuje však podrobnější specifikaci obsahu, který má být prohledáván.	Umožňuje prohledávání celých domén i subdomén, vč. přesné specifikace obsahu, který má být prohledáván, pomocí tzv. URL vzorců (URL patterns).
Možnost zadání implicitně prohledávaných klíčových slov	-	+	+
Možnost vyloučení reklam a sponzorovaných odkazů	-	-	+
Prohledávání celého internetu	Je možné samostatně (není automaticky součástí výsledků cíleného vyhledávání).	Je automaticky součástí vyhledávání a nelze ho oddělit od cíleného vyhledávání. Požadované stránky je možné ve vyhledávání zvýhodnit nebo zakázat.	Je možné samostatně prohledávání obsahu definovaného v cíleném vyhledávači i prohledávání celého internetu se zvýhodněním či zákazem požadovaných stránek.
Prohledávání jednotlivých stránek vyhledávače	Je možné prohledávat zvlášť každou stránku cíleného vyhledávače.	Není možné prohledávat zvlášť jednotlivé stránky cíleného vyhledávače.	Není možné prohledávat zvlášť jednotlivé stránky cíleného vyhledávače.
Preference nebo restrikce vybraných stránek ve výsledcích vyhledávání	Není možná.	Je možná.	Je možná.
Vlastnost, kterou se technologie nejvíce liší od ostatních	Umožňuje prohledávat jednotlivé domény.	Na základě hlasování uživatelů vyhledávač koriguje pořadí výsledných dokumentů (obr. 3).	Je velmi flexibilní. Umožňuje přesné definování obsahu, který má být prohledáván (URL patterns).

Tabulka 2: Srovnání technologií Rollyo, Swicki (Eurekster) a Google Co-op pro sestavování cílených (vertikálních) vyhledávačů.

7. Závěr

Výsledkem této práce jsou tři specializované vyhledávače zaměřené na online vyhledávání lékařských doporučení, které jsou dostupné pro další využití na webových adresách uvedených v textu tohoto článku.

Jako nejpreciznější se projevila technologie Google Co-op, která (v případě dobré znalosti oboru či tématu, které má být předmětem prohledávání) umožňuje prakticky okamžitě vytvořit velmi precizní vyhledávací nástroj generující vysoce relevantní výsledky. Jako daleko méně

precizní, přesto však přínosná se projevila technologie Swicki (Eurekster). Vyhledávač založený na principu spolupráce profesní (nebo zájmové) skupiny má perspektivu spíše v delším časovém horizontu, a to jednak proto, že umožňuje autorovi a současně moderátorovi vyhledávače zohledňovat podněty a preference uživatelů, a dále díky své schopnosti korigovat algoritmicky vyhledané výsledky s ohledem na chování uživatelů při vyhledávání informací. Oba v závěru jmenované vyhledávací nástroje budou i nadále zdokonalovány a průběžně aktualizovány.

Literatura

- [1] Australian Infection control guidelines for the prevention of transmission of infectious diseases in the health care setting. [Online]. Available: www.health.gov.au/internet/wcms/Publishing.nsf/content/icg-guidelines-index.htm permalink www.webcitation.org/5QA7qPocS cached Jul. 7, 2007. [Accessed Jul. 7, 2007].
- [2] Australian National Health and Medical Research Council: Clinical Practice Guidelines. [Online]. Jun. 6, 2006. Available: www.nhmrc.gov.au/publications/subjects/clinical.htm, permalink www.webcitation.org/5Q9ztbbqX cached Jul. 7, 2007. [Accessed Jul. 7, 2007].
- [3] Canadian Medical Association - Infobase: Clinical Practice Guidelines. [Online]. Available: <http://mdm.ca/cpgsnew/cpgs/index.asp>, permalink www.webcitation.org/5QA4PA4Qy cached Jul. 7, 2007. [Accessed Jul. 7, 2007].
- [4] Centers for Disease Control and Prevention, Atlanta USA. [Online]. Available: www.cdc.gov/, permalink www.webcitation.org/5QA8ARMIQ cached Jul. 7, 2007. [Accessed Jul. 7, 2007].
- [5] Create Searchroll. [Online]. Available: www.rollyo.com/createroll.html [Accessed Jul. 7, 2007].
- [6] E. Enge, "Are Vertical Search Engines the Answer to Relevance?", *Search Engine Watch* [Online] Jan 3, 2007. Available: <http://searchenginewatch.com/showPage.html?page=3624377>, permalink www.webcitation.org/5PzZ3uFV9 cached Jun. 30, 2007. [Accessed Jun. 30, 2007].
- [7] E. Enge, "Building a Quality Custom Search Engine", [Online]. Available: www.stonetemple.com/articles/google-CSE-success.shtml, permalink www.webcitation.org/5Q8JHjutu cached Jul. 6, 2007. [Accessed Jul. 6, 2007].
- [8] E. Enge, "Google Custom Search Engines (Google CSEs)", [Online]. Available: www.stonetemple.com/articles/google-custom-search-engines.shtml, permalink www.webcitation.org/5Q8CMAnmD cached Jul. 6, 2007. [Accessed Jul. 6, 2007].
- [9] B. A. Finegan, "Access Denied; Care Impaired: The Benefits of Having Online Medical Information Available at the Point-of-Care", *Anesthesia & Analgesia*, vol. 99, pp. 1450–1452, 2004. Available: www.anesthesia-analgesia.org/cgi/content/full/99/5/1450, permalink www.webcitation.org/5Q9kY5T8Z cached Jul. 7, 2007. [Accessed Jul. 7, 2007].
- [10] Google, Inc., "Google Co-op", [Online]. Available: www.google.com/coop/, permalink www.webcitation.org/5Q8LHP2oN cached Jul. 6, 2007. [Accessed Jul. 6, 2007].
- [11] Health Canada: Guidelines. [Online]. Available: www.hcsc.gc.ca/ahcasc/legislation/guideld/index_e.html, permalink www.webcitation.org/5QA5Eh8Ia cached Jul. 7, 2007. [Accessed Jul. 7, 2007].
- [12] W. R. Hersh, "Relevance-based evaluation, in Information retrieval - A health and biomedical prespective", 2003, Springer-Verlag: New York. pp. 83–113.
- [13] "National Guideline Clearinghouse", [Online]. Available: www.guideline.gov, permalink www.webcitation.org/5Q9tOXWja, cached Jul. 7, 2007. [Accessed Jul. 7, 2007].

- [14] National Institute for Health and Clinical Excellence (UK). "Clinical guidelines - definition", [Online]. Available: www.nice.org.uk/guidance/CG,
permalink www.webcitation.org/5Q19XawLc cached Jul. 1, 2007. [Accessed Jul. 1, 2007].
- [15] National Library of Guidelines (UK). www.library.nhs.uk/guidelinesFinder/Default.aspx?pagename=HOME,
permalink www.webcitation.org/5Q9wE6E46 cached Jul. 7, 2007. [Accessed Jul. 7, 2007].
- [16] New Zealand Guidelines Group. [Online] Mar. 21, 2007. Available: www.nzgg.org.nz,
permalink www.webcitation.org/5Q9zVtmy7 cached Jul. 7, 2007. [Accessed Jul. 7, 2007].
- [17] Public Health Agency of Canada Guidelines. [Online].
Available: www.phac-aspc.gc.ca/dpg_e.html,
permalink www.webcitation.org/5QA6oimf1 cached Jul. 7, 2007. [Accessed Jul. 7, 2007].
- [18] Swicki FAQ. [Online]. Available: <http://swickihome.eurekster.com/faqs.htm>. [Accessed Jul. 17, 2007].
- [19] SwickiBuilder. [Online]. Available: <http://swickihome.eurekster.com/customize.htm>. [Accessed Jul. 16, 2007].
- [20] The Blue Book - Guidelines for the control of infectious diseases of the Victorian Government Health Information (Australia). [Online]. Revised edition 2005. Available: www.health.vic.gov.au/ideas/bluebook,
permalink www.webcitation.org/5QA5n0tNP cached Jul. 7, 2007. [Accessed Jul. 7, 2007].
- [21] The Medical Journal of Australia Clinical Guidelines. [Online].
Available: www.mja.com.au/public/guides/guides.html,
permalink www.webcitation.org/5QA9LzSSV cached Jul. 7, 2007. [Accessed Jul. 7, 2007].
- [22] B. Thompson, "Is Personalized Search the Future?", [Online] Aug 3, 2004.
Available: www.webpronews.com/node/11089/print,
permalink www.webcitation.org/5PzKngYuY cached Jun. 30, 2007. [Accessed Jun. 30, 2007].
- [23] B. Thompson, "Yahoo! Talks Personalized Search", [Online] Aug. 3, 2004.
Available: www.webpronews.com/insiderreports/2004/08/03/yahoo-talks-personalized-search,
permalink www.webcitation.org/5PzT1oibU cached Jun. 30, 2007. [Accessed Jun. 30, 2007].
- [24] University of California, San Francisco, School of Medicine "Primary Care Clinical Practice Guidelines", [Online]. Available: <http://medicine.ucsf.edu/resources/guidelines/guide.html>,
permalink www.webcitation.org/5QA7UVEPA cached Jul. 7, 2007. [Accessed Jul. 7, 2007].
- [25] World Health Organisation. [Online]. Available: <http://who.int/en/>. [Accessed Jul. 7, 2007].

Úplný problém nejmenších čtverců v úlohách s násobnou pravou stranou

doktorand:

ING. MARTIN PLEŠINGER

Fakulta mechatroniky
Technická univerzita Liberec
Hájkova 6
461 17 Liberec 1

martin.plesinger@tul.cz

školitel:

PROF. ING. ZDENĚK STRAKOŠ, DRSc.

Ústav informatiky AV ČR, v. v. i.
Pod Vodárenskou věží 2
182 07 Praha 8

strakos@cs.cas.cz

obor studia:
Přírodovědné inženýrství

Tato práce byla podpořena grantem národního programu výzkumu "Informační společnost" č. 1ET400300415.

Abstrakt

V tomto příspěvku se budeme zabývat klasifikací lineárních aproximačních úloh s ohledem na jejich řešitelnost ve smyslu formulace tzv. úplného problému nejmenších čtverců.

1. Úvod

Uvažujme lineární aproximační úlohu

$$AX \approx B, \quad (1)$$

kde $A \in \mathbb{R}^{m \times n}$ a $B \in \mathbb{R}^{m \times d}$ jsou matice systému a d -násobná pravá strana, $X \in \mathbb{R}^{n \times d}$ je matice neznámých. (Pokud $d = 1$ značíme pravou stranu b a vektor neznámých x .) Úloha (1) lze ekvivalentně přeformulovat

$$[B | A] \begin{bmatrix} -I_d \\ X \end{bmatrix} \approx 0.$$

Způsob aproximace upřesní následující definice.

Definice 1 *Minimalizační úlohu*

$$\min_{G, E, X} \| [G | E] \|_F, \quad (A + E)X = (B + G), \quad (2)$$

nazveme úplným problémem nejmenších čtverců (total least squares problem, TLS). Řešením úplného problému nejmenších čtverců nazveme libovolné X splňující (2).

Bez újmy na obecnosti budeme předpokládat $m \geq n + d$ (v opačném případě matici $[B | A]$ doplníme nulovými řádky). Dále předpokládejme $A^T B \neq 0$ (v opačném případě, tedy jsou-li obory hodnot matic A a B vzájemně ortogonální, snaha aproximovat B pomocí sloupců matice A postrádá smysl a lze ukázat, že problém (2) má triviální řešení).

2. Úlohy s jednou pravou stranou

Úplný problém nejmenších čtverců pro $d = 1$ (úlohu s jednou pravou stranou) prvně analyzovali Gene Golub a Charles Van Loan [1], 1980. Ukázali, že úloha (2) nemá obecně řešení. Za předpokladu, že řešení existuje, nemusí být jednoznačné; zavádí se řešení minimální v normě.

Sabine Van Huffel a Joos Vandewalle [5], 1991, nazývají problém (2) s $d = 1$ jež nemá řešení *negenerickým*. Zavádějí pro něj tzv. *negenerické řešení*, které vždy existuje a lze definovat tak, že je jednoznačné. Význam negenerického řešení ovšem není příliš zřejmý.

Analýzu problému s jednou pravou stranou uzavírá článek Christophera Paige a Zdeňka Strakoše [6], 2006. Za předpokladu ortogonální invariance úlohy (1) lze ukázat, že existují matice $P \in \mathbb{R}^{m \times m}$, $P^{-1} = P^T$ a $Q \in \mathbb{R}^{n \times n}$, $Q^{-1} = Q^T$ takové, že

$$P^T [b | A Q] = \left[\begin{array}{c|c|c} b_1 & A_{11} & 0 \\ \hline 0 & 0 & A_{22} \end{array} \right] \quad (3)$$

přičemž matice $[b_1 | A_{11}]$ má minimální dimenzi přes všechny ortogonální transformace vedoucí na blokově diagonální strukturu (3). Původní úloha (1) se tak rozpadne na dva nezávislé podproblémy

$$A_{11} x_1 \approx b_1, \quad A_{22} x_2 \approx 0.$$

Lze ukázat [6, 1], že první z obou podproblémů je *vždy řešitelný* ve smyslu Definice 1 a navíc jeho řešení x_1 je *jednoznačné*. Podproblém $A_{11} x_1 \approx b_1$ nazýváme *core*

problémem. Dále lze ukázat, že vektor

$$x \equiv Q \begin{bmatrix} x_1 \\ 0 \end{bmatrix}$$

je identický s řešením minimálním v normě, dle Goluba a Van Loana [1], existuje-li, respektive s řešením negenerickým [5] v případě, že (2) řešení nemá. Teorie core problému tak dává konceptu negenerického řešení dobře interpretovatelný význam. Pro podrobnější výklad viz [6, 2, 3] případně [7].

2.1. Klasická analýza úloh s jednou pravou stranou

O tom, zda problém (2) s jednou pravou stranou má nebo nemá řešení, případně o tom, zda řešení, existuje-li, je jednoznačné či nikoliv, lze rozhodnout na základě pravých singulárních vektorů a distribuce singulárních čísel rozšířené matice $[b | A]$. Uvažujme tedy singulární rozklad

$$[b | A] = U \Sigma V^T \quad (4)$$

a

$$\sigma_1 \geq \dots \geq \sigma_p > \sigma_{p+1} = \dots = \sigma_{n+1} \geq 0 \quad (5)$$

singulární čísla matice $[b | A]$. Dále uvažujme následující dělení matice pravých singulárních vektorů

$$V = \left[\begin{array}{c|c} V_{11} & V_{12} \\ \hline V_{21} & V_{22} \end{array} \right], \quad (6)$$

kde $V_{11} \in \mathbb{R}^{1 \times p}$, $V_{12} \in \mathbb{R}^{1 \times (n-p+1)}$, $V_{21} \in \mathbb{R}^{n \times p}$, $V_{22} \in \mathbb{R}^{n \times (n-p+1)}$. (Pokud $\sigma_1 = \sigma_{n+1}$, pak $p = 0$ a σ_p , V_{11} a V_{21} neexistují. V [5] mají bloky matice (6) jiné pořadí.) Platí následující věta.

Věta 1 *Necht' je dána lineární aproximační úloha (1) a $d = 1$. Uvažujme singulární rozklad (4), se značením zavedeným v (5)–(6).*

Úplný problém nejmenších čtverců (2) má řešení tehdy a jen tehdy, když $V_{12} \neq 0$.

Navíc pokud $p = n$, pak je toto řešení jednoznačné, pokud $p > n$ pak lze zkonstruovat řešení minimální v normě.

Důkaz viz [1, 5]. (V opačném případě $V_{12} = 0$ lze vždy, jak již bylo řečeno, zkonstruovat jednoznačné negenerické řešení, viz [4, 5], které však není řešením úlohy (2) ve smyslu Definice 1.)

3. Úlohy s násobnou pravou stranou

V článku [6] je pro úlohy s jednou pravou stranou využito klasické analýzy, zde shrnuté ve Větě 1, k důkazu

jednoznačné řešitelnosti core problému ve smyslu Definice 1. Naší snahou je rozšířit tuto teorii, zejména ideu redukce úlohy na core problém, na úlohy s násobnou pravou stranou, tedy pro $d > 1$. Je tedy nutné vědět, kdy je daný úplný problém nejmenších čtverců (2) řešitelný.

Analýzou existence a jednoznačnosti řešení pro úlohy s násobnou pravou stranou se zabývali Sabine Van Huffel a Joos Vandewalle, [5]. Analyzovali však jen některé *speciální případy*, obecná analýza chybí, viz [5, poznámka na str. 66]. Navzdory tomu algoritmus pro řešení úplného problému nejmenších čtverců, tzv. *TLS algoritmus*, viz [4], [5, Algoritmus 3.1, str. 87–88], vrátí „řešení“ pro libovolnou úlohu (1). Jedním z kroků vedoucích k rozšíření teorie core problému na úlohy s násobnou pravou stranou tak je zúplnění analýzy řešitelnosti problému (2).

3.1. Klasická analýza úloh s více pravými stranami

Speciální případy analyzované v [5] budeme opět identifikovat pomocí pravých singulárních vektorů a distribuce singulárních čísel rozšířené matice $[B | A]$. Uvažujme tedy singulární rozklad

$$[B | A] = U \Sigma V^T \quad (7)$$

a

$$\begin{aligned} \sigma_1 \geq \dots \geq \sigma_p > \sigma_{p+1} = \dots = \sigma_{n+1} = \dots \\ = \sigma_{n+e} > \sigma_{n+e+1} \geq \dots \geq \sigma_{n+d} \geq 0 \end{aligned} \quad (8)$$

singulární čísla matice $[B | A]$. Dále uvažujme následující dělení matice pravých singulárních vektorů

$$V = \left[\begin{array}{c|c|c} V_{11} & V_{12} & V_{13} \\ \hline V_{21} & V_{22} & V_{23} \end{array} \right], \quad (9)$$

kde $V_{11} \in \mathbb{R}^{d \times p}$, $V_{12} \in \mathbb{R}^{d \times (n-p+e)}$, $V_{13} \in \mathbb{R}^{d \times (d-e)}$, $V_{21} \in \mathbb{R}^{n \times p}$, $V_{22} \in \mathbb{R}^{n \times (n-p+e)}$, $V_{23} \in \mathbb{R}^{n \times (d-e)}$. (Pokud $\sigma_1 = \sigma_{n+1}$, pak $p = 0$ a σ_p , V_{11} a V_{21} neexistují, obdobně pokud $\sigma_{n+1} = \sigma_{n+d}$, pak $e = d$ a σ_{n+e+1} , V_{13} a V_{23} neexistují. V [5] je dělení matice (9) zavedeno jinak, bloky mají navíc jiné pořadí.) Platí následující věta.

Věta 2 *Necht' je dána lineární aproximační úloha (1). Uvažujme singulární rozklad (7), se značením zavedeným v (8)–(9).*

Necht' $\text{rank}([V_{12} | V_{13}]) = d$ a zároveň $p = n$ (tedy $[V_{12} | V_{13}]$ je čtvercová nesingulární matice). Pak úplný problém nejmenších čtverců (2) má řešení a toto řešení je jednoznačné.

Necht' $\text{rank}([V_{12} | V_{13}]) = d$ a zároveň $e = d$ (tedy všechna singulární čísla počínaje σ_{p+1} jsou si rovna).

Pak úplný problém nejmenších čtverců (2) má nekonečně mnoho řešení, lze zkonstruovat řešení minimální v normě (spektrální i Frobeniově).

Necht' $\text{rank}([V_{12}|V_{13}]) < d$. Pak úplný problém nejmenších čtverců (2) nemá řešení.

Důkaz viz [5]. V případě, že $\text{rank}([V_{12}|V_{13}]) < d$, lze vždy zkonstruovat jednoznačné negenerické řešení, viz [4, 5].

Všimněme si, že zatímco Věta 1 říká, že existence řešení je ekvivalentní s nenulovostí jistého bloku matice V , Věta 2 pouze implikuje existenci řešení ve dvou speciálních případech.

3.2. Revize analýzy úloh s více pravými stranami

Případ

$$\text{rank}([V_{12}|V_{13}]) = d, \quad p < n, \quad e < d \quad (10)$$

není z hlediska řešitelnosti ve smyslu Definice 1 v nám známé literatuře vůbec analyzován. Obvykle je tento případ interpretován následujícím způsobem: Protože aproximační úloha (1) je chápána jako *perturbace* původně *kompatibilního systému*, jsou všechna singulární čísla, tedy i $\sigma_{n+e+1}, \dots, \sigma_{n+d}$, zatížena chybou. Nahradíme-li tato singulární čísla čísla $\tilde{\sigma}_{n+e+1}, \dots, \tilde{\sigma}_{n+d}$ rovnými σ_{n+1} , zredukujeme obecný případ (10) vždy na druhý speciální případ popsaný Větou 2, tzv. *truncated TLS* koncept, viz např. [5, poslední odstavec na str. 77]. Tím může být diskuze o existenci řešení uzavřena. S touto myšlenkou pak přirozeně koresponduje fakt, že klasický přístup, prezentovaný např. v [5], pracuje téměř výhradně s celým blokem $[V_{12}|V_{13}]$. Chceme-li ovšem diskutovat řešitelnost problému (2) obecně, bez uvažování dalších perturbací úlohy, musíme provést jemnější analýzu úlohy s více pravými stranami. Pro potřeby této analýzy navrhujeme pracovat s bloky V_{12} a V_{13} odděleně.

Analýzu provedeme pro nejobecnější případ úlohy (1) splňující podmínku $\text{rank}([V_{12}|V_{13}]) = d$. Speciální případy úloh popsaných Větou 1 (úlohy s jednou pravou stranou) a Větou 2 přirozeně vyplnou jako případy se speciálními hodnotami d , p a nebo e . Snadno nahledneme, že matice $V_{13} \in \mathbb{R}^{d \times (d-e)}$ nemůže mít za předpokladu $\text{rank}([V_{12}|V_{13}]) = d$ rank větší než $d - e$, z čehož vyplývá, že matice $V_{12} \in \mathbb{R}^{d \times (n-p+e)}$ nemůže mít rank menší než e . Plný (řádkový) rank matice $[V_{12}|V_{13}]$ je tak možno mezi bloky V_{12} a V_{13} „rozdělit“ třemi různými způsoby. Když $\text{rank}(V_{12}) = e$, pak nutně V_{13} musí mít plný (sloupcový) rank, tedy $\text{rank}(V_{13}) = d - e$, opačná implikace ovšem neplatí. Může se tedy stát, že $\text{rank}(V_{13}) = d - e$ a a zá-

roveň $\text{rank}(V_{12}) > e$. Třetí a poslední možností je, že matice V_{13} nebude mít plný (sloupcový) rank, tedy $\text{rank}(V_{13}) < d - e$, pak ale nutně $\text{rank}(V_{12}) > e$. Klasifikaci úloh zpřehlední následující definice.

Definice 2 *Uvažujme značení zavedené v (7)–(9). Množinu všech úloh (1), které splňují podmínku $\text{rank}([V_{12}|V_{13}]) = d$, označíme \mathcal{F} . Množinu všech úloh (1), které podmínku $\text{rank}([V_{12}|V_{13}]) = d$ nesplňují, označíme \mathcal{S} . Dále*

- množinu všech úloh z \mathcal{F} , pro něž $\text{rank}(V_{12}) = e$ (a tedy $\text{rank}(V_{13}) = d - e$), označíme \mathcal{F}_1 .
- Množinu všech úloh z \mathcal{F} , pro něž $\text{rank}(V_{13}) = d - e$ a zároveň $\text{rank}(V_{12}) > e$, označíme \mathcal{F}_2 .
- Množinu všech úloh z \mathcal{F} , pro něž $\text{rank}(V_{13}) < d - e$ (a tedy $\text{rank}(V_{12}) > e$), označíme \mathcal{F}_3 .

Množiny \mathcal{F}_1 , \mathcal{F}_2 , \mathcal{F}_3 a \mathcal{S} jsou zřejmě disjunktní a zřejmě platí $\bigcup_{j=1}^3 \mathcal{F}_j = \mathcal{F}$. Úlohy mající řešení ve smyslu Definice 1 popsané Větou 1 (případ $d = 1$) a Větou 2 (případy $p = n$ nebo $e = d$) vždy splňují podmínku $\text{rank}(V_{12}) = e$, patří tedy do množiny \mathcal{F}_1 . V [8] bylo ukázáno, že platí následující věta zobecňující toto pozorování.

Věta 3 *Necht' je dána lineární aproximační úloha (1). Uvažujme singulární rozklad (7), se značením zavedeným v (8)–(9). Předpokládejme $\text{rank}([V_{12}|V_{13}]) = d$.*

Je-li daná úloha z množiny \mathcal{F}_1 (tedy pokud $\text{rank}(V_{12}) = e$), pak úplný problém nejmenších čtverců (2) má řešení. Má-li úloha více než jedno řešení, pak lze zkonstruovat řešení minimální v normě (spektrální i Frobeniově).

Je-li daná úloha z množiny \mathcal{F}_2 (tedy pokud $\text{rank}(V_{13}) = d - e$ a zároveň $\text{rank}(V_{12}) > e$), pak úplný problém nejmenších čtverců (2) má řešení.

Je-li daná úloha z množiny \mathcal{F}_3 (tedy pokud $\text{rank}(V_{13}) < d - e$), pak úplný problém nejmenších čtverců (2) nemá řešení.

Naznačíme pouze základní myšlenku důkazu, úplný důkaz viz [8]. Lze ukázat, že existence řešení úplného problému nejmenších čtverců je ekvivalentní s existencí ortogonální matice $W \in \mathbb{R}^{(n-p+e) \times (n-p+e)}$ takové, že $V_{12}W = [\Delta|\Gamma_1]$, $\Gamma_1 \in \mathbb{R}^{d \times e}$, kde čtvercová matice $\Gamma \equiv [\Gamma_1|V_{13}]$ je *nesingulární*. Pro úlohy z množiny $\mathcal{F}_1 \cup \mathcal{F}_2$ vždy taková matice W existuje. Navíc pro úlohy z množiny \mathcal{F}_1 vždy existuje $W = W_0$ taková,

že $\Delta = 0$; jejím užitím konstruujeme řešení minimální v normě, které je jednoznačné (nezávislé na volbě W_0). Pro úlohy z množiny \mathcal{F}_2 je $\Delta \neq 0$ pro libovolné W ; existence a případná jednoznačnost řešení minimálního v normě zatím *není jasná*. Pro úlohy z množiny \mathcal{F}_3 zřejmě žádná matice W dávající nesingulární Γ neexistuje.

Oproti tomu řešení úlohy z množiny \mathcal{F} spočtené TLS algoritmem je jednoznačně určeno libovolnou ortogonální maticí $\bar{W} \in \mathbb{R}^{(n-p+d) \times (n-p+d)}$ takovou, že $[V_{12} | V_{13}] \bar{W} = [0 | \bar{\Gamma}]$, kde čtvercová matice $\bar{\Gamma}$ je nesingulární. Taková matice \bar{W} existuje pro libovolnou úlohu z množiny \mathcal{F} . Pro úlohy z množiny \mathcal{F}_1 TLS algoritmus spočte právě řešení problému (2) minimální

v normě (např. $\bar{W} = \text{diag}(W_0, I_{d-e})$). Dále lze ukázat, že řešení libovolné úlohy z množiny $\mathcal{F}_2 \cup \mathcal{F}_3$ vypočtené TLS algoritmem není řešením odpovídajícího problému (2); má charakter negenerického řešení, které TLS algoritmus vrátí i pro úlohy z množiny \mathcal{S} . (Zde je třeba dát pozor na užitou terminologii, např. v [5] se termínu negenerické řešení používá výhradně v kontextu úloh z množiny \mathcal{S} , v [8] a také zde se o negenerickém řešení hovoří navíc i v kontextu úloh z množiny $\mathcal{F}_2 \cup \mathcal{F}_3$). Negenerické řešení není řešením úlohy (2) ve smyslu Definice 1.

Vzájemný vztah mezi vlastnostmi dané úlohy a existencí řešení problému (2) a řešením spočteným TLS algoritmem shrnuje následující schema.

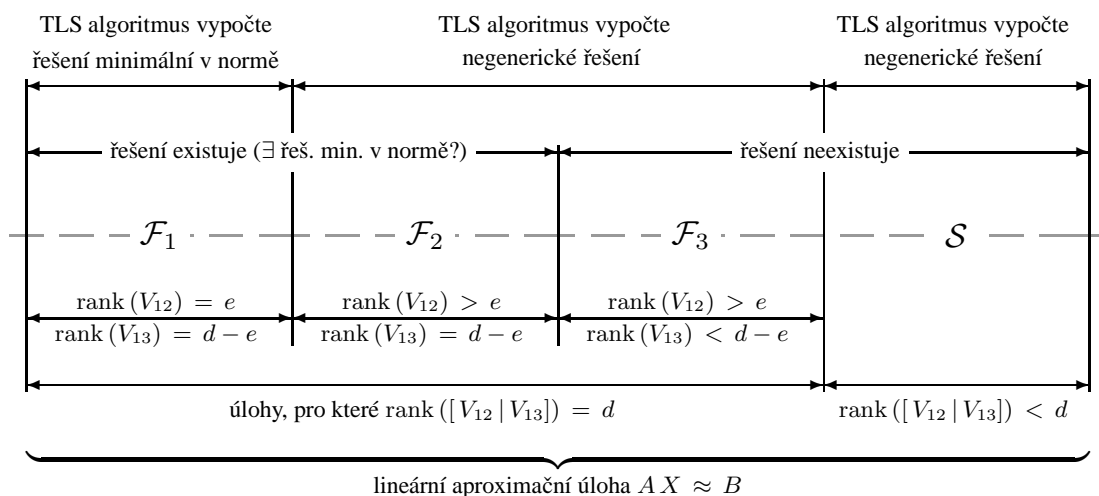

4. Závěr

Zda je pro úlohy z množiny \mathcal{F}_2 smysluplnější preferovat skutečné řešení problému (2), které vždy existuje, či řešení negenerické vypočtené pomocí TLS algoritmu, není zatím jasné. Obdobně význam samotného negenerického řešení pro $d > 1$ není příliš zřejmý.

Užitím datové redukce, která zobecňuje pojem core problému pro úlohy s $d \geq 1$, viz [8], lze v jistých typických případech (analogických s úlohami s jednou pravou stranou) smysluplnost negenerického řešení interpretovat obdobně jako v případě $d = 1$. Zda mezi tyto případy mohou patřit i úlohy z množiny \mathcal{F}_2 zatím není jasné.

Na druhou stranu je v [8] ukázáno, že existuje celá třída problémů, pro něž vykazuje koncept negenerického řešení ne zcela uspokojivé chování. Ilustrujme tento jev na příkladu.

Příklad 1 Uvažujme dvě (nezávislé) úlohy (1) s jednou

pravou stranou, které jsou dány ve formě core problémů

$$A_{11}^I x_1^I \approx b_1^I, \quad A_{11}^{II} x_1^{II} \approx b_1^{II}$$

a mají tedy dle [6] jednoznačné řešení. Předpokládejme, že

$$\sigma_{\min}([b_1^I | A_{11}^I]) > \sigma_{\max}([b_1^{II} | A_{11}^{II}]).$$

Jinak řečeno, všechna singulární čísla prvního core problému jsou ostře větší než největší singulární číslo druhého core problému. V [8] je ukázáno, že rozšířená matice aproximačního problému

$$\left[\begin{array}{c|c} A_{11}^I & 0 \\ \hline 0 & A_{11}^{II} \end{array} \right] X \approx \left[\begin{array}{c|c} b_1^I & 0 \\ \hline 0 & b_1^{II} \end{array} \right], \quad (11)$$

má minimální dimenzi a představuje tak analogii core problému v dané úloze se dvěma pravými stranami. Dále je v [8] ukázáno, že TLS algoritmus aplikován na (11) vrátí negenerické řešení

$$X = \left[\begin{array}{c|c} x_1^I & 0 \\ \hline 0 & 0 \end{array} \right],$$

namísto intuitivně očekávaného

$$X = \left[\begin{array}{c|c} x_1^I & 0 \\ \hline 0 & x_1^{II} \end{array} \right].$$

Zde prezentovaná analýza a dosavadní výsledky naznačují, že zdánlivě elementární formulace úplného problému nejmenších čtverců (2) pro úlohy s více pravými stranami je mnohem komplikovanější a komplexnější než je tomu u úloh s jednou pravou stranou. Vzhledem k tomu, že existuje reálná potřeba řešit aproximační úlohy s více pravými stranami (např. multi-input multi-output dynamické systémy v teorii řízení), bude třeba dalšího studia dané problematiky.

Literatura

- [1] G. H. Golub, C. F. Van Loan, “An analysis of the total least squares problem”, *Numer. Anal.* vol. 17, pp. 883–893, 1980.
- [2] I. Hnětynková, Z. Strakoš, “Lanczos tridiagonalization and core problems”, *Linear Algebra Appl.*, vol. 421, pp. 243–251, 2007.
- [3] I. Hnětynková, M. Plešinger, Z. Strakoš, “Lanczos tridiagonalization, Golub-Kahan bidiagonalization and core problem”, *PAMM, Proc. Appl. Math. Mech.* 6, pp. 717–718, 2006.
- [4] S. Van Huffel, “Documented Fortran 77 programs of the extended classical total least squares algorithm, the partial singular value decomposition algorithm and the partial total least squares algorithm”, *Internal. Report ESAT-KUL 88/1*, ESAT Lab., Dept. of Electrical Engrg., Katholieke Universiteit Leuven, 1988.
- [5] S. Van Huffel, J. Vandewalle, “The Total Least Squares Problem, Computational Aspects and Analysis”, *SIAM Publications*, 1991.
- [6] C. C. Paige, Z. Strakoš, “Core problem in linear algebraic systems”, *SIAM J. Matrix Anal. Appl.* vol. 27, pp. 861–875, 2006.
- [7] M. Plešinger, Z. Strakoš, “Core problém v úlohách nejmenších čtverců”, *Sborník konference: Doktorandský den '05, ÚI AV ČR*, pp. 102–108, 2005.
- [8] M. Plešinger, I. Hnětynková, D. M. Sima, Z. Strakoš, S. Van Huffel, “The total least squares problem and reduction of data in $AX \approx B$ ”, *work in progress*.

Jazyk lékařských zpráv

doktorand:

MGR. PETRA PŘEČKOVÁ

Oddělení medicínské informatiky
Ústav informatiky AV ČR, v. v. i.
Pod Vodárenskou věží 2

182 07 Praha 8

preckova@euromise.cz

školitel:

PROF. RNDR. JANA ZVÁROVÁ, DRSC.

Oddělení medicínské informatiky
Ústav informatiky AV ČR, v. v. i.
Pod Vodárenskou věží 2

182 07 Praha 8

zvarova@euromise.cz

obor studia:
Biomedicínská informatika

Článek vzniknul s podporou grantu 1ET200300413.

Abstrakt

Cílem této práce je lexikální analýza textových lékařských zpráv a dále porovnání informace obsažené v textových lékařských zprávách s informací obsaženou ve strukturované zdravotní dokumentaci uložené s použitím softwarové aplikace ADAMEK. Informace obsažená v textových zprávách je porovnávána se strukturovanou informací podle Minimálního datového modelu pro kardiologii.

Klíčová slova: kardiologie, textové lékařské zprávy, informace, minimální datový model.

1. Úvod

Hlavním tématem tohoto článku jsou textové lékařské zprávy a zejména jejich lexikální analýza. K analýze byly použity textové lékařské zprávy ze vstupních vyšetření, kontrolních vyšetření a propouštěcí zprávy z různých časových období. Hlavní důraz byl kladen na zapisování znaků spojených s kardiologií a zejména na znaky z Minimálního Datového Modelu Kardiologického pacienta (MDMK), který byl vytvořen v rámci výzkumného centra EuroMISE - Kardio v letech 2000-2004. Zapisování těchto znaků bylo v závěrečné fázi porovnáváno se strukturovanými lékařskými zprávami, zapisovanými pomocí softwarové aplikace ADAMEK (Aplikace Datového Modelu EuroMISE centra - Kardio), používané v ambulanci preventivní kardiologie, umístěné v budově Ústavu informatiky AV ČR, v.v.i.

2. Minimální datový model pro kardiologii

Minimální datový model kardiologického pacienta [1], [2] je výsledkem dlouhodobého procesu. Jelikož je kardiologie velice rozsáhlý obor, MDMK je zúžen na aterosklerotická kardiovaskulární onemocnění. Cílem MDMK bylo vytvořit minimální soubor znaků, které je potřeba u každého pacienta z pohledu kardiologie sledovat, aby mohl být pacient zařazen mezi osoby nemocné či rizikové a to z hlediska arteriálních kardiovaskulárních onemocnění.

Mezi znaky MDMK patří nezbytné administrativní

údaje. Ty ale nejsou do analýzy zahrnuty, jelikož lékařské zprávy, které byly analyzovány, byly anonymizované a tudíž bez administrativních údajů.

Dále mezi údaje MDMK patří znaky týkající se rizikových faktorů. U některých rizikových faktorů je důležité nejenom konstatování, zda je nebo není přítomen, ale je potřebná i jeho kvantifikace. Například tělesná aktivita má pozitivní účinek na snížení celkového kardiovaskulárního rizika. Alkohol má ambivalentní účinek. V malých dávkách snižuje kardiovaskulární riziko, ale naopak ve vyšších dávkách ho zvyšuje. Ještě výraznější účinek mají léky. Důležité ale bývají také časové vztahy.

MDMK se skládá z osmi skupin znaků. Na začátku je rodinná anamnéza, následuje sociální anamnéza a toxikomanie, osobní anamnéza, současné obtíže možného kardiálního původu, dosavadní léčba, fyzikální vyšetření a blok parametrů EKG.

Na základě MDMK byla vytvořena softwarová aplikace ADAMEK (Aplikace Datového Modelu EuroMISE centra - Kardio). Po jejím dokončení byl od března 2002 zahájen sběr dat v ambulanci preventivní kardiologie EuroMISE centra, umístěné v ústavu informatiky AV ČR, v.v.i.

3. Jazyk textových zpráv

Styl zapisování textových zpráv není nijak standardizován. Rozdíly najdeme nejenom ve zprávách od různých

lékařů, ale i jednotliví lékaři často zapisují stejné koncepty v různých tvarech. V následující části se zaměříme na již zmíněné jazykové, lexikální, rozdíly v lékařských zprávách.

Diakritika: Někteří lékaři zapisují text bez použití diakritiky, např. "Bricho mekke nebolestive". Většina z nich diakritická písmena ale používá.

Překlepy: Větším problémem jsou překlepy, které jsou velmi časté a text je potom dále velmi těžce použitelný pro strojové zpracování.

Mezery: Podobnou záležitostí je i vynechávání mezer mezi slovy, kdy se ze dvou slov stává jedno slovo, jako například "pivopřestal". Lékaři se různí v zapisování mezer před jednotkami. Můžeme se setkat jak s tvarem s mezerou, např. "2,5 mg", tak i s tvarem bez mezery, např. "4mg". Tak to je i s tvary, kde se používá lomítko. Někteří lékaři používají variantu bez mezer, např. "80/min", jiní variantu s mezerami "70 / min".

Číslice 0: Pro strojové zpracování je také složité, když někteří lékaři používají místo číslice 0 velké písmeno O.

Zkratky: Jelikož lékaři mívají málo času na zapisování zpráv, dochází ke zkracování slov. Zkrácené tvary ale bývají různě dlouhé, například kyselina močová bývá zkracována jako kys. moč., kys. močová nebo KM. Může se stát, že v jedné a té samé zprávě je slovo zkráceno dvakrát a pokaždé jinak. Se zkrácenými tvary souvisí také to, že se setkáváme s vynecháním tečky za zkráceným slovem, např. "levostr kard insuf."

Zaokrouhlování: Další část, ve které můžeme nalézt mnoho rozdílů, souvisí s číselnými hodnotami. Zde se můžeme například setkat u stejného znaku u jednoho lékaře se zaokrouhlováním hodnot na celá čísla, u jiného lékaře s uváděním hodnot nezaokrouhlených, s přesností na jedno nebo dvě desetinná čísla. Někdy jsou číselné hodnoty znaku uváděné jako rozmezí, např. "70-80". Častokrát bývá zadán pouze přibližný údaj, například "diastolický tlak kolem 70". U některých znaků nejsou hodnoty vyjádřeny číslem, ale pouze slovně, např. "tlak je zcela v mezích normy".

Římské a arabské číslice: Rozdíl je i v používání římských a arabských číslic. Například u zápisu o srdečních ozvách lze najít jak tvar "ozvy 2", tak i "ozvy II".

Synonyma: Český jazyk je velmi bohatý na synonyma a ta nacházíme i v lékařských zprávách. Jako příklad uved' me dolní končetiny versus nohy, hmotnost versus váha, iregulární versus nepravidelný, praktický lékař versus obvodní lékař versus prakt. lékař versus PL versus OL. Tepová frekvence bývá zapsána třemi různými

způsoby: tep versus P versus fr. a mnoho dalších.

Pravopis: Někteří lékaři používají starší formy pravopisu, někteří novější, takže se můžeme setkat např. se znakem "cyanóza", "cyanosa", ale i "cyanoza" nebo "hyperlipoproteinemie", ale i "hyperlipoproteinémie".

Časové údaje: Ani zaznamenávání časových údajů není sjednoceno. V lékařských zprávách se objevuje jak název měsíce, např. "únor 2006", tak i pořadí měsíce, např. "2/2006".

Podávání léků: Velmi odlišné je i zapisování rozpisu podávání léků. Stejná informace, kdy jedna tableta léku má být podávána ráno, bývá zapsána takto: 1 ráno, 1x ráno, 1-0-0, 1 tabl. ráno. Setkáváme se i s pouze slovním vyjádřením dávkování, jako například "jen zřídka", "tabletu vezme až v poledne", "denně", "obd", "příležitostně", "při bolesti", "dle hodnot QT".

Hodnoty znaků: Často jsou stejné hodnoty znaku zapisovány řadou různých způsobů. Například:

- Hodnota znaku diabetes mellitus bývá zapsána jako: diabet, diabet., diabetes mellitus 2. typu, diabetička 2. typu na dietě, diabetes mellitus II. typu na dietě, DM 2. typu, DM 2. typu.
- Dolní končetiny bez otoků můžeme nalézt zapsané těmito způsoby: otoky DK nepozoruje, DK bez otoků, DK - bez otoků, DK neotékají, DK bez otoku, DK otoky 0. Přitom se jedná stále o tu samou informaci.
- Když hledáme v textových zprávách informace o dušnosti, najdeme tyto tvary: není dušná, není dušn, dušnost nepozoruje, dušnost neudává, bez dušnosti.
- Jak už jsme se dříve zmínili v souvislosti se synonymy, u hmotnosti bývají tyto informace: hmotnost 86 kg, V 86 kg, váha 86 kg, vaha 86 kg.
- Při studiu textových lékařských zpráv bylo nalezeno pět možností, jak bývá zapsáno, že je srdeční akce pravidelná: akce srd. prav., AS pravid., AS prav., akce pr. a cor- AS pravid.
- Triacylglyceroly bývají v textových lékařských zprávách zkracovány jako Tg, Tgl nebo TAG.

Z této lexikální analýzy vyplývá, že vymezení, pojmenování a třídění lékařských pojmů není optimální. Pro jeden pojem často existuje mnoho synonym. Tato nedostatečná standardizace v medicínské terminologii je velkým problémem pro další zpracování biomedicínských dat. Obecně je velmi výhodné využívat v odborné terminologii pro jeden pojem vždy pouze jediný výraz. Synonymie v odborné terminologii vede při sdělování informací navíc k nepřesnostem a nedorozumění.

4. Mezinárodní klasifikační systémy

Aby došlo k omezení variability vyjadřování, vznikají kódovací systémy, které používají namísto schválených termínů formální kódy. Vhodný kódovací systém tak rychle poskytne kód pro libovolný biomedicínský poznatek v případě, že je u daného pacienta známý. Klasifikační systémy jsou takové kódovací systémy, které jsou založeny na principu vytváření tříd. Třídy tvoří agregované pojmy, které se shodují v alespoň jednom klasifikačním znaku. Třídy klasifikace musí pokrývat úplně vymezenou oblast a nesmí se překrývat. Tvorba klasifikačních systémů byla motivována především jejich praktickým využitím v evidenci, třídění a statistickém zpracování lékařské informace. Mezi nejznámější mezinárodní klasifikační systémy patří například Mezinárodní klasifikace nemocí (MKN), Systematized Nomenclature of Medicine (SNOMED), SNOMED Clinical Terms (SNOMED CT), Medical Subject Headings (MeSH), Logical Observations Identifiers, Names, Codes (LOINC) a mnoho dalších, více než sto, klasifikačních systémů.

Rostoucí počet těchto klasifikačních systémů si vyžádal vytváření různých konverzních nástrojů pro převod mezi hlavními klasifikačními systémy a pro zachycení vztahů mezi termíny v těchto systémech. Nejrozsáhlejším projektem tohoto druhu v dnešní době je Unified Medical Language System (UMLS) [3], [4], [5].

Velkým problémem při využití klasifikačních systémů ve zdravotnictví v České republice zůstává neexistence českých klasifikačních systémů či jejich vhodných českých překladů a z tohoto důvodu je potřeba termíny nejprve překládat, zejména do anglického jazyka, pro který je většina klasifikačních systémů vytvořena.

Mapování terminologie v aplikacích elektronického zdravotního záznamu na mezinárodně používané klasifikační systémy je základem pro interoperabilitu heterogenních systémů elektronického zdravotního záznamu.

5. Analýza znaků MDMK v textových lékařských zprávách

V analýze textových lékařských zpráv se vycházelo ze znaků Minimálního datového modelu kardiologického pacienta. Jak už bylo uvedeno výše, lékařské zprávy byly anonymizované a z tohoto důvodu nebylo možné analyzovat administrativní data.

Když se podíváme na jednotlivé znaky, tak pouze *diastolický a systolický tlak* jsou zaznamenány ve všech textových lékařských zprávách, které byly analyzovány. V

96,30 % textových lékařských zprávách jsou zaznamenány *léky*, které pacient užívá nebo které lékař nově předepisuje. *I hmotnost* je zaznamenána v 96,30 % zpráv. Oproti tomu *výška* už pouze v 74,07 % zpráv. V analyzovaných textových zprávách se některé znaky MDMK neobjevily ani v jednom případě. Jedná se například o tyto znaky: *aneurysma aorty*, *angína pectoris*, *blokáda ramének*, *endarterektomie karotid*, *hyperkalemie*, *ICHDK*, *ischemická CMP*, *kdy zjištěn DM*, *kdy zjištěna HLP*, *manifestní onemocnění periferních tepen (jiných než ICHDK)*, *medikamentózní léčba HPL*, *měštnavé srdeční selhání*, *němá ischemie*, *porevmatická chlopněvada*, *síňokomorová blokáda* a *tělesná teplota*. *Alergie na lék* je zmíněná ve 22,22 % zpráv, to, zda pacient pije nebo nepije *alkohol* v 51,85 % zpráv, *bolesti na hrudi* v 37,04 %. *Celkovou psychickou zátěž* zaznamenává 11,11 % zpráv, *fyzickou zátěž v zaměstnání* 11,11 % zpráv, *celkový cholesterol* 70,37 %, *pití černé kávy* 22,22 %, *různá další vyšetřování* 62,96 %. *Dechová frekvence* byla nalezena ve 3,7 % zpráv, *diabetes mellitus* ve 40,74 %, *dieta* u 59,26 %, *glykémie* u 51,85 %, *HDL cholesterol* u 66,67 %. Se zaznamenáním přítomnosti/nepřítomnosti *hypertenze* jsme se mohli setkat u 70,37 %, *hypertrofií levé komory* u 11,11 %, s *infarktem myokardu* u 14,81 %, s *průměrným množstvím cigaret u kuřáka* u 51,85 % a tak dále.

Lze tedy říci, že při zapisování výsledků vyšetření pomocí volného textu zůstává plno znaků nezaznamenáno. K tomu může docházet z několika důvodů. Lékaři nemají přesně danou osnovu, podle které by měli postupovat a může se stát, že na některé znaky mohou zapomenout. V softwarových aplikacích je tomuto problému zabráněno tak, že pokud lékař nevyplní žádanou položku, program mu nedovolí pokračovat. Další důvod, proč nejsou některé znaky v textové zprávě zaznamenány, může být fakt, že lékařům ze znalosti předchozích znaků vyplyne, že další znak nemůže být přítomen a proto se již na něj dále nezeptají a nezaznamenají ho. Z textové zprávy ale nevyplyne, zda skutečně byly u pacienta zjištěny tyto základní informace, z jejichž hodnot lékaři hodnoty dalších znaků sami svými znalostmi vyvodili.

6. Softwarová aplikace ADAMEK

Jedním z cílů, na které se v poslední době v oblasti biomedicínské informatiky soustředí stále větší úsilí, je vytvoření databázových systémů společně se softwarovými nástroji, které by mohly analyzovat získané údaje. A tak i po zformování Minimálního datového modelu kardiologického pacienta vyvstala přirozená potřeba sbírat data o pacientech v souladu s tímto modelem. Navíc, aby tato data byla dobře použitelná pro ná-

sledné statistické či jiné zpracování a vyhodnocování, bylo žádoucí, aby tato data byla sbírána jednotným způsobem. Z tohoto důvodu byla vytvořena aplikace ADAMEK (Aplikace datového modelu EuroMISE - Kardio) [6], [7]. Byla sice snaha tvořit aplikaci ADAMEK jako systém, který by mohl sloužit pro vedení elektronické zdravotní dokumentace v kardiologických ambulancích zařízeních, ale není to její primární určení. Z tohoto důvodu v ní nejsou implementovány žádné funkce či nástroje výkaznictví pro zdravotní pojišťovny, statistické nástroje a řada dalších funkcí.

Celý záznam o pacientovi je rozdělen do části administrativa, rodinná anamnéza, sociální anamnéza, alergie, osobní anamnéza, obtíže, léčba, fyzikální vyšetření, laboratorní vyšetření a EKG.

7. Analýza znaků MDMK v softwarové aplikaci ADAMEK

Pro analýzu bylo využito 1118 lékařských zpráv z ambulance preventivní kardiologie EuroMISE centra.

Ve všech lékařských zprávách, tedy ve 100 %, byla zaznamenána například *alergie na lék*, *aneurysma aorty*, *angína pectoris*, *bolest na hrudi*, *otoky dolních končetin*, *dušnost*, *hypertrofie levé komory*, *infarkt myokardu*, *ischemická CMP*, *jiná alergie*, *kašel po ACE inhibitory*, *klaudikace*, *němá ischemie*, *systolický tlak*, *typ léčby diabetu*. Již z tohoto výčtu je patrné, že pomocí softwarové aplikace je zaznamenáváno daleko větší množství znaků.

Při porovnání zápisu jednotlivých znaků v textové a strukturované lékařské zprávě, dojdeme například k těmto výsledkům. Alergie na lék je v textových lékařských zprávách zaznamenána ve 22,22 %, v aplikaci ADAMEK ve všech, tedy 100 %, zpráv. Odpověď, zda pacient má nebo nemá *aneurysma aorty*, byla v aplikaci ADAMEK vyplněna ve všech zprávách, ale v žádné textové lékařské zprávě. Na *bolest na hrudi* se lékaři, vyplňující lékařskou zprávu pomocí aplikace ADAMEK, zeptali ve všech případech, v textových lékařských zprávách pouze 37,04 % obsahuje zmínku o bolesti na hrudi. *Celková psychická zátěž* byla vyplněna u 96,15 % zpráv v aplikaci ADAMEK, v textových lékařských zprávách to bylo 11,11 %. Stejného procenta zaznamenání v textových lékařských zprávách bylo dosaženo u znaku *fyzická zátěž v zaměstnání*, v aplikaci ADAMEK to bylo v 94,81 %. *Celkový cholesterol* byl ve zprávách aplikace

ADAMEK uveden u 83,36 % zpráv, v textových lékařských zprávách to bylo v 70,37 %. Přítomnost nebo nepřítomnost *diabetu mellitu* byla v softwarové aplikaci vyplněna u 95,89 % lékařských zpráv, u textových lékařských zpráv to bylo 40,74 %. *Glykémie* je v aplikaci ADAMEK uvedena u 77,64 % zpráv, v 51,85 % v textových lékařských zprávách. *Cholesterol* je zaznamenán v softwarové aplikaci v 917 zprávách, což je v 82,02 %, zatímco v textových lékařských zprávách se se zaznamenáním tohoto znaku můžeme setkat v 66,67 % analyzovaných zpráv. Nejbližší k sobě mají oba druhy zpráv u *hmotnosti*, která je v aplikaci ADAMEK zapsána u 97,94 % zpráv a v textových lékařských zprávách v 96,30 %. Se zaznamenáním přítomnosti či nepřítomnosti *hypertenze* se setkáme v 95,26 % zpráv z aplikace ADAMEK, zatímco v textových lékařských zprávách pouze v 70,37 % případů. Velký rozdíl nalezneme například u *hypertrofie levé komory*, která je v lékařských zprávách aplikace ADAMEK zapsána ve všech případech, ale pouze v 11,11 % textových lékařských zpráv nebo *menopauza*, která je v aplikaci ADAMEK uvedena v 96,87 % zpráv a pouze v 7,40 % v textových lékařských zprávách. *Interval PQ* je v lékařských zprávách zapsaných pomocí softwarové aplikace zaznamenán v 89,09 % a v textových lékařských zprávách v 62,96 %, obdobně i *interval QRS* je ve strukturovaných zprávách aplikace ADAMEK zaznamenán v 89,53 % a v textových lékařských zprávách v 66,67 %.

V tabulce 1 je přehledně zobrazeno procentuální vyjádření o zaznamenaných hodnotách vybraných znaků MDMK v 1118 lékařských zprávách při užití softwarové aplikace ADAMEK a ve 27 textových lékařských zprávách.

8. Závěr

Analýzou textových lékařských zpráv bylo zjištěno, že zapisování pomocí volného textu je velice nehomogenní a nestandardizované. Největšími problémy pro další počítačové zpracování jsou překlady, různá délka zkracovaných výrazů a používání synonym.

Při porovnání textových lékařských zpráv s lékařskými zprávami zapisovanými pomocí aplikace ADAMEK bylo zjištěno, že pomocí softwarové aplikace jsou jednotlivé znaky Minimálního datového modelu kardiologického pacienta zaznamenávány u významně vyššího procenta pacientů, než je tomu při užití volného textu lékařských zpráv.

znak MDMK	aplikace ADAMEK	textové lékařské zprávy	textové lékařské zprávy 95% interval spolehlivosti	
			dolní mez	horní mez
	$n = 1118$	$n = 27$		
alergie na lék	100	22,22	8,62	42,3
aneurysma aorty	100	0	0	12,8
angína pectoris	100	0	0	12,8
bolest na hrudi	100	37,04	19,4	57,6
celková psychická zátěž	96,15	11,11	2,35	29,2
celkový cholesterol (v mmol/l)	83,36	70,37	49,8	86,2
diabetes mellitus (ano, ne)	95,89	40,74	22,4	61,2
dušnost	100	55,56	35,3	74,5
fyzická zátěž v zaměstnání	94,81	11,11	2,35	29,2
glykémie	77,64	51,85	32	71,3
HDL cholesterol	82,02	66,67	46	83,5
hmotnost	97,94	96,30	81	99,9
hypertenze (ano, ne)	95,26	70,37	49,8	86,2
hypertrofie levé komory	100	11,11	2,35	29,2
ICHDK	94,45	0	0	12,8
infarkt myokardu	100	14,81	4,19	33,7
interval PQ	89,09	62,96	42,4	80,6
interval QRS	89,53	66,67	46	83,5
jiná alergie - na co	100	18,52	6,3	38,1
kašel po ACE inhibitorech	100	7,41	9,09	24,3
klaudikace	100	3,70	0,91	19
kuřák	96,51	66,67	46	83,5
tělesná aktivita mimo zaměstnání	93,29	29,63	13,8	50,2
tělesná teplota	14,85	0	0	12,8
tepová frekvence (za minutu)	95,44	77,78	57,7	91,4
triacylglyceroly	82,38	44,44	25,5	64,7
výška	97,67	74,07	53,7	88,9

Tabulka 1: Procentuální vyjádření zaznamenaných hodnot vybraných znaků MDMK v lékařských zprávách při užití aplikace ADAMEK a textových lékařských zpráv.

Literatura

- [1] Adášková J., Anger Z., Aschermann M., Bencko V., Berka P., Filipovský J., Goláš L., Grus T., Grünfeldová H., Haas T., Hanuš P., Hanzlíček P., Holcátová I., Hrach K., Jiroušek R., Kejřová E., Kocmanová D., Kolář J., Kotásek P., Králíková E., Krupařová M., Kyloušková M., Malý M., Mareš R., Matoulek M., Mazura I., Mrázek V., Novotný L., Novotný Z., Pecen L., Peleška J., Prázný M., Pudil P., Rameš J., Rauch J., Reissigová J., Rosolová H., Rousková B., Říha A., Sedlak P., Slámová A., Somol P., Svačina Š., Svátek V., Šabík D., Šimek S., Škvor J., Špidlen J., Štochl J., Tomečková M., Umnerová V., Zvára K., Zvárová J., "Návrh minimálního datového modelu pro kardiologii a softwarová aplikace ADAMEK. Interní výzkumná zpráva EuroMISE Centra - Kardio", Praha, Říjen 2002.
- [2] Tomečková M., "Minimální datový model kardiologického pacienta - výběr dat", Cor et Vasa, 2002, Vol. 44, No. 4 Suppl., s. 123.
- [3] Přečková P., "Mezinárodní nomenklatury a meta-tezaury ve zdravotnictví", Doktorandský den 2005. Praha, MATFYZPRESS 2005, s. 109–116.
- [4] Přečková P., Špidlen J., Zvárová J., "Usage of International Nomenclatures and Metathesauruses in Shared Healthcare in the Czech Republic", Acta Informatica Medica. Vol 13, No 4, 2005, pp. 201–205.
- [5] Přečková P., Zvárová J., Špidlen J., "International Nomenclatures in Shared Healthcare in the Czech Republic", Proceedings of 6th Nordic Conference on eHealth and Telemedicine. Helsinky, Finland. pp. 45–46.
- [6] Mareš R., Tomečková M., Peleška J., Hanzlíček P., Zvárová J., "Uživatelská rozhraní patientských databázových systémů - ukázka aplikace určené pro sběr dat v rámci Minimálního datového modelu kardiologického pacienta", Cor et Vasa, 2002, Vol. 44, No. 4 Suppl., s. 76.
- [7] Mareš R., "ADAMEK - uživatelská příručka", EuroMISE centrum - Kardio, 2002.

Redukce datových modelů

doktorand:

ING. MARTIN ŘIMNÁČ

Ústav informatiky AV ČR, v. v. i.

Pod Vodárenskou věží 2

182 07 Praha 8

rimnacm@cs.cas.cz

školitel:

ING. JÚLIUS ŠTULLER, CSC.

Ústav informatiky AV ČR, v. v. i.

Pod Vodárenskou věží 2

182 07 Praha 8

stuller@cs.cas.cz

obor studia:
Databázové systémy

Práce byla podpořena projektem č. 1ET100300419 programu Informační společnost (Tematického programu II Národního programu výzkumu v ČR: Inteligentní modely, algoritmy, metody a nástroje pro vytváření sémantického webu), záměrem AV0Z10300504 "Computer Science for the Information Society: Models, Algorithms, Applications" a projektem 1M0554 Ministerstva školství, mládeže a tělovýchovy ČR "Pokročilé sanační technologie a procesy".

Abstrakt

Příspěvek se zabývá aspekty optimalizace paměťových nároků binárního úložiště atributově anotovaných dat na základě transitivní redukce systému funkčních závislostí. Tento systém buď může být předem daný modelem, v tomto případě se ukazuje, že je možné optimalizaci použít jednorázově; a nebo tento model je inkrementálním způsobem odhadován a pak je vhodné již jednou naoptimalizované úložiště pouze upravovat opět inkrementálním způsobem. V poslední sekci se příspěvek zabývá rozбором nejednoznačnosti výsledku včetně detailního rozboru vlastností základních konfigurací částí modelu způsobující tuto nejednoznačnost. V neposlední řadě je analyzována složitost dílčích operací v úložišti.

1. Úvod a motivace

Studium principů paměti je v rámci psychologie studováno od středověku, 19. století přináší první experimenty s pamětí (Ebbinghaus), které byly následovány experimenty s pamětí v širším pojetí (Pavlov, Thorndike, Lashley), převážně z hlediska schopnosti učení se - již v této době byla studována vazba mezi pamětí jako prostředkem pro uchování znalostí a procesy učení jako způsoby pro vkládání nových znalostí. Paměť je obvykle dělena podle nejrůznějších kritérií, například podle trvání uchování znalosti (krátkodobá, dlouhodobá paměť), či podle její funkce (asociativní, sémantická, fonologická smyčka); ukazuje se však, že paměť funguje spíše jako jeden celek nežli propojení více bloků, každý odděleně reprezentující určitý typ paměti [1].

Mnohé z těchto hypotéz a experimentálních výsledků lze zúročit v oblasti umělé inteligence. Jednou z takových podoblastí je studium schopnosti paměti samostatně strukturovat uložené znalosti. Zcela jistě paměť musí vážit mezi svou kapacitou a časem, za který je možné hledanou znalost vybavit.

Stejným směrem se vydává i tento příspěvek, avšak místo paměti lidské používá pro paměť formalismu binárních matic [2], které mají přímou návaznost na for-

máty sémantického webu [3].

Předpokládáme, že uvažujeme atributově anotovaná data se známou strukturou popsanou schématem, či v případě, že schéma není dostupné, odhadnutou z dat [4, 5, 6]. Tato struktura necht' pokrývá minimálně množinu atributů včetně jejich aktivních domén a množinu platných funkčních závislostí; samotná data jsou pak uložena v úložišti jako instance funkčních závislostí. V mnohých případech je možné na základě tranzitivních pravidel redukovat množinu všech platných funkčních závislostí a tím i počet jejich instancí. Tato redukce podstatným způsobem ovlivňuje efektivitu uložení znalostí a tedy i kapacitu paměti nutnou pro uchování předmětných dat.

Mezními případy jsou reprezentace:

- *s minimální dobou vybavení* - pokrývající všechny platné funkční závislosti, příp. jejich instance
- *s minimálními nároky na paměť* - pokrývající minimální počet instancí funkčních závislostí, avšak bez možnosti dosažení finálního výsledku v jednom kroku

Tato problematika je známa z teorie grafů jako tranzi-

tivní redukce, příp. uzávěr grafu [7, 8]. Poznamenejme, výsledek tranzitivní redukce je nejednoznačný.

Příspěvek proto zavádí přídavné kritérium, jenž zajišťuje optimalizaci úložiště s ohledem na minimální nároky na kapacitu paměti při zachování veškerých znalostí. Takovou redukci je možné provést jak na úrovni instancí, tak na úrovni zobecněných popisů, v případě tohoto příspěvku redukcí množiny platných funkčních závislostí.

V případě, že použijeme inkrementální algoritmus pro odhad struktury dat [2], je nutné při jakékoli změně provést reoptimalizaci. Z tohoto důvodu příspěvek navrhuje detekovat pouze neoptimální části a provést nápravu inkrementálním způsobem.

Poslední část příspěvku ukazuje, že požadavek na minimální paměťové nároky sám o sobě nevede na jednoznačné řešení optimalizační úlohy. Víceznačnost výsledku může být omezena použitím libovolné z předepsaných konfigurací. Dílčí vlastnosti těchto konfigurací jsou analyzovány a následně porovnány.

1.1. Binární úložiště dat

Úložiště dat je systém pro uchování a následně vyhledávání dat. Úložiště \mathcal{R} vedle samotných dat \mathcal{I} obsahuje i jejich model \mathcal{M} . Úložiště, jehož všechna data \mathcal{I} splňují požadavky kladené modelem \mathcal{M} , se nazývá *konzistentní*.

Binární úložiště atributově anotovaných dat je úložiště, jehož data jsou uložena pomocí množiny implikací mezi elementy $e \in \mathcal{E}$ - dvojicemi atribut hodnota. Model \mathcal{M} pro potřeby tohoto příspěvku zahrnuje:

- množinu atributů \mathcal{A} ,
- množinu hodnot \mathcal{D}
- množinu aktivních domén jednotlivých atributů $\{\forall A \in \mathcal{A} : \mathcal{D}_\alpha(A) \subseteq \mathcal{D}\}$
- množinu platných (unárních) funkčních závislostí $\mathcal{F} \subseteq \mathcal{A} \times \mathcal{A}$, na jejichž základě je možné jednoznačně dovést hodnotu atributu na pravé straně z hodnoty atributu na levé straně.

Přepokládejme, že pro každý element $e \in \mathcal{E}$, atribut $A \in \mathcal{A}$ a hodnotu $v \in \mathcal{D}$ existuje index ke každému prvku jednoznačně přiřazující přirozené číslo. Pak je možné nadefinovat úložiště pomocí binárních matic namísto množin:

- matici instancí $\Phi = [\phi_{ij}]$

$$\phi_{ij} = \begin{cases} 1 & \text{pokud } e_i \rightarrow e_j \in \mathcal{I} \\ 0 & \text{jinak} \end{cases} \quad (1)$$

- matici funkčních závislostí $\Omega = [\omega_{ij}]$

$$\omega_{ij} = \begin{cases} 1 & \text{pokud } A_i \rightarrow A_j \in \mathcal{F} \\ 0 & \text{jinak} \end{cases} \quad (2)$$

- matici aktivních domén atributů $\Delta = [\delta_{ij}]$

$$\delta_{ij} = \begin{cases} 1 & \text{pokud } v_j \in \mathcal{D}_\alpha(A_i) \\ 0 & \text{jinak} \end{cases} \quad (3)$$

Úložiště je pak možné definovat jako:

$$\mathcal{R} = [\Phi, \mathcal{M}], \text{ kde } \mathcal{M} = [\Omega, \Delta, \mathcal{A}, \mathcal{D}] \quad (4)$$

Úložiště je konzistentní, pokud implikace Φ pokrývají pouze instance funkčních závislostí Ω , tedy

$$\forall \phi_{ij} = 1 : \phi'_{ij} = 1, \text{ kde } [\phi'_{ij}] = \Delta \Omega \Delta^T \quad (5)$$

Objekty necht' jsou popsány pomocí množiny elementů $t \subset \mathcal{E}$. V dalším textu se omezme na popis objektů stejného druhu, tj. každý objekt je popsán pomocí všech atributů $A \in \mathcal{A}$ a prázdné hodnoty nejsou přípustné. Navíc (jako silnější podmínku) požadujeme, aby každý atribut byl v záznamu t pokryt právě jedním elementem (tj. v rámci záznamu nelze dělit neatomické atributy)

$$\forall t : ||t|| = ||\mathcal{A}|| \quad (6)$$

$$\forall t : \forall e_i \in t \nexists e_j \in t, e_j \neq e_i : \mathcal{A}(e_i) = \mathcal{A}(e_j)$$

Toto omezení mimo jiné přináší:

$$\forall \omega_{ij} = 1 : \mathcal{D}_\alpha(A_i) \geq \mathcal{D}_\alpha(A_j) \quad (7)$$

1.2. Tranzitivní redukce

Vztah mezi dvěma obecnými prvky je tranzitivní, pokud platnost vztahu mezi prvky $[i, j]$ a $[j, k]$ implikuje platnost vztahu mezi prvky $[i, k]$. Pakliže na matici instancí budeme pohlížet jako na incidenční matici grafu, lze tuto úlohu převést do teorie grafů - na hledání tranzitivního uzávěru příslušného grafu. Tímto způsobem je možné docílit minimalizace počtu prvků [9], které musí být uloženy, aniž by došlo ke ztrátě dat. Úloha hledání takové podmínky se nazývá tranzitivní redukce, úloha inverzní (rekonstruující z redukce úplnou množinu) se nazývá hledání tranzitivního uzávěru. Poznamenejme, že výsledek tranzitivní redukce není jednoznačný.

Jak množina funkčních závislostí \mathcal{F} , tak díky (5) i množina instancí konzistentního úložiště splňují podmínku transitivity. Jednoduše lze nahlédnout, že postačuje redukovat pouze funkční závislosti a následně ponechat

pouze instance těch funkčních závislostí, které odpovídají tranzitivního uzávěru.

Pro binární matice je možné tranzitivní uzávěr vyjádřit jako mocnění redukované matice:

$$\begin{aligned} X &= (X^b)^\kappa \\ \kappa &= \arg \min_k \{k : (X^b)^k = (X^b)^{k+1}\} \end{aligned} \quad (8)$$

Parametr κ představuje počet kroků nutných ke získání plné formy matice (odpovídající tranzitivnímu uzávěru zaručující dosažitelnost výsledku v jednom kroce).

Hledání tranzitivního uzávěru postupným násobením matic je značně neefektivní, složitost operace je $\mathcal{O}(|X|^{\kappa+2})$. Lepším způsobem je hledání uzávěru pomocí:

Algoritmus 1 Tranzitivní uzávěr

```
for  $\forall k = 1 \dots |X|$ 
  for  $\forall j = 1 \dots |X|$ 
    for  $\forall i = 1 \dots |X|$ 
      if  $x_{ij} = 1 \wedge x_{jk} = 1$  then
         $x_{ik} = 1$ ;
```

Tento algoritmus má složitost již nezávislou na parametru κ : $\mathcal{O}(|X|^3)$, případně přesněji $\mathcal{O}((\sum_{i,j} x_{ij})^2)$.

2. Optimalizace úložiště

Mějme úložiště \mathcal{R} naplněné daty Φ odpovídající instancím funkčních závislostí Ω a předpokládejme, že model obsahuje všechny (tj. tranzitivní uzávěr) platné funkční závislosti. Pokusme se nyní optimalizovat úložiště tak, aby pro uložení všech dat bylo potřeba minimálního počtu instancí, tedy minimalizujeme

$$\|\mathcal{S}\| = \|\Phi\| = \sum_{i,j} \phi_{ij} \quad (9)$$

2.1. Počet instancí

Diskutujme nyní počet instancí funkčních závislostí.

Mějme funkční závislost $f = (A_i \rightarrow A_j) \in \mathcal{F}$ reprezentovanou v binární matice jako $\omega_{ij} = 1$. Blok **1** v matici $\Delta\Omega_{ij}\Delta^T$, který odpovídá¹ prostoru této funkční závislosti, představuje její všechny možné instance. Takových instancí je celkem

$$\|\Delta\Omega_{ij}\Delta^T\| = \|\mathcal{D}(A_i)\| \cdot \|\mathcal{D}(A_j)\| \quad (10)$$

¹ $\Omega_{ij} = [\omega_{i'j'}] : \omega_{i'j'} = 1$ pokud $i = i', j = j'$, jinak $\omega_{i'j'} = 0$

Díky informaci o existenci funkční závislosti f je možné na základě hodnoty atributu na levé straně jednoznačně určit hodnotu atributu na straně pravé; tedy z tohoto počtu možných instancí je přípustných pouze $\|\mathcal{D}(A_i)\|$. Jinými slovy, znalost o existenci funkční závislosti f redukuje počet přípustných instancí ze všech možných celkem o

$$\frac{\|\mathcal{D}(A_i)\|}{\|\Delta\Omega_{ij}\Delta^T\|} = \frac{1}{\|\mathcal{D}(A_j)\|} \% \quad (11)$$

Zobecníme-li tuto úvahu na celou množinu funkčních závislostí, pak

$$\|\Phi\| = \sum_{\forall \omega_{ij}=1} \|\mathcal{D}(A_i)\| \quad (12)$$

2.2. Vliv znalosti funkčních závislostí

Znalost množiny funkčních závislostí \mathcal{F} není pro úložiště \mathcal{R} principiálně nutná; odpovídající minimální funkcionalitu by úložiště pokrývalo i za předpokladu, že každý objekt by byl uložen jako množina implikací mající klíčový element, jednoznačně definující konkrétní objekt, na levé straně a elementy popisující vlastnosti objektu na straně pravé.

$$\mathcal{F}' = \{\forall A \in \mathcal{A} : A_{PK} \rightarrow A\} \quad (13)$$

Bude-li takové úložiště obsahovat popis m objektů, každý popsán stejnými atributy \mathcal{A} , pak počet uložených instancí bude:

$$\|\Phi'\| = \sum_{\forall \omega_{ij}=1} = \|\mathcal{A}\| \cdot m = \|\mathcal{A}\| \cdot \|\mathcal{D}_\alpha(A_{PK})\| \quad (14)$$

Poměr mezi počtem instancí takového úložiště a úložištěm zohledňujícími funkční závislosti bude označen

$$\nu = \frac{\|\Phi\|}{\|\Phi'\|} \quad (15)$$

Tento poměr bude příznivý (tj. $\nu < 1$), pakliže množina funkčních závislostí nebude obsahovat žádné redundantní závislosti.

Ilustrujme výpočet poměru na umělém příkladu. Mějme množinu atributů $A_{GK} \in \mathcal{A}$. Necht' jsou tyto atributy rozděleny do g disjunktních skupin \mathcal{A}_G po k attributech a necht' aktivní doména všech atributů v jedné skupině je stejná a její velikost je odvozena od velikosti předchozí skupiny, která je u krát větší. Velikost aktivních domén

atributů v první skupině je d . Množina funkčních závislostí \mathcal{F} je

$$\{\forall A_{1i} \in \mathcal{A}_1 : A_{PK} \rightarrow A_i\} \cup \bigcup_{\forall l < g-1} \{A_{li} \rightarrow A_{(l+1)i}\} \quad (16)$$

Srovnáme-li počet instancí s (13), dostáváme

$$\nu = \frac{|\Phi|}{|\Phi'|} = \frac{|\mathcal{D}(A_{PK})| + \sum_{v=1}^g kd \frac{1}{u^v}}{|\mathcal{D}(A_{PK})| \cdot kg} \quad (17)$$

Za předpokladu, že budeme uvažovat $|\mathcal{D}(A_{PK})| = d^k$, dostáváme

$$\nu = \frac{1}{g} \left(\frac{1}{k} + \frac{1}{d^{k-1} \sum_{v=1}^g u^v} \right) \quad (18)$$

Je patrné, že tento poměr bude velmi příhodný a tudíž lze zahrnutí znalosti funkčních závislostí více nežli doporučit. Poznamenejme, že $|\mathcal{F}| = |\mathcal{F}'|$ a \mathcal{F}' je možné za použití tranzitivních pravidel odvodit z \mathcal{F} .

2.3. Algoritmus

Hledejme nyní algoritmus, který najde minimální systém funkčních závislostí a zohledňuje i počet instancí tohoto systému. Mějme matici Ω popisující vstupní neoptimalizovaný systém funkčních závislostí, výstupem algoritmu pak je optimalizovaná matice Ω^b .

Základní algoritmus pracuje na principu, že se z pracovní matice postupně vyjímají hrany; pakliže tranzitivní uzávěr (Algoritmus 1) nově vzniklé matice bez hrany je shodný s tranzitivním uzávěrem původní matice, je vyjmutí této hrany přípustné, v opačném případě tato hrana musí být navržena.

Test se provede postupně pro všechny hrany. Navíc jej lze zjednodušit pouze na potvrzení možnosti odvodit vyjmutou hranu na základě okolních hran.

Algoritmus 2 Tranzitivní redukce

for $\forall i, j : \omega_{ij} = 1$
 $\omega_{ij} = 0; \Omega' = \text{closure}(\Omega);$
 if $\omega'_{ij} = 0$ then
 $\omega_{ij} = 1;$
 $\Omega^b = \Omega;$

Složitost tohoto algoritmu pro nalezení tranzitivní redukce je $\mathcal{O}(|\Omega|^3)$. Existují však vylepšení pro silně souvislé grafy [7], které používají pro hledání redukce procházení grafu z náhodně vybraného vrcholu do hloubky. Tyto algoritmy vykazují složitost

$\mathcal{O}(|\mathcal{A}| + |\Omega|)$, avšak jich nelze použít, neboť systém funkčních závislostí nemusí odpovídat silně souvislému grafu - tedy pro použití této myšlenky je nutné procházet všechny vrcholy - atributy. Složitost pak naroste na $|\mathcal{A}| \cdot \mathcal{O}(|\mathcal{A}| + |\Omega|)$, což principiálně vede na $\mathcal{O}(|\mathcal{A}|^3)$.

Hrany mohou být vyjímány v náhodném pořadí. Pakliže budeme prioritně vyjímát funkční závislosti $f = A_i \rightarrow A_j$ s největším počtem instancí $|\mathcal{D}(A_i)|$, součástí tranzitivní redukce zůstanou funkční závislosti s minimálním počtem instancí. Za předpokladu, že vstupní matice je maximálním tranzitivním uzávěrem, vrácený systém funkčních závislostí bude pokrývat nejmenší možný počet instancí.

Složitost seřazení funkčních závislostí $\omega_{ij} = 1$ do posloupnosti dvojic indexů $[[i_1, j_1] \dots [i_{|\Omega|}, j_{|\Omega|}]]$ podle kritéria

$$|\mathcal{D}_\alpha(A_{i_u})| > |\mathcal{D}_\alpha(A_{i_v})| \rightsquigarrow u \succ v \quad (19)$$

je $\mathcal{O}(|\Omega| \log(|\Omega|))$.

Algoritmus 3 Tranzitivní redukce minimalizující počet instancí

$\Omega^* = \text{closure}(\Omega);$
 $o = \text{sort}(\Omega^*);$
 $\Omega^b = \text{reduce}(\Omega^*) \text{ respecting } o;$

Za cenu výpočtu tranzitivního uzávěru vstupní matice Ω (může být požadováno jako vstupní předpoklad algoritmu) $\mathcal{O}(|\Omega|^2)$ a cenu za seřazení $\mathcal{O}(|\Omega| \log(|\Omega|))$ není získána libovolná přípustná redukce systému funkčních závislostí, ale taková, která potřebuje k reprezentaci celé znalostní báze minimální paměťový prostor.

2.4. Intensionální versus extensionální modely

Díky platnosti (7) je nutné optimalizovat úložiště \mathcal{R} pouze jednou na základě funkčních závislostí \mathcal{F} popsaných intensionálním modelem M ; jakékoli přidávání dat odpovídajících modelu M nemůže vést ke takové změně, která by způsobila neoptimalitu úložiště. Jinými slovy znalost všech platných funkčních závislostí je silnějším předpokladem nežli znalost velikosti (aktivních) domén atributů.

Mnohé zdroje, zvláště pak v prostředí webu, poskytují pouze data bez jakéhokoli popisu (modelu). Zvláštním případem jsou data bez uvedeného intensionálního modelu, avšak (většinou pomocí atributové anotace) schopné extensionální model explicitně popsat. V tomto případě hovoříme o metodě odhadu modelu - struktury dat.

Tyto metody (označované jako Functional Dependency Discovery) se snaží nejlepším možným způsobem odhadnout systém funkčních závislostí. Podle postupného hledání protipříkladů rozdělují množinu všech možných unárních funkčních závislostí $\overline{\mathcal{F}} = \mathcal{A} \times \mathcal{A}$ na:

- *porušené funkční závislosti* \mathcal{F}_c . Za předpokladu bezchybnosti vstupních dat porušená funkční závislost v jakékoli extensi nemůže být součástí intensionálního modelu. Jinými slovy, po nalezení protipříkladu lze s jistotou tvrdit, že daná funkční závislost neplatí. Matici porušených funkčních závislostí budeme označovat \bar{U} .
- *neporušené funkční závislosti* \mathcal{F} . U těchto funkčních závislostí dosud nebyl nalezen protipříklad, který by je porušil. O těchto funkčních závislostech se můžeme domnívat, že jsou platné (a tedy součástí intensionálního modelu).

Díky neznalosti množiny funkčních závislostí jsou velikosti aktivních domén jedinou použitelnou známou charakteristikou. Ta se může v průběhu vkládání dat do úložiště měnit - její změny často vedou na základě (7) k získání protipříkladu s následnou detekcí porušení funkční závislosti a tím ke změně modelu. Nový model je potřeba znovu optimalizovat.

2.5. Inkrementální verze algoritmu

Použití algoritmu 3 je vhodné pro jednorázovou optimalizaci. Předpokládejme, že model se nebude měnit radikálně, vždy zůstane nějaká část beze změny. Diskutujeme nyní návrh úprav optimalizovaného úložiště tak, aby bylo optimální i po vložení nového objektu.

Neoptimalita se často odvíjí od porušení funkční závislosti $\omega_{ij} = 1$ z redukovaného systému. Tato porušená funkční závislost bude následně vyjmuta ze systému, tj. $\omega'_{ij} = 0$, avšak je nutné zachovat funkční závislosti, které byly pomocí této závislosti odvoditelné na základě tranzitivních pravidel:

$$\begin{aligned} \forall k : \omega_{jk} = 1 &\rightsquigarrow \omega'_{ik} = 1 \\ \forall l : \omega_{li} = 1 &\rightsquigarrow \omega'_{lj} = 1 \end{aligned}$$

Tento proces probíhá do okamžiku, kdy už žádná z funkčních závislostí v redukovaném systému není porušena.

Je možné ukázat, že nový redukovaný systém Ω' je optimální možný, pokud před započatím detekce porušených funkčních závislostí byl optimální vůči již aktualizovaným velikostem aktivních domén atributů.

3. Nejednoznačnost tranzitivní redukce

Nalezení tranzitivní redukce je obecně úloha s víceznačným řešením. Z tohoto důvodu je vhodné použít nějaké doplňující kritérium.

Za předpokladu, že použijeme kritérium minimalizující počet instancí, výsledek bude jednoznačný až na atributy spojené s funkčními závislostmi, které tvoří cyklus libovolné délky. Takové skupiny atributů budeme nazývat komponentami:

$$A_i \in \mathcal{C}(A_j) \subseteq \mathcal{A} \text{ if } \exists A_j \in \mathcal{C} : \omega_{ij} = \omega_{ji} = 1 \quad (20)$$

Pokud každou z komponent $\mathcal{C}(A_j)$ nahradíme jedním reprezentativním atributem A_j , pak výsledek tranzitivní redukce s minimálním počtem instancí je jednoznačný. Jinými slovy nejednoznačnost celého výsledku je způsobena nejednoznačností tranzitivní redukce komponent včetně nejednoznačnosti výběru reprezentativního atributu, jenž komponentu propojuje s ostatními.

Obecně existuje mnoho konfigurací, jak popsat vztahy uvnitř komponenty. Tři základní, lineární, hvězdicovou a cyklus popíšeme detailněji, všechny ostatní jsou nějakou kombinací těchto základních konfigurací.

Před výčtem vlastností dílčích konfigurací poznamenejme, že jako důsledek (7) a (20) platí:

$$\forall \mathcal{C} \forall A_i, A_j \in \mathcal{C} : \|\mathcal{D}_\alpha(A_i)\| = \|\mathcal{D}_\alpha(A_j)\| = \epsilon \quad (21)$$

Dále, vlastnosti konfigurace $\Omega_{\mathcal{C}}^X = [\omega_{ij}^b]$ se odvíjí od vstupních a výstupních stupňů vrcholů odpovídající atributům při zachování vzájemné odvoditelnosti mezi všemi atributy v komponentě reprezentované tranzitivním uzávěrem $\Omega_{\mathcal{C}}^*$. Proto tento účel zaved' me kritérium na počet vrcholů (atributů) mající předepsaný součet stupňů :

$$\mu(\beta) = \|\{\forall A_i \in \mathcal{C} : \sum_{\forall k} \omega_{ik}^b + \omega_{ki}^b = \beta\}\| \quad (22)$$

3.1. Lineární konfigurace

Lineární konfigurace představuje takovou redukci $\Omega_{\mathcal{C}}^L$, která je symetrická a maximalizuje počet vrcholů $\mu(4)$ mající součet stupňů součet stupňů roven 4:

$$\arg \max_{\mu(4)} \{\Omega_{\mathcal{C}}^L = (\Omega_{\mathcal{C}}^L)^T \wedge (\Omega_{\mathcal{C}}^L)^{\|\mathcal{C}\|} = \Omega_{\mathcal{C}}^*\} \quad (23)$$

Výsledkem takové minimalizace je matice, jejíž prvky jsou:

$$\omega_{ij}^L = \begin{cases} 1 & i = j + 1 \vee j = i + 1 \\ 0 & \text{jinak} \end{cases} \quad (24)$$

Taková matice pak vykazuje:

Maximální počet iterací	κ	$\ \mathcal{E}\ - 1$
Počet funkčních závislostí	$\ \Omega_{\mathcal{E}}^L\ $	$2(\ \mathcal{E}\ - 1)$
Počet instancí	$\ \Phi\ $	$2\epsilon(\ \mathcal{E}\ - 1)$
Kompresní poměr	ν^L	$\frac{2\epsilon(\ \mathcal{E}\ - 1)}{\epsilon(\ \mathcal{E}\ - 1)} = 2$
Délka minimálního cyklu	σ^{\ominus}	2
Délka maximálního cyklu	σ^{\oplus}	$2(\ \mathcal{E}\ - 1)$
Maximální počet vložení	θ^{\oplus}	0
Maximální počet vyjmutí	θ^{\ominus}	κ

Tabulka 1: Vlastnosti lineární konfigurace

3.2. Hvězdicová konfigurace

Hvězdicová konfigurace představuje takovou redukci $\Omega_{\mathcal{E}}^S$, která je symetrická a maximalizuje počet vrcholů $\mu(2)$ se součtem stupňů 2:

$$\arg \max_{\mu(2)} \{ \Omega_{\mathcal{E}}^L = (\Omega_{\mathcal{E}}^S)^T \wedge (\Omega_{\mathcal{E}}^S)^{\|\mathcal{E}\|} = \Omega_{\mathcal{E}}^* \} \quad (25)$$

Výsledkem takové minimalizace je matice, jejíž prvky jsou:

$$\omega_{ij}^S = \begin{cases} 1 & i = 1 \vee j = 1 \\ 0 & \text{jinak} \end{cases} \quad (26)$$

Taková matice pak vykazuje:

Maximální počet iterací	κ	2
Počet funkčních závislostí	$\ \Omega_{\mathcal{E}}^L\ $	$2(\ \mathcal{E}\ - 1)$
Počet instancí	$\ \Phi\ $	$2\epsilon(\ \mathcal{E}\ - 1)$
Kompresní poměr	ν^L	$\frac{2\epsilon(\ \mathcal{E}\ - 1)}{\epsilon(\ \mathcal{E}\ - 1)} = 2$
Délka minimálního cyklu	σ^{\ominus}	2
Délka maximálního cyklu	σ^{\oplus}	4
Maximální počet vložení	θ^{\oplus}	$(\ \mathcal{E}\ - 2)$
Maximální počet vyjmutí	θ^{\ominus}	$(\ \mathcal{E}\ - 1)$

Tabulka 2: Vlastnosti hvězdicové konfigurace

3.3. Konfigurace cyklus

Konfigurace cyklus představuje takovou redukci $\Omega_{\mathcal{E}}^C$, která narozdíl od předchozích není symetrická a maximalizuje počet vrcholů $\mu(2)$ mající součet stupňů 2:

$$\arg \max_{\mu(2)} \{ (\Omega_{\mathcal{E}}^C)^{\|\mathcal{E}\|} = \Omega_{\mathcal{E}}^* \} \quad (27)$$

Výsledkem takové minimalizace je matice, jejíž prvky jsou:

$$\omega_{ij}^C = \begin{cases} 1 & i = j + 1 \\ 1 & i = \|\mathcal{E}\| \wedge j = 1 \\ 0 & \text{jinak} \end{cases} \quad (28)$$

Taková matice pak vykazuje:

Maximální počet iterací	κ	$\ \mathcal{E}\ - 1$
Počet funkčních závislostí	$\ \Omega_{\mathcal{E}}^C\ $	$\ \mathcal{E}\ $
Počet instancí	$\ \Phi\ $	$\epsilon\ \mathcal{E}\ $
Kompresní poměr	ν^C	$\frac{\epsilon(\ \mathcal{E}\)}{\epsilon(\ \mathcal{E}\ - 1)} \sim 1$
Délka minimálního cyklu	σ^{\ominus}	$\ \mathcal{E}\ $
Délka maximálního cyklu	σ^{\oplus}	$\ \mathcal{E}\ $
Maximální počet vložení	θ^{\oplus}	$(\ \mathcal{E}\ - 2)$
Maximální počet vyjmutí	θ^{\ominus}	$(\ \mathcal{E}\ - 1)$

Tabulka 3: Vlastnosti konfigurace cyklus

3.4. Porovnání konfigurací

Na základě porovnání parametrů uvedených v předchozích tabulkách je možné zobecnit poznatky o volbě konfigurace.

Mezi výhody lineární konfigurace patří fakt, že počet funkčních závislostí redukovaného systému je stejně jako u počtu všech odvoditelných funkčních závislostí v průběhu procesu odhadování nerostoucí. Jinými slovy tato konfigurace nevyžaduje tak časté odvozování instancí nově vložených funkčních závislostí - pouze porušené nahrazuje platnými. Druhou výhodou je, že délka minimálního cyklu je 2. Toho lze s výhodou využít při detekci cyklu. Cykly mohou způsobovat nežádoucí postupné deaktivace elementů při dotazování, jenž využívá zobecnění binárních matic na matice s hodnotami prvků z celého intervalu $\langle 0, 1 \rangle$.

Naopak bezespornou výhodou hvězdicové konfigurace je minimální počet kroků nutných k dosažení finálního výsledku. Tento počet se týká jak fáze vyhledávání, tak iterací pro detekci porušených funkčních závislostí ve fázi odhadu struktury dat. Tato výhoda je však zaplácena množstvím možných úprav (vložení) při detekci porušené funkční závislosti.

Konfigurace cyklus vykazuje výhodné vlastnosti předchozích dvou, navíc se kompresní poměr blíží 1 (oproti 2 u předchozích konfigurací způsobený požadavkem na symetrii), avšak konfiguraci tvoří jeden cyklus délky $\kappa = \|\mathcal{E}\|$. Tedy tato konfigurace je velmi vhodná pro ukládání dat do úložiště, avšak dotazování potřebuje největší počet iterací a detekce cyklů pro účely zmíněné výše je výpočetně náročná.

4. Závěr

Článek se zabývá možnostmi redukci počtu instancí funkčních závislostí a to jak v případě, že tyto funkční závislosti jsou popsány v intensionálním modelu, tak v průběhu procesu odhadování modelu z dat na extensionální úrovni. Ukazuje se, že optimalizaci postačí v prvním případě provést jednorázově, avšak v případě po-

stupného odhadování vlastností dat je nutné optimalizaci provést po vložení každého nového záznamu.

Z tohoto důvodu je navrženo detekovat pouze neoptimální části a ty následně optimalizovat. Tyto neoptimalizované části jsou vždy svázány s porušením některé z funkčních závislostí (takové jsou jako neplatné z modelu postupně vyjímány). Příspěvek z tohoto důvodu zavádí pojem komponent - porušení funkční závislosti v komponentě vede na její rozdělení.

Druhotně příspěvek ukazuje, jak přesnější znalost o struktuře dat vede ke snížení počtu víceznačných řešení optimalizační úlohy. Vedle toho na umělém příkladu ukazuje výhody znalosti platných funkčních závislostí pro efektivní uložení dat do úložiště.

Literatura

- [1] A. Baddeley, *Vaše paměť*. Books, 1999.
- [2] M. Řimnáč, "Data structure estimation for rdf oriented repository building," *cisis*, vol. 0, pp. 147–154, 2007.
- [3] G. Antoniou and F. v Harmelen, *A Semantic Web Primer*. MIT Press, 2004.
- [4] H. Mannila and K. Räihä, "Design by example: An applications of armstrong relations.," *Journal of computer and system sciences*, vol. 33, pp. 129–141, 1986.
- [5] H. Mannila and K. Räihä, "Algorithms for inferring functional dependencies from relations," *Data & Knowledge Engineering*, vol. 12, pp. 83–99, 1994.
- [6] P. A. Flach and I. Savnik., "Database dependency discovery: A machine learning approach," *AI Communications*, vol. 12/3, pp. 139–160, 1999.
- [7] K. Simon, "Finding a minimal transitive reduction in a strongly connected digraph within linear time," in *WG '89: Proceedings of the 15th International Workshop on Graph-Theoretic Concepts in Computer Science*, (London, UK), pp. 245–259, Springer-Verlag, 1990.
- [8] K. Simon, "On minimum flow and transitive reduction," in *ICALP '88: Proceedings of the 15th International Colloquium on Automata, Languages and Programming*, (London, UK), pp. 535–546, Springer-Verlag, 1988.
- [9] M. Kryszkiewicz, "Concise representations of association rules," in *Pattern Detection and Discovery: ESF Exploratory Workshop*, vol. LNCS 2447, 2002.

Neural Networks for Evolutionary Robotics

Post-Graduate Student:

MGR. STANISLAV SLUŠNÝ

Institute of Computer Science of the ASCR, v. v. i.
Pod Vodárenskou věží 2

182 07 Prague 8, CZ

slusnys@gmail.com

Supervisor:

MGR.. ROMAN NERUDA, CSC.

Institute of Computer Science of the ASCR, v. v. i.
Pod Vodárenskou věží 2

182 07 Prague 8, CZ

roman@cs.cas.cz

Field of Study:
Software Systems

The work was fully supported by Czech Science Foundation (GACR), project No: 201/05/H014.

Abstract

The design of intelligent embodied agents represents one of the key research topics of today's artificial intelligence. The goal of this work is to study emergence of intelligent behavior within a simple intelligent agent. Cognitive agent functions are realized by mechanisms based on neural networks and evolutionary algorithms. The evolutionary algorithm is responsible for the adaptation of a neural network parameters based on the performance of the embodied agent in a simulated environment. The evolutionary learning is realized for several architectures of neural networks, namely the feed-forward multilayer perceptron network, the recurrent Elmans neural network, and the radial basis function network. In experiments, we demonstrate the performance of evolutionary algorithm in the problem of agent learning where it is not possible to use traditional supervised learning techniques.

1. Introduction

One of the main goals of Artificial Intelligence is to gain insight into natural intelligence through a synthetic approach, by generating and analyzing artificial intelligent behavior. In order to glean an understanding of a phenomenon as complex as natural intelligence, we need to study complex behavior in complex environments.

In contrast to traditional systems, reactive and behavior based systems have placed agents with low levels of cognitive complexity into complex, noisy and uncertain environments. One of the many characteristics of intelligence is that it arises as a result of an agent's interaction with complex environments. Thus, one approach to develop autonomous intelligent agents, called *evolutionary robotics*, is through a self-organization process based on artificial evolution. Its main advantage is that it is an ideal framework for synthesizing agents whose behavior emerge from a large number of interactions among their constituent parts [9].

In the following sections we introduce multilayer perceptron networks (MLP), Elmans networks (ELM) and radial basis function networks (RBF). Then we take a look at Khepera robots and related simulation software. In the following section we present two experiments with Khepera robots. In both of them, the artificial evolution is guiding the self-organization process. In

the first experiment we expect an emergence of behavior that guarantees full maze exploration. The second experiment shows the ability to train the robot to discriminate between walls and cylinders. In the last section we draw some conclusions and present directions for our future work.

2. Neural Networks

2.1. Multilayer Perceptron Networks

A multilayer feedforward neural network is an interconnected network of simple computing units called neurons which are ordered in layers, starting from the input layer and ending with the output layer [5]. Between these two layers there can be a number of hidden layers. Connections in this kind of networks only go forward from one layer to the next. The output $y(x)$ of a neuron is defined in equation (1):

$$y(x) = g \left(\sum_{i=1}^n w_i x_i \right), \quad (1)$$

where x is the neuron with n input dendrites ($x_0 \dots x_n$), one output axon $y(x)$, $w_0 \dots w_n$ are weights and $g : \mathbb{R} \rightarrow \mathbb{R}$ is the activation function. We have used one of the most common activation functions, the logistic sigmoid function (2):

$$\sigma(\xi) = 1/(1 + e^{-\xi t}), \quad (2)$$

where t determines its steepness.

In our approach, the evolutionary algorithm is responsible for weights modification, the architecture of the network is determined in advance and does not undergo the evolutionary process.

2.2. Recurrent Neural Networks

In recurrent neural networks, besides the feedforward connections, there are additional recurrent connections that go in the opposite direction. These networks are often used for time series processing because the recurrent connection can work as a memory for previous time steps. In the Elman [3] architecture, the recurrent connections explicitly hold a copy (memory) of the hidden units activations at the previous time step. Since hidden units encode their own previous states, this network can detect and reproduce long sequences in time. The scheme how the Elman network works is like this (also cf. Fig. 1):

- Compute hidden unit activations using net input from input units and from the copy layer.
- Compute output unit activations as usual based on the hidden layer.
- Copy new hidden unit activations to the copy layer.

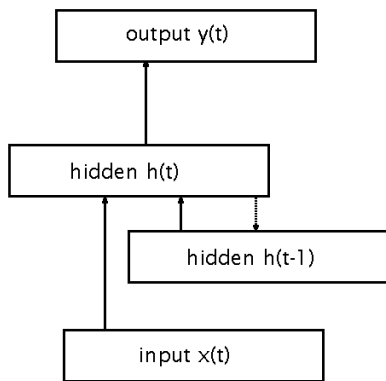

Figure 1: Scheme of layers in the Elman network architecture.

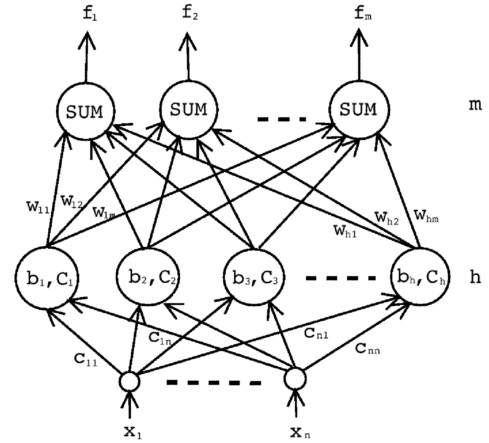

Figure 2: Scheme of layers in the RBF network architecture.

2.3. Radial Basis Function Networks

An RBF neural network represents a relatively new neural network architecture. In contrast with the multilayer perceptrons the RBF network contains local units, which was motivated by the presence of many local response units in human brain. Other motivation came from numerical mathematics, radial basis functions were first introduced as a solution of real multivariate interpolation problems [12].

It is a feed-forward neural network with one hidden layer of RBF units and a linear output layer (see Fig. 2). By an RBF unit we mean a neuron with n real inputs \vec{x} and one real output y , realizing a radial basis function φ , such as Gaussian.

$$y(\vec{x}) = \varphi\left(\frac{\|\vec{x} - \vec{c}\|}{b}\right). \quad (3)$$

The network realizes the function:

$$f_s(\vec{x}) = \sum_{j=1}^h w_{js} \varphi\left(\frac{\|\vec{x} - \vec{c}_j\|}{b_j}\right), \quad (4)$$

where f_s is the output of the s -th output unit.

There is a variety of algorithms for RBF network learning, in our previous work we studied their behavior and possibilities of their combinations [8].

The learning algorithm that we use for RBF networks was motivated by the commonly used Three-step learning. Parameters of RBF network are divided into three groups: centers, widths of the hidden units, and output weights. Each group is then trained separately. The centers of hidden units are found by clustering (k-means algorithm) and the widths are fixed so as the areas of importance belonging to individual units cover the whole

input space. Finally, the output weights are found by EA. The advantage of such approach is the lower number of parameters to be optimized by EA, i.e. smaller length of individual.

3. Evolutionary Learning Algorithms for Robotics

3.1. The Khepera Robot

Khepera [7] is a miniature mobile robot with a diameter of 70 mm and a weight of 80 g. The robot is supported by two lateral wheels that can rotate in both directions and two rigid pivots in the front and in the back. The sensory system employs eight “active infrared light” sensors distributed around the body, six on one side and two on other side. In “active mode” these sensors emit a ray of infrared light and measure the amount of reflected light. The closer they are to a surface, the higher is the amount of infrared light measured. The Khepera sensors can detect a white paper at a maximum distance of approximately 5 cm.

In a typical setup, the controller mechanism of the robot is connected to the eight infrared sensors as input and its two outputs represent information about the left and right wheel power. For a neural network we typically consider architectures with eight input neurons, two output neurons and a single layer of neurons, mostly five or ten hidden neurons is considered in this paper. It is difficult to train such a network by traditional supervised learning algorithms since they require instant feedback in each step, which is not the case for evolution of behavior. Here we typically can evaluate each run of a robot as a good or bad one, but it is impossible to assess each one move as good or bad. Thus, the evolutionary algorithm represent one of the few possibilities how to train the network.

3.2. Evolutionary Algorithm

The evolutionary algorithms (EA) [6, 4] represent a stochastic search technique used to find approximate solutions to optimization and search problems. They use techniques inspired by evolutionary biology such as mutation, selection, and crossover. The EA typically works with a population of *individuals* representing abstract representations of feasible solutions. Each individual is assigned a *fitness* that is a measure of how good solution it represents. The better the solution is, the higher the fitness value it gets. The population evolves towards better solutions. The evolution starts from a population of completely random individuals and iterates in generations. In each generation, the fitness of each individual is evaluated. Individuals are stochastically selected from the current population (based on their fitness), and mo-

dified by means of operators *mutation* and *crossover* to form a new population. The new population is then used in the next iteration of the algorithm.

3.3. Evolutionary Network Learning

Various architectures of neural networks used as robot controllers are encoded in order to use them the evolutionary algorithm. The encoded vector is represented as a floating-point encoded vector of real parameters determining the network weights.

Typical evolutionary operators for this case have been used, namely the uniform crossover and the mutation which performs a slight additive change in the parameter value. The rate of these operators is quite big, ensuring the exploration capabilities of the evolutionary learning. A standard roulette-wheel selection is used together with a small elitist rate parameter. Detailed discussions about the fitness function are presented in the next section.

4. Experiments

4.1. Setup

Although evolution on real robots is feasible, serial evaluation of individuals on a single physical robot might require quite a long time. One of the widely used simulation software (for Khepera robots) is the Yaks simulator [2], which is freely available. Simulation consists of predefined number of discrete steps, each single step corresponds to 100 ms.

To evaluate the individual, simulation is launched several times. Individual runs are called “trials”. In each trial, neural network is constructed from the chromosome, environment is initialized and the robot is put into randomly chosen starting location. The inputs of neural networks are interconnected with robot’s sensors and outputs with robot’s motors. The robot is then left to “live” in the simulated environment for some (fixed) time period, fully controlled by neural network. As soon as the robot hits the wall or obstacle, simulation is stopped. Depending on how well the robot is performing, the individual is evaluated by value, which we call “trial score”. The higher the trial score, the more successful robot in executing the task in a particular trial. The fitness value is then obtained by summing up all trial scores.

4.2. Maze Exploration

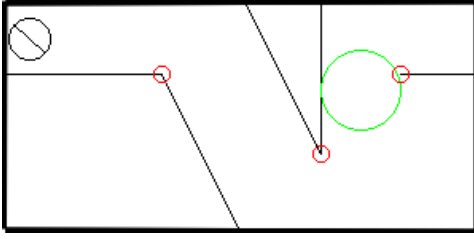

Figure 3: The environment in the maze exploration task. The zone is drawn as the bigger circle, the smaller circle represents the Khepera robot.

In this experiment, the agent is put in the maze of 60x30 cm (Fig. 3). The agent's task is to fully explore the maze. Fitness evaluation consists of four trials, individual trials differ by agent's starting location. Agent is left to live in the environment for 250 simulation steps.

The three-component $T_{k,j}$ motivates agent to learn to move and to avoid obstacles:

$$T_{k,j} = V_{k,j}(1 - \sqrt{\Delta V_{k,j}})(1 - i_{k,j}). \quad (5)$$

First component $V_{k,j}$ is computed by summing absolute values of motor speed in the k -th simulation step and j -th trial, generating value between 0 and 1. The second component $(1 - \sqrt{\Delta V_{k,j}})$ encourages the two wheels to rotate in the same direction. The last component $(1 - i_{k,j})$ encourage obstacle avoidance. The value $i_{k,j}$ of the most active sensor in k -th simulation step and j -th trial provides a conservative measure of how close the robot is to an object. The closer it is to an object, the higher the measured value in range from 0 to 1. Thus, $T_{k,j}$ is in range from 0 to 1, too.

In the j -th trial, score S_j is computed by summing normalized trial gains $T_{k,j}$ in each simulation step.

$$S_j = \sum_{k=1}^{250} \frac{T_{k,j}}{250} \quad (6)$$

To stimulate maze exploration, agent is rewarded, when it passes through the zone. The zone is randomly located area, which can not be sensed by an agent. Therefore, Δ_j is 1, if agent passed through the zone in j -th trial and 0 otherwise. The fitness value is then computed as follows:

$$Fitness = \sum_{j=1}^4 (S_j + \Delta_j) \quad (7)$$

Successful individuals, which pass through the zone in each trial, will have fitness value in range from 4 to 5. The fractional part of the fitness value reflects the speed of the agent and it's ability to avoid obstacles.

4.3. Results

All the networks included in the tests were able to learn the task of finding a random zone from all four positions. The resulting best fitness values (cf. Tab. 1) are all in the range of 4.3–4.4 and they differ only in the order of few per cent. It can be seen that the MLP networks perform slightly better, RBF networks are in the middle, while recurrent networks are a bit worse in terms of the best fitness achieved. According to their general performance, which takes into account ten different EA runs, the situation changes slightly. In general, the networks can be divided into two categories. The first one represents networks that performed well in each experiment in a consistent manner, i.e. every run of the evolutionary algorithm out of the ten random populations ended in finding a successful network that was able to find the zone from each trial. MLP networks and recurrent networks with 5 units fall into this group. The second group has in fact a smaller trial rate because, typically, one out of ten runs of EA did not produced the optimal solution. The observance of average and standard deviation values in Tab. 1 shows this clearly. This might still be caused by the less-efficient EA performance for RBF and Elman networks.

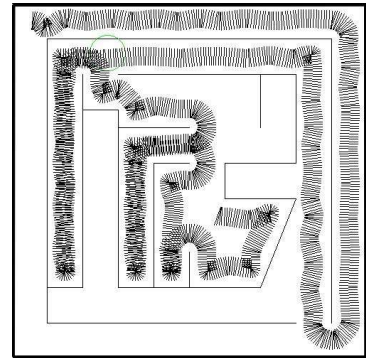

Figure 4: Testing environment in the maze exploration task is the bigger maze of 100x100 cm. Agent's strategy is to follow wall on it's left side.

The important thing is to test the quality of the obtained solution is tested in a different arena, where a bigger maze is utilized (Fig. 4). Each of the architectures is capable of efficient space exploration behavior that has emerged during the learning to find random zone positions. The above mentioned figure shows that the robot trained in a quite simple arena and endowed by relatively small network of 5–10 units is capable to navigate in a very complex environment.

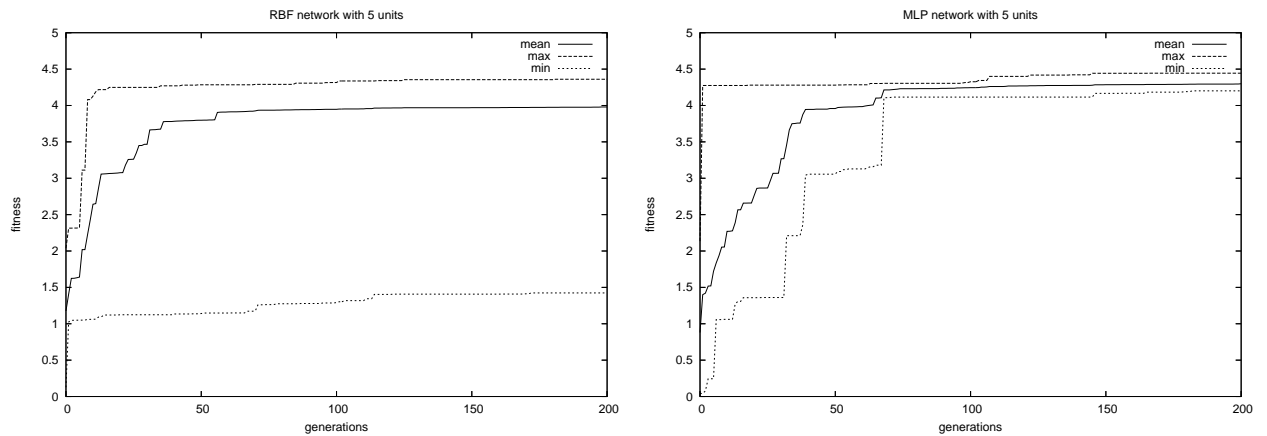

Figure 5: Plots of fitness curves in consecutive populations (maximal, minimal, and average individual) for a typical EA run (one of ten) training the RBF (and MLP, respectively) network with 5 units.

Network type	Maze exploration				Wall and cylinder			
	mean	std	min	max	mean	std	min	max
MLP 5 units	4.29	0.08	4.20	4.44	2326.1	57.8	2185.5	2390.0
MLP 10 units	4.32	0.07	4.24	4.46	2331.4	86.6	2089.0	2391.5
ELM 5 units	4.24	0.06	4.14	4.33	2250.8	147.7	1954.5	2382.5
ELM 10 units	3.97	0.70	2.24	4.34	2027.8	204.3	1609.5	2301.5
RBF 5 units	3.98	0.90	1.42	4.36	1986.6	230.2	1604.0	2343.0
RBF 10 units	4.00	0.97	1.23	4.38	2079.4	94.5	2077.5	2359.5

Table 1: Comparison of the fitness values achieved by different types of network in the experiments.

4.4. Walls and Cylinders Experiment

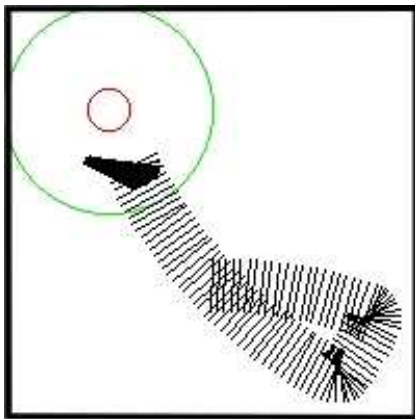

Figure 6: Trajectory of an agent doing the Walls and cylinders task.

Following experiment is based on the experiment carried out by Nolfi [10, 11]. The task is to discriminate between the sensory patterns produced by the walls and small cylinders. As noted in [9], passive networks (i.e. networks which are passively exposed to a set of sensory patterns without being able to interact with the external

environment through motor action), are mostly unable to discriminate between different objects. However, this problem can easily be solved by agents that are left free to move in the environment.

The agent is allowed to sense the world by only six frontal infrared sensors, which provide it with only limited information about environment. Fitness evaluation consists of five trials, individual trials differ by agent's starting location. Agent is left to live in the environment for 500 simulation steps. In each simulation step, trial score is increased by 1, if robot is near the cylinder, or 0.5, if robot is near the wall. The fitness value is then obtained by summing up all trial scores. Environment is the arena of 40x40 cm surrounded by walls.

4.5. Results

It may seem surprising that even this more complicated task was solved quite easily by relatively simple network architectures (Fig. 6). The images of walls and cylinders are overlapping a lot in the input space determined by the sensors.

The results in terms of best individuals are again quite

comparable for different architectures with reasonable network sizes. The differences are more pronounced than in the case of the previous task though. Again, the MLP is the overall winner mainly when considering the overall performance averaged over ten runs of EA. The behavior of EA for Elman and RBF networks was less consistent, there were again several runs that obviously got stuck in local extrema (cf. Tab. 1).

We should emphasize the difference between fitness functions in both experiment. The fitness function used in the first experiment rewards robot for single actions, whereas in the second experiment, we describe only desired behavior.

All network architectures produced similar behavior. Robot was exploring the environment by doing arc movements and after discovering target, it started to move there and back and remained in it's vicinity.

5. Conclusions

The main goal of this paper was to demonstrate the ability of neural networks trained by evolutionary algorithm to achieve non-trivial robotic tasks. There have been two experiments carried out with three types of neural networks and different number of units.

For the maze exploration experiment the results are encouraging, a neural network of any of the three types is able to develop the exploration behavior. The trained network is able to control the robot in the previously unseen environment. Typical behavioral patterns, like following the right wall have been developed, which in turn resulted in the very efficient exploration of an unknown maze. The best results achieved by any of the network architectures are quite comparable, with simpler perceptron networks (such as the 5-hidden unit perceptron) marginally outperforming Elman and RBF networks.

In the second experiment it has been demonstrated that the above mentioned approach is able to take advantage of the embodied nature of agents in order to tell walls from cylindrical targets. Due to the sensor limitations of the agent, this task requires a synchronized use of a suitable position change and simple pattern recognition. This problem is obviously more difficult than the maze exploration, nevertheless, most of the neural architectures were able to locate and identify the round target regardless of its position.

The results reported above represent just a few steps in the journey toward more autonomous and adaptive robotic agents. The robots are able to learn simple beha-

viour by evolutionary algorithm only by rewarding the good ones, and without explicitly specifying particular actions. The next step is to extend this approach for more complicated actions and compound behaviors. This can be probably realized by incremental learning one network a sequence of several tasks. Another—maybe a more promising approach—is to try to build a higher level architecture (like a type of a Brooks subsumption architecture [1]) which would have a control over switching simpler tasks realized by specialized networks. Ideally, this higher control structure is also evolved adaptively without the need to explicitly hardwire it in advance. The last direction of our future work is the extension of this methodology to the field of collective behavior.

References

- [1] R. A. Brooks, A robust layered control system for a mobile robot. *IEEE Journal of Robotics and Automation* (1986), **RA-2**, 14-23.
- [2] J. Carlsson, T. Ziemke, YAKS - yet another Khepera simulator, in: S. Ruckert, Witkowski (Eds.) *Autonomous Minirobots for Research and Entertainment Proceedings of the Fifth International Heinz Nixdorf Symposium*, HNI-Verlagsschriftenreihe, Paderborn, Germany, 2001.
- [3] J. Elman, Finding structure in time, *Cognitive Science* 14 (1990) 179-214.
- [4] D. B. Fogel, *Evolutionary Computation: The Fossil Record*. MIT-IEEE Press. 1998.
- [5] S. Haykin, *Neural Networks: A Comprehensive Foundation* (2nd ed). Prentice Hall, 1998.
- [6] J. Holland, *Adaptation In Natural and Artificial Systems* (reprint ed). MIT Press. 1992.
- [7] Khepera II web page documentation. <http://www.k-team.com>
- [8] R. Neruda, P. Kudová, Learning methods for RBF neural networks. *Future Generations of Computer Systems*, **21**, (2005), 1131-1142.
- [9] S. Nolfi, D. Floreano, *Evolutionary Robotics — The Biology, Intelligence and Technology of Self-Organizing Machines*. The MIT Press, 2000.
- [10] S. Nolfi, Adaptation as a more powerful tool than decomposition and integration. In T. Fogarty and G. Venturini (Eds.), *Proceedings of the Workshop on Evolutionary Computing and Machine Learning*, 13th International Conference on Machine Learning, Bari, 1996.
- [11] S. Nolfi, The power and limits of reactive agents.

Technical Report. Rome, Institute of Psychology,
National Research Council, 1999.

[12] M. Powel, Radial basis functions for multivaria-

ble interpolation: A review. In: *IMA Conference
on Algorithms for the Approximation of Functions
and Data*, RMCS, Shrivenham, England (1985)
143–167

Maintaining Trust in Large Scale Environments

Post-Graduate Student:

ING. ROMAN ŠPÁNEK

Faculty of Mechatronics and Interdisciplinary Engineering Studies
Technical University of Liberec
Hádkova 6

461 17 Liberec 1, CZ

roman.spanek@tul.cz

Supervisor:

ING. JÚLIUS ŠTULLER, CSC.

Institute of Computer Science of the ASCR, v. v. i.
Pod Vodárenskou věží 2

182 07 Prague 8, CZ

stuller@cs.cas.cz

Field of Study:
Electrical Engineering and Informatics

The work was supported by the project 1ET100300419 of the Program Information Society (of the Thematic Program II of the National Research Program of the Czech Republic) "Intelligent Models, Algorithms, Methods and Tools for the Semantic Web Realization", partly by the Institutional Research Plan AV0Z10300504 "Computer Science for the Information Society: Models, Algorithms, Applications" and by Ministry of Education, Youth and Sports of the Czech Republic, project No. 1M0554 Advanced Remedial Technology and Processes.

Abstract

The paper describes a new approach for treating trust in reconfigurable groups of users used for communication and computing. The proposed model uses properties of weighted hypergraphs. Model flexibility enables description of relations between nodes such that these relations are preserved under frequent changes. The ideas can be straightforwardly generalized to other concepts describable by weighted hypergraphs. The consistency of the proposal was verified in a couple of experiments with our pilot implementation SecGRID.

1. Introduction

It is thought that humans evolution was started at the precise moment when the first primogenitor used its hands to make a simple job. Even if it might not be the truth, the truth is that our primogenitor used to live in crowds. These crowds were simple societies, the predecessors of current complicated society spreading round the world. Although the evolution from the crowds to the nowadays societies was a long and sometimes a painful process, at least one thing has reminded in the limelight – communication. Were it not for the communication, it would have been very hard even unlikely to have achieved the progress in society and technologies. It is not surprising then that many great inventions were in the field of communication. The list might be started with the typography going through the Bell's telegraph and the telephone reaching the current hi-tech wireless communication devices and the Internet.

However, all the progress and the success of the high-tech devices have also faced some severe problems. The one of the most severe issues is security. The security task can be viewed as consisting of two the main sub-tasks:

- *encryption* - use strong cryptography algorithms

for securing communication against the treat of tap, man-in-the-middle attack, etc.

- *trust* - use the level of trust between engaged entities to simplify the process of making the resolution whether accept or reject the request

Interaction or communication secured by the strong cryptography between mutually unknown entities or entities with very limited knowledge about themselves can take place only if trust between the parties is high enough. Nevertheless trust is not a static phenomena; humans are used to change their relationships on the fly as posed to dangers or security threats during their every day lives. Thence models coping with trust as static property fails to be appropriate in human driven communication. Thus, a dynamic model of trust is needed where new relationships may emerge, existing relationship may disappear or level of trust may change through the time.

2. Motivation

Figure 1 illustrates the motivation scenario of private information exchange between two distinct entities. In this scenario User B requires private information provided by User A. Assume that the users store group mem-

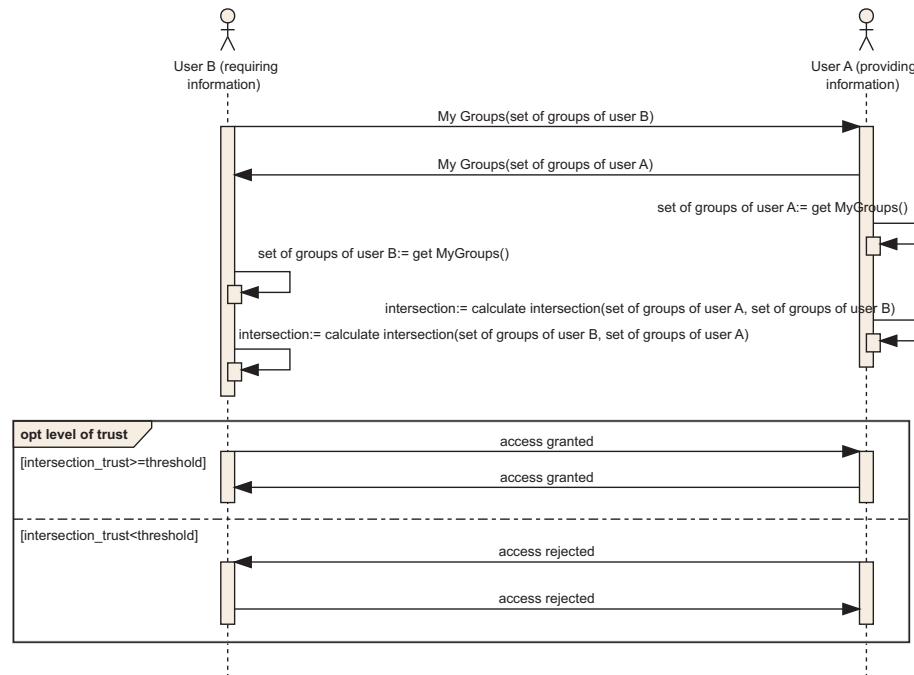

Figure 1: Extended motivation scenario

bership related information¹. At first users exchange their group memberships. Then both retrieve their own groups memberships (possibly securely stored in a private place) and compute intersections – groups they are both members. If the intersection comprises a trusted group(s) the access is granted, rejected otherwise. The point stressed is the ability to infer trust level between two users on their group memberships information. Such approach differs from traditional conception of trust [1], [2], [3], [4], [5], [6], [7], [8], [9], NoDeRanking [10] and it allows more flexibility and better accessibility of trust related information.

3. Dynamic Trust Model

A weighted oriented graph can be used to model trust on basic of relationships between two particular users. On the other hand, our comprehension of trust differs inasmuch as trust is maintained on the group memberships basics. Under such circumstances, the graph model is not sufficient. Therefore we use a hypergraphs with required abilities.

A hyperedge can connect arbitrary many vertices and one vertex can be a pin of more hyperedges [11]. Figure 2 shows a simple example of a hypergraph with 5 hyperedges and 8 vertices.

¹e.g. football players, lawyers, mathematicians

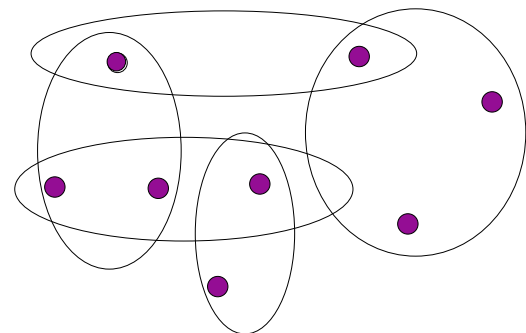

Figure 2: An example of a hypergraph

From the figure it follows that a hypergraph can describe a very complicated structure of groups of users straightforwardly. In addition, most of the important concepts from graphs can be easily generalized to hypergraphs. Further more, weights can be used in order to describe a structure of users more in details, not just who is connected to whom, but also reliability, security, error proneness or other additional properties needed.

Concrete relations between a hypergraph $\mathcal{H} = (U, N, W_U, W_N)$ and the structure of groups of users follows:

1. users equal to vertices U
2. user u_i related information (abilities, etc.) are described as the weight of vertex W_{u_i}

3. groups of users equal to hyperedges N
4. overall group security together with group related information equal to the weight of hyperedge W_{n_i}
5. pins of a hyperedge $pins(n_i)$ equals to the members of the group described by the hyperedge n_i
6. set of groups of a user u equals $hyperedges(u)$

In the rest of the paper Virtual Organization definition will be extended from its primary definition [12], [13]. In our case a VO is not a temporal but rather long-live coalition of users with the same or very similar intentions. The proposed model does not consider the only one VO but it is rather concern with a set of interconnected VOs.

4. Dynamic Virtual Organization Evolution

As we put stress on the fact that trust is not a static phenomena, but rather a dynamic concept, the following introduces the algorithms for dynamic trust management.

4.1. G2H Algorithm

As the security model maintains dynamic VOs as hypergraphs, it is necessary to propose a transformation of a general input structure into hypergraphs.

The transformation cannot be done arbitrary but it must consider a semantics of the input graph – social relationships among users. The main task of the transformation is to identify highly correlated substructures and transforms them into a groups of users (hyperedges).

4.1.1 G2H Based on Search for Strongly Connected Components: The main idea of this version of the algorithm is to identify strongly connected components in the input graph and creates hyperedges from the components. The basic idea is rather simple; if any two vertices A,B are in the same strongly connected component there must exist an oriented path connecting vertex A with vertex B. In the social network point of view, such vertices (users) have direct knowledge about themselves or can infer mutual relationship trough the other vertices (users).

4.1.2 G2H Based on Search for Triads: The second version of the algorithm based on triads [14] was proposed due to the inability of the first version to cope with dense input graphs.

Figure 3 graphically shows the main idea of the algorithm with comments provided. If any two vertices are

connected as most as possible they must have mutual relationship. In graph point of view, we are looking for a complete graph of size two (K_2). Case a), in the figure, shows a creation of a seed K_2 from vertices V_1 and V_2 . If found then the algorithm searches for any vertex V_3 connected to the seed by an acceptable triad (case b)). Let V_1 and V_2 identified as a seed and subsequently merged during the step c). If there existed the vertex V_3 then the precedent merging initiated the creation of a new K_2 (case d)). Thence, vertex V_3 is merged with the seed during the next step returning to case b).

The G2H algorithm works in this way until all vertices are examined resulting in partitions of vertices ($h_i \in H$) of the input graph.

4.2. SD Algorithm

The dynamics of the model corresponds to the fact that users must react to changes they are posed to in their real lives. The dynamics has further been claimed to be the crucial point for systems coping with security hazards in particularly distributed environments. Therefore, this section introduces the dynamic part of the security model – the SD algorithm.

The SD algorithm must preserve local security of the users in groups, thus maintaining the overall security. Since the model is totally distributed with no centralized control it is not an easy task.

The following list gives an overview on events that are possible through the evolution of a VO:

1. addition of a new member
2. deletion of a member
3. change in users' relationships

The SD algorithm takes care for each listed action separately as the actions related to the events are not equal.

The input of the SD algorithm is a quadriple (u_1, n_1, u_2, n_2) where the following holds: user u_1 from group n_1 is invited by user u_2 from group n_2 to group n_2 . The algorithm begins with a procedure that compares the weights (level of trust) of groups n_1 and n_2 . If the difference is less than a predefined threshold ϵ then user u_1 is simply added to group n_2 , otherwise is triggered the split net procedure. The split net procedure splits a group with a higher level of trust. After splitting or adding procedure is triggered the merging procedure. It merges groups with $intersection = |n_1 \cap n_2|$ larger than a threshold λ .

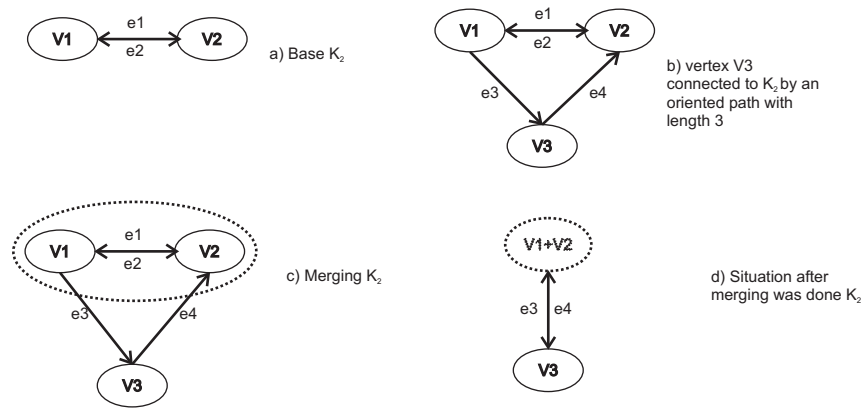

Figure 3: G2H algorithm for transforming edges into nets

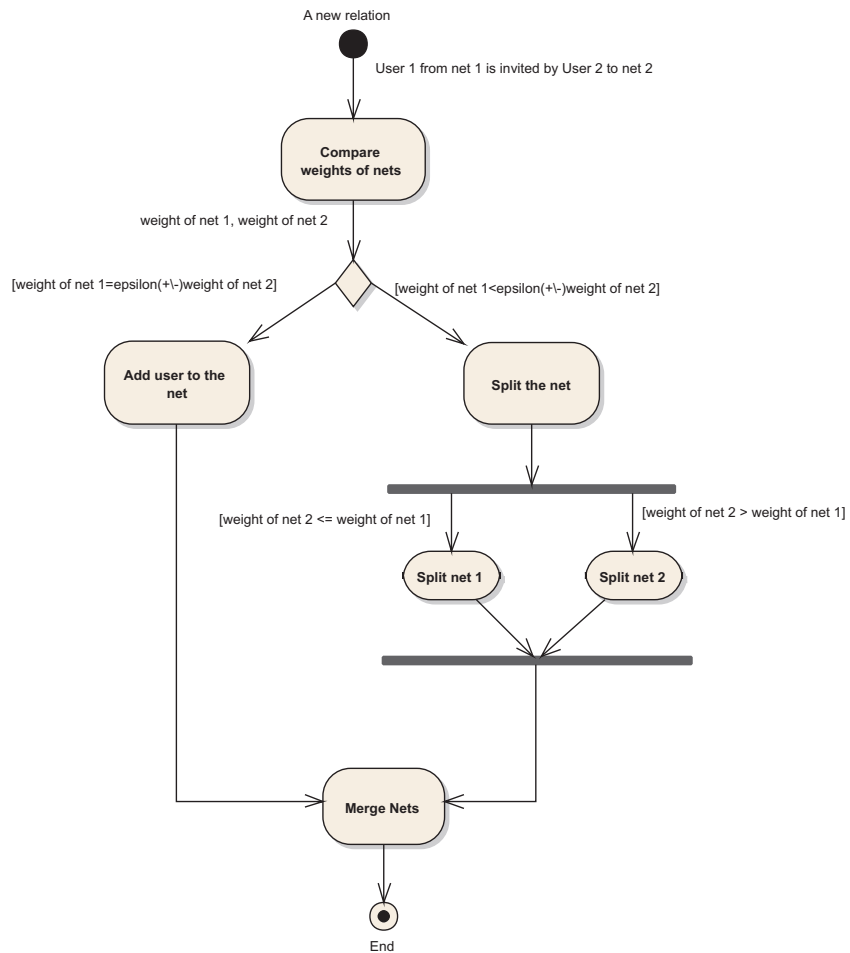

Figure 4: UML activity diagram describing the SD algorithm

In other words, at the beginning there is a new invitation issued by User 1 to User 2. *Compare weights of nets* procedure computes the difference in trust levels between the groups. If this difference is lower than a threshold then groups share the same or almost the same trust and the new user is welcome. If the difference is higher then *split the net* procedure preserves the trust of the group by isolating potentially untrusted users. The splitting procedure is given more in details in Figure 5.

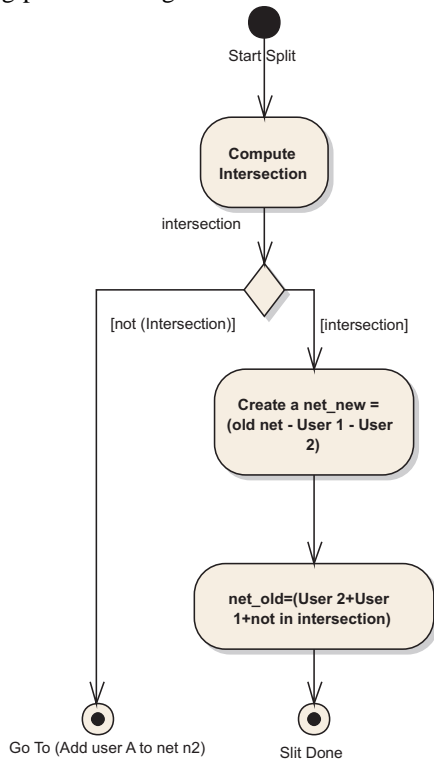

Figure 5: UML activity diagram describing the split procedure of the SD algorithm described

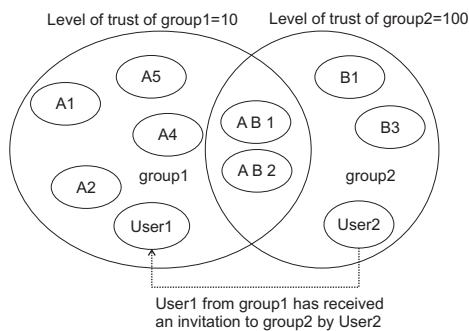

Figure 6: Initial configuration

At first, the procedure tries to identify the users that are member of both groups (net 1 and net 2). If no intersection exists user is simply added to the group (net 2). If the intersection is nonempty it implies the fact that some users have known each other from both groups and

together with the bigger difference in levels of trust it suggest a possible trust violation. Therefore the group with higher level is split, as shown in the figure. The old group contains users not involved in intersection together with User 1 and User 2, whereas the new group composes members of the former, now split, group apart from User 1 and User 2.

Figures 6 and 7 graphically show the splitting procedure. At the beginning (Figure 6) there are two groups with different level of trust and two users in the intersection (AB1, AB2). Furthermore, User2 issues an invitation for User1. The next Figure 7 shows the final state after splitting. Whereas group1 remains unchanged, group group2 is divide into group2 old and group2 new.

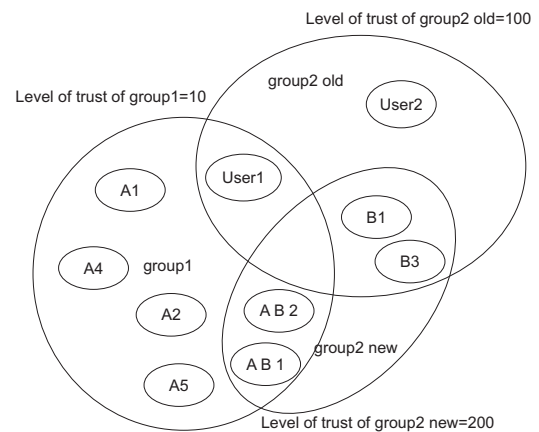

Figure 7: Situation after splitting

5. Experimental Results

The stability of the dynamic part (SD algorithm) was verified by an experimental implementation SecGRID. The SecGRID implements the SD algorithm with two main parameters influencing overall behavior of the SD algorithm:

- Parameter λ influences the merging procedure. The size of intersection is compared to λ and if higher the groups are merged.
- Parameter ϵ controls the splitting procedure. The higher ϵ the higher probability of splitting the groups.

The experiments were done for three different combination of the parameters covering all possible combinations. The input to the SD algorithm was a real social network extracted from data describing calls realized in a mobile network in the Slovak republic. The data contains records as quartets (*recipient, sender, type of the*

request, duration). For the experiment were extracted 161 404 records of phone calls among 121 672 users.

At the beginning an initial system of 908 groups each containing 134 users was created with the equal level of trust. The SecGRID then fetches records one by one from the input set. Each record expressed the fact that the *recipient* invites *sender* to one of the groups the recipient is member (SecGRID chose concrete group randomly from the set of groups of the recipient).

In the following figures are shown three main dependencies (given in the same order as in the list):

- set of histograms (absolute frequency as a function of size of groups)
- detailed final histogram (absolute frequency as a function of size of groups)
- dependency of the size of groups on cycles completed

The figures shown the evolution of the system of the groups. The experiments shown that despite different parameters, the SD algorithm tends to achieve stability (the same distribution of the groups of users) round cycle 70 000. The main differences between the simulations with various parameters are mainly visible in the first half of the histograms where the shapes visibly differ. After the first half (round cycle 70 000) the shapes do not differ much and the system remains stable for the rest of the experiment.

A very interesting is the sudden decrease in minimal size of group in Figures 10,13,16. Currently, we cannot explain the reason, but it seems to be the most probably that the input data contains a dangerous configuration that results in sudden splitting of the groups.

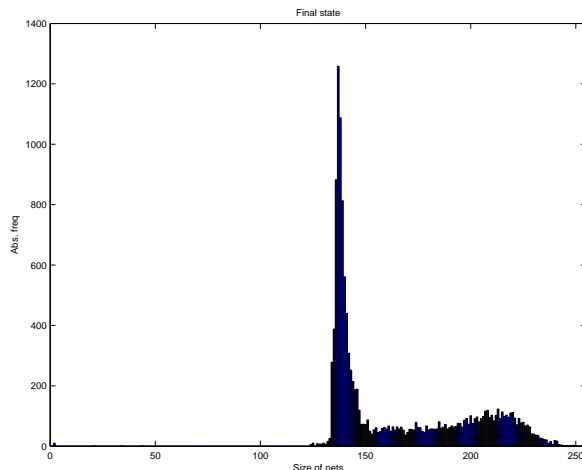

Figure 8: The final histogram for $\lambda=1$, $\epsilon=1$, starting amount of groups=908

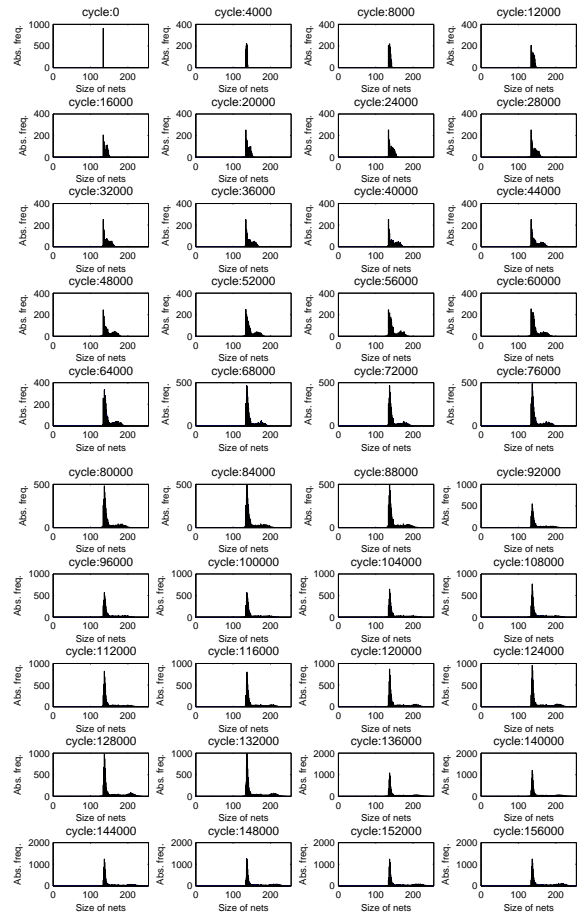

Figure 9: Histograms for $\lambda=1$, $\epsilon=1$, starting amount of groups=908

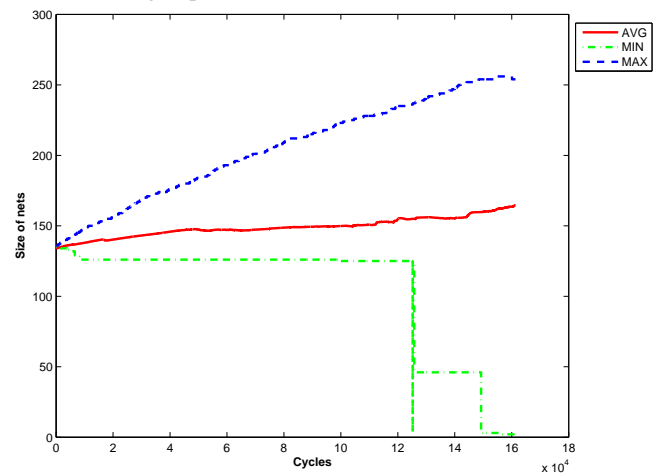

Figure 10: The dependency of the size of net on cycle completed for $\lambda=1$, $\epsilon=1$, starting amount of groups=908

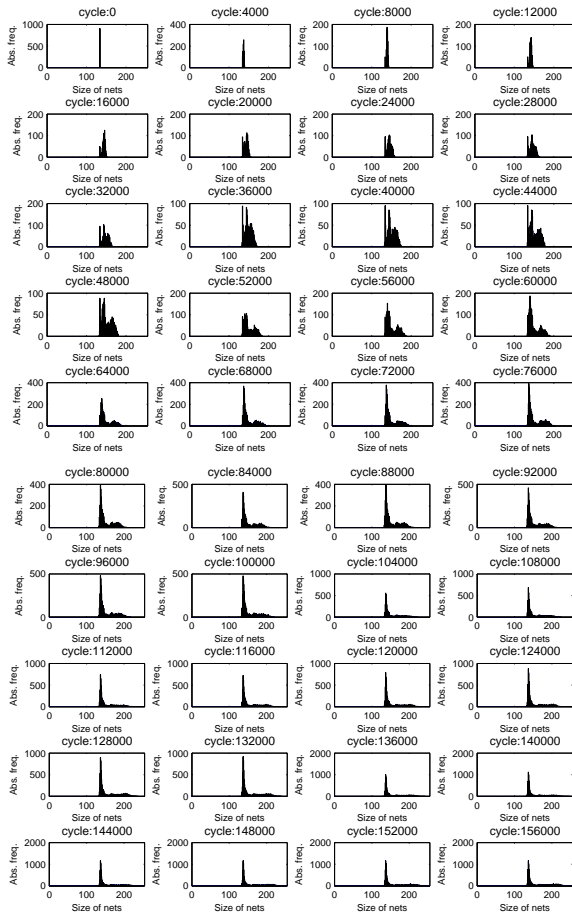

Figure 11: Histograms for $\lambda=1$, $\epsilon=3$, starting amount of groups=908

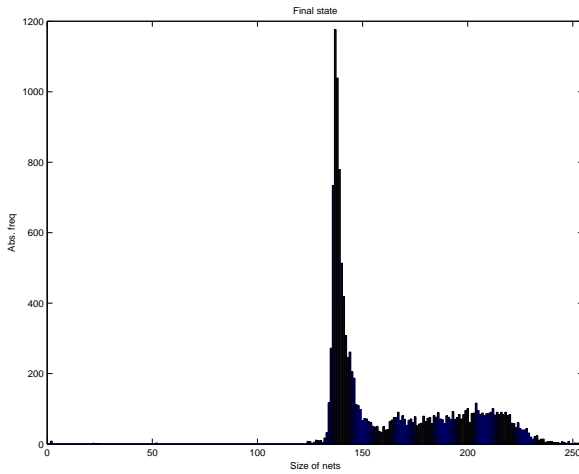

Figure 12: The final histogram for $\lambda=1$, $\epsilon=3$, starting amount of groups=908

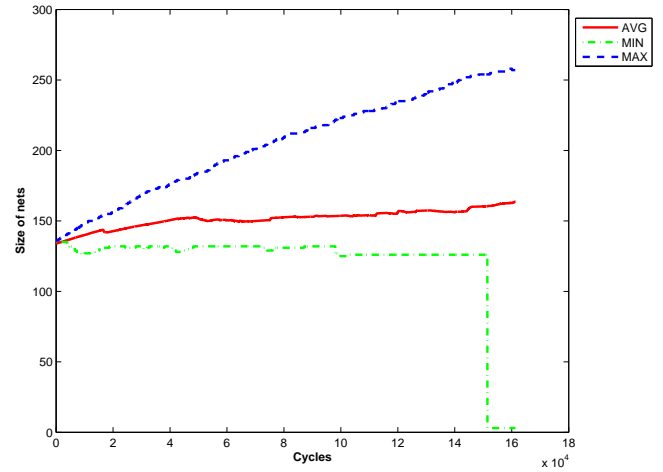

Figure 13: The dependency of the size of net on cycle completed for $\lambda=1$, $\epsilon=3$, starting amount of groups=908

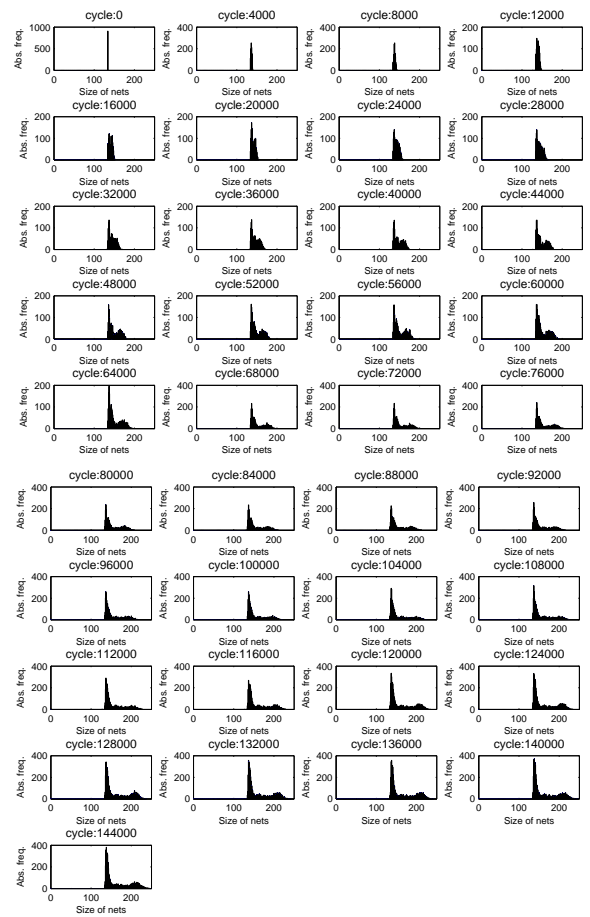

Figure 14: Histograms for $\lambda=3$, $\epsilon=1$, starting amount of groups=908

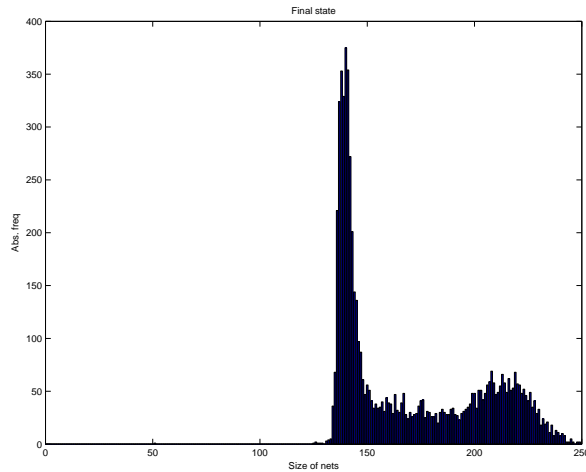

Figure 15: The final histogram for $\lambda=3$, $\epsilon=1$, starting amount of groups=908

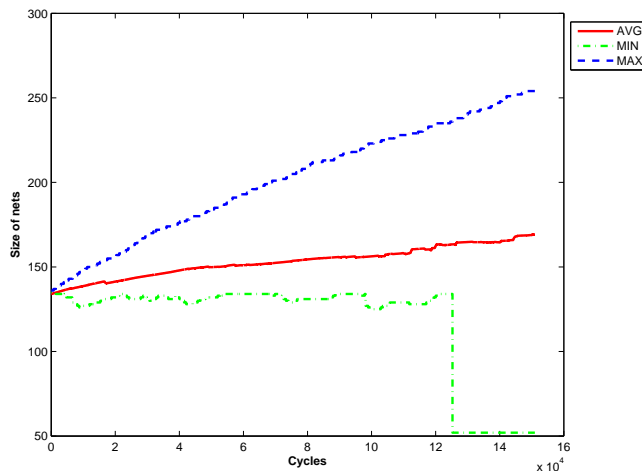

Figure 16: The dependency of the size of net on cycle completed for $\lambda=3$, $\epsilon=1$, starting amount of groups=908

A detailed investigation into the input records is in our plan for the future work, but it is noticeable that the size of the input makes this very complicated.

6. Conclusions

The paper presents an approach for treating security, privacy and trust in a distributed and dynamic environment. The approach takes advantages of the reputation systems based on social networks together with the advantages of weighted hypergraphs for storage and management of groups of users organized in dynamic Virtual Organizations. The model is naturally distributed. The most important question whether the model can be consistently developed was positively answered by our experiments with a real data as the inputs.

References

- [1] E. Damiani, S. D. C. di Vimercati, S. Paraboschi, P. Samarati, and F. Violante, “A reputation-based approach for choosing reliable resources in peer-to-peer networks.,” *In Proceedings of ACM Conference on Computer and Communications Security*, p. 202–216, 2002.
- [2] S. Lee, R. Sherwood, and et al., “Cooperative peer groups in nice.,” *IEEE Infocom, San Francisco, USA*, 2003.
- [3] M. Gupta, P. Judge, and et al., “A reputation system for peer-to-peer networks.,” *Thirteenth ACM International Workshop on Network and Operating Systems Support for Digital Audio and Video, Monterey, California.*, 2003.
- [4] S. Kamvar, M. Schlosser, and et al., “The eigentrust algorithm for reputation management in p2p networks.,” *WWW, Budapest, Hungary*, 2003.
- [5] S. D. Kamvar, M. T. Schlosser, and H. Garcia-Molina, “Eigenrep: Reputation management in p2p networks.,” *In Proceedings of 12th International WWW Conference*, p. 640–651, 2003.
- [6] C. Duma, N. Shahmehri, and G. Caronni, “Dynamic trust metrics for peer-to-peer systems.,” *In Proceedings of 2nd IEEE Workshop on P2P Data Management, Security and Trust (in connection with DEXA’05)*, August 2005.
- [7] L. Kagal, T. Finin, and A. Joshi, “A policy based approach to security for the semantic web.,” *In Proceedings of the 2nd International Semantic Web Conference, Sanibel Island, Florida, USA*, Oct. 2003.
- [8] G. Tonti, J. M. Bradshaw, R. Jeffers, R. Montanari, N. Suri, and A. Uszok, “Semantic web languages for policy representation and reasoning: A comparison of kaos, rei and ponder.,” *In Proceedings of the 2nd International Semantic Web Conference, Sanibel Island, Florida, USA*, Oct. 2003.
- [9] J. Sabater and C. Sierra, “Regret: A reputation model for gregarious societies.,” *4th Workshop on Deception, Fraud and Trust in Agent Societies, Montreal, Canada.*, 2001.
- [10] J. Pujol, R. Sanguesa, and et al., “Extracting reputation in multi agent systems by means of social network topology.,” *First International Joint Conference on Autonomous Agents and Multi-Agent Systems, Bologna, Italy.*, 2002.
- [11] M. Golumbic, *Algorithmic graph theory and perfect graphs*. Academic Press, 1980.
- [12] I. Foster, C. Kesselman, J. Nick, and S. Tuecke, “The physiology of the grid: An open grid services

- architecture for distributed systems integration,” <http://www.globus.org/research/papers/ogsa.pdf>, citeseer.ist.psu.edu/foster02physiology.html, 2002.
- [13] I. Foster, C. Kesselman, and S. Tuecke, “The anatomy of the grid: Enabling scalable virtual organizations,” *International J. Supercomputer Applications*, vol. 15(3), 2001.
- [14] V. Batagelj and A. Mrvar, “Pajek analysis and visualization of large networks,” *Proceedings Graph Drawing*, vol. 41, pp. 477–478, 2002.

Confidence of Classification in Classifier Combining

Post-Graduate Student:

ING. DAVID ŠTEFKA

Institute of Computer Science of the ASCR, v. v. i.
Pod Vodárenskou věží 2

182 07 Prague 8, CZ

stefka@cs.cas.cz

Supervisor:

ING. RNDR. MARTIN HOLEŇA, CSc.

Institute of Computer Science of the ASCR, v. v. i.
Pod Vodárenskou věží 2

182 07 Prague 8, CZ

martin@cs.cas.cz

Field of Study:
Mathematical Engineering

The research reported in this paper was partially supported by the Program "Information Society" under project 1ET100300517.

Abstract

Classifier combining is a successful method for improving the quality of classification. In this paper, we introduce the concept of confidence of classification and define two confidence measures – the local accuracy and the local class separability. We propose a simple classifier aggregation algorithm which uses the concept of confidence, the Filtered Mean Value Aggregation algorithm. This algorithm outperforms two commonly used methods for classifier combining on two datasets. We show that by incorporating confidence into classifier aggregation algorithms, we can improve state-of-the-art methods for classifier combining.

1. Introduction

The literature shows that a team of multiple classifiers can perform the classification task better than any of the individual classifiers. However, to achieve this, the classifier outputs have to be combined wisely. For this purpose, many methods have been introduced in the literature. These can be grouped into classifier selection and classifier aggregation.

In classifier selection, some rule is used to determine which classifier to use for the current pattern; only this "expert" classifier is then used for the final prediction, and the rest of the team is discarded. In classifier aggregation, outputs of all the classifiers are aggregated into the final decision.

Common drawback of classifier aggregation methods is that they are *global*, i.e., they do not adapt themselves to the particular patterns to classify. In other words, the combination is specified during a training phase, prior to classifying a test pattern. A typical example is that if we use the weighted mean aggregation rule, the weights of the individual classifiers are usually based on the classifiers' accuracies. While it is true that if a classifier has high accuracy, its weight should be higher, still, for the *current pattern*, some other classifier could be more suitable.

While classifier selection methods use some techniques

to determine which classifier is *locally* better than the others, such algorithms select only one classifier, discarding much potentially useful information, thus reducing the robustness compared to classifier aggregation.

In this paper, we try to identify the strong points of classifier selection techniques and incorporate them into classifier aggregation methods. This will enable us to create novel methods for classifier aggregation which can provide better results than state-of-the-art methods for classifier combining on two datasets.

We introduce the concept of *confidence* of classification, which can be used both as a criterium for classifier selection and for improving classifier aggregation. We define two confidence measures, and propose an algorithm for classifier aggregation which utilizes the concept of confidence. We then show that this algorithm outperforms two commonly used methods for classifier combining.

The paper is structured as follows: Section 2 describes the basics of classification and classifier combining, and summarizes methods for classifier selection and classifier aggregation. Section 3 then introduces the concept of confidence of classification. Section 4 presents the experimental results. Finally, Section 5 then concludes the paper.

2. Classifier Combining

Throughout the rest of the paper, we use the following notation. Let $\mathcal{X} \subseteq \mathbf{R}^n$ be a n -dimensional *feature space*, an element $\vec{x} \in \mathcal{X}$ of this space is called *pattern*, and let $C_1, \dots, C_N \subseteq \mathcal{X}$ be disjoint sets called *classes*. The goal of classification is to determine to which class a given pattern belongs. We call a *classifier* any mapping ϕ from the following:

- *possibilistic classifier* – $\phi : \mathcal{X} \rightarrow [0, 1]^N$, where $\phi(\vec{x}) = (\mu_1, \dots, \mu_N)$ are *degrees of classification* to each class.
- *normalized possibilistic classifier* – $\phi : \mathcal{X} \rightarrow [0, 1]^N$, where $\phi(\vec{x}) = (\mu_1, \dots, \mu_N)$, $\sum_i \mu_i = 1$.
- *crisp classifier* – $\phi : \mathcal{X} \rightarrow \{1, \dots, N\}$, where $\phi(\vec{x})$ is the predicted class label of pattern \vec{x} . Crisp classifier can also be defined as a special case of a normalized possibilistic classifier, such that one degree of membership is equal to 1 and the others are equal to 0.

Normalized possibilistic classifiers are sometimes called *probabilistic* [1]. However, they do not need to be based on probability theory, so we will call them normalized possibilistic. Other types of classifiers, such as *rank classifier* [2], can be defined, but we deal with crisp and possibilistic classifiers only in the rest of the paper. The conversion of a possibilistic classifier ϕ_p to a crisp classifier ϕ_c is called *hardening*:

$$\phi_c(\vec{x}) = \arg \max_{i=1, \dots, N} \{\mu_i\}, \quad (1)$$

where $\phi_p(\vec{x}) = (\mu_1, \dots, \mu_N)$.

In classifier combining, we create a team of classifiers, let each of the classifiers predict independently, and then combine the classifiers' outputs into one final classifier. This combined classifier can perform its classification task better than any of the individual classifiers in the team. Methods which use more or less this idea can be found under many names in the literature – *classifier combining*, *classifier aggregation*, *classifier fusion*, *classifier selection*, *mixture of experts*, *classifier ensembles*, etc. Basically, there are two main approaches to classifier combination:

- *classifier selection*, where we use some rule to determine which classifier to use for the current pattern; only this “expert” classifier is then used for the final prediction
- *classifier aggregation*, where all the classifiers in the team are used for the final decision

Classifier combining consists of two steps – first, we create a team of classifiers, and then we adopt some strategy to combine the classifiers' outputs into the final decision. The former step is common for both classifier selection and aggregation (algorithms for creating a team of classifiers are described in Sec. 2.1), while for the latter, different algorithms are needed (these are described in Sec. 2.2 and 2.3).

2.1. Ensemble Methods

If the team of classifiers consists only of classifiers of the same type, which differ only in their parameters, dimensionality, or training sets, the team is usually called an *ensemble* of classifiers. That is why the methods which create a team of classifiers are sometimes called *ensemble methods*. The restriction to classifiers of the same type is not essential, but it ensures that the outputs of the classifiers are consistent.

Well-known methods for ensemble creation are *bagging* [3], *boosting* [4], error correction codes [5], or *multiple feature subset* (MFS) methods [6]. These methods try to create an ensemble of classifiers which are both *accurate* and *diverse* (in the sense that they predict differently).

Diversity of the ensemble is thought to be a crucial issue for classifier combining; however, there is no generally accepted measure of diversity. In [7], 10 diversity measures are studied, resulting in the suggestion to use the Q statistics because of its simplicity.

2.2. Classifier Selection

Crisp classifiers are not much appropriate for classifier combining, because they do not provide information about degree of classification to each class. For these classifiers, only simple techniques like voting or single best selection can be used. That's the reason why we restrict to possibilistic classifiers in this paper. In the rest of the paper, we suppose that we have constructed an ensemble (ϕ_1, \dots, ϕ_r) of r possibilistic classifiers using some of the methods described in Sec. 2.1.

Classifier selection algorithms [8, 9, 10] use some criterion to determine which classifier is most suitable for the current pattern, and the output of this classifier is taken as the final result. The criterion for selection can be some global property of the ensemble, as in *single best selection* (SBS), or some local property, as in *dynamic best selection* (DBS).

In SBS, the criterion for selection is usually the validation error rate of the individual classifiers. The classifier with the lowest validation error rate is used for prediction of all the patterns (i.e. the other classifiers are en-

tirely discarded). In DBS, the classifier optimizing some local criterion (for example local accuracy of the classifier in neighborhood of the current pattern) is selected for the prediction.

2.3. Classifier Aggregation

For classifier aggregation, the output of the ensemble (ϕ_1, \dots, ϕ_r) for input pattern \vec{x} can be structured to a $r \times N$ matrix, called *decision profile* (DP):

$$DP(\vec{x}) = \begin{pmatrix} \phi_1(\vec{x}) \\ \phi_2(\vec{x}) \\ \vdots \\ \phi_r(\vec{x}) \end{pmatrix} = \begin{pmatrix} \mu_{1,1} & \mu_{1,2} & \dots & \mu_{1,N} \\ \mu_{2,1} & \mu_{2,2} & \dots & \mu_{2,N} \\ & & \ddots & \\ \mu_{r,1} & \mu_{r,2} & \dots & \mu_{r,N} \end{pmatrix} \quad (2)$$

The i -th row of $DP(\vec{x})$ is an output of the corresponding classifier ϕ_i , and the j -th column contains the degrees of classification of \vec{x} to the corresponding class C_j given by all the classifiers.

Many methods for aggregating the ensemble of classifiers into one final classifier have been reported in the literature. A good overview of the commonly used aggregation methods can be found in [1]. These methods comprise simple arithmetic rules (sum, product, maximum, minimum, average, weighted average, see [1, 11]), fuzzy integral [1, 12], Dempster-Shafer fusion [1, 13], second-level classifiers [1], decision templates [1], and many others.

In this paper, we introduce the concept of *confidence* of classification, which can be used both as a criterion for classifier selection, and for improving classifier aggregation by filtering the worst classifiers in the team. The concept of confidence is described in the next section.

3. Confidence Classifiers

The classifiers defined in Sec. 2 (both crisp and possibilistic) give us information about the *evidence* of classification (i.e., degrees of classification) of the current pattern \vec{x} . This is all we need to know if we are classifying patterns using a single classifier. However, in classifier combining, we have a team of classifiers, and the information about “how can we trust the output of classifier ϕ_i ” could be very useful. For this purpose, we introduce a concept of *confidence* of classification.

The concept of confidence is not new to classifier combining – in classifier selection, the criteria for selection can be viewed as some confidence measures. In weighted mean classifier aggregation, the individual classifiers’ error rates (which can again be viewed as some confidence measure) are used to adapt the weights of

the individual classifiers etc. In this paper, we try to generalize different methods which use this approach, and incorporate all of them into the concept of confidence. This enables us to create general algorithms for classifier aggregation, which use some properties of classifier selection, improving both classifier aggregation and classifier selection. This is what makes the approach novel.

Suppose we have a classifier ϕ , and a pattern \vec{x} to classify. The confidence of classification of the pattern \vec{x} using classifier ϕ is a real number in the unit interval $[0, 1]$, and we model it by a mapping $\kappa_\phi : \mathcal{X} \rightarrow [0, 1]$. The mapping κ_ϕ will be called *confidence measure*, and the tuple (ϕ, κ_ϕ) will be called *confidence classifier*.

The confidence of classification $\kappa_\phi(\vec{x})$ can be any property estimating the degree to which we can trust the output of ϕ for current pattern \vec{x} . In this paper, we will use the following two confidence measures:

- *local accuracy* with parameter k – LA(k)

LA(k) is commonly used criterion for classifier selection [10]. The confidence of classification of \vec{x} using ϕ is defined as the estimate of local accuracy of ϕ near \vec{x} . Let $N_k(\vec{x})$ denote the set of k nearest neighbors from the training (or validation) set, closest to \vec{x} under Euclidean metric. Then $\kappa_\phi^{LA(k)}(\vec{x})$ is defined as the ratio of the number of patterns from $N_k(\vec{x})$ classified correctly by ϕ to the number of all patterns from $N_k(\vec{x})$.

- *local class separability* – (LCS)

This approach is based on the fact that if the degree of classification to some class is high, and degrees of classification to the remaining classes are low, then the classification is probably right, i.e., the confidence should be high. On the other hand, if all the degrees of classification have similar values, then the confidence should be low. Let ϕ be a normalized possibilistic classifier, $\phi(\vec{x}) = (\mu_1, \dots, \mu_N)$. Then the LCS confidence of classification is defined using the following formula:

$$\kappa_\phi^{LCS}(\vec{x}) = \frac{1}{(N-1)} \sum_{i=1}^{N-1} \sum_{j=i+1}^N |\mu_i - \mu_j| \quad (3)$$

Proposition 1 *Let ϕ be a normalized possibilistic classifier, i.e. $\sum_{i=1}^N \mu_i = 1$. Then $\kappa_\phi^{LCS}(\vec{x}) \in [0, 1]$.*

Proof: Let $C = \sum_{i=1}^{N-1} \sum_{j=i+1}^N |\mu_i - \mu_j|$. Without loss of generality, let $\mu_1 \geq \mu_2 \geq \dots \geq \mu_N$ – under such conditions the absolute values va-

nish. It is easy to show that

$$C = \sum_{i=1}^{N-1} \mu_i + \sum_{i=1}^{N-2} \mu_i + \cdots + \mu_1 - \sum_{i=2}^N \mu_i - \sum_{i=3}^N \mu_i - \cdots - \mu_N, \quad (4)$$

hence

$$C \leq \sum_{i=1}^{N-1} \mu_i + \sum_{i=1}^{N-2} \mu_i + \cdots + \mu_1, \quad (5)$$

and because $\sum_{i=1}^{N-j} \mu_i \leq 1 \forall j = 1, \dots, N-1$, we get

$$C \leq (N-1), \quad (6)$$

which proves that $\kappa_{\phi}^{LCS}(\vec{x}) \leq 1$. The fact that $\kappa_{\phi}^{LCS}(\vec{x}) > 0$ is trivial. ■

We give some examples of LCS for different outputs of normalized possibilistic classifiers:

- $\phi(\vec{x}) = (1, 0, 0, 0)$ – the degree of classification to one of the classes is maximal, and the others are 0. The confidence should be high, and indeed, $\kappa_{\phi}^{LCS}(\vec{x}) = 1$.
- $\phi(\vec{x}) = (0.8, 0, 0.2, 0)$ – there is some small ambiguity in the classification. The confidence drops to $\kappa_{\phi}^{LCS}(\vec{x}) = 0.86$.
- $\phi(\vec{x}) = (0.5, 0.5, 0, 0)$ – the degrees of classification to the first and second class are the same. $\kappa_{\phi}^{LCS}(\vec{x}) = 0.66$
- $\phi(\vec{x}) = (0.4, 0.4, 0.2, 0)$ – ambiguity increases, but still $\mu_4 = 0$. $\kappa_{\phi}^{LCS}(\vec{x}) = 0.46$
- $\phi(\vec{x}) = (0.4, 0.4, 0.1, 0.1)$ – all the degrees of classification are > 0 . $\kappa_{\phi}^{LCS}(\vec{x}) = 0.4$
- $\phi(\vec{x}) = (0.25, 0.25, 0.25, 0.25)$ – all the degrees of classification are the same, confidence should be minimal. $\kappa_{\phi}^{LCS}(\vec{x}) = 0$

The examples above show that LCS expresses some measure of confidence of classification using normalized possibilistic classifiers. However, the formula (3) can not be used for non-normalized classifiers:

- $\phi(\vec{x}) = (1, 0, 0, 0)$ – $\kappa_{\phi}^{LCS}(\vec{x}) = 1$. This is as expected.
- $\phi(\vec{x}) = (1, 1, 0, 0)$ – in this case, we do not know to which of the classes C_1 or C_2 to classify, so the confidence should be lower; however $\kappa_{\phi}^{LCS}(\vec{x}) = 1.33$.

This behavior implies that (3) has to be modified for non-normalized classifiers. However, all the classifiers we used in our experiments were normalized, so we used LCS in the form of (3).

The advantage of LCS over LA is its lower time complexity. While LA needs to find the set of neighbors, and to classify all of them, LCS performs only a simple arithmetic operation on a vector of length N .

State-of-the-art methods for classifier combining do not use both evidence and confidence of classification heavily. In classifier selection, confidence is used to select a classifier, and the evidence of other classifiers is discarded. Simple algorithms for classifier aggregation (mean value, product, maximum, minimum, etc.) use the evidence of classification only, and they disregard the confidence. Advanced classifier aggregation methods (weighted mean, fuzzy integral, etc.) incorporate confidence into aggregation, but only global confidence measures (i.e., measures independent on the current pattern, e.g. based on validation accuracy of the classifiers) are commonly used.

However, by incorporating local confidence measures (like LA or LCS) into such algorithms, their performance could be improved. To show this, we propose a simple classifier aggregation algorithm, which utilizes the concept of confidence of classification, the Filtered Mean Value Aggregation algorithm, and study its performance on two datasets. The details are given in the next section.

4. Experiments

To show that the concept of confidence of classification can improve state-of-the-art methods for classifier combining, we developed a simple algorithm, called Filtered Mean Value Aggregation (FMVA), and compared it to two other methods, Dynamic Best Selection (DBS) and Mean Value Aggregation (MVA), on two datasets from the UCI repository [14] – the Pima and Balance datasets.

The algorithms used in the experiments are described in the next section.

4.1. Algorithm Description

Let (ϕ_1, \dots, ϕ_r) be a team of classifiers, (2) the output of the team for a pattern \vec{x} .

1. *Mean Value Aggregation* – MVA is an classifier aggregation method. MVA computes mean value of degree of classification to each class, i.e. the

aggregated degree of classification to class C_j is defined as the average of the degrees of classification to class C_j through all the classifiers in the team:

$$\mu_j = \frac{1}{r} \sum_{i=1}^r \mu_{i,j}. \quad (7)$$

2. *Filtered Mean Value Aggregation* – FMVA is a modification of MVA, the difference being that prior to computing the mean value, classifiers with confidence of classification of the current pattern lower than some threshold T are discarded. If $T = 0$, FMVA coincides with MVA. If there are no classifiers with confidence higher than T (i.e., all the classifiers would be discarded), T is lowered to the value of maximal confidence in the team.
3. *Dynamic Best Selection* – DBS is a classifier selection algorithm. From the team (ϕ_1, \dots, ϕ_r) , the classifier with the maximal confidence κ_{max} is selected. If there is more than one classifier with confidence κ_{max} , a random one among them is selected.

4.2. Experimental Results

For the experiments, we used an ensemble of classifiers (ϕ_1, \dots, ϕ_r) , constructed using the Multiple Feature Subset method, i.e., we created classifiers with all possible combinations of features (all 1-D classifiers, all 2-D classifiers, etc.). As the Balance dataset is 4-D, the resulting ensemble consisted of 15 classifiers, and as the Pima dataset is 8-D, the resulting ensemble consisted of 255 classifiers.

For the Pima dataset, the base classifiers were Bayesian classifiers [15], for the Balance dataset, we used Fuzzy k -NN classifiers [16].

The combination of the ensemble was done using the MVA (classifier aggregation), FMVA (with threshold T increasing from 0.1 to 1.0 – i.e., with increasing classifier-selection-like behavior), and DBS (classifier selection) methods. As confidence measures for FMVA and DBS, we used both LA(20) and LCS. All the algo-

gorithms were implemented using the Java programming language.

The results from experimental testing on the Pima and Balance datasets are shown in Fig. 1 and 2, respectively. We measured mean test error rate and standard deviation of test error rate (in %) from 10-fold crossvalidation.

From the figures, we can see that FMVA performs most often better than both of the other two methods. For the Pima dataset, MVA achieves about 26% error rate, DBS with LA(20) confidence measure about 28%, DBS with LCS confidence measure about 25%. By fine-tuning the threshold for FMVA, we can achieve less than 24% error rate.

For the Balance dataset, the improvement is even more apparent – MVA achieves about 18.5%, DBS with LA(20) nearly 20%, DBS with LCS nearly 25%, while FMVA can be fine-tuned to approx. 14% for both LA(20) and LCS.

In all of the four figures, we can see the following trend: with increasing T , the error rate first decreases to some point, and then it starts to increase again. This can be interpreted as follows: if T is too low, classifiers with low confidence (which probably yield incorrect predictions) are used in the aggregation, confusing the rest of the team. If the threshold is too high, there is only a small number of classifiers (or just one in the extreme case) used in the aggregation, and the team is less robust to outliers. For some value of T , these two aspects balance, resulting in enough classifiers with reasonably good confidence.

What could be somewhat surprising on the first sight, is the relatively big gap between DBS and FMVA with $T = 1$, which is particularly apparent for the Balance dataset. This is in contrast with the guess that these two algorithms should perform comparably. However, this notion is incorrect – in DBS, always only one classifier is used, while in the case of FMVA with $T = 1$, there is usually more than one classifier with confidence equal to one (or less than one if T has to be lowered), so the prediction is always based on aggregation of some small number of classifiers. As the figures show, even such detail can improve the classification slightly.

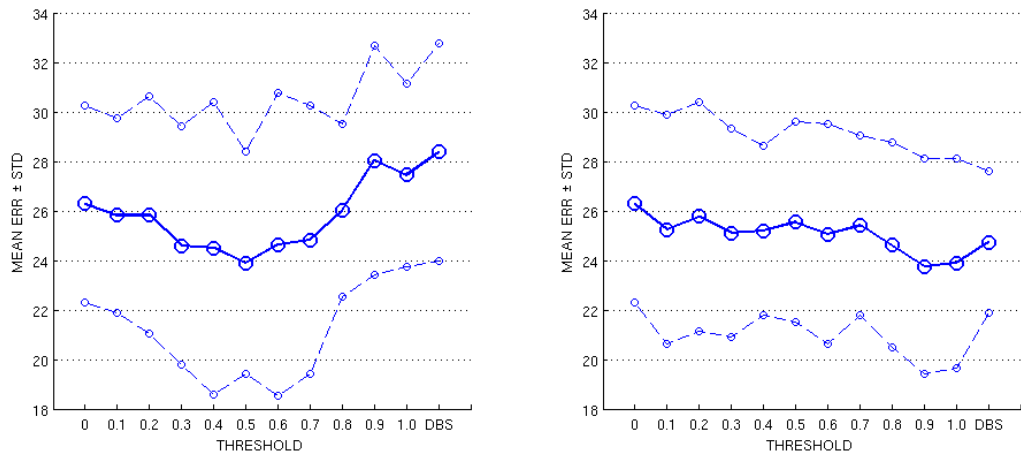

Figure 1: Mean \pm standard deviation of the test error rate for the Pima dataset for MVA ($Threshold = 0$), FMVA ($Threshold = 0.1 - 1$), and DBS. Two confidence measures were used – LA(20) (left) and LCS (right).

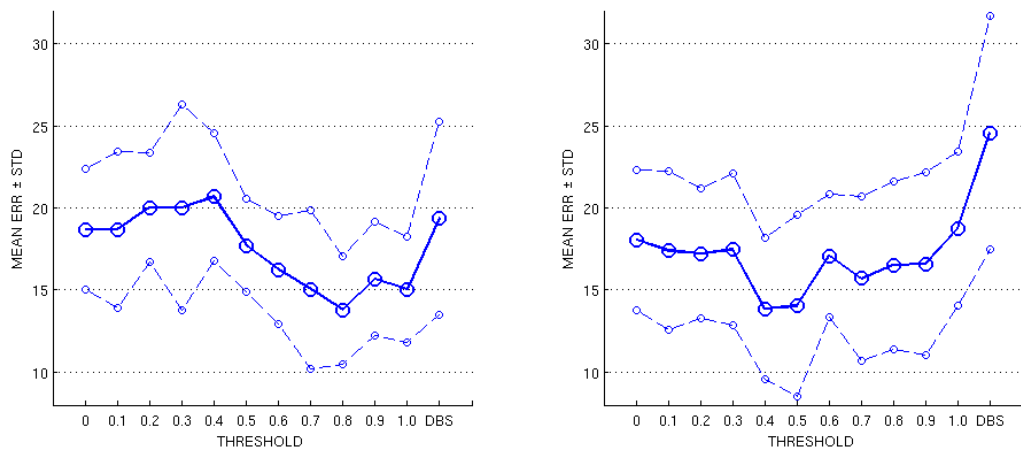

Figure 2: Mean \pm standard deviation of the test error rate for the Balance dataset for MVA ($Threshold = 0$), FMVA ($Threshold = 0.1 - 1$), and DBS. Two confidence measures were used – LA(20) (left) and LCS (right).

5. Summary

In this paper, we introduced the concept of confidence of classification, which can be used both as a criterium for classifier selection and for modifying classifier aggregation methods. We defined two confidence measures (the local accuracy and the local class separability), and introduced simple algorithm for classifier aggregation which uses the concept of confidence of classification – the Filtered Mean Value Aggregation algorithm. Experimental results show that even such a simple modification of the Mean Value Aggregation algorithm can yield improvements in the classification.

However, the concept of confidence of classification can

be incorporated into many classifier combining techniques, possibly resulting in very successful methods. In addition, other confidence measures than those reported in this article can be used to further improve the algorithms. This is the topic of our future research.

References

- [1] L. I. Kuncheva, J. C. Bezdek, and R. P. W. Duin, “Decision templates for multiple classifier fusion: an experimental comparison,” *Pattern Recognition*, vol. 34, no. 2, pp. 299–314, 2001.
- [2] O. Melnik, Y. Vardi, and C.-H. Zhang, “Mixed group ranks: Preference and confidence in clas-

- sifier combination.," *IEEE Trans. Pattern Anal. Mach. Intell.*, vol. 26, no. 8, pp. 973–981, 2004.
- [3] L. Breiman, "Bagging predictors," *Machine Learning*, vol. 24, no. 2, pp. 123–140, 1996.
- [4] Y. Freund and R. E. Schapire, "Experiments with a new boosting algorithm," in *International Conference on Machine Learning*, pp. 148–156, 1996.
- [5] L. I. Kuncheva, "Using diversity measures for generating error-correcting output codes in classifier ensembles," *Pattern Recogn. Lett.*, vol. 26, no. 1, pp. 83–90, 2005.
- [6] S. D. Bay, "Nearest neighbor classification from multiple feature subsets," *Intelligent Data Analysis*, vol. 3, no. 3, pp. 191–209, 1999.
- [7] L. I. Kuncheva and C. J. Whitaker, "Measures of diversity in classifier ensembles," *Machine Learning*, vol. 51, pp. 181–207, 2003.
- [8] X. Zhu, X. Wu, and Y. Yang, "Dynamic classifier selection for effective mining from noisy data streams," in *ICDM '04: Proceedings of the Fourth IEEE International Conference on Data Mining (ICDM'04)*, (Washington, DC, USA), pp. 305–312, IEEE Computer Society, 2004.
- [9] M. Aksela, "Comparison of classifier selection methods for improving committee performance.," in *Multiple Classifier Systems*, pp. 84–93, 2003.
- [10] K. Woods, J. W. Philip Kegelmeyer, and K. Bowyer, "Combination of multiple classifiers using local accuracy estimates," *IEEE Trans. Pattern Anal. Mach. Intell.*, vol. 19, no. 4, pp. 405–410, 1997.
- [11] J. Kittler, M. Hatef, R. P. W. Duin, and J. Matas, "On combining classifiers," *IEEE Trans. Pattern Anal. Mach. Intell.*, vol. 20, no. 3, pp. 226–239, 1998.
- [12] L. I. Kuncheva, "Fuzzy versus nonfuzzy in combining classifiers designed by boosting," *IEEE Transactions on Fuzzy Systems*, vol. 11, no. 6, pp. 729–741, 2003.
- [13] M. R. Ahmadzadeh and M. Petrou, "Use of Dempster-Shafer theory to combine classifiers which use different class boundaries.," *Pattern Anal. Appl.*, vol. 6, no. 1, pp. 41–46, 2003.
- [14] C. B. D.J. Newman, S. Hettich and C. Merz, "UCI repository of machine learning databases," 1998. www.ics.uci.edu/~mllearn/MLRepository.html.
- [15] R. O. Duda, P. E. Hart, and D. G. Stork, *Pattern Classification (2nd Edition)*. Wiley-Interscience, 2000.
- [16] J. M. Keller, M. R. Gray, and J. A. Givens, Jr., "A fuzzy k-nearest neighbor algorithm," *IEEE Transactions on Systems, Man, and Cybernetics*, vol. SMC-15, no. 4, pp. 580–585, 1985.

Problematika integrace ontologií

doktorand:

ING. PAVEL TYL

Ústav informatiky AV ČR, v. v. i.
Pod Vodárenskou věží 2
182 07 Praha 8

Fakulta mechatroniky
Technická univerzita Liberec
Hájkova 6
461 17 Liberec 1

pavel.tyl@tul.cz

školitel:

ING. JÚLIUS ŠTULLER, CSC.

Ústav informatiky AV ČR, v. v. i.
Pod Vodárenskou věží 2
182 07 Praha 8

stuller@cs.cas.cz

obor studia:
Technická kybernetika

Práce byla částečně podpořena výzkumným centrem 1M0554 Ministerstva školství, mládeže a tělovýchovy České republiky: Pokročilé sanační technologie a procesy, projektem 1ET100300419 programu Informační společnost (Tematického programu II – Národního programu výzkumu v ČR: Inteligentní modely, algoritmy, metody a nástroje pro vytváření sémantického webu) a výzkumným záměrem AV0Z10300504 "Computer Science for the Information Society: Models, Algorithms, Applications".

Abstrakt

Internet je ohromným zdrojem provázaných, ale většinou neuspořádaných dat. Sémantický web, jako rozšíření webu současného, se snaží tuto neuspořádanost řešit a to nejen bezprostředně pro lidského uživatele, ale zejména z hlediska možnosti strojového zpracování informací. Cílem je doplnit data o metadata, která mají být srozumitelná jak pro člověka, tak pro počítač. Tato metadata jsou nejčastěji vyjádřena pomocí ontologií, které jsou jedním ze základních stavebních prvků sémantického webu. V příspěvku se snažím nastínit některé z možností integrace (slučování) ontologií za účelem sdílení informací.

1. Úvod

Internet je pozoruhodným informačním zdrojem. Svoboda, rozšířenost a téměř všudypřítomnost Internetu je ale zaplácena neuspořádaností většiny z něho dostupných informací, které jsou navíc velmi často bez logických návazností a vztahů. Hledané konkrétní informace nám tak mnohdy zůstanou skryty. Bez potřebné provázanosti zůstanou informace skrze svá podpůrná data obtížně vyhledatelné i pro stroje, které by jinak byly schopny nalezené výsledky dále zpracovávat pro různé skupiny uživatelů. Pokud by data na webu byla rozšířena o jejich význam, otevřelo by to široké možnosti při jejich sdílení, vyhledávání a znovupoužití. Tuto myšlenku se snaží rozvíjet vize sémantického webu [14].

2. Sémantický web

Tvůrce webu Tim Berners-Lee říká, že sémantický web není separátním webem, nýbrž je rozšířením webu současného. Sémantický web přiřazuje datům na webu přesný význam umožňující spolupráci lidí a softwaru [2]. V tomto ohledu se chová jako informační systém,

který má usnadnit cestu informace od jedné osoby ke druhé. Dnes se web dynamicky vyvíjí zejména jako zprostředkovatel dokumentů pro lidského uživatele. Sémantický web se snaží naopak vyzdvihnout automatické zpracování dat a informací pomocí počítačů a umožnit tak provoz inteligentních služeb. Aby mohl sémantický web vůbec fungovat, je třeba, aby počítače měly přístup ke strukturovaným souborům dat a zároveň srozumitelná pravidla k provádění automatických operací s těmito daty [1]. Na obrázku 1 je naznačena struktura sémantického webu.

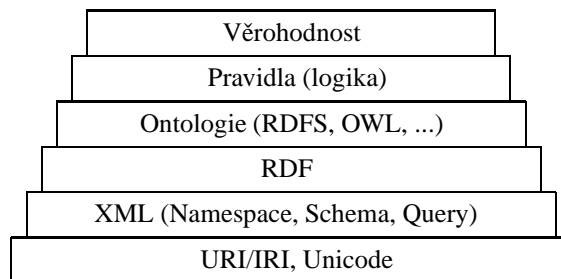

Obrázek 1: Vrstvy sémantického webu

Jak je vidět, tak pro vývoj sémantického webu jsou důležité mnohé technologie. Pod zkratkou RDF [12] si můžeme představit model pro reprezentaci dat uložených v jednotlivých zdrojích na webu. Zatímco XML [15] umožňuje uživatelům vytvářet vlastní struktury dokumentů, ale neříká nic o jejich významu, RDF umožňuje zachycení významu, a to v podobě trojic objekt–atribut–hodnota (podmět–přísudek–předmět). Konkrétní věci (lidé, webové stránky, tabulky nebo cokoli jiného) mají určité vlastnosti (atributy, predikáty – například být synem), které pak nabývají jistých hodnot (jiná osoba, jiná webová stránka atd.). Objekt, atribut i hodnota mohou být identifikovány pomocí URI či IRI (Internationalized Resource Identifier – URI s možností použití libovolného kódování, např. českého). RDF trojice vytvářejí pavučiny informací o souvisejících věcech. URI umožňují, že koncepty nemusejí být pouhými slovy v dokumentu, ale mohou být provázány na unikátní definici, kterou si každý může na webu najít. Na webu nejčastěji používaná forma zápisu RDF je pomocí XML [4]. Za těchto předpokladů je ovšem stále možné, že například dvě rozdílné webové databáze budou používat různé identifikátory příslušející stejnému konceptu. Proto je nutný další ze základních kamenů sémantického webu, konkrétně ontologie.

3. Ontologie

Podle jedné z definic je ontologie *formální specifikace sdílené konceptualizace*. *Konceptualizací* je myšlen abstraktní model výseku reálného světa, který popisuje relevantní koncepty daného výseku. Slova *formální* a *sdílené* mají důležitý význam ke (znovu-)použitelnosti ontologií, protože základním předpokladem jejich opakované (počítačové) použitelnosti je jejich formální vyjádřitelnost a možnost jejich sdílení; pokud by kteroukoli z těchto dvou vlastností postrádaly, byly by zřejmě k ničemu. Ontologie je tedy určitým systémem zachycení reality, který je znovupoužitelný a je možné ho sdílet.

3.1. Meta model ontologie

Pod tímto pojmem si můžeme představit popisné a odvozovací schopnosti modelu. Jde o formální definice toho, co ontologie může obsahovat, co jsou uzly, co vazby, jaké typy vztahů připouští, jak je možné specifikovat pravidla a funkce apod. Každá ontologie má svůj model, více ontologií ale může být vystavěno podle stejného meta modelu.

3.2. Klasifikace ontologií

Ontologie lze obecně rozdělovat podle různých kritérií. První z možností je rozdělit veškeré ontologie do dvou skupin, *ontologie popsané formálním jazykem* a *ontolo-*

gie v přirozeném jazyce [5]. A protože samotný přirozený jazyk poskytuje mnoho různých prostředků konceptualizace, je zpracování ontologií popsaných přirozeným jazykem složité a provádí se většinou na lingvistické úrovni nebo se převádí na jiný (jednodušší) typ. Druhou a nejčastěji používanou možností je dělit ontologie podle zdroje konceptualizace (viz obrázek 2):

- **generické ontologie** (*ontologie vyššího řádu*) – zachycování obecných zákonitostí, (mohou sloužit také jako prostředek pro spojení jednotlivých doménově specifických ontologií a tak pomoci k jejich širší integraci),
- **doménové ontologie** (*doménově specifické ontologie*) – určeny pro specifickou věcnou oblast (nejčastější; např. pro oblast sportu, hudby atd.),
- **úlohové ontologie** (*reprezentační ontologie* či *metaontologie*) – zaměřeny na procesy odvozování,
- **aplikační ontologie** – adaptovány na konkrétní aplikaci, (nejspecifičtější; zpravidla zahrnují doménovou i úlohovou část).

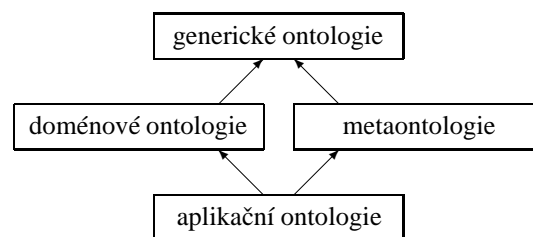

Obrázek 2: Druhy ontologií a jejich vztahy z pohledu konceptualizace

V dalším textu se pod pojmem ontologie uvažují zejména aplikační a doménové ontologie.

3.3. Jazyk ontologií

Jedná se o jazyk, který se používá pro reprezentaci ontologií. Nejčastěji používanými jazyky jsou RDFS [13] a OWL [11]. Jazyk ontologií pro sémantický web se skládá ze dvou částí, logické a mimologické. Logická část se obvykle skládá z *axiomů* pro *definici tříd*, *vlastností*, *instancí* atd. Prvky mimologické části jsou většinou vlastnosti, které se netýkají funkčnosti (*jméno autora*, *datum vytvoření*, *komentáře*, ale i *deklaraci jmenovaných prostorů* či *import dalších ontologií*). Mimologická část je určena především pro lidi, přestože množství výše uvedených vlastností je strojově zpracovatelné

(příkladem jsou jmenné prostory nebo import ontologií: ten může být proveden buď pomocí přidání logické části importované ontologie do logické části ontologie, do níž importujeme, vytvoříme tak jeden logický popis, nebo použitím jakéhosi prostředníka, který řeší nestejnorodost dvou ontologií).

3.4. Využití ontologií

Agregace, integrace, unifikace

Jak již bylo zmíněno, Internet je prostoupen informacemi ve všemožné podobě, struktuře a kvalitě. Ontologie by mohly být prostředkem propojení a následně agregace takových heterogenních zdrojů. Databáze, které obsahují cenná data, by mohly sloužit ještě mnohem lépe v integrovaném celku. Ontologie by se mohly stát jádrem systému, prostředkem pro kompozici nezávislých webových služeb.

Snížení redundance

Přestože již mnohokrát vytvořené, nashromážděné, zpracované, ověřené a porovnané informace jsou znovu a znovu vytvářeny, shromažďovány, zpracovávány, ..., zvyšuje se jejich redundance, která může vést až k nekonzistenci, když si duplikovaná data vzájemně protirečí. S použitím ontologií by mohla být data místo duplikace sdílena, a tak by redundance i nekonzistence mohla klesnout, mohla by být lépe kontrolována či úplně eliminována.

Znovupoužití

Konceptualizovaná data je mnohem snazší použít, a to i vícekrát a různými způsoby.

4. Integrace ontologií

Existující ontologie se hodí jako zdroje znalostí pro vytváření ontologií nových: ontologie mohou být převáděny a slučovány tak, aby k nim bylo možné přistupovat jako k jednomu většímu celku. Výsledkem je nová ontologie. Se systémy a daty integrovanými pomocí ontologií se zvýší možnosti interoperability. Současným aplikacím schází především možnost budovat z nich kompaktní celky a poskytovat společně realizované služby pro uživatele. Slovo kompaktní v tomto případě znamená monolitické, ale spíše poskládané z mnoha nezávislých komponent, které jsou překryty jednotící vrstvou.

Je potřeba rozlišovat několik operací či činností, které je možné s ontologiemi provádět:

Transformace ontologií

Může být dvojího druhu:

- *meziformátová* – mezi jazyky pro zachycení ontologií ($RDF \rightarrow OIL$),
- *sémantická* – změna vnitřní struktury podle jiného metamodelu nebo pro jiné použití.

Vývoj ontologií

Vývojem ontologií myslíme jejich *údržbu, doplňování nových konceptů, sladování se současnými poznatky* o doméně nebo o ontologiích.

Spojování ontologií (*Ontology Merging*)

Výsledkem této operace je jedna nová ontologie, která zahrnuje informace ze dvou či více ontologií. Integrovaná ontologie je již nezávislá na ontologiích původních, které v podstatě nahradí.

Integrace ontologií (*Ontology Alignment*)

Integrace ontologií má význam především tam, kde se očekává budoucí rozvoj a údržba spojujících ontologií.

Více se zde zajímáme o dvojice ontologií, které se určitým způsobem překrývají, a kdy spolu některé jejich elementy více či méně souvisejí. Výsledkem integrace dvou ontologií A a B jsou stále dvě ontologie (nové), ale s definovanými společnými místy a přesahujícími vztahy, jak ukazuje obrázek 3. Snahou je, aby nesouvisející elementy byly ponechány stranou tak, aby nedošlo k porušení struktury ontologií.

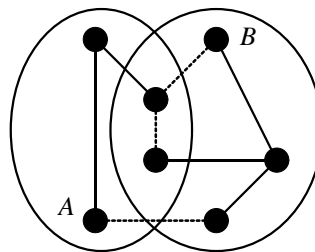

Obrázek 3: Graficky znázorněná integrace ontologií

Zde je možné rozlišit dva typy situací, jak odlišit dvojice ontologií:

- každá z ontologií popisuje *odlišnou doménu* – tyto ontologie mohou být spojeny do jedné "superontologie" přes společné části, jsou-li takové, nebo přes nějakou obecnější ontologii [6].
- obě ontologie popisují *stejnou doménu*, ale z *různých úhlů pohledu* nebo *různými prostředky* –

v tomto případě musí být provedeno *srovnání ontologií* za účelem vytvoření překrytí odlišností ontologií.

Srovnáním ontologií (*Ontology Matching*) se nazývá proces nacházení podobností mezi dvěma zdrojovými ontologiemi. Výsledkem je specifikace těchto podobností, která slouží jako vstup tzv. *mapování* (viz níže). Srovnání ontologií je věnována samostatná část 5. **Mapování ontologií** (*Ontology Mapping*) je deklarativní specifikací sémantického překrytí mezi dvěma ontologiemi O a O' . Shody mezi odlišnými entitami jsou typicky vyjádřeny použitím axiomů formulovaných v "mapovacím" jazyce (jazyk k reprezentaci mapování ontologií). Mapování může být *jednosměrné* (specifikuje, jak termy z jedné ontologie mohou být vyjádřeny použitím termů ontologie druhé) či *obousměrné* (funguje oběma směry). **Integrace ontologií** specifikuje, jak spolu ontologie souvisí v logickém smyslu. To znamená, že se původní ontologie nezmění, ale vzniknou další axiomy popisující vztahy mezi jejich koncepty. Ponechání původních ontologií v nezměněné podobě většinou znamená, že lze zintegrovat ontologie pouze částečně, neboť hlavní odlišnosti by vedly k nutné úpravě vstupních ontologií. Integrace ontologií je tedy určitým zobecněním mapování – *dvě ontologie mohou být zintegrovány pomocí mapování* [6].

4.1. Problémy při integraci ontologií

Problémy mohou nastat v mnoha případech. Třeba v tom, že tvůrci ontologií neuvažují stejně a vzájemně si leckdy neporozumí. Jedna ontologie může například reprezentovat červenou barvu jako *vztah*, druhá jako *hodnotu*. Přitom zvolená reprezentace je v rámci ontologie vždy *správná a pravdivá* – správná je z definice, neboť jde o definici. Další potíže jsou na *jazykové úrovni*. To může komplikovat proces automatické integrace, protože je složité zjistit, zda jsou dva uzly (podíváme-li se na ontologii jako na graf) *stejně, podobné* nebo *zcela odlišné* [3].

5. Metody řešení srovnání ontologií

Předpokládejme, že máme dvě ontologie, z nichž každá se skládá z množiny entit (elementů, relací, tříd, vlastností atd.). Ty jsou v tomto případě vstupem pro srovnání. Výstupem pak budou vztahy (*ekvivalence, subsumpce*, neboli podřazení, *disjunktnost* atd.). Pro zjednodušení můžeme srovnání ontologií přirovnat ke srovnání XML schémat, jak ukazuje obrázek 4.

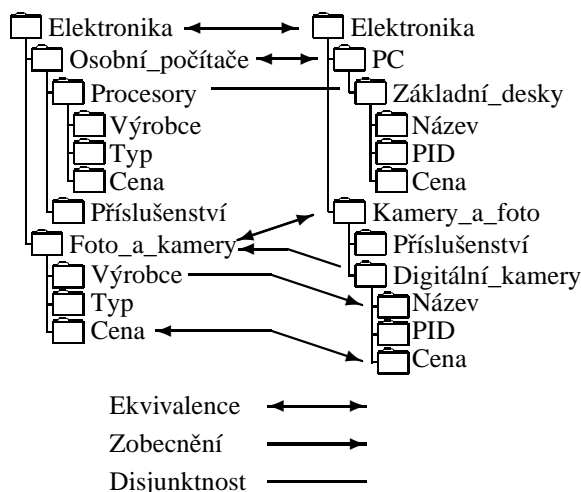

Obrázek 4: Ukázka možného srovnání dvou XML schémat

Obrázek 4 ukazuje možné vztahy srovnání dvou XML schémat. Od srovnání ontologií se však v některých aspektech odlišuje. Schémata často neposkytují explicitní sémantiku pro svá data. Ontologie, jako logické systémy, se omezují na význam. Ontologické definice jsou množiny (logických) axiomů. Ontologie a schémata mají ale i společné rysy. Oboje mají své slovníky pojmů, které popisují oblast zájmu (doménu) a oboje zároveň vymezují význam těchto pojmů. Nестejnorodost schémat či ontologií se redukuje ve dvou základních krocích:

1. *vymezení* (viz obrázek 4), 2. *zpracování* (transformace, spojení, ...). Máme-li dvě ontologie (schémata) O a O' , je srovnáním mezi O a O' množina odpovídajících si prvků, trojic $\langle e, e', r \rangle$, kde $e \in O$ a $e' \in O'$ a r je vztah mezi e a e' (*ekvivalence, zobecnění, disjunktnost*). Na obrázku 5 je zobrazeno rozdělení metod pro srovnání na základě schématu. Jednotlivé metody vyžadují alespoň stručný popis:

- **Metody založené na řetězci** – Pracují s předponami (resp. příponami) slov, kdy jsou vstupem dva řetězce a kontroluje se, zda první řetězec začíná (resp. končí) druhým řetězcem. Např.: *hotel* → *hot* Dále je možné určovat počet stejných N-gramů (počet N-tic písmen, které mají dva řetězce společné) či vzdálenost dvou řetězců. Např.: *Nokia versus Nka*.
- **Metody založené na zpracování přirozeného jazyka** — Využívají analýzy přirozeného jazyka. *Tokenizace* je rozdělení textu na jednotlivé slovní tvary (tokeny). Např.: *foto-aparát*. *Lemmatizace* je analýza tokenů pro zjištění všech základních forem slov. *Eliminací* odstraníme "bezvýznamná" slova.
- **Lingvistické prostředky** — Zabývají se význa-

mem slov, na tomto principu funguje třeba WordNet. Např.: $A \sqsupseteq B$, neboli A je *hypernymem* nebo *holonymem* B , konkrétně *Evropa* \sqsupseteq *Řecko*.

- **Metody založené na omezeních** — Metoda srovnání datových typů. Např.: $integer \subset real$ nebo $datum \in [1.4.2007, 30.6.2007] \subset datum[year = 2007]$.
- **Znovupoužití alignmentu** — Potřebujeme-li provést srovnání schémat/ontologie O' a O'' a již máme srovnání mezi O a O' a zároveň O a O'' , využijeme ho.
- **Metody založené na taxonomii** — Na schémata/ontologie se díváme jako na grafy obsahující termíny a vztahy mezi nimi. Například pokud se *shodují koncepty vyšší úrovně, aktuální koncepty se podobají*.
- **Metody založené na grafu** — Elementy dvou ne-listových schémat jsou *strukturou podobné*, pokud jsou *množiny přímých potomků podobné* nebo pokud jsou *podobné jejich listové množiny*, i když množiny jejich přímých potomků nejsou. Jestliže *dva uzly dvou schémat/ontologií jsou podobné*, jejich *sourozenci mohou být rovněž podobní*.
- **Metody založené na modelu** — Převedeme srovnání grafu (stromu) na *srovnání množiny jeho*

uzlů. Vytvoříme páry uzlů, které *spolu mohou souviset* a vztahy mezi nimi zapíšeme *výrokovými formullemi*. Poté kontrolujeme *platnost jednotlivých formulí*. Např.: $(Elektronika_1 \Leftrightarrow Elektronika_2) \wedge (Osobní_počítač_1 \Leftrightarrow PC_2) \Rightarrow (Elektronika_1 \wedge Osobní_počítač_1 \Leftrightarrow Elektronika_2 \wedge PC_2)$.

5.1. Návrh spojení metod srovnání ontologií

Každá z metod uvedených v předchozí části má svoje omezení a svoji chybovost. Skutečně ideálním řešením by mohlo být vyvinout nástroj, který by podle typu ontologie využil více metod srovnání najednou. Jednotlivým metodám by šlo dávat váhy a metody by zároveň spolu mohly spolupracovat tak, aby jedna eliminovala nedostatky druhé. Schéma takového nástroje je naznačeno na Obrázku 6. Srovnáním ontologií O a O' pomocí *metody 1* vznikne A_1 . Dále srovnáním ontologií O a O' pomocí *metody 2* vznikne A_2 . V ideálním případě, pokud by byly metody dokonalé, by $A_1 = A_2$. Tato situace je však málo pravděpodobná. V tom případě se provede porovnání A_1 a A_2 . Tím zjistíme odlišnosti a rozdíl obou výsledků potom slouží jako zpětná vazba pro případnou úpravu *metody 1* a 2 . Části výsledku, které se naprosto liší by šlo potom ze srovnání úplně vynechat. Této problematice bych se chtěl v průběhu svého dalšího studia věnovat.

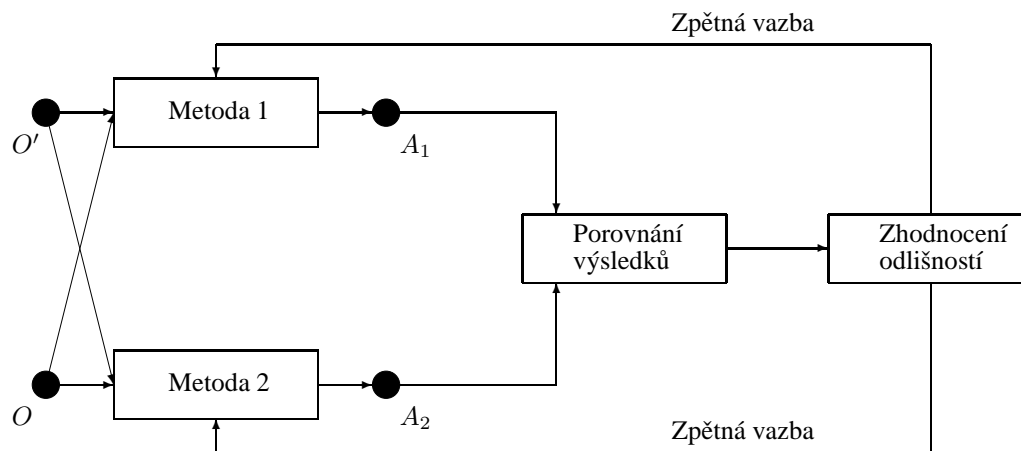

Obrázek 6: Návrh schématu spojení dvou metod srovnání ontologií

6. Závěr

Ontologie mohou v mnohém vylepšit fungování webu. V nejjednodušším případě se může jednat např. o přesnost vyhledávání, kdy se vyhledávač může zaměřit jen na stránky odpovídající danému konceptu (a nikoli dvojnásobným nebo dokonce víceznačným klíčovým slově). Jejich integrací navíc docílíme toho, že infor-

mační zdroje budou pro uživatele působit kompaktnějším dojmem. Úspěšné integraci napomáhají do určité míry v textu uvedené metody srovnání ontologií. Tyto metody by ji mohli dále vylepšovat, ale jejich skutečná síla by se mohla projevit, když jejich jednotlivé přednosti spojíme, popřípadě využijeme pro jejich úpravu poznatků, v čem se výsledky po srovnání ontologií liší.

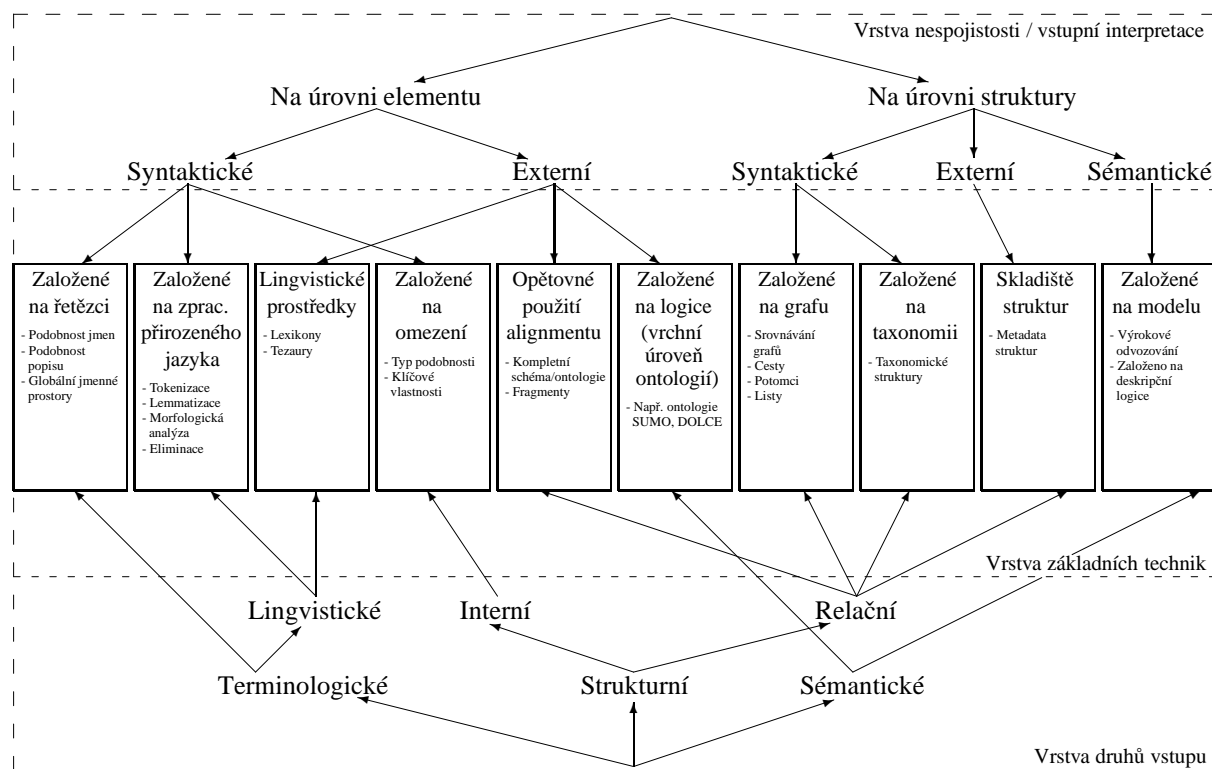

Obrázek 5: Klasifikace metod srovnání ontologií na základě schémat [7]

Literatura

- [1] ANTONIOU, Grigoris — VAN HARMELEN, Frank. "A Semantic Web Primer". London: The Mit Press, 2004. ISBN 0-262-01210-3.
- [2] BERNERS-LEE, Tim — HENDLER, James — LASSILA, Ora. "The Semantic Web: A new form of Web content that is meaningful to computers will unleash a revolution of new possibilities". *Scientific American*, vol. 284, 5, pp. 35–43. May 17, 2001.
- [3] HITZLER, Pascal — KRÖTZSCH, Markus — EHRIG, Marc — SURE, York. "What Is Ontology Merging? – A Category-Theoretical Perspective Using Pushouts". *Proceedings of 1st International Workshop on Contexts and Ontologies (IWCO '05)*. 2005.
- [4] HJELM, Johan. "Creating the Semantic Web with RDF". New York: Wiley, 2001. ISBN 0-471-40259-1.
- [5] MAEDCHE, Alexander. "Ontology Learning for the Semantic Web". Norwell: Kluwer Academic Publisher, 2002. ISBN 0-7923-7656-0.
- [6] PREDOIU, Livia — FEIER, Cristina — SCHAR-FFE, Francois — BRUIJN, Jos de — MARTÍN-RECUERDA, Francisco — MANOV, Dimitar — EHRIG, Marc. "State-of-the-art Survey on Ontology Merging and Aligning V2". *Digital Enterprise Research Institute, University of Innsbruck*. 2005–2006.
- [7] SHVAIKO, Pavel — EUZENAT, Jérôme. "Tutorial on Schema and Ontology Matching". *Proceedings of 2nd European Semantic Web Conference (ESWC '05)*. 2005.
- [I1] Web Ontology Language (OWL) / W3C Semantic Web Activity. <http://www.w3.org/2004/OWL>.
- [I2] Resource Description Framework (RDF) / W3C Semantic Web Activity. <http://www.w3.org/RDF>.
- [I3] RDF Vocabulary Description Language 1.0: RDF Schema. <http://www.w3.org/TR/rdf-schema>.
- [I4] W3C Semantic Web Activity. <http://www.w3.org/2001/sw>.
- [I5] Extensible Markup Language (XML). <http://www.w3.org/XML>.

Detecting Synchronized States from Bivariate Time Series

Post-Graduate Student:

ING. MARTIN VEJMEĽKA

Institute of Computer Science of the ASCR, v. v. i.
Pod Vodárenskou věží 2

182 07 Prague 8, CZ

vejmelka@cs.cas.cz

Supervisor:

RNDR. MILAN PALUŠ, DRSC.

Institute of Computer Science of the ASCR, v. v. i.
Pod Vodárenskou věží 2

182 07 Prague 8, CZ

mp@cs.cas.cz

Field of Study:
Artificial Intelligence and Biocybernetics

This work was supported by the EC FP6 project BRACCIA (Brain, Respiration and Cardiac Causalities in Anaesthesia). Part of this work was carried out under the HPC-EUROPA project (RII3-CT-2003-506079), with the support of the European Community - Research Infrastructure Action under the FP6 "Structuring the European Research Area" Programme.

Abstract

As experimental scientists strive to understand the inner workings of more and more complex systems, classification of the interactions between the components of such systems is gaining much importance. Many biological, geophysical and atmospheric processes can be analyzed in the framework of nonlinear dynamical systems. An important subclass are oscillatory or quasi-oscillatory systems which can be coupled in various ways leading to a rich spectrum of cooperative behavior. One of the most important types of such behaviors is *synchronization*. Many forms of synchronization have been discovered to date, among them phase synchronization which occurs in weakly coupled oscillators. Up to now, instead of direct detection of phase synchronization, much work has been devoted to quantifying phase dependence from bivariate time series of a pair of oscillatory processes. In this paper we introduce a selection of available methods for quantification of phase dependence and describe the first detector of phase synchronization from bivariate time series. The efficiency of the method is demonstrated on a model system and the method is compared with existing approaches to analysis of synchronization.

1. Introduction

Increasingly, complex biological, biochemical, meteorological and geophysical systems have become the focus of intensive experimental and theoretical research. Many of these systems can be characterized as coupled networks of nonlinear oscillators or quasi-oscillators. The complexity of their behavior typically arises from non-trivial interactions between more or less discrete components. A higher level of understanding of the function of the systems is facilitated by a more detailed analysis of the various types of behaviors induced by the coupling between their components.

There is a variety of ways that two oscillatory systems can be directly or indirectly coupled. Certain types of coupling between two systems lead (under favorable conditions) to a specific type of cooperative behavior termed "synchronization". Synchronization has been first described in the 17th century by Christian Huygens and who observed the phenomenon of mutual adjustment of motions of two pendulums hanging from a common beam. Performing further experiments he found that this

is not a random effect but one that is brought about by a connection between the two pendulum clocks — in this case the very slight motion of the beam transferring forces between the two clocks. He called this interaction "sympathy" and published these (and other) findings in the monograph *Horologium Oscillatorium* [7].

The term synchronization has since come to represent a multitude of phenomena and much effort has been spent differentiating between its various forms. The simplest form is called *complete synchronization* and is found in coupled identical systems when both systems move along coincident trajectories after reaching a steady state [5]. *Generalized synchronization* requires that a smooth map exists between the trajectories of both oscillators [2]. More recently, *phase synchronization* resulting from weak coupling has been discovered as a form of synchronization that occurs even in oscillating systems exhibiting deterministic chaos [1, 20, 19]. *Phase* is an observable which efficiently describes the motion of an oscillatory system: it indicates the current position of the dynamical system on its limit cycle. It is an increasing variable which grows by a fixed amount (usually

2π) for every completed cycle of the periodic motion. Phase is generally not directly available and must be first obtained from an observable of the system by a process called “phase extraction”.

Experimentally, synchronization has been found for example in the human cardiorespiratory system [4, 21], in the Solar system [17], in meteorological systems [16] or in neural signals [15, 22].

Synchronization can occur in pairs of oscillators with similar natural frequencies which then lock at a 1:1 ratio. It is also possible that a pair of systems synchronizes at different ratios, for example a parent walking with a child alongside may make one large step while the child makes two smaller steps, every second step of the child aligning with the large step of the parent. Such a system synchronizes at a ratio 2:1. In general, synchronization at ratios different from 1:1 is called *higher order synchronization* and the ratio of frequencies at which the systems synchronize is termed the *locking ratio*.

In experimental practice, the only information available about the investigated systems are the recorded time series. In this case it is necessary to apply methods developed in the context of non-linear time series analysis and to infer if the systems synchronize or not. Unfortunately without additional knowledge or the option to interact with the given systems, it is not possible to decide with certainty if two systems synchronize. At best, either an index characterizing the strength of phase dependence can be estimated or an inference regarding the synchronization state can be made with a desired level of significance.

The rest of this paper is organized as follows: the next section deals with two frequently used methods of computing a “synchronization index” and describes the proposed synchronization detector; the following section details experiments testing the methods and comments on the results and the paper closes with a brief discussion and a conclusion.

2. Methods

In this section the sequence of steps required for processing time series of the original observable to obtain a result indicating the synchronization state is described. First, phase must be extracted from the time series. The phase is then used as input into the actual synchronization analysis methods which supply the final result: either a computed index or a decision.

2.1. Phase Extraction

There are multiple ways of extracting phase, each of which is suited to a particular situation. Instantaneous phase can be obtained from using the Hilbert transform [12] or the Wavelet transform [11]. If the time series of the observable is too noisy to obtain a reliable instantaneous phase signal, the marked-events method may yield better results [25]. In the following, the phase time series (obtained by one of the methods above) of the coupled systems will be denoted ϕ_1 and ϕ_2 . It should be noted that the extraction methods usually provide a “wrapped” phase time series which is confined to the interval $(0, 2\pi)$ but synchronization methods may work with an “unwrapped” definition, where 2π is added to the phase after a cycle is completed to produce an increasing phase. In the following experiments it will be specified which methods work with which definition of phase.

2.2. Synchronization indices

Because of the variety of synchronization phenomena, different synchronization analysis methods have been proposed, a comparison and overview of methods for analyzing phase synchronization is in [10]. These methods however usually estimate a “degree of synchronization”, which should more aptly be called the “degree of phase dependence” and their result is typically a normalized synchronization index. It has however proven difficult to make a decision as to whether two systems are synchronized based on the values of such indices. We propose a new approach to the problem of detecting phase synchronization by constructing method which provides a decision whether two systems are synchronized with a pre-selected level of statistical significance.

In this section we first describe two frequently used methods in quantifying phase synchronization in systems of coupled non-linear oscillators: mean phase coherence and mutual information. In the rest of the section the new phase synchronization detection method is introduced.

2.2.1 Mean Phase Coherence: The mean phase coherence (MPC) [6] is defined as

$$R = \left| \frac{1}{N} \sum_{j=1}^N e^{i\Delta\phi(j)} \right| = 1 - \text{CV}, \quad (1)$$

where $\Delta\phi(j) = n\phi_1(j) - m\phi_2(j)$ is the difference of the “unwrapped” phases scaled by the locking ratio $m:n$ and CV denotes the circular variance [13], a well-known

measure of point spread in circular statistics.

The ratio $m:n$ should be set to the expected phase synchronization ratio. The function

$$\Delta\phi(j) = n\phi_1(j) - m\phi_2(j)$$

is important and describes the evolution of the difference of the scaled phases. If the systems are synchronized, this function should be constant (assuming there is no noise induced into the system). The mean of the derivative of the continuous version of the function $\Delta\phi(j)$ denotes the scaled relative phase velocity of the two systems. If the systems are synchronized, this should be exactly 0 indicating that m cycles of the second systems correspond to n cycles of the first system.

The result R is a synchronization index with values in the interval $\langle 0, 1 \rangle$. The value of 0 indicates independent phases while 1 indicates completely synchronous motion.

The MPC quantifies the ‘‘spread’’ of the phase differences. If all of phase differences are tightly coupled together for a given time series, the value of MPC will be high. If, on the other hand, the phase differences exhibit high fluctuations, the value of MPC will be low. This can be seen from the relationship between MPC and the circular variance CV [13],

2.2.2 Mutual Information: Mutual information [24] characterizes the statistical dependence of random variables. The phase time series are interpreted as realizations of an ergodic stochastic process. Under this assumption, the probability density function (PDF) of the variables can be estimated from a single realization. Using Φ_1, Φ_2 to denote the stochastic processes we can write

$$\begin{aligned} I(\Phi_1; \Phi_2) &= \iint p(\Phi_1, \Phi_2) \log \frac{p(\Phi_1, \Phi_2)}{p(\Phi_1)p(\Phi_2)} \\ &= H(\Phi_1) + H(\Phi_2) - H(\Phi_1, \Phi_2). \end{aligned} \quad (2)$$

If the two systems are uncoupled and behave independently, the mutual information (MI) of the two variables should be close to 0. In practice, however, contamination by noise and insufficient data to estimate the PDF reliably cause the value of MI to fluctuate. A systematic error is also introduced by similarities in the dynamics of the two systems as MI quantifies not only dependencies in the variables resulting from coupling between the systems but also dependencies resulting from common dynamics.

For the purpose of evaluation, mutual information can be normalized by $\min\{H(\Phi_1), H(\Phi_2)\}$ yielding an index of phase dependence in the interval $\langle 0, 1 \rangle$. The value of 0 indicates that the random variables Φ_1, Φ_2 are independent and the value of 1 indicates that a functional relationship exists between the variables. In general a stronger connection between the PDFs of the processes will produce a higher value of MI.

Use of mutual information requires an effective tool to estimate the marginal PDF of each stochastic variable and also the joint PDF. This is currently the most challenging problem in applying information-theoretic functionals to time series analysis. An effective PDF estimator must capture the salient features of the PDF while being as resistant to noise as possible. There are many ways of estimating the PDF, a comprehensive review is in [23].

As an alternative to using (2), mutual information can be directly estimated from some statistics of the data. This is the approach used in this paper. One of the most promising estimators of mutual information, the Kraskov-Grassberger-Stögbauer method [9] of estimating mutual information from nearest neighbor distances is applied. The work is based on earlier efforts of Kozachenko and Leonenko [8] on asymptotically unbiased estimators of entropy.

2.3. Bootstrap Synchronization Detection

The above methods do not use any mathematical definition of synchronization as a basis for detecting the presence of synchronization. Rather they provide an index related to the mutual dependence of the phases of the systems. On the other hand, the method proposed in this section is based on a mathematical definition of phase synchronization. There are currently two widely accepted definitions of phase synchronization which respect the possible influence of noise on the systems and are therefore practically applicable:

$$|m\phi_1(t) - n\phi_2(t)| = |\Delta\phi(t)| < \delta, \quad (3)$$

which allows the phase time series to fluctuate slightly. This allows a pair of synchronized systems to be labeled as such even in the presence of some noise. This condition states that the phase difference between the two time series is bounded. This is a theoretically sound definition but unfortunately it cannot be tested on time series of finite length as every such time series satisfies (3) for $\delta = \sup\{|\Delta\phi|\}$. The other, slightly weaker condition, states that two systems are phase synchronized if their mean phase velocities are equal

$$m\langle\dot{\phi}_1\rangle = n\langle\dot{\phi}_2\rangle, \quad (4)$$

where $\langle \dots \rangle$ denotes the time average. In the following, we show that this condition can be tested on a finite time series. First, it is necessary to prove that if the mean frequencies are not equal (systems are not synchronized) then the phase difference time series has a non-zero gradient and vice-versa. Henceforth we will work with sampled time series. This will be indicated by the use of the variable i to index the time series ϕ_1 , ϕ_2 and $\Delta\phi$. We note that the condition (4) can be rewritten as

$$\langle \dot{\Delta\phi} \rangle = 0, \quad (5)$$

Using least squares linear regression we may write

$$\Delta\phi(i) = at(i) + b + \epsilon(i) \quad (6)$$

where a and b are chosen to minimize $\chi^2 = \sum_i \epsilon(i)^2$ [3]. As a corollary to this we have that mean $\epsilon(i)$ is zero. Subtracting the equation for $\Delta\phi(i)$ from the equation for $\Delta\phi(i+1)$ and rearranging gives

$$\frac{\Delta\phi(i+1) - \Delta\phi(i)}{t(i+1) - t(i)} = a + \frac{\epsilon(i+1) - \epsilon(i)}{t(i+1) - t(i)} \quad (7)$$

Averaging over all samples (assuming equidistant sampling) we obtain

$$\frac{\langle \Delta\phi(i+1) - \Delta\phi(i) \rangle}{\Delta t} = a, \quad (8)$$

where $\Delta t = t(i+1) - t(i)$. If we sampled with infinite density we would be able to take the limit $\Delta t \rightarrow 0$ to arrive at

$$\langle \dot{\Delta\phi} \rangle = a \quad (9)$$

We note that the above shows that no matter what the actual evolution of the phase difference is, a linear trend will be present if the systems are unsynchronized. The phase locking condition (4) can thus be restated as $a = 0$. In real time series, noise and fluctuations will invariably cause the value of a to be slightly different from zero. The question is whether the gradient a is significantly non-zero. In this way, the problem of detecting synchronization has been transformed into the problem of estimating the significance of a gradient in the phase difference time series.

In general it is not possible to assume that a will have any particular distribution. This fact makes the construction of a direct statistical test of the value of a very difficult. In this work we propose not to test the value of a directly but to estimate its significance in an indirect fashion. This requires that a least-squares fit of a horizontal line $\Delta\phi(i) = c + \eta(i)$ is performed, where again c is chosen to minimize $\chi^2 = \sum_i \eta(i)^2$. In this case c is simply the mean of $\Delta\phi(i)$. We now compare the sample

of errors of the original fit (6) and that of the errors of the horizontal line fit. If there is no real gradient in the time series $\Delta\phi(i)$ then the value of a is the result of random fluctuations and the distributions of the errors of both of the fits should be the *same*. If on the other hand there is a trend in the time series and the value of a explains part of the variance of the errors than the distributions will be different. There is a standard test that determines if two samples are drawn from the same distribution — the Kolmogorov-Smirnov test [14]. The test is a standard hypothesis test with the null hypothesis being that the samples are drawn from the same distribution. This means that the proposed synchronization detector assumes that the processes are synchronized and tries to reject this assumption using evidence from the data. This is a completely new approach to detecting synchronized states.

As described above, the method requires a high volume of data, on the order of hundreds or thousands of cycles to reliably differentiate between synchronized and unsynchronized states. This is because of long correlations in the time series which cause the appearance of spurious gradients in short time series. We use a simple solution which breaks these long correlations if there is no gradient but preserves the autocorrelation of the signal if there is a significant trend: time indices are sorted by the magnitude of the associated phase difference values. This step leads to a significant reduction in the frequency of false negatives and improves the efficiency of the method greatly. As it will be shown in the next section, time series only tens of periods long are now necessary for reliable detection even for higher locking ratios, such as those occurring in the cardiorespiratory system.

3. Experiments

Numerical tests on model systems are a prerequisite to the application of any method to experimental data. Experimental data suffer from a number of problems which make the task of synchronization detection (indeed of any type of interaction analysis) difficult. The main problem is generally stationarity: the methods require as much data as possible to provide reasonable estimates, on the other hand using time series that are too long may violate the assumption of stationarity of the system. Experimental time series are burdened with noise signals of multiple origins (measurement, thermal, quantization).

Testing on model systems under many different conditions does not ensure that the method will work well in practice but successful tests under a wide range of conditions indicate that the method should work well. Such tests also show how the effectivity of the method chan-

ges with respect to different parameters.

In this work we investigate the problem of detecting higher-order synchronization at the ratio of frequencies 1:4. The ratio has been carefully selected to match the frequency ratio of the heart-beat period to the breathing cycle period. The problem of detecting synchronization in the cardiorespiratory system has been examined by some authors, e.g. [4].

3.1. Phase synchronization in noisy systems

The simplest possible nonlinear oscillator is the *phase oscillator*. A linearly coupled pair of symmetrically coupled phase oscillators is described by the differential equations

$$\begin{aligned}\dot{\phi}_1 &= \omega_1 + b \cos(\phi_1) + \epsilon \sin(m\phi_2 - n\phi_1) + \eta_1 \\ \dot{\phi}_2 &= \omega_2 + b \cos(\phi_2) + \epsilon \sin(n\phi_1 - m\phi_2) + \eta_2,\end{aligned}\quad (10)$$

where $\omega_{1,2}$ represent the natural frequencies of the systems, b is the coefficient of the nonlinear term, ϵ represents the strength of coupling and $\eta_{1,2}$ are uncorrelated Gaussian noise terms. In this paper we show the synchronization results for a pair of oscillators with the frequency ratio approximately 1:4. When the systems synchronize, the definition (4) should hold.

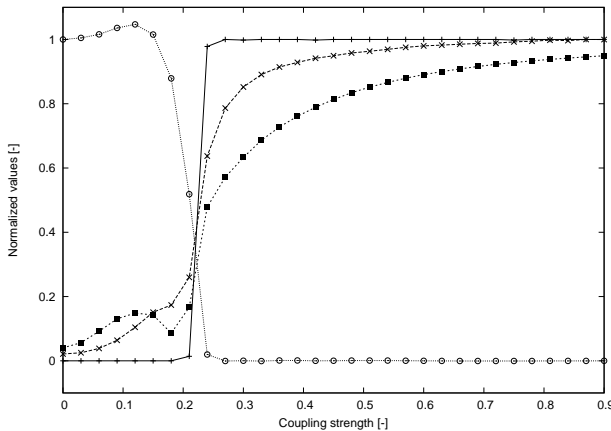

Figure 1: Comparison of synchronization analysis algorithms. Circles denote the DPV, pluses denote the detection rate of the bootstrap synchronization detector, crosses indicates the normalized mutual information estimated using k NN and full squares denote the mean phase coherence. Time series length is 2048 data points with about 60 points per period of the faster system (≈ 18 periods).

In Fig. 1 we plot the function $\langle n\dot{\phi}_1 - m\dot{\phi}_2 \rangle$, here called the difference of scaled phase velocities (DPV) together

with the results of the introduced synchronization analysis algorithms. The DPV is “normalized” by dividing all of its values by the value attained with non-existent coupling, this was done so that the shape of the DPV was clearly seen in the figure. The standard deviation of the inserted uncorrelated Gaussian noise was set to 0.02.

The synchronization transition region is approximately at the coupling strength 0.23 and is indicated by the phase difference velocity rapidly approaching 0.

3.2. Arnold tongues in phase oscillators

The second test is a reconstruction of one of the “Arnold tongues” for the system of coupled phase oscillators. The Arnold tongue refers to the region of synchronization of the coupled model system in the parameter space. We investigate coupled phase oscillator model (10), where the frequencies $\omega_{1,2}$ are set to

$$\begin{aligned}\omega_1 &= 1 + \Delta f \\ \omega_2 &= 4 - \Delta f\end{aligned}\quad (11)$$

where Δf is the frequency mismatch. The standard deviation of the inserted Gaussian uncorrelated noise was set to 0.02. The coupling strength ϵ spanned the interval $\langle 0, 0.5 \rangle$, and the frequency mismatch was varied in the interval $\langle -0.2, 0.2 \rangle$.

Fig. 2 shows the difference in scaled phase velocities (DPV) adjusted for the locking ratio 1:4. In the synchronized region, this difference should be 0 indicating that there are exactly four cycles of the faster system for one cycle of the slower system, the shape of the region resembles a tongue, hence the name of the region. In the figure, there are other flat regions with nonzero DPV. These regions correspond to synchronization in *different* ratios than 1:4. A synchronization analysis algorithm with adequate specificity should not be sensitive to the parameter combinations inside these regions.

In Fig. 3 it can be clearly seen that the Bootstrap synchronization detector is able to identify the region of 1:4 synchronization clearly. The interface between the synchronized and unsynchronized regions is sharply defined indicating that the detector is sensitive even near the transition between regions.

Figs. 4 and 5 show how the value of the synchronization indices varies with the frequency mismatch and coupling strength. It can be discerned that the highest values of the indices are in the synchronization region. However, we note that the values are not constant inside the region, thus rendering eventual thresholding more difficult and that there are non-zero values outside the

synchronization region. These correspond to the other (secondary) plateaus in Fig. 2. Because the methods are sensitive to synchronization outside the pre-selected ratio, there is a danger of incorrectly accepting states synchronized at different ratios as states synchronized at the given ratio.

To the best of our knowledge there is currently no procedure which would reliably compute a threshold discriminating between the synchronized and unsynchronized states for either of the indices (MPC and MI) based on a single bivariate time-series.

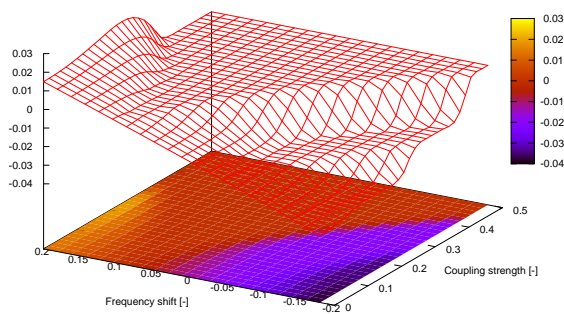

Figure 2: Difference of scaled phase velocities (DPV) plotted as a function of the frequency mismatch and of the coupling strength. The synchronization region is clearly seen as a plateau where the value of DPV is 0.

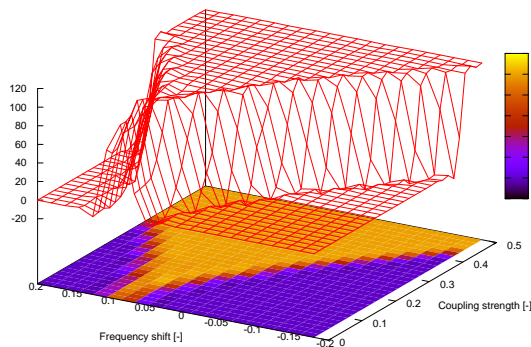

Figure 3: Detection rates of the bootstrap synchronization detector in percent. Comparing this image with Fig. 2, it is clearly seen that the region of synchronization is detected with excellent precision.

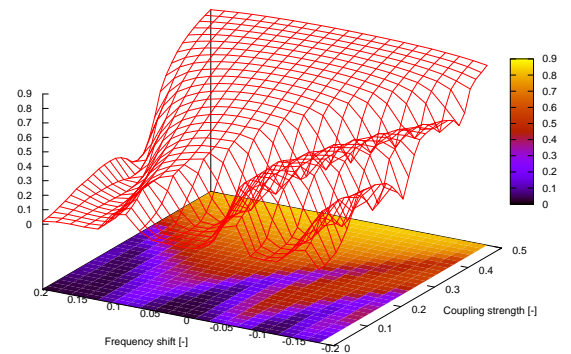

Figure 4: The values of the mean phase coherence. MPC shows the highest values in the synchronization region, however non-zero values are also outside the region and the value of the MPC index R varies widely even inside the synchronization region.

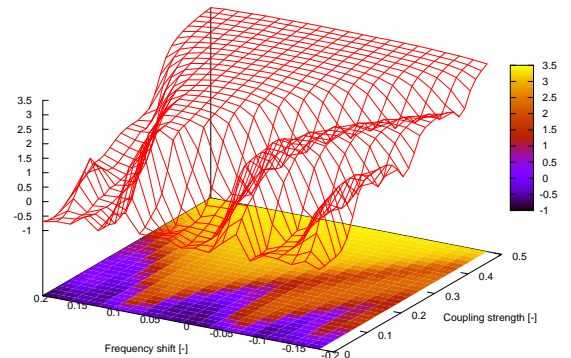

Figure 5: The values of mutual information estimated using the k NN method. The value of MI clearly attains its highest values in the synchronization region but also shows non-zero values outside the 1:4 synchronization region. The estimate is more stable inside the synchronization region than the MPC estimate, cf. Fig. 4.

4. Discussion

Phase synchronization is in general difficult to detect solely using information contained in the time series of observables. The main problem is that synchronization is a *process* [18] that manifests itself in the time series and causes phase locking. However detecting phase locking in a time series does not automatically imply that the two systems are synchronized. A simple example is of two identical oscillators with the same initial conditions and no coupling. Without the influence of noise, the two sys-

tems will evolve along coincident trajectories and from the time series they would appear to be perfectly locked. The problem of detecting phase synchronization from time-series therefore remains a problem of a statistical nature.

The influence of noise on the quality of detection is two-fold. A small amount of noise may break static correlations (resulting from common dynamics) such as those described in the last paragraph. A large amount of noise may prevent synchronization altogether or cause difficulties in detection of synchronization. A pervasive type of problem is called *phase slipping*, phase slipping occurs when sufficiently strong noise perturbs the states of the two systems so that one of the systems loses a cycle and “slips” behind. A unified approach to treating phase slips is not agreed upon at present. In this work we have not investigated the problem of phase slips, suffice it to note that phase slips adversely affect all synchronization analysis methods. The problem is discussed in [26].

5. Conclusion

In this work the notion of phase synchronization between nonlinear oscillatory systems has been introduced. Frequently used methods to “detect” synchronization have been introduced and their drawbacks have been described. Subsequently a new synchronization detection method — the Bootstrap synchronization detector, has been introduced. Numerical experiments similar in nature to the problem of detecting synchronization in the cardiorespiratory system have been performed. The effectiveness of the proposed method has been demonstrated and compared to existing approaches. The method will be applied in analysis of cardiorespiratory and neural data within the project BRACCIA.

6. Acknowledgments

The author would like to thank William T. Lee for the assistance provided in developing the algorithm, to Milan Palus for carefully reading this manuscript and providing valuable feedback and to the organizers of HPC-Europa for providing the computational resources to evaluate the efficiency of the proposed method.

References

- [1] H. D. I. Abarbanel, N. F. Rulkov and M. M. Sushchik. *Phys. Rev. E*, 53(5): 4528–4535, 1996.

- [2] V. S. Afraimovich, N. N. Verichev and M. I. Rabinovich. *Izvestiya Vysshikh Uchebnykh Zavedenii Radiofizika*, 29:1050–1060, 1986
- [3] P. R. Bevington. *Data Reduction and Error Analysis for the Physical Sciences*. McGraw Hill, 1969.
- [4] M. L. Bračič and A. Stefanovska. *Physica A*, 283:451–461, 2000.
- [5] H. Fujisaka and T. Yamada. *Progr. Theoret. Phys.*, 69:32–47, 1983.
- [6] M. Hoke, K. Lehnertz, C. Pantev and B. Lütkenhöner, In: E. Basar, T.H. Bullock (Eds.), *Series in Brain Dynamics*, Vol. 2, Springer, Berlin, 1989.
- [7] C. Huygens. *Horologium Oscillatorium*, Paris, 1673.
- [8] L. F. Kozachenko and N. N. Leonenko. *Problems of information transmission*, 23(2):9–16, 1987.
- [9] A. Kraskov, H. Stoegbauer, and P. Grassberger. *Physical Review E*, 69, 2004.
- [10] T. Kreuz, F. Mormann, R. G. Andrzejak, A. Kraskov, K. Lehnertz and P. Grassberger. *Phys. D* 225:29–42, 2007.
- [11] J-P. Lachaux, E. Rodriguez, J. Martinerie and F. J. Varela. *Human Brain Mapping*, 194–208, 1999.
- [12] M. Le Van Quyen, J. Foucher, J-P. Lachaux, E. Rodriguez, A. Lutz, J. Martinerie, and F. J. Varela. *Journal of Neuroscience Methods*, 111:83–98, 2001.
- [13] K. V. Mardia. *Probability and Mathematical Statistics: Statistics of Directional Data*. Academic Press, London, 1972.
- [14] R. von Mises. Academic Press, New York, 1964.
- [15] M. Paluš, V. Komárek, Z. Hrnčíř, and K. Štěrbová. *Phys. Rev. E*, page 046211, 2001.
- [16] Palus M., Novotna D. *Nonlin. Proc. Geophys.*, 13(3):287–296, 2006.
- [17] M. Paluš, J. Kurths, U. Schwarz, N. Seehafer, D. Novotná and I. Charvátová. *Phys. Lett. A*, 365:421–428, 2007.
- [18] A. Pikovsky, M. Rosenblum, and J. Kurths. *Synchronization: A Universal concept in nonlinear sciences*. Cambridge University Press, Cambridge, 2001.
- [19] M. G. Rosenblum, A. S. Pikovsky and J. Kurths. *Phys. Rev. Lett.*, 76:1804–1807, 1996.
- [20] N. F. Rulkov, M. M. Suschik, L. S. Tsimring and H. D. I. Abarbanel. *Phys. Rev. E* 51(2):980–994, 1995.

- [21] C. Schäfer, M. G. Rosenblum, J. Kurths, and H-H. Abel. *Nature*, 392:239–240, 1998.
- [22] S. J. Schiff, P. So, T. Chang, R. E. Burke, and T. Sauer. *Phys. Rev. E*, 54(6):6708–6724, 1996.
- [23] K. Schindler-Hlaváčková, M. Paluš, M. Vejmelka, and J. Bhattacharya. *Phys. Rep.*, 441(1):1–46, 2007.
- [24] C. E. Shannon. In *Bell Syst. Tech. J.*, 27:379–423, 1948.
- [25] A. Stefanovska, H. Haken, P. V. E. McClintock, M. Hožič, F. Bajrović, and S. Ribarič. *Phys. Rev. Lett.*, 85:4831–4834, 2000.
- [26] M. Vejmelka, W. T. Lee and M. Paluš. *Phys. Rev. E*, submitted.

Ústav informatiky AV ČR, v. v. i.
DOKTORANDSKÉ DNY '07

Vydal
MATFYZPRESS
vydavatelství
Matematicko-fyzikální fakulty
Univerzity Karlovy
Sokolovská 83, 186 75 Praha 8
jako svou – *not yet* – publikaci

Obálku navrhl František Hakl

Z předloh připravených v systému \LaTeX
vytisklo Repro středisko MFF UK
Sokolovská 83, 186 75 Praha 8

Vydání první
Praha 2007

ISBN – *not yet* –