

2017

ALZHEIMER'S DISEASE

EPILEPSY

PREVENTION

CHANNELOPATHIES

SCHIZOPHRENIA

OBESITY AND METABOLIC SYNDROME

INHERITED METABOLIC DISEASES

PHYSIOLOGY

NEURODEGENERATION

AUTISM

CANCER

BIOMEDICINE

INFECTIONS BY YEASTS

DIABETES MELLITUS TYPE 2

DISEASES OF THE INTESTINE

DIAGNOSIS

DISORDER OF BIORHYTHMS

KNOWLEDGE

CHRONIC KIDNEY FAILURE

HYPERTENSION

TREATMENT

INBORN COGNITIVE DEFECTS

CHRONIC HEART FAILURE

INSTITUTE

OF PHYSIOLOGY

OF THE CZECH ACADEMY OF SCIENCES

ISCHEMIC HEART DISEASE

HEART ARRHYTHMIAS

NEUROPATHIC PAIN

DEPRESSION

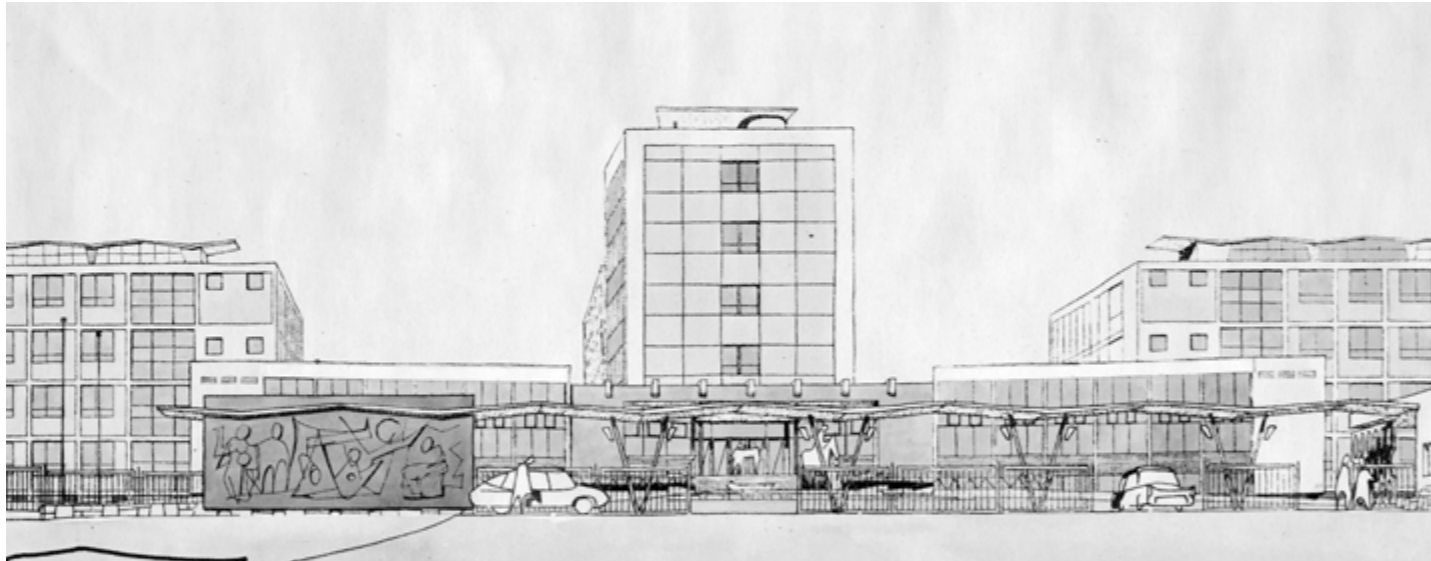

Proposed design of the campus (by Ing. V. Zvěřina, 1958)



Current look of the campus (2017)

FOREWORD

WELCOME TO THE INSTITUTE OF PHYSIOLOGY OF THE CZECH ACADEMY OF SCIENCES



The purpose of this brochure is to provide an overview of the mission and activities of the Institute of Physiology (IPHYS) of the Czech Academy of Sciences (CAS), which is the leading research institution in the field of normal and pathological physiology in the country. Our mission is twofold, first, to uncover basic biological mechanisms, and second, to make use of these findings in biomedicine for the better prevention, diagnosis and treatment of serious diseases.

Of course, in contrast to the existing and continuously updated IPHYS website (www.fgu.cas.cz/en), the brochure can only mirror the actual situation at the time of its release, i.e. the autumn of 2017. However, I believe that despite this limitation, it will serve as a handy vehicle to promote information about IPHYS, especially in the scientific community, and that it will also help to increase awareness about IPHYS among those who might join it in the future, either as students or new talented and promising scientists. In order to overcome in part the inherent limitation of the printed document, this brochure also contains a leaflet with a list of the recent grants and publications of IPHYS. This information will be updated on a yearly basis, until the release of a new brochure.

IPHYS has an excellent history of research, which has led to its current activities. While the mission of the institute has remained basically unchanged since its foundation in 1954, the strategy for reaching these goals has had to cope with the changes in the society and the funding possibilities. Out of the total funding of IPHYS (about 370 million CZK each year) about two thirds depends on the grant system, which is similar to the situation at the other institutes of CAS. Over the last several years, the success rate of our scientists in domestic grant agencies has been relatively high. In addition to local support, IPHYS scientists have been awarded by several EU-funded projects and other foreign grants. Recruiting new bright scientists and postdocs to IPHYS is a prerequisite for increasing its competitiveness, and represents a major challenge for the institute's leadership. The perspectives of IPHYS are good, namely because of its unique and strong position in biomedical research, the participation of its globally recognized excellent teams in their respective fields, and also the strong links with leading clinical centres (e.g. the National Institute of Mental Health and the Institute of Experimental and Clinical Medicine), other institutes of CAS, as well as universities in the Czech Republic (namely Charles University and the University of Chemistry and Technology in Prague). In fact, in its collaborations with universities, IPHYS serves as an important place for pre- and post-graduate education.

I would like to thank all my colleagues who are responsible for the friendly and enthusiastic atmosphere at IPHYS that helps to make it an excellent scientific institution, and especially to those who contributed to this brochure.

Jan Kopecký
IPHYS director



IPHYS

IPHYS IS THE LEADING NATIONAL RESEARCH INSTITUTION IN THE FIELD OF NORMAL AND PATHOLOGICAL PHYSIOLOGY.

Its mission is to improve our fundamental knowledge on the physiological and pathological processes associated with the function of the neuronal and brain system, cardiovascular system, and specific areas of metabolism, and thus pave the way to novel prevention, diagnostic and therapeutic procedures for combating serious human diseases. All these activities emphasize the Institute's prominent role in biomedical research in the Czech Republic.

WHAT IS THERE TO KNOW ABOUT IPHYS?

- Research at IPHYS has a more than 60-year tradition and includes three main topics: neurophysiology, cardiovascular physiology and metabolism (6–7)
- Experiments are conducted at the molecular to whole-organism level (9–11)
- IPHYS has almost 400 employees with 60 principal investigators, expressed revalued time work is nearing 320. It is supervised by the director and the IPHYS Boards (12–13)
- The scientists of IPHYS closely collaborate with many academic and clinical institutions (14)
- IPHYS consists of 21 scientific and 7 service departments (15–65)
- IPHYS is the partner of the excellence project BIOCEV, a joint project of six institutes of CAS and Charles University (58)
- IPHYS publishes the peer-reviewed journal Physiological Research (65)
- IPHYS is a member of the infrastructure network Czech Bioimaging (66)
- The top equipment for physiological research is available at IPHYS (67)
- The scientists of IPHYS successfully attract research funding at both the national and international level (68–69)
- IPHYS participates in Centres of Excellence and other major projects (69)
- IPHYS is the coordinator of two research programmes within the new Strategy AV21 of CAS - Wellbeing in health and disease (QUALITAS) and Preclinical testing of potential pharmaceuticals (70)
- IPHYS employs world-renowned experts awarded major domestic and foreign prizes for their scientific work (71)
- More than 150 scientific articles are published per year by scientists of IPHYS (72–73)
- In collaboration with universities, IPHYS trains dozens of bachelor's, master's and PhD students (74–75)
- Results obtained at IPHYS are actively presented to the scientific community as well as to the general public (76–77)

HISTORY OF IPHYS

MORE THAN 60-YEAR TRADITION OF IPHYS RESEARCH...

Zdeněk Servít

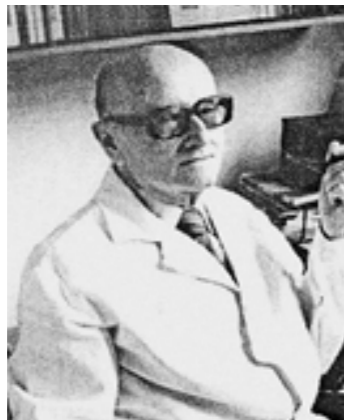

Arnošt Gutmann



The origin of the current IPHYS is traced back to 1950 when two outstanding personalities, **Prof. Zdeněk Servít** (1913–1986) and **Prof. Arnošt Gutmann** (1910–1977), met at the Department of Neurophysiology within the Central Biological Institutes. In 1952, the Czechoslovak Academy of Sciences (CSAV) was founded. Servít's laboratory (epileptology) and Gutmann's laboratory (neuromuscular function) joined a group interested in critical periods of ontogenetic development headed by **Prof. Jiří Křeček** (1923–2014) to form a section of the new Biological Institute. On the basis of successful research and acceptance at home as well as abroad, IPHYS was officially founded on January 1, 1954 and consisted of these three laboratories. In 1956, a fourth group led by **Prof. Otakar Poupa** (1916–1999), who studied the adaptation of the organism to its environment, joined the Institute. The outstanding contribution of these scientists in the fields of neurophysiology, muscle regeneration, heart adaptation to hypoxia and late effects of early interventions was subsequently enriched by their students and follower scientists at IPHYS.

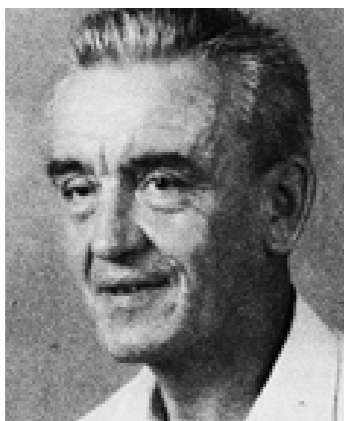

Jiří Křeček



Otakar Poupa

HIGHLIGHTS OF RESEARCH ACTIVITIES

AND THEIR LEADERS OVER THE HISTORY OF IPHYS

NEURONAL AND BRAIN SYSTEM

- epileptology (**Prof. Zdeněk Servít**)
- trophic influence of nerves on skeletal muscle (**Prof. Arnošt Gutmann**)
- physiology and morphology of peripheral sensory systems (**Dr. Jiřina Zelená**)
- coordination of spinal cord and skeletal muscle (**Dr. Pavel Hník**)
- cellular electrophysiology of skeletal muscle (**Dr. Radan Beránek**)
- non-quantal acetylcholine release at neuromuscular junction (**Prof. František Vyskočil**)
- functional neurobiology of spinal cord in respect to nociception (**Dr. Ladislav Vyklický, Sr**)
- neurochemistry of acetylcholine receptors (**Prof. Stanislav Tuček**)
- functional neurobiology of memory formation and consolidation (**Dr. Jan Bureš, Dr. Olga Burešová**)
- brain function during sleep and active state (**Prof. Tomáš Radil**)
- brain function and behavior (**Dr. Olga Nováková, Dr. Jaroslav Šterc**)
- brain neurochemistry during ontogenesis (**Dr. Jaroslava Folbergrová**)
- ontogenetic mechanisms of epileptogenesis (**Prof. Pavel Mareš**)
- construction of unique instruments for neuromuscular research and participation in the development of the patch-clamp approach (**Ing. Vojtěch Rohlíček, Ing. Evžen Ujec**)

CARDIOVASCULAR SYSTEM

- cardiac adaptation to chronic hypoxia (**Prof. Otakar Poupa**)
- experimental cardiac necrosis (**Dr. Eva Faltová**)
- ontogenetic and phylogenetic aspects of cardiac sensitivity to oxygen deficiency (**Prof. Bohuslav Ošťádal**)
- precise timing of major ontogenetic periods on the basis of nutritional changes (**Dr. Ivana Ošťádalová**)
- early hemodynamic changes in hypertensive animals (**Dr. Ivan Albrecht**)

METABOLISM

- ontogenetic aspects of energy and especially lipid metabolism (**Prof. Peter Hahn**)
- late effects of early interventions on lipid metabolism (**Prof. Peter Hahn, Prof. Otakar Koldovský**)
- postnatal development of gastrointestinal function (**Prof. Otakar Koldovský**)
- mitochondrial functions and brown adipose tissue (**Dr. Zdeněk Drahoš**)
- water and electrolyte distribution in the developing organism (**Dr. Jiří Jelínek**)
- altered regulation of cholesterol esterification rate in pathogenesis of human atherogenesis (**Dr. Milada Dobiášová**)
- collagen metabolism (**Prof. Zdeněk Deyl**)
- trace elements interactions (**Dr. Jiří Pařízek**)

Of course, the above assignment of the activities to one of the main fields of research is quite simplistic, because most of the activities span across multiple fields, e.g. the studies of circadian biorhythm control in central and peripheral systems, which were initiated by **Prof. Helena Illnerová** (the President of the CAS during 2001–2005), helped to integrate the research efforts at IPHYS.

Not all the outstanding scientists who were affiliated with IPHYS during its history could be named here. This generation and the other personnel currently working at IPHYS are described in the text that follows.



RESEARCH STRATEGY

THE OVERALL RESEARCH STRATEGY AT IPHYS COMBINES COMPLEMENTARY EFFORTS IN SEVERAL FIELDS. BOTH ANIMAL AND HUMAN STUDIES ARE PERFORMED.

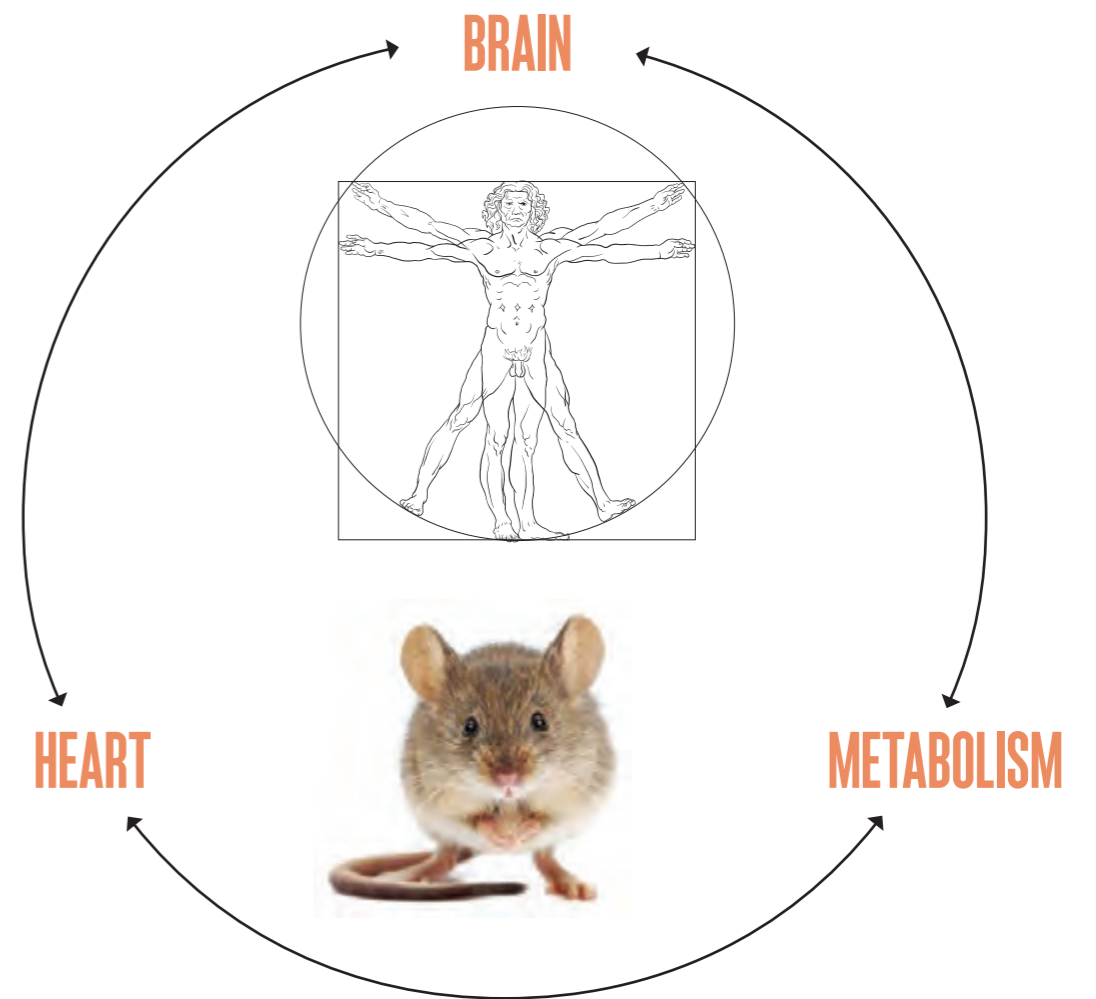

MAIN RESEARCH FIELDS

NEURONAL AND BRAIN SYSTEM

Neuroscience research covers studies aimed at understanding basic physiological and pathological processes related to human neurological and psychiatric diseases. Investigations at the system level study integrative functions of the central nervous system that include cognitive functions (memory, spatial orientation or learning), chronic pain, and epilepsy. At the cellular level circadian rhythms (i.e. processes repeated rhythmically during a 24-hour period) and pathophysiological mechanisms of drug addictions are investigated. Studies at the molecular level are aimed at revealing the biochemical principles of signal transmission from one cell to another, structural and functional correlations of neurotransmitter receptor activation and modulation by biological and pharmacological compounds. Aspects of neural transmission are studied in vivo, in vitro as well as theoretically using computer simulations and modelling.

DISEASES IN FOCUS

ALZHEIMER'S DISEASE—SCHIZOPHRENIA—DEPRESSION—EPILEPSY
DISORDER OF BIORHYTHMS—NEUROPATHIC PAIN—NEURODEGENERATION—AUTISM
INBORN COGNITIVE DEFECTS—CHANNELOPATHIES

CARDIOVASCULAR SYSTEM

Research in the cardiovascular field includes studies on the mechanisms of the development, therapy and prevention of serious cardiovascular diseases, such as ischemic heart disease, hypertension and chronic heart and kidney failure. Particular attention is devoted to the development of cardiac adaptation to oxygen deprivation and mechanisms of cardiac protection. Studies on the mechanisms of blood pressure regulation, vascular contractions and development of the conductive system represent a basis for new therapeutic approaches to hypertension and cardiac arrhythmias. The genetic approach deals with modifications or defects of selected genes responsible for cardiovascular diseases. Work is also being done on the development of biomaterials that may be suitable for synthetic vascular replacements.

DISEASES IN FOCUS

HYPERTENSION—ISCHEMIC HEART DISEASE—CHRONIC HEART FAILURE
HEART ARRHYTHMIAS—CHRONIC KIDNEY FAILURE

METABOLISM

Studies in the metabolic field cover specific problems from the cellular to whole-body level. The research is focused on the investigation of transport systems in cell membranes, specific signaling pathways affecting metabolism, the function of mitochondria and the impact of mitochondrial dysfunction on health, interactions between nutrition and the immune system that affect metabolism, circadian control of metabolism, genetic basis of obesity-related diseases as well as the ontogenic aspects and the role of ageing in metabolic health.

DISEASES IN FOCUS

OBESITY AND METABOLIC SYNDROME—DIABETES MELLITUS TYPE 2
INHERITED METABOLIC DISEASES—DISEASES OF THE INTESTINE
CANCER—INFECTIONS BY YEASTS

COMPLEXITY LEVELS OF RESEARCH

NEURONAL AND BRAIN SYSTEM

- Circadian rhythms
- Memory
- Epilepsy
- Alzheimer's disease
- Pain

CARDIOVASCULAR SYSTEM

SYSTEM LEVEL

- Central and peripheral blood pressure control
- Regulation of embryonic cardiac output
- Pathophysiology of heart failure
- Cardiac adaptation to hypoxia, protective mechanisms

METABOLISM

- Neurohumoral control
- Energy expenditure
- Glucose homeostasis
- Biomarkers
- Nutritional interventions
- Metabolic syndrome

CELLULAR LEVEL

- Synaptic transmission
- Neuromodulation
- Nociception
- Ionic channels: NMDA, TRP, nicotinic, purinergic
- Metabotropic receptors: muscarinic, adrenergic
- Secretion of pituitary hormones
- Computational approach

- Calcium influx and calcium sensitization in contractility of resistance arteries
- Calcium transients and ion channels
- Gap junctional coupling
- Cell proliferation in cardiac growth and regeneration

- Intracellular signaling
- Mitochondrial (dys)function
- Membrane biophysics

MOLECULAR LEVEL

- Receptor structure - function
- Gene and protein expression

- Adrenergic receptor number regulation
- Mitochondrial function
- RhoA/Rho kinase pathway in calcium sensitization

- Transport proteins
- Reactive oxygen species
- Structure of signaling proteins

IPHYS MANAGEMENT

Director

MUDr. Jan Kopecký, DrSc.



Chairman of the Council

PharmDr. Alena Sumová, DSc.



Vice-director

Prof. MUDr. Ladislav Vyklický, DrSc.



Secretary

Ing. Petra Janečková

IPHYS BOARDS

COUNCIL OF IPHYS

Chairman

PharmDr. Alena Sumová, DSc.

Vice-Chairman

RNDr. Ivana Vaněčková, DSc.

Internal Members

Doc. MUDr. Lucie Bačáková, CSc.

Prof. RNDr. František Kolář, CSc.

Prof. RNDr. Aleš Stuchlík, Ph.D.

RNDr. Hana Sychrová, DrSc.

External Members

Prof. RNDr. Jan Černý, Ph.D.

Charles University, Prague

Prof. Ing. Martin Fusek, CSc.

Institute of Organic Chemistry and Biochemistry CAS

RNDr. Vladimír Kořínek, CSc.

Institute of Molecular genetics CAS

Secretary

Ing. Kateřina Špačková

SUPERVISORY BOARD OF IPHYS

Chairman

Prof. Ing. Vladimír Mareček, DrSc.
J. Heyrovsky Institute of Physical Chemistry CAS

Vice-Chairman

RNDr. Jaroslav Kuneš, DrSc.
IPHYS

Members

Mgr. Ing. Jindřich Hroch
attorney-at-law

Prof. MUDr. Zuzana Červinková, CSc.
Faculty of Medicine of Charles University, Hradec Králové

Doc. MUDr. Vojtěch Melenovský, CSc.
Institute for Clinical and Experimental Medicine, Prague

Secretary

Ing. Michaela Jirečková

COLLABORATIONS

MOST OF IPHYS RESEARCH IS CONDUCTED IN THE FRAMEWORK OF DOMESTIC AND INTERNATIONAL COLLABORATION.

Among the principal Czech partners of IPHYS belong the major institutions located in Prague, namely the faculties of Charles University (CU), the Institute of Organic Chemistry and Biochemistry CAS (IOCB), Motol University Hospital (MUH), National Institute of Mental Health (NIMH) and Institute of Clinical and Experimental Medicine (IKEM). Many research collaborations all around the world are of increasing importance for the quality of the research at IPHYS. Only those with formal institutional collaborative agreements are depicted below.

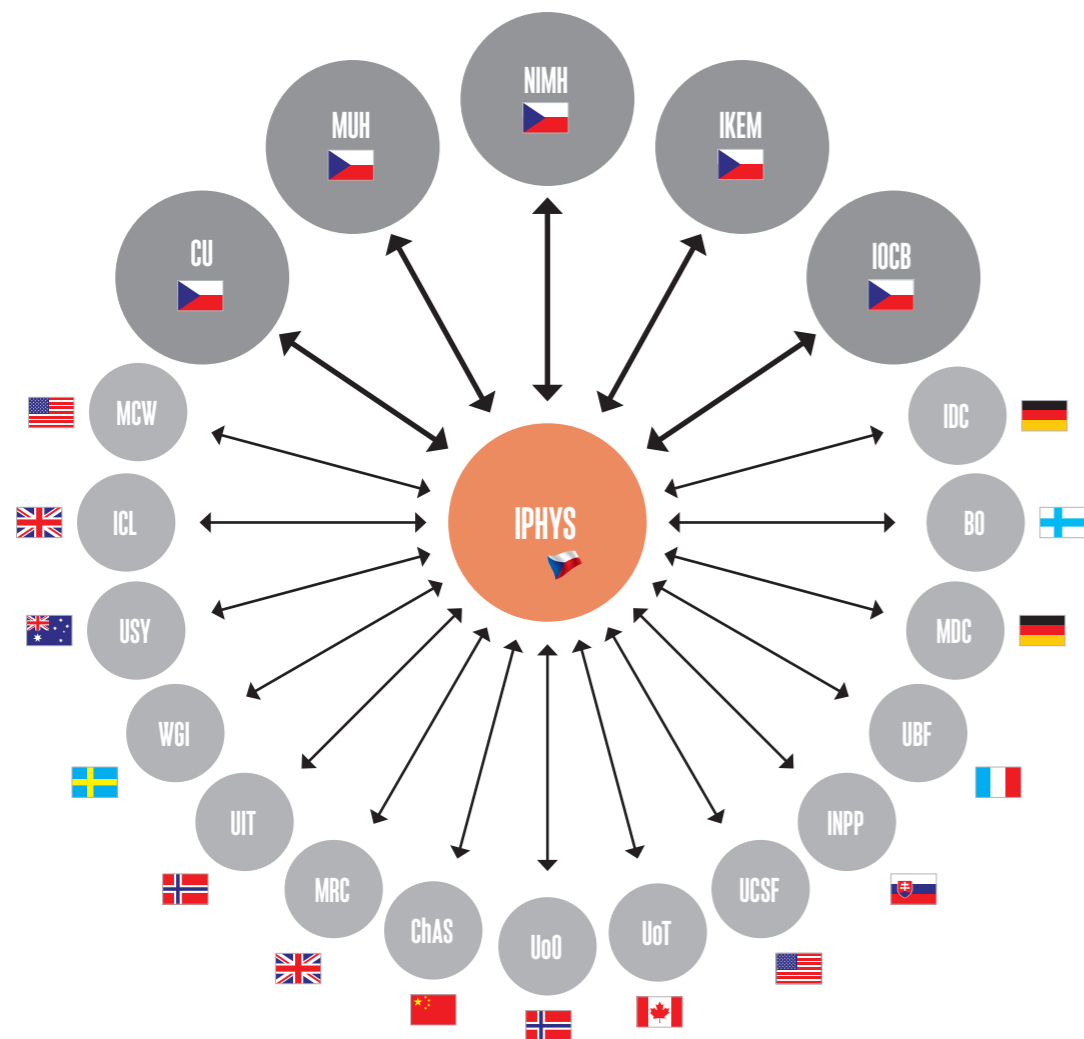

COLLABORATIVE AGREEMENTS OF IPHYS WITH EXTERNAL PARTNERS

Medical College of Wisconsin (MCW), Imperial College London, Department of Surgery and Cancer (ICL), University of Sydney (USY), Stockholm University - Wenner-Gren institute (WGI), The Arctic University of Norway (UIT), Medical Research Council - Laboratory of Molecular Biology (MRC), Chinese Academy of Sciences (ChAS), University of Oslo (UoO), University of Toronto (UoT), University of California (UCSF), Institute of Normal and Pathological Physiology, Slovak Academy of Sciences (INPP), University of Bordeaux (UBF), Max Delbrück Center for Molecular Medicine in the Helmholtz Association (MDC), University of Oulu - Biocenter Oulu and Medical Research Center Oulu (BO), Institute of Diabetes and Cancer, Helmholtz Center (IDC).

SCIENTIFIC DEPARTMENTS

*** ZACHOVEJTE TICHŮ
JE NEZBYTNĚ K POKUSŮM**

- Adipose Tissue Biology (16)
- Analysis of Biologically Important Compounds (18)
- Bioenergetics (20)
- Biomaterials and Tissue Engineering (22)
- Biomathematics (24)
- Cellular and Molecular Neuroendocrinology (26)
- Cellular Neurophysiology (28)
- Computational Neuroscience (30)
- Developmental Cardiology (32)
- Developmental Epileptology (34)
- Epithelial Physiology (36)
- Experimental Hypertension (38)
- Functional Morphology (40)
- Genetics of Model Diseases (42)
- Membrane Transport (44)
- Mitochondrial Physiology (46)
- Molecular Neurobiology (48)
- Neurochemistry (50)
- Neurohumoral Regulations (52)
- Neurophysiology of Memory (54)
- Structural Biology of Signaling Proteins (56)

***KEEP SILENCE
IT IS NECESSARY FOR EXPERIMENTS**

ADIPOSE TISSUE BIOLOGY

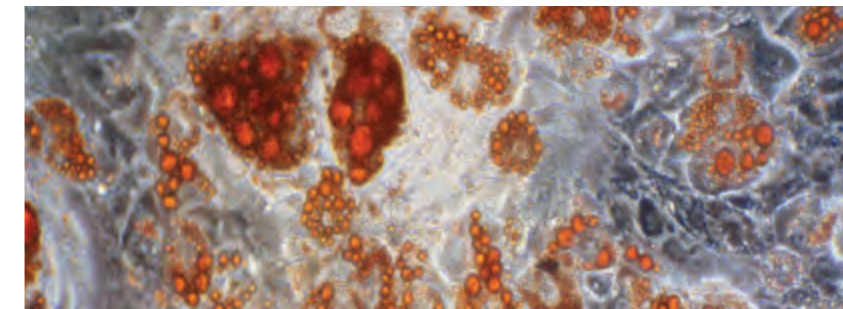

A microscopical image of adipose cells – adipocytes – grown on a dish in cell culture. Lipid accumulation inside the differentiated adipocytes was visualized by staining with a dye Oil Red O.

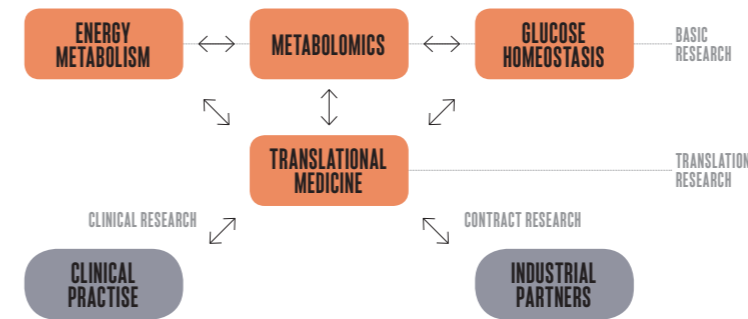

The Department is subdivided into three Research units with complementary focus, which closely collaborate and are engaged in translational research conducted together with clinical as well as industrial partners.

CURRENT PROJECTS

- Physiological relevance of white adipose tissue plasticity and its relationship to the development of obesity; enhancing the lipid-buffering capacity of the tissue by various interventions (omega-3s, calorie restriction, cold)
- Metabolism of eicosanoids in adipose tissue: molecular mechanisms with respect to fatty acid substrate
- The role of the endocannabinoid system in the metabolic effects of marine omega-3 phospholipids
- The role of the intestine in the differential metabolic effects of various lipid forms of dietary omega-3s
- Perinatal regulation of metabolism in humans

head MUDr. Martin Rossmeißl, Ph.D.
e-mail martin.rossmeisl@fgu.cas.cz



researchers Kristina Bardová, Pavel Flachs (†2016), Olga Horáková, Petra Janovská, Jan Kopecký, Ondřej Kuda, Michaela Svobodová
PhD students Kateřina Adamcová, Marie Březinová, Jiří Funda, Jana Hansíková, Veronika Kalendová, Petra Kuchaříková, Marina Oseeva, Jana Pavlišová, Martina Rombaldová, Gabriella Sistilli
technical support Jaroslava Bémová, Ilona Berková, Soňa Hornová, Jana Jahelková, Adéla Krejčárková, Petr Macek, Daniela Šálková

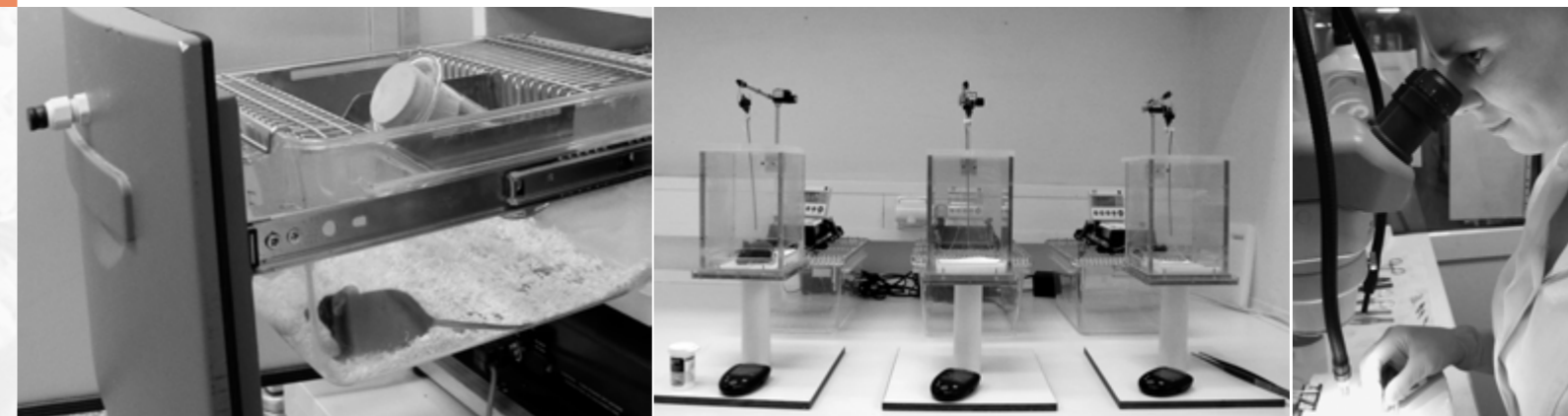

SELECTED OUTPUTS

- Proof-of-concept studies in mice – modulation of white adipose tissue metabolism could reduce obesity (Kopecky et al. (1996) Am J Physiol-Endocrinol Metab 270, E768-E7750).
- Chemical derivatives of omega-3 fatty acid DHA exert anti-obesity effects and improve lipid and glucose metabolism (Rossmeißl et al. (2009) Obesity 17, 1023–1031; US patent no. 7,550,613 B2).
- Omega-3s stimulate the secretion of the insulin-sensitizing hormone adiponectin in obese mice (Flachs et al. (2006) Diabetologia 49, 394–397) – the most cited paper of IPHYS from 2005–2016.
- Omega-3s augment the beneficial effects of antidiabetic drugs in obese mice (Kuda et al. (2009) Diabetologia 52, 941–951) and diabetic patients (Veleba et al. (2015) Nutr Metab 12, 52).
- Omega-3s reduce accumulation of liver fat depending on AMP-activated protein kinase (Jelenik et al. (2010) Diabetes 59, 2737–2746).
- Omega-3s in the form of marine phospholipids are more effective than their triacylglycerol form in ameliorating metabolic disturbances in obesity (Rossmeißl et al. (2012) PloS One 7, e38834).
- Novel lipid mediators derived from DHA are involved in the anti-inflammatory effects of omega-3s in mice and humans (Kuda et al. (2016) Diabetes 65, 2580–2590).

We study the physiological regulation of metabolism and their disturbances in obesity and associated diseases (i.e. **METABOLIC SYNDROME**). In order to help treat these disorders, we explore the influence of drugs, diet and natural substances, namely n-3 polyunsaturated fatty acids of marine origin (**OMEGA-3s**). Our results show that **ADIPOSE TISSUE METABOLISM** plays a key role in the development of obesity-associated diseases and represents a suitable target for the treatment of these diseases. We investigate various aspects of metabolism in adipose tissue, liver, muscle and intestine and its regulations by combining experiments on mice and cell models with clinical studies, and we try to apply new knowledge in clinical medicine (see figure on the right). While working with the manufacturers of the tested substances in the Czech Republic and Norway, we investigate the possible use of omega-3s to increase the effect of drugs and other substances in the treatment of selected diseases.

ANALYSIS OF BIOLOGICALLY IMPORTANT COMPOUNDS



head Prof. Ing. Ivan Mikšík, DrSc.
e-mail ivan.miksik@fgu.cas.cz

researchers Adam Eckhardt, Michal Jágr, Stasis Pataridis, Pavla Sedláková, Jana Svobodová **PhD student** Lucie Kulhavá **technical support** Pavla Šmigolová

In this department, new separation methods (**CAPILLARY ELECTROMIGRATION TECHNIQUES**, incl. coupling CE-MS) for physiological research are developed. Various physiological aspects of the ageing and disease of **CONNECTIVE TISSUES** are studied. For example, the **PROTEOME** of human **TEETH** and **SALIVA** and their connection with tooth decay were examined, as were insoluble proteins from the avian eggshell, especially the cuticle. We have conducted analyses of the posttranslational modifications of proteins, discovered the compounds arising in the glycation reaction as well as the sites of modifications and identified age- and disease-related changes in proteins.

Our department serves as the **PROTEOMIC FACILITY** of the IPHYS, using qualitative and quantitative differential proteomic approaches. A broad spectrum of biologically important compounds for physiological research are analysed in collaboration with many departments of the IPHYS and various Czech and international institutions (e.g. steroids, pigments).



Protein analysis of data from mass spectrometer coupled to nano-liquid chromatography.

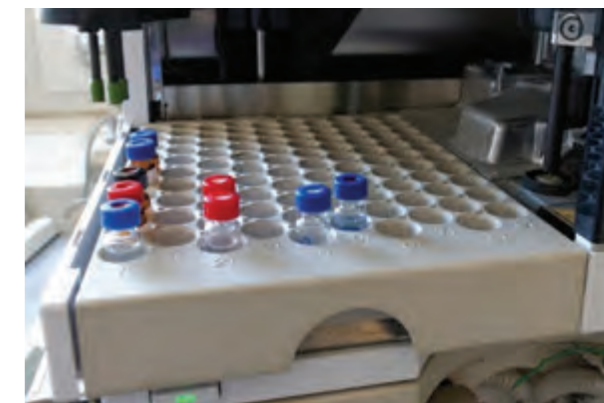

Autosampler of HPLC (high-performance liquid chromatography).

CURRENT PROJECTS

- Predictive role of proteomic composition of teeth and saliva in the etiology of tooth decay
- A correlative approach to extracellular matrix disorders: from proteins to tissue architecture at idiopathic pes equinovarus
- Analysis of proteins of connective tissue, their modifications
- Analysis of eggshell pigments and proteins
- Methodological progress and development of new separation methods applicable for the estimation of physiologically important compounds (capillary electrophoresis and HPLC/MS)



SELECTED OUTPUTS

- Jágr et al. Proteomic analysis of human tooth pulp proteomes - Comparison of caries-resistant and caries-susceptible persons. *J Proteomics* 145, 127-136 (2016).
- Mikšík et al. Proteins and their modifications in a medieval mummy. *Protein Sci* 25(11), 2037-2044 (2016).
- Mikšík et al. Proteomic analysis of chicken eggshell cuticle membrane layer. *Analytic Bioanalytic Chem* 406 (29), 7633-7640 (2014).
- Pataridis et al. Monotopic modifications derived from in vitro glycation of albumin with ribose. *Electrophoresis* 34(12), 1757-1763 (2013).
- Mikšík et al. Open-tubular capillary electrochromatography with bare gold nanoparticles-based stationary phase applied to separation of trypsin digested native and glycosylated proteins. *J Separ Sci* 35(8), 994-1002 (2012).

BIOENERGETICS



head RNDr. Tomáš Mráček, Ph.D.
e-mail tomas.mracek@fgu.cas.cz

researchers Lukáš Alán, Andrea Brázdová, Josef Houšťek, Vilma Kaplanová, Petr Pecina, Alena Pecinová, David Pajuelo Reguera, Kateřina Tauchmannová, Marek Vrbacký
emeritus Zdeněk Dražbata
PhD students Zuzana Drašnarová, Jana Kovalčíková, Michal Zima
technical support Radka Bardoňová, Vladimíra Brožková

We study the physiology of **MITOCHONDRIA**, the cell organelles responsible for the majority of energy production at the molecular level. We use both animal models and cells derived from patients harbouring various mitochondrial disorders. Our research is focused mainly on:

The assembly of **MITOCHONDRIAL RESPIRATORY CHAIN COMPLEXES** and supercomplexes and protein factors involved in this process.

Human diseases caused by mutations in genes involved in mitochondrial energy provision - **MITOPATHIES**. Identification of new mitochondrial genes that play a causal role in **METABOLIC SYNDROME** and **HEART FAILURE**.

Interaction between mitochondrial and nuclear genomes. The role of **mtDNA HAPLOTYPES** in the development of complex metabolic phenotypes.

CURRENT PROJECTS

- Mitochondrial myopathies – identification of disease-causing genes, exploring therapeutic prospects for ATP synthase deficiencies
- Mitochondrial ATP synthase – assembly factors for the biogenesis of the enzyme, role of small subunits in Fo domain
- Cytochrome c oxidase – regulation of biogenesis and function with a particular emphasis on SURF1 and COX IV proteins
- Glycerol-3-phosphate dehydrogenase – mechanisms of reactive oxygen species production, role in the metabolism of cancer cells
- Mitochondrial proteomics – shotgun and targeted approaches to evaluation of mitoproteome changes in disease models
- New diagnostic approaches to mitochondrial diseases – the development of protocols using leukocytes for frontline diagnostics of suspected mitochondrial patients

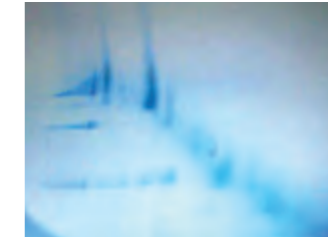
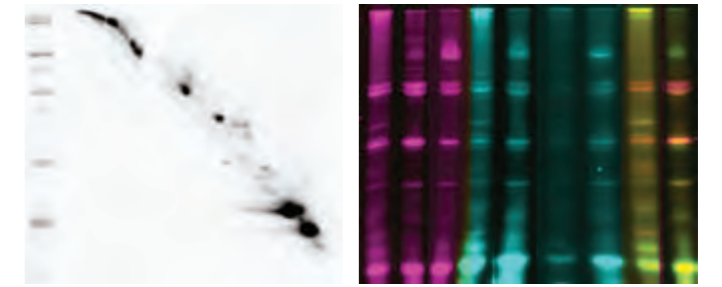

Upper panels: Various electrophoretic approaches to analyse composition of mitochondrial respiratory complexes. Lower panel: Mitochondrial reticulum (red) and actin cytoskeleton (green) in cultured human skin fibroblasts.

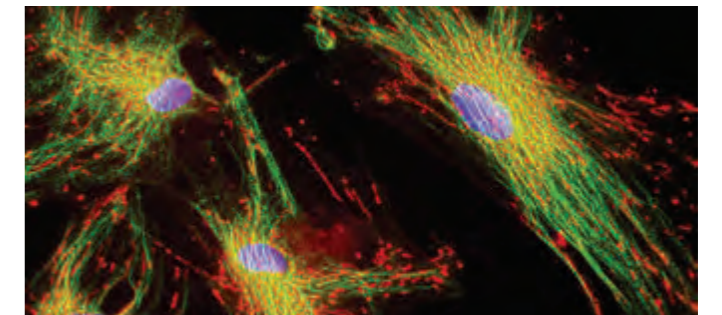

SELECTED OUTPUTS

- Deficiencies in F1Fo ATP synthase and the role of TMEM70 protein: Čížková et al. TMEM70 mutations cause isolated ATP synthase deficiency and neonatal mitochondrial encephalocardiomyopathy. *Nat Genet* 40(11), 1288-1290 (2008). Vrbacký et al. Knockout of Tmem70 alters biogenesis of ATP synthase and leads to embryonal lethality in mice. *Hum Mol Genet* 25(21), 4674-4685 (2016).
- Mitochondrial diseases: Hartmannová et al. Acadian variant of Fanconi syndrome is caused by mitochondrial respiratory chain complex I deficiency due to a non-coding mutation in complex I assembly factor NDUFAF6. *Hum Mol Genet* 25(18), 4062-4079 (2016); Kovářová et al. Tissue- and species-specific differences in cytochrome c oxidase assembly induced by SURF1 defects. *Biochim Biophys Acta* 1862(4), 705-715 (2016).
- Role of mitochondria in heart failure: Melenovský et al. Myocardial iron content and mitochondrial function in human heart failure: a direct tissue analysis. *Eur J Heart Fail* 19(4), 522-530 (2017).

BIOMATERIALS AND TISSUE ENGINEERING



head Doc. MUDr. Lucie Bačáková, CSc.
e-mail lucie.bacakova@fgu.cas.cz

researchers Markéta Bačáková, Antonín Brož, Elena Filová, Jaroslav Chlupáč, Jarmila Knitlová, Ivana Kopová, Věra Lisá, Jana Lišková, Roman Matějka, Jana Musílková, Martin Pařízek, Martin Plencner, Lubica Staňková, Jana Štěpanovská, Marta Vandrovcová, Jana Zárubová **PhD students** Martina Doubková, Radmila Kudláčková, Júlia Pajorová, Marie Steinerová, Martina Trávníčková
technical support Jana Voborníková, Ivana Zajanová

The Department is subdivided into three research groups: **VASCULAR TISSUE ENGINEERING, BONE TISSUE ENGINEERING** and **SKIN TISSUE ENGINEERING**. Within each group, the main tasks are (1) to improve currently-used tissue replacements by introducing cell and other biological components, and (2) to construct completely new replacements on the basis of **BIOMATERIALS** (synthetic and nature-derived) and cells. In order to achieve these goals, we carry out studies on the molecular mechanisms of cell behavior on synthetic and nature-derived materials, such as the **ADHESION, GROWTH, DIFFERENTIATION** and **VIABILITY** of cells on artificial materials, together with studies on potential damage and **IMMUNE ACTIVATION**. We use differentiated cells (animal cells or commercially available human cells) or human **STEM CELLS** (stem cells derived from adipose tissue obtained by liposuction) as the cell component of these constructs.

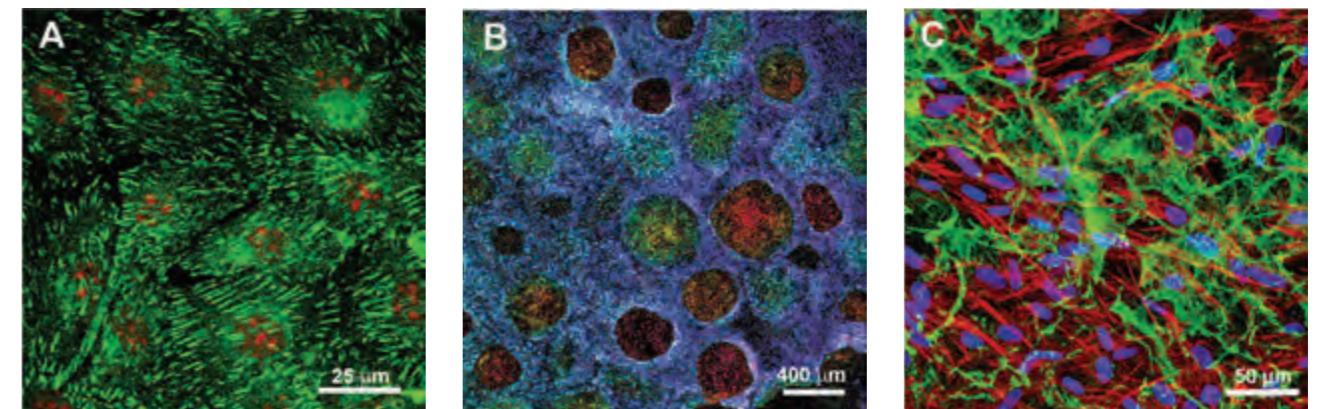

Examples of vascular, bone and skin tissue engineering. **A:** talin-containing focal adhesion plaques in vascular endothelial cells on a fibrin layer for the inner coating of vascular prostheses; **B:** ingrowth of human osteoblast-like cells into porous PLGA scaffolds; **C:** human dermal fibroblasts on a polylactide nanofibrous membrane coated with a fibrin nanolayer.

CURRENT PROJECTS

- The preparation, modification and characterization of materials by radiation, interaction of these materials with cells and use of these materials for the construction of tissue replacements
- Small-diameter vascular prostheses seeded with endothelial cells and bone marrow-derived stem cells in a bioreactor
- Electroactive films on titanium alloy substrates for surface modification of bone implants
- Application of adipose tissue-derived stem cells obtained by liposuction in tissue engineering
- Growth of human skin cells on biomimetic nanofibrous matrices for active wound healing



SELECTED OUTPUTS

- Bacakova M et al. The potential applications of fibrin-coated electrospun polylactide nanofibers in skin tissue engineering. *Int J Nanomedicine* 11, 771-789 (2016).
- Kaplan et al. Enhanced mitogenic activity of recombinant human vascular endothelial growth factor VEGF121 expressed in *E. coli* Origami B (DE3) with molecular chaperones. *PLoS One* 11(10), e0163697 (2016).
- Vandrovцова et al. Interaction of human osteoblast-like Saos-2 and MG-63 cells with thermally oxidized surfaces of a titanium-niobium alloy. *PLoS One* 9(6), e100475 (2014).
- Filova et al. The diameter of nanotubes formed on Ti-6Al-4V alloy controls the adhesion and differentiation of Saos-2 cells. *Int J Nanomedicine* 10, 7145-7163 (2015).
- Chlupac et al. The gene expression of human endothelial cells is modulated by subendothelial extracellular matrix proteins: short-term response to laminar shear stress. *Tissue Eng Part A*, 20, 2253-2264 (2014).
- Czech Patent: Fencel J, Janecek M, Strasky J, Harcuba P, Havlikova J, Bacakova L. Joint implant and mode of its fabrication. ID 304445 (2014).

BIOMATHEMATICS

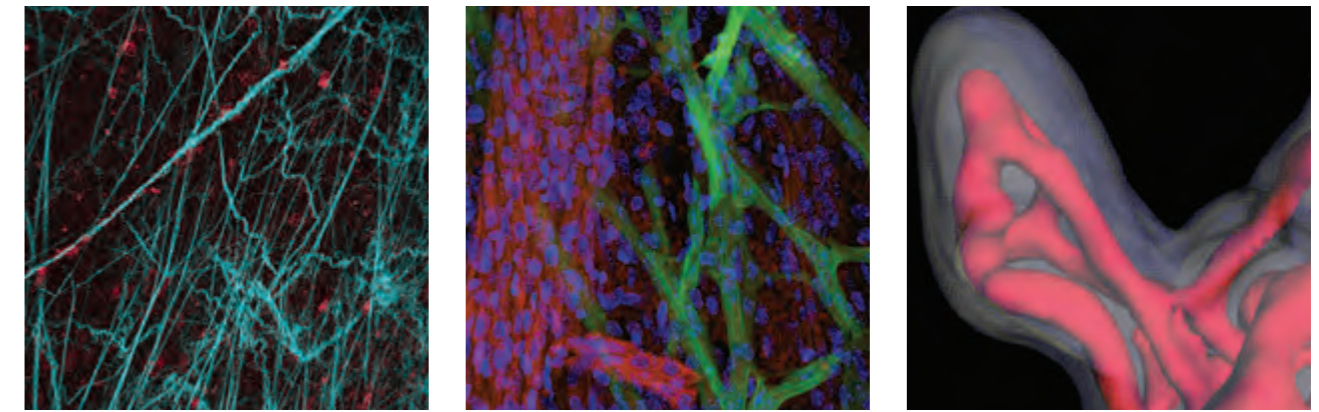

Images acquired by two-photon and confocal microscopes of the Czech-BioImaging microscopic facility at the Department of Biomathematics. Left: collagen fibres in mouse melanoma (SHG imaging, cooperation with Prof. Vannucci, Institute of Microbiology CAS); middle: Purkinje fibers in mouse heart (maximum projection, cooperation with Prof. Sedmera); right: blood capillaries in human placenta (3D reconstruction, cooperation with Doc. Jirkovská, 1st Medical Faculty, Charles University in Prague).

CURRENT PROJECTS

- Morphology of the conduction system in the developing murine heart
- The effect of long-term morphine administration and withdrawal on the function of opioid receptors
- Analysis of the effect of lithium on delta-opioid receptors in living cells and isolated cell membranes
- The role of plasma membrane hydrophobic lipids and membrane domains in cellular communication
- Interaction of cytoplasmic domains and TRP channels
- Study of structure and binding properties of TRPM channels

head RNDr. Jiří Janáček, Ph.D.
e-mail jiri.janacek@fgu.cas.cz



researchers Kristýna Boušová, Jana Brejchová, Martin Čapek, Alexandr Čerňavský, Daniel Hadraba, Petr Karen, Lucie Kubínová, Kevin Jia-Lin Loo, Radek Pelc, Barbora Radochová, Lenka Roubalová, Petr Svoboda, Jan Teisinger, Hana Ujčíková, Miroslava Vošahlíková **PhD students** Kristina Cechová, Michaela Czerneková, Adam Frtus, Martina Hloušková, David Kala, Monika Vargová **technical support** Alena Dědičová, Hana Prouzová, Kateřina Špačková, Ivana Švandová, David Vondrášek



The department consists of two research groups:
 The **BIOIMAGING** and **IMAGE ANALYSIS** group conducts research into the 3D microanatomical aspects of physiological phenomena at the mesoscopic, microscopic and ultrastructural level. It is engaged in a range of collaborative projects across the campus and beyond.
 The research of the **BIOCHEMISTRY OF MEMBRANE RECEPTORS** group focuses on the cellular and molecular mechanisms of the desensitization of hormone response mediated by the activation of **G-PROTEIN-COUPLED RECEPTORS** (GPCR), the transducers of extracellular signals across the plasma membrane bilayer to the cell interior. GPCR play a key role in the regulation of many physiological processes and functions, and are one of the most important groups of targets for therapeutics.
 Operating mainly at the *in situ* and *in vitro* levels, respectively, the two groups complement each other when studying phenomena confined to the cell membrane.

SELECTED OUTPUTS

- We developed 3D image analysis and stereological methods for measuring biological structures, e.g. cell volume and surface area or blood capillary length density using confocal images. Our interactive methods with 3D virtual probes enable precise measurement of images that would be difficult to measure by automated image analysis (Kubínová et al. (1998) J Microsc 191, 201-211; Jiráček et al. (2015) Sci Rep 5, 16002).
- Long-term exposure of rats to high doses of morphine causes desensitization of μ -OR- and δ -OR-stimulated G protein response in the rat brain cortex, followed by compensatory and specific increase in adenylyl cyclase (AC I and II) levels in the plasma membranes. A number of altered proteins by morphine dramatically decreased 20 days after the last drug dose. (Ujčíková et al. (2016) J Proteomics 145, 11-23).

CELLULAR AND MOLECULAR NEUROENDOCRINOLOGY

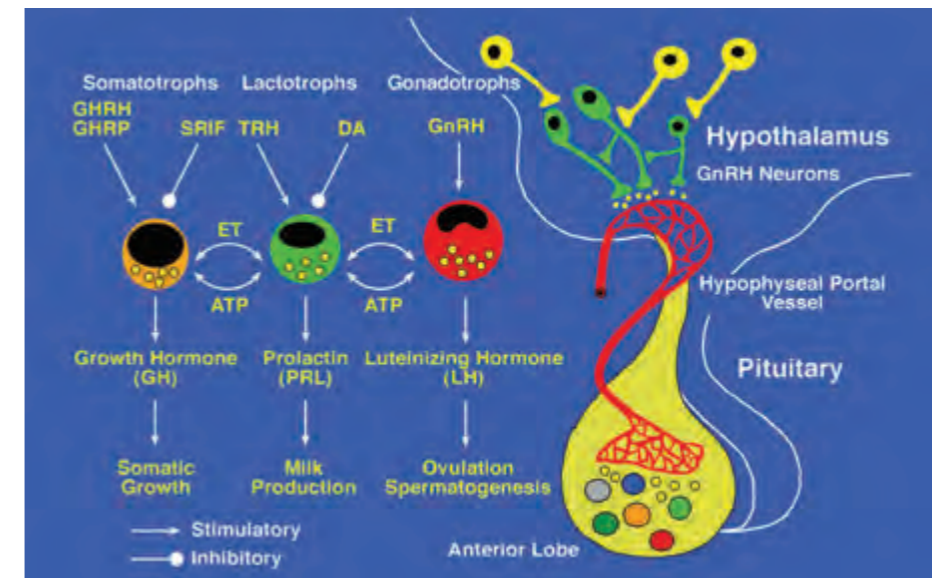

Hypothalamic control of pituitary secretion. Neurosecretory terminals of GnRH-, TRH-, CRH- and GHRH-secreting neurons release peptides that stimulate hormone secretion. Most of pituitary cells also express ATP-gated channels.

CURRENT PROJECTS

- Purinergic signaling in neurons of suprachiasmatic and supraoptic nuclei of the hypothalamus
- Electrical excitability of anterior pituitary cells
- Relationship between molecular structure and function of recombinant purinergic P2X receptor-channels



head RNDr. Hana Zemková, CSc.
e-mail hana.zemkova@fgu.cas.cz

researchers Anirban Bhattacharya, Hana Janoušková, Vendula Stillerová, Irena Svobodová **emeritus** Tomáš Radil **PhD students** Milorad Ivetič, Marian Rupert, Sonja Sivčev **technical support** Irina Kalová

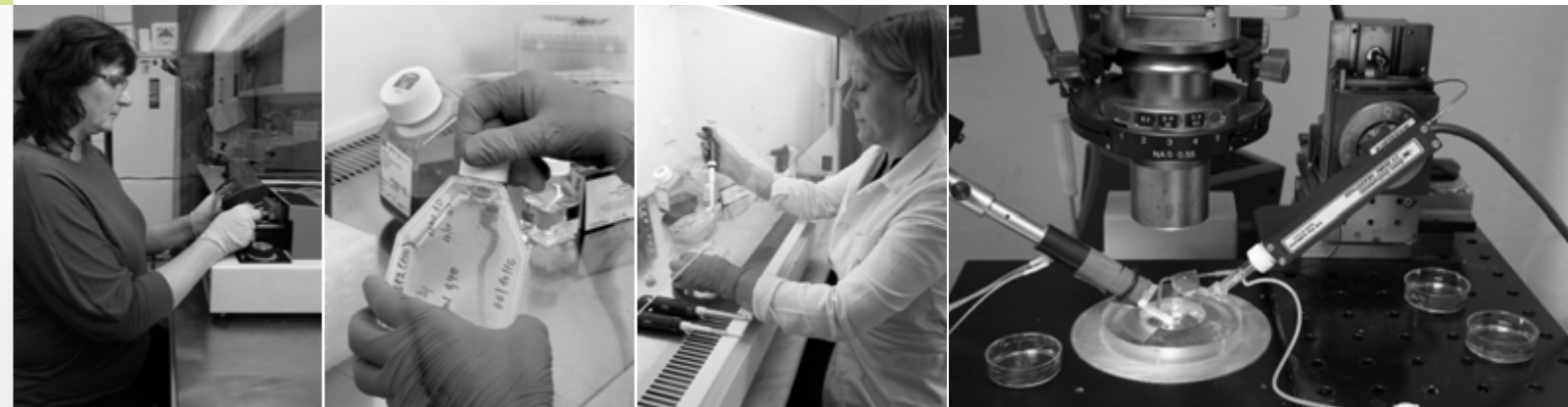

The laboratory is focused on the research of **MEMBRANE RECEPTORS** and **SECRETION** in **NEUROENDOCRINE CELLS**, with a special emphasis on the **PITUITARY** and **HYPOTHALAMUS**. The laboratory investigates interactions between plasma membrane electrical events and receptor-controlled pathways at the cellular and molecular level, determines the manner in which hormones and neurotransmitters utilize calcium and cyclic nucleotides as intracellular messengers, and characterizes **ION CHANNELS** involved in **SYNAPTIC TRANSMISSION** and **HORMONE SECRETION**. Specifically, we address how the structural features of channels relate to their functions, and how plasma membrane receptors and the intracellular signaling milieu affect channel activity. To achieve this, we characterize both native and recombinant channels that stimulate neuroendocrine cells. Our current work is focused on the **ATP-GATED P2X RECEPTORS** and understanding the precise physiological function of this form of secretory cell facilitation.

SELECTED OUTPUTS

- Jelínková et al. Identification of P2X4 receptor transmembrane residues contributing to channel gating and interaction with ivermectin. Pflug Arch-Europ J Physiol 456, 939-950 (2008).
- Vavra et al. Facilitation of glutamate and GABA release by P2X receptor activation in supraoptic neurons from freshly isolated rat brain slices. Neuroscience 188, 1-12 (2011).
- Zemkova et al. Multiple cholinergic signaling pathways in pituitary gonadotrophs. Endocrinology 154, 421-433 (2013).
- Bhattacharya et al. Potentiation of inhibitory synaptic transmission by extracellular ATP in rat suprachiasmatic nuclei. J Neurosci 33, 8035-8044 (2013).
- Zemkova et al. Allosteric regulation of P2X4 receptor channel pore dilation. Pflug Arch-Europ J Physiol 467, 713-726 (2015).

CELLULAR NEUROPHYSIOLOGY



head Prof. MUDr. Ladislav Vyklický, DrSc.
e-mail ladislav.vyklicky@fgu.cas.cz

researchers Aleš Balík, Jiří Černý, Ivan Dittert, Martin Horák, Martina Kaniaková, Miloslav Kořínek, Jan Krůšek, Tereza Smejkalová, Viktorie Vlachová, Lenka Vyklická, Vojtěch Vyklický, Lucie Zimová
emeritus František Vyskočil **PhD students** Jiřina Borovská, Pavla Hubálková, Barbora Krausová, Bohdan Kysilov, Marek Ladislav, Katarina Lichnerová, Lucie Máčliková, Kristýna Skřenková, Viktor Synytsya, Filip Touška
technical support Miloslava Kuldová, Magda Kuntošová, Josef Uher

We study the functional and pharmacological properties of **ION CHANNELS**. We use advanced **ELECTROPHYSIOLOGY METHODS**, primarily the patch-clamp technique, combined with analytical techniques, molecular biology, biochemistry, immunohistochemistry and microfluorometric methods.

We focus on **IONOTROPIC GLUTAMATE RECEPTORS**, specifically the NMDA receptor subtype, which plays an essential role in normal physiology, but under certain pathological conditions can participate in the development of serious **PSYCHIATRIC AND NEUROLOGICAL DISORDERS**. Through detailed study of NMDA receptor structure, pharmacology and trafficking, we aim to identify potential treatments for diseases associated with the dysfunction of the glutamate system.

We also investigate the molecular and biophysical properties and the physiological significance of a specific subclass of **TRP ION CHANNELS** that are involved in the detection of noxious thermal, mechanical and chemical stimuli.

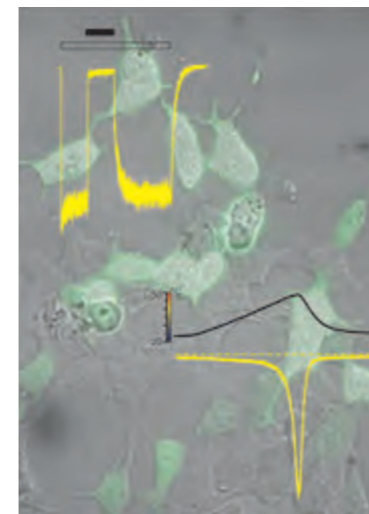
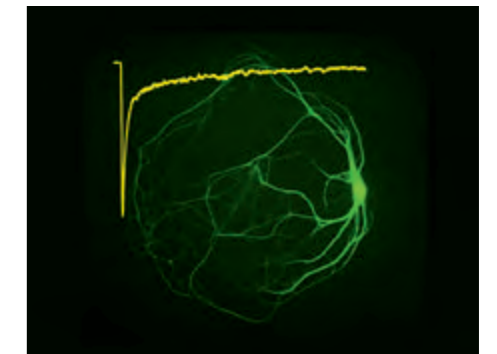
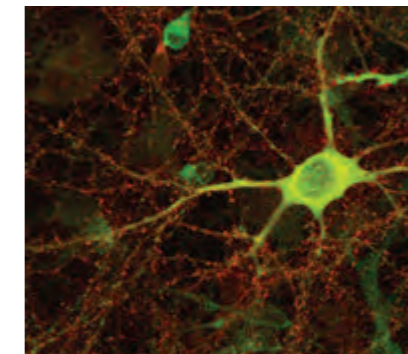

Clockwise from upper left: Model of NMDAR structure (gold) and NMDAR single-channel recording. Confocal micrograph of a primary hippocampal neuron expressing YFP-GluN1 (yellow) immunostained for PSD95 (red). GFP-expressing autaptic hippocampal neuron, inset shows a dual AMPAR/NMDAR-mediated evoked EPSC. GFP-expressing HEK293 cells, insets show NMDAR response to agonist application (top) and TRPV1 response to temperature ramp (bottom).

CURRENT PROJECTS

- Study of the molecular mechanisms of the positive and negative allosteric modulatory action of steroids at NMDA receptors and the influence of these compounds on synaptic transmission
- Study of the structural and functional determinants of early NMDA receptor processing in mammalian neurons
- Investigation of the molecular basis of thermosensitive TRP channel regulation and the role of these channels in the mechanisms of acute and chronic pain



SELECTED OUTPUTS

- We have studied effects of steroids on the NMDARs and found that: i. the site of action for the inhibitory steroids is located at the extracellular vestibule of the receptor's ion channel pore; ii. some newly synthesized steroids (e.g. pregnanolone hemipelate) have no effect on NMDARs activated during synaptic transmission but are potent inhibitors of tonically activated NMDARs, and iii. the probability of opening of NMDA receptors is controlled by membrane cholesterol (Vycklicky et al. (2015) Sci Rep 5, 10935; Vycklicky et al. (2016) J Neurosci 36, 2161-2175; Korinek et al. (2015) J Physiol 593, 2279-2293).
- We have found that NMDARs are only released from the endoplasmic reticulum when two asparagine residues in the GluN1 subunit (N203 and N368) are N-glycosylated. Furthermore, we have identified 23 lectins that pulled down the native GluN1 and GluN2B subunits and we have investigated several lectins that alter the receptor's biophysical properties (Lichnerova et al. (2015) J Biol Chem 290, 18379-18390; Kaniakova et al. (2016) J Neurochem 138, 546-56).
- We have clarified the structural basis underlying the TRPA1-channelopathy-associated pain syndrome. We have also discovered that evolutionarily highly conserved N-terminal structural motifs critically, and each in a different way, contribute to the conformational stability of this channel (Zima et al. (2015) Neuropharmacology 93, 294-307; Hynkova et al. (2016) Sci Rep 6, 28700).

COMPUTATIONAL NEUROSCIENCE

Binary "neuron"

Integrate & Fire

Hodgkin-Huxley

3D detailed

Reality

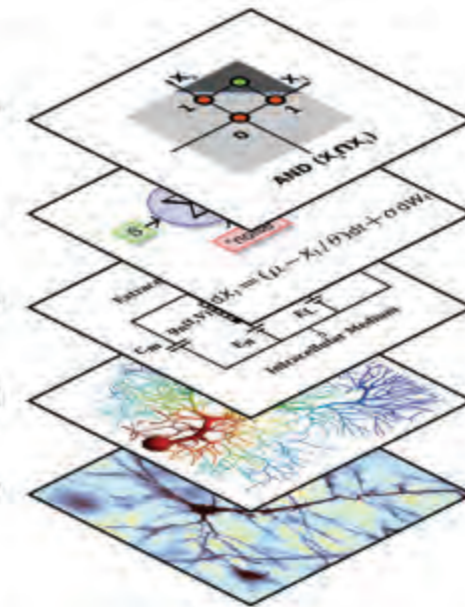

Models can range from detailed biophysical models, describing processes that take place in different parts of the neuron, through models neglecting the space structure of the neuron or the time course of action potentials, to binary neurons acting as logical units.

CURRENT PROJECTS

- Analysis of stochastic neuronal models and estimation of key biophysical parameters under various stimulus encoding schemes
- The impact of different forms of noise together with metabolic energy consumption and decoding complexity on neuronal coding efficiency
- Biophysical modeling of neural connectivity in dependence on the guided growth of axons during development
- Models and analysis of neural oscillations, both of physiological and pathophysiological origin



head Mgr. Lubomír Košťál, Ph.D.
e-mail lubomir.kostal@fgu.cas.cz

researchers Giuseppe D'Onofrio, Petr Lánský, Martin Zápotocký
PhD students Marie Leváková, Ondřej Nováček

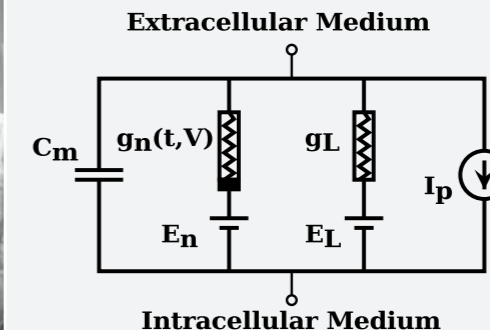

The Computational Neuroscience group investigates the fundamental **MECHANISMS OF INFORMATION REPRESENTATION AND PROCESSING IN THE BRAIN. STOCHASTIC PROCESS**, information theory and statistical estimation theory methods are employed to analyse the **NEURONAL CODE**. Of particular interest is the **EFFICIENT CODING** hypothesis for **SENSORY NEURONS** and the role of noise and **ENERGETIC CONSTRAINTS** in the decoding process.

The group proposes novel analytical and numerical modelling techniques to explore the properties and the function of **NEURAL ACTIVITY, CONTROL AND DEVELOPMENT. BIOPHYSICS**, nonlinear dynamics, **CYBERNETICS** and mathematical statistics methods provide the tools for both simulated and experimental data analysis.

The group is also active in the organization of international conferences and workshops (biennial *Neural Coding* meetings, *OCNS* workshops).

SELECTED OUTPUTS

- Kostal et al. Efficient olfactory coding in the pheromone receptor neuron of a moth. *PLoS Comput Biol* 4, e1000053 (2008).
- Rospars et al. Competitive and noncompetitive odorant interaction in the early neural coding of odorant mixtures. *J Neurosci* 28, 2659-2666 (2008).
- Kobayashi et al. Estimation of time-dependent input from neuronal membrane potential. *Neural Comput* 23, 3070-3093 (2011).
- Bartussek et al. Limit-cycle-based control of the myogenic wingbeat rhythm in the fruit fly *Drosophila*. *J Roy Soc Interface* 10, 20121013 (2013).
- Kostal et al. Measures of statistical dispersion based on Shannon and Fisher information concepts. *Inform Sci* 235, 214-223 (2013).
- Kostal et al. Performance breakdown in optimal stimulus decoding. *J Neural Eng* 12, 036012 (2015).

DEVELOPMENTAL CARDIOLOGY



head Prof. RNDr. František Kolář, CSc.
e-mail frantisek.kolar@fgu.cas.cz

researchers Petra Alánová, Martina Gregorovičová, Markéta Hlaváčková, Kristýna Holzerová, Marie Milerová, Jan Neckář, Olga Nováková, Ivana Ošťádalová, František Papoušek, David Sedmera, Anna Svatoňová, Barbora Šaňková **emeritus** Bohuslav Ošťádal
PhD students Jaroslav Hrdlička, Dita Kašparová, Kristýna Macháčková, Veronika Olejníčková, František Vostárek **technical support** Marie Jindráková, Miloslava Marková, Milana Pešková, Jarmila Svatůňková

ISCHEMIC HEART DISEASE is the main cause of mortality worldwide. We study the cardiac tolerance to injury caused by acute **OXYGEN DEPRIVATION** from the molecular level to the whole organism using animal models. Our research is focused mainly on the study of mechanisms that underlie i) high cardiac tolerance to injury during **EARLY ONTOGENY**, ii) increased cardiac tolerance induced by adaptation to **CHRONIC HYPOXIA** and regular **EXERCISE** training, and iii) altered cardiac tolerance associated with various pathological states.

CONGENITAL HEART DISEASE affects between 0.5-1% of all newborns. We study the mechanisms of the pathogenesis of congenital heart malformations to better understand their causes and therefore enable their primary prevention. Using chick and mouse embryos as models, we focus on the physiology of the developing heart and formation of its **CONDUCTION SYSTEM**, as proper heart function is crucial for embryonic/fetal survival and normal development.

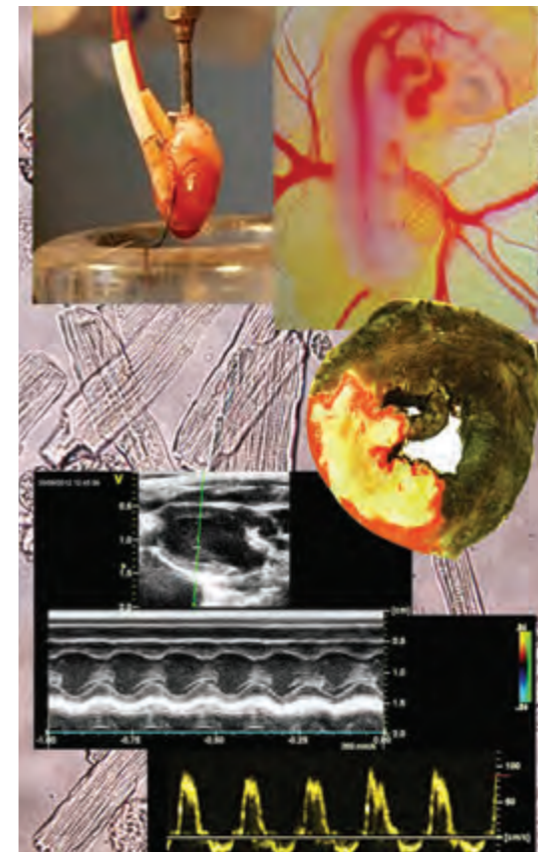

Main experimental models and techniques used in the Department of Developmental Cardiology to study protective mechanisms against cardiac ischemia/reperfusion injury and heart failure, and development of cardiac conduction system.

CURRENT PROJECTS

- The molecular mechanisms underlying the cardio-protective effects of chronic hypoxia and regular exercise on acute ischemia/reperfusion injury and postinfarction heart failure
- The influence of various types of systemic hypertension and dyslipidemia on cardiac ischemic tolerance and postinfarction remodeling
- Developmental aspects of cardiac ischemic tolerance
- The phylogenesis of the cardiac conduction system in vertebrates
- Nanostructured surfaces on implants for improved biological compatibility



SELECTED OUTPUTS

- Inflammatory cytokine TNF- α plays a key role in the induction of the ischemia-resistant cardiac phenotype of chronically hypoxic rats via its receptor TNFR2 and the NF- κ B-dependent activation of protective redox signaling with increased antioxidant defense (Chytilová et al. (2015) Acta Physiol 214, 97-108).
- Chronic inhibition of soluble epoxide hydrolase exhibits antihypertensive and cardioprotective actions in Ren-2 renin transgenic rats with angiotensin II-dependent hypertension (Neckář et al. (2012) Clin Sci 122, 513-525).
- Daily interruption of chronic continuous hypoxia with brief normoxic episodes blunts its cardioprotective effect by a mechanism which attenuates antioxidant defense, results in oxidative stress and interferes with the activation of mitochondrial BKCa channels (Neckář et al. (2013) Curr Pharmaceut Design 19, 6880-6889).
- Heart rate changes mediate the embryotoxic effect of antiarrhythmic drugs in the chick embryo (Kočkova et al. (2013) Am J Physiol Heart Circ Physiol 304, H895-H902).
- Effect of connexin40 deficiency on ventricular conduction system function during development (Šaňková et al. (2012) Cardiovasc Res 95, 469-479).

DEVELOPMENTAL EPILEPTOLOGY

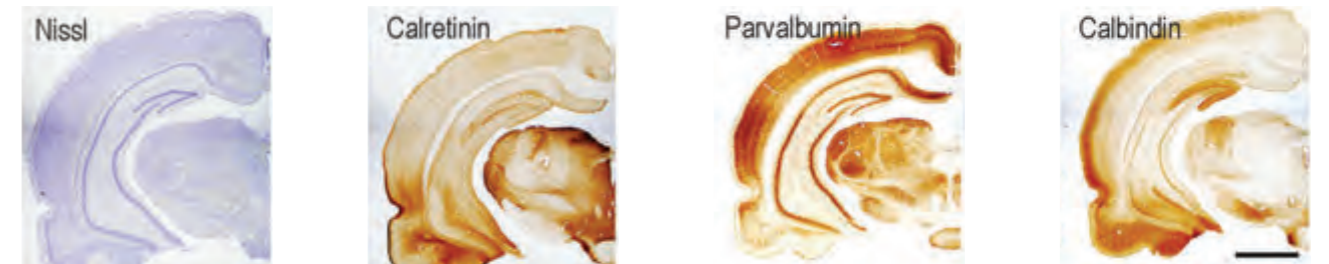

Representative low magnification photomicrographs illustrating the patterns of Nissl, calretinin, parvalbumin and calbindin staining in cerebral hemisphere of the rat brain.

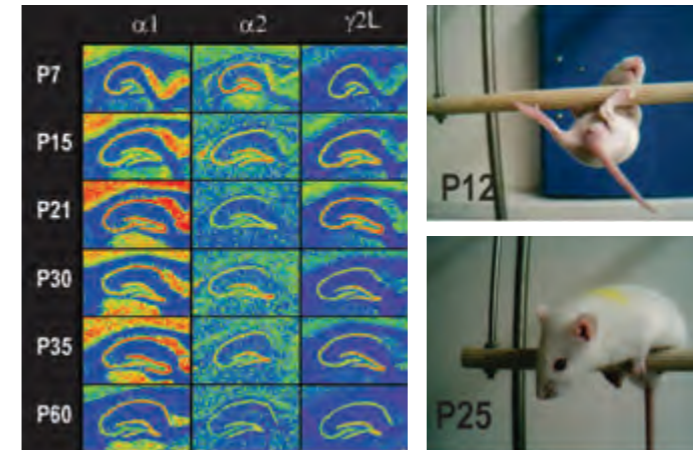

Distribution of $\alpha 1$, $\alpha 2$ and $\gamma 2L$ subunits of GABAA receptor in the hippocampus at different postnatal (P) days in the rat. Bar holding test in twelve (P12) and twenty five (P25) days old rats.

CURRENT PROJECTS

- Mechanisms of ictogenesis, epileptogenesis and epilepsy-related comorbidities in the mature and immature brain
- Development of new diagnostic techniques for epilepsy
- The long-term impact of early pharmacological intervention in neurotransmitter systems on brain development
- The role of oxidative stress in the pathogenesis of epilepsy and seizures during the development of the brain
- Developmental pharmacology of classical and potential anti-seizure drugs

head Doc. PharmDr. Hana Kubová, DrSc.
e-mail hana.kubova@fgu.cas.cz

researchers Přemysl Jiruška, Anna Mikulecká, Jakub Otáhal, Grygoriy Tsenov **emeritus** Jaroslava Folbergrová, Pavel Mareš
PhD students Lubica Demeterová, Petr Fábera, Jan Chvojka, David Kala, Jan Kudláček, Antonín Pošusta, Jan Svoboda, Pavel Vlk, Kateřina Vondráková
technical support Blanka Čejková, Eva Lažková, Irinka Necheva, Ivana Rabasová



The research at our department focuses on the pathophysiology of **EPILEPSY** and epileptic seizures in adulthood and particularly in **THE DEVELOPING BRAIN**. In all age groups, we study the mechanisms of **ICTOGENESIS**, **EPILEPTOGENESIS** and **EPILEPSY-RELATED COMORBIDITIES**. In our research we utilize modern electrophysiological, imaging, biochemical and pharmacological techniques. To elucidate the cellular and network mechanisms involved in epilepsy and to increase the translational potential of new observations, we make extensive use of various models of provoked seizures, chronic models of acquired epilepsy and also genetic models. In close collaboration with clinical epilepsy centers, we work to develop new diagnostic techniques for epilepsy. Beyond basic research, we work to a limited extent with the pharmaceutical industry to search for age-specific anti-seizure drugs and to ameliorate the potential adverse side effects of these drugs.



SELECTED OUTPUTS

- The first description of the age-specific, flexion seizures induced in immature rats NMDA. The model was validated as a model of human infantile spasms (Mareš et al. (1992) Dev Brain Res 65, 185-189).
- Characterization of status epilepticus-induced neuronal damage in the mediodorsal nucleus of the thalamus in 12-day-old rats (Kubová et al. (2001) J Neurosci 21, 3593-3599).
- This study explores the role of the altered neurogenesis in pathophysiology of epilepsy. It demonstrates that brief seizures are sufficient to promote increased hippocampal neurogenesis even in the absence of status epilepticus and severe cell loss. (Jiruška et al. (2013) Neurobiol Dis 54, 492-498).
- Activation of either the ET_A or the ET_B receptors is associated with seizure development after the intrahippocampal infusion of endothelin-1 in immature rats (Tsenov et al. (2015) Exp Neurol 265, 40-47).
- Status epilepticus-induced oxidative stress and mitochondrial dysfunction are age- and model- independent. This finding has relevance for a novel treatment of epilepsy in children (Folbergrová et al. (2016) Front Cell Neurosci 10, 1-13).

EPITHELIAL PHYSIOLOGY

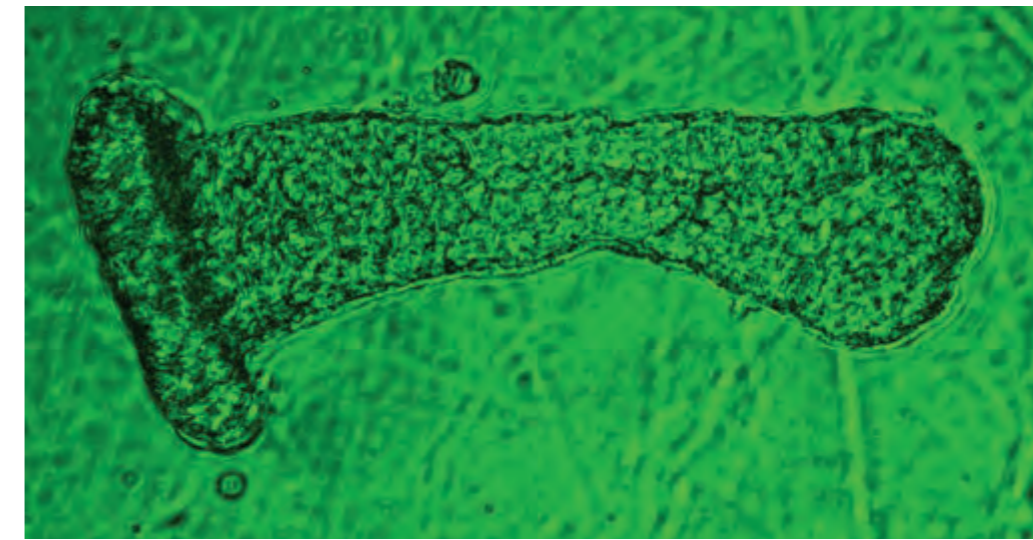

Intestinal crypt isolated from rat colon.

CURRENT PROJECTS

- Effect of gut microbiota on neuroendocrine regulatory pathways during stress
- Effect of inflammation on the local metabolism of glucocorticoids in neuroendocrine regulatory pathways and secondary lymphoid organs
- Role of the internal time-keeping system in the pathogenesis of colorectal cancer associated with inflammatory bowel disease



head Prof. RNDr. Jiří Pácha, DrSc.
e-mail jiri.pacha@fgu.cas.cz

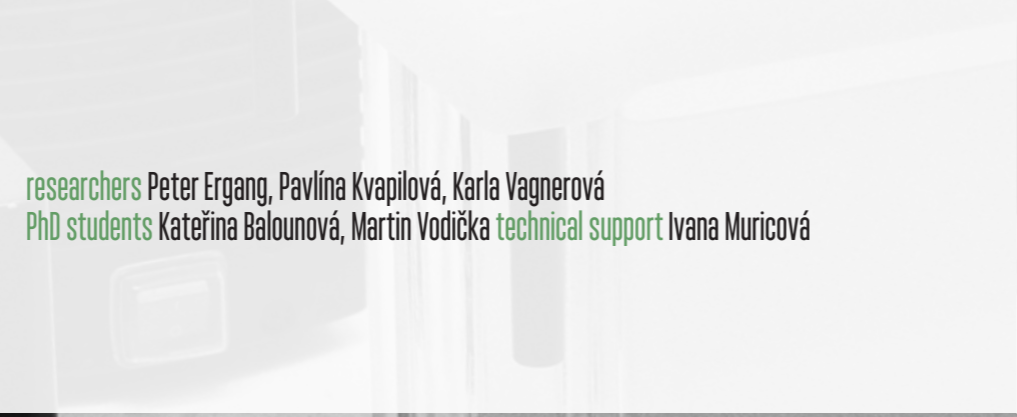

researchers Peter Ergang, Pavlína Kvapilová, Karla Vagnerová
PhD students Kateřina Balounová, Martin Vodička **technical support** Ivana Muricová



The department's research is focused on the **BIOLOGY, PHYSIOLOGY AND PATHOPHYSIOLOGY OF THE INTESTINE** and the cellular and molecular **MECHANISMS OF CORTICOSTEROID REGULATION**. To achieve these aims, our group utilizes a wide range of experimental approaches including biochemical analysis (i.e. determination of enzyme activities), genomic and proteomic techniques, microanatomy (laser microdissection) and electrophysiological techniques (voltage clamp). To elucidate the mechanisms operating under normal and pathological conditions, we use specific rat strains with weak and strong HPA axis activity (Fisher 344 and Lewis rats), germ-free animals and animal models of colitis, arthritis and colitis-associated colorectal cancer. Our group's research focuses on the elucidation of (1) the role of the local metabolism of glucocorticoids in gut physiology and pathophysiology, (2) the regulation of intestinal transport in healthy and diseased intestine and (3) the effect of stress on neuroendocrine regulatory pathways.

SELECTED OUTPUTS

- Ergang et al. Differential impact of stress on hypothalamic-pituitary-adrenal axis: gene expression changes in Lewis and Fisher rats. *Psychoneuroendocrinology* 53, 49-59 (2015).
- Vodička et al. Regulation of 11 β -hydroxysteroid dehydrogenase type 1 and 7 α -hydroxylase CYP7B1 during social stress. *PLoS One* 9, e89421 (2014).
- Moravec et al. Expression of 11 β -hydroxysteroid dehydrogenase type 2 is deregulated in colon carcinoma. *Histol Histopathol* 29, 489-496 (2014).
- Soták et al. An association between clock genes and clock-controlled cell cycle genes in murine colorectal tumors. *Int J Cancer* 132(5), 1032-1041 (2013).
- Ergang et al. Upregulation of 11 β -hydroxysteroid dehydrogenase 1 in lymphoid organs during inflammation in the rat. *J Steroid Biochem Mol Biol* 126, 19-25 (2011).
- Soták et al. Circadian regulation of electrolyte absorption in the rat colon. *Am J Physiol Gastrointest Liver Physiol* 301, G1066-1074 (2011).

EXPERIMENTAL HYPERTENSION



head RNDr. Ivana Vaněčková, DSc.
e-mail ivana.vaneckova@fgu.cas.cz

researchers Michal Behuliak, Milada Dobiášová, Silvie Hojná, Michaela Kadlecová, Hana Rauchová, Lenka Řezáčová, Josef Zicha
emeritus Jaroslav Kuneš **PhD students** Michal Bencze, Barbora Mikulášková, Anna Vavřínová **technical support** Alena Charvátová, Zdeňka Kopecká

The Department of **EXPERIMENTAL HYPERTENSION** was established in 1976 and currently studies the mechanisms of **BLOOD PRESSURE (BP)** regulation and **END-ORGAN DAMAGE** in **RATS** with different types of experimental hypertension, with special attention given to the **ONTOGENETIC FACTORS** involved in these processes. Our research is focused on i) elucidating the mechanisms by which endothelin and renin-angiotensin systems participate in **RENAL DAMAGE** (in cooperation with the Institute of Experimental Medicine in Prague); ii) comparing the role of **CALCIUM SENSITIZATION** (Rho kinase pathway) and **CALCIUM INFLUX** in the development of high BP and on the molecular biological analysis of alterations in these regulatory pathways; iii) studying the central mechanisms participating in **BLOOD PRESSURE REGULATION**; iv) the **BAROREFLEX CONTROL** of sympathetic tone under stress conditions, v) the role of **OXIDATIVE STRESS** in these processes and vi) the cardiovascular effects of new analogs of **NEUROPEPTIDES** regulating **FOOD INTAKE** in rats (in cooperation with the Institute of Organic Chemistry and Biochemistry CAS in Prague).

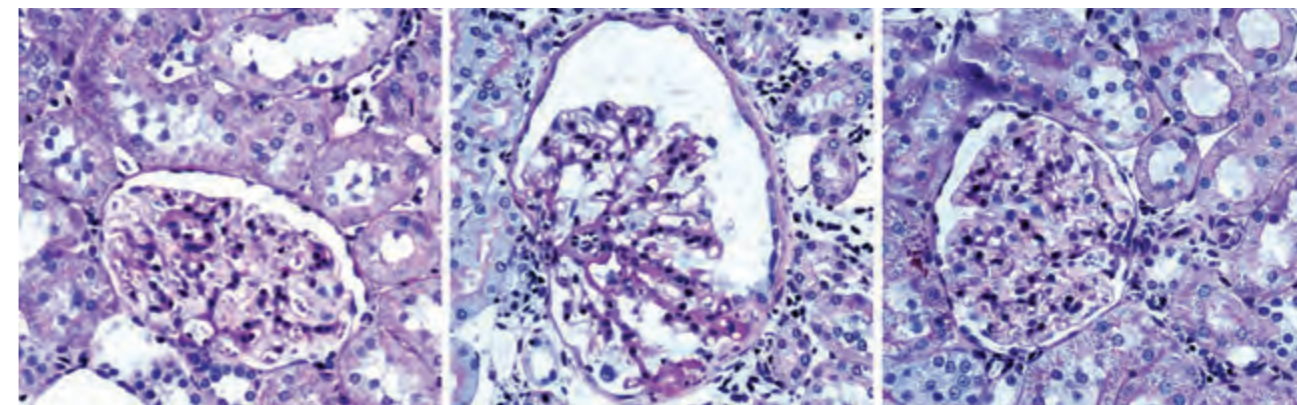

Renal glomeruli stained with hematoxylin-eosin in control HanSD animals (A), hypertensive Ren-2 transgenic rats (TGR) (B), and TGR rats treated with direct renin inhibitor aliskiren (C).

CURRENT PROJECTS

- Central and peripheral modulation of vascular tone and sodium excretion: the role of the brain and kidney in the pathophysiology of hypertension
- Stress-induced modulation of baroreflex sensitivity in spontaneously hypertensive rats: the role of renin-angiotensin system and glucocorticoids
- The Alpha2delta auxiliary subunit of voltage-dependent Ca²⁺ channels as a novel therapeutic target for the treatment of hypertension
- The possible role of stable analogs of prolactin-releasing peptide in the treatment of obesity and hypertension: studies in lean and obese rodents

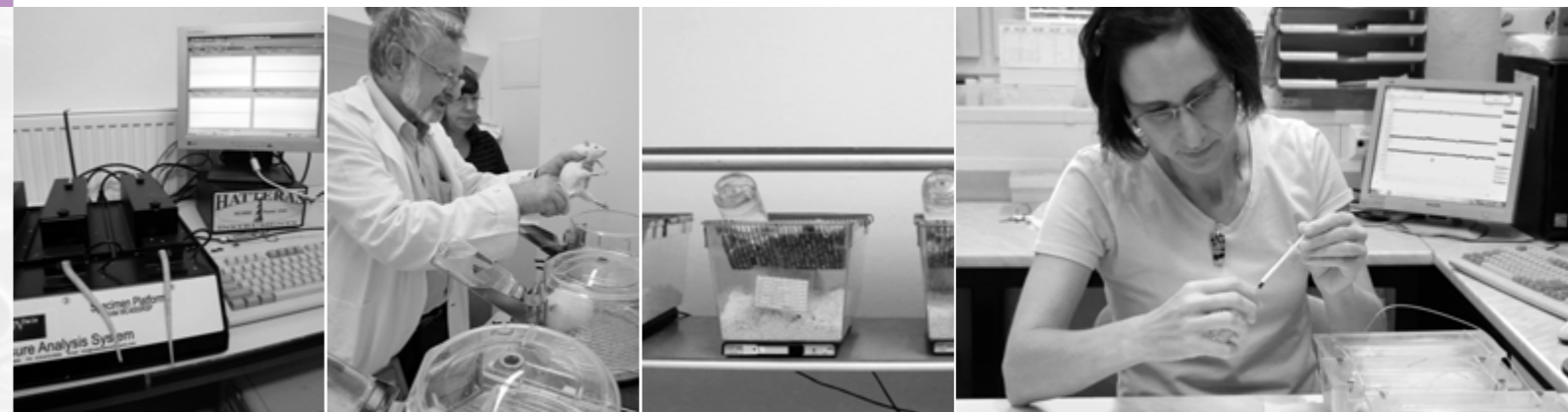

SELECTED OUTPUTS

- Behuliak et al. Ontogenetic changes in contribution of calcium sensitization and calcium entry to blood pressure maintenance of Wistar-Kyoto and spontaneously hypertensive rats. *J Hypertens*, 33(12), 2443-54 (2015).
- Kuneš et al.. Prolactin-releasing peptide: a new tool for obesity treatment. *J Endocrinol.*;230(2), R51-8 (2016).
- Rauchová et al. Inhibition of mitochondrial glycerol-3-phosphate dehydrogenase by α -tocopheryl succinate. *Int J Biochem Cell Biol.*;53, 409-13 (2014).
- Vaněčková et al. Endothelin A receptor blocker atrasentan lowers blood pressure by the reduction of nifedipine-sensitive calcium influx in Ren-2 transgenic rats fed a high-salt diet. *J Hypertens*, 33(1), 161-169 (2015).
- Zicha et al. Chronic endothelin A receptor blockade attenuates contribution of sympathetic nervous system to salt hypertension development in adult but not in young Dahl rats. *Acta Physiol (Oxf)*, 205(1), 124-132 (2012).

FUNCTIONAL MORPHOLOGY



head MUDr. Jiří Paleček, CSc.
e-mail jiri.palecek@fgu.cas.cz

researchers Petra Mrózková, Tomáš Soukup (+2017), Diana Špicarová, Gisela Zachařová
PhD students Pavel Adámek, Mário Heleš, Nataliia Kalynovská, Vladimír Nerandžič
technical support Anna Jokelová, Kateřina Kramerová, Martina Pytlová

The main research interest of the department is to study the **MECHANISMS OF PAIN** and to explore new possibilities for pain treatment, especially of chronic neuropathic states. Our experimental work is focused on the modulation of nociceptive information at the spinal cord level that is the first relay center between the periphery and the higher brain areas. **THE GOAL IS TO STUDY THESE MODULATORY MECHANISMS IN ORDER TO IMPROVE THERAPY FOR NEUROPATHIC, INFLAMMATORY AND CANCER-RELATED PAIN.** The focus is on the role of transient receptor potential vanilloid 1 (TRPV1) and other receptors, inflammatory cytokines and glial cells in this process. In our research, we use mainly electrophysiological, immunohistochemical and behavioral methods.

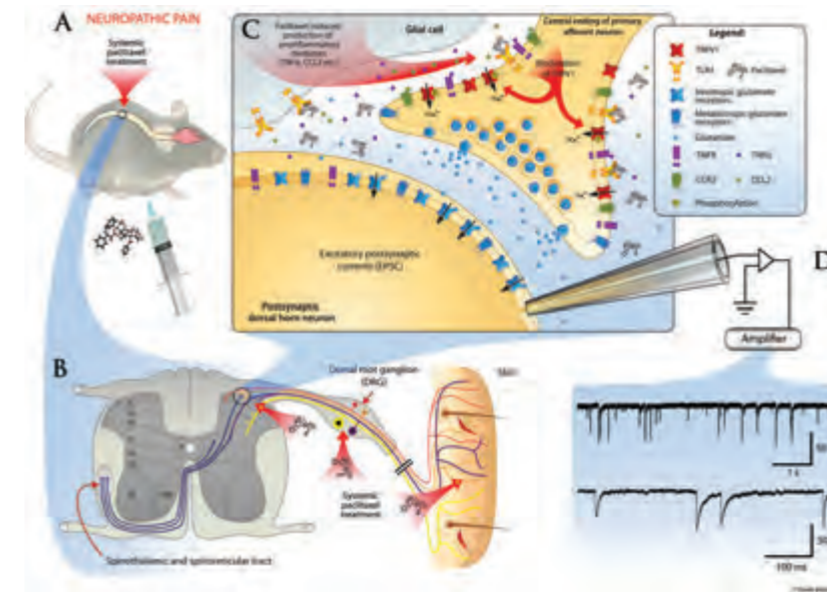

Schematic drawing of paclitaxel (PAC) effects at spinal cord level. (A) Low concentration of PAC penetrates through hematoencephalic-barrier. (B, C) In the spinal cord PAC may activate TLR4 receptors and modulate TRPV1 receptors function. (D) These changes are studied by whole-cell patch clamp recordings from superficial dorsal horn neurons.

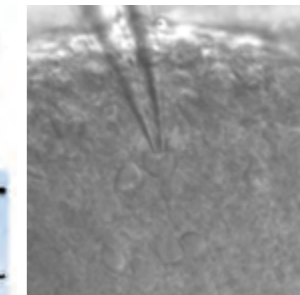

Recording of postsynaptic currents from superficial dorsal horn neuron in acute spinal cord slice with patch-clamp technique.

CURRENT PROJECTS

- Modulation of spinal cord dorsal horn synaptic transmission by endocannabinoids
- Functional interaction between TLR4 and TRPV1 receptors in neuropathic pain
- The role of PAR2 receptors in the modulation of nociceptive signalling
- The role of spinal TRPV1 receptors in TNF- α and CCL2-induced hyperalgesia
- The role of opioid and TRPV1 receptors interaction in spinal analgesia

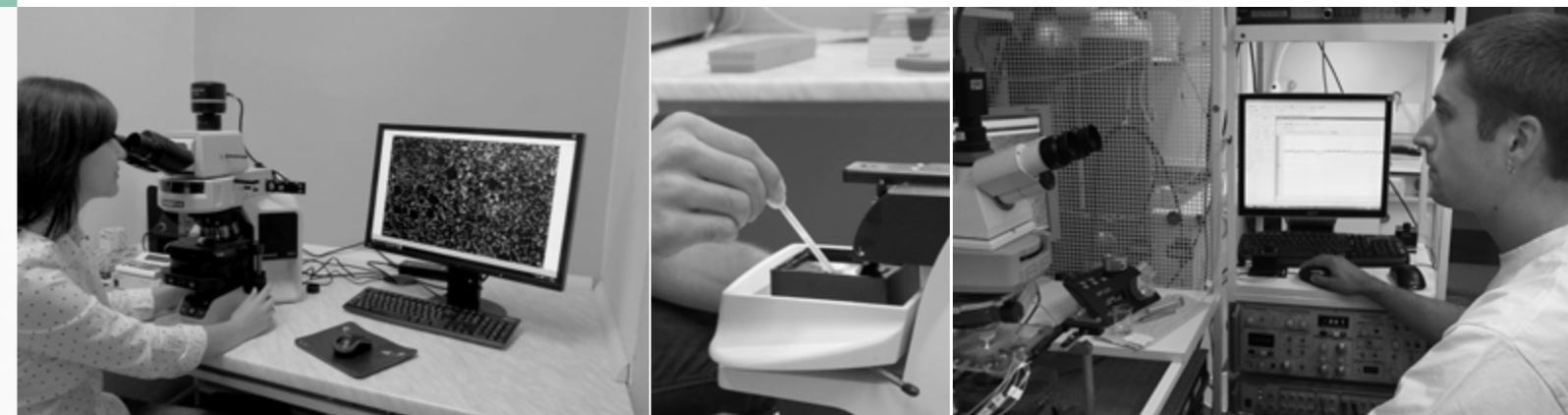

SELECTED OUTPUTS

- Peripheral inflammation alters N-arachidonoylphosphatidylethanolamine (20:4-NAPE) induced modulation of nociceptive spinal cord synaptic transmission. (Nerandzic et al. (2017) Br J Pharmacol. doi: 10.1111/bph.13849).
- Hypersensitivity induced by the activation of spinal cord PAR2 receptors is partially mediated by TRPV1 receptors (Mrozkova et al. (2016) PLoS One 11(10), e0163991).
- The cancer chemotherapeutic paclitaxel increases human and rodent sensory neuron responses to TRPV1 by activating TLR4 (Li et al. (2015) J Neurosci 35(39), 13487-13500).
- TRPV1 receptor inhibition decreases CCL2-induced hyperalgesia (Spicarova et al. (2014) Neuropharmacology 81, 75-84).
- TRPV1 antagonist attenuates postoperative hypersensitivity by central and peripheral mechanisms (Uchytlova et al. (2014) Mol Pain 10, 67).
- Modulation of spinal cord synaptic activity by tumor necrosis factor α in a model of peripheral neuropathy (Spicarova et al. (2011) J Neuroinflammation 8, 177).

GENETICS OF MODEL DISEASES

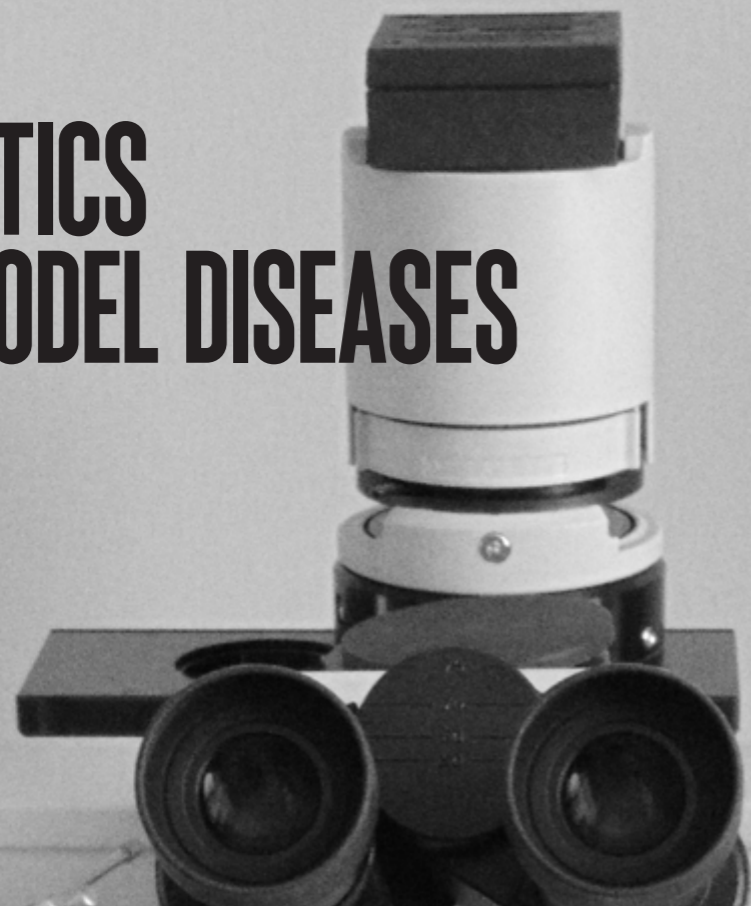

head Ing. Michal Pravenec, DrSc.
e-mail michal.pravenec@fgu.cas.cz

researchers Vladimír Landa, Petr Mlejnek, Jan Šilhavý, Miroslava Šimáková, Václav Zídek
PhD student Magdalena Melčová **technical support** Alena Musilová

METABOLIC SYNDROME is a cluster of several risk factors for type 2 diabetes and cardiovascular disease, including obesity, hypertension, insulin resistance, and dyslipidemia. Genome-wide association studies in humans identified only a minor proportion of the total heritability of such complex traits so far. Studies in **ANIMAL MODELS OF HUMAN COMPLEX DISEASES** can provide a useful alternative. Experiments with rat models can control for both genetic background and environmental effects as well as enable the **GENETIC MANIPULATION** of experimental animals. The **SPONTANEOUSLY HYPERTENSIVE RAT** (SHR) is the most widely used animal model of essential hypertension and associated metabolic disturbances typical of metabolic syndrome. Although it cannot be expected that the individual predisposing genes themselves might be conserved between rats and humans, it is likely that the networks and pathways of genes leading to disease susceptibility will be conserved across species.



Derivation of transgenic rats with a Sleeping Beauty transposon vector encoding the Venus fluorescent protein.

CURRENT PROJECTS

- Identification of genes that regulate hemodynamic and metabolic traits in the SHR
- Identification of new genes coding for mitochondrial proteins and their role in the pathogenesis of metabolic syndrome
- Derivation of new animal models using highly effective methods for transgenesis and gene targeting
- Analysis of molecular-based hemodynamic mechanisms of salt-dependent hypertension



SELECTED OUTPUTS

- Development of a model system for genetic analyses of cardiovascular and metabolic disturbances in spontaneously hypertensive rats (SHR), the BXH/HXB recombinant inbred strains derived from crosses of SHR with Brown Norway rats. Designation of new analytical approaches including the combination of gene expression profiles with linkage analyses to identify candidate genes for quantitative trait loci (QTL) (Hübner et al. (2005) Nat Genet 37, 243-253).
- Identification of the first blood pressure regulatory QTL at the molecular level in the SHR as a deletion variant of the Cd36 gene (Pravenec et al. (2008) Nat Genet 40, 952-954) as well as a number of other QTL associated with metabolic and cardiac traits (reviewed by Pravenec et al. (2014) Physiol Res 63, Suppl 1, S1-S8).
- A new hypothesis of molecular-based hemodynamic mechanisms of salt-dependent hypertension (Kurtz et al. (2015) Hypertension 65, 932-941).

MEMBRANE TRANSPORT

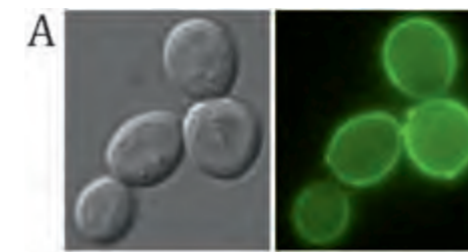

Na^+/H^+ antiporter tagged with GFP is localized in the plasma membrane (A). Mutations of aminoacid residues in the transmembrane part change its substrate specificity (B) as they modify the size of the hydrophobic filter in the cation pathway (C).

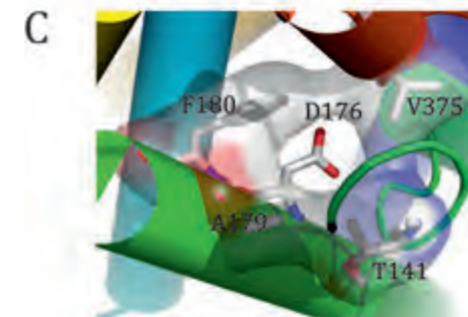
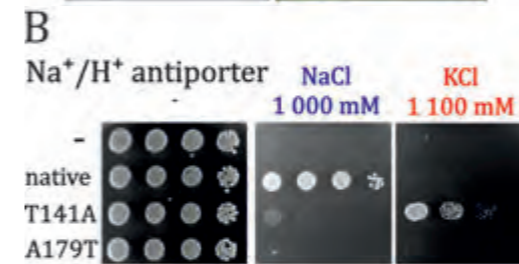

CURRENT PROJECTS

- Molecular characterization of cation/proton exchangers – relationship between their protein structure, substrate specificity and transport capacity
- Characterization of non-transporting proteins involved in the maintenance of cation and pH homeostasis via their interaction with transporters
- Yeast as a tool to study transport processes in animal and plant cells
- Transporters in pathogenic yeasts as potential antifungal drug targets
- Specific transporters of non-conventional yeast species and their application in biotechnology

head RNDr. Hana Sychrová, DrSc.
e-mail hana.sychrova@fgu.cas.cz

researchers Zuzana Antošová, Michala Dušková, Hana Elicharová, Marie Kodedová, Kristina Netíková, Klára Papoušková, Olga Zimmermannová **PhD student** Klára Herkommerová
technical support Radka Bardoňová, Pavla Herynková, Denisa Rácová



We study the proteins that transport compounds and signals across cell membranes. These proteins, called **TRANSPORTERS**, ensure the uptake of nutrients into cells, the efflux of waste compounds from cells and communication with the environment. We are interested not only in the molecular characterization of transporters in terms of their **STRUCTURE/FUNCTION, SUBSTRATE SPECIFICITY AND TRANSPORT MECHANISM**, but also in their biogenesis and degradation, posttranslational regulation and in their role in **EUKARYOTIC CELL PHYSIOLOGY**. We specialize in transporters related to **INTRACELLULAR pH AND POTASSIUM HOMEOSTASIS**, or involved in the **OSMOTOLERANCE** and **SALT TOLERANCE** of lower eukaryotes, as well as in transporters from higher eukaryotes related either to human diseases or to the effective production of crops.

SELECTED OUTPUTS

- The properties of more than 20 transporters participating in the regulation of cation homeostasis and intracellular pH were estimated, among them cation/proton exchangers and potassium channels of higher eukaryotes (e.g. Huang et al. (2010) BBA 1800, 1241-1247, Rosas-Santiago et al. (2015) J Exp Bot 66, 2733-2748).
- A 3D model of a yeast Na^+/H^+ antiporter with experimentally verified residues important for cation recognition and activity regulation was created (Kinclova-Zimmermannova et al. (2015) J Mol Biol 427, 1691-1694).
- A glycerol uptake system important for the osmotolerance of non-conventional yeast species was characterized (Duskova et al. (2015) Mol Microbiol 97, 541-559).
- Potassium importing and exporting systems in *Candida* sp. were described, together with their role in *Candida* cell virulence and pathogenicity (e.g. Llopis-Torregrosa et al. (2016) PLoS ONE DOI:10.1371/journal.pone.0153374, Elicharova et al. (2016) FEMS Yeast Res 16, DOI: 10.1093/femsyr/fow039).

MITOCHONDRIAL PHYSIOLOGY



head RNDr. Petr Ježek, DrSc.
e-mail petr.jezek@fgu.cas.cz

researchers Andrea Dlasková, Aleš Dvořák, Hana Engstová, Blanka Holendová, Martin Jabůrek, Jan Ježek, Lydie Plecítá-Hlavatá, Miloš Nekvasil, Katarína Smolková, Tomáš Špaček, Jitka Špačková, Jan Tauber **PhD students** Anežka Kahancová, Vojtěch Pavluch **technical support** Jitka Smiková, Ludmila Šimečková, Jana Vaicová

MITOCHONDRIA, being the main source of cellular energy, ATP, and an essential metabolic hub and source of redox signaling in physiological and pathophysiological processes, are studied in cell and GMO mice models, likewise the **PRODUCTION OF REACTIVE OXYGEN** species that essentially initiate redox signals, e.g. in **HYPOXIC ADAPTATION** or **INSULIN RELEASE STIMULATION**, but in excess negatively impact cell function. Prolonged **OXIDATIVE STRESS** leads to cell death, but chronic moderate oxidative stress accompanies **PATHOPHYSIOLOGICAL DISORDERS** including neurodegenerations, type 2 diabetes and pulmonary hypertension. Mitochondria possess their own DNA (mtDNA) organized with accessory proteins within nucleoids, the biology of which is studied by 3D superresolution microscopy. "Nanoscopy" is being developed to study mitochondrial **CRISTAE** morphology in relation to function. Finally, **MITOCHONDRIAL SIGNALING** in cancer cells and **CANCER-SPECIFIC METABOLISM** are studied as essential for future **ANTICANCER DRUG DEVELOPMENT**.

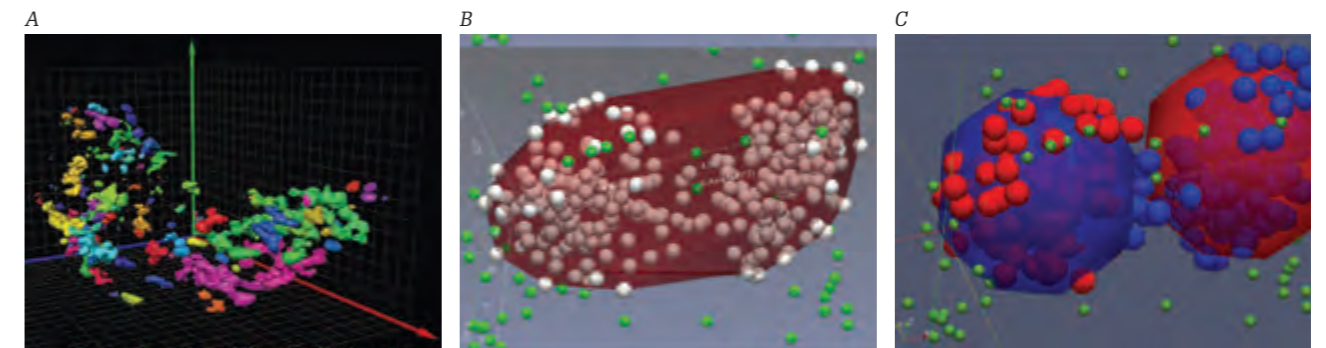

A) Fragmented mitochondrial network in pancreatic beta cell of diabetic Goto Kakizaki rat imaged by 4Pi microscopy B),C) Division of mitochondrial nucleoids imaged via antiDNA 3D immunocyto-chemistry by microscopic superresolution technique termed dSTORM.

CURRENT PROJECTS

- Reactive oxygen species (ROS) homeostasis, redox regulations, redox signaling, endogenous antioxidant mechanisms
- Nucleoids of mitochondrial DNA in relation to diabetes, nucleoid division and ultrastructure by 3D super-resolution microscopy
- Novel cancer-related metabolites, cancer-related mitochondrial metabolism, oxidative stress or hypoxia
- Mechanisms of insulin release in pancreatic beta-cells
- Cristae morphology in relation to metabolism by 3D super-resolution and electron microscopy



SELECTED OUTPUTS

- We studied mitochondrial phospholipase iPLA2 γ and revealed its direct stimulation by H₂O₂ activating the cleavage of fatty acids (FA) from phospholipids and initiating uncoupling mediated by uncoupling protein UCP2, which attenuates mitochondrial superoxide formation. This synergy provides cytoprotection to pancreatic β -cells and regulates (decreases) glucose-stimulated insulin secretion. Moreover, FA β -oxidation initiates the iPLA2 γ cleavage of mitochondrial FAs, which activate the GPR40 receptor, initiating insulin secretion by the so-called glycerolipid/fatty acid cycle (Ježek et al. (2015) Antioxid Red Sign 23, 958-972).
- Hypoxic cristae widening, partially controlled by HIF, was found to occur due to ~20% down-regulation of mitofilin, a component of MICOS complexes, joining the SAM complex of the outer membrane and due to de-dimerization of the ATP-synthase dimers located at sharp cristae edges. The reversal effect is currently being studied (Plecítá-Hlavatá et al. (2016) FASEB J 230, 1941-1957).

MOLECULAR NEUROBIOLOGY

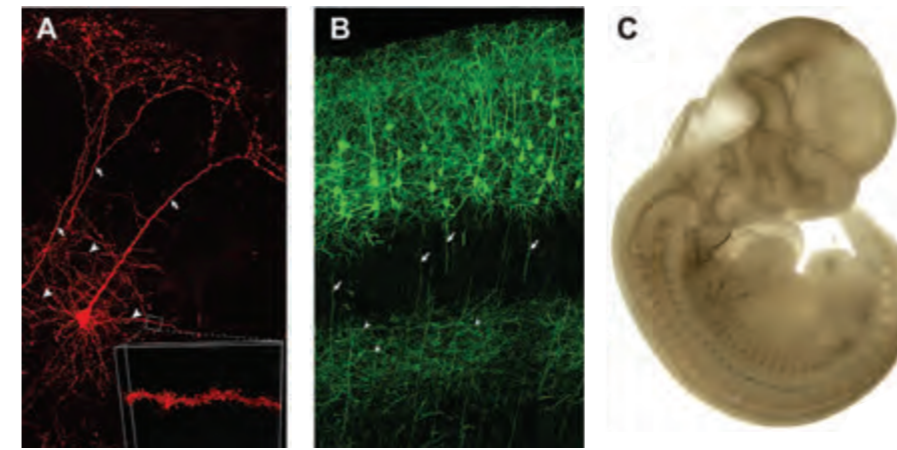

Analysis of axon/dendrite growth and guidance in vivo. (A) DiI labeling: apical (arrows) and basal (arrowheads) dendrites of pyramidal neurons, dendritic spines (inset), (B) In utero electroporation: axons (arrows) and their branches (arrowheads). (C) Whole mount immunostaining: peripheral nerve growth, E11.5 mouse embryos.

CURRENT PROJECTS

- Molecular mechanisms of axon growth and guidance – characterization of the role of Collapsin response mediator protein 2 in class 3 Semaphorin signaling and its regulation by phosphorylation and conformational changes
- Prolyl isomerases in neuron ageing and neurodegeneration – analysis of the role of conformational stress in aging and in the pathogenesis of Alzheimer's disease
- Conformational regulation in axon regeneration – study of the effect of isomerase Pin1 and in its substrates on adult central nervous system regeneration using gene-expressing/silencing lentiviral vectors in in vivo/in vitro models



head Mgr. Martin Balašík, Ph.D.
e-mail martin.balastik@fgu.cas.cz

PhD students Barbora Eliášová, Marie Kleisnerová,
Romana Weisssová, Jakub Žiak **technical support** Radka Bardoňová



During the development of the human brain, 86 billion neurons send their processes (axons, dendrites) to form over 10^{14} connections with an unprecedented precision – essential for the normal function of the nervous system. Defects in **AXON GUIDANCE** were linked to several **NEURODEVELOPMENTAL DISORDERS** such as autism or epilepsy. The department of Molecular Neurobiology, established in 2014, focuses on analysis of the molecular mechanisms controlling precise axon growth and guidance in the gradients of extracellular guidance cues – in particular conformational regulation by **PROLYL ISOMERASES**. In addition, we study the reactivation of the developmental **SIGNALING CASCADES** and regulatory mechanisms in adult neurons and their role in **NEURODEGENERATIVE DISORDERS**. For this purpose, we use a combination of in vitro and in vivo models (neuron cultures, transgenic/knockout mice) which we generate and analyze by combination of molecular biology, histology, microscopy and genetic techniques.

SELECTED OUTPUTS

- We found a new regulatory mechanism controlling axon growth and collapse through microtubule associated protein CRMP2A (collapsin response mediator protein 2A). A key part in this mechanism is played by prolyl isomerase Pin1 that changes conformation and stability of CRMP2A in distal axons promoting axon growth. (Balastik et al. (2015) Cell Reports 13, 812-828). As defects in both Pin1 and CRMP2 have been linked to pathogenesis of Alzheimer's disease (AD), our data show how deregulation of these proteins in aging neurons could affect microtubule metabolism and neuron function in AD.
- Using in vitro and in vivo models (mouse, zebrafish) we demonstrated that Pin1 regulates axon guidance in Semaphorin 3A gradients in the developing central nervous system (Balastik et al. (2015) Cell Reports 13, 812-828). Importantly, the level of Pin1 is high in developing neurons, but significantly drops in adult and aging neurons along with their growth and regenerative potential. Our latest data show that indeed Pin1 is essential for spinal cord regeneration and that its modulation, or modulation of its substrates promotes adult spinal cord regeneration in mouse model of spinal cord contusion.

NEUROCHEMISTRY



head Mgr. Jan Jakubík, Ph.D.
e-mail jan.jakubik@fgu.cas.cz

researchers Eva Dolejší, Vladimír Doležal, Helena Janíčková,
Eva Machová, Alena Randáková, Vladimír Rudajev
technical support Romana Ondřejová, Dana Ungerová

We study the physiology, biochemistry and pharmacology of **CHOLINERGIC NEURONS** at the molecular level. In our study we mainly employ cell lines but we also use animal models. Our research is focused mainly on the following topics: (i) Biochemical physiology and pharmacology of cholinergic neurons. Development and differentiation of cholinergic neurons. Synthesis, storage, and release of **ACETYLCHOLINE**. Presynaptic regulation of acetylcholine release. (ii) Cholinergic mechanisms in the pathogenesis of Alzheimer's disease. Effects of β -amyloid on acetylcholine metabolism and muscarinic transmission. (iii) Molecular pharmacology of muscarinic receptors. Allosteric modulation of receptor activation. Interaction of muscarinic receptors with G-proteins. Modelling of **MUSCARINIC RECEPTOR** signal transduction.

CURRENT PROJECTS

- The therapeutic and preventive impact of nutritional lipids on neuronal and cognitive performance: Based on previous observations that lipids change the risk for dementia, the project addresses the impact of nutritional lipids on neuronal and cognitive performance in ageing, Alzheimer's disease and vascular dementia.
- Neuropathological effects and neuronal specificity of apolipoprotein E4: Apolipoprotein E4 (apoE4) is the most prevalent genetic risk factor of Alzheimer's disease (AD). We investigate the cellular and molecular mechanisms underlying the neuronal and synaptic effects of apoE4 and their neuronal specificity.
- Molecular mechanisms of functional selectivity of atypical agonists at muscarinic receptors: Ectopic agonists are a new class of drugs with undefined mechanisms of action. We perform a detailed analysis of receptor activation with the aim of identifying the molecular mechanisms underlying functional selectivity.

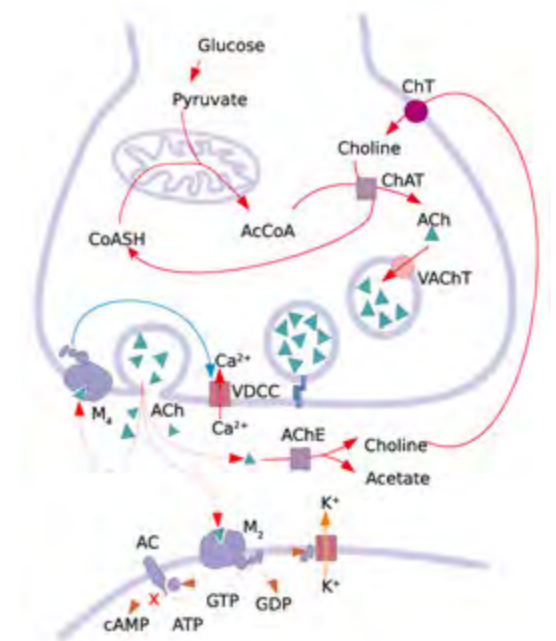

Upon Ca^{2+} entry via voltage-dependent calcium channels (VDCC) acetylcholine (ACh) is released to synapse. Postsynaptically ACh regulates cAMP synthesis and K^+ flow via M_2 receptors. Presynaptically it inhibits own release via M_4 receptors. AC – adenylyl cyclase, AcCoA – acetyl coenzyme A, ChAT – choline acetyl transferase, ChT – choline transporter, VAcHT – vesicular acetylcholine transporter.



SELECTED OUTPUTS

- Koivisto et al. Chronic pyruvate supplementation increases exploratory activity and brain energy reserves in young and middle-aged mice. *Front Aging Neurosci* 8, article 41 (2016).
- Dolejsi et al. Apolipoprotein E4 reduces evoked hippocampal acetylcholine release in adult mice. *J Neurochem* 136, 503-509 (2016).
- Randakova et al. Classical and atypical agonists activate M_1 muscarinic acetylcholine receptors through common mechanisms. *Pharmacol Res* 97, 27-39 (2015).
- Michal et al. Changes in membrane cholesterol differentially influence preferential and non-preferential signaling of the M_1 and M_3 muscarinic acetylcholine receptors. *Neurochem Res* 40, 2068-2070 (2015).
- Janickova et al. Lipid-based diets improve muscarinic neurotransmission in the hippocampus of transgenic APPswe/PS1dE9 mice. *Curr Alzheimer Res* 12, 923-931 (2015).
- Jakubik et al. Towards predictive docking at aminergic G-protein coupled receptors. *J Mol Model* 21, article 284 (2015).

NEUROHUMORAL REGULATIONS

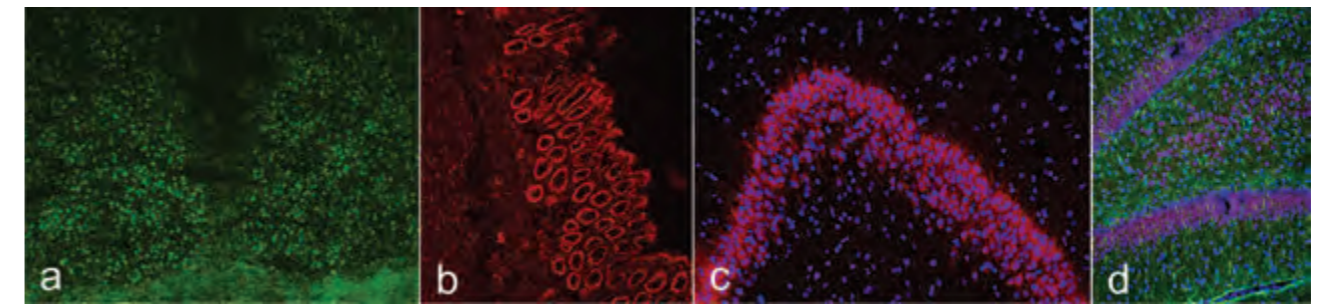

Representative images showing immunofluorescent staining of clock protein expressions in the SCN (a), colon (b) and hippocampus of rat (c) and mouse (d).

CURRENT PROJECTS

- The ontogenesis of the biological clock, investigating mechanisms of how the circadian clocks develop and how they are entrained
- Mechanisms of entrainment of the circadian clock, exploring how they are entrained with the external environment and also with signals within our body, using various in vivo and in vitro models
- The circadian system in patients with various disorders, studying the circadian system in patients suffering from disorders associated with disrupted sleep pattern to find connections between the functional state of the timing system and those disorders

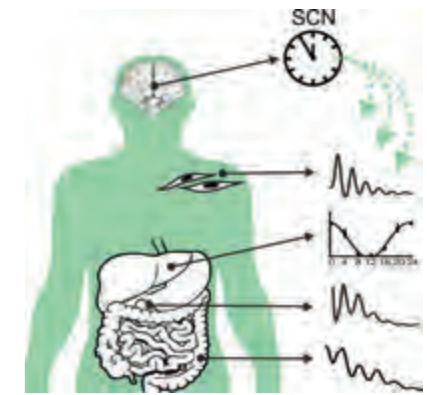

Mammalian circadian system is controlled by master oscillator, suprachiasmatic nuclei (SCN), located in the brain. The SCN synchronizes circadian clocks in peripheral tissues and organs to ensure their proper and timely function.

head PharmDr. Alena Sumová, DSc.
e-mail alena.sumova@fgu.cas.cz

researchers Pavel Houdek, Lenka Polidarová, Martin Sládek **emeritus** Helena Illnerová
PhD students Vendula Čečmanová, Petra Honzlová, Zuzana Novosadová, Lucie Olejníková, Karolína Šuchmanová **technical support** Lucie Heppnerová, Eva Suchanová



SELECTED OUTPUTS

- Nováková M. et al. The circadian system of patients with bipolar disorder differs in episodes of mania and depression. *Bipolar Disorders* 17(3), 303-314 (2015).
- Nováková M. et al. Alteration of the circadian clock in children with Smith-Magenis syndrome. *J Clin Endocrinol Metab* 97(2), E312-318 (2012).
- Sládek M et al. Insight into circadian clock within rat colonic epithelial cells. *Gastroenterology* 133, 1240-1249 (2007). This study described the circadian clock located in the epithelial cells in the colon and revealed its importance for colonic functions.
- Sládek et al. Insight into core clock mechanism of embryonic and early postnatal rat suprachiasmatic nucleus. *Proc Natl Acad Sci USA* 101, 6231-6236 (2004). In this study, we revealed how the central circadian clock develops during the fetal stage.
- Sumová et al. The rat suprachiasmatic nucleus is a clock for all seasons. *Proc Natl Acad Sci USA* 92, 7754-7758 (1995). This study provided the first evidence that the central circadian clock responds to changes in photoperiod and is thus involved in physiological adaptations to seasons.

Our focus of interest is the endogenous timing-keeping system, the **BIOLOGICAL (CIRCADIAN) CLOCKS**, of mammals, including humans. The system temporally regulates physiological processes in our body so that they take place at the proper time of day and are optimally synchronized relative to each other. A failure of this temporal regulation has a negative impact on **HUMAN HEALTH**. Using in vivo and in vitro models, we study the **MOLECULAR MECHANISMS** of how the circadian clocks are regulated, how these clocks control processes in our body and what the consequences of disrupting these regulation systems are for human health over our lifespan.

NEUROPHYSIOLOGY OF MEMORY

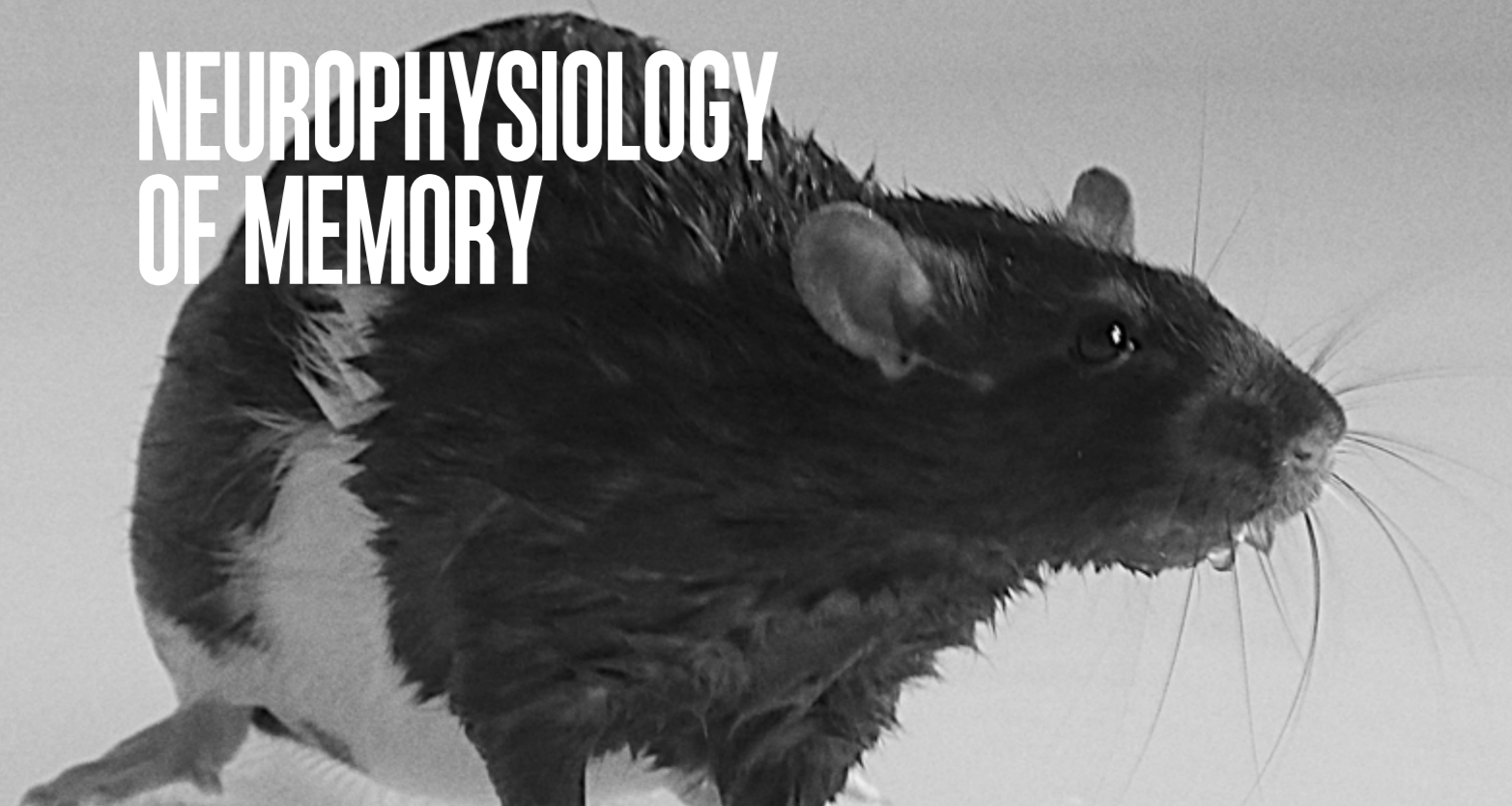

head Prof. RNDr. Aleš Stuchlík, Ph.D.
e-mail ales.stuchlik@fgu.cas.cz

researchers Iveta Fajnerová, David Levčík, Štěpán Kubík, Tereza Nekovářová, Tomáš Petrásek Jan Svoboda, Karel Valeš, Kamil Vlček **PhD students** Nikhil Ahuja, Hana Brožka, Helena Buchtová, Lukáš Hejtmánek, Kristína Holubová, Martina Janíková, Lenka Kletečková, Kristýna Malenínská, Adéla Piščíková, Dominika Radostová, Iveta Vojtěchová **technical support** Michaela Fialová, Jindřich Kalvoda, Vladimíra Marková, Barbara Stuchlíková, Antonín Zahálka

Our department has been involved in studies of **LEARNING, MEMORY** and **COGNITIVE FUNCTIONS** for a long time. For instance, **SPATIAL ORIENTATION** is now considered a type of so-called **DECLARATIVE MEMORY** (the ability to remember facts and events). This capability is predominantly affected in **ALZHEIMER'S DISEASE** and other dementias, **OBSESSIVE-COMPULSIVE DISORDER** or **SCHIZOPHRENIA**. These are conditions for which we do not know the details of their physiology, so we actually only treat symptoms but not causes. Using **NEUROANATOMICAL, NEUROPHARMACOLOGICAL, CELLULAR, MOLECULAR,** and **BEHAVIORAL APPROACHES** we investigate **BRAIN FUNCTION** in relation to **BEHAVIOR**, both in healthy and diseased brains. In an intense collaboration, we are also working on the development of novel **THERAPEUTICS** focused on **BRAIN DISEASES**.



A genetically modified rat lacking protein Nogo-A, which inhibits the growth of nerve fibers. The model has been created and tested in cooperation between our laboratory, CIMH Mannheim and ETH Zurich.

CURRENT PROJECTS

- Integration of multidisciplinary approaches in the study of cognitive functions: our focus is to integrate molecular, cellular and systems levels in understanding memory, behavioral flexibility, working memory, recognition of position and other cognitive domains
- Animal models of brain disorders: our projects are focused on behavioral pharmacology in the field of animal models of brain disorders and associated cognitive deficits
- Study of cognitive functions in humans: in this project we study spatial orientation, strategies used during navigation and spatial representations in the human mind



SELECTED OUTPUTS

- Kubík et al. Behavioral evidence that segregation and representation are dissociable hippocampal functions. *J Neurosci* 25(40), 9205-9212 (2005) - we have shown that the hippocampus performs two distinct functions, representation of spatial stimuli (memory) and their segregation into meaningful subsets (coordination).
- Petrásek et al. A rat model of Alzheimer's disease based on Abeta42 and pro-oxidative substances exhibits cognitive deficit and alterations in glutamatergic and cholinergic neurotransmitter systems. *Front Aging Neurosci* 8, 83 (2016) - we found that rats injected with amyloid-beta and pro-oxidative chemicals into the brain suffer from symptoms similar to AD - they have trouble finding their way in complex environments and remembering new information.
- Hort et al. Spatial navigation deficit in amnesic mild cognitive impairment. *Proc Natl Acad Sci USA* 104(10), 4042-4047 (2007) - our results suggest that a real navigation test could be important for predicting future AD development.
- Telensky et al. Functional inactivation of the rat hippocampus disrupts avoidance of a moving object. *Proc Natl Acad Sci USA* 108(13), 5414-5418 (2005) - we found that rats with the hippocampus temporarily blocked with tetrodotoxin are capable of avoiding a stationary robot, but not a randomly moving robot.

STRUCTURAL BIOLOGY OF SIGNALING PROTEINS

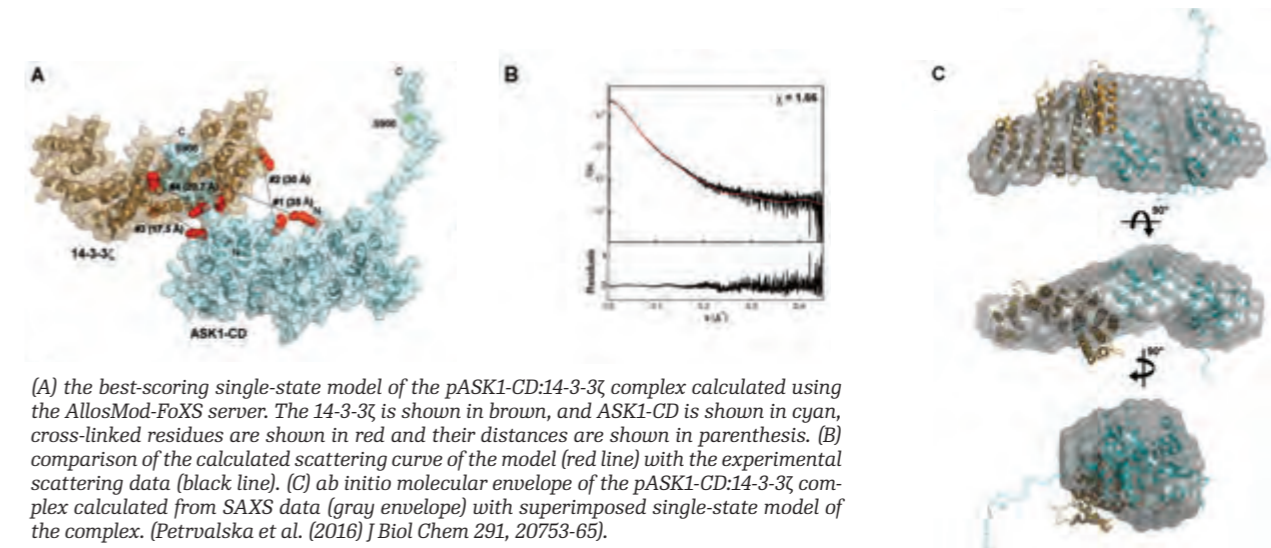

(A) the best-scoring single-state model of the pASK1-CD:14-3-3 ζ complex calculated using the AllosMod-FoXS server. The 14-3-3 ζ is shown in brown, and ASK1-CD is shown in cyan, cross-linked residues are shown in red and their distances are shown in parenthesis. (B) comparison of the calculated scattering curve of the model (red line) with the experimental scattering data (black line). (C) ab initio molecular envelope of the pASK1-CD:14-3-3 ζ complex calculated from SAXS data (gray envelope) with superimposed single-state model of the complex. (Petruvalska et al. (2016) J Biol Chem 291, 20753-65).

CURRENT PROJECTS

- Structural biology of 14-3-3 proteins and their complexes
- Mechanism of regulation of protein kinases CaMKK1, CaMKK2 and ASK1
- Study of the inhibition of protease caspase-2 in a 14-3-3 protein dependent manner
- Study of DNA-binding domain of transcription factor FOXO4
- Structural basis of the 14-3-3 protein-dependent activation of yeast neutral trehalase Nth1



head RNDr. Veronika Obšilová, Ph.D.
e-mail veronika.obsilova@fgu.cas.cz

researchers Miroslava Alblová, Matěj Horváth, Tomáš Obšil **PhD students** Dana Kalábová, Salome Kylarová, Olívia Petruvalská, Katarína Pšenáková, Domenico Lentini Santo, Aneta Šmídová **technical support** Markéta Kolcunová, Linda Malá



Our group is focused on **STRUCTURAL BIOLOGY** (the relationship between the structure and function of certain groups of proteins), in particular we are interested in **14-3-3 PROTEINS** and their **COMPLEXES** with proteins involved in **APOPTOSIS, CANCER** and **CALCIUM-TRIGGERED SIGNALING PATHWAYS**. 14-3-3 proteins specifically bind to phosphoserine (or phosphothreonine)-containing motifs in a sequence-specific manner. Mechanistically, 14-3-3 proteins act as **ALLOSTERIC REGULATORS** and/or molecular scaffolds that constrain the conformation of the binding partner. Nonetheless, the underlying molecular mechanisms are only partially identified, mainly due to the **LACK OF STRUCTURAL DATA**. The methods we are currently using include recombinant protein expression, biophysical characterization, the study of intermolecular interactions, protein structure and interaction surfaces. All these methods enable us to better understand how the activity and function of protein-protein complexes are regulated.

SELECTED OUTPUTS

- Mechanism of regulation of protein kinase activity of ASK1. We characterized the structural basis of the interaction of ASK1 kinase with its two natural inhibitors redox protein thioredoxin and 14-3-3 protein (Kosek et al. (2014) J Biol Chem 289, 24463-74; Petruvalska et al. (2016) J Biol Chem 291, 20753-20765).
- Yeast 14-3-3 proteins and neutral trehalase Nth1. We identified key phosphorylation sites responsible for the activation of the enzyme Nth1 by the 14-3-3 protein (Veisova et al. (2012) Biochem J 443, 663-670) and solved its low-resolution structure (SAXS), showing that 14-3-3 protein binding induces a significant structural rearrangement of the whole Nth1 molecule, especially in the calcium binding domain, which is crucial for the activation process (Kopecka et al. (2014) J Biol Chem 289, 13948-13961).
- A study of regulatory proteins participating in G-protein signaling. We solved the crystal structure of the RGS domain of RGS3 with a resolution of 2.3 Å. (Rezabkova et al. (2010) J Struct Biol 170, 451-461), determined the low-resolution solution structure of the 14-3-3 ζ :RGS3 complex (Rezabkova et al. (2011) J Biol Chem 286, 43527-43536) and the structure of phosducin (Kacirova et al. (2015) J Biol Chem 290, 16246-16260).

BIOCEV

EUROPEAN SCIENTIFIC CENTRE OF EXCELLENCE
IN BIOTECHNOLOGY AND BIOMEDICINE

BIOCEV focuses on detailed study of cellular mechanisms at the molecular level, research and development of novel therapeutic strategies, early diagnostics, biologically active agents including chemotherapeutics, protein engineering and other innovative technologies. **BIOCEV** is a joint project of six institutes of CAS (Institute of Biotechnology, Institute of Molecular Genetics, IPHYS, Institute of Microbiology, Institute of Experimental Medicine, Institute of Macromolecular Chemistry) and two faculties of Charles University (Faculty of Science and 1st Faculty of Medicine). Seven departments of IPHYS participate in the **BIOCEV** project.

The scientific scope of **BIOCEV** has been divided into five research programs, each of them dealing with a number of separate research projects (particular IPHYS projects in each programme are listed below). The programs and projects have been designed to form a mutually integrated system of synergistic links inside **BIOCEV**:

1. Functional genomics

2. Cellular biology and virology:

- Mitochondrial structure and gene expression
(Petr Ježek)
- Transporters of potassium in regulation of the cell cycle, pH and response to the stress of lower eukaryotes
(Hana Sychrová)
- Structure and function of membrane receptors
(Ladislav Vyklický, Jiří Paleček, Hana Zemková)

3. Structural biology and protein engineering:

Structural biology of signalling proteins *(Veronika Obšilová)*

4. Biomaterials and tissue engineering:

Bioartificial structures for replacement and regeneration of damaged tissues *(Lucie Bačáková)*

5. Development of diagnostic and therapeutic procedures

The implementation of complex projects requires a high-quality methodological basis concentrated in the core facilities. All are open to external users to provide them with the following research services:

- Czech Centre for Phenogenomics
- Imaging Methods
- Centre of Molecular Structure
- Gene Core - Quantitative and Digital PCR
- OMICS - Proteomics and Genomics
- Cryobank

CONTACT

BIOCEV

Průmyslová 595, 252 50 Vestec, Czech Republic
tel: +420 325 873 140, e-mail: biocev@biocev.eu
www.biocev.eu



SERVICE DEPARTMENTS

- Biological controls (60)
- Animal facility (61)
- Radiometry (62)
- Economic department (63)
- Information technology department (63)
- Property and facility department (64)
- Library (64)
- Director's office (65)



head RNDr. Světlana Žufanová
e-mail svetlana.zufanova@fgu.cas.cz

BIOLOGICAL CONTROLS

team members Jaroslav Kalivoda, Zdeňka Kotková, Jiří Marhan, Lenka Marhanová

We provide comprehensive pharmaceutical services in accordance with the principles of **Good Manufacturing Practice** (QC; our Quality control laboratory) and of **Good Laboratory Practice** (GLP; our Test Facility). We offer the performance of various biological and safety studies to our academic and business partners so as to fulfil their research and development goals, including studies under GMP/GLP regulations and in accordance with the OECD methods. We are an essential part of the newly established **Center for Preclinical Testing (CPT)** within CAS (www.prekliniky.cz). Our vision is to enable better prospects for the commercialization of potentially therapeutically effective medicinal products to both institutes within CAS and to other customers from the academic and commercial sector.

SERVICES

Scope of our services:

- Preclinical toxicity testing on commercially manufactured drugs as well as new chemical entities, QC of biologicals
- General safety studies on small laboratory animals (mice, rats, guinea pigs, rabbits)
- Customized safety studies on rodents, non-GLP and GLP studies
- Quality control of medicinal products for human use
- Pharmacological tests (determination of the efficacy of immunomodulators)
- Toxicological tests (tests on specific and nonspecific harmfulness)
- Pharmacopoeial tests (determination of evidence of extraneous agents in viral vaccines and human cell substrate for the manufacture of human vaccines)
- Testing of vaccines and allergens (QC methods for determining efficacy and safety)

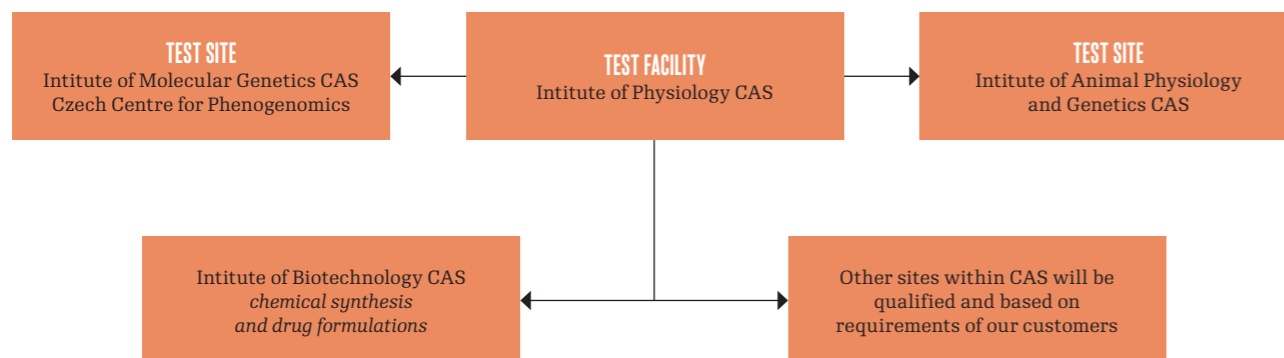

ANIMAL FACILITY

team members Josef Lachout, Jana Bártů **care-workers of laboratory animals** Michaela Apltauerová, Barbora Bejšáková, Monika Böhmová, Anna Hájková, Nikola Chmátalová, Evelina Lavičková, Jana Lejčková, Kateřina Pavelková, Jana Perná, Hana Ptáčková, Jaroslava Quiquerez, Lucie Rosová, Jaroslava Šmejkalová, Hana Thierlová, Andrea Vališová, Miluše Vantuchová **technicians** Alena Fialová, Monika Humenná, Jan Krámer, Andrea Perglerová, Lenka Vondrová



head MVDr. Kristýna Bílková
e-mail kristyna.bilkova@fgu.cas.cz

The department provides the production of various **laboratory rats and mice strains** and all necessary animal housing facilities under continuous veterinary control. The department also ensures rat, mouse and rabbit housing during the experiment and provides all the necessary related services. All procedures correspond to the requirements of the **law for protection** of animals against cruelty and the Decree about the protection of experimental animals.

The **spontaneously hypertensive rat (SHR)** is the most widely used animal **model of human essential hypertension and left ventricular hypertrophy**, and under special environmental conditions (for instance, when fed a high fructose or folate-deficient diet) also develops disturbances in lipid and glucose metabolism that are typical for metabolic syndrome. Similar to humans, these hemodynamic and metabolic disturbances in SHRs are also determined multifactorially. To identify the genetic determinants of such complex traits, we use a combination of linkage and correlation analyses with intermediary phenotypes in the BXH/HXB recombinant inbred strains and follow-up in vivo functional testing in SHR congenic and SHR transgenic or knockout lines. All these strains were derived at IPHYS from SHR progenitors.



Spontaneously hypertensive rat (SHR)

The **C57BL/6 inbred strain of mice** with its numerous substrains is frequently used to study the **pathophysiology of obesity and associated metabolic disorders**. When challenged with a high-fat diet, mice with this genetic background will develop various degrees of obesity, insulin resistance and other disorders of glucose and lipid metabolism, which are also frequently encountered in obese human subjects and referred to as metabolic syndrome. Further, by studying the interactions between the C57BL/6 genetic background and deleterious environmental factors such as high-fat, high-energy foods it is possible to identify genetic as well as metabolic signatures or biomarkers that are characteristic of the susceptibility or resistance to obesity and its metabolic sequelae.

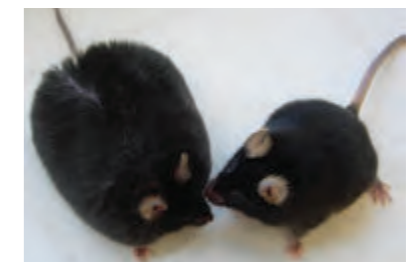

Animal model of obesity



head Roman Liška
e-mail roman.liska@fgu.cas.cz

RADIOMETRY

team members Karla Bohunová, Stanislav Pavelka

The Department of Radiometry provides services concerning all types of work with radioactive materials. In addition, with Computerized Tomography (CT) and Positron Emission Tomography (PET), we can also provide in vivo anatomical and molecular imaging of small laboratory animals (mice and rats) for quantitative 3D tomographic imaging of biodistributed radiotracers, bones, and different soft tissues, using the newly installed μ CT/PET apparatus Albira.

Radioactivity measurements of all kinds of radionuclides in different samples are carried out for research workers of other departments of IPHYS as well as for other Institutes of the Academy of Sciences in the areas of Krč and Vestec (BIOCEV). We dispose of radioactive waste produced in more than a hundred radioisotopic laboratories of these Institutes. We also provide advice and services in the field of manipulation with radioactive materials, ordering and purchasing radioactive preparations, etc. We are also involved in the research project „Multidisciplinary analysis of the combined effect of thyroid hormones and n-3 polyunsaturated fatty acids in rats“ within the framework of the bilateral project SAV-15-03.



The μ CT/PET scanner for small animals (Albira, Bruker). This instrument enables the preclinical morphological and functional imaging of small laboratory animals such as mice or rats with high spatial resolution.

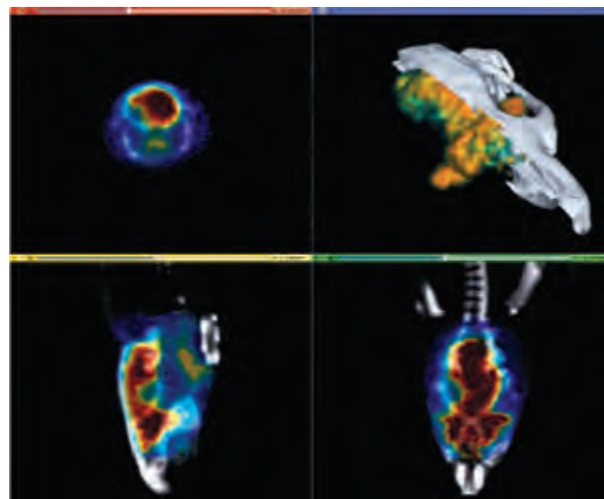

Positron emission tomography utilizes a small amount of radioactively-labeled tracer to visualize its accumulation in the organism. ^{18}F -deoxyglucose accumulates in metabolically active tissues. The figure shows a massive cerebral infarct (stroke) one day after the infarction.

ECONOMIC DEPARTMENT

team members Gabriela Bartejšová, Lucie Čiperová, Monika Dolanská, Lucie Firerová, Michaela Glaserová, Eva Hamalčíková, Kristýna Kněžů, Kamila Kohoutová, Jaroslava Králová, Viktor Kratochvíl, Monika Kulhánková, Martina Kupcová, Tereza Mádle, Lenka Nejedlá, Irena Pecháčková, Aneta Rolníková, Eva Syrová, Běla Tobolová, Lada Trčková, Gabriela Trmalová

Economic department ensures human resources, payroll and financial accounting, supply and stocks, agenda of grants and operating programs.



head Kateřina Uhrová
e-mail katerina.uhrova@fgu.cas.cz

INFORMATION TECHNOLOGY DEPARTMENT

team members Tomáš Fišera, Martin Kantor, Ondřej Švanda, Jiří Vilím

Information technology department serves the whole campus with all services in the field of computer technology and traffic data network. It helps with the purchase, operation and maintenance of hardware, data maintenance and software upgrades.



head Václav Pauločik
e-mail vaclav.paulocik@fgu.cas.cz



head Pavlína Hájková
e-mail pavlina.hajkova@fgu.cas.cz

PROPERTY AND FACILITY DEPARTMENT

team members Irena Čechová, Ladislav Krámer, Vladimír Křehlík, Stanislav Pečený, Jana Pechová, Iveta Prošková, Helena Reimerová, Ivan Slunéčko, Ingrid Techlovská, Vladimíra Trůková, Josef Uher

Property and facility department ensures all services related to the building maintenance and necessary health and safety rules. It also runs hostel rooms for IPHYS guests.

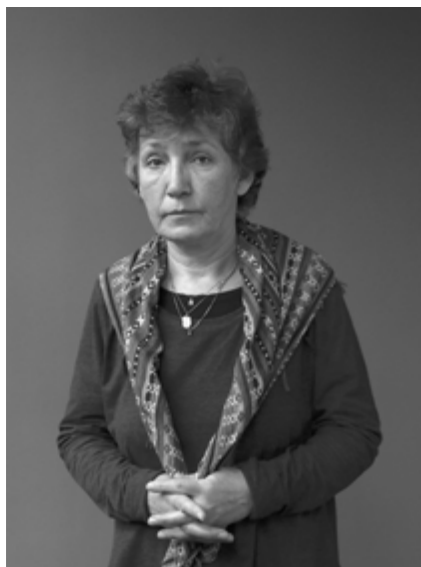

head RNDr. Zuzana Lisková
e-mail zuzana.liskova@fgu.cas.cz

LIBRARY

team members Jana Hružová, Blanka Liberová, Helena Sedláková, Lucie Trajhanová

The **library** provides access to both traditional paper-based and electronic resources for the whole campus. It ensures an information service based on the latest information technologies, access to printed sources and to specialised databases, on-line journals and information access, interlibrary and international interlibrary loan services. The supply of approximately 80,000 books and journals ranks the library as one of the largest libraries of the scientific institutes of the CAS.

DIRECTOR'S OFFICE

assistant Michaela Jirečková (right)
PR specialist Diana Moosová
project manager Josef Prchal



web www.fgu.cas.cz
e-mail fgu@fgu.cas.cz

Secretariat of the director provides administrative and organizational work connected with securing of Institute's activities. It organizes the events for the public and also the professional lectures. It ensures the popularization of the Institute to the media and public.

PHYSIOLOGICAL RESEARCH JOURNAL

editor in chief RNDr. Jaroslav Kuneš, DrSc. (right)
managing editor MUDr. Josef Zicha, DrSc.
team members Edita Balladová, Hynek Moravec, Michal Růžička, Zdeňka Stádníková, Libor Škárka



web www.biomed.cas.cz/physiolres
e-mail physres@biomed.cas.cz

Physiological Research is a scientific journal of IPHYS published bimonthly, containing articles on normal and pathological physiology, biochemistry, biophysics, pharmacology, and immunology. It was founded as Physiologia Bohemoslovaca in 1952. Since 1991, it has been published under the title Physiological Research. Its current impact factor is 1.46.

CZECH-BIOIMAGING

IPHYS PARTICIPATES IN THE PROJECT OF NATIONAL INFRASTRUCTURE FOR BIOLOGICAL AND MEDICAL IMAGING—CZECH-BIOIMAGING (MŠMT—LM 2015062).

It consists of nine partner institutions of nine leading research infrastructures for experimental development and innovations from the Czech Republic for the years 2016–2022. The purpose of Czech-BioImaging is to combine the unique technological equipment for biomedical imaging accessible in the Czech Republic and to coordinate open access to education in this area of expertise to the Czech and foreign research community.

SCIENTIFIC MANAGER OF THE PROJECT AT IPHYS:

RNDr. Lucie Kubínová, CSc. (Biomathematics)

- At IPHYS, nine instruments are available, especially confocal and multiphoton microscopic systems and optical projection tomography.
- Training programs, workshops and consultations in advanced fluorescence microscopic techniques, image analysis and processing are provided.
- Options to effectively share high quality technologies among partner institutions.
- Follow-up OP VVV infrastructure project: Modernization and support of research activities of the national infrastructure for biological and medical imaging Czech-BioImaging.

IPHYS is also a member of European Research Infrastructure for Imaging Technologies in Biological and Biomedical Sciences, which is interlinked with the project Czech-BioImaging. Its goal is to attract new foreign users with interesting research projects and new options of cooperation in methodological research with top research facilities.

More information:

www.czech-bioimaging.cz
www.fgu.cas.cz/czech-bioimaging
www.eurobioimaging.eu



SHARED EQUIPMENT

UNIQUE EQUIPMENT AVAILABLE AT IPHYS ENABLES COMPLEX PHENOTYPE ANALYSIS OF WHOLE ANIMALS AS WELL AS STUDIES AT THE MOLECULAR LEVEL.



FROM BEHAVIOUR TO BODY COMPOSITION

Phenoworld

Complex phenotypization and analysis of behaviour



Indirect calorimetry for small animals

Energy metabolism



µPET/CT Albira for small animals

Energy metabolism



FROM ORGANS TO MOLECULES



Echocardiography
Non-invasive assessment of heart geometry and function



Spectral confocal & multiphoton Leica systems



Seahorse XF24 Flux analyzer
Oxygen consumption in cell cultures



LC-MS metabolomics
Complex analysis of metabolites and signaling molecules

GRANT PROJECTS 2013–2017

IPHYS IS SUCCESSFUL IN ATTRACTING RESEARCH FUNDING AT BOTH THE NATIONAL AND INTERNATIONAL LEVEL.

PART OF THE OVERALL INSTITUTION BUDGET COVERED BY GRANTS

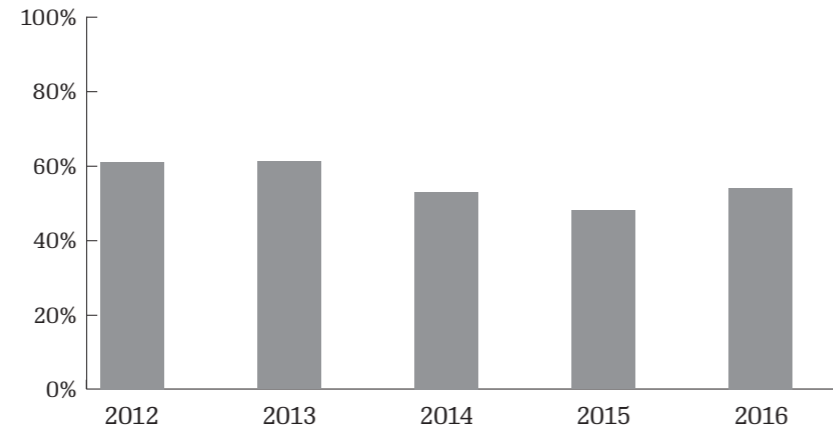

SUCCESS RATES FOR GRANT FUNDING BY MAJOR DOMESTIC AGENCIES
(N.A. = not announced)

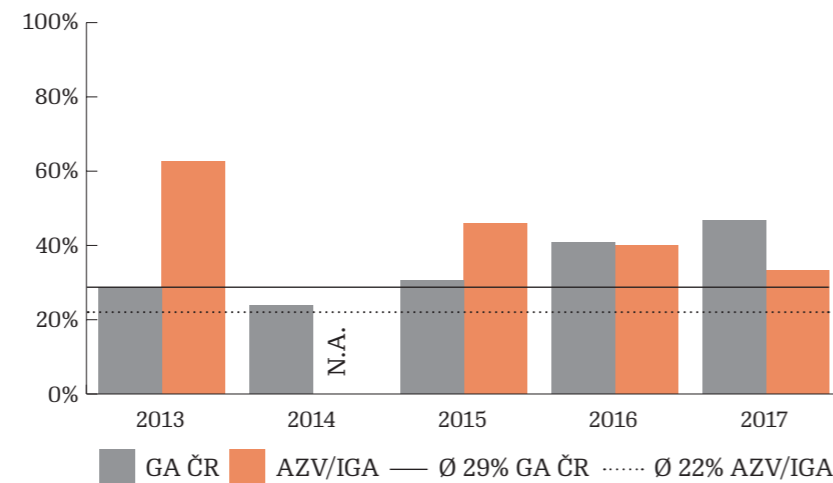

SHARE OF FINANCING BY THE INTERNATIONAL PROJECTS

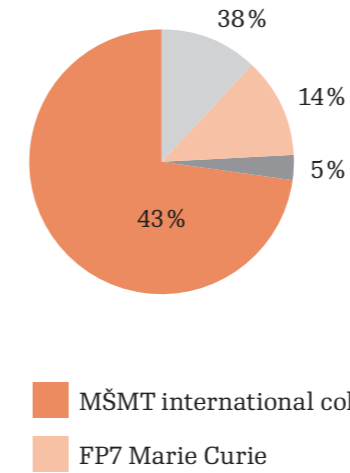

NUMBER OF INTERNATIONAL PROJECTS

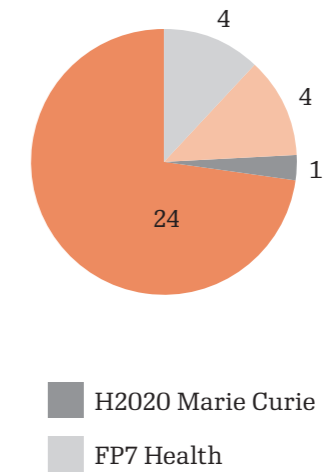

FINANCING BY THE OPERATIONAL PROGRAMMES OF THE EUROPEAN STRUCTURAL AND INVESTMENT FUNDS
(m = million CZK)

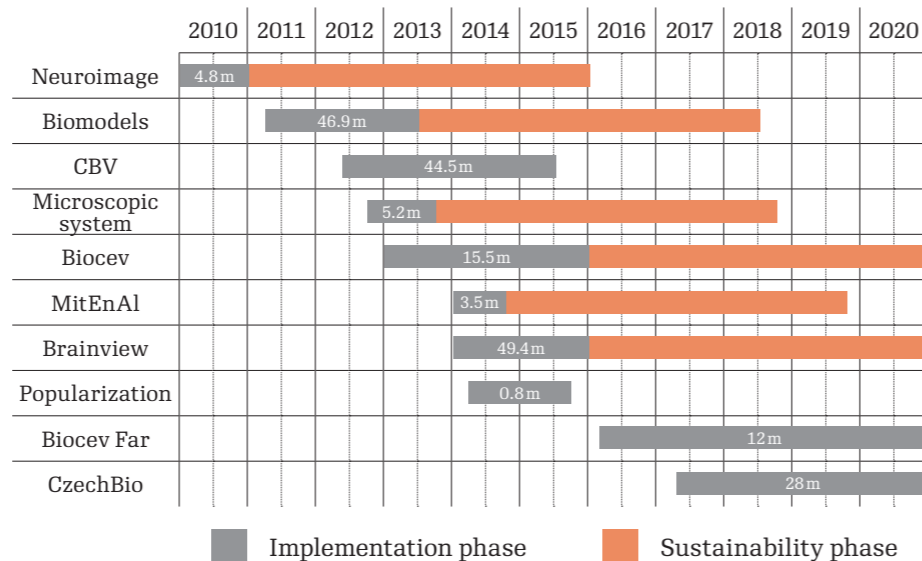

CENTRES OF EXCELLENCE

SCIENTISTS FROM IPHYS SERVE AS CO-ORDINATORS OF CENTRES OF EXCELLENCE

PROJECT OF EXCELLENCE IN NEUROSCIENCE (PEN) 2014–2018

CO-ORDINATOR Prof. MUDr. Ladislav Vyklický, DrSc. (Cellular Neurophysiology)

A collaboration of top scientists (IPHYS, National Institute of Mental Health in Klecany, Institute of Experimental Medicine CAS, 2nd Faculty of Medicine of the Charles University in Prague) conducting research into neurodegenerative diseases such as Alzheimer's disease, Parkinson's disease, amyotrophic lateral sclerosis.

CENTRE OF MITOCHONDRIAL BIOLOGY AND PATHOLOGY (MITOCENTRE) 2014–2018

CO-ORDINATOR MUDr. Josef Houšťek, DrSc. (Bioenergetics)

A collaboration of top scientists (IPHYS, 1st Faculty of Medicine of the Charles University in Prague, General University Hospital in Prague) to identify new components and functions of mammalian mitochondria and to characterize their pathophysiological roles.

STRATEGY AV21

In 2014, the Czech Academy of Sciences adopted new Strategy AV21 based on a set of coordinated long-term interdisciplinary Research Programmes focused on contemporary problems and challenges as well as an emphasis on practical application of the research results in economically and socially important areas. IPHYS is the coordinator of two of these programmes.

QUALITAS WELLBEING IN HEALTH AND DISEASE (2015–2019)

CO-ORDINATOR

Doc. MUDr. Jakub Otáhal, Ph.D.
(IPHYS, Developmental Epileptology)

The programme **QUALITAS – Wellbeing in health and disease** integrates experts from various research disciplines (medicine, physics, engineering, social sciences and the humanities). The main aim of the QUALITAS program is to develop more effective strategies to prevent and treat lifestyle-choice related diseases. In addition to restoring health, these strategies should also enhance the successful social integration of disease sufferers, their re-employment and ultimately improve the wellbeing of the patient and their careers.

Main Goals:

- Directly develop innovative diagnostic tools and therapies to prevent and treat diseases of modern civilization
- Minimize their consequences
- Promote faster recovery

Participating institutes:

- Institute of Physiology CAS (three research studies)
- Institute of Experimental Medicine CAS (two research studies)
- Institute of Molecular Genetics CAS
- Institute of Biophysics CAS
- Institute of Biotechnology CAS
- Institute of Sociology CAS
- Institute of Rock Structure and Mechanics CAS

Collaborating partners:

IKEM, University Hospital Vinohrady and others

More information:

www.fgu.cas.cz/qualitas

PRECLINICAL TESTING OF POTENTIAL PHARMACEUTICALS (2017–2021)

CO-ORDINATOR

MUDr. Jan Kopecký, DrSc.
(IPHYS, director)

The programme **Preclinical testing of potential pharmaceuticals** reflects the need to use experiments on animals as a key element in the development of new pharmaceuticals, including the tests and analyses performed under GLP conditions (GLP-Good Laboratory Practice). Laboratory animals are used exclusively for the studies of potentially lifesaving therapeutics and where possible, alternative methods are used.

Main Goals:

- Coordination of research and development of potential pharmaceuticals and their comprehensive pre-clinical testing within CAS institutes
- Facilitate introduction of potential pharmaceuticals into practice
- Foster collaboration between the academic sector and commercial entities

Participating institutes:

- Institute of Physiology CAS
- Institute of Molecular Genetics CAS, Czech Centre for Phenogenomics (CCP)
- Institute of Biotechnology CAS
- Institute of Animal Physiology and Genetics CAS, Pigmod Centre

These institutes form the **Centre for Preclinical Testing (CPT)**

Collaborating partners:

Pharmakl, spol. s.r.o. and other commercial partners

More information:

www.prekliniky.cz

SELECTED AWARDS

2017

MUDr. Josef Houšťek, DrSc.
and his team

Prize of the Czech Academy of Sciences for the exceptional results in the field of energy metabolism and mechanisms behind mitochondrial diseases

2016

Prof. MUDr. Tomáš Radil, DrSc.

Award from Mensa Czech Republic for significant contribution to the nation's intelligence, promotion of intellectual culture and spreading the good name of the Czech Republic in the world

Prof. RNDr. František Vyskočil, DrSc.

Medal of the Czech Learned Society for meritorious contributions to the advancement of science

Prof. MUDr. Bohuslav Ošťádal, DrSc.

G. J. Mendel Honorary Field Medal for merit in the biological sciences

Prof. MUDr. Pavel Mareš, DrSc.

Epileptology European Award 2016 for contributions to European epileptology

2015

Prof. RNDr. Helena Illnerová, DrSc.

Prize of the President of the Czech Academy of Sciences for the promotion and popularization of research, experimental development and innovations

Ing. Michal Pravenec, DrSc.

Praemium Academiae award for outstanding scientific contribution

Prof. RNDr. Helena Illnerová, DrSc.

Ariens Kappers medal from European Biological Rhythms Society

2014

MUDr. Přemysl Jiruška, Ph.D.

Jessenius Prize for a major contribution in medicine

2013

MUDr. Jan Kopecký, DrSc.

Prize of the Minister of Education for exceptional research findings on the impact of omega-3 fatty acids in the prevention and treatment of obesity and insulin resistance

Prof. RNDr. Helena Illnerová, DrSc.

G. J. Mendel Honorary Field Medal for merit in the biological sciences

Prof. MUDr. Pavel Mareš, DrSc.

Jan Evangelista Purkinje Honorary Field Medal for merit in the biomedical sciences

Prof. RNDr. Helena Illnerová, DrSc.

Jan Evangelista Purkinje Medal for merit in physiology

Prof. RNDr. František Kolář, CSc.

Laufberger Medal for work for the benefit of Czech physiology

Prof. MUDr. Bohuslav Ošťádal, DrSc.

“President elect” for longterm active work in the International Academy of Cardiovascular Sciences

MVDr. Richard Pospíšil, DrSc.

Expert Member for European Pharmacopoeia

2012

RNDr. Lubica Staňková, Ph.D.

Josef Hlávka Prize for the young scientists from CAS

Ing. Michal Pravenec, DrSc.

Grant of the prestigious Grant ERC CZ

MUDr. Josef Houšťek, DrSc.

Minister of Health's Certificate of Merit for exceptional results in health research and development during the project of the Grant Agency of the Ministry of Health

RNDr. Jaroslava Folbergrová, DrSc.

Jan Evangelista Purkinje Honorary Field Medal for merit in the biomedical sciences

PUBLICATIONS 2012–2016

PUBLICATIONS IN IMPACT FACTOR (IF) JOURNALS IN ASEP DATABASE

TOTAL NUMBER OF PUBLICATIONS

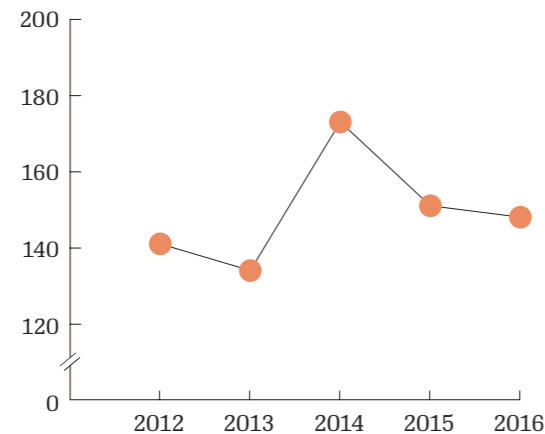

TOTAL IF

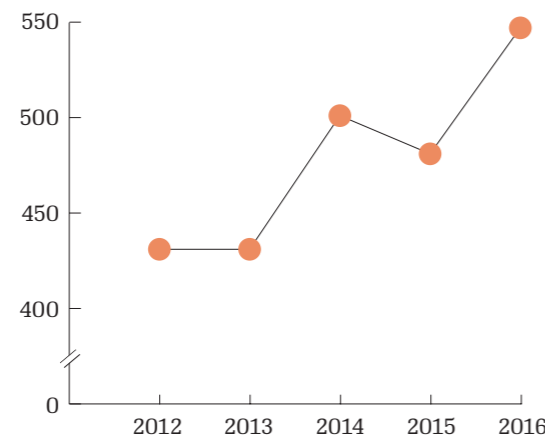

AVERAGE IF PER PUBLICATION

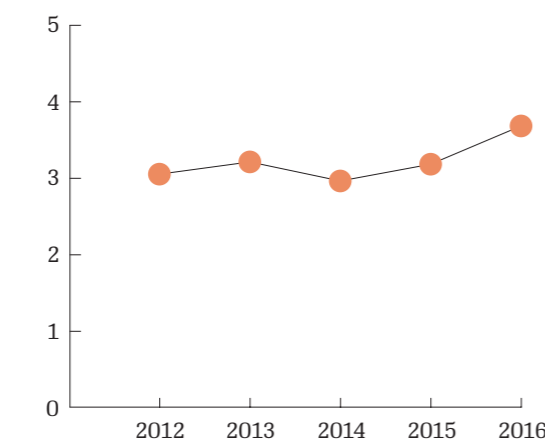

MOST CITED PAPERS THE TOP TENS*

DATA VALID TO 30TH JUNE 2017

Publications with the highest number of citation over the history of IPHYS:

1. **Vaněček J.:** Cellular mechanisms of melatonin action. *Physiol Rev* 78(3), 687-721 (1998). No. of citations: 393
2. **Ježek P., Hlavatá L.:** Mitochondria in homeostasis of reactive oxygen species in cell, tissues, and organism. *Int J Biochem Cell Biol* 37(12), 2478-2503 (2005). No. of citations: 376
3. **Vaněček J., Pavlík A., Illnerová H.:** Hypothalamic melatonin receptor-sites revealed by autoradiography. *Brain Res* 435 (1-2), 359-362 (1987). No. of citations: 349
4. Hubner N., Wallace C. A., Zimdahl H., Petretto E., Schulz H., Maciver F., Mueller M., Hummel O., Monti J., **Zídek V., Musilová A., Křen V.,** Causton H., Game L., Born G., Schmidt S., Müller A., Cook S. A., Kurtz T. W., Whittaker J., **Pravenec M.,** Aitman T. J.: Integrated transcriptional profiling and linkage analysis for identification of genes underlying disease. *Nature Genet* 37(3), 243-253 (2005). No. of citations: 333
5. Pařízek J., **Ošťádalová I.:** Protective effect of small amounts of selenite in sublimate intoxication. *Experientia* 23(2), 142-143 (1967). No. of citations: 331
6. **Vyskočil F., Bureš J., Kříž N.:** Potassium-selective microelectrodes used for measuring extracellular brain potassium during spreading depression and anoxic depolarization in rats. *Brain Res* 39(1), 255-259 (1972). No. of citations: 306
7. **Gutmann E.:** Neurotrophic relations. *Ann Rev Physiol* 38, 177-216 (1976). No. of citations: 290
8. **Dobiášová M.,** Frohlich J.: The plasma parameter log (TG/HDL-C) as an atherogenic index: correlation with lipoprotein particle size and esterification rate in apoB-lipoprotein-depleted plasma (FERHDL). *Clin Biochem* 34(7), 583-588 (2001). No. of citations: 280
9. **Tuček S.:** Regulation of acetylcholine synthesis in the brain. *J Neurochem* 44(1), 11-24 (1985). No. of citations: 248
10. **Folbergrová J.,** Passonneau J. V., Lowry O.H., Schulz D. W.: Glycogen ammonia and related metabolites in the brain during seizures evoked by methionine sulphoximine. *J Neurochem* 16(2), 191-203 (1969). No. of citations: 233

Publications with the highest number of citations over the last 10 years:

1. **Bačáková L., Filová E., Pařízek M.,** Ruml T., Švorčík V.: Modulation of cell adhesion, proliferation and differentiation on materials designed for body implants. *Biotechnol Adv* 29(6), 739-767 (2011). No. of citations: 221
2. **Kubík Š.,** Miyashita, T., Guzowski, J. F.: Using immediate-early genes to map hippocampal subregional functions. *Learning & Memory* 14(11), 758-770 (2007). No. of citations: 121
3. **Chlupáč J., Filová E., Bačáková L.:** Blood vessel replacement: 50 years of development and tissue engineering paradigms in vascular surgery. *Physiol Res* 58 (Suppl.2), S119-S139 (2009). No. of citations: 112
4. **Flachs P., Rossmeisl M.,** Bryhn M., **Kopecký J.:** Cellular and molecular effects of n-3 polyunsaturated fatty acids on adipose tissue biology and metabolism. *Clin Sci* 116(1), 1-16 (2009). No. of citations: 111
5. **Ježek K.,** Henriksen E. J., Treves A., Moser E. I., Moser M. B.: Theta-paced flickering between place-cell maps in the hippocampus. *Nature* 478(7368), 246-249 (2011). No. of citations: 99
6. **Jíruška P.,** de Curtis M., Jefferys J. G. R., Schevon C. A., Schiff S. J., Schindler K.: Synchronization and desynchronization in epilepsy: controversies and hypotheses. *J Physiol* 591(4), 787-797 (2013). No. of citations: 91
7. **Obšilová V.,** Šilhán J., Boura E., **Teisinger J., Obšil T.:** 14-3-3 proteins: a family of versatile molecular regulators. *Physiol Res* 57 (Suppl 3), S11-S21 (2008). No. of citations: 90
8. **Obšil T., Obšilová V.:** Structure/function relationships underlying regulation of FOXO transcription factors. *Oncogene* 27(16), 2263-2275 (2008). No. of citations: 87
9. **Obšil T., Obšilová V.:** Structural basis of 14-3-3 protein functions. *Sem Cell Develop Biol* 22(7), 663-672 (2011). No. of citations: 85
10. **Čížková A.,** Stránecký V., Mayr J. A., Tesařová M., **Havlíčková V., Paul J.,** Ivánek R., Kuss A. W., Hansíková H., **Kaplanová V., Vrbacký M.,** Hartmannová H., Nosková L., Honzík T., **Drahota Z.,** Magner M., **Hejzlarová K.,** Sperl W., Zeman J., **Houšťek J.,** Kmoč S.: TMEM70 mutations cause isolated ATP synthase deficiency and neonatal mitochondrial encephalomyopathy. *Nature Genet* 40(11), 1288-1290 (2008). No. of citations: 80

*Only publications with the first or corresponding author with the affiliation to IPHYS are listed.

PhD PROGRAMME / STUDENTS

IPHYS PROVIDES HIGH-QUALITY TRAINING FOR STUDENTS OF BACHELOR'S, MASTER'S AND DOCTORAL DEGREE PROGRAMMES IN COOPERATION WITH A NUMBER OF CZECH UNIVERSITIES AS WELL AS PRESTIGIOUS INTERNATIONAL INSTITUTIONS.

Currently, about 70 PhD students are educated at IPHYS. Every year, IPHYS announces an on-line application call for its PhD programme. IPHYS is also involved in the Open Science project which opens the doors of its laboratories to high-school students.



TOTAL NUMBER OF PhD STUDENTS AT IPHYS (2012–2017)

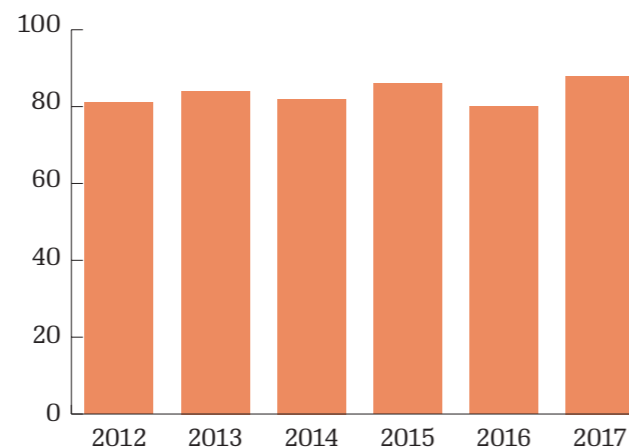

PhD STUDENTS BENEFITS AT IPHYS

- **research** in the fields of neuroscience, cardiovascular physiology and metabolism
- **training** in modern methods in physiology, biochemistry and molecular biology
- employment at IPHYS with up-to full time salary and **benefits**
- participation in **regular events** for PhD students organized and subsidized by IPHYS (seminars, Course of physiological methods, biannual external meeting)
- **advancement report** and **internal doctoral PhD thesis** examination as a prerequisite for successful completion of a study
- **English** language courses
- modern **campus** with on-site accommodation
- **sports** facilities

OUTREACH ACTIVITIES

IPHYS ORGANIZES A NUMBER OF EVENTS FOR THE PROFESSIONAL AND GENERAL PUBLIC DURING ALL THE YEAR.

Publicly accessible lectures of invited scientists from fields related to IPHYS research as well as those of IPHYS employees are organized weekly and include Bureš's lectures being delivered by first-class invited scientists.

ACTIVITIES FOR THE GENERAL PUBLIC

IPHYS research results are regularly presented at various science festivals organized by CAS (Science Expo, Week of the Brain, Week of Science and Technology). In addition, several successful popular-science interactive programmes presenting the physiology of the human body and IPHYS research topics were implemented recently.



OPEN HOUSE DAY

The laboratories of IPHYS are opened to the public annually in November during the Week of Science and Technology.

MEMORY PARK

An interactive workshop with eleven unique psychological tests of memory and orientation skills, some of them developed at IPHYS (Department of Neurophysiology of Memory).

PURKINJE CHAMBER OF PHYSIOLOGY

Interactive exhibition explaining biological clocks, the functioning of muscles, the significance of heartbeat frequency and uncovering many other functions of the human body.

THE HUMAN BODY IN HEALTH AND DISEASES

Regular joint presentations of IPHYS's researchers and clinicians presenting collaboration between experts from basic research and clinical specialists, which is necessary for the development of novel diagnostic and therapeutic procedures.

BUREŠ'S LECTURE SERIES

The lecture series was initiated in 2013 as part of the celebration of IPHYS 60th anniversary. The series is named in the honour of Jan Bureš (1926–2012), an outstanding neuroscientist (Neurophysiology of Memory) who had been working at IPHYS since its foundation.

Invited speakers:

- 2017 Masashi Yanagisawa (Japan)
- 2016 Philipp Scherer (USA)
- 2015 Hana Antonicka (Canada), Victor Hruby (USA), Michael P. Czech (USA), Grant Pierce (Canada)
- 2014 Eva Paštálková (USA), Robert G. Gourdie (USA), Peter Illes (Germany), Michael Menaker (USA), Asla S. L. Pitkänen (Finland), Barbara Cannon (photo) (Sweden)
- 2013 Andreas Hejnol (Norway), Lynn Nade (USA)

INTERACTIVE VIDEO-PRESENTATION OF IPHYS RESEARCH

It is freely available at the IPHYS web site and awarded in 2013 at The European Science TV and New Media Festival in Dublin. It represents an overview of IPHYS research topics and can be used as an educational tool.

CONTACTS

DIRECTOR'S OFFICE

Ing. Michaela Jirečková

Michaela.Jireckova@fgu.cas.cz

+420 241 062 815

COMMUNICATIONS

Diana Moosová

Diana.Moosova@fgu.cas.cz

+420 241 062 413

HUMAN RESOURCES

Ing. Monika Dolanská

Monika.Dolanska@fgu.cas.cz

+420 241 062 225

GRANT OFFICE

Ing. Michaela Glaserová

Michaela.Glaserova@fgu.cas.cz

+420 241 062 584

INSTITUTE OF PHYSIOLOGY OF THE CZECH ACADEMY OF SCIENCES

Videňská 1083

142 20 Prague 4-Krč

Tel.: +420 241 062 424

Tel.: +420 241 062 815

Fax: +420 241 062 488

fgu@fgu.cas.cz

www.fgu.cas.cz

 FyziologickyUstavAVCR

Design: Linda Kriegerbecková / Cittadella Production

Photo: Michaela Hrubá / Cittadella Production, Mgr. Michal Růžička, Ph.D., IPHYS archive

Editors: MUDr. Jan Kopecký, DrSc., Ing. Olga Zimmermannová, Ph.D., Diana Moosová

Print: Carter Reproplus s.r.o.

© Institute of Physiology CAS, 2017



The Czech Academy
of Sciences

INSTITUTE
OF PHYSIOLOGY CAS