

**October 2014**

**ZEN 2 (black edition)**

**LSM 880**  
**LSM 880 NLO**  
**Operating Manual**

Knowledge of this manual is required for the operation of the instrument. Would you therefore please make yourself familiar with the contents of this manual and pay special attention to hints concerning the safe operation of the instrument.

The specifications are subject to change; the manual is not covered by an update service.

- © Unless expressly authorized, forwarding and duplication of this document, and the utilization and communication of its contents are not permitted. Violations will entail an obligation to pay compensation.

All rights reserved in the event of granting of patents or registration of a utility model.

Issued by Carl Zeiss Microscopy GmbH  
Carl-Zeiss-Promenade 10  
07745 Jena, Germany

[microscopy@zeiss.com](mailto:microscopy@zeiss.com)  
[www.zeiss.com/microscopy](http://www.zeiss.com/microscopy)

---

## How to make best use of the LSM 880 and LSM 880 NLO operating instructions:

A few symbols in these operating instructions will help you to recognize the nature and purpose of information immediately:



The WARNING symbol warns against hazards for the user that might arise when operating the laser.



This WARNING symbol warns against hazards from dangerously high voltages.



The CAUTION symbol warns against faults and hazards that might arise during operation and which might cause damage to the unit.



The NOTE symbol will help you to optimally solve your work problem. It represents a practical tip which will help you to find out which settings and methods are capable of improving or accelerating a procedure.



The HOT SURFACE symbol warns against hazards for the user that might arise when touching the lamp housing during operation.



The MAINS PLUG symbol reminds service personal to pull the mains plug before opening the device housing.

Depending on the request, these operating instructions will supply you with various possibilities:

- If you want to know where to find certain general areas of information, refer to the following outline of sections to get a general overview.
- You will find a detailed table of contents at the start of every chapter. There you will see at a glance what topics are covered in detail.

**Always remember: The time you invest in getting acquainted with the product will pay for itself many times over in your application task.**

## Contents

---

### **1 System Operation**

In this section you will find the most important steps and procedures of the LSM menu structure. The step-by-step description how to get an image will be shown by typical application examples including the WINDOWS graphic user environment.

---

### **2 Macros and Visual Basic**

This section contains a description of the use of additional functions, e.g. maintenance, macros.

---

### **3 Additional Software Tools**

This section contains a description of the use of additional tools for setting the microscope.

---

### **4 Annex**

The annex contains the Application-specific Configurations, special notes and information for using the LSM microscope.

---

### **5 Multiphoton Laser Scanning Microscopy with LSM Family Systems**

This section provides detailed back ground information on Multiphoton Microscopy including trouble shooting procedures.

---

### **6 Certification**

---

### **7 Laser Safety Warning Labels**

---

### **8 Introduction to Laser Scanning Microscopy**

The section introduces you to the performance features of your LSM system.

---

---

# IMPORTANT NOTES FOR CHAPTER 1

- Visual Macro Editor does not allow saving .czi file format.
- Auto Z correction function works with laser powers smaller than 0.5 % but does not display the changes even if Enable Test is active.
- Do not use "Double click in image" function for shuttle and find as this does move stage when keeping the mouse button pressed.
- Processed PALM data do not show up as image in the Shuttle and Find View tab, use unprocessed data instead.
- Do not use "Double click in image" function for shuttle and find as this does move stage even without calibration data.
- Creating a new block moves the stage in Z to a lower position. Duplicate an existing block instead to not lose the focus.
- Do not reuse images which have been acquired with polarization filters use for acquisition. The filters cannot be removed from the beam path afterwards and ZEN has to be restarted if that is needed.
- The Z coordinate in the info view refers to the center position for Position Experiments or the first image of the stack for Non-Position Experiments.
- Using Fast Z Line mode in combination with a Multitrack does result in wrong results. Do not check fast Z line or avoid multi-tracking.
- Multi-positions will not be concatenated; the positions dimension is lost.
- Tuning a multiphoton laser with inbuilt dispersion compensation to a different wavelength for bleaching might result in the first image(s) following the bleach event not being final as the GDD can still be moving. This can be set via database. Contact your ZEISS representative on details if that function is of interest for you.
- Using arrow, line or scale bar as graphics tool in non-processed Airyscan data (Airyscan View) does change table parameters in an unspecified way. Use these tools only for processed data.
- Concatenating SR mode and VP mode acquired datasets using modify series or the concatenate macro produces faulty results.
- Spot select for spot imaging or bleaching should only be used within one image container. Applying it to images in different containers may result in malposition of the spots.
- Using the split mode of the 3D view does not work in combination with measurements in 3D. Use either or for display or measurement.
- Do not use ILEX mode other than when Airyscan detector is set active.
- When using LSM and SIM imaging in multitrack mode, use the maximal pixel resolution for the camera to be able to apply a fit function to the SIM image.
- Particle tracking requires non processed PALM data as input. Processed data produce no results.
- For wide-field imaging, set the halogen lamp for illumination during continuous scan to adjust before starting the final scan. Settings of the lamp without scanning might not be effective for the image acquisition.
- When using LSM and SIM imaging in multitrack mode, the processing of the SIM image will then lead to a loss of the last image of the LSM acquisition. Split the images before processing the SIM image(s).

- The functions Crop, Split, Delete and Copy used in the file browser menu requires some time for GUI update.
- When using the channel unmixing function for Airyscan data, the histogram of the resulting image still refers to the Airyscan data set.
- Airyscan datasets with step sizes too small (much too high oversampling like with step sizes of 10 nm) lead to faulty processing. Choose 100 nm steps or above as suggested by software for Z-Stack acquisition.
- When analyzing PALM data for particle tracking, it is possible to select an entry in the table to highlight the linked particle. It does not work the other way round.
- Do not use PALM image that has already been processed, again as input image for PALM processing. This leads to GUI artefacts that are only reversible with starting ZEN again.
- When performing Z-Stacks which require averaging of frames, use Line Average. Frame Average can lead to empty image frames.

# CHAPTER 1 SYSTEM OPERATION

## CONTENTS

	Page
<b>1 PURPOSE .....</b>	<b>8</b>
1.1 Software.....	8
1.2 Convention for the Text in this Manual .....	8
1.3 Backup.....	9
1.4 Software Operation.....	9
<b>2 HARDWARE ASPECTS .....</b>	<b>10</b>
2.1 Principle of Laser Scanning Microscopy.....	10
2.2 Principle of Fluorescence Correlation Spectroscopy.....	11
2.3 Principle of Airyscanning.....	12
2.4 Optical Diagram of the LSM 880 (Schematic) .....	13
2.5 Performance Features of the LSM 880.....	14
2.6 Microscope Equipment of the LSM 880 .....	15
2.7 Computer Hardware and Software .....	17
<b>3 STARTUP AND SHUTDOWN OF THE SYSTEM .....</b>	<b>18</b>
3.1 Startup of the System.....	18
3.1.1 The Power Remote Switch .....	18
3.1.2 Starting ZEN .....	20
3.2 Shutdown Procedure.....	23
3.2.1 Exiting ZEN Software .....	23
3.2.2 Switching System Power Off .....	25
<b>4 INTRODUCTION TO THE SOFTWARE APPLICATION LAYOUT .....</b>	<b>26</b>
4.1 Overview on the Screen Layout.....	26
4.2 Introduction to ZEN .....	27
4.3 Function Elements .....	30
4.4 Application Bar .....	32
4.5 Menu Bar.....	32
4.5.1 File.....	34
4.5.2 Maintain .....	35
4.5.2.1 Set Spline .....	35
4.5.2.2 Camera .....	36
4.5.2.3 Hardware Administrator.....	36
4.5.2.4 Test Grid .....	36

---

4.5.3	Help – About .....	37
<b>4.6</b>	<b>Main Toolbar .....</b>	<b>38</b>
<b>4.7</b>	<b>Status Bar.....</b>	<b>40</b>
<b>4.8</b>	<b>Left Tool Area .....</b>	<b>41</b>
4.8.1	Tool Groups and Tools.....	43
4.8.2	Context Menu of the Left Tool Area.....	44
<b>4.9</b>	<b>Center Screen Area.....</b>	<b>45</b>
4.9.1	Overview of the Center Screen Area .....	45
4.9.2	Context Menu of the Center Screen Area.....	47
<b>4.10</b>	<b>Right Tool Area.....</b>	<b>48</b>
<b>5</b>	<b>LEFT TOOL AREA AND HARDWARE CONTROL TOOLS.....</b>	<b>50</b>
<b>5.1</b>	<b>Locate Tab.....</b>	<b>51</b>
5.1.1	Microscope Control Tool for Axio Observer.Z1 .....	53
5.1.2	Microscope Control Tool for Axio Imager.Z2 .....	60
5.1.3	Controls for Axio Examiner .....	63
5.1.4	Incubation Tool .....	64
<b>5.2</b>	<b>Acquisition Tab.....</b>	<b>65</b>
5.2.1	Configuration Functions .....	66
5.2.2	Smart Setup .....	68
5.2.3	Action Buttons .....	73
5.2.4	Multidimensional Acquisition Settings .....	75
5.2.5	Setup Manager – Laser .....	77
5.2.6	Setup Manager – Experiment Designer.....	80
5.2.7	Setup Manager – Imaging Setup.....	84
5.2.7.1	Imaging Mode and Track Definition .....	84
5.2.7.2	Filter Cube Selection.....	86
5.2.7.3	Objective Selection .....	86
5.2.7.4	Stage Control.....	87
5.2.7.5	Focus Control.....	88
5.2.7.6	HAL Control.....	88
5.2.7.7	X-Cite Control.....	89
5.2.7.8	Aperture Control.....	89
5.2.7.9	Ratio Imaging.....	90
5.2.7.10	Laser Control .....	90
5.2.7.11	Control Elements of the Imaging Setup Tool .....	91
5.2.7.12	Setup Imaging with Airyscan Detector.....	99
5.2.8	Acquisition Parameter – Acquisition Mode .....	101
5.2.8.1	Objective Selection .....	101
5.2.8.2	Scan Mode.....	102
5.2.8.3	Format Selection .....	102
5.2.8.4	Averaging and Color Depth Selection.....	103
5.2.8.5	HDR(High Dynamic Range)-Imaging .....	104
5.2.8.6	Scan Area Definition.....	105
5.2.8.7	Acquisition Mode Functions for LSM.....	106
5.2.8.8	Acquisition Mode Settings for Airyscan .....	113
5.2.9	Acquisition Parameter – Channels.....	115

---



5.2.9.1	Defining Channels and Tracks .....	116
5.2.9.2	Ratio Channels .....	120
5.2.9.3	Using GaAsP Detectors and the temperature controlled side PMT for Photon Counting Imaging .....	121
5.2.9.4	Channel Settings for Airyscan .....	124
5.2.10	Acquisition Parameter – Focus .....	126
5.2.11	Acquisition Parameter – Focus Devices and Strategy .....	127
5.2.12	Acquisition Parameter – Stage .....	131
5.2.13	Acquisition Parameter – Shuttle and Find .....	132
5.2.14	Acquisition Parameter – Regions .....	138
5.2.15	Multidimensional Acquisition – Z-Stack .....	141
5.2.15.1	Performing a Z-Stack Using First/Last Mode .....	142
5.2.15.2	Performing a Z-Stack Using Center Mode .....	144
5.2.15.3	Performing a Z-Stack Using a Z-Piezo .....	146
5.2.15.4	Optimize Sectioning and Step .....	147
5.2.15.5	Correction .....	148
5.2.15.6	Z-Stack Settings for Airyscan .....	149
5.2.16	Multidimensional Acquisition – Bleaching .....	150
5.2.17	Multidimensional Acquisition – Tile Scan .....	152
5.2.18	Scan Overview Image for Tiling .....	154
5.2.19	Multidimensional Acquisition – Time Series .....	155
5.2.19.1	Interval Time .....	155
5.2.19.2	Marker .....	157
5.2.19.3	Start .....	159
5.2.19.4	End .....	161
5.2.20	Multidimensional Acquisition – Positions .....	162
5.2.20.1	Position List .....	162
5.2.20.2	Sample Carrier .....	163
5.2.20.3	Setting Individual Offset Values for Positions in Position List Mode .....	166
5.2.20.4	Lowering Objective when Moving the Stage .....	166
5.2.20.5	Scan Overview Image .....	167
5.2.21	Multidimensional Acquisition – Information on Experiment .....	167
5.2.22	Multidimensional Acquisition – Auto Save .....	168
5.2.23	Image Optimization .....	169
5.2.23.1	Requirements .....	169
5.2.23.2	Defining the Scan Parameters .....	171
5.2.23.3	Defining the Detection Parameters .....	171
5.2.23.4	How to Optimize Image Quality .....	172
5.2.23.5	How to Optimize Imaging with Airyscan .....	173
<b>5.3</b>	<b>FCS Tab .....</b>	<b>175</b>
5.3.1	Setup – Laser .....	177
5.3.2	Setup – Light Path .....	177
5.3.2.1	Light Path for 2 Channel Module (BiG.2 on DC out port) .....	179
5.3.2.2	NDD Light Path (BiG.2 as NDD) .....	181
5.3.2.3	Light Path for 32 Channel Module .....	183
5.3.2.4	Selection of Laser Lines .....	184
5.3.2.5	Pinhole Adjustment .....	186
5.3.3	Setup – Acquisition .....	190

---

5.3.4	Setup – Fit.....	192
5.3.4.1	Defining a New Model.....	194
5.3.4.2	Correlation Options.....	195
5.3.4.3	Model Equations.....	196
5.3.4.4	Definition of a Model.....	213
5.3.4.5	PCH.....	222
5.3.4.6	Formula.....	223
5.3.5	Setup – Correlator.....	224
5.3.6	Navigation – Stage.....	228
5.3.7	Navigation – Sample Carrier.....	229
5.3.8	Navigation – Focus.....	231
5.3.9	Multidimensional Acquisition Tools – Time Series.....	236
5.3.10	Multidimensional Acquisition Tools – Positions.....	238
5.3.11	Navigation – Incubation.....	247
5.3.12	Multidimensional Acquisition Tools – Information on Experiment.....	248
5.3.13	Action Buttons for FCS.....	249
5.3.14	Method Tool.....	250
5.3.15	Activation Tab Area.....	253
5.3.16	New.....	253
5.3.17	Count Rate.....	254
5.3.18	X-Y-Z Scan.....	256
5.3.19	Snap.....	259
5.3.20	Start Experiment.....	259
5.3.21	Taking FCS Measurements.....	260
5.3.21.1	Start and End of a Measurement.....	263
5.3.21.2	Loading Stored Data Files.....	267
5.3.21.3	FCS Correlation Diagram.....	268
5.3.21.4	Image View Controls – Correlation Tab.....	271
5.3.21.5	Image View Controls – Table Tab.....	273
5.3.21.6	Saving Correlation Results.....	278
5.3.21.7	Coincidence.....	280
5.3.21.8	Fit.....	281
5.3.21.9	Print.....	290
5.3.21.10	Information.....	292
<b>5.4</b>	<b>Processing Tab.....</b>	<b>293</b>
5.4.1	General Structure of the Processing Tab.....	293
5.4.2	Processing – Airyscan Processing.....	297
5.4.3	Processing – Maximum Intensity Projection.....	300
5.4.4	Processing – Color-coded Projection.....	301
5.4.5	Processing – Image Calculator.....	302
5.4.6	Processing – Average.....	304
5.4.7	Processing – Filter.....	305
5.4.8	Processing – Linear Unmixing.....	308
5.4.9	Processing – Ion Concentration.....	313
5.4.9.1	Single Wavelength Dyes – Offline Calibration.....	315
5.4.9.2	Ratiometric Dyes.....	316
5.4.10	Processing – Correlation.....	319
5.4.11	Processing – Modify Series.....	320

---

---

5.4.12	Processing – HDR-imaging .....	321
5.4.13	Processing – Stitch .....	325
5.4.14	Processing – PALM.....	326
5.4.14.1	PALM – Convert to Image .....	327
5.4.14.2	PALM – Import PALM Molecules .....	328
5.4.14.3	PALM – Localization Precision.....	329
5.4.14.4	PALM – PALM .....	330
5.4.14.5	PALM – Remove PALM Outliers .....	338
5.4.15	Processing – Particle Tracking .....	339
5.4.16	Processing – Experimental PSF .....	341
5.4.17	Processing – Structured Illumination .....	345
5.4.17.1	Structured Illumination – Fourier Transform .....	346
5.4.17.2	Structured Illumination – Structured Illumination.....	347
5.4.17.3	Structured Illumination – TIRF-Filtered.....	352
5.4.18	Processing – Channel Alignment .....	354
5.4.19	Processing – Lightsheet Processing .....	361
5.4.19.1	Dual Side Fusion .....	361
5.4.19.2	Multiview Processing .....	364
5.4.19.3	Online Multiview Processing.....	381
5.4.20	Processing – Copy.....	382
5.4.21	Processing – ICS .....	384
5.4.21.1	Detrend.....	384
5.4.21.2	Remove Structure .....	385
5.4.21.3	ICS Correlation .....	386
5.4.21.4	Map Filter.....	387
5.4.21.5	NandB Analysis.....	388
5.4.22	Processing – Adjust.....	391
5.4.22.1	Burn in Brightness and Contrast .....	391
5.4.22.2	Interpolate Brightness and Contrast .....	392
5.4.22.3	Channel Shift .....	393
5.4.22.4	Shading Correction.....	394
<b>5.5</b>	<b>Maintain Tab.....</b>	<b>395</b>
5.5.1	Maintain – Adjust Pinhole and Collimators .....	396
5.5.1.1	Pinholes Section Panel .....	397
5.5.1.2	Collimators Section Panel.....	398
5.5.1.3	How to Adjust the Pinhole and Collimator.....	399
5.5.2	Maintain – Objectives .....	402
5.5.2.1	Objective .....	402
5.5.2.2	Select Objective .....	403
5.5.2.3	Add Objective.....	404
5.5.2.4	Remove Objective .....	405
5.5.2.5	Show/Edit Objective.....	405
5.5.2.6	Focus Speed .....	406
5.5.2.7	Parfocal Correction.....	406
5.5.3	Maintain – Filters .....	407
5.5.4	Maintain – Airyscan .....	408
5.5.5	Options – System Options .....	409
5.5.5.1	System Options – Load Configurations .....	410
5.5.5.2	System Options – Reuse.....	410

---

---

5.5.5.3	System Options – Hardware.....	411
5.5.5.4	System Options – Image Display.....	412
5.5.6	Options – FCS Options.....	413
5.5.6.1	FCS Options – Data .....	413
5.5.6.2	FCS Options – Measure .....	417
5.5.6.3	FCS Options – Auto Save .....	418
5.5.7	Options – Service.....	418
<b>6</b>	<b>CENTER SCREEN AREA / IMAGE CONTAINERS - DISPLAY AND IMAGE ANALYSIS.....</b>	<b>419</b>
<b>6.1</b>	<b>Structure and Functional Concept of the Center Screen Area and the Image Display Container .....</b>	<b>419</b>
6.1.1	General Structure .....	419
6.1.2	Container Configuration with the Container Context Menu .....	423
<b>6.2</b>	<b>2D View.....</b>	<b>424</b>
6.2.1	Dimensions .....	424
6.2.2	Display .....	427
6.2.3	Player.....	428
6.2.4	Graphics .....	429
6.2.5	Preview View .....	432
<b>6.3</b>	<b>Split View.....</b>	<b>433</b>
<b>6.4</b>	<b>Gallery View .....</b>	<b>436</b>
<b>6.5</b>	<b>Airyscan View .....</b>	<b>437</b>
6.5.1	Airyscan – View Option Tab Dimensions.....	437
6.5.2	Airyscan – View Option Tab Display .....	438
6.5.3	Airyscan – View Option Tab Airyscan .....	439
<b>6.6</b>	<b>Ortho View .....</b>	<b>443</b>
6.6.1	Ortho – Select Function .....	444
6.6.2	Ortho – Distance Function .....	445
<b>6.7</b>	<b>Cut View .....</b>	<b>446</b>
<b>6.8</b>	<b>2.5 D View.....</b>	<b>447</b>
<b>6.9</b>	<b>3D View.....</b>	<b>449</b>
6.9.1	Shadow Projection .....	451
6.9.2	Transparency Render Mode .....	454
6.9.3	Maximum Mode.....	455
6.9.4	Surface Render Mode.....	455
6.9.5	Mixed Render Mode.....	456
6.9.6	Clipping Planes.....	457
6.9.7	Flying Mode .....	461
6.9.8	3D Rendering Settings in <i>VisArtplus</i> .....	461
6.9.9	Series.....	463
6.9.10	Interactive Measurements.....	465
6.9.11	Settings .....	466
6.9.12	Options.....	467
6.9.13	3D View – Basic.....	468
<b>6.10</b>	<b>Histogram View.....</b>	<b>469</b>

---

<b>6.11</b>	<b>Colocalization View</b> .....	<b>472</b>
6.11.1	How a Scatter Diagram is Generated .....	474
6.11.2	Quantitative Colocalization Parameters Shown in the Data Table .....	475
6.11.3	Colocalization Coefficients .....	475
6.11.4	Overlap Coefficient, Overlap Coefficient after Manders .....	476
<b>6.12</b>	<b>Profile View</b> .....	<b>476</b>
<b>6.13</b>	<b>Shuttle and Find View</b> .....	<b>479</b>
<b>6.14</b>	<b>Mean of ROI: Additional View Type for Time Series</b> .....	<b>482</b>
<b>6.15</b>	<b>Kinetic / FRAP View: Additional View Type for Time Series</b> .....	<b>486</b>
<b>6.16</b>	<b>Lambda Coded: Additional View Types for Lambda Mode</b> .....	<b>492</b>
<b>6.17</b>	<b>Unmixing View</b> .....	<b>494</b>
6.17.1	Automatic Component Extraction .....	499
<b>6.18</b>	<b>FRET View</b> .....	<b>501</b>
6.18.1	Tools in the FRET View Options Control Block for Acceptor Photobleaching .....	503
6.18.2	Tools in the FRET View Options Control Block for Sensitized Emission .....	505
<b>6.19</b>	<b>Raster Scanning Image Correlation Spectroscopy (RICS)</b> .....	<b>508</b>
6.19.1	Access to RICS .....	509
6.19.2	Control of View Functionalities .....	509
6.19.3	Correlation Functionalities .....	510
6.19.4	Display Functionalities .....	513
6.19.5	Fitting Functionalities .....	520
6.19.6	Model Functionalities .....	523
<b>6.20</b>	<b>Polarization Imaging</b> .....	<b>527</b>
6.20.1	Imaging Setup for Polarization Imaging .....	528
6.20.2	Determination of G-factor .....	529
6.20.3	Obtaining an Anisotropy Image .....	530
<b>6.21</b>	<b>Information View</b> .....	<b>532</b>
<b>7</b>	<b>RIGHT TOOL AREA, DATA MANAGEMENT AND STORAGE</b> .....	<b>534</b>
<b>7.1</b>	<b>General</b> .....	<b>534</b>
<b>7.2</b>	<b>ZEN File Browser</b> .....	<b>535</b>
7.2.1	Gallery View of the ZEN File Browser .....	538
7.2.2	Form View of the ZEN File Browser .....	540
7.2.3	Table View of the ZEN File Browser .....	541
<b>7.3</b>	<b>Images and Documents Panel</b> .....	<b>542</b>
<b>7.4</b>	<b>Opening of Files via the "Open" Command in the File Menu</b> .....	<b>545</b>
<b>7.5</b>	<b>Save</b> .....	<b>545</b>
<b>7.6</b>	<b>Export of Images</b> .....	<b>546</b>
<b>8</b>	<b>INDEX</b> .....	<b>547</b>

## 1 Purpose

This section describes the operation of the Laser Scanning Microscope with the ZEN 2 software.

When starting up and operating the microscope system, mind the operating instruction manuals for the Axio Imager.Z2, Axio Imager.M2, Axio Observer.Z1 and Axio Examiner.Z1 microscopes:

- M70-2-0020 Axio Imager.Z2 / M2, Operating Manual
- B 40-0111 Axio Observer.Z1, Operating Manual
- M60-2-0003 Axio Examiner.Z1, Operating Manual

### 1.1 Software

The ZEN software is used to

- control the microscope, the scanning module, the laser module, and the image acquisition process
- display, edit and analyze the images

It is a special user interface (desktop) based on the network-capable graphic 64-bit Microsoft® WINDOWS 7 operating system.

Portions© Copyright 2007, Microsoft Corporation. All rights reserved.

The installation of the software for the Laser Scanning Microscope and the basic settings of the equipment components are carried out by ZEISS service staff. This job includes the creation of a customized software configuration in line with the specific hardware components of the customer's microscope system.

### 1.2 Convention for the Text in this Manual

All the originally used terms of the software interface, e.g.

- names of windows
- tool groups
- panels
- input boxes
- list / selection boxes
- check boxes
- menu items
- names of buttons and sliders
- keyboard keys

are displayed in **bold letters** to allow easier identification.

## 1.3 Backup

### System backup

Prior to the delivery of each system, a backup of the entire system computer is created in the factory. This backup image belongs to the system and may be re-installed in order to restore the original state of the system computer. Please contact your local service representative if the backup image needs to be installed.

### User files backup

The following user-generated files should be included in a backup procedure controlled and carried out on a regular basis by the user (keep directory structure):

- Carl Zeiss Image files: \*.czi
- LSM Image files: \*.lsm
- Exported images: \*.\* (\*.Tiff, \*.LSM-Tiff, \*.BMP, ...)
- Palette files: ZEN\Palette\\*.lut

The backup of further hardware calibration settings including the database and licence file can easily be created with the **CanCheck** tool (C:\ZEN\CanCheck).

- Click the **CREATE REPORT** button in the **CanCheck** window (Fig. 1).

A system report will be created and saved to the desktop on your computer as a zip file named report.zip. This report contains all the information needed for a system status report and to create a save copy in case the system has to be reset.

## 1.4 Software Operation

The ZEN software can be operated using the mouse, the PC keyboard, or both. The operation of the mouse and the keyboard is identical to that of the Microsoft® WINDOWS 7 operating system and is therefore not described in this manual. If required, see the Microsoft manual or online help for relevant information.

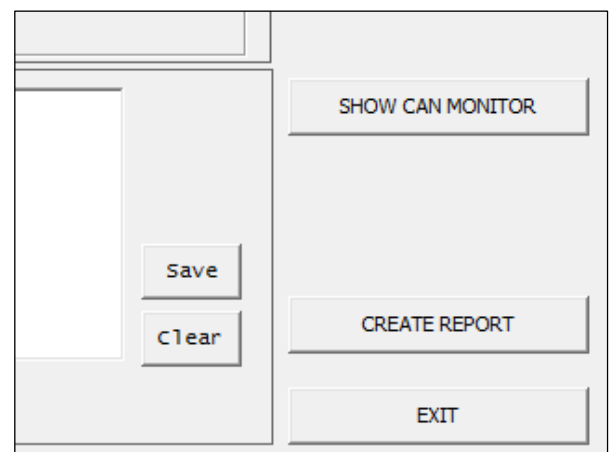


Fig. 1 Cut-out of the CanCheck window

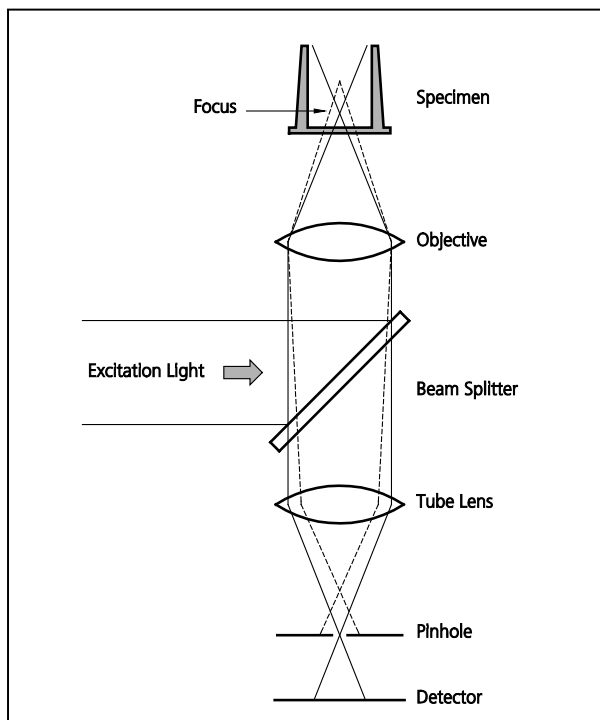
## 2 Hardware Aspects

### 2.1 Principle of Laser Scanning Microscopy

To yield information on their inner structure by conventional transmitted-light microscopy, specimens have to be very thin and translucent; otherwise image definition will be poor. In many cases it is a problem to satisfy these requirements.

The essential considerations have led to trailblazing changes in conventional microscopy and supplied a successful solution of the problem above.

- Unlike the practice of even illumination in conventional microscopy, the LSM technique projects the light of a point light source (a laser) through a high-NA objective onto a certain object plane of interest as a nearly diffraction-limited focus. However, if not for another "trick", the stray light produced outside the object plane, or the fluorescence of fluorescent specimens, would disturb the in-focus image of object point of interest, resulting in a blurred image of poor contrast. The problem therefore is how to capture only the light coming immediately from the object point in focus, while obstructing the light coming from out-of-focus areas of the specimen.



**Fig. 2 Principle of confocal imaging**

deflection system. The detectors - as a rule, photomultipliers - convert the optical information into electric signals. This allows the image of any object plane to be generated and stored within less than a second. By a defined focusing (Z axis) movement it is possible to look at any object plane of interest. By scanning a succession of object planes in a specimen, a stack of slice images can be produced.

This way, the LSM technique in conjunction with ICS optics (Infinity Color-Corrected System) has brought decisive improvements over conventional microscopy in terms of resolving power and confocal depth contrast: Object features in the order of 0.2  $\mu\text{m}$  can be resolved, and height differences of less than 0.1  $\mu\text{m}$  made visible, without the use of interference methods.

- The light reflected, or the fluorescence light produced, at the focus of the high NA-objective is projected onto a variable pinhole diaphragm by the same objective and a tube lens. The focus inside the specimen and the pinhole are situated at optically conjugate points (**Confocal imaging**). The decisive advantage of this arrangement is the fact that essentially no other light than that coming from the object plane of interest can pass the narrow pinhole and be registered by a detector. Unwanted light coming from other specimen areas is focused outside the pinhole, which passes only a small fraction of it. The smaller the pinhole, the less stray light or fluorescence from out-of-focus areas will get on the detector. The image point thus generated is largely free from blur caused by unwanted light.

- In order to obtain an image of the selected object plane as a whole, it is necessary to scan the object plane in a point-by-point, line-by-line raster by means of an XY light



## 2.2 Principle of Fluorescence Correlation Spectroscopy

Fluorescence Correlation Spectroscopy (FCS) analyzes the diffusion time of molecules and their differences if they have bound together. This is done by fluctuation analysis of fluorescence-labeled molecules within a well defined volume element. In most experiments, Brownian motion drives the fluctuation. The volume element is the confocal volume defined by the excitation spot of a well focused laser beam and the selected emission region defined by the properly aligned pinhole of the detection optics (Fig. 2).

As such, the setup is the same as for a Laser-Scanning Microscope (LSM), but in the latter we are not interested in the fluctuations but in the average intensity. As a matter of fact, what is the signal in FCS is noise in the LSM. Since the fluctuations are more pronounced, if fewer molecules are in the volume, FCS requires little molecule numbers (1-10). Whereas LSM is a scanning technique, FCS uses the beam is parked in one spot.

The fluctuations are analyzed by treating the measured photon counts with mathematical methods called correlation functions (Fig. 3). The amplitude of the function is inverse proportional to the molecule number and the decay time gives the residence time of the molecule in the confocal volume and hence its diffusion time. If the two interacting molecules are of different size, only the smaller one has to be labeled using fluorescent dyes. This method is called auto-correlation. In this case the total auto-correlation is the sum of the two different species. If the diffusion constants of both partners are similar, they are both labeled with different dyes and cross-correlation is used. Often, photo physical processes like triplet states impinge on the correlation function, but can be accommodated in the model. Then the total correlation is the product of the single processes.

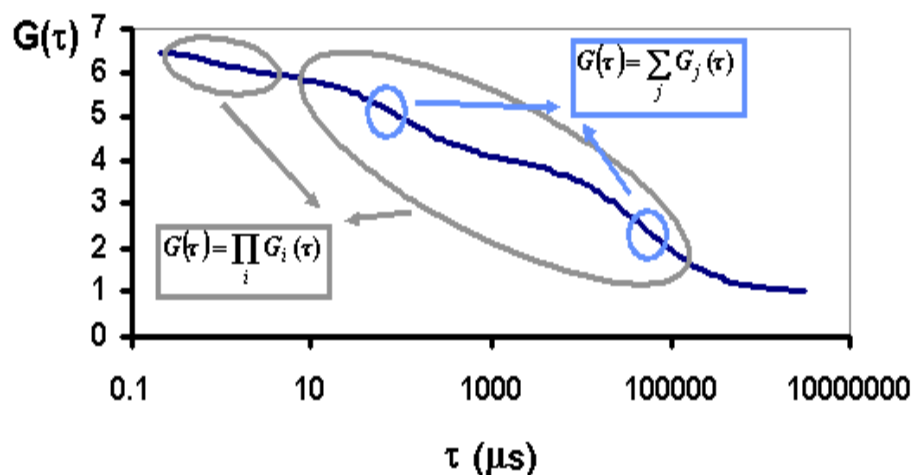


Fig. 3 Correlation functions

Fig. 3 shows a correlation curve for a two component translational diffusion with triplet. The two components can be separated on behalf of their diffusion time (circles). Note that the contribution of the two components adds up, whereas the contribution of the total diffusion process and the triplet multiply to obtain the total correlation.

Because of the tiny size of the confocal volume and its nature, the measurement can be carried out, in principle, in every area that is reachable by light and that is not smaller than an *Escherichia coli* bacterium (approximately 0.2 fl). In particular, measurements can be done inside living cells or on cell membranes. In order to be able to place the measurement volume at its proper place, it is advantageous to combine FCS with powerful light microscopy, particularly a confocal LSM.

## 2.3 Principle of Airyscanning

The Airyscan detector consists of 32 elements based on GaAsP PMT technology with each element detecting the emission signal of a focal spot much smaller than the typical 1 Airy volume.

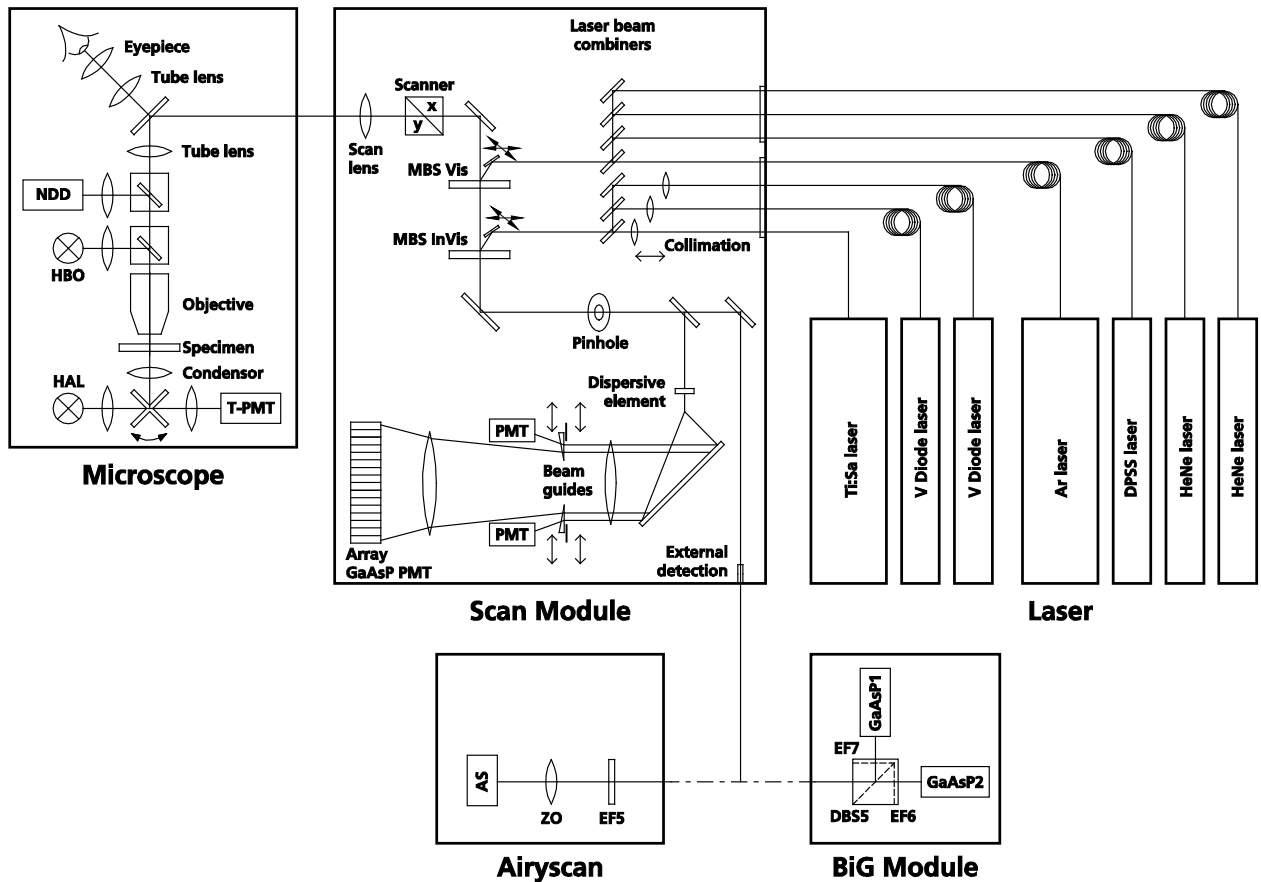
This detection scheme together with adapted deconvolution algorithms allows resolving fluorescently labelled structures to a much higher degree. The resolution reaches 140 nm in x and y and 400 nm along the optical axis.

The emission signal is filtered using standard emission filters.

The detected signal is processed online for immediate judgement of the resulting 2D image. As the detector works along the confocal principle an increase in resolution is achieved in 3D and using standard specimens prepared for confocal imaging.

Another detection mode provides the ability to virtually open or close the pinhole after the image has been acquired. In addition the detector can be used as an additional confocal detector and in combination with other detectors of the system.

2.4 Optical Diagram of the LSM 880 (Schematic)



- |     |                              |       |                              |
|-----|------------------------------|-------|------------------------------|
| AS  | Airyscan detector            | MBS   | Main Beam Splitter           |
| DBS | Dichroic Beam Splitter       | NDD   | Non-Descanned Detector       |
| EF  | Emission Filter              | PMT   | Photomultiplier              |
| HAL | Halogen Lamp                 | T-PMT | Transmission-Photomultiplier |
| HBO | Mercury Vapor Short-Arc Lamp | ZO    | Zoom Optics                  |
| IBF | Infrared Blocking Filter     | GaAsP | Gallium Arsenide Phosphide   |

Fig. 4 Optical path on an inverted microscope, schematic (2 PMT / 32 array configuration)

The diagram above is a schematic representation of the LSM 880 system with attached Airyscan and BiG.2 module.

Laser light is focused onto the specimen through an objective in a diffraction-limited mode. Light emitted at the focal plane and at planes below and above it is directed via an XY scanner onto a main dichroic beam splitter (MDBS), which separates the emissions from the excitation light. In the LSM 880 the fluorescence is either spectrally separated by passing through a grating onto the Quasar detector (3 PMTs or 2 PMTs plus 1 central GaAsP detector) or directed via secondary beam splitters into Airyscan or BiG.2 module. In Airyscan light is filtered by emission filters (EF5) and projected onto the Airyscan detector with its 32 sub-airy detector elements. In the BiG.2 module the light passes through a Push & Click filter cube with a dichroic beam splitter (DBS 6) and two emission filters (EF6 and EF7) onto 2 GaAsP (GaAsP1 and GaAsP2) detectors. The pinhole (VP) blocks all out of focus light, whereas emission filters (EF) are used to select a specific spectrum of the emitted light and to suppress any remaining excitation light. In NLO applications, light can be either directed to the Quasar detector or BiG.2 module (descanned detection) or to NDDs (equipped with either multialkali or GaAsP PMT) in transmission or reflection position (non-descanned detection).

## 2.5 Performance Features of the LSM 880

### Optical and Mechanical Aspects

The highly integrated system design makes for the shortest possible optical paths, top-grade optical precision and high stability. The Airyscan module can be mounted to the LSM 880 scan head of any configuration and with upright or inverted microscopes. The BiG.2 module is either directly attached to the scan head and can be used in combination with upright and inverse microscope stands.

The spectral range available extends from the UV to the IR region.

For the VIS (visible-light) Laser Module, the user can select from up to six lasers with wavelengths of 633, 594, 561, 543, 514, 488, 458 and 405 nm. The UV Laser Module provides wavelengths of 355 nm. Ti:Sa Lasers provide pulsed laser light from 680 to 1300 nm for Multiphoton imaging (NLO). UV and visible lasers are coupled to the scan head via polarization-preserving single-mode optical fibers. Ti:Sa lasers are coupled to the system via free beam coupling kits. One variable beam collimator each for the UV, NLO and visible ranges provides optimum adaptation of the respective laser wavelength to the objective used and, thus, optimum correction for Z aberrations.

Acousto-optical tunable filters (AOTF) adjust the necessary brightness for up to 8 laser lines within microseconds. Ti:Sa lasers are attenuated via AOM within less than a microsecond.

The internal image acquisition channels usable for reflection or fluorescence, and an additional transmitted-light channel are ideal for the investigation of multiple fluorescence specimens. Airyscan and BiG.2 are attached directly to the scan head. Both are equipped with Gallium Arsenide Phosphide detectors (GaAsP). The diameter of the pinhole and the XY positions can be optimized, and the desired emission can be selected. This adjustment also includes positioning along Z. For the simultaneous registration of multiple fluorescence signals, identical optical sections can be obtained in each confocal channel.

The microscope's transmitted-light channel is equipped with a photomultiplier, too. It is therefore possible to superimpose a multiple fluorescence image on a brightfield, differential interference or phase image.

Airyscan is equipped with a filter wheel consisting of 8 positions of which 6 are used for specific double band pass emission filters. BiG.2 dichroics and emission filters are housed in push & click filter cubes which are exchanged manually.

The high-NA C-APOCHROMAT objectives specially developed for the LSM technique reach the physical limit in resolving power, and can be used throughout the 380...900 nm spectral range with the same high quality, producing brilliant images. Note, for fluorescence correlation spectroscopy the C-APOCHROMAT objectives are highly recommended.

A two-mirror scanner system, controlled by real time electronics, offers several advantages. The large deflection angle of the scanning mirrors allows a wide area to be scanned. With a 1.25× objective, the object area scanned is 11 × 11 mm<sup>2</sup>. The scanning field size can be freely selected between 4 × 1 and 8192 × 8192 pixels.

It is possible to rotate the XY scanning field through 360° and carry out XY scans without having to rotate the specimen itself under laser radiation load.

For FCS operation all detectors able to count photons can be used for FCS. These are GaAsP PMTs of the array detector, BiG.2 and the cooled multi-alkali PMT in the red spectral range. Multi-alkali PMTs of the three channel configuration without GaAsP PMTs or NDDs cannot be used for FCS.

Selection of the specimen detail of interest for zooming is fast and convenient, and the zoomed image is automatically centered. This saves the job of specimen centration with the microscope stage.

Bi-directional scanning doubles the scanning rate to a maximum of 13 frames/sec (at 512 × 512 pixels). Two fluorescent dyes can be viewed and documented in a quasi-simultaneous mode when using two different laser wavelengths for bi-directional scanning. This will prevent cross talk between detection channels.

---

## 2.6 Microscope Equipment of the LSM 880

LSM 880 is attached to either the rear port or side port of the inverted microscope Axio Observer.Z1 or to the upright microscopes Axio Imager.Z2 or Axio Examiner.Z1.

Only the differences from the delivered operating manual "Axio Observer.Z1" will be explained here.

### (1) Stand

- The motorized objective nosepiece 5× H DIC is firmly fixed to the stand, where no operating elements can be found for the nosepiece. Operation will be performed via LSM software control. The "Restriction of the nosepiece height to protect the objectives during motorized objective change" is not activated. The nosepiece will be moved down automatically before each motorized objective change.
- The reflector mount is motorized and provided with the Axio Observer.Z1 reflector turret. The reflector turret has six positions: One transmitting light position, which is identical to the LSM position, and five other positions for fluorescence filter sets (reflector modules). If you want to use more than five conventional fluorescence filter sets, it is advisable to use a further reflector turret. When changing the reflector turret position, make sure that the turret will click into position, since otherwise the image area will be cut.
- The stand has a motorized focusing drive (fine & coarse). Sensitivity of the focusing drive is adjusted to the delivered objectives by the manufacturer. If you want to use other objectives, sensitivity and parfocality can be adjusted via the **AxioSet** program.
- The stand features an integrated power supply for the internal motors and stand electronics. The power supply can be switched at the external power supply unit for the microscope. External power supply units will be used for the mercury vapor short arc lamp or the X-Cite 120 fiber coupled lamp.
- The analyzer slider for conventional DIC methods will be operated from the right side and is located just below the nosepiece.
- When the rod is pushed in, the analyzer is located in the beam path. In the LSM-mode, remove the analyzer from the beam path by pulling out the analyzer rod.

### (2) Specimen stages and fine focus drives

- Mechanical stage - The stage with coaxial drive must be mounted on the right side of the stand.
- Scanning stage
- Piezo objective focus drive

**(3) Transmitted-light illumination**

- The illuminator support contains a security circuit which activates a shutter preventing laser light from reaching the stand when the support is moved to the back. A complementary shutter built in the stand prevents laser light from reaching the eyepieces during the scanning mode.
- The illuminator support is equipped with a rotary polarizer. The Axio Observer.Z1 description contains the adjustment for the DIC mode during conventional observation.
- For scanning in transmitted-light DIC mode, the polarizer in the transmitted light support works like an analyzer and must be adjusted in such a manner that direct laser light will be blocked.
- The conventional analyzer slider in the stand must not be located in the beam path because the laser light is already polarized.
- A fully motorized, LSM software-controlled switching mirror is mounted on the illuminator support. Alternatively, the light is directed to the LSM transmitted-light detector or enables conventional transmitted-light observation.
- The focusing screen for conventional transmitted-light is located in a support in front of the halogen lamp housing.
- Further information on the halogen lamp and the condensers is provided in the Axio Observer.Z1 operating manual.

**(4) Reflected light fluorescence**

With the exception of the reflector slider, all the Axio Observer.Z1 fluorescence accessories can be used. Further information is provided in the Axio Observer.Z1 operation manual.

**(5) Imaging optics**

Optovar sliders cannot be used.

The analyzer for the conventional DIC mode will be operated from the right side and is located just below the nosepiece.

Use of sliders with auxiliary objects is not possible.

**(6) Photo equipment**

The stand does not feature an integrated SLR-port, but microscope cameras as described in the Axio Observer.Z1 and LSM 880 NLO operation manuals can be used.

**(7) Camera adaptation**

The camera port at the side or the front can be used as described in the Axio Observer.Z1 operation manual.

The camera interface side port can be used with camera adapters 60 N or LSM adapters.

## 2.7 Computer Hardware and Software

The LSM 880 (NLO) Airyscan / BiG.2 are controlled via a standard high-end Pentium / Xeon PC. Linking to the electronic control system is made via Gigabit Ethernet interface. The PC comes with the WINDOWS operating system.

The instrument is fully motorized, permitting fast change-over between methods as well as automatic operation. Parameters once set or complex examination sequences once established can be saved and reproduced; therefore, complete application programs can be loaded and performed by pushbutton control.

The software of the LSM 880 (NLO) and Airyscan / BiG runs on the ZEN platform.

Conversion of the light signals into a digital image is effected by means of four 12-bit A/D converters; each of it can generate 4096 brightness levels.

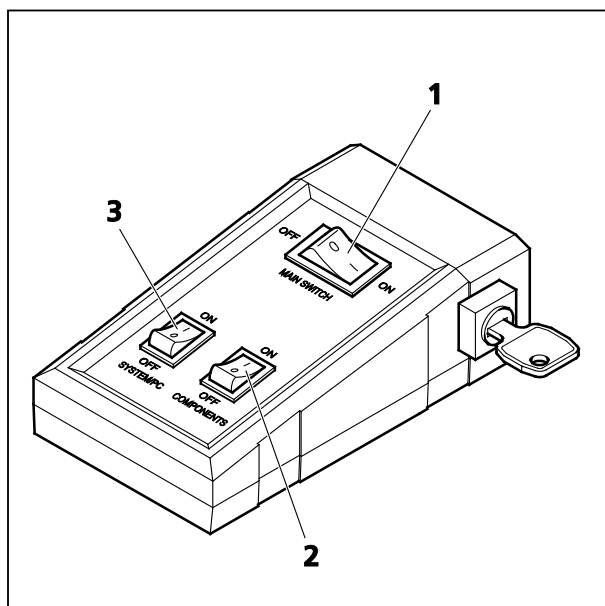
The software provides an enormously wide range of image processing functions, including all standard 2D / 3D (stereo, projection) functions identical to sophisticated 3D reconstruction capabilities (surface and alpha rendering) and digital processing of voxels.

## 3 Startup and Shutdown of the System

### 3.1 Startup of the System

The LSM system is equipped with a main power switch and two further switches labeled **System/PC** and **Components** that are located at the front of the System Electronic Rack. The main switch has to be set to **ON** to be able to switch the system on and off using the **System/PC** and **Components** switches. The main switch can be used to switch off the complete system with one switch only. The electronics to run the computer and the microscope are switched on with the **System/PC** switch. The laser module and the scan head are switched on with the **Components** switch. These switches are also accessible via the power remote witch (Fig. 5).

Refer to the operating manual and CHAPTER 4: ANNEX for handling of any Titanium-Sapphire-Laser used for Multiphoton (NLO) Microscopy.



- 1 Main switch ON/OFF
- 2 COMPONENTS switch ON/OFF
- 3 SYSTEM PC switch ON/OFF

**Fig. 5 Power remote switch**

#### 3.1.1 The Power Remote Switch

- To start the system switch the main switch (Fig. 5/1) to **ON**.
- When set to **ON** the power remote switch labeled **System/PC** (Fig. 5/3) provides power to the computer. This allows using the computer and ZEN software offline.



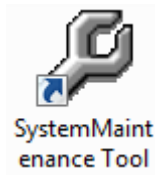
The drives for floppy discs and CD/DVD of the computer must not contain any data storage item.

- After switching on the computer type in the user name and password to log on to the computer.
- After entries, confirm by clicking the **OK** button or **Enter**.
  - The WINDOWS operating system desktop appears on the screen, showing a number of icons.

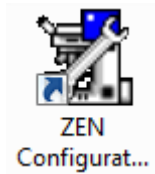
After complete startup, the computer is ready for the components start.

- To switch on the system completely put the **Components** switch (Fig. 5/2) also to **ON**. Now the complete system is ready to be initialized with the LSM Software.



**System Maintenance Tool** icon

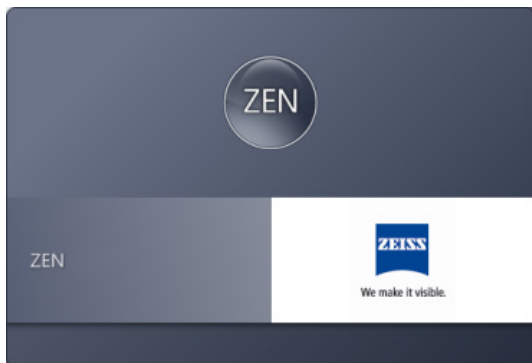
With a calibration objective and correct system configuration, the maintenance tool allows convenient self adjustment of the LSM 880 systems. The optical beam path, relative pinhole position and scanner adjustment can be set and checked automatically on the systems.

**ZEN Configuration Tool** icon

The **Configuration Tool** permits a new or updated database to be assigned to the LSM software program. This function should preferably be performed by authorized service personnel. See printed manual CHAPTER 3: ADDITIONAL SOFTWARE TOOLS.

**ZEN** icon

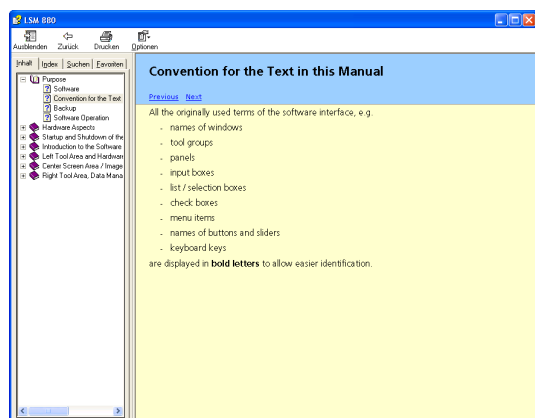
Start ZEN software for operating the LSM laser scanning microscope.



**Fig. 6 Starting the ZEN software – The Loading "ZEN" window**



**Fig. 7 Starting the ZEN software – The Login "ZEN" dialog**



**Fig. 8 The Help menu dialog**

### 3.1.2 Starting ZEN

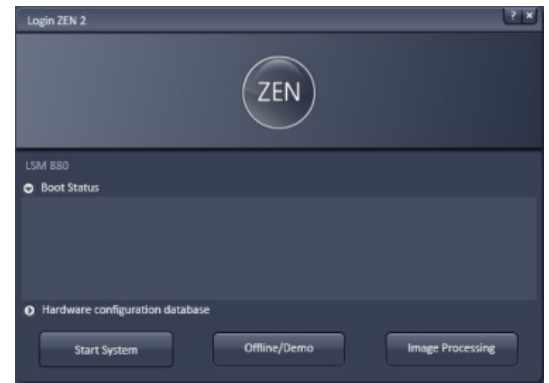
- To start the software double click the **ZEN** icon on your desktop!
  - During loading the program the **ZEN Access** window will appear (Fig. 6). It displays the ZEN symbol in the upper part, the designation of the current ZEN software version (lower left) and the Zeiss icon (lower right).
  - Once the program is loaded the **Login ZEN** dialog will appear (Fig. 7) in front of the ZEN interface. The number after ZEN designates the current version.
- By pressing the **?** (question mark) symbol, the context sensitive **Help menu** will appear (Fig. 8). Close the menu with the Windows commands if you do not want to search the help database by pressing the **x** (cross) symbol.
- Pressing the **x** (cross) symbol, the **Login ZEN** dialog will be closed and the ZEN software will not be started.

The **Login ZEN** dialog allows you to boot the Software in different modes. If the **Boot Status** is closed, the options are **Start System** and **Image Processing**.

A third option, **Offline/Demo**, becomes available (Fig. 9), once the **Boot Status** field is expanded by pressing the **expansion** symbol (triangle).

You can collapse the field by pressing the expansion symbol again. Select:

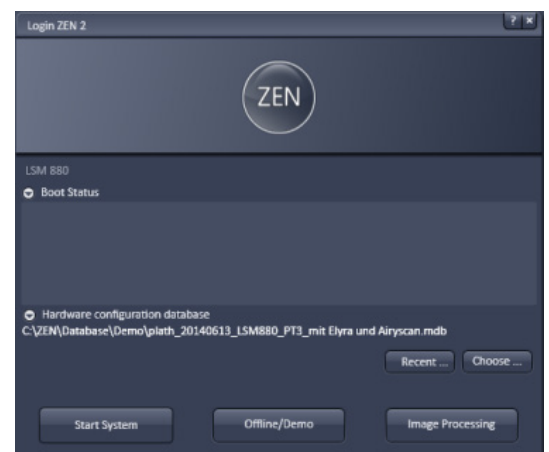
- **Start System** for system control, data / image acquisition / recording and analysis. The whole microscope system will be initialized. The progress of the boot process will be displayed by the blue time tab. During booting the status of the system will be displayed in the **Boot Status** window and the single components will be listed which have been or are currently being checked during the boot process (Fig. 9).
- **Offline/Demo** for data analysis and simulation. **Offline/Demo** reads the active hardware database and simulates the respective hardware. This button is only available after opening the **Boot Status** display by clicking the little arrow left of the text "Boot Status" This option should be chosen when working at an offline station and if you want to test functionalities of the system. The progress of the boot process will be displayed by the blue time tab. The single components will be listed, which are checked during the boot process. Note that the software will not control the hardware in this mode.
- **Image Processing** for data analysis only. This mode ignores the hardware and activates only data handling and image processing functionality to analyze stored images. Note that only those software tools will be displayed that are needed for processing and analysis of the data. No hardware control tools will be shown.
- **Cancel** to abort the booting process and to leave the dialog. Note that the **Cancel** button will appear in the place of the **Image processing** button only if **Start System** or **Offline/Demo** was selected (Fig. 10).
- You can leave the software by choosing the **File** menu from the main tool area and selecting **Exit**.
- You can select a database before booting, if you wish to change the current one. To change the database open the **Hardware configuration database** expansion field (Fig. 11). The expansion field displays the currently loaded database and its location on the hard disc.



**Fig. 9** Starting the ZEN software – The Login "ZEN" dialog with **Boot Status** field expanded



**Fig. 10** Starting the ZEN software – The Login "ZEN" dialog with **Boot Status** field expanded and during the process of booting



**Fig. 11** Hardware configuration database - The Login "ZEN" dialog allows you to boot the Software in different modes. If the **Boot Status** is closed, the options are **Start System** and **Image Processing**.

- If **Recent...** is pressed the last couple of databases that were in use will be displayed (Fig. 12). Click on the one you want to select. By pressing the **Choose...** button Windows Explorer will open. Search for the folder file the database is stored and open it. Select it for use. Select a database suited for your purpose from the Explorer window.
- You can also change the database after having booted the system. To this end choose from the **File** menu of the main tool area **Login...** and the **Login Zen** dialog will appear. Select the database by pressing **Choose...** or **Recent...** and the system restarts.



Fig. 12 Recent databases

### 3.2 Shutdown Procedure



Never shut down the computer by its main switch while the ZEN software is still active, or else you will lose the currently set operating parameters and the images just scanned.



In the **Maintain** tab / **System Options** dialog window, activate **Laser off** on **Exit** in the **Shutdown** tab (section **Options – System Options**). The Argon laser and Ti:Sa lasers will automatically be switched off when you exit the LSM program.

#### 3.2.1 Exiting ZEN Software

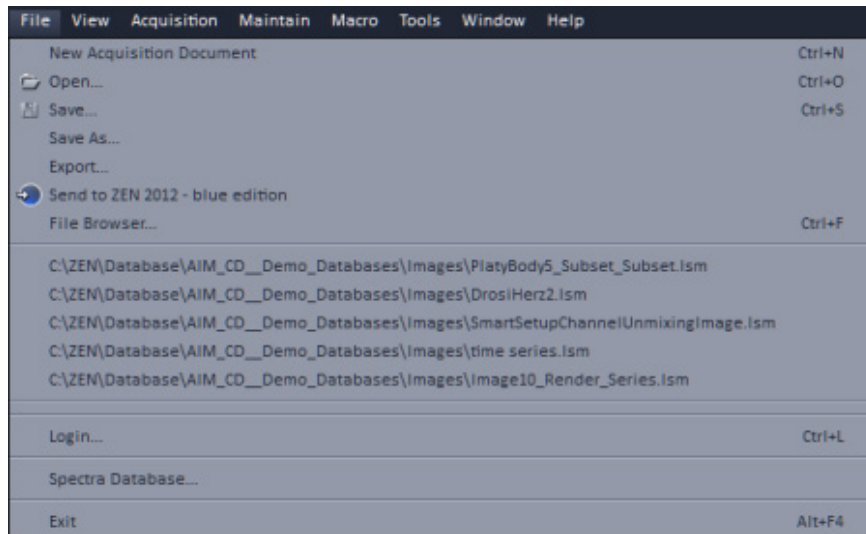
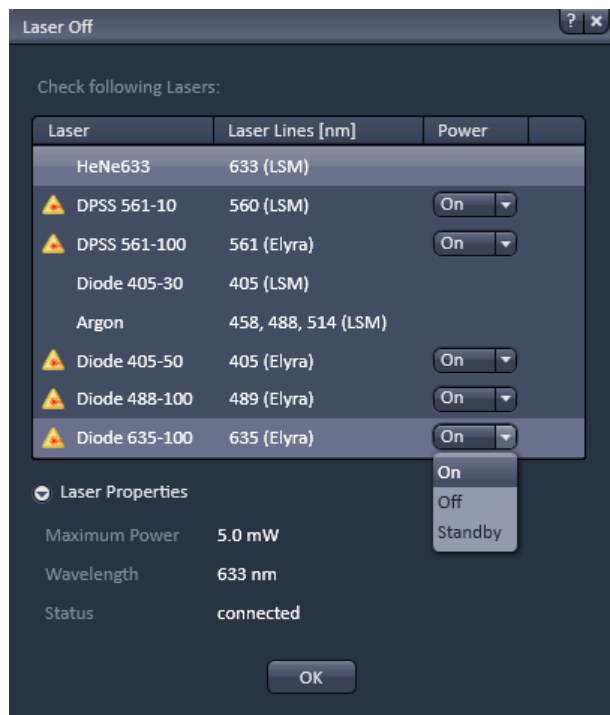


Fig. 13 Exit in the File menu



**Fig. 14** Laser Off dialog box

The Software can be shut down from **File** menu of the Main toolbar by selecting **Exit** (Fig. 13) or by pressing the **Window Close** button (symbolized by a cross) of the ZEN window.

If in **Maintain** tab in the **LSM Options** dialog window the box **Laser off on Exit** in the **Hardware** tab is ticked, the lasers will be automatically switched off when exiting the ZEN program.

If the box is not ticked, the **Laser Off** dialog box will appear that allows one to check on the listed lasers (Fig. 14).

By the **Power** drop down menu, if available, the laser can be left **On**, put in **Standby** or turned **Off**. Those lasers, for which no **Power** drop down menu is available, are switched off automatically when not in use. By expanding the Laser properties field you can see the current status of the selected laser. Press **Ok** after having made the desired changes to exit the ZEN software.

---

### 3.2.2 Switching System Power Off

After having exited the ZEN software, you may turn off the whole system with the following **Shutdown** procedure.

- Make sure you have saved all your image data.
- Switch of all the lasers which might still be running.
- Close the ZEN software window. This terminates the ZEN software.
- Shut down WINDOWS.
- About 20 seconds after WINDOWS is shut down your computer turns off.



Please bear in mind that a cooling phase of at least 5 minutes is required between switching off of the Argon laser and switching off of the entire system via the power remote switch or the Power Supply switch.



**5 minutes after computer shutdown** set the power remote switches **System/PC** and **Components** or the **Main** switch on the System Electronic Rack to position **OFF**. This puts your LSM 880 including the computer off power.

## 4 Introduction to the Software Application Layout

### 4.1 Overview on the Screen Layout

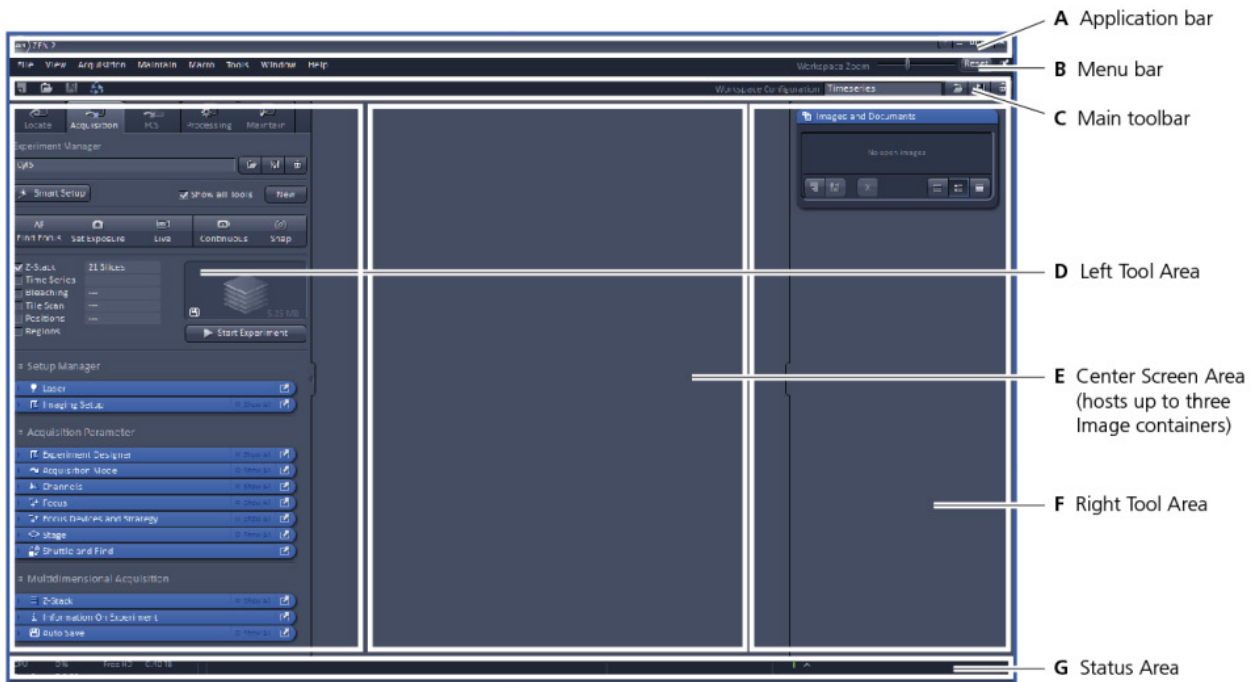


Fig. 15 ZEN Main Application window after Startup with empty image container

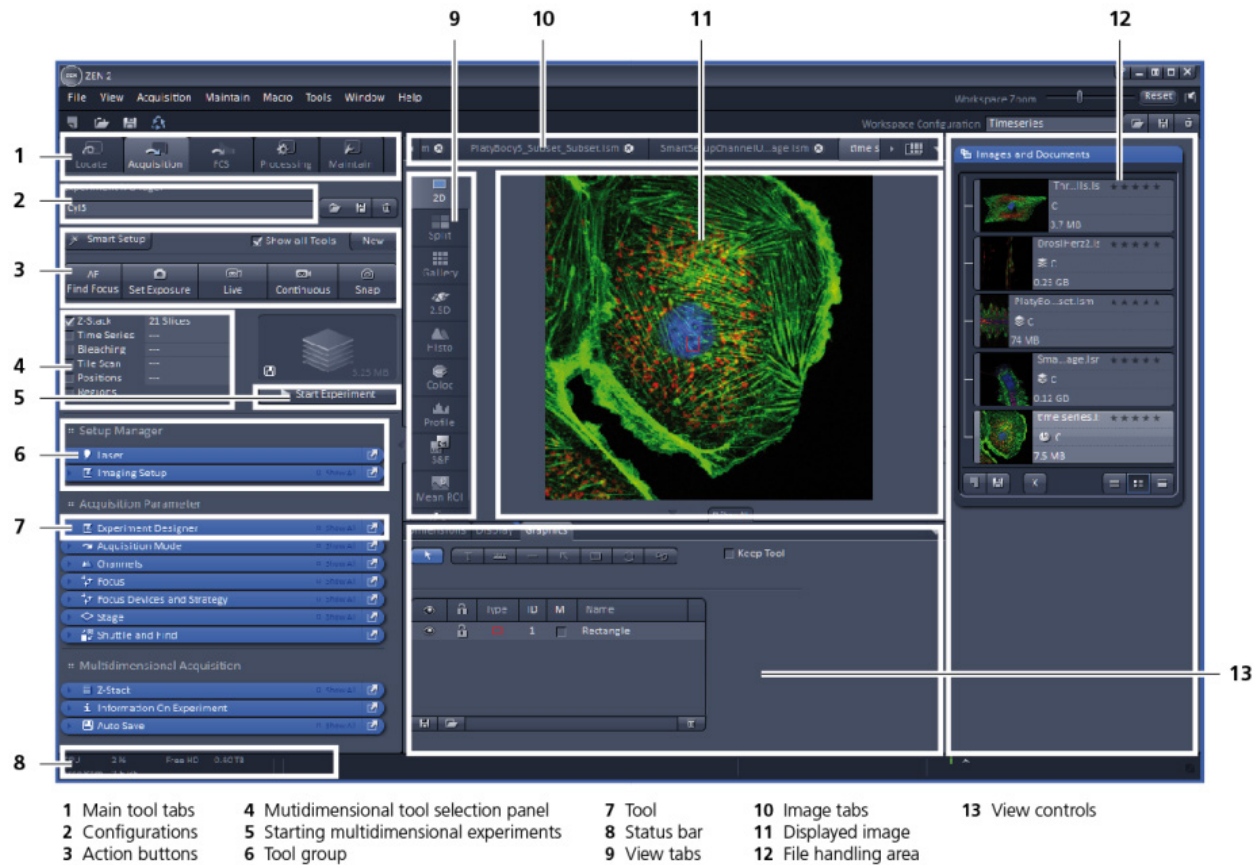


Fig. 16 ZEN Main Application window after Startup with several images loaded



---

## 4.2 Introduction to ZEN

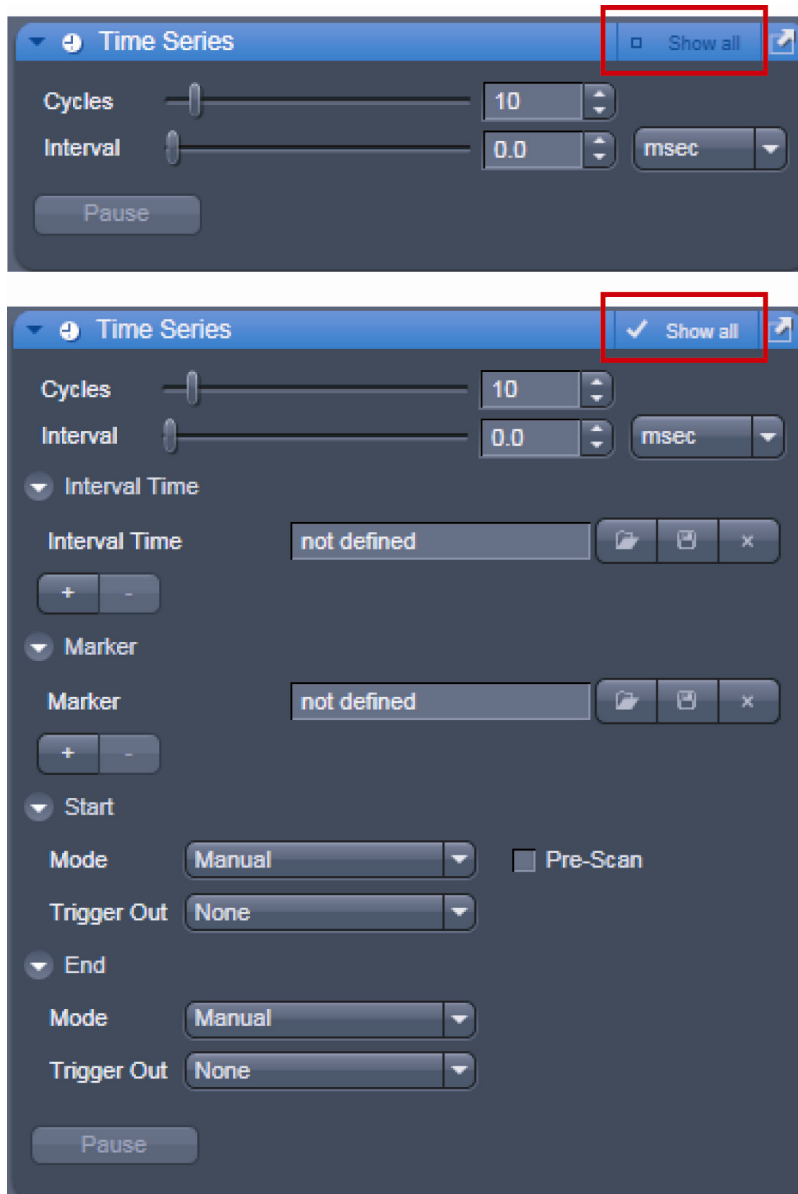
**ZEN - Efficient Navigation** - is the new software for the LSM Family from ZEISS. With the launch of this software in 2007 ZEISS sets new standards in application-friendly software for Laser Scanning Microscopy.

The ZEN Interface is clearly structured and follows the typical workflow of the experiments performed with confocal microscopy systems:

On the **Left Tool Area** (Fig. 15/D) the user finds the tools for image acquisition, image processing and system maintenance, easily accessible via the **Main** tabs (Fig. 16/1). All functions needed to control the microscope can be found on the **Locate** tab, to acquire images use the **Acquisition** tools (Fig. 16/3 and 4). Arranged from top to bottom they follow the logic of the experimental workflow. The area for viewing and interacting with images is centered in the middle of the **Main Application** window: the **Center Screen Area**. Each displayed image can be displayed and/or analyzed with many view options available through "view tabs" which can be found on the left side of the image. According to the chosen view tab, the required view controls appear in View control blocks below each image. File management and data handling tools are found in the **Right Tool Area** (see Fig. 15 and Fig. 16).

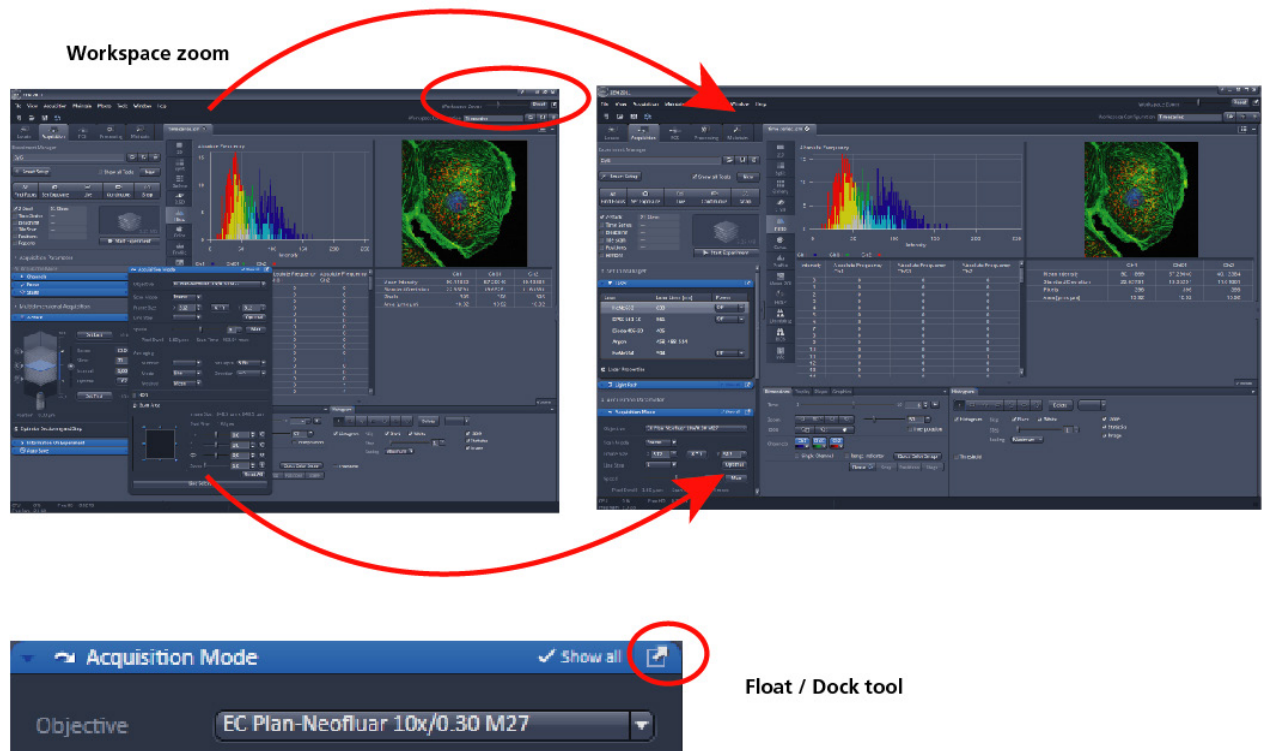
Color and brightness of the interface have been carefully adjusted to the typical light conditions of the imaging laboratory, guaranteeing optimal display contrast and minimal stray light for high-sensitivity detection experiments. The **ZEN** software is optimized for a 30" TFT monitor but can also be used with dual-20" TFT setups.

A focus in the development of **ZEN** was to fulfill the needs of both basic users and microscopy specialists. Both types of users will appreciate the set of intuitive tools designed to make the use of a confocal microscope from ZEISS easy and fast:



**Fig. 17 Show all mode**

The **Show all** concept ensures that tool panels are never more complex than needed. In the basic mode of the tools **Show all** is deactivated and the tools show only the most relevant functions, covering approximately 80 % of the application. For each tool, the user can activate **Show all** to display and use additional functionality (Fig. 17).

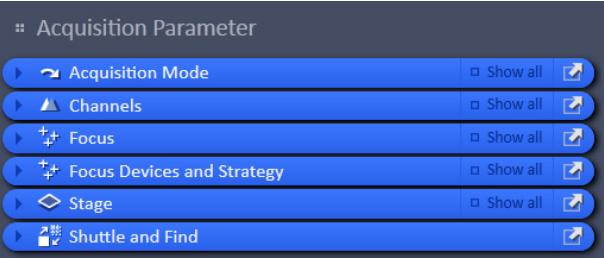
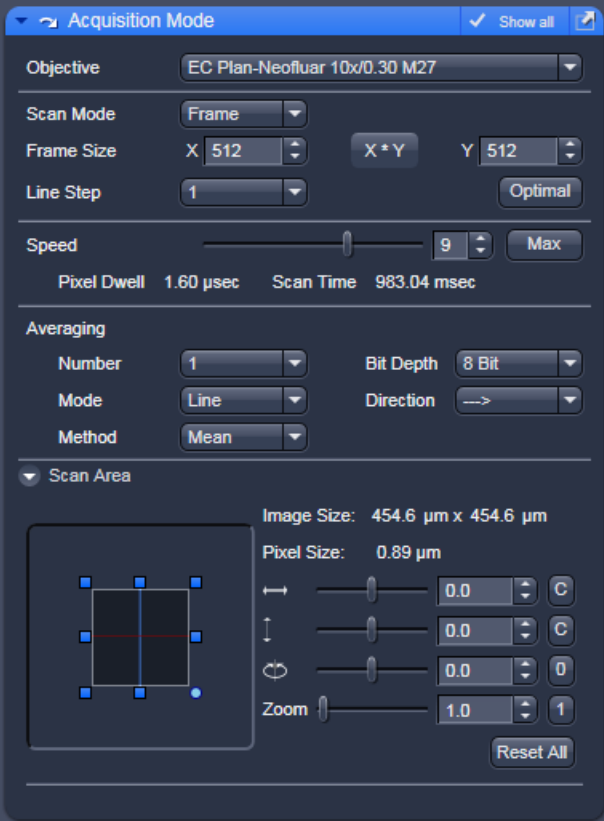
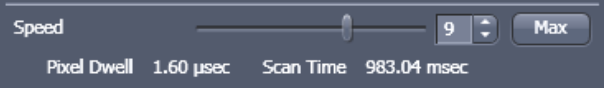
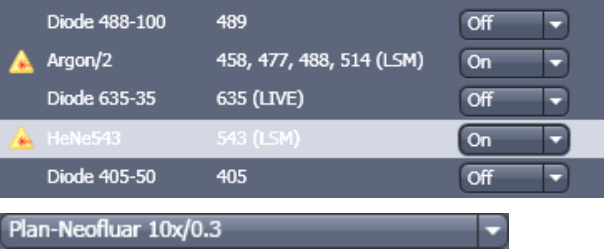




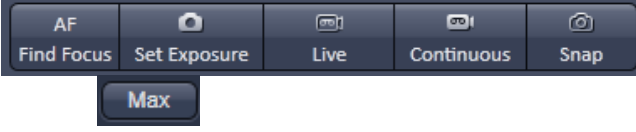



**Fig. 18 ZEN window Layout configuration**

More features of **ZEN** include:

- The user can add more columns to the **Left Tool Area** or detach individual tools to position them anywhere on the monitor. To add a column, drag a **tool group** by the title bar (e.g. "Acquisition Parameter") to the right and a new tool column automatically opens. To detach a tool, click on the little icon on the very right end of the blue tool header bar or drag it by this blue header bar to where you want it (Fig. 18).
- Another feature is the scalable ZEN interface. This **Workspace Zoom** allows adjustment of the **ZEN** window size and fonts to the situational needs or your personal preferences (Fig. 18).
- Setting up conventional confocal software for a specific experiment can take a long time and is often tedious to repeat. With ZEN these adjustments have to be done only once – and may be restored with just two clicks of the mouse. For each type of experiment one can now set-up and save the suitable **Workspace Layout**. These configurations can also be shared between users.
- For most controls, buttons and sliders, a **tool tip** is available. When the mouse pointer is kept over the button, a small pop up-window will display which function is covered by this tool/button.





### 4.3 Function Elements

Function element	Description / Explanation
	<p>Tool group</p>
	<p>Tool (closed) or tool window (opened)</p>
	<p>Panel (e.g.: <b>Speed</b> panel)</p> <ul style="list-style-type: none"> <li>- Field with a subset of tools of a tool window</li> </ul>
	<p>List box or selection box</p> <ul style="list-style-type: none"> <li>- Selection of one of the displayed options via a mouse click. The selected option is highlighted.</li> <li>- Open the box by clicking on the arrow button.</li> </ul>
	<p>Input box with arrows ("spin box")</p> <ul style="list-style-type: none"> <li>- Input of text or numeric values via the keyboard or using the arrows.</li> </ul>

	<p>Slider with input ("spin") box and arrows</p> <ul style="list-style-type: none"> <li>- Setting of numbers in the relevant input box by moving the slider or clicking on the arrow buttons or clicking on the slider and moving via the arrow keys of the keyboard. Press the <b>Shift</b> or <b>Ctrl</b> key while clicking on the arrow button to change the numeric values in coarse or fine steps.</li> </ul>
	<p>Button</p> <ul style="list-style-type: none"> <li>- Selection / performance of a function via mouse click.</li> </ul>
	<p>Tab</p> <ul style="list-style-type: none"> <li>- Selection of functions of a tab via mouse click (e.g.: <b>Dimensions</b> or <b>Display</b> tab).</li> </ul>
	<p>Load – Save – Delete</p> <ul style="list-style-type: none"> <li>- Buttons to load, save or delete a configuration, overlay set, track setting etc.</li> </ul>
	<p>New – Save – Close</p> <ul style="list-style-type: none"> <li>- Buttons to open a new acquisition document, save an image document or close it.</li> </ul>

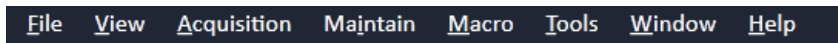
## 4.4 Application Bar

The application bar includes the following control elements of the ZEN software application window:

-  Starts the online help
-  Minimizes the application window
-  Switches between maximized-window mode and compressed-window mode
-  Closes the window

## 4.5 Menu Bar

The menu bar contains the menu items and the controls for the **Workspace Zoom**, including the **Reset** button for the **Workspace Zoom** and the button to re-dock all free floating tools to the **Left Tool Area**.



**Fig. 19** Menu bar, left side

The menu functions are shown in the following menu overview (see next page).

Workspace Zoom

Moving the slider to left or right, changes the display size of the Left/Right Tool Area and the Center Screen Area.

Clicking the **Reset** button, sets the standard zoom factor for all areas.





**Fig. 20** Menu bar, right side

Clicking on  moves all undocked tools back to the **Left Tool Area** (see also section **Tool Groups and Tools**).

**Menu overview**

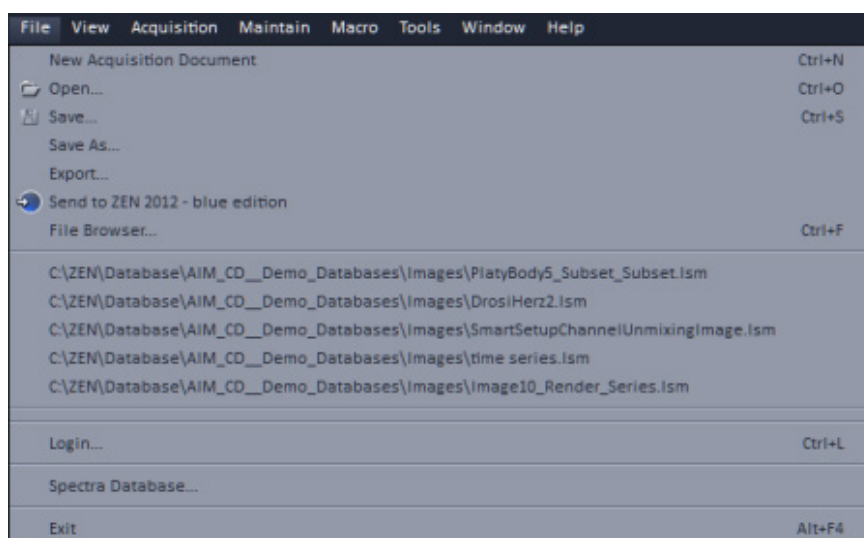
<p><b>File</b></p> <p><b>New Acquisition Document</b> Opens a new and empty image document.</p>	<p><b>View</b></p> <p><b>Text View</b> Displays the image tabs with text only.</p>	<p><b>Acquisition</b></p> <p><b>New Acquisition Document</b> Opens a new and empty image document.</p>	<p><b>Maintain</b></p> <p><b>Set Spline</b> Opens a dialog for setting the parameters.</p>	<p><b>Macro</b></p> <p><b>Macro</b> Opens the Macro Control window for creating, loading or handling macros.</p>	<p><b>Tools</b></p> <p><b>Paste Image</b> Pastes an image from clipboard for saving.</p>	<p><b>Window</b></p> <p><b>Close</b> Closes the active window.</p>
<p><b>Open...</b> Opens an existing document in the active image container.</p>	<p><b>Small Thumbnail View</b> Displays the image tabs with small thumbnails.</p>	<p><b>Set Exposure</b> Starts the Find procedure. This balances Gain settings.</p>	<p><b>Camera</b> Opens the Camera Color Adjustment tool.</p>	<p><b>Visual Macro Editor</b> Opens the Visual Macro Editor.</p>		<p><b>Close All</b> Closes all windows, a separate save dialog will be displayed if images have not been saved.</p>
<p><b>Save...</b> Saves the active document.</p>	<p><b>Large Thumbnail View</b> Displays the image tabs with large thumbnails.</p>	<p><b>Find Focus</b> Starts the auto focus. A Line / Z Scan is performed and the focus position is determined upon the contrast values.</p>	<p><b>Hardware Administrator</b> For service only.</p>			<p><b>Help</b></p> <p><b>Help</b> Opens the ZEN help.</p>
<p><b>Save As...</b> Saves the selected image with entering new formats.</p>	<p><b>1 Container</b> Sets ZEN to work only with one image container.</p>	<p><b>Live</b> Starts the fast scanning procedure, scans with lower resolution and higher speed.</p>	<p><b>Test grid</b> For service only.</p>			<p><b>About</b> Opens a panel with information about the ZEN release.</p>
<p><b>Export...</b> Exports the currently active document using various image formats.</p>	<p><b>2 Containers</b> Sets ZEN to work with two image containers.</p>	<p><b>Continuous</b> Scans an image continuously with the currently active scanning parameters.</p>				
<p><b>Send to ZEN 2012 - blue edition</b> Sends the currently active document to ZEN blue edition.</p>	<p><b>3 Containers</b> Sets ZEN to work with three image containers.</p>	<p><b>Snap</b> Scans one single image.</p>				
<p><b>File browser...</b> Opens a document containing a ZEN File Browser.</p>	<p><b>Automatically layout container</b> The size of the containers is automatically adjusted depending on the screen space available.</p>	<p><b>Starts Experiment</b> Starts a multidimensional experiment (Z, T, ...).</p>				
<p><b>Open containing folder</b> Opens the folder, where the image file is saved.</p>	<p><b>Shared view Controls</b> Shares the view controls below the images between containers.</p>	<p><b>Stop</b> Stops the scanning immediately.</p>				
<p><b>Login...</b> Opens the Login ZEN dialog to change the software operation mode.</p>	<p><b>Separate view Controls</b> Each container is displayed with a separate view control panel.</p>					
<p><b>Spectra Database...</b> Opens the Spectra Database.</p>	<p><b>"Show all" (global)</b> Sets all windows, tools, and control panels to "Show all", all controls are always visible in all tools.</p>					
<p><b>Exit</b> Closes the ZEN software.</p>						

 For detailed information about the image acquisition functions see section **Acquisition Tab**.

 The functionalities of the **Macro** menu are described in CHAPTER 2: MACROS AND VISUAL BASIC.

#### 4.5.1 File

- In the menu bar, click on **File**.
  - This displays the menu shown in Fig. 21.



**Fig. 21 File menu**

The items in this list reflect the standard windows files menus with the following exceptions:

- **File Browser** will open a ZEN File Browser in the currently active container (see section **ZEN File Browser**).
- In the second group of entries in the list, the five last accessed files are listed. Selecting a list entry will open the respective file.
- In the third group of entries, the four last accessed folders are listed. Selecting a list entry will open the ZEN File Browser and display the image files which are present in the folder.
- **Login** displays the **Login screen** and permits to change the operation mode of ZEN, e.g. from **Online** (with hardware started) to **Offline** (Image Processing or Demo mode), without quitting ZEN.
- **Spectra database** is starting the dialog used to handle previously recorded reference spectra.

 See also section **Right Tool Area, Data Management and Storage** for image file handling.



## 4.5.2 Maintain

The **Maintain** menu from the Menu bar contains additional modules to check and guarantee the interference-free operation of all the software and hardware components of the LSM 710 and LSM 780 systems. In the **Menu** bar, click **Maintain**. This opens the Maintain list (Fig. 22).

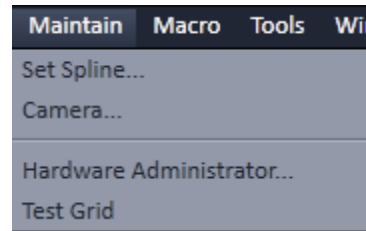


Fig. 22 Maintain list

The maintain list is bipartite. On upper section lists user accessible tools, the lower section lists tools reserved for service personnel, they are password protected.



See also section **Maintain Tab** for further information.

### 4.5.2.1 Set Spline

This function permits calibration of the Scanner position signals. This is required for the use of spline curves in the **Line** scanning mode.

- Click on **Set Spline** in the **Maintain** list.
  - The **Spline** window appears on the screen (see Fig. 23).
- You can set the required **Amplitude X**, **Amplitude Y**, **Offset X** and **Offset Y** values by using the sliders.
- Click the **Close** button to leave the window.

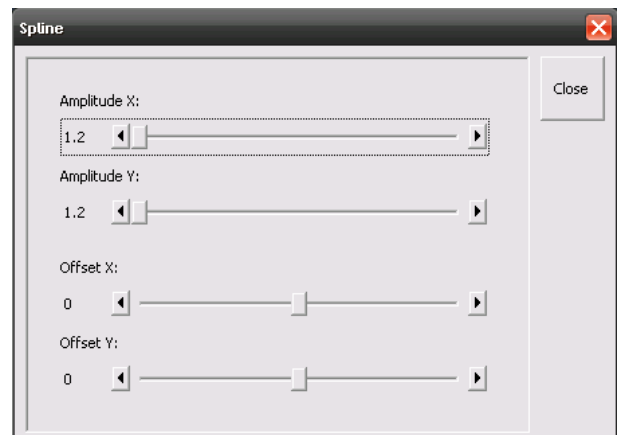


Fig. 23 Spline window

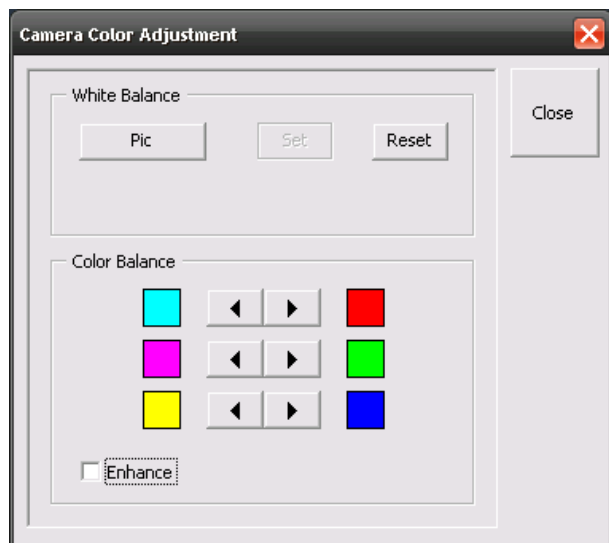


Fig. 24 Camera Color Adjustment window

#### 4.5.2.2 Camera

This function allows the user to adjust the white balance and color balance of a connected camera.

- Click on **Camera** in the **Maintain** list.
  - The **Camera Color Adjustment** window appears on the screen (see Fig. 24).

Clicking the **Pic** button allows to set the white balance using the mouse cursor in the camera image. The **Set** button will become active. Press set to store new settings, press **Reset** to return to the old settings.

Use the arrow buttons to adjust the color balance of the camera.

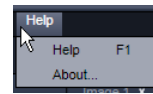
#### 4.5.2.3 Hardware Administrator

The **Hardware Administrator** function is for servicing purposes and may only be used by authorized service personnel. Its access is therefore password-protected.

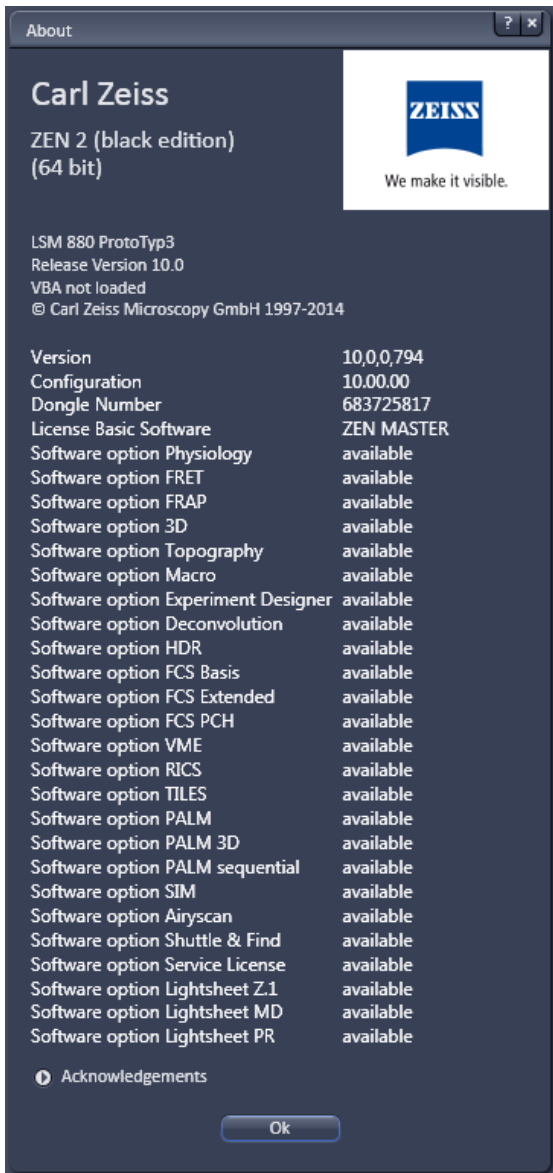
#### 4.5.2.4 Test Grid

The **TestGrid** function is for servicing purposes only and may only be performed by authorized personnel. Its access is therefore password-protected.

### 4.5.3 Help – About



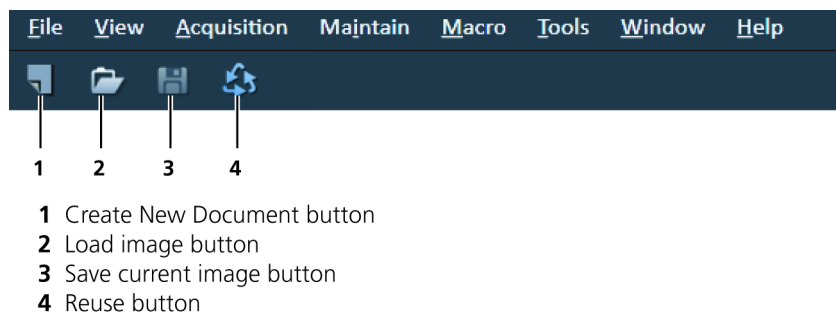
The **About** window can be accessed via the Help item in the menu bar clicking **About** opens the following dialog:



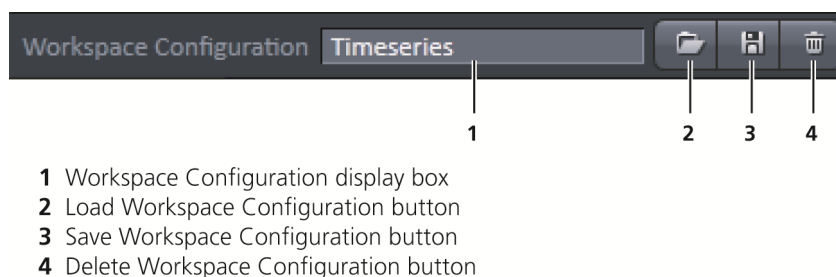
**Fig. 25 About window**

The panel hosts important information about the software version number, the license number and the available software modules.

## 4.6 Main Toolbar




**Fig. 26** Main toolbar, left side

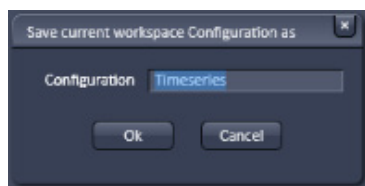


**Fig. 27** Main toolbar, right side

### Workspace Configuration

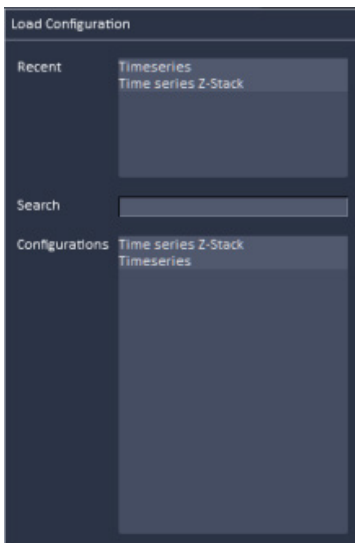
This function allows loading, saving or deleting a workspace configuration. These workspace configurations are saved settings that allow to restore a pre-defined layout of the whole ZEN application window, including status, size and position of tools and windows, workspace zoom, number of tool columns.

- To save a workspace configuration, click on the  button, the following dialog will appear:



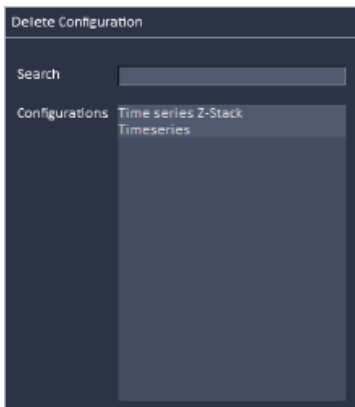
The name of the workspace configuration can be entered. Clicking **OK** saves the configuration.

- To load a workspace configuration, click on the  button. The following list box will appear:

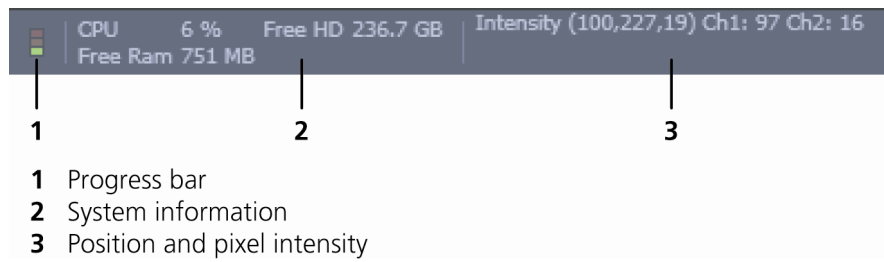


Selecting one of the list entries will load the respective configuration.

- To delete a workspace configuration, click on the  button. The configuration to be deleted can be selected from a list.



## 4.7 Status Bar



**Fig. 28** Status bar

### Progress bar

Shows an overview of all running processes. If only one process is running the details of this one are shown. If more than one process is running then the single process information will be shown in the gallery.



**Fig. 29** Progress bar

### System information

Shows information of the currently system tasks (state). The possible states are:

- CPU usage
- free hard disc capacity
- free RAM capacity

### Position and pixel intensity

Shows the intensity values of the existing channels for the current X, Y and Z position of the mouse cursor in the image.

## 4.8 Left Tool Area

### Main Tool tabs

Switches between the **Locate**, **Acquisition**, **Processing** and **Maintain** main tools to operate the included tool

### Action buttons


Action buttons are only available for the **Acquisition Main** tool to control the image acquisition process.

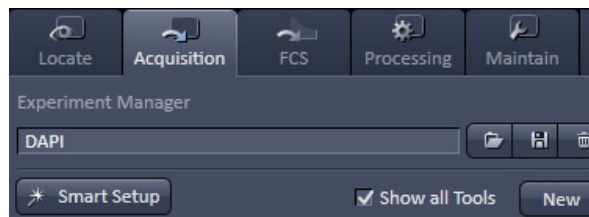
### Tool groups

Groups special tools, e.g. **Setup Manager** or **Acquisition Parameter**.

### Setup Manager

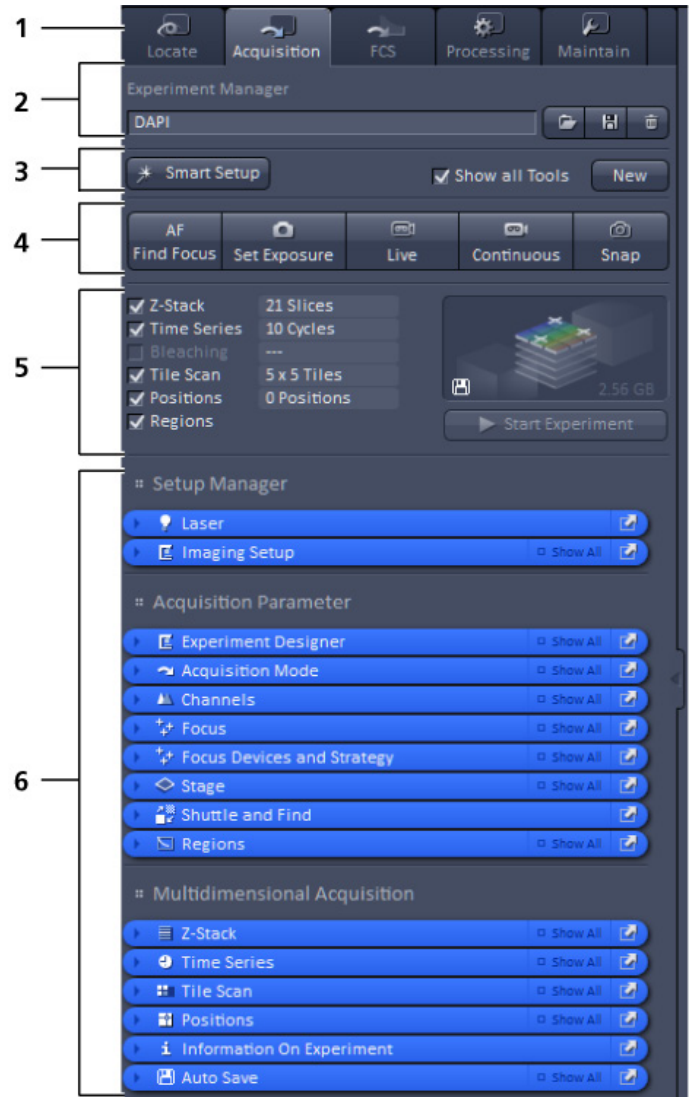
The tools of this tool group (Laser and Setup Imager) are only visible if the check box **Show all Tools** is checked. Those tools are necessary if the system should be operated in full manual mode. The use of the automated functions of ZEN like smart setup includes the functions of those tools.

 The tools **Laser** and **Setup Imager** are not displayed by default in the software. They can be shown if the check box **Show all Tools** is checked.



### Acquisition Parameter

Tools continuously needed for all acquisition procedures.



- 1 Main tool tabs
- 2 Experiment Manager
- 3 Smart Setup
- 4 Action buttons
- 5 Selection panel for multidimensional acquisition
- 6 Tool groups

Fig. 30 Left tool area

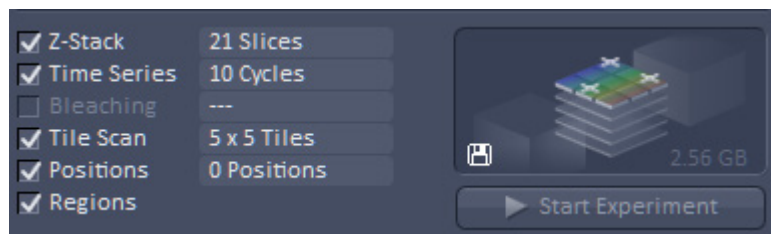


Fig. 31 Expand slider with arrow button pointing left to collapse and right to expand

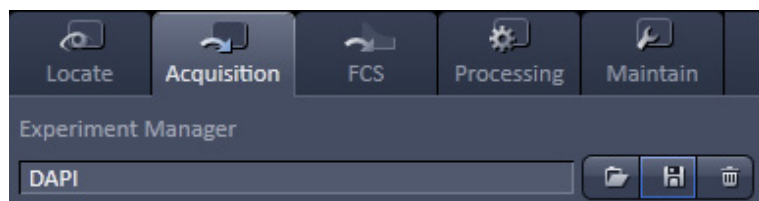
**Multidimensional Acquisition:**

Tools for all multidimensional imaging

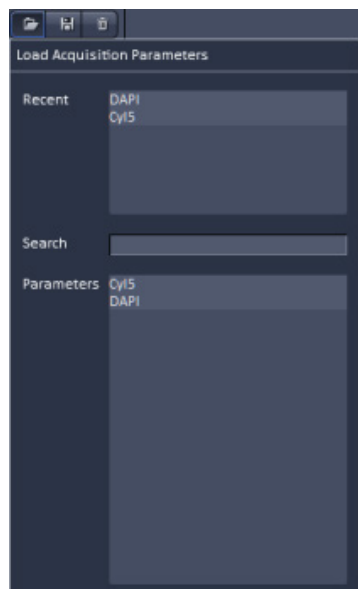
The tools of this tool group will only appear if selected in the selection panel below the start buttons. Once selected by the check box, the tool will appear in the multidimensional acquisition tool group. The tool is then active and will be used after hitting the **Start Experiment** button. The experiment type is represented above the button by a graphic.

**Tools / tools window**

Used for setting the microscope and software functions.

**Experiment Manager**

This function allows selecting an Experiment Manager imaging configuration. The configuration can be chosen in a list box. Clicking on a configuration loads the selection.

**Smart Setup**

- Clicking the **Smart Setup** button  will open the **Smart setup** dialog (see section **Smart Setup**).






## 4.8.1 Tool Groups and Tools

### Multiple Columns Layout of tool groups



This function allows moving one or several **tool groups** in a second or third column of the **Left Tool Area**. This is done by dragging and dropping the **tool groups** header. The second column opens automatically if a group is moved and closes if all groups are removed from it.

### Undock function of tool windows

This function allows undocking and moving one or several tool windows from its home position in the Left Tool Area and further drags it to any position on the Monitor. This can be done by clicking the  button. The tools can also be undocked by simply dragging the header bar of the respective tool to the desired position. To place a tool back to its home position, click the  button again, drag the tool back to the **Left Tool Area** or click on the grey place holder at the home position of the tool. The last option is particularly useful if the screen gets too crowded and one can't find the tools any more. To float all tools back with one click use the  button in the top right corner of the menu bar.

To position the tool window freely on the desktop, use the drag and drop function.

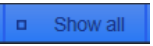
### Open a tool window

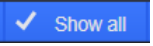
Clicking on the tool header opens or closes the tool pull down window. The state is indicated by a changing icon (, ) left hand in the tool window header.

If a tool is undocked from the **Left Tool Area** (float function) it will be opened automatically.

### Show all function of the tool window

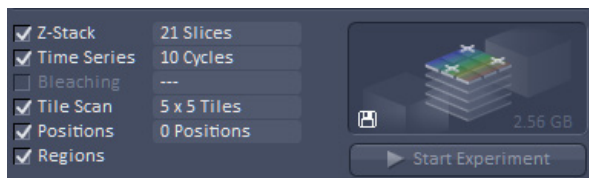
Clicking on the  button shows or hides additional functions of the tool.


 Only the basic functions are shown; this functionality is adequate for most applications.

 All the functions are activated. The full functionality of the tool is available.

### Activation of tools with respect to a multidimensional image acquisition functions of the tool window

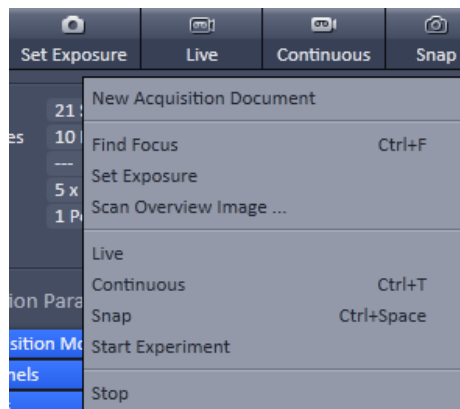
The tools for multidimensional image acquisition can be activated and selected by ticking the respective tick boxes in the selection panel:



Clicking on the  check box of the appropriate tool selects, activates and displays the tool for multidimensional image acquisition. Once selected by the check box, the tool will appear in the multidimensional acquisition tool group. The tool is then active and will be used after hitting the **Start Experiment** button. The experiment type is represented above the button by a graphic.

## 4.8.2 Context Menu of the Left Tool Area

There are 2 different context menus in the Left Tool Area with different functionalities available.



**Fig. 32** Context menu of multidimensional acquisition area

**New Acquisition Document** opens an empty acquisition document in the active image container.

**Find Focus** starts the Auto focus. A Line – Z Scan is performed and the focus position is determined upon contrast values.

**Set Exposure** starts the **Find** procedure. This balances Gain settings.

**Scan Overview Image ...** opens the **Scan Overview Image** dialog to set the parameters for an overview scan. Clicking the **Scan** button starts the procedure.

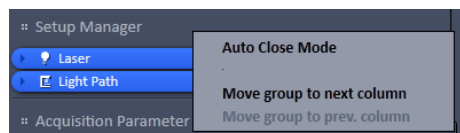
**Live** starts the fast scanning procedure – scans with lower resolution and higher speed.

**Continuous** scans an image continuously with the currently active scanning parameters.

**Snap** scans one single image.

**Start Experiment** starts a multidimensional experiment (Z, T, ...).

**Stop** stops the scanning immediately



**Fig. 33** Context menu of the tool groups area

**Auto Close Mode** means that the "oldest" open tool window will be closed automatically if opening a new one leads to a full tool column.

Right mouse click in the Left Tool Area opens a context menu to activate or deactivate the **Auto Close Mode**. A de-activated **Auto Close Mode** will lead to a scrollbar on the right hand side of the Left Tool Area, once a tool column is filled with open tool.

**Move tool group to next column** shifts an entire tool group to the adjacent column.

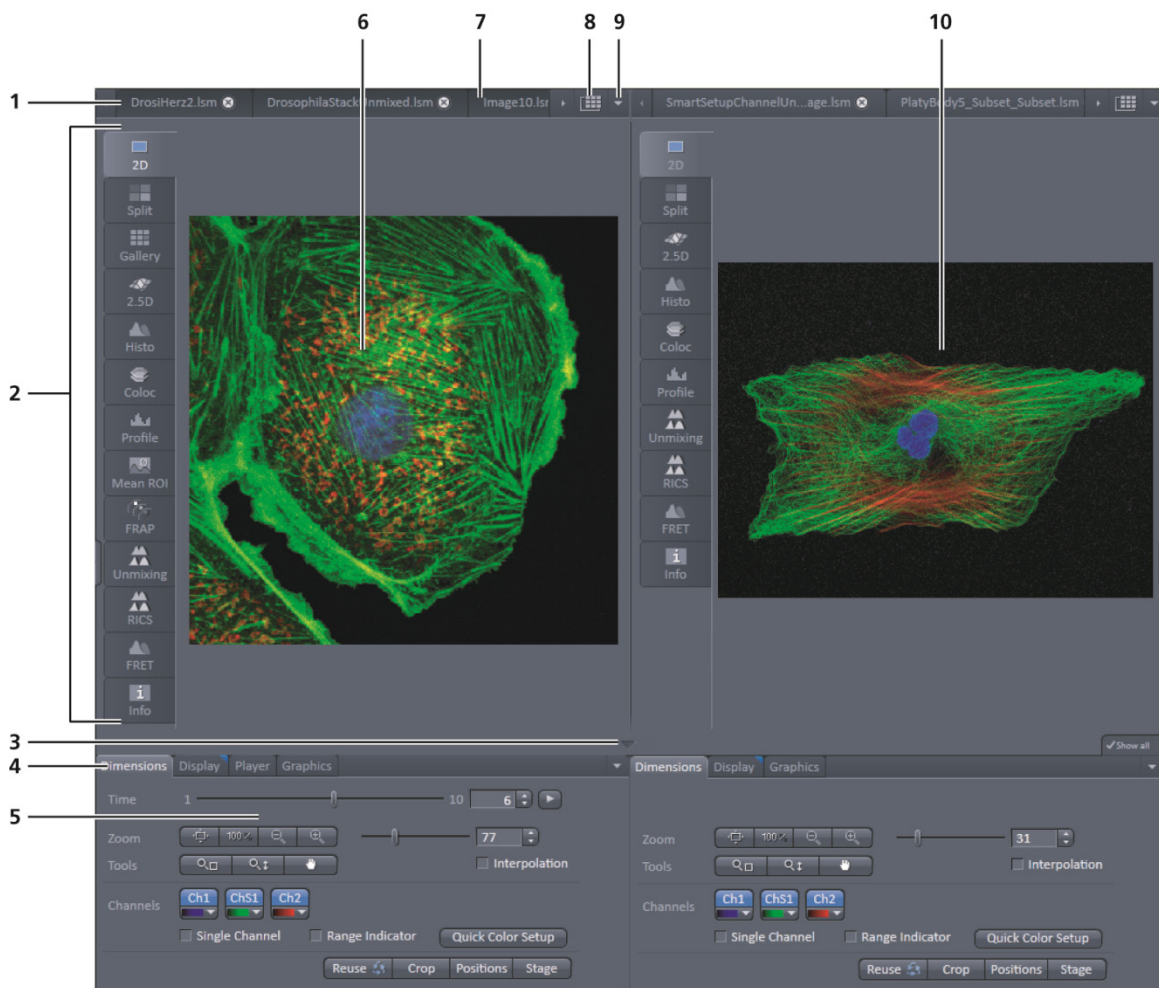
## 4.9 Center Screen Area

The Center Screen Area is used for displaying scanned images or to show images in the available image views. Using the context menu of the Center Screen Area by clicking the background of a container, the view of this area can be varied individually.

The Center Screen Area can be split in a 1, 2 or 3 container view. So, it is possible to show several images in parallel.

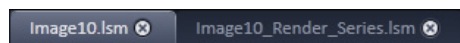
Images can be moved from one container to another using the drag-and-drop function.

### 4.9.1 Overview of the Center Screen Area



- 1 Image tabs with scroll arrow buttons left and right of container 1
- 2 Image view tabs of container 1
- 3 Arrow down or arrow up button to hide or show the image control area
- 4 Image view controls
- 5 Image control area
- 6 Image container 1 (with opened image window)
- 7 Background area of container 1
- 8 Expose mode button (overview)
- 9 Arrow down button for fast image selection
- 10 Image container 2

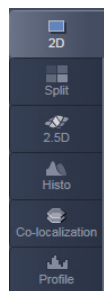
**Fig. 34 Center screen area**



**Fig. 35** Image tabs

### Image tabs

For each opened image one image tab is shown in the header of the actual container. Three modes can be selected using the context menu of the **Center Screen Area** (see also section **Context Menu of the Center Screen Area**).



**Fig. 36** Image view tabs

### Image view tabs

Used to select one of the various image views (see also sections **2D View** to **Information View**).

Arrow down or arrow up button to hide or show the image control area

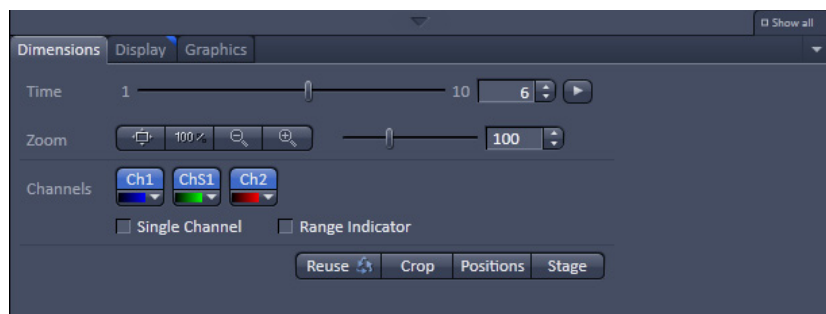
Clicking on the arrow down button hides the image control area and increases the image view field of all containers in vertical direction for a larger image display. Clicking the arrow up button shows the image area in all containers once again.

### Image view controls

Activates one or more of the various image display and analysis functions (see also section **2D View**).

### Image control area

Shows the tools of the selected image display or analysis functions.

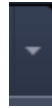


**Fig. 37** Image control area

### Expose Mode

Changes the one image display to the Expose display. Clicking on one of the image headers changes back to the one image display.

The main purpose of this function is to quickly find an image that might be only one of many open images which are all represented by image tabs on the top. Especially if the image tabs are configured to display only the image name.



### Arrow down button

Clicking on this button shows a list with all opened images for fast image selection.



Using the drag and drop function, one or several images can be moved into another opened container. If closing a container, the included images will be moved automatically to another open container.

## 4.9.2 Context Menu of the Center Screen Area

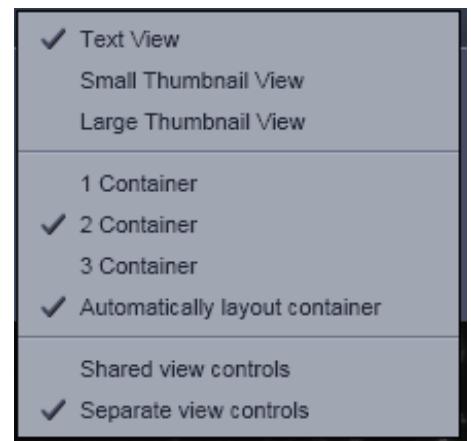
Clicking the right mouse button on the background of the container opens the context menu of the Center Screen Area.

The following functions are available:

Display of the image tabs in the container header

Three options are available:

- Text View
- Small Thumbnail View
- Large Thumbnail View



**Fig. 38** Context menu

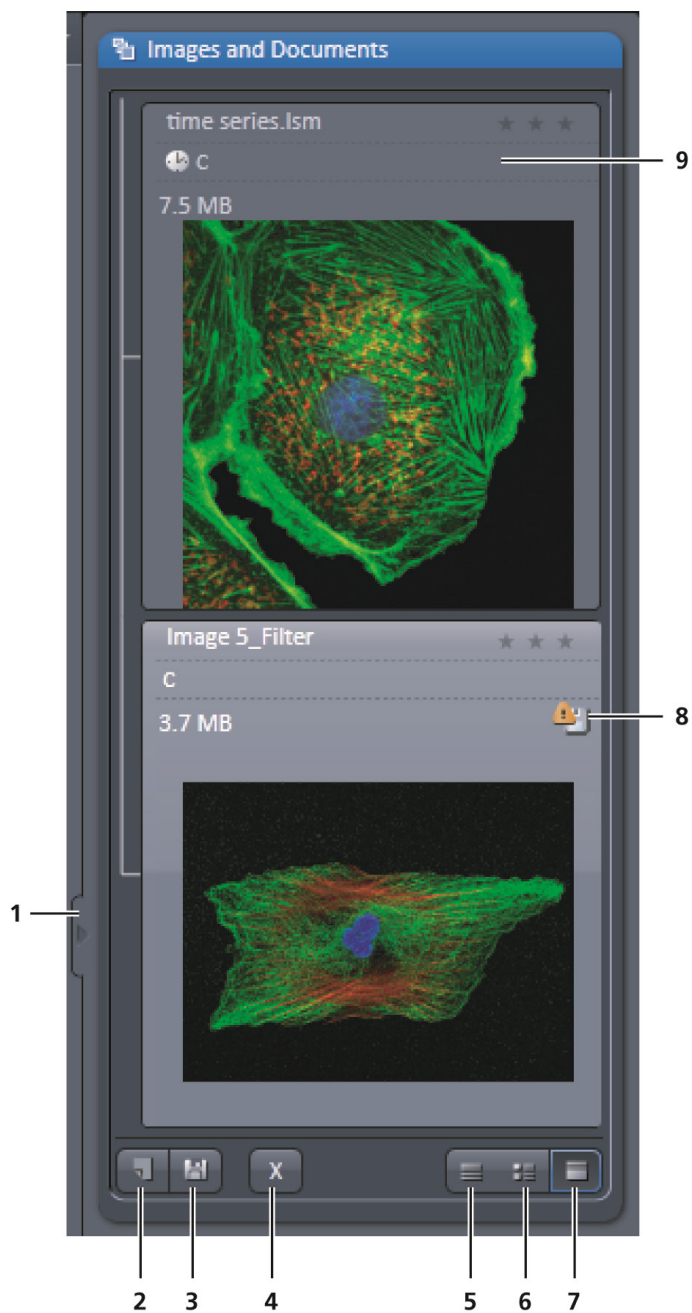
Number of opened containers

Up to three containers can be opened in the Center Screen Area.

### Shared or separate view controls

The display of the Center Screen Area can be changed between shared view controls mode and separate view controls mode.

**Separate view controls** shows a set of view control tabs for each container. In shared view controls mode, only one set of view control tabs is displayed, spanning the whole bottom area under all 2 or 3 containers. They always apply to the active image/container



- 1 Expand slider
- 2 New image document button
- 3 Save button
- 4 Close button
- 5 Textual view button
- 6 Thumbnail view button
- 7 Big view button
- 8 Save status button
- 9 Image information field

**Fig. 39 Right tool area (big view selected)**

### 4.10 Right Tool Area

The Right Tool Area is used for displaying and handling the opened images, e.g. save or close. The view of this area can be varied individually, e.g. expand or hide the area, change between the view modes.

#### Expand slider

Dragging this slider to the left side expands the Right Tool Area by decreasing the center tool area.

Dragging the slider to the right side decreases the Right Tool Area up to the default size.

#### Save button

Saves the selected scanned or changed image. The **Save as** dialog appears.

#### New image document button

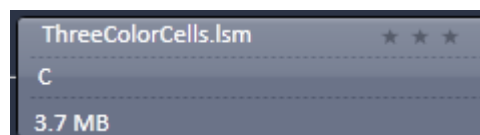
Opens an empty image document in the active container.

#### Close button

Closes the selected image. The **Close image** dialog appears to close the image with or without saving or to cancel the closing.

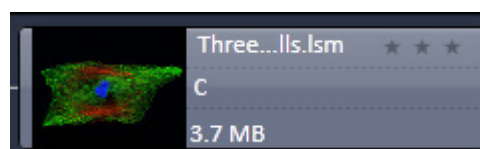
#### Textual View button

Shows images only with the textual characters.



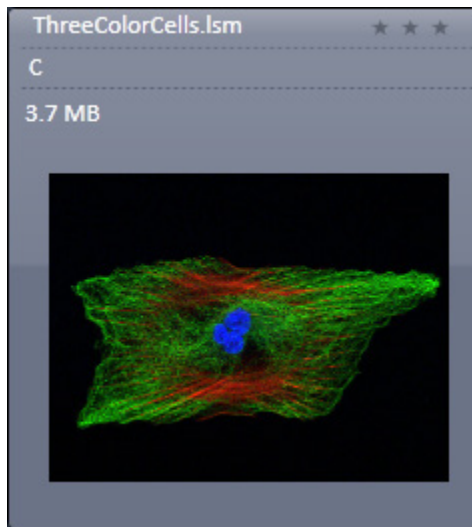
#### Thumbnail View button

Shows images with the textual characters and an image thumbnail preview.



**Big View button**

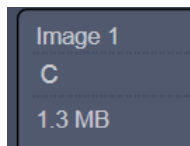
Shows images with the textual characters and a big image preview.

**Save Status icon**

This icon appears in the image that is not saved yet.

**Image information**

Displays the name, type and file size of the image.



## 5 Left Tool Area and Hardware Control Tools

The Left Tool Area contains all tools for system operation, image acquisition, image processing and maintenance.

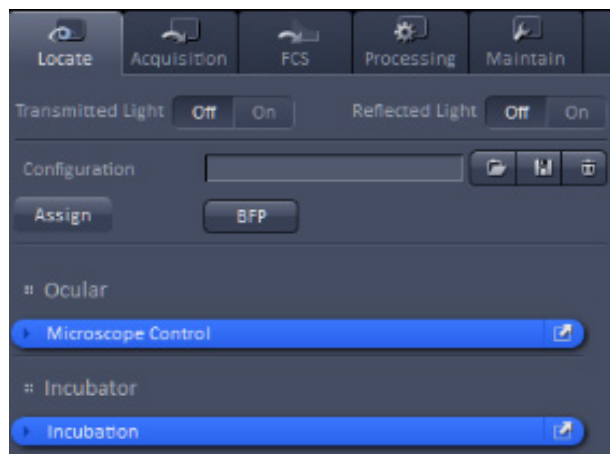


Fig. 40 Locate tab

The major functions are organized in the five Main tool tabs (Fig. 40):

### Locate

Visual and camera inspection in transmitted and epifluorescence light

### Acquisition

Imaging with LSM or ELYRA

### FCS

Fluorescence Correlation Spectroscopy (LSM 880 only).

### Processing

Processing superresolution and LSM images

### Maintain

Setting Imaging and Firmware parameters

By pressing the arrow left symbol of the **Expand slider** on the right border, the **left tool area** will collapse to the left side. The symbol changes to an arrow right symbol. By pressing the latter the **left tool area** will expand.




## 5.1 Locate Tab

**Locate** contains all functions of the microscope for visual inspection of the sample through the eyepieces (Fig. 41).

You can open the shutters for **Transmitted Light** (HAL lamp) and **Reflected Light** (X-Cite lamp) by pressing the respective **On** buttons in the Light control field.

Pressing the **Off** buttons will close the shutters, so no light can reach the eyepieces.

You can load a predefined ocular configuration from the **Configuration** selection box by pressing the **Load** button (  ).

All saved ocular configurations will be listed in the **Load Configuration** panel (Fig. 42).

Select the appropriate one by highlighting it in the **Recent** section, which lists the recently used ocular configurations or from the **Configurations** section, where all saved ocular configurations are displayed.

To search for a microscope configuration, type in its name or part of its name in the **Search** field and only those microscope configurations will be listed that contain the typed in string of letters.

The loaded configuration will be displayed in the **Configuration** display box.

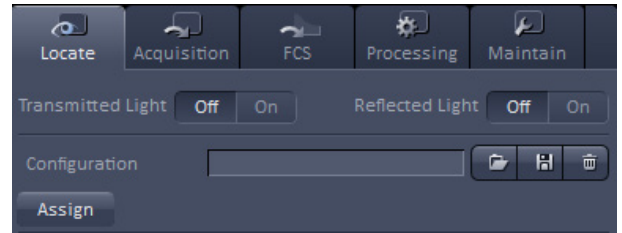


Fig. 41 Locate tab – Configuration panel



Fig. 42 Load Configuration panel

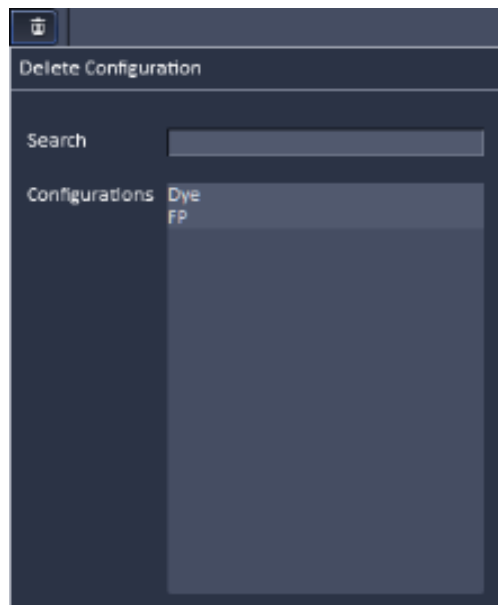


Fig. 43 Delete Configuration panel

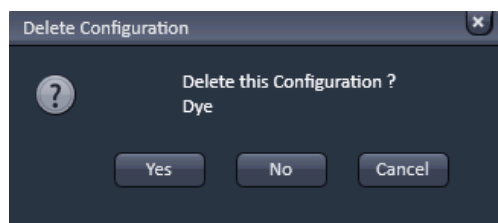


Fig. 44 Delete Configuration pop up menu

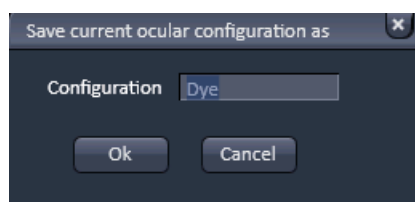


Fig. 45 Save current configuration as panel



Fig. 46 Assign Pop up menu


To delete a configuration press the **Delete** button (🗑️). This opens the **Delete configuration** panel (Fig. 43).


Select the ocular configuration from the **Configurations** list by highlighting it or search for it by typing its name in the **Search** field. The **Delete Configuration** pop up menu will appear (Fig. 44). Press **Yes** to delete the configuration, **No** to keep the configuration or **Cancel** to close the dialog.

To save a microscope configuration press the **Save** button (💾). This opens the **Save current ocular configuration as** panel (Fig. 45). Type in an appropriate name in the **Configuration** field and press **Ok** to save the microscope configuration in the data base or press **Cancel** to abort the process. The configuration that is saved is the one as defined in the **Microscope Control** panel.

If you press the **Assign** button, the **Assign** pop up menu will appear (Fig. 46). You can select the button to which a configuration should be assigned in the **Button** selection drop down menu – up to 8 buttons are available. The configuration that should be assigned to a button can be selected from the **Configuration** selection drop down menu. By pressing **Assign** the configuration will be assigned to the button that will be displayed right to the **Assign** button. The buttons will carry the name of the selected configurations and appear from left to right and top to down according to their number. The ocular configuration assigned to that button will be automatically loaded by pressing that button. If you want to delete a predefined button, select the button (and its configuration), and press **Delete**.

The **Microscope Control** and **Incubation** tools are available in the **Locate** tab (Fig. 41). By pressing the expansion symbols in the bars the **Microscope Control** and **Incubation** tools become available. The **Microscope Control** tool permits configuring beam paths, which can be saved and reloaded in the **Configuration** field. Motorized functions controlled from the **Microscope Control** tool include objective, reflector cube and illumination mode (transmitted or reflected light) selection. The **Incubation** tool allows setting the temperature, CO<sub>2</sub> level, O<sub>2</sub> level and humidity.

 These microscope functions can also be operated directly on the microscope stand via assigned buttons or through the touch screen, if available. In that case, any changes are recorded by the software and displayed in the relevant windows / panels.

 For left side port access, the reflector has to be in a **None** position.

If the reflected light lamp is equipped with a software controlled shutter, the **Shutter On/Off** button in the **Fluorescence** field should be in the **On** position in order to open the shutter. In **Shutter Off** mode, the shutter is closed and will block the light.

### 5.1.1 Microscope Control Tool for Axio Observer.Z1

To have access to the microscope functions to define a configuration, you have to expand the **Microscope Control** tool by pressing the expansion symbol in the **Microscope Control** tool tab (Fig. 47).

The **Microscope Control** panel contains the following functions:

**HAL On/Off** button for transmitted light: If the button is pressed, the control panel appears (Fig. 48).

If you press the **On** button it will be highlighted and the Halogen lamp will be switched on (symbolized by the halo in the lamp symbol).

In parallel the shutter for transmitted light automatically opens (**On** position in the **Light control** field and **Open** position in the **Ocular** panel). The light intensity of the HAL lamp can be varied via the input box or slider.

The light path will be highlighted by color in the diagram. Press the **On** button again to shut down the light. The button will go to the **Off** position and the shutter closes automatically.

The color temperature for photo documentation can be switched on via the **3200 K** button.

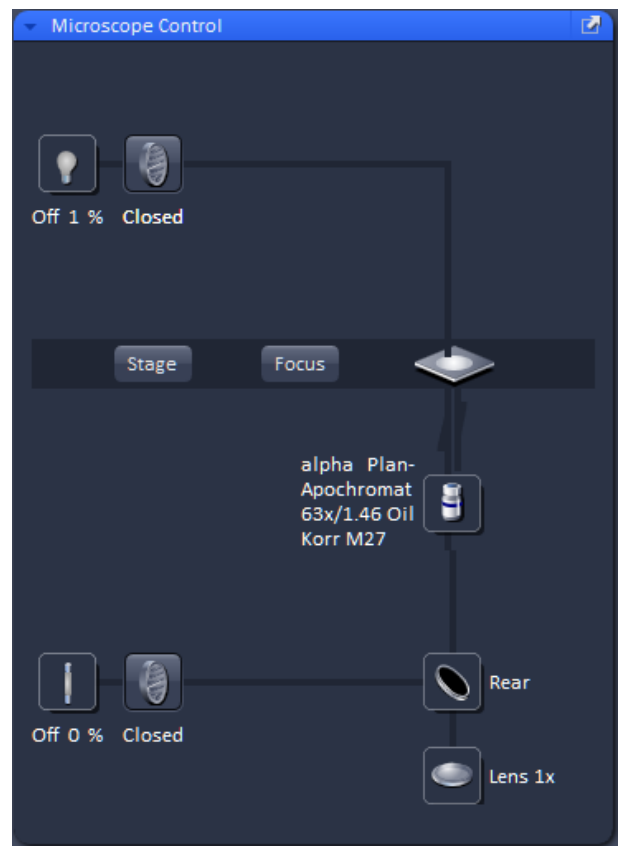


Fig. 47 Microscope Control tool

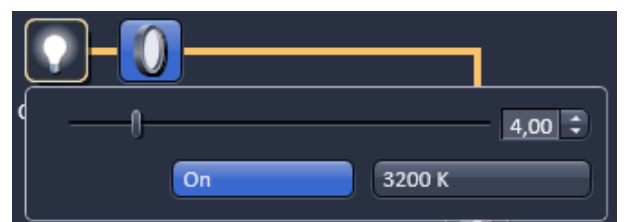
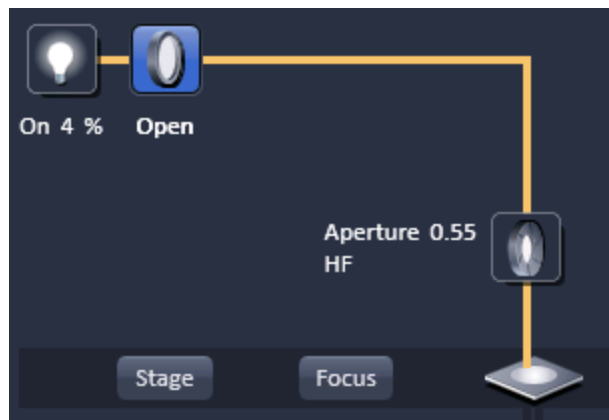
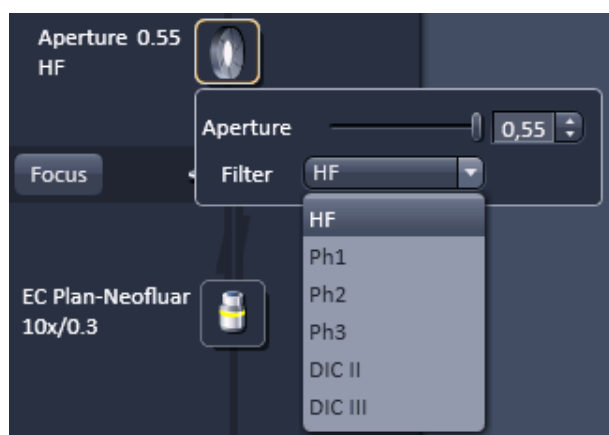


Fig. 48 Microscope Control tool – HAL lamp control



**Fig. 49** Microscope Control tool – HAL lamp switched on, shutter in the Open position



**Fig. 50** Microscope Control tool – Condensor control



**Fig. 51** Microscope Control tool – Stage control

**HAL transmitted light Open/Close shutter** button:

The shutter for transmitted light from the HAL lamp is switched on and off by repeated pressing (Fig. 49).

Note that it is equivalent to the Transmitted Light **On/Off** button from the **Light control** field. Whenever one of these buttons is pressed, the other buttons are updated. The shutter opens automatically, when the **HAL On/Off** button is switched to the **On** position, and closes automatically if the **HAL On/Off** button is switched to the **Off** position. However, it can be independently controlled, i.e. you can switch the shutter to the **Close** position with the halogen lamp still being switched on or vice versa you can open the shutter with the HAL lamp being switched off.

**Condenser** button:

The numerical aperture of the condenser is set via input box or slider (Fig. 50). The turret position of the filter can be selected from the **Filter** drop down menu (only for motorized condensers).

**Stage** button:

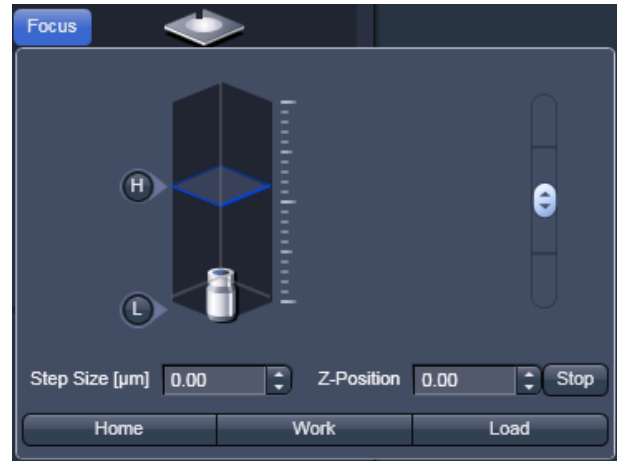
If the **Stage** button is pressed, the **Stage control** panel will appear (Fig. 51).

By pressing the **Stop** button you can interrupt any stage movement. The **Move to Zero** button will move the stage to the current zero positions of the x and y coordinates. The compass rose will move the stage in the direction of the arrowheads. Fast movement is obtained with the outer rose, slow movement with the inner rose.

The **X-Position (μm)** and **Y-Position (μm)** display boxes show the actual x and y coordinates. You can edit the numbers by typing or using the arrowheads. If numbers were altered, the first click on the compass rose will bring the stage to the altered position. The **Step Size (μm)** display box shows the currently used step size for stage movement. The value can be edited by typing or using the arrowheads. The **Set zero** button sets the x and y coordinates to 0.

**Focus** button:

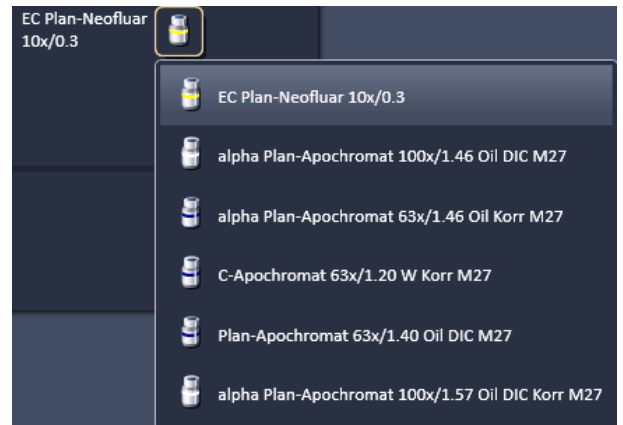
If the focus button is pressed, the **Focus** control panel will appear (Fig. 52). The **Z-Position** display box shows the current z-position. The number can be edited by typing or using the arrowheads. The nosepiece or stage will automatically update the new position. By pressing the **Stop** button, you can stop the current movement. The **Step Size (µm)** display box shows the currently used step size for stage movement. The value can be edited by typing or using the arrowheads. The **Home** button sets the z-position to the predefined zero value. Pressing **Load** will lower the nose piece (z-position) for objective change. **Work** brings the z-position back to the actual used position if the focus was zeroed or in **Load** position. Home and Load positions can also be accessed from the z-position slider by pressing the **H** or **L** buttons. The z-position can be altered by grasping and sliding the **plane** or by using the arrow slider. The **plane** shows the actual z-position.



**Fig. 52** Microscope Control tool – Focus control

**Objective** button:

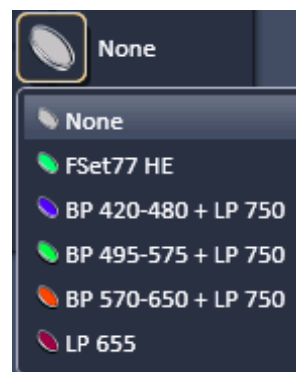
The objective can be selected via a graphical pop-up menu (Fig. 53). Please note, that for SIM the Plan-Apochromat 63x / 1.4 oil and for TIRF the alpha Plan-Apochromat 100x / 1.46 oil are the objectives of choice.



**Fig. 53** Microscope Control tool – Objective control

**Reflector** button:

The reflector cube can be selected from the reflector turret via a graphical pop-up menu (Fig. 54).



**Fig. 54** Microscope Control tool – reflector turret control

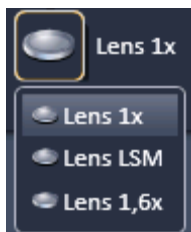


Fig. 55 Microscope Control tool – Tube lens control

#### Tube Lens button:

The tube lens can be selected via a graphical pop-up menu (Fig. 55). **Lens 1x** is used for ocular observation and widefield imaging using an arc lamp, **Lens LSM** is used for laser scanning imaging and **Lens 1.6x** is used for widefield imaging using a laser source as well as for superresolution imaging. The tube lens for each application will be automatically chosen, but the selection can be overruled manually.

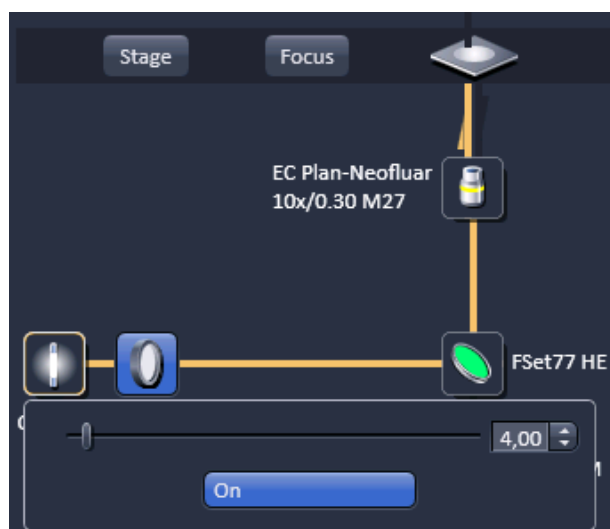


Fig. 56 Microscope Control tool – Excite control

#### Excite On/Off button for epifluorescence / reflected light:

If the button is pressed, the control panel appears (Fig. 56). If you press the **On** button it will be highlighted and the X-Cite lamp will be switched on (Fig. 57). In parallel the shutter for reflected light automatically opens (**On** position in the **Light control** field and **Open** position in the **Ocular** tool). The light intensity of the X-Cite lamp can be varied via the input box or slider. The light path will be highlighted by color in the diagram. Press the **On** button again to shut down the light. The button will go to the **Off** position and the shutter closes automatically.



Fig. 57 Microscope Control tool– Excite control

#### Excite Reflected Light Open/Close Shutter button:

The shutter for reflected epi-fluorescent light from the X-Cite lamp is switched on and off by repeated pressing (Fig. 57). Note that it is equivalent to the reflected Light **On/Off** button from the **Light control** field. Whenever one of the buttons is pressed, the other buttons are updated. The shutter opens automatically, when the **X-Cite On/Off** button is switched to the **On** position, and closes automatically if the **X-Cite On/Off** button is switched to the **Off** position. However, it can be independently controlled, i.e. you can switch the shutter to the **Close** position with the X-Cite lamp still being switched on or vice versa you can open the shutter with the X-Cite lamp being switched off. The light path will be highlighted in color.

---

**Visual inspection of the cells via binoculars**

- In the main toolbar, activate the **Locate** tab.
- Choose from the **Locate** tab the **Microscope Control** tool.

**For transmitted-light observation (Bright-field)**

- Switch the HAL lamp on by the **HAL On/Off** button and adjust the light intensity.
- Activate the condenser function with the **Condenser** button if applicable.
- Press the **Objective** button to swing the required objective into the working position. We recommend using the Plan-Apochromat 63x/1.4 oil for HR-SIM and 3D-PALM and the  $\alpha$ Plan-Apochromat 100x/1.46 oil for PALM due to their optimized optics.
- Select the desired tube lens by clicking the **Tube lens** button. Normally, the correct **Lens 1x** will be chosen automatically when the **Locate** tab of the main tool bar is pressed. When working with Airyscan we also recommend using selected high NA objectives.

**For reflected-light observation (Epi-fluorescence)**

- Turn on the Excite power supply switch.
- Switch the Excite **On/Off** button to the **On** position. As needed switch the Excite **Reflected Light Open/Close Shutter** into the **Close/Open** position.
- Select the desired filter cube in the reflector turret by clicking the **Reflector** button. The filter will be automatically moved into the beam path to enable observation in epi-fluorescence.
- Select the desired tube lens by clicking the **Tube lens** button. Normally, the correct **Lens 1x** will be chosen automatically when the **Ocular** tab is pressed.
- Swing the required objective into the working position by selecting the objective with the **Objective** button. We recommend using the Plan-Apochromat 63x/1.4 oil for HR-SIM and 3D-PALM and the  $\alpha$ Plan-Apochromat 100x/1.46 oil for PALM due to their optimized optics. When working with Airyscan we also recommend using selected high NA objectives.

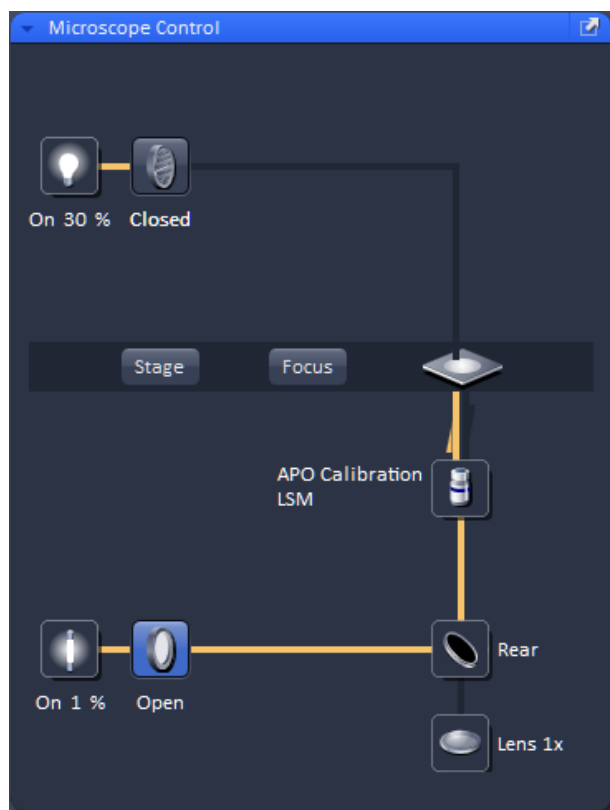


Fig. 58 Axio Observer.Z1 controls in the Microscope Control tool

### (1) Conventional setting of the microscope Axio Observer.Z1

The Recording of microscope settings works as described for the microscope Axio Imager.

For the conventional setting of the Axio Observer.Z1, proceed as follows:

- Click the **Locate** tab in the **Main** toolbar.
- Place specimen on microscope stage.
  - The cover slip must be facing down.
- In the **Objective** list box, select the required objective.
- Use the focusing drive (Fig. 59/4) to focus the required specimen plane.
- Select specimen detail by moving the stage in X and Y via the XY stage fine motion control (Fig. 59/3 and 2).

### (2) Microscope settings on Axio Observer for transmitted-light observation

- Click on the **Transmitted light** button. Click the **On** button in the **Transmitted Light** panel and set the transmitted light intensity via the slider or click on **3200 K**.
- Click on the **Condenser** button and set the aperture via the slider in the **Condenser** panel. Set the filter in the **Filter** selection box.
- Click on the **Objective** button and select the objective by clicking on it.
- Click on the **Reflector** button and select **None**.
- Make sure there is no illumination from the reflected-light.



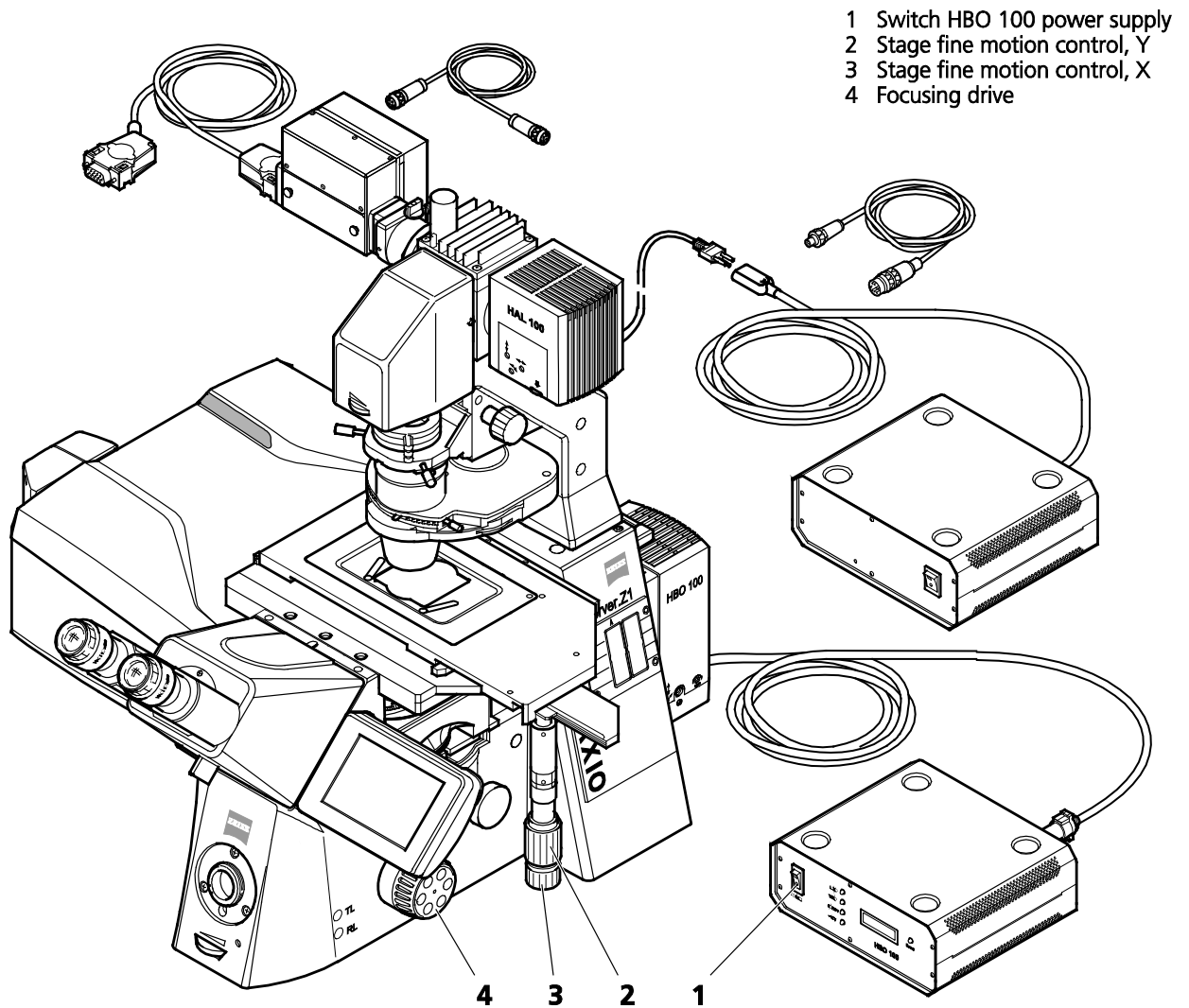


Fig. 59 LSM 880 with AxiObserver.Z1

### (3) Microscope settings on AxiObserver for reflected-light observation (Epi-fluorescence)

- Turn on the HBO 100 power supply switch (Fig. 59/1).
- Click on the **Reflected Light** button and set the shutter to **Open**.
- Click on the **Reflector** button and select the desired filter set by clicking on it.
- The filter is automatically moved into the beam path to enable observation in epi-fluorescence.
- Click on the **Objective** button and select the objective.
- Make sure that the illumination from the transmitted-light is switched off.

---

### 5.1.2 Microscope Control Tool for Axio Imager.Z2

- Click on **Locate** tab in the **Left tool** area. Click **Online** if needed.
- The currently set light path of the microscope is displayed.
- Depending on the level of motorization, the following parts can be controlled:

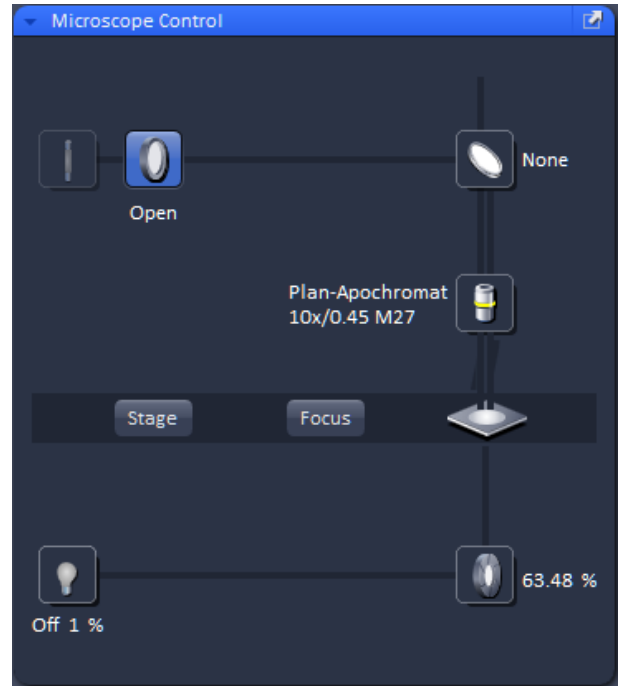
<b>Reflected Light HBO Lamp</b>	This function controls the reflected light illumination source, e. g. X-Cite 120. An additional dialog opens which allows to open and close the lamp internal shutter and to attenuate the light intensity of the lamp via slider or input box.
<b>Shutter Reflected Light</b>	This turns the rear port mirror to guide the light to the specimen or to block it from the specimen.
<b>Tube Lens</b>	This function allows switching between available tube lenses. The appropriate lens is automatically set when switching between Locate and Acquisition in the Main toolbar.
<b>Reflector</b>	Push and click reflector cube can be selected via graphical pop-up menu.
<b>Objective</b>	Objectives can be selected via graphical pop-up menu.
<b>Condenser</b>	Numerical aperture of the condenser is set via input box or slider. Turret position (filter) selected from graphical pop-up menu (only for motorized condensers).
<b>Field Stop</b>	Opening of luminous-field diaphragm (transmitted light) can be set via input box or slider.
<b>Filter</b>	Transmission values for attenuation filter (transmitted) are set via input box or slider for the front or rear filter wheel in accordance with the available filter steps.
<b>Transmitted Light Lamp</b>	Transmitted light is switched on / off via ON button in the Transmitted Light frame, setting of light intensity can be varied via input box or slider. 3200 K color temperature for photo documentation can be switched on via 3200 K button in the Transmitted Light frame.
<b>Shutter Transmitted Light</b>	This function opens or closes the internal shutter for transmitted light.

**(1) Microscope settings on Axio Imager for transmitted-light observation**

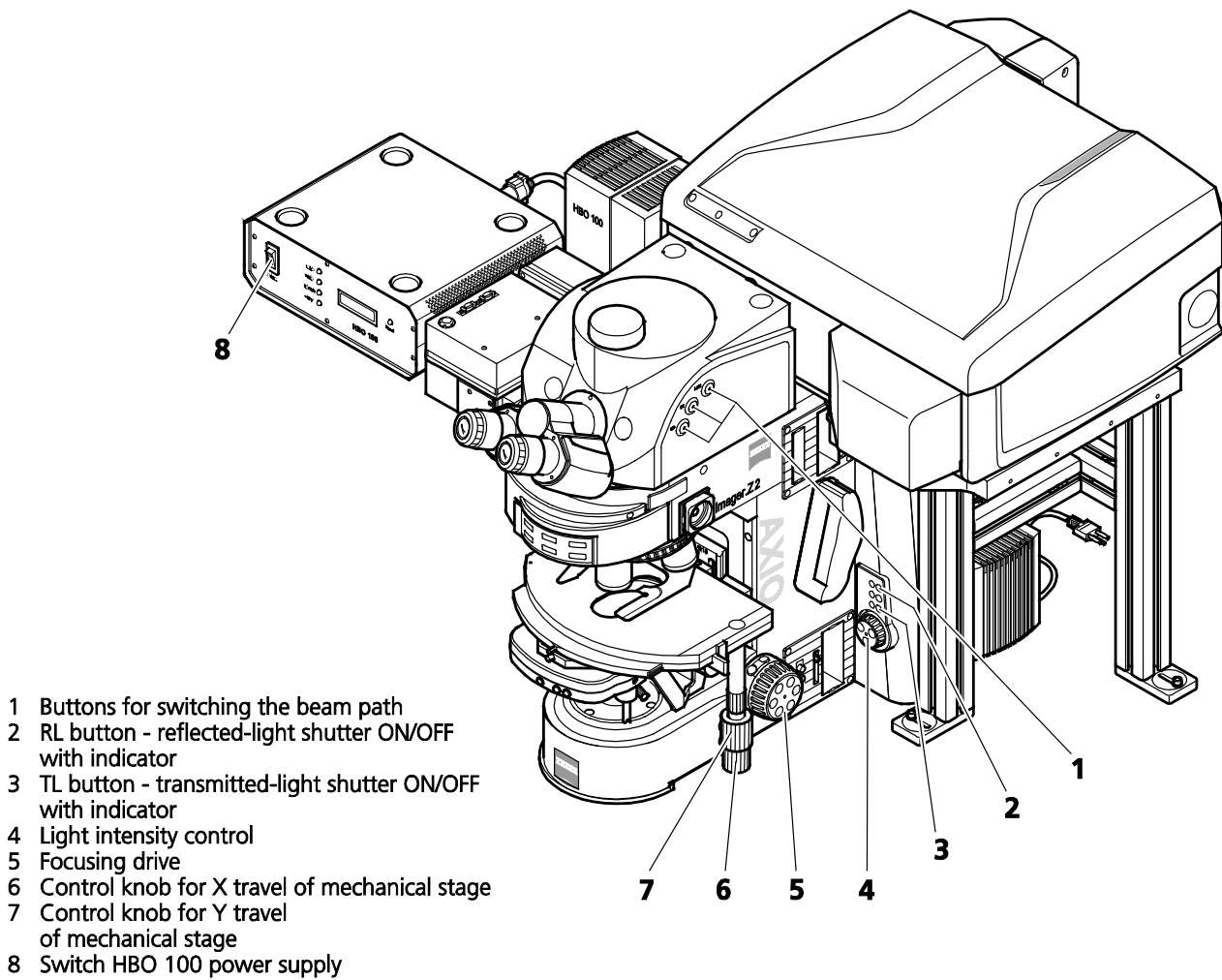
- Set the reflector turret position to **None** and click the **On** button for transmitted light.
- Pull out the push rod (Fig. 61/1) to switch the beam path of the tube in LSM position.
- Control the brightness of the halogen lamp with the potentiometer (Fig. 61/4) or the **Intensity %** slider in the **Microscope Control** tool.
- Set the required transmission value of the gray filters in the **Filter** frame.
- Set the condenser and the luminous-field diaphragm for KÖHLER illumination.

The laser-scanning mode automatically occludes the halogen lamp even with **Transmitted Light** activated (**On**).

- Click on the **Locate** tab in the Left tool area. Press **Online** if needed.
- Place specimen on microscope stage.
  - The cover slip must be facing up.




**Fig. 60** Axio Imager.Z2 controls in the Microscope Control tool




**Fig. 61** LSM 880 with Axio Imager.Z2

- Via the **Objective** button, select the required objective as follows:
  - Open the graphical pop-up menu by clicking on the **Objective** button.
  - Click on the objective you want to select.
  - The selected objective will automatically move into the beam path.
- Use the focusing drive (Fig. 61/5) to focus the required object plane.
- Select specimen detail by moving the stage in X and Y using the XY stage fine motion controls (Fig. 61/6 and 7).

## (2) Microscope settings on Axio Imager for reflected-light observation (Epi-fluorescence)


- Turn on the HBO 100 W or X-Cite power supply with switch (Fig. 61/8)
- Click on the **RL reflected light** button. The shutter opens.
-  To avoid excessive bleaching of biological samples, expose the specimen to the minimum possible irradiation, i.e. keep the irradiation time as short as possible. For this, use the slider in the Ocular tool to attenuate the illumination of the HBO / X-Cite.
- By clicking on the reflector turret button, select the reflector module (filter sets) to suit the type of fluorescence excitation. Proceed as follows:
- Click on the reflector turret button.
- Click on the desired reflector module.
  - The reflector turret moves the selected reflector module into the beam path.


-  The FITC filter set consists of an excitation filter for the 450 - 490 nm spectral range, an FT color splitter for 510 nm and an LP long pass filter, which passes emission light wavelengths greater than 510 nm (FSET 09 = FITC, FSET 15 = Rhodamine, FSET 01 = DAPI).

Other filter sets:

DAPI:           BP 365 FSET01  
                          FT 395  
                          LP 397

Rhodamine: BP 546 FSET15  
                          FT 580  
                          LP 590

-  The filter sets described in this section are examples; other sets are available on request.

-  The aperture setting on the condenser of the Axio Imager.Z2 is performed in fixed steps.

### 5.1.3 Controls for Axio Examiner

For setting the Axio Examiner, proceed in the same way as with Axio Imager.Z2 and Axio Observer.Z1. Since the objective turret of the Axio Examiner is not motorized the setting of the desired objective has to be done manually.

The objective in use must be indicated in the **Acquisition Mode** tool.

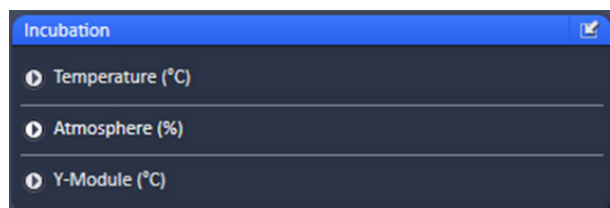


Fig. 62 Incubation tool



Fig. 63 Incubation tool – Expanded fields for atmosphere and temperature control

#### 5.1.4 Incubation Tool

To have access to incubator functions to define the atmosphere and temperature, you have to expand the **Incubation** tool by pressing the arrow in the **Incubation** tool (Fig. 62).

You will have access dependent on the attached equipment to


- Temperature (°C) control
- Atmosphere (%) control
- Y-module (°C) control

To have access to the respective controls, you have to expand the fields by pressing the triangles (Fig. 63).

The **Temperature (°C)** panel allows you to control up to 4 independent heating channels that are linked to certain devices (e.g. incubator XL, heating insert P, objective heater etc.) that are assigned to different channels. Enter the desired nominal temperature via the input boxes by typing in the numbers or by using the arrows to set the parameters. Check the corresponding box to activate the desired **Channel**. The numbers on the right will display the actual temperature. If a sensor is available, its temperature will also be displayed.

The **Atmosphere (%)** panel allows defining the O<sub>2</sub> and CO<sub>2</sub> concentration via the input boxes either type in the numbers or use the arrows to set the parameters. In order to monitor O<sub>2</sub>, CO<sub>2</sub> and humidity levels, check the corresponding boxes. Actual values will be displayed on the right. If a humidifier is available it can be activated by checking the **Humidity** box. The actual humidity reading is displayed on the right,

The Y-Module (°C) panel allows setting the temperature for two independent thermostats (circulators), that can be selected via the **Selected** drop down menu. Each **thermostat** has two output channels, **01** and **02**. Type into the input boxes or use the arrows to define the appropriate temperature for each module. Activate the modules by checking the corresponding boxes. The actual values will be displayed to the right of each module.

 Note that using the Z-Piezo stage insert, which is required for both HR-SIM and PALM, only the incubator function of the incubator XL are available as Heating Insert P and Incubator S do not fit to this stage. The latter can therefore only be used without the Piezo stage insert.

## 5.2 Acquisition Tab

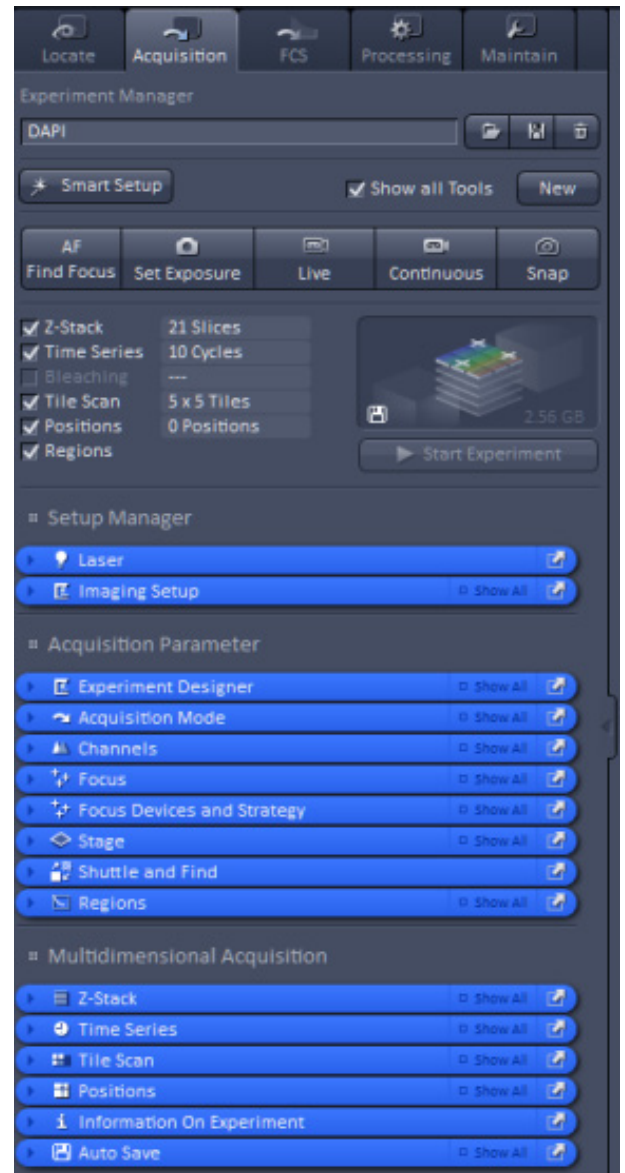
**Acquisition** contains all functions of the microscope that are needed to set up and control wide-field imaging by bright field or fluorescence, designated in this manual as wide-field (**WF**), laser wide-field imaging by epi-fluorescence and total internal reflection fluorescence (**Laser WF**), wide-field imaging with structured illumination microscopy (**SIM**) and laser scanning microscopy (**LSM**).

It depends on the hardware configuration, which of these functions are available. All wide-field techniques use cameras, whereas LSM uses internal photomultiplier tubes (PMT or GaAsP) for detection.

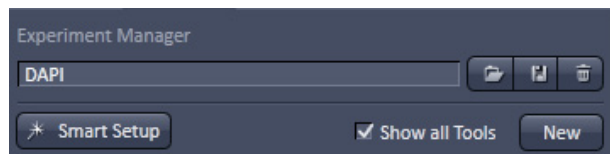
For excitation all imaging modes uses lasers with the exception of **WF** that employs the X-Cite. If **Acquisition** is selected, the **Acquisition** tool becomes available (Fig. 64).

The **Acquisition** tool is divided into the

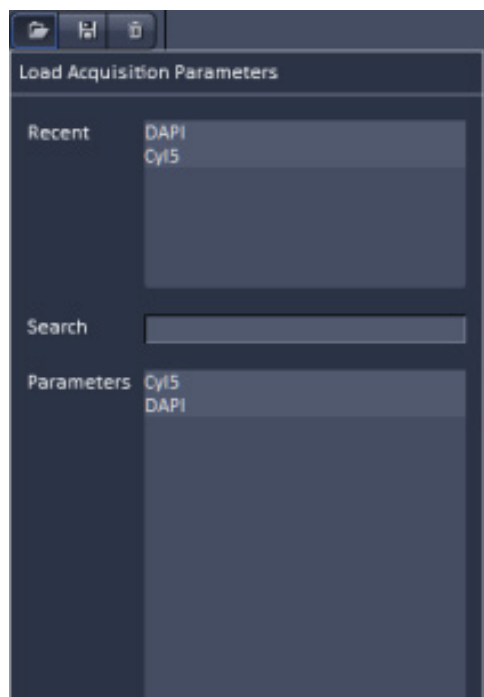
- **Experiment Manager** field for loading predefined configurations, action buttons and definition of the multidimensionality of the experiment and
- **Tool Group** field with the **tool tabs** for setting the parameters for imaging.



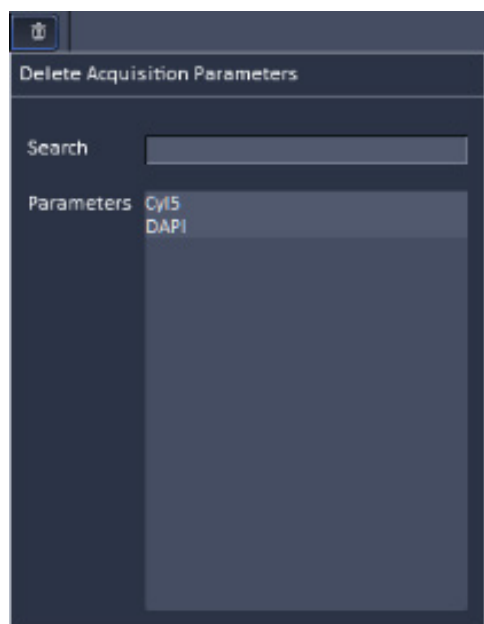
**Fig. 64** Appearance of Acquisition Tab tools for LSM mode



**Fig. 65** Experiment Manager field with loaded configuration



**Fig. 66** Load Acquisition Parameters panel



**Fig. 67** Delete Acquisition Parameters panel

## 5.2.1 Configuration Functions

You can load a predefined acquisition configuration from the **Experiment Manager** field (Fig. 65) by pressing the **Load** button (📄).

All saved acquisition parameters will be listed in the **Load Acquisition Parameters** panel (Fig. 66).

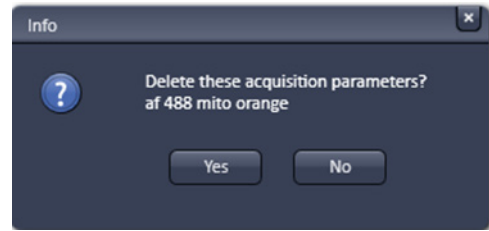
Select the appropriate one by highlighting it in the **Recent** section, which lists the recently used acquisition parameters or from the **Parameters** section, where all saved acquisition parameters are displayed.

To search for an acquisition parameter, type in its name or part of its name in the **Search** field and only those acquisition parameters will be listed that contain the typed in string of letters.


To delete parameters press the **Delete** button (🗑️). This opens the **Delete Acquisition Parameters** panel (Fig. 67).

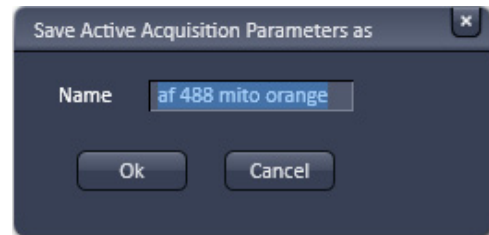


Select the acquisition configuration from the **Parameters** list by highlighting it or search for it by typing its name in the **Search** field. An **Info** menu pops up (Fig. 68). Press **Yes** to delete the acquisition parameters, **No** to keep the parameters. Close the menu by pressing the **cross** to abort the operation.



**Fig. 68** Info panel

To save acquisition parameters press the **Save** button (  ). This opens the **Save Active Acquisition Parameters as** panel (Fig. 69). Type in an appropriate name in the **Name** field and press **Ok** to save the acquisition parameters in the data base or press **Cancel** to abort the process.



**Fig. 69** Save Active Acquisition Parameters as panel

Pressing the **Smart Setup** button will open the **Smart Setup** panel. As this is an exclusive LSM function the user is referred to section **Smart Setup** for a detailed description.

If the **Show all tools** box is checked, the **Setup Manager tool group** is displayed and available. If unchecked, the **Setup Manager tool group** will not be visible.

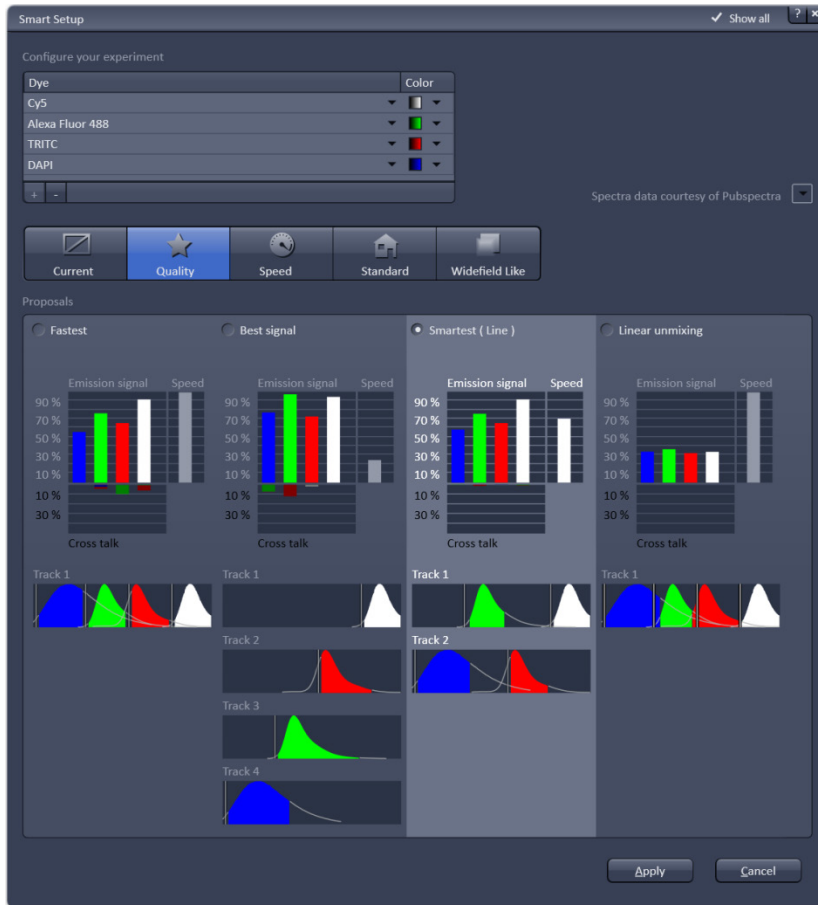
If the **New** button is pressed, a new **Image window** is opened in the **Image Container** into which the new image will be displayed. The next acquired image is displayed in this image frame, when it is the selected one. This function can be used to avoid that an old unsaved image (acquired by **Live**, **Continuous** or **Snap**) will be overwritten by a new image.

### 5.2.2 Smart Setup

**Smart Setup** (Fig. 70) provides an intuitive, user-friendly interface for automatically configuring the LSM's light path for detecting fluorescent dyes.

Similar to cameras used in photography, a panel of motifs helps setting the scanning parameters for imaging with the LSM.

**Smart Setup** is started upon pressing the  button.



**Fig. 70** Smart Setup and Motifs

**Configure your experiment**


The fluorescent labels used for staining the sample need to be added to the table in **Configure your experiment**.

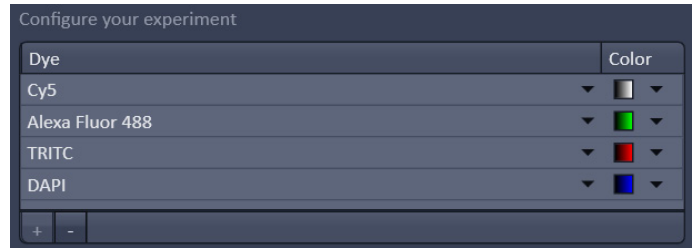
Dyes are added to this list from a searchable library containing almost all commercially available fluorescent labels (Fig. 71).

This library is part of a pop-up menu that becomes available upon clicking the arrow symbols in the **Dye** column (Fig. 72).

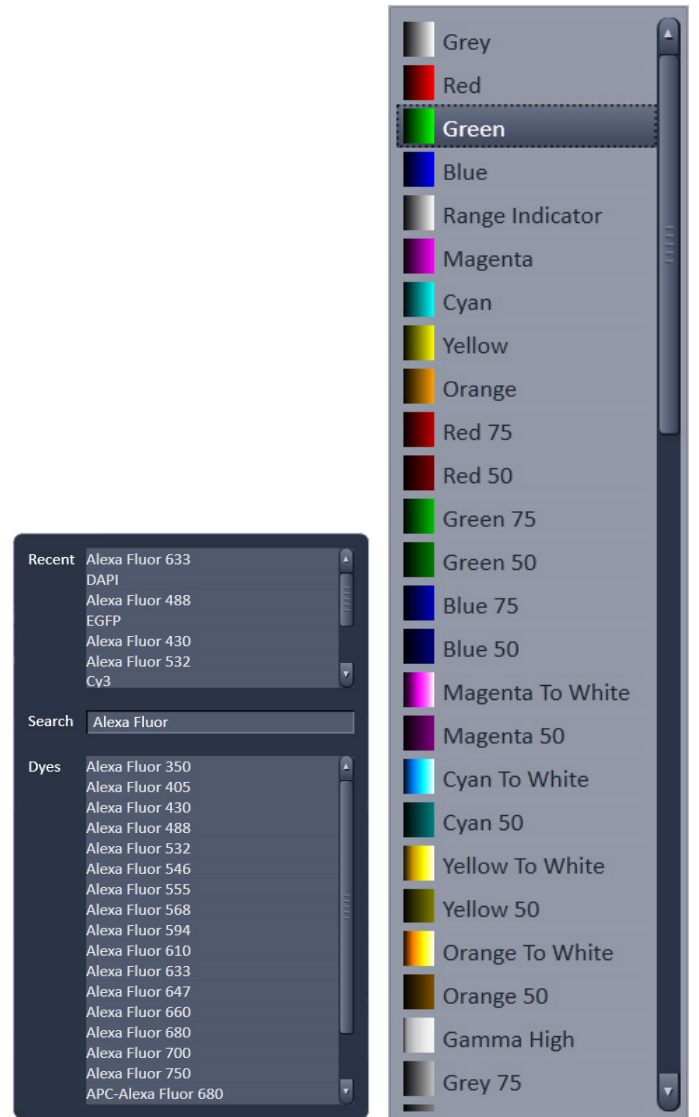
Searching for dyes is done by typing the name of a dye into the **Search** box and then selecting it from the list. Alternatively, the most recently used dyes can be picked from the upper section of the panel.

A color representation of the dyes (LUT) is added automatically and graphically displayed as a small icon (box) next to the dye. The color code is changed by clicking the arrows in the **Color** column (Fig. 72). The color code specified here will be used for a given dye in all graphical representations in **Smart Setup**. Dyes can be added or

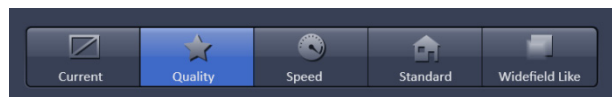
removed from the list with . A dye configuration table in Smart Setup may contain up to four different dyes.



**Fig. 71** Configure your experiment panel



**Fig. 72** Dye column (left) and Color column (right)



**Fig. 73** The motifs provide presets for typical imaging tasks. The selected motif is highlighted.

- **Current**
- **Quality**
- **Speed**
- **Standard**
- **Widefield-Like**

Activate your selection with a mouse click.

**Current:** Does not change the current set of scanning parameters defined in the Acquisition Tool. In the Channels tool laser power and pinhole are set to moderate levels. Detector settings are not changed unless the detector gain is still zero, then a moderate gain will be set. Clicking Apply does set the parameters accordingly, no image is scanned yet.

**Quality:** Aims to provide high quality images with best signal to noise ratio based on lower detector gains and higher laser power defined in the Channels Tool. The pinhole is set to one Airy unit. In the Acquisition tool the image size shows close to niquist settings in xy, a slow scan speed, 12 bit data depth and unidirectional scan mode without averaging. Clicking apply sets the parameters and scans one image.

**Speed:** Choses parameters for fast imaging. The parameters of the Imaging Setup and the Channels tool are not changed. Within the Acquisition tool the image size is reduced and using the maximum speed possible for the given zoom with bidirectional scanning and no averaging an image is scanned when clicking Apply.

**Standard:** Applies the most common imaging settings for the acquisition. The image size is set to 512 x 512 pixels with the standard scan speed of 9 at no average, unidirectional scanning and a data depth of 8 bit. Laser power is set to moderate levels and the gain is at rather low settings. Clicking apply sets the parameters and scans a new image.

**Widefield-Like:** Uses 512x512 pixels, no average, 12 bit data depth and unidirectional scanning at the given imaging speed. The pinhole is fully opened and the gain and laser power are both set to low levels. Clicking Apply sets the parameters and scans one image.

## Motifs

Like in photography, common imaging conditions with typical requirements also exist in laser scanning microscopy.

The **Motifs** in **Smart Setup** represent presets of scanning parameters (pixels size, pinhole diameter, scan speeds etc.) for such typical imaging conditions (Fig. 73):

---

## Proposals

The imaging parameters of the Imaging Setup Tool are defined for the dyes indicated in the panel: Configure your experiment. Based upon this set of dyes used for staining the sample (see above) **Smart Setup** computes four proposals with different goals:

- **Fastest**
- **Best Signal**
- **Smartest (Line)**
- **Linear Unmixing**

In the case of only a single type of fluorescent dye, all proposals may be identical.

The proposal **Fastest** aims to record all dyes simultaneously as a single track with multiple channels whenever possible. If the number of fluorescent dyes exceeds the number of available detectors, Smart Setup switches to a speed-optimized multi-channel strategy with frame-wise switching between the acquisition tracks. This proposal favors speed over cross talk.

The proposal for **Best Signal** follows a strategy that maximizes the efficiency of signal recording and also minimizes the level of cross talk. Multi-color acquisitions using this strategy are typically performed as sequential acquisitions of each dye species with frame-wise switching between tracks.

**Smartest (line)** combines the advantages of **Fastest** and **Best Signal**. This proposal aims to minimize the number of acquisition tracks as well as cross talk. This is achieved by recording dyes with low spectral overlap as a single acquisition track. In addition, **Smartest (Line)** improves the acquisition speed also by performing line-wise switching between tracks whenever applicable.

Unlike in the other modes, data recorded with **Linear Unmixing** (only available if **Show all** is active) will contain substantial amounts of fluorochrome cross talk. This data is meant to be processed (Linear Unmixing) in order to separate individual fluorochromes.

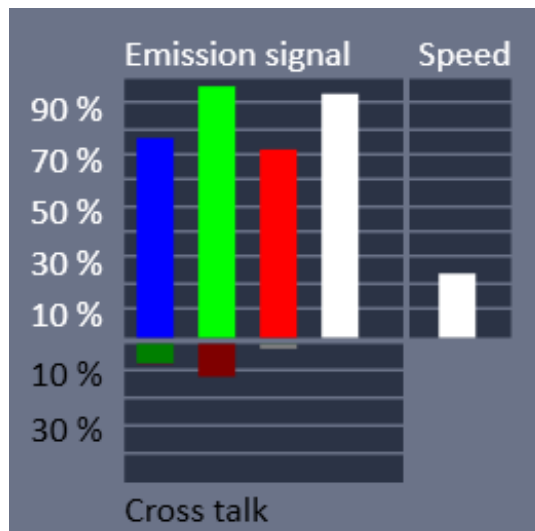


Fig. 74 Smart Setup bar charts

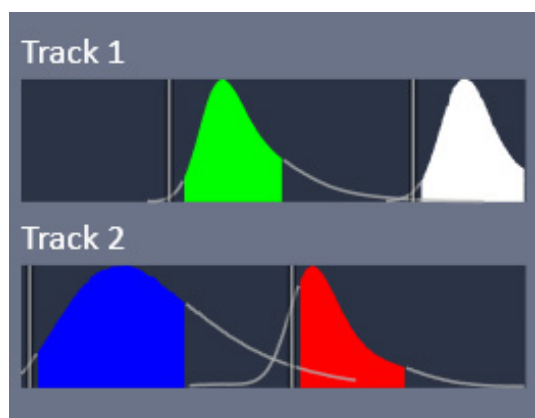


Fig. 75 Smart Setup tracks


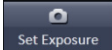
**Smart Setup** displays its proposals side-by-side for optimal comparison. The proposal selected for imaging is highlighted. Key aspects of each proposal are displayed as a bar chart representation.

Such bar charts contain information on the expected emission signal (relative amount of detectable signal with the proposed configuration), cross talk (relative contribution of cross talk) and speed (acquisition speed as percentage of acquisition speed in simultaneous multi-channel recording).

The prediction of the emission signal considers both, the efficiency of fluorochrome excitation and also the detectable portion of the emission.

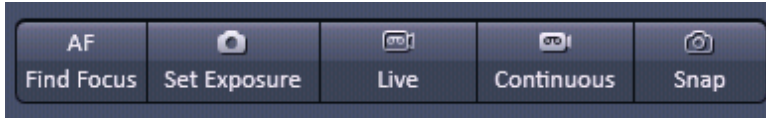
**Smart Setup** displays a bar chart representation of emission signal, cross talk and speed with each proposal. The color-coding specified for the stains is used for displaying the bar charts (Fig. 74).

**Smart Setup** displays the track configuration along with normalized emission spectra of the chosen dyes (as specified in the experiment configuration). Filled spaces of the spectral curves illustrate the portion of the emission detectable in a given proposal (Fig. 75). The illustration also displays the order of track acquisitions upon sequential multi-color recording. Track acquisitions using long wavelength laser lines are performed first.

Pressing the  button applies the selected proposal as well as the motif. If a motif other than **Current** is selected, ZEN applies the proposal, the scanning parameters of the motif and automatically scans an image. Detector settings are automatically adjusted by pressing the  action button.

### 5.2.3 Action Buttons

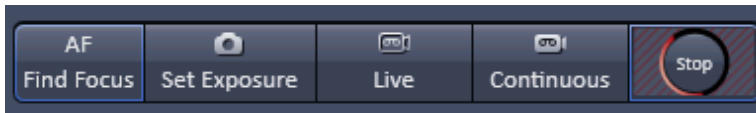
Action buttons provide control for how the image is acquired (Fig. 76).



**Fig. 76 Action buttons**

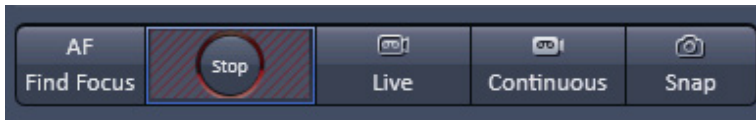
They have the following functions, regardless of the imaging mode:

**AF Find Focus** triggers a frame z-Scan. The system selects the z-position associated with the frame of highest intensity or contrast. **AF Find Focus** can be disrupted by pressing the **Stop** button, to which the **Snap** button changes upon activation (Fig. 77).



**Fig. 77 Action buttons – AF Find Focus button active**

**Set Exposure** optimizes the gain and offset settings (PMT only, for cameras only the exposure time will be adjusted) of all active channels and tracks dependent on the given laser power. **Set Exposure** can be disrupted by pressing the **Stop** button, to which the **Set Exposure** button changes upon activation (Fig. 78).



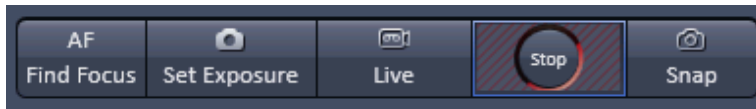
**Fig. 78 Action buttons – Set exposure button active**

**Live** uses the maximum speed for a given image frame (and zoom setting) for all active channels. It will set the resolution to 248 x 248 for the Andor SIM camera, 256 x 256 for the Andor PALM camera and 512 by 512 for single point detectors (PMT, GaAsP). To disrupt **Live** acquisition, the **Stop** button has to be pressed into which the **Live** button changes after its activation (Fig. 79).



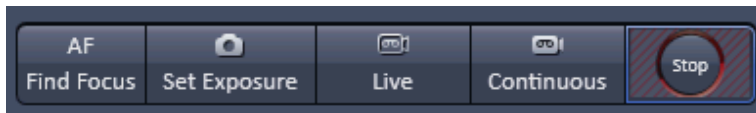
**Fig. 79 Action buttons – Live button active**

**Continuous** produce images from all active channels and tracks, thereby ignoring the settings for multidimensional acquisition, but taking into account the selected imaging mode. The last scanned frame will stay in the image window. To disrupt **Continuous** acquisition, the **Stop** button has to be pressed into which the **Continuous** button changes after its activation (Fig. 80).



**Fig. 80** Action buttons – Continuous button active

**Snap** produces one single image using all active channels and tracks thereby ignoring the parameters activated in the multidimensional acquisition tool group, but taking into account the imaging mode. **Snap** can be disrupted by pressing the **Stop** button into which the **Snap** button changes upon activation (Fig. 81)



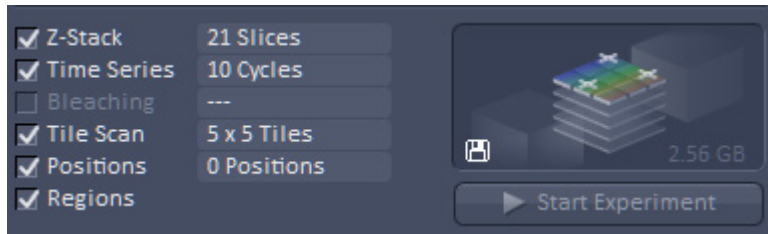
**Fig. 81** Action buttons – Snap button active

☞ All actions buttons (with the exception of **AF Find Focus**) turn into **Stop** buttons once pressed, which can be used to stop the current process or experiment. In the case of the **AF Find Focus** button, the **Snap** button turns into **Stop**.



## 5.2.4 Multidimensional Acquisition Settings

In the **Multidimensional acquisition** field (Fig. 82), the multidimensionality can be defined by checking the corresponding boxes.



**Fig. 82** Multidimensional input field – Z-Stack (with 10 slices), Time series (with 10 images) and Regions active

The following dimensions are available:

**Z-Stack** – Acquisition of an image series in z

**Time series** – Acquisition of an image series in time

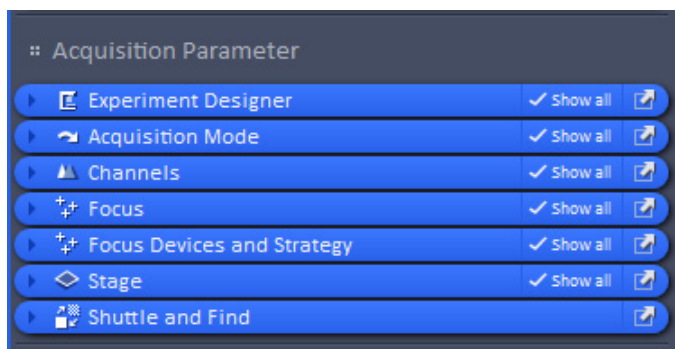
**Bleaching** – Acquisition of a time series including definition of a region to be bleached.

**Tile Scan** – Acquisition of an image series with neighboring field of views (FOV).

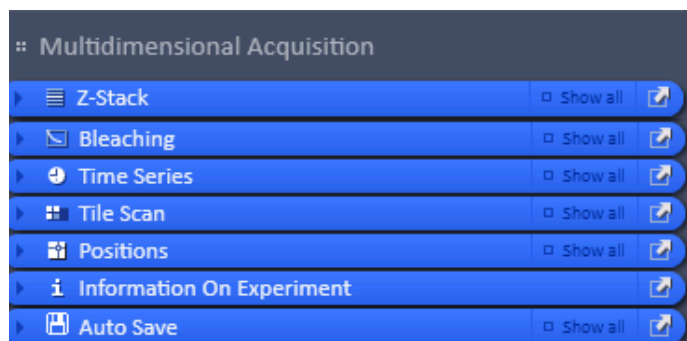
**Positions** – Acquisition of an image series at different positions.

**Regions** – Imaging or manipulation of defined regions of interest (ROI)

The settings for multidimensional acquisition are accomplished within the tool groups **Acquisition Parameter** for **Regions** and **Multidimensional Acquisition** for all other functions. If available the settings are displayed beside the function, e.g. how many images are taken for the time series (Fig. 82). Corresponding tool bars within the tool groups only become available if the box of a multidimensional function is checked; otherwise the tool bar is not displayed (Fig. 83 and Fig. 84). The **graphical display** field above the **Start Experiment** button shows a representation of the experiment type with its dimensions is show. It also lists the estimated size of the final multidimensional image.



**Fig. 83** Acquisition parameter Tool group



**Fig. 84** Multidimensional Acquisition Tool group – all possible tool tabs displayed

- ☞ Note that not all functions are available for all imaging modes. Only those functions that are available can be activated; non-available functions are greyed out and inactive.
- ☞ Note that some functions are mutual exclusive. In this case checking one function will inactivate all other functions that are incompatible with the former.
- ☞ Note that some functions need other functions for a useful experiment. In this case checking that function will activate the other needed functions as well. The latter can be, however, manually deselected, if required.

Pressing the **Start Experiment** button will trigger the image acquisition, taking into account all activated functions. The progress of the experiment in regard to which image the system currently acquires will be shown updated to the right of the functions if available (Fig. 85).



**Fig. 85** Multidimensional input field – display of the current status 9 from 10 slices taken from the 5th of the 10 images

Upon pressing the **Start Experiment** button it turns into a **Finish current step** button, whereas the **graphical display** field turns into a **Stop** button. Pressing the **Stop** button immediately finishes the acquisition. Pressing the **Finish current step** button will interrupt the multidimensional acquisition after the currently performed step; e. g. when performing a Z-Stack over time it will finish the current Z-Stack and then stop the experiment.

### 5.2.5 Setup Manager – Laser


Open (and close) the **Laser** tool (Fig. 86) (only available when the **Show all tools** check box is ticked) by clicking the **Laser** tab in the **Setup Manager** tool group.


Lasers are listed with their **Laser name**, their **Laser lines (nm)** and their **Power** state. Lasers available for ELYRA have the extension **(Elyra)** in their name. Select the power state from the power state switch box. It shows the state of the laser: **On**, **Off** or **Standby**. **Standby** mode is available for some lasers. To activate a laser select **On** or **Standby** to switch the laser on for immediate use or for warm up, respectively. A laser that is in **Standby** will automatically go to **On** state, when in use and go back to **Standby**, when not in use. The Argon laser and Ti:Sa lasers are not set to Standby when not in use, they have to be set to Standby deliberately.

Lasers with no switch button, like the HeNe laser, will be switched on automatically after software start.

The **Laser Properties** panel displays the current wavelength, status, mode (ps or cw if applicable), tube current (Argon laser) and power (Argon and Ti:Sa laser).

When exiting the Software, the **Laser Off** panel will be displayed - unless the checkbox **Lasers off on exit in Maintain / Systems Options / Hardware** is not ticked - showing the current power state of the lasers (Fig. 87). The user has the possibility to manually switch off still active lasers before the software closes. In case the status ON is not changed, lasers are set into standby mode if applicable. Lasers without power status are switched off. The shutter of Ti:Sa lasers will always be closed when the software is shut down.

 After switching on the lasers in the laser control window and their status is displayed as ready (On) the system can be used for imaging. However, for quantitative imaging it is recommended to let the system warm up for up to 2 hours.

 Please bear in mind that a cooling phase of at least 5 minutes is required between switching off the laser via the software and switching off the entire system via the power remote switch.

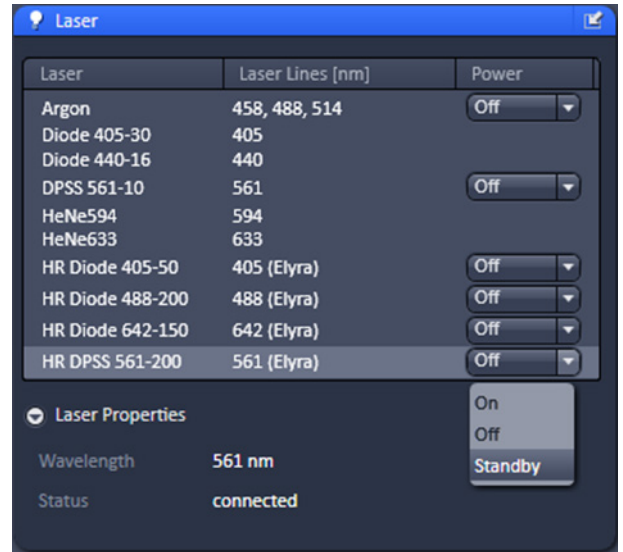


Fig. 86 Laser tool

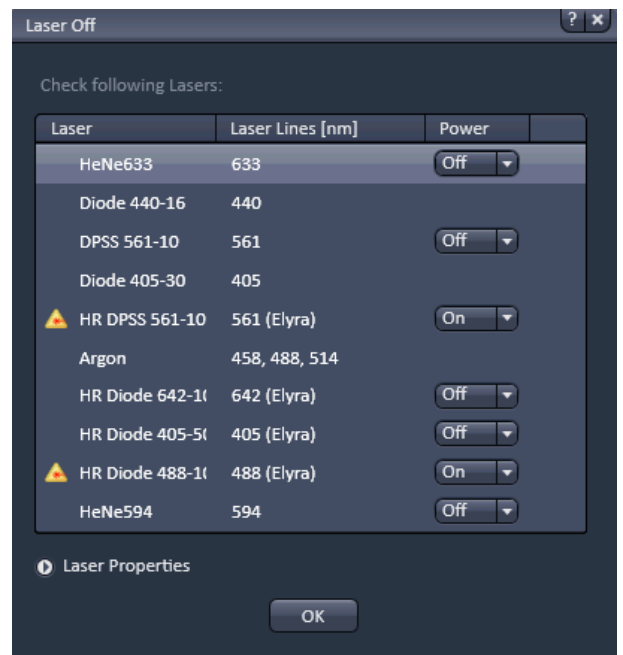
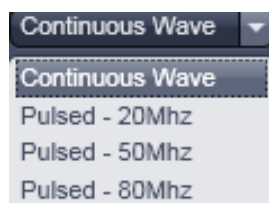


Fig. 87 Laser Off panel



**Fig. 88 Laser menu with Diode 405-30 activated**



**Fig. 89 Mode pull down menu**

## Diode lasers

The LSM 880 can be equipped with Diode 440 and / or Diode 405 lasers that can be used in continuous wavelength (cw) mode or in pulsed (ps) mode (Fig. 88).

Selection of the mode is available in the Mode pull down menu in the **Laser properties** menu (Fig. 89).

You can select between **Continuous Wave** or **Pulsed - 20 MHz, Pulsed - 50 MHz** and **Pulsed - 80 MHz** mode.

The diode lasers are directly modulated. They can be further attenuated once a pulse frequency is selected by ticking the **ND04** check box, which will place a neutral density filter in front of the lasers.

Please note that pulsed modes were specifically designed for Fluorescence Lifetime Microscopy (FLIM) and should be preferentially used for this application. Since laser powers in the pulsed mode are substantially less than in the cw mode, the pulsed mode is not suitable for bleaching experiments. Also signal-to-noise ratios in intensity imaging are less in the pulsed mode compared to cw operation, hence the cw mode should be chosen for high quality imaging.

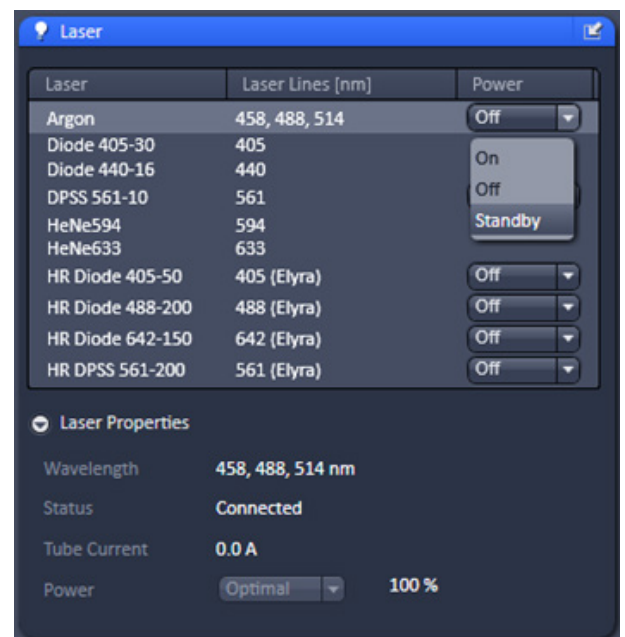
## Argon laser

The Argon laser is a gas laser that is operated in a slightly different way compared to the other lasers. It needs some minutes to ignite and warm up and, being air cooled, needs also some minutes to cool down after it has been switched off. The lifetime is dependent on the the operation mode and messages are provided to help you run it in its optimal mode for maximum lifetime. The laser is integrated in the SW similar to other lasers. Until the laser is in standby mode it does not produce a constant power output. The current status of the laser is indicated at any time during the operation of the system in the Laser Properties panel of the **Laser** tool window.

### Operation of the Argon laser:

1. The laser power supply is linked to the main power switch: Upon switching on the main power of the system, the laser is supplied with electrical power which is linked to the permanent cooling of the laser. The power switch on the laser module itself has to be switched on. The key switch of the laser has to be set to 1 to be able to control the laser via SW.
2. When starting the Software and opening the Laser tool window the laser can be in three states:
  - a. In case the laser is set to Off via the power switch on the laser power supply, the system SW provides a time out error with the message: "Hardware Argon Laser not found. Please check the main switch on the laser electronics." The status report in the Laser Properties panel of the Laser tool window shows the status **Not connected**.  
-> In this case turn the power switch of the laser power supply to On.

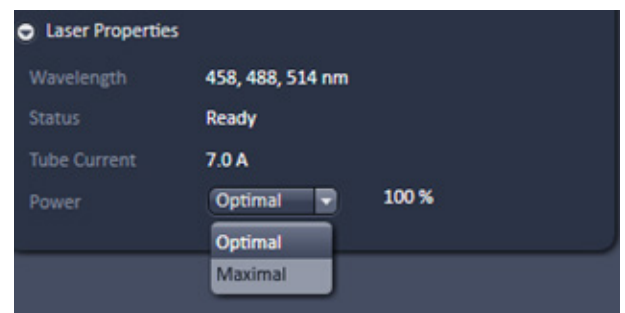
- b. In case the laser is set to On via the power switch on the laser power supply and the key switch on the laser is set to 0, the status report in the Laser Properties panel shows the status **Connected**. When setting the laser to **On** in the laser Tool Window the laser tries to ignite but will fail and the following message does occur after 1 minute: "Laser failure. The laser is not igniting. Please check the key switch at the power supply of the laser! If the failure persists contact your local Zeiss service team."  
-> In this case turn the key switch to 1 to be able to start the laser. Click **On** or **Standby** in the Laser tool window again.
- c. In case the laser is set to On via the power switch on the laser power supply and the key switch on the laser is set to 1, the laser can be started via software and the status report in the Laser Properties panel shows the status **Connected**.
3. The laser is represented in the **Laser** tool window (Fig. 90). A laser warning triangle is depicted next to the word Argon if the laser is in **Standby** or **On**. The laser is started by either choosing On or Standby in the Power drop down menu. The Laser Properties panel shows the status of the laser (**Warming up**) and a time countdown indicates the time still needed for the warm up of the laser until it is either **On** or in **Standby**. During this time and while in Standby the laser wavelengths are marked in red in the Channels tool window to indicate that the laser is not yet operating at its optimal power setting. Once the laser is in **Standby** or **On** its status changes to **Ready**.
4. The Laser Properties Panel indicates the **Tube Current** which is either 0.0 A (Ampere) if the laser is **Off**, 2.0 A if the laser is in **Standby** or 7.0 A (Ampere) if the laser is **On**.



**Fig. 90** Laser tool window showing the status and options for the Argon laser

An additional drop down list next to **Power** in the **Laser Properties** panel becomes active and serves to select an additional power status when the laser is **On** (Fig. 91). Next to the drop down list the power of the laser is indicated as percentage value where **100%** are equal to 25 mW (or 35 mW) of power output (for the 25 or 35 mW Multiline Argon laser respectively). The laser is set to work at 100% providing a constant power output at the **Optimal** operation mode. The tube current is adapted accordingly to match the 100 % output.

For certain experiments you may want to set the laser to its maximum output power. This status is needed for short periods of time (minutes) like for example with a FRAP experiment. To get maximum power open the Laser Properties panel and chose



**Fig. 91** Laser Properties panel indicating the additional drop down for choosing Optimal or Maximal power output of the Argon laser tool window showing the status and options for the Argon laser

**Maximal** in the drop down list next to the Power status. The maximal available laser power changes to a higher percentage value and the value is now indicated in red as well as the higher tube current. **This operation mode reduces the life time of the laser and should only be used for short periods of time.**

### Laser life time

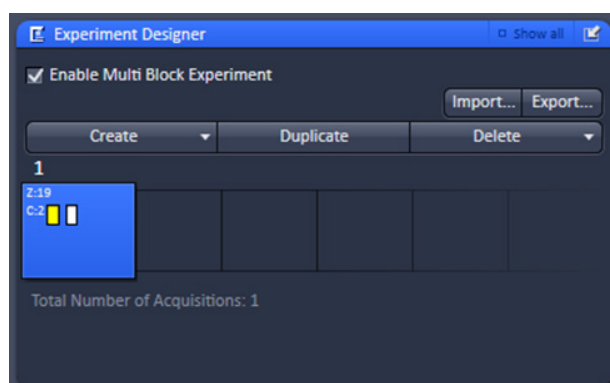
The absolute maximum power varies with the laser and declines over time as the laser is in use. A given tube current will over time produce less and less laser output power. Maximal power should only be set for short periods of time. Once the laser is no longer able to produce 100% output power with the maximal tube current available, the percentage of power and the tube current will also show up in red. With a tool tip you will be reminded, that the laser might reach the end of its lifetime. It can still be operated but its lifetime will decline even faster as it will be operated at high tube current to achieve the 100 or near 100 % of power.

Dynamic range of laser does not support all desired settings. Not all settings could be applied.

**Fig. 92** Warning message in the Channels tool window when exceeding the dynamic range of the AOFT / laser power settings

### Laser dynamics

The regulation of the all visible laser lines (458 nm up to 633 nm) is achieved via AOTF. The amount of power is proportional to the electric power generating the acousto-optic wave in the AOTF crystal. The AOTF crystal can deal with up to 8 laser lines in parallel. However, if the power settings for the individual lasers differ by at least an order of magnitude, interferences can occur between the lines and the laser power can vary during imaging when applied. In this case a warning shows up in the **Channels** tool window (Fig. 92) and the higher power setting for the AOTF will be reduced.



**Fig. 93** Experiment Designer tool

### 5.2.6 Setup Manager – Experiment Designer

Experiment Designer combines different multi-dimensional acquisition parameters with each parameter setting assigned to one imaging block in one total experiment described as Multi Block Experiment. Click the **Experiment Designer** tab to open or close the tool window (Fig. 93).

There is *always* one blue Block (Active Acquisition Block) present with the active acquisition parameters assigned to it.

Changing acquisition parameters *always* effects acquisition parameters of the active acquisition block even if the Experiment Designer tool is not open and/or not enabled.

When **Enable Multi Block Experiment** is checked, all functions within the tool become accessible.

---

The active acquisition parameters include all settings of the following tools:

- Imaging Setup
- Acquisition Mode
- Channels
- Focus Devices and Strategy
- Z-Stack
- Time Series
- Tile Scan
- Positions
- Regions
- Bleaching

The blue block is the active acquisition block. A Block can be activated (blue) and selected (enlarged) with a right mouse click or choosing **Activate** from the context menu of the left mouse click. Hardware and software is then changed to match the acquisition parameters of this activated (blue) block.

A left mouse click only selects a block (enlarged) but does not activate it (still grey). Hard- and software settings are not changed, they still represent the settings of the blue block. Wait and Delay blocks can be selected with a right or left mouse click. With a left mouse click a context menu opens which allows to **Disable/Enable** a block.

Disabled blocks are crossed out and will not be executed within the experiment. If only one acquisition block is present it cannot be disabled. Disabled blocks have to be enabled first before they can be activated.

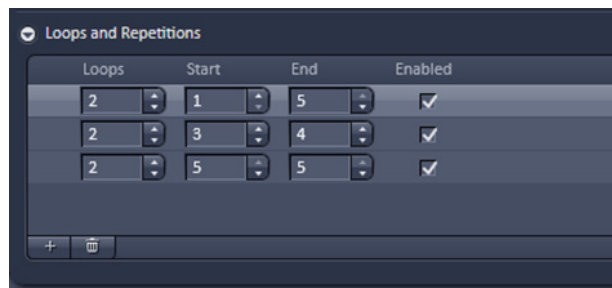
New Blocks are added using the **Create** drop down list:

- A **Acquisition Block** is used for image acquisition which is performed according to the acquisition parameter settings
- A **Delay Block** sets a time delay between two blocks (not effective if defined as the very last block of a Multi block experiment). The delay time is set using the Delay slider which shows up when selecting a Delay Block. The time unit can be selected from the drop down list ranging from milliseconds (ms) to days (d).
- A **Wait Block** pauses the acquisition until the user actively confirms the message box. The message of this box is typed into the editing field which shows up when a Wait Block is selected.

Use **Duplicate** to create a duplicate of the selected block. The duplicated block will be added as the last block. It will be active and selected.

Each Block icon shows as smaller icons or in writing its content like the delay time, the message or the acquisition dimensions (T for time, Z for Z-Stack, C for Channels, P for Positions and M for Tile scan).

The number of enabled acquisition blocks of the total Multi Block experiment is indicated underneath the row of block icons.



**Fig. 94** Loops and Repetitions panel of the Experiment Designer tool

Loops and Repetitions are set (in **Show all** mode) in the **Loops and Repetition** panel. Use the arrow to open the panel (Fig. 94). The number in the **Loops** column states how often a sequence of Blocks defined by the number of the Block in **Start** and **End** is run. One loop/repetition is set as default and reflects the minimum of running the experiment once. Set the Loops value to 2 to perform the defined sequence twice. Repeat one Block by choosing the same number for Start and End. A yellow triangle shows up if a sequence cannot be performed for example if the end block is before the start block. Whenever a block being part of a sequence is reached, the defined number

of loops is performed. Thus outer loops also contribute to the number of total runs of an inner loop. Add a new row of loop settings by clicking the + button. Highlighted rows are removed by clicking the waste bin button. Rows of settings need to be checked in the **Enabled** column to be executed.

Use the **Export...** button to store a complete Multi Block experiment or selected Blocks under a **Name** of choice typed into the editing field. Within the **Export Experiment Blocks** dialogue you can **Select All** or **Deselect All** blocks using the corresponding buttons. Single blocks are selected/deselected with a mouse click. **Export** stores the selected block(s) under the chosen name.

Use the **Import...** button to load a Multi Block experiment or selected Blocks of an Experiment. Within the **Import Experiment Blocks** dialogue chose a name from the **Experiments** list with mouse click. **Select All** or **Deselect All** blocks using the corresponding buttons. Single blocks are selected/deselected with a mouse click. Delete removes the highlighted name/experiment from the list. **Import** adds the selected block(s) to the already existing block(s) of the Experiment Designer.

Pay attention to the following guidelines for the Experiment Designer

- Each Block and looped Block is (saved as) a separate image file
- Auto Save settings apply to the complete Multi Block experiment
- Image files are automatically named consecutively keeping the number for the image constant for a given Multi Block Experiment. The Block number always starts with 1 and the number is consecutive within the experiment.
- Use the Macro "ConcatenateImages70.lvb" to combine still open images into one consecutive time series. See Chapter on Macros for further explanations.
- Use the Macro "ModifySeriesZEN.lvb" to combine already already saved images into consecutive time series iamges. See Chapter on Macros for further explanations.
- Set desired stage position(s) for each new block separately using the Positions Tool. For multi-position experiments in combination with Z-Stack acquisition the Z coordinate from the Position list is referring to the center position of the Z-Stack.
- Bleaching experiments are restricted to one position per Block. If more than one position is defined for a Block, Bleaching is disabled.
- Positions and Regions are not saved with the experiment, only with the image. Positions cannot be reused from the resulting image but have to be stored as separate position list(s). See also section 5.2.20.1 on using position lists.



- Autofocus Strategies use the center position of a Z-Stack as the reference position. For a given Z-Stack go to the center position and if necessary, click Center within the Center tab of the Z-Stack tool once to confirm the reference.
- All imaging modes defined in the Imaging Setup Tool (i.e. WF, LSM) can be assigned to different Blocks and used in mixed mode experiments.
- FCS measurements cannot be performed using Experiment Designer

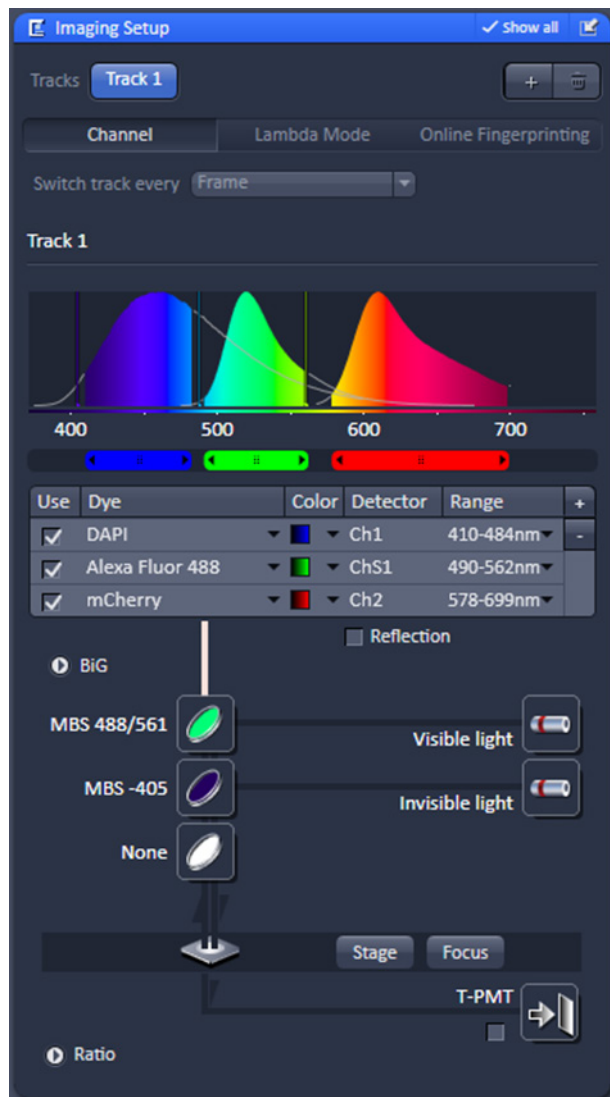


Fig. 95 Imaging Setup tool

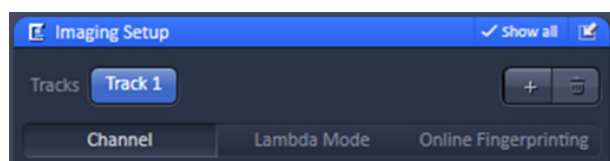


Fig. 96 Imaging Setup tool – imaging mode selection menu

## 5.2.7 Setup Manager – Imaging Setup

The **Imaging Setup** tool (only available when the **Show all tools** check-box is ticked) allows new/existing beam path configurations to be created/edited and saved for the different imaging modes.

- Click on the **Imaging Setup** tool or close the tool window (Fig. 95).

The **Imaging Setup** tool is divided in the

- Imaging mode selection
- Beam path configuration
- Ratio Imaging panel

### 5.2.7.1 Imaging Mode and Track Definition

Different imaging modes can be selected by activating the respective tab (Fig. 96).


The following imaging modes are available:

- Channel
- Lambda Mode
- Online Fingerprinting

When in **Channel** mode the image acquisition can either be done in one Track (all lasers and detectors active simultaneously) or in up to 4 tracks (Fig. 97).

Configurations for each track are thereby defined in the **Beam path configuration** field for the selected track. To create a new track configuration, highlight the track. Go to the **Beam path configuration** to set up the beam path. You can store the track configuration in the **Experiment Manager** field. The configuration also includes the settings of laser power, detector gain and offset to be selected in the Channels tool window (see section 5.2.6).


Tracks can be added or deleted by pressing the **+** or **dust bin** button, respectively. The **dust bin** button is inactive if only one track is defined. Up to 4 tracks can be added. The **+** button becomes inactive after the 4<sup>th</sup> track has been added. An added track will have the same filter settings than the first track, which can be subsequently changed in the **Beam path configuration** field. The **Track** button of the selected **Track (1-4)** will be highlighted in blue and the **Track display** area below designates the track that is displayed in the **Beam path configuration** field. All alterations will be specific for that track.

 If all channels of a track are deactivated this track will be deactivated, too.

With the **Switch track every** drop down menu (only available if **Show all** is active), you can select the way tracks are switched. The different tracks can be switched every **Line** (available for **LSM imaging** mode only), every **Frame**, every **Frame Fast** and every **Z-Stack** (if Z-Stack acquisition is checked) (Fig. 98).

In **Line** and **Frame Fast** mode, switching of hardware components that require mechanical movement like filter change is prevented and hence the setting of the first track remains in place, even if the other tracks have different configurations.

The latter parameters are therefore overwritten by those from the first track. Only those settings that do not require mechanical movement are accepted like activation/deactivation of laser lines and channels, and laser power settings. You will be prompted in an Info window to allow parameters to be overwritten when using **Line** and **Frame Fast** switching modes (Fig. 99). Press **Yes** to accept parameters to be overwritten. Press **No** to return to **Frame** or **Z-Stack** switching mode, where all settings will be kept for each track. Note, that if mechanical switching is required, switching time will be accordingly slow.

 The total set of parameters for one or multiple tracks can be stored as the active acquisition parameters using the save option of the **Experiment Manager** field. Using multiple tracks is the preferred method to clearly separate weakly overlapping emission signals.

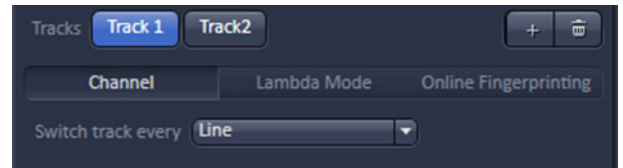


Fig. 97 Track definition

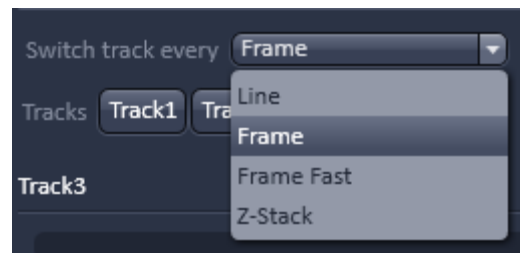


Fig. 98 Switch track every drop down menu

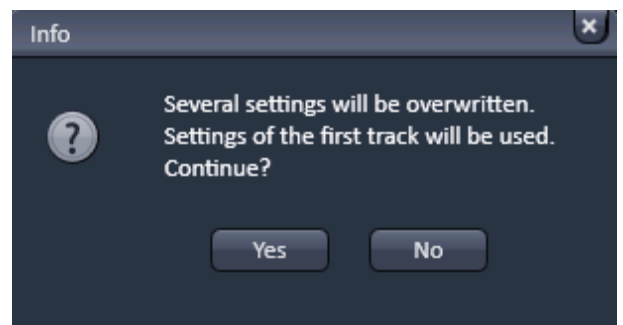


Fig. 99 Info window to confirm



Fig. 100 Filter cube selection

### 5.2.7.2 Filter Cube Selection

The filter cube can be selected from the reflector turret via a graphical pop-up menu when the **Filter cube** button is pressed (Fig. 100).

There are six positions for the filter cube. 2 positions (positions 1 and 2) are for push and click filters. **None** (no filter cube) is needed for the **LSM imaging** mode and must be assigned to position 1 as this position will be automatically selected in the **LSM** imaging mode. The other position (position 2) can be equipped with a cube that is suitable for widefield excitation and observation through the eyepieces.

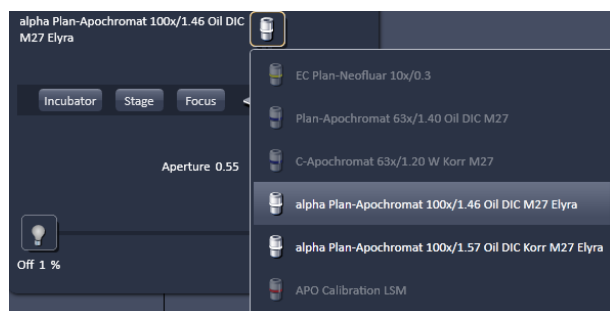


Fig. 101 Objective selection – appearance of Laser WF imaging mode

### 5.2.7.3 Objective Selection

The objective can be selected via the graphical pop-up menu when pressing the **Objective** button (Fig. 101).

Those objective, which are suited for a certain imaging mode are highlighted, but all objectives can be selected.

### 5.2.7.4 Stage Control

If the **Stage** button is pressed, the **Stage** control panel will appear (Fig. 102).

By pressing the **Stop** button you can interrupt any stage movement.

The **Move to Zero** button will move the stage to the current zero positions of the x and y coordinates. The compass rose will move the stage in the direction of the arrowheads.

Fast movement is obtained with the outer rose, slow movement with the inner rose.

The **X-Position (µm)** and **Y-Position (µm)** display boxes show the actual x and y coordinates. You can edit the numbers by typing or using the arrowheads. If numbers were altered, the first click on the compass rose will bring the stage to the altered position.

The **Step Size (µm)** display box shows the currently used step size for stage movement. The value can be edited by typing or using the arrowheads.

The **Zero Position Set** button sets the x and y coordinates to 0.

If the **Mark** button is pressed, the current position will be stored.

Pressing the **Move to button** will bring the stage back to this position. By pressing **Remove**, the actual displayed position will be deleted. Pressing **Remove All** will delete all stored positions.

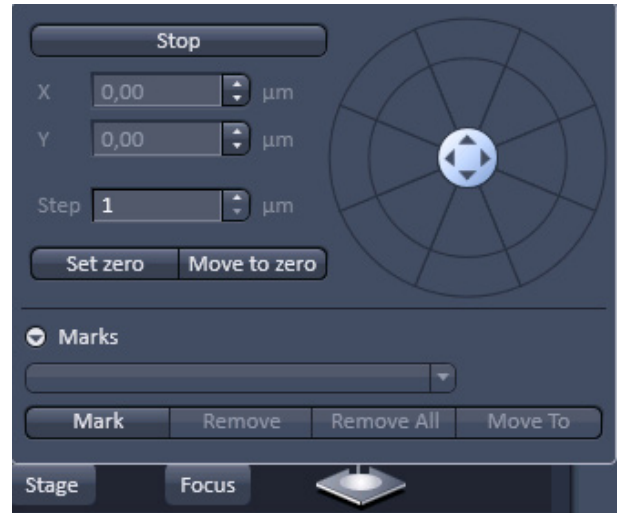


Fig. 102 Stage control – expanded view

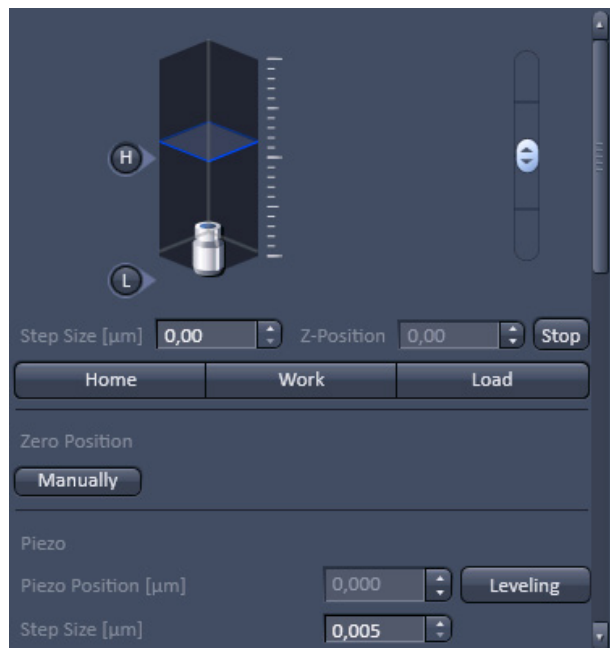


Fig. 103 Focus control – expanded view

### 5.2.7.5 Focus Control

If the **Focus** button is pressed, the **Focus** control panel will appear (Fig. 103). The **Z-Position** display box shows the current z-position. The number can be edited by typing or using the arrowheads. The nosepiece or stage will automatically update the new position.

By pressing the **Stop** button, you can stop the current movement.

The **Step Size (µm)** display box shows the currently used step size for focus movement. The value can be edited by typing or using the arrowheads.

The **Home** button sets the z-position to the predefined zero value. Pressing **Load** will lower the nose piece (z-position) for objective change.

**Work** brings the z-position back to the actual used position if the focus was zeroed or in **Load** position. **Home** and **Load** positions can also be accessed from the z-position slider by pressing the **H** or **L** buttons. The z-position can be altered by grasping and sliding the **plane** or by using the arrow slider. The **plane** shows the actual z-position.

Pressing **Manually** in the **Zero position** field will set the current z-position to 0.

If a Piezo stage insert is in use and active then pressing **Levelling** in the **Piezo field** will center the Piezo stage position at the current focus position of the microscope focus drive.

The **Piezo Position (µm)** input box allows the position of the Piezo to be altered. The **Step Size (µm)** display box shows the currently used step size for focus movement of the Piezo stage.

The Scroll bar allows accessing the whole **Focus control** panel.

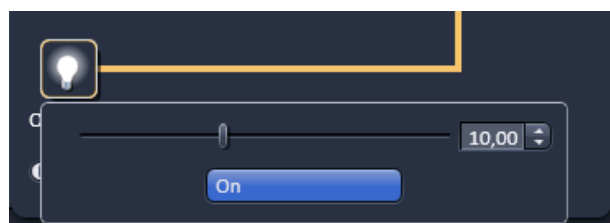


Fig. 104 HAL control

### 5.2.7.6 HAL Control

When the **HAL On/Off** button (only available for **WF** imaging mode) for transmitted light of the halogen lamp is pressed, the control panel for the light settings is displayed (Fig. 104).

If you press the **On** button, the light intensity of the **HAL** lamp can be varied via the input box or slider. The light path will be highlighted by color in the diagram. Press the **On** button again to shut down the light.

### 5.2.7.7 X-Cite Control

When the **X-Cite On/Off** button (only available for **WF** imaging mode) for reflected light of the X-Cite or HXP lamp is pressed, the control panel for the light settings is displayed (Fig. 105).

If you press the **On** button, the light intensity of the **X-Cite** or **HXP** lamp can be varied via the input box or slider. The light path will be highlighted by color in the diagram. Press the **On** button again to shut down the light.

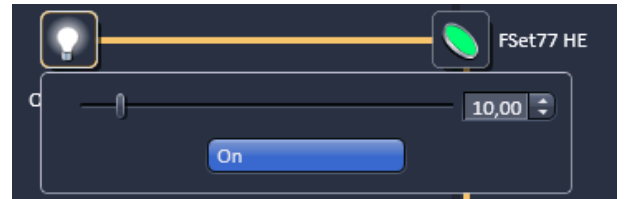


Fig. 105 X-Cite or HXP control

### 5.2.7.8 Aperture Control

When the **Aperture** button (only available for WF, SIM and **Laser WF** imaging modes) is pressed, the aperture size of the motorized condenser can be defined by typing or by using the slider or arrowheads (Fig. 106).

The **Filter** pull down menu allows to select the filter (available only in WF imaging mode) suitable for the objective in use.



Fig. 106 Aperture control

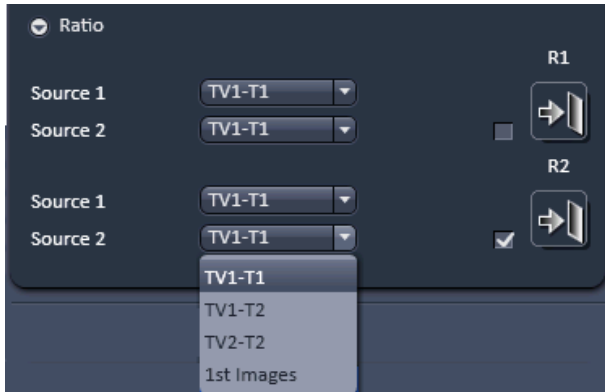


Fig. 107 Ratio imaging panel



Fig. 108 Color selection table



Fig. 109 Laser control panel

### 5.2.7.9 Ratio Imaging

In the **Show all** mode Ratio imaging becomes available (only for **WF** and **LSM** imaging modes).


A click on the arrow next to **Ratio** provides access to the **Ratio channel interface** panel (Fig. 107).

A maximum of two ratio channels (**R1** and **R2**) can be activated by ticking the respective check box. These channels can display the ratio between two of the active imaging channels.

The source channels for calculating the ratio have to be selected from the **Source 1** and **Source 2** drop down menus. As an alternative to a second channel for the ratio imaging it is also possible to choose the **1st images** of a time series of one channel for the ratio metric calculation.

The parameters for the calculation are set in the **Channels** tool of the **Online Acquisition** tool group.

A suitable color can be assigned to each of the two Ratio Channels **R1** and **R2** if their icons are pressed (Fig. 108). The scroll bar allows access to all listed colors.

 The ratio to be formed between the selected channels can be defined more precisely using one of the four preset formulas in the **Channels** tool of the **Online Acquisition** tool group after a click on the relevant ratio button (e.g.: **R1**). The **Set by min/max** function (in **Channels** tool) allows the definition of the display scaling according to the expected minimal and maximal values.

### 5.2.7.10 Laser Control

Press the **Laser** button to display the laser control expansion submenu (Fig. 109).

Activate the lasers you want to use by checking the corresponding boxes.

The used laser line with sliders will appear.

Set the requested laser attenuation (%) using the sliders, the arrows, or typing in the display field.



### 5.2.7.11 Control Elements of the Imaging Setup Tool

This tool displays the hardware settings of the scan head (**LSM** tab), the beam path to image with the camera (**WF** tab) or the Non descanned Detectors (**Non Descanned** tab). The settings can be changed in the corresponding tab and used for a new imaging configuration.

#### Channel Mode

The **Channel** tab (Fig. 110) displays the current hardware settings within the scan head for an imaging track (for LSM or Non Descanned mode).

This mode uses one or more detectors as single channels with defined imaging parameters.

Chose 1 or more Tracks for the imaging set up.

Activate the detector channels by checking the box(es) in the Use column. Detectors can be added/removed (depending on the hardware) clicking the plus / minus button.

Assigne a Dye to the detector in the Dye column.

Assign a LUT color to the detector in the Color column.

Either use the mouse to grab, expand and move the bar(s) representing the spectral detection band in the graphical display or type in the lower and upper border of the detection band in the editing fields (Fig. 111) by clicking on the number field or the arrow in the Range column.

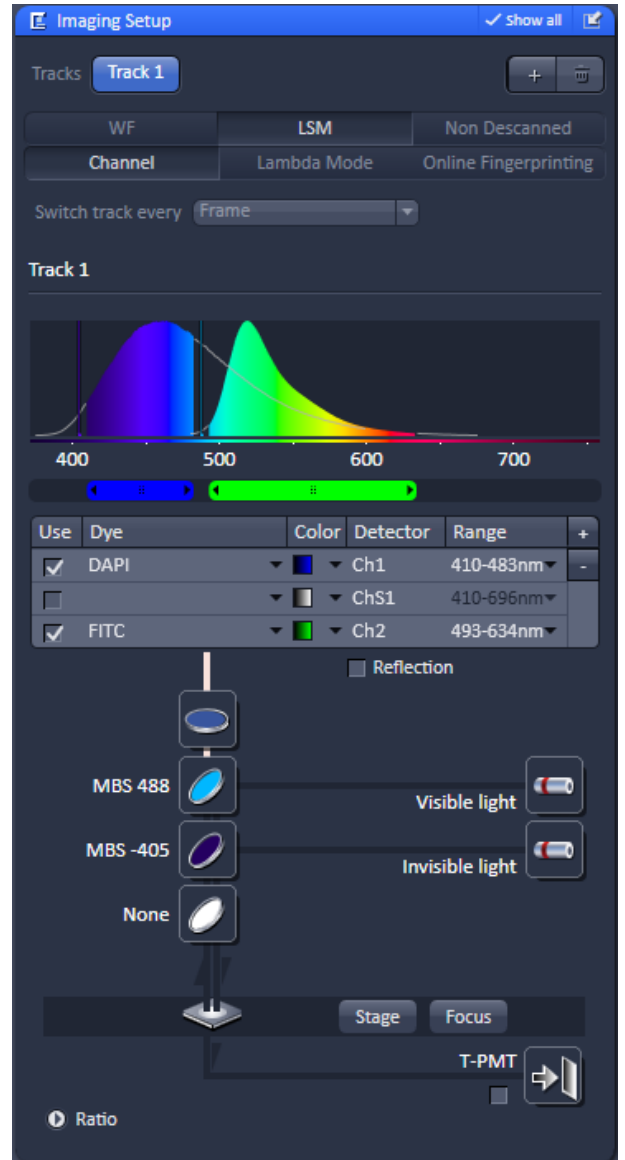


Fig. 110 Imaging Setup tool

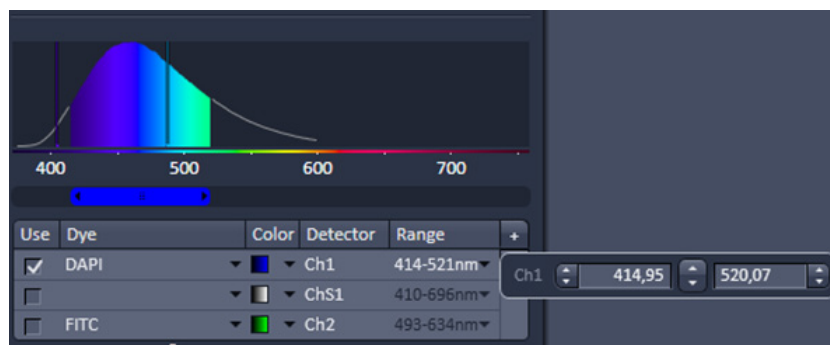


Fig. 111 Control interface to activate detector channels and define the spectral emission band for each detector

Set the main beam splitter(s) for the excitation of the dyes and activate the according laser lines. To select a beam splitter, click on the icon and chose the desired one from the drop down menu.

A beam splitter is chosen according to the selected laser line(s). It separates the excitation light from the emission signal. These filters reflect the wavelength indicated and transmit all other wavelengths.

Make sure there is no filter in the reflector turret (None) or (for a scan head mounted to the rear port of a inverted microscope) it is set to the mirror position (Rear).

For working in non descanned mode (multiphoton imaging) please refer to CHAPTER 5: MULTIPHOTON LASER SCANNING MICROSCOPY WITH LSM FAMILY SYSTEMS.

### **Lambda Mode**

The **Lambda** mode is chosen for imaging heavily overlapping emission signals. When choosing this mode by activating the **Lambda** mode button display changes to show the currently active laser line(s) and the detection range of the QUASAR detector.

With this imaging mode, it is possible to acquire an intensity image displaying the intensity of the fluorochrome(s) within a spectral bandwidth of 10 nm. According to the detection range that is set for the QUASAR detector, a specific number of such images is acquired which is called a Lambda stack.

These image data provide the intensity information within the selected detection range for each pixel. Therefore, the data allow deducing an emission spectrum for each pixel corresponding to the emission spectrum of a specific dye.

This calculation is done by linear unmixing (see section **Unmixing View**) using the acquired Lambda stack and allows to clearly separate even heavily overlapping emission signals.

A workflow similar to the Channel mode is applied. The number of scans changes with the hardware (settings). A full spectrum can be acquired with one scan using a 32 channel Quasar detector with or without the flanking PMTs and a spectral resolution of 8.9 nm or higher. For all other combinations like using a three channels Quasar or a higher spectral resolution more scans are required for spectral imaging. The spectral resolution is set in the Range column.

### **Online Fingerprinting**

The imaging mode **Online Fingerprinting** is based on the acquisition of a Lambda stack. It requires using already available emission spectra from the dyes which are used as markers in the imaged specimen. The choice of the emission spectra and the setting of the detection range for the QUASAR detector are defined in the loaded configuration or using the **Imaging Setup** tool.



Within the Use column the spectra of the dyes for unmixing are chosen /added.

The detection range is equal for all dyes. When changing it for one dye it will be changed for all other dyes.

All other tools are controlled as described for the Channels mode.

For best results, the settings for Online Fingerprinting should match the settings of the Lambda Mode when the dyes were acquired for defining the reference spectra.

### Activation/Deactivation of Channels

- To activate a channel for imaging, check the check box next to channel icon. To deactivate the channel uncheck this box.
- Use Channel T-PTM (transmission channel) to acquire an image with transmission illumination using any laser for excitation. This image will display the differential interference contrast (DIC) of the specimen if the according optical hardware for this contrast is put into the beam path in front of the detector. Check the manual of the microscope for setting DIC optics. Be aware that the laser light is already polarized and therefore a polarizer device is not necessary for transmission imaging. This imaging mode allows displaying a DIC image simultaneously to the fluorescence signal of the specimen.
- To assign a specific color to the image of a channel click onto the  color triangle and select a color from the drop down menu (Fig. 112).
- To set the dye click onto the  dye triangle and select it from the drop down menu.



**Fig. 112** Drop down menu for selection of the channel color

### Reflector Turret

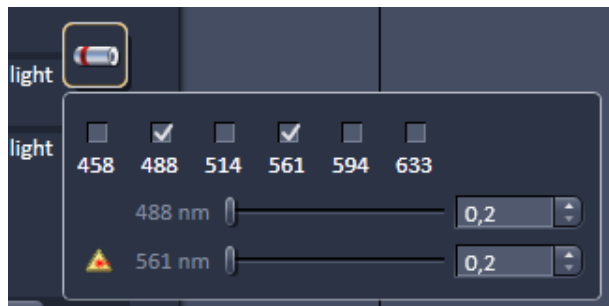
The filter wheel FW1 is the reflector turret of the microscope that holds push-and-click filter cubes and fixed beam combiner cubes. When using the LSM for imaging the filter wheel is automatically set to an empty position if not otherwise defined or set by loading an imaging configuration. Standard fluorescence filter cubes are used for observation of the specimen with the eye or with the camera. A click on the icon opens a drop down menu from which the desired filter can be chosen.

### Stage / Focus

This icons provide access to the control for the focus (position of the specimen in Z) and the stage (position of the specimen in X and Y). But detailed description is given in section **Focus Control** and section **Stage Control**.

### Setting of Laser Line and Laser Attenuation

The **Laser** icon provides access to the control of the laser lines and their attenuation (Fig. 113). Activate a laser line by checking the according box. This opens the attenuation slider and input box, which allows setting the desired laser power. Make sure the laser line is indicated as active with a warning triangle. If this is not the case, go back to the **Laser** tool and switch on the laser.



**Fig. 113 Laser line selection and attenuation**

- Use the slider to set the utilisable laser intensity (recommendation: start at 1 %).
  - The transmittance of the Acousto-Optical Tunable Filter (AOTF) changes accordingly. This allows adapting the laser intensity very sensitively to the job.
  - No more than 8 excitation laser lines (wavelengths) can be active at the same time. If more than eight laser lines are connected to the system the Switch button is active and the required laser lines (if not displayed) must be allocated.
- For this purpose, click on **Switch** and select the required laser line that should be switched to the one not yet displayed.

### Multiple Tracks Configuration


The **sequential** imaging of **tracks** permits several tracks to be defined as one configuration for the scan procedure, to be stored under any name, reloaded or deleted (see also section **Acquisition Parameter – Channels**).

The multiple tracks can either be configured manually one after the other (identical to a single track) and then stored as acquisition parameters, or already existing acquisition parameters can be used and changed as required.

It is also possible to load already stored track configurations (single tracks) in a recording configuration (Available in the **Channels** tool window).

The setup is done using both the **Channels** tool and **Imaging Setup** tool.

In the **Imaging Setup** tool chose **Channel Mode** as the mode for image acquisition and define the hardware parameters like Laser line, laser attenuation, main and secondary dichroic beam splitters, and emission filters for the first track as described above. Ideally the parameters should be stored as a **Track**. Add a second **Track** within the **Channels** tool. Make sure it's selected (highlighted) before switching to the **Imaging Setup** tool. Again set the hardware parameters in this case for the second track, and store them under a different name as a Track in the **Channels** tool. If more than two tracks are requested, repeat this procedure accordingly. Finally the total combination of tracks is stored as imaging **Configuration** in the **Channels** tool.

 When storing the acquisition parameters all the settings of the **Imaging Setup** plus Gain (Master), Digital Offset, Digital Gain and Data Depth (see section **Acquisition Parameter – Channels**), the scan parameters like **Frame Size, Zoom, Rotation & Offset**, and **Scan Direction** parameters (see section **Acquisition Parameter – Acquisition Mode**) are stored.

## Ratio Imaging Configuration

In the **Show all** mode of the **Imaging Setup** tool two additional ratio imaging channels **R1** and **R2** can be defined. These channels are displayed in addition to the maximum of 8 active imaging channels. They provide the possibility to display the ratio between two of the active channels.

A click on the arrow next to **Ratio** in the lower part of the **Imaging Setup** tool window (Fig. 114) provides access to the ratio channel interface. A maximum of two ratio channels can be activated.

These channels can display the ratio between two of the active imaging channels. The source channels for calculating the ratio have to be selected from the drop down menu next to Source 1 and Source 2. As an alternative to a second channel for the ratio imaging is also possible to choose the first images of a time series of one channel for the ratio metric calculation (e.g. to calculate  $F/F_0$  for single wavelength dyes). The parameters for the calculation are set in the **Channels** tool (see section **Acquisition Parameter – Channels**).

A suitable color is assigned to each of the two **Ratio Channels R1** and **R2**, in the same way as for the photomultiplier channels.

- ☞ The ratio to be formed between the selected channels can be defined more precisely using one of the four preset formulas in the **Channels** tool window after a click on the relevant ratio button (e.g.: R1) for online display of radiometric or single wavelength dyes. The Set by min/max function (in **Channels** tool window) allows the definition of the display scaling according to the expected minimal and maximal values.



**Fig. 114** Ratio channels in the Imaging Setup tool



**Fig. 115** Imaging Setup tool window; Lambda Mode activated

## Imaging in Lambda Mode

(to be selected in the **Imaging Setup** tool).

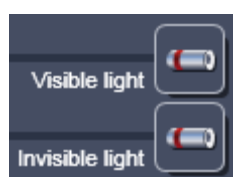
The **Lambda Mode** is recording the overall emission from the sample onto a wavelength-dispersive element and is imaged on a 34-channel detector. All 34 photomultipliers of the detector cover a spectral width of approximately 360 nm, a single PMT covers a spectral range of 8.9 nm. In the **Lambda Mode**, images, image stacks, or time series are recorded in a wavelength selective way.

This new image format is called Lambda Stack. For the acquisition of a Lambda Stack, the complete fluorescence signal can be read out at once. The settings of the beam path for the **Lambda Mode** scanning procedure with regard to the main dichroic beam splitter and the QUASAR detector settings are performed in the **Imaging Setup** tool (Fig. 115).

The QUASAR detector is displayed for spectral imaging if **Lambda Mode** has been chosen as imaging configuration.

The **Imaging Setup** tool displays the laser lines, the main (dichroic) beam splitter, and the spectral range of the QUASAR detector.

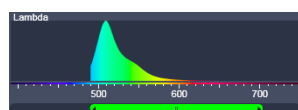
You can change the settings using the following function elements:



Activation / deactivation of the excitation wavelengths (checkbox) and setting of excitation intensities (slider).



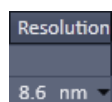
Selection of the main dichroic beam splitter (MBS) through selection from the relevant list box.



Definition of number of PMTs out of the 34 PMT Detectors to fit the required spectral range.



Access to the focus control (see section **Focus Control**)



Step width in spectral range (8.6 recommended).



Activation / deactivation of reflection.

**QUASAR detector settings**

Use the two sliders to define the spectral detection range of the QUASAR detector.

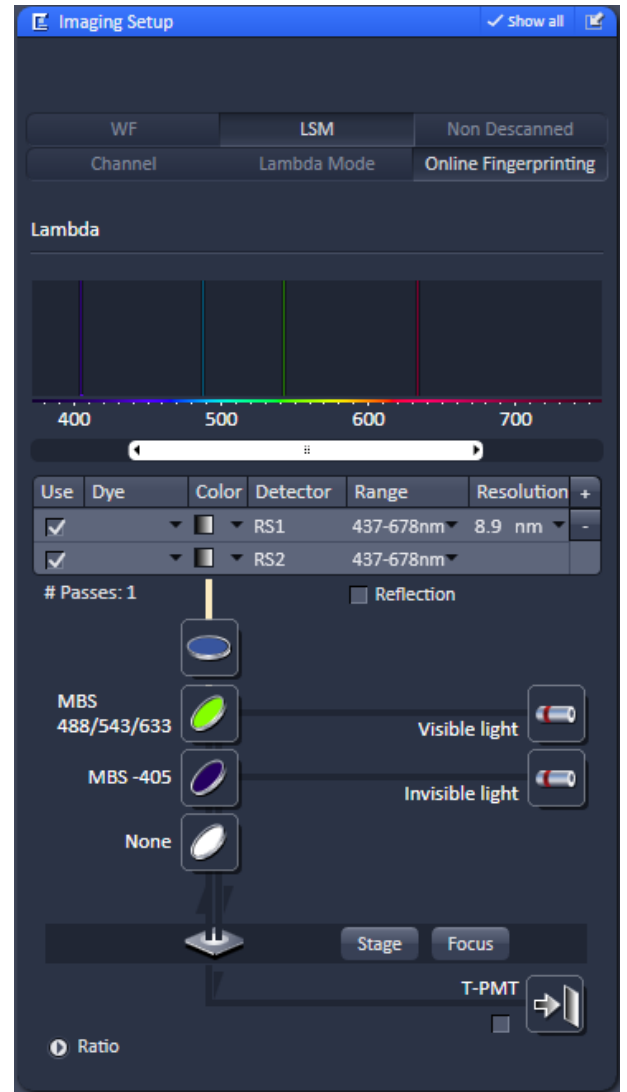
**Resolution:** Step size can be 3.0, 4.4, 8.9, 17.8, 26.7 or 35.6 nm.

**Online Fingerprinting Mode**

(to be selected in the **Imaging Setup** tool).

The use of this function permits the selection of reference spectra together with the excitation settings, allowing an immediate display of the unmixed images while scanning. Chose **Online Fingerprinting** in the **Imaging Setup** tool.

You can change the settings using the function elements which have been described for the **Lambda Mode** plus the following:



**Fig. 116** Imaging Setup tool window; Online Fingerprinting mode

**RS1 ... 8**

Use	Dye	Color	Detector	Range	Resolution	+
<input checked="" type="checkbox"/>		<span style="color: red;">■</span>	RS1	415-690nm	8.6 nm	-
<input checked="" type="checkbox"/>		<span style="color: green;">■</span>	RS2	415-690nm		

Menu for selecting a display color and reference spectra (reference spectra derive from earlier experiments via Mean of ROI functionality or ACE tool). The unmixed results are displayed during scanning and Lambda Stack data will neither be displayed nor stored.

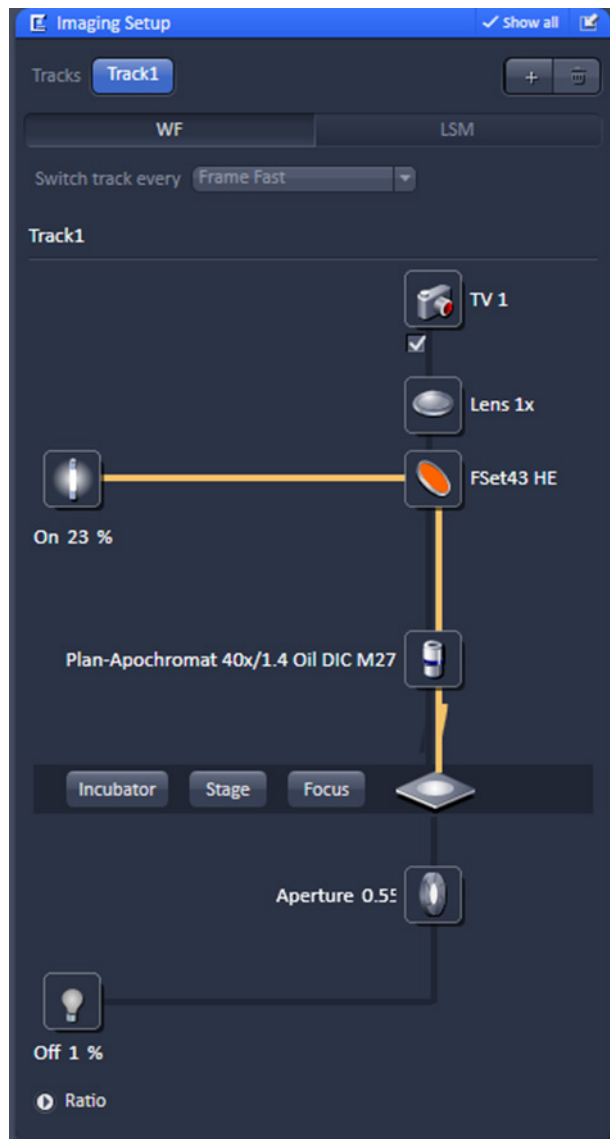


Fig. 117 Imaging Setup tool: WF mode

### WF Mode (Widefield Camera Mode)

The **WF** mode (widefield camera mode) displays the current hardware settings for an imaging track using the camera as detection channel. The display changes in accordance with the selection of a track in the **Imaging Setup** tool.

The **WF** mode provides access to the conventional illumination sources, the halogen lamp and HBO (X-Cite 120 / HXP). It also provides access to the condenser lens aperture and filters and the tube lens.

The use of this function permits the use of a Zeiss AxioCam camera (various models, see ANNEX for description) as an alternative external detector.

The camera can be used with the transmission illumination source halogen lamp, which allows acquiring a standard transmission image or, depending on the optics of the microscope, a differential interference contrast image.

When the HBO (or X-Cite 120 / HXP) is used as an illumination source a standard fluorescence image can be acquired. In this case a specific fluorescence filter cube has to be chosen in the reflector turret filter wheel.

A corresponding tube lens (1x or 0.63x) should be used.



### 5.2.7.12 Setup Imaging with Airyscan Detector

#### Acquisition, Imaging Setup, Detector Activation

- To activate the Airyscan detector, tick the **ChA** checkbox in the beam path (Fig. 118).
- Make sure to set the filter wheel for internal and external detectors to a plate position or a dichroic which transmits the required wavelengths.

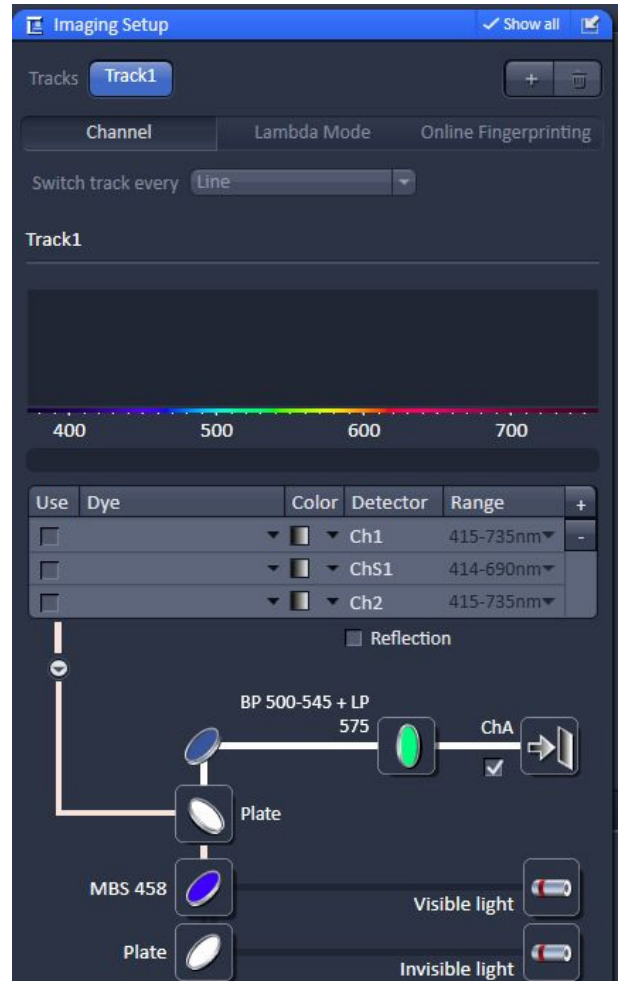


Fig. 118 Imaging Setup tool: Airyscan detector activation

#### Mirror, Emission Filters

- Select an emission bandpass filter according to the dyes you need to detect in single track or multitrack acquisition mode (Fig. 119).

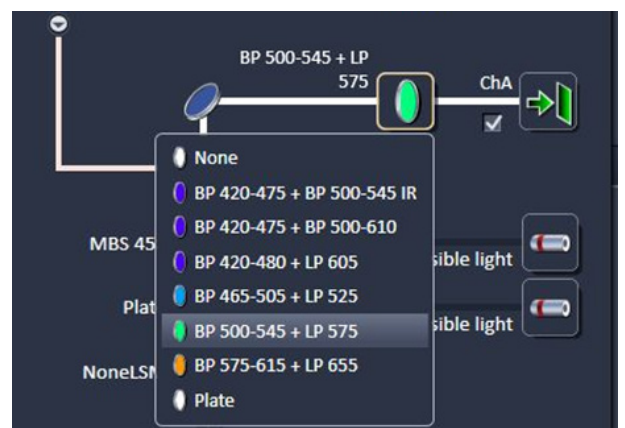
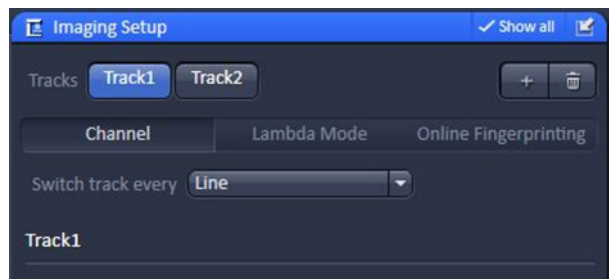


Fig. 119 Airyscan detector: Mirror and emission filters selection



**Fig. 120 Imaging Setup tool: Multitracking with Airyscan detector**

### Multitracking

A multitracking acquisition is set up by using the + button (Fig. 120).

In each track individual settings can be configured for the Airyscan or the internal detectors.

In case Airyscan is used together with internal detectors, only the switch track every frame mode can be used.



**Fig. 121 Airyscan detector: Laser and detection setting**

Laser and detection setting for each (Airyscan) track will be configured in the **Channels** tool (Fig. 121).

### 5.2.8 Acquisition Parameter – Acquisition Mode

In the **Acquisition Mode** tool window, parameters for the acquisition can be set (Fig. 122).

The user interface is adapted depending on the chosen Imaging mode in the **Imaging Setup tool**.

Controls include

- Objective selection
- Scan Mode, Frame Size and Line Step selection
- Format selection
- Imaging speed selection
- Averaging and color depth selection
- High Dynamic Range
- Scan Area selection

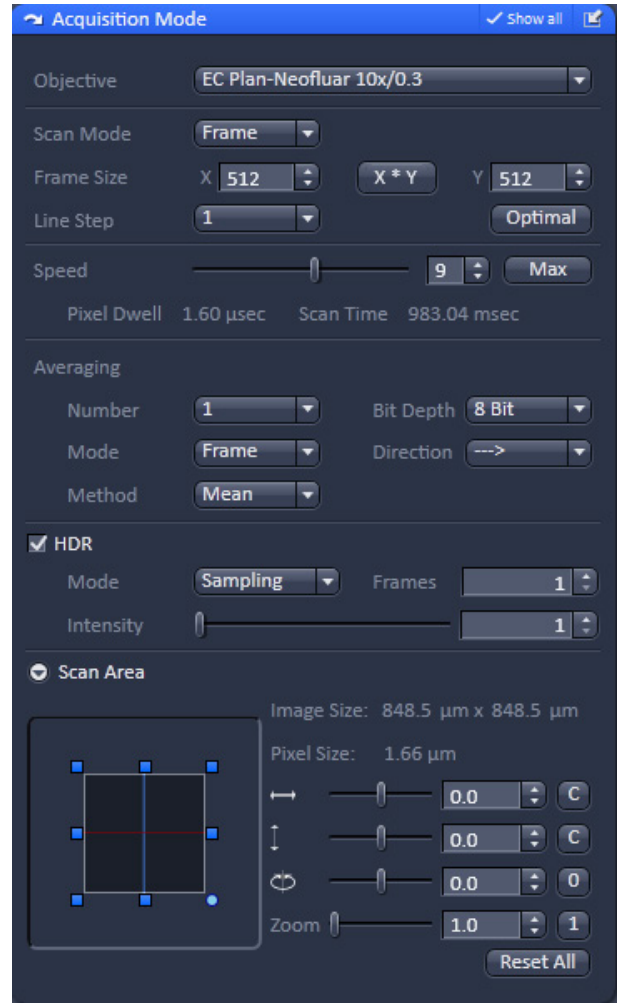


Fig. 122 Acquisition Mode tool window

#### 5.2.8.1 Objective Selection

You can select an objective from the **Objective** drop down menu (Fig. 123). Objectives suited for a certain imaging mode will be highlighted, but every objective can be selected

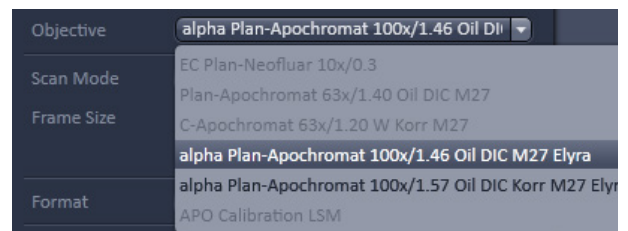


Fig. 123 Objective drop down menu – appearance for SIM imaging mode

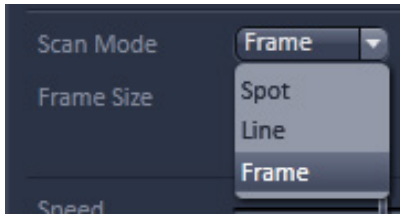


Fig. 124 Scan Mode drop down menu

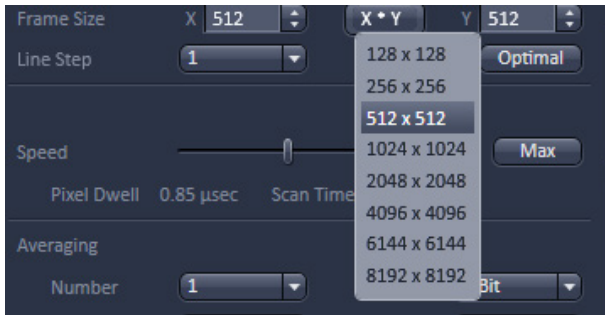


Fig. 125 Frame size drop down menu



Fig. 126 Format drop down menu – appearance for WF, SIM and Laser WF imaging modes

### 5.2.8.2 Scan Mode

The mode of image acquisition (frame wise, line wise, spot wise) can be selected in the **Scan Mode** drop down menu. For the **LSM imaging** mode you can select between **Frame**, **Line** and **Spot**.

The frame size of the displayed image can be edited by the **Frame Size X** and **Y** input boxes. By pressing the **x,y frame size** button, available predefined n,n (or n,m) formats can be loaded directly (Fig. 125). It will depend on the detector type and camera chip, which formats are available.

### 5.2.8.3 Format Selection

Binning of the camera pixels can be set in the **Format** drop down menu (Fig. 126). In this menu you have additionally to the standard format (**1004 x 1002 standard**) the options of 2x binning (**500 x 500 binned 2x2**) and 4x binning (**248 x 248 binned 4x4**). Selection of **Format** will update the possible **Frame Sizes**.

### 5.2.8.4 Averaging and Color Depth Selection

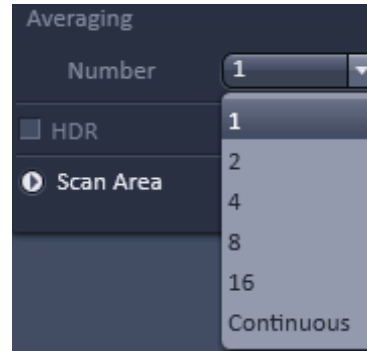
You can select the number of image frames you want to average from the **Averaging Number** drop down menu (Fig. 127).

You can select a  $2^n$  x averaging (n=0-4) or **Continuous** averaging.

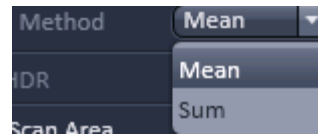
The way of averaging can be selected in the **Averaging Method** drop down menu (available only in **Show all** mode), where you can either select **Mean** for the mean average or **Sum** for adding the images up (Fig. 128).

The color bit depth can be selected from the **Bit Depth** drop down menu (Fig. 129).

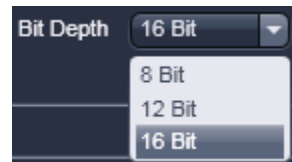
Select **8 Bit**, **12 Bit** or **16 Bit** Data Depth, i.e. 256, 4096 or 65536 gray values.



**Fig. 127 Averaging Number down menu**



**Fig. 128 Averaging Method down menu**



**Fig. 129 Bit Depth drop down menu**

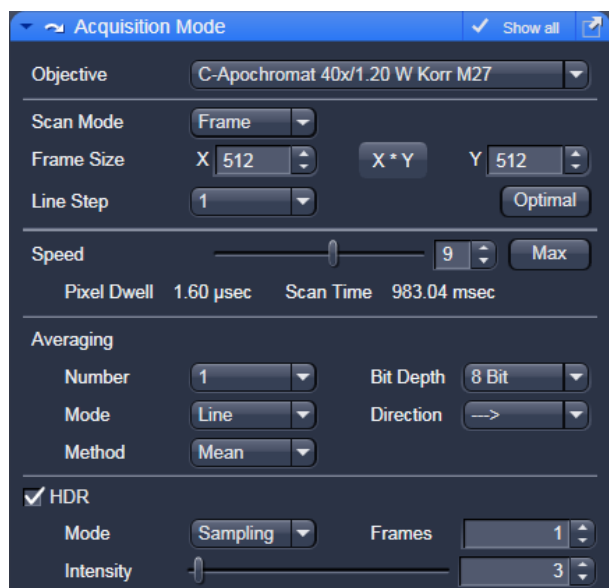


Fig. 130 Acquisition Mode tool, HDR panel

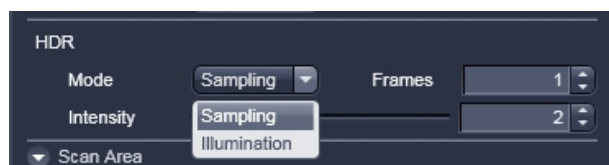


Fig. 131 HDR modes

### 5.2.8.5 HDR(High Dynamic Range)-Imaging

High dynamic range (HDR) creates an image with a depth of 32-bit therefore covering a far broader dynamic range than conventional images (8 to 16 bit). HDR-imaging is available in the **Show all** mode.

HDR creates the typical HDR effect of boosting weak structures without saturating bright areas in the image thereby enabling an optimal representation of the morphology of weak and bright objects within the same image.

Please see the description of the processing tool **HDR-Imaging** (section **Processing – HDR-imaging**) for details on the properties and processing options of HDR files.

The HDR function is located under the field **Averaging** in the **Show all** mode of the **Acquisition Mode** tool (Fig. 130). **HDR** is activated through ticking the **HDR** checkbox.

HDR is exclusively available to LSM imaging and is not selectable when using other modes of image recording (e.g. WF, SIM and Laser WF imaging on ELYRA systems).

Two methods are available (Fig. 131):

- **Sampling** (HDR)
- **Illumination** (ROI HDR)

The HDR method used for image capture is also shown in the information of the recorded images.

The Sampling method is a means to improve the image display as it equalizes the differences between the very high and the very low intensities in the image. However, it is not suitable for quantitative analysis as the grey level steps become non-linear.

In the **Illumination** method number of frames is automatically set to 3 (Fig. 132).


The Illumination method changes the laser power (Fig. 133) to acquire a series of varying exposures. The degree of variation is fixed to allow better reproducibility of experiments.

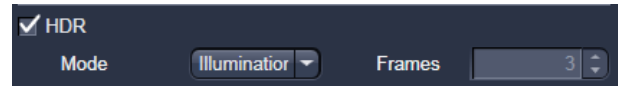
The second image is acquired with 3 times more laser power and the third image is acquired with 10 x more laser power. The default laser power set in the channel menu should be kept to a minimum.

For the acquisition step with increased laser power, those regions of the image are excluded from exposures when no reasonable data can be obtained with any higher laser power.

This mask reduces unwanted bleaching of the sample. The respective ROIs are displayed in an additional image. The **Illumination** method preserves a linear grey stepping which allows for quantitative measurements of image intensity.

Please see also the information about HDR processing in section 5.4.12.

 HDR imaging does not produce usable results with high speed imaging.



**Fig. 132** HDR Illumination mode



**Fig. 133** Laser Power setting for Illumination mode

### 5.2.8.6 Scan Area Definition

The **Scan area**, when expanded, displays the Image size and Pixel Size in  $\mu\text{m}$  of the displayed frame (Fig. 134).

In all widefield (**WF**, **SIM**, **LSM WF**) imaging modes, the full frame is displayed, which cannot be altered in size. In the **LSM imaging** mode, altering the size (**Zoom**) is possible.

If images are cropped, the size of the cropped area and its offset from the center will be displayed.

The horizontal and vertical sliders allow to offset a cropped region in x and y.

You can also use the graphical display to drag and drop the displayed region by pressing with the left mouse button, which will automatically update the slider positions.

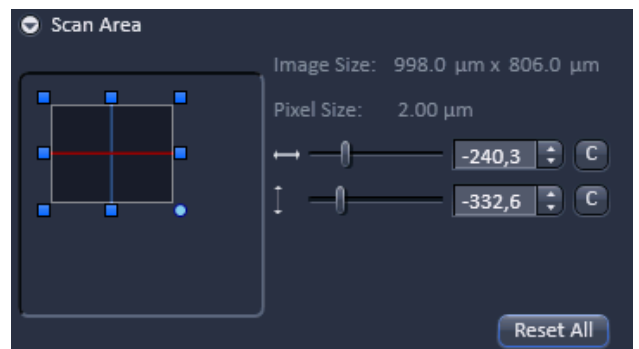
By pressing the **c** buttons, the region will be centered again.

You can also type in numbers or use the arrow heads.

The frame can be altered in size by clicking at the blue anchor points, which will update the cropped area in the next image.

For the **LSM imaging** mode, also rotation of the cropped region is possible.

Pressing **Reset** will center and expand the region to the full size.



**Fig. 134** Scan Area with cropped frame offset

### 5.2.8.7 Acquisition Mode Functions for LSM

The parameters for image acquisition are set using the tool **Acquisition Mode**.

The following scan modes, which can be selected from the drop down menu, are available:

#### Frame

- scanning of an XY frame (Frame, Frame + Time Series)
- scanning of XY frames with different Z-values (Frame + Z-Stack, Frame + Z-Stack + Time Series)
- scanning of XY frames in defined ROIs (Frame + ROI + Time Series)
- scanning of XY frames with different Z-values in defined ROIs (Frame + Z-Stack + ROI + Time Series)

#### Line

- scanning of a line in the XY-plane (Line, Line + Time Series)
- scanning of a line with different Z-values (Line + Z-Stack, Line + Z-Stack + Time Series)

#### Spot

- scanning of a spot (Spot + Time Series)

The availability of the modes is also dependent on the imaging device used e.g. LSM 710 or camera. Depending on the selected scan mode the additional parameters for image acquisition will change.



## Frame Mode for LSM

When the scan mode **Frame** is active, a frame of variable size is scanned pixel by pixel and line by line. The laser beam is moved over the specimen line by line.

The following additional parameters and options can be set:

**Objective, Frame Size, Line Step Factor, Speed, Bit Depth, Scan Direction, Averaging and Zoom** including rotation and offset

A list of available objectives is displayed in the scroll down menu next to **Objective**. Choose one from the list which is appropriate for imaging a specific specimen. Pay attention to match the refractive index of the objective with the refractive index of the embedding medium of the specimen if possible.

- Select the **Frame Size** from the default sizes via the drop down menu clicking the **X+Y** button or type in the required values next to X and Y. Recommended setting to start with: 512 x 512 pixels.
  - It is also possible to enter different values for X and Y. The value for **Y** is freely selectable between 1 and 8192 pixels (integers). The value for **X** must always be an integral multiple of 4 and will be corrected if not typed in already. The maximum value for **X** is also 8192 pixels.
  - The **Optimal** button sets the image resolution to an optimal value corresponding to the optical magnification (objective) the zoom and the emission range detected. This provides an image where no information is lost as optimal sampling is achieved. The optimal value is calculated for the give objective and zoom settings matching a 2fold oversampling according to 2 fold Nyquist.
- Select the **Line Step** size between 1 and 10. Only every n-th line is scanned. The lines in between are interpolated. This fast scan mode is called Step Scan.




**Fig. 135** Acquisition Mode - Frame with LSM tab selected in the Imaging Setup tool


- Select the **Scan Speed** from the 19 preset steps via slider or input box. Recommended: 8 for the first scan. A click on the **Max** button sets the maximum speed for the current zoom.
  - In basic mode (**Show all** inactive), the LSM switches automatically to bi-directional scanning if high scan speeds are selected (see also description of bi-directional scanning below).
  - The **Scan Speed** determines the **Pixel Dwell** time. In the case of different image formats, the **Pixel Dwell** time is constant for the same Scan Speed, but the **Scan Time** is different.
  - **Pixel Dwell** time of the laser beam on the pixel
  - The **Scan Time** duration of the acquisition for the entire frame


<b>Speed:</b>	1 ... 11	12	13	14	15	16	19
<b>Zoom:</b>	0.6 - 1.4	≤ 1.8	≤ 2.9	≤ 3.3	≤ 4.3	≤ 5.4	≤ 13.2
<b>Mode:</b>	lbda./ 34 ch.	lbda./ 32 ch.	10-ch	10-ch	6-ch	6-ch	4-ch

\* Values refer to image format 512 x 512 pixels, 8 bit data depth and a tube lens of 150 mm (LSM on the side port of Axio Observer); other values apply for higher formats and data depth.


- Select **8 Bit**, **12 Bit** or **16 Bit** Data Depth, i.e. 256, 4096 or 65536 gray values.
- Select the **Unidirectional** or **Bi-directional** Scan Direction.

–  Unidirectional: The laser scans in one direction only, then moves back with beam blanked and scans the next line.

–  Bi-directional: The laser also scans when moving backwards, i.e. the Scan Time is halved. The online scanner calibration (OSC) will correct for nonlinear distortions of the lines in bidirectional mode. This function (see also checkbox in **Maintain Tab -> Options – System Options-> Hardware**) eliminates most of the deviations of the scanmirrors at the very fast speeds.

–  The pixel shift between forward and backward movement (double image) resulting from bi-directional scanning must be corrected. For automatic scan correction, click on the **Auto** button. If **Auto** is off the scan **Corr X** and **Y** sliders which are indicated when selecting bidirectional scanning. Zero° rotation requires correction in the X-direction, 90° rotation must be corrected in the Y-direction. If the image was rotated, correction is required in both coordinates. Correction is performed on-line in the **Continuous** scan mode. The size of the shift depends on the Scan Speed.

- Select the **Line** or **Frame** mode for averaging.
- Select the desired scan average method **Mean** or **Sum**.
- Select the desired scan average from the available values **2**, **4**, **8** and **16** in the **Number** selection drop down menu or **Continuous** (only for **Frame** average mode).

 The greater the number of averages selected for **Mean** average **Method**, the better the image quality will be; the scanning time will be prolonged accordingly.

Averaging can be performed in different ways, depending on whether the **Mean** or **Sum** method has been activated.

If you are using the **Mean** method, the image information is generated by adding up all scans pixel by pixel and then calculating the mean value.

In the **Sum** method, the intensity values of all images are added up, without a mean value being calculated.

To create the image information using the **Line** average mode, each line (depending on the setting) is scanned 2, 4, 8 or 16 times during Scan Average, and then the average value per pixel is calculated. This minimizes noise interference during the scanning procedure.

If the **Frame** average mode is used to create the image information, the complete frame is scanned 2, 4, 8 or 16 times, depending on the setting. The average value is recalculated after each frame scan.

The **Frame** average mode also permits continuous averaging.

For this, select the **Continuous** option in the **Number** selection box.

### Scan Area

In this panel, the scan field is set for zoom, rotation and offset in relation to the field of view of the microscope. The diagonals of the outer square on the left-hand side correspond to the field of view of the microscope.

The inner square contained in it (rectangle in the case of differently set frame size) represents the scan range and immediately shows the changes made to zoom, rotation and offset.

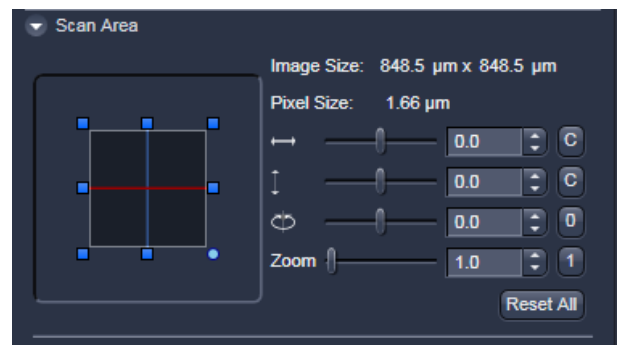




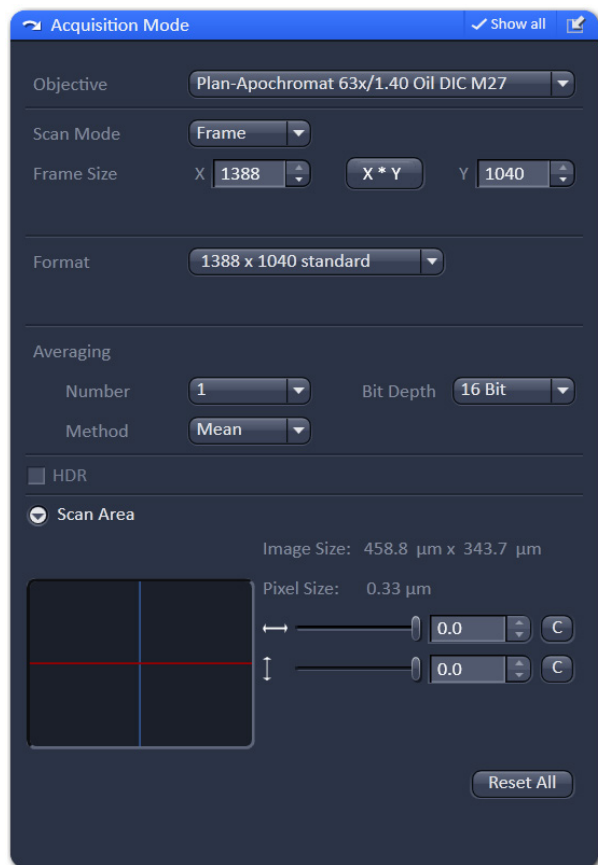
Fig. 136 Scan Area panel

- Set the desired **Zoom** factor via the slider or by clicking on the small red squares outlining the inner square.
  - The **Zoom** factor can be set continuously in the range from 0.6 (0.7 for Axio Examiner stand) to the maximum of 40, and is displayed in the relevant input box. The value 0.6 corresponds to factor 1, and value 40 to factor 66, related to the field of view. From zoom factor 5 onwards, the magnification will be empty.
  - Recommended setting to start with: Zoom 1.
- To rotate the scan area, use the slider or click on the blue dot in one of the corners of the inner square.
  - Recommended setting to start with: Rotation 0°.
- Move the scan area by clicking on  for offset in horizontal direction and  for offset in vertical direction.
- The offset of the scan area from the center of the field of view is displayed online in µm for X and Y.
  - Clicking, holding and drawing the rectangle with the mouse permits the scan area to be moved directly within the field of view.
  - Recommended setting to start with: Offset X = 0, Y = 0



During the scan procedure, the functions **Speed**, **Scan Corr**, **Zoom**, **Rotation** and **Offset** can be influenced online.

By clicking on the **Reset All** button the scan zoom is set to 1, the XY offsets are set to the zero position and the ratio angle is set to 0°.



**Fig. 137 Acquisition Mode - Frame with Camera tab selected in the Imaging Setup tool**

### Frame Mode for Camera

When images are acquired with the camera only **Frame** mode is available.

The following additional parameters and be set:

### Objective, Frame Size, Format, Bit Depth, Averaging and Offset

The exposure time is set in the **Channels** tool.


A list of available objectives is displayed in the scroll down menu next to **Objective**. Choose one from the list which is appropriate for imaging a specific specimen. Pay attention to match the refractive index of the objective with the refractive index of the embedding medium of the specimen if possible.

- Select the **Frame Size** from the default sizes via the drop down menu clicking the button **X\*Y** or type in the required values next to **X** and **Y** all the. Recommended setting to start with: 1300 x 1300. You can select between square formats or free defined frame sizes.

**Format** selects between a range of default camera resolutions. The 5x5 binning mode can be used for focusing without delay of the image display.

- Select **8 Bit** or **12 Bit** Data Depth, i.e. 256 or 4096 gray values.

- In the scan area it is possible to shift a sub region in the frame using the offset sliders if the **Frame Size** is set to a smaller value than the chosen **Format** sets it automatically.
- The horizontal and vertical **Offset** can be set to zero individually clicking **C**.
- **Reset All** Resets the **Offset** and the frame/sub region to the default value selected in **Format**.
- **Frame** mode is available for averaging.
- Select the desired scan average method **Mean** or **Sum**.
- Select the desired scan average from the available values **2**, **4**, **8** and **16** in the **Number** selection drop down menu or **Continues**.

 The greater the number of averages selected for **Mean** average **Method**, the better the image quality will be; the scanning time will be prolonged accordingly.

Averaging can be performed in different ways, depending on whether the **Mean** or **Sum** method has been activated.

If you are using the **Mean** method, the image information is generated by adding up all images and then calculating the mean value.

In the **Sum** method, the intensity values of all images are added up, without a mean value being calculated.

### Line Mode

In **Line** mode, fluorescent or reflected light along a straight or freely definable line is displayed in the form of an intensity profile. The line is scanned pixel by pixel. The laser beam is moved over the specimen along a line.

The following parameters for scanning a line can be defined:


#### Objective, Frame Size, Speed, Bit Depth, Scan Direction, Averaging and Zoom including rotation and offset


These functions operate as described in section **Frame Mode for LSM**. **Frame size** in this context sets the length of the line in x direction. The width of the line is one pixel.


Note: A width larger than one pixel is defined as a frame.

If **Line Mode** has been selected, the **Line Select** button appears on the bottom of the **Acquisition mode** tool. It permits positioning of the line to be scanned as required within the **Image** (Frame in XY-plane).

A frame will be scanned and the currently selected scan line and its intensity profile will be displayed. In the **View Control** the **Line-select** tools are available.

The line arrow  is active by default and allows using the mouse to draw a straight line in the image at the position where the line scan should be performed.


Alternatively the scan line  can be defined as a free shape curve (spline).

The arrow selection  is used to move the drawn line within the image.

The standard controls allow defining the color and width of the appearance of the line overlay in the image.

Once a straight line is drawn in the image, the relevant intensity profile along the drawn line will be displayed. In the **Acquisition Mode** tool Zoom, Rotation and Offset values are updated.

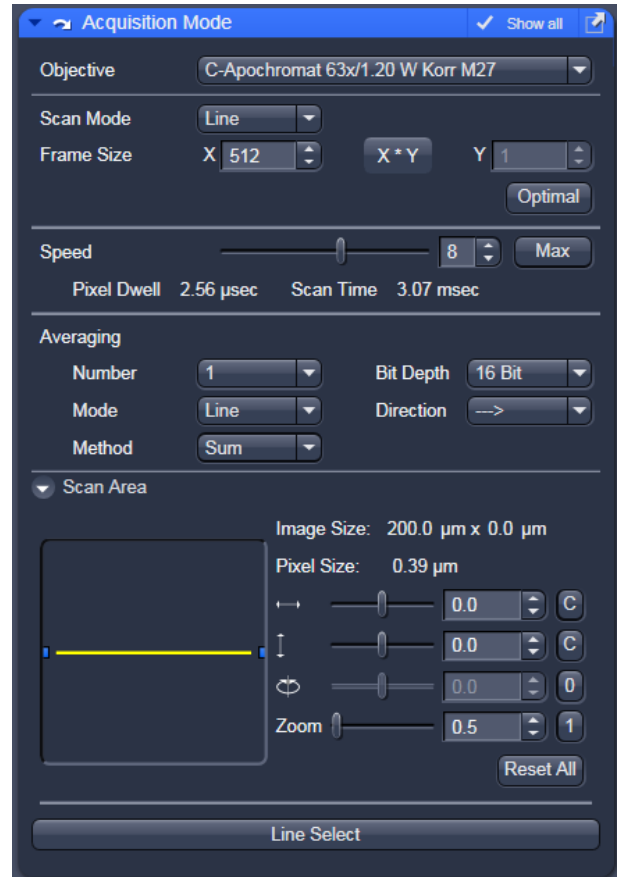
- When the **Line Select** button is hit again, a frame will be scanned in such a way that the selected line lies exactly in the center of the Y-axis again and is parallel to the X-axis.

 The position and size of the Line (rotation and offset) can also be changed directly in the **Scan Area** panel of the **Acquisition Mode** tool.

In the **Line** mode, Line Stacks can also be recorded over a defined period of time.

- When drawing a free shape curve (spline) in the **Image** using the mouse, the first click sets the starting point; each further click adds a line segment. A click with the right mouse button ends the line definition.

The scanner represented by a white line immediately begins with the on-line tracing of the defined free shape curve. The laser excitation remains inactive in this process.



**Fig. 138 Acquisition Mode – Line with LSM tab selected in the Imaging Setup tool**

If the defined free shape curve becomes too complicated or the selected **Scan Speed** is too high, the following message appears in the status bar:

Maximum scanner acceleration exceeded!

- In this case, reduce the **Scan Speed** set in the **Acquisition Mode** tool.
- If the generated contour and the line traced by the scanner are not in coincidence, reduce the **Scan Speed** by a further amount.

If no sufficient coincidence of the two lines can be achieved by the reduction of the scan speed, you have to calibrate the scanner position signal.

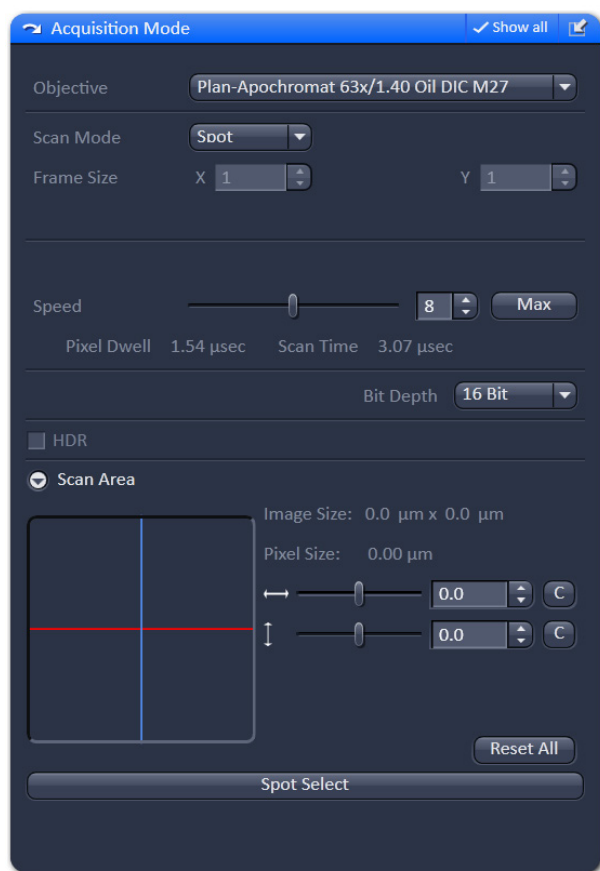


Fig. 139 Acquisition Mode tool - Spot Mode

### Spot Mode

In the **Spot** mode fluorescent or reflected light occurring from a single voxel xyz is detected. In this mode a spot can be defined by two perpendicular lines in the **Image** using the **Spot Select** button which is located in the lower part of the **Acquisition Mode** tool window (Fig. 139).

The following parameters for scanning a spot can be defined:

#### Objective, Speed, Bit Depth and Offset in X and Y (= position within the image)

These functions operate as described in section **Frame Mode for LSM**.

In **Spot** mode it is not possible to acquire a **Z-Stack**. After definition of the spot position the only possible scan mode is **Time Series**.

Spot scan data can also be displayed as images consisting of two lines with 500 pixel per line. When indicating the number of cycles in the Time Series tool window, one cycle equals 1000 pixels.

### 5.2.8.8 Acquisition Mode Settings for Airyscan

#### Objective, Scan Area, Zoom

The required acquisition settings for the Airyscan are set in the **Acquisition Mode** tool (Fig. 140).

- Make sure to select a high performance objective (e.g. PSF selected Plan-Apochromat or C-Apochromat objective with 40x-100x magnification).
- For optimal resolution, the scan area should be centered and the zoom should have a factor of at least 1.7x or higher.
- Zoom factors with negative influence on the resolution will be displayed in red.



Fig. 140 Acquisition Mode tool: Airyscan settings

#### Frame Size, Optimal

- The required number and size of pixels to achieve increased resolution with the Airyscan is set automatically by pressing the **Optimal** button (Fig. 141).

This will take into account which detection mode is used for the Airyscan (SR, VP or CO, see **Channels** dialog (Fig. 144)).

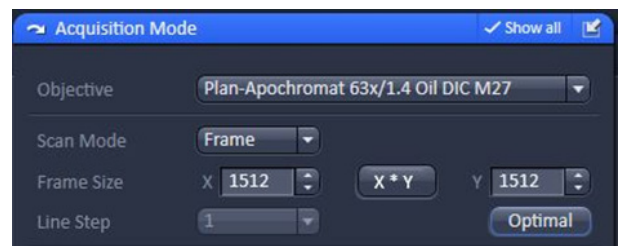


Fig. 141 Airyscan: Settings for number and size of pixels

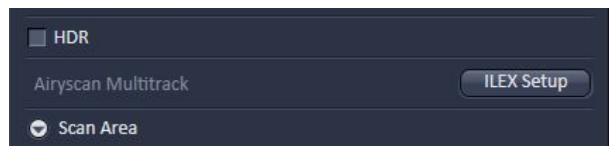


Fig. 142 Airyscan: ILEX Setup activation

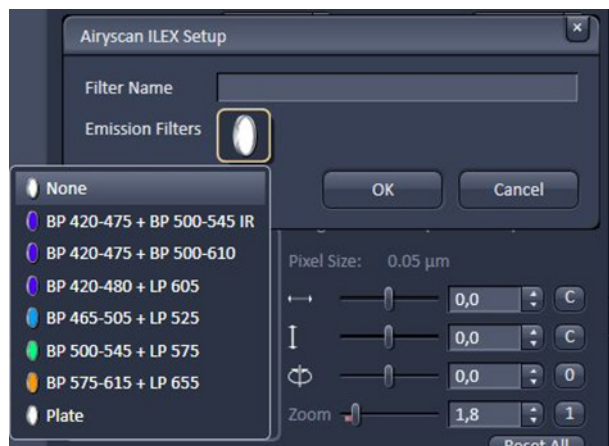


Fig. 143 Airyscan: ILEX Setup panel

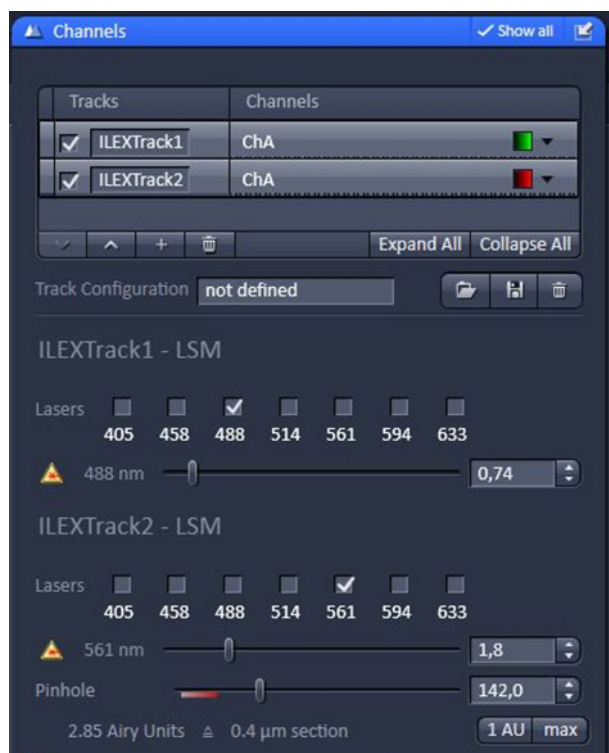


Fig. 144 Airyscan: Channels settings

### Airyscan Multitrack ILEX

For best synchronicity in a multitracking acquisition with the Airyscan, a so called **ILEX** (interleaved laser excitation) mode is available.

This allows the tightest timing of the different channels acquired with the Airyscan detector.

- To activate ILEX, use the **ILEX Setup** button (Fig. 142) at the Airyscan multitrack section in the Acquisition mode dialog.
- You can either type in the required bandpass emission filters or select them from the drop down list. Then press the **OK** button (Fig. 143).

As a result, a linewise multitracking will be configured automatically, which includes a 2x linewise averaging of each image line acquired.

During this averaging, the excitation lasers will be interleaved for best synchronicity.

- Make sure the correct laser lines are activated by using the laser checkboxes for the respective multitracks.
- The laser power can be set individually with the slider (Fig. 144).

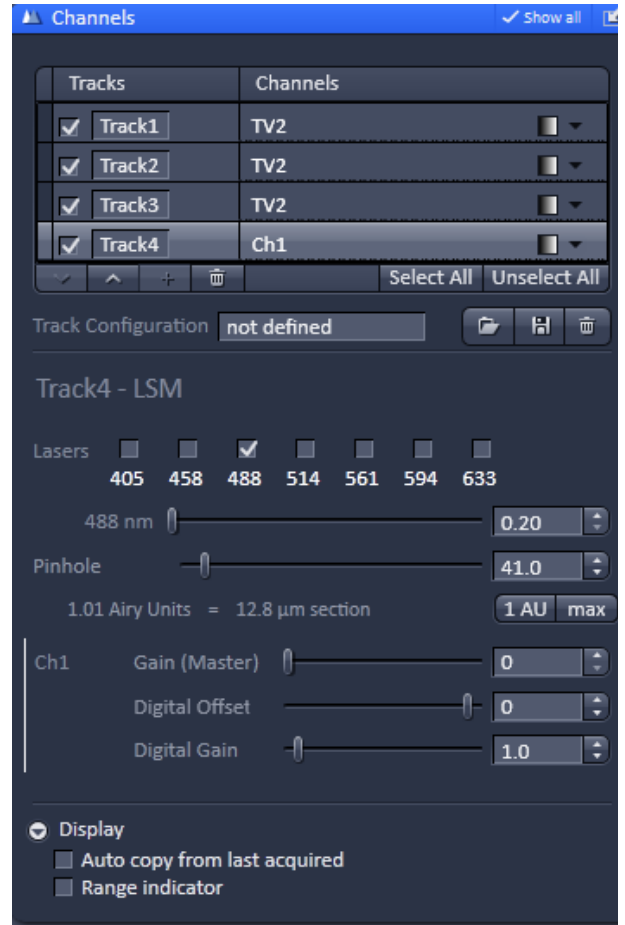


### 5.2.9 Acquisition Parameter – Channels

In the **Channels** tool window the following options are available:

- Switching, activating, deactivating and naming/saving of tracks
- Defining Detector settings
- Defining pinhole settings
- Defining Display options

Expand the **Channels** tool window to have access to all options (Fig. 145).



**Fig. 145 Channels tool – Appearance for the LSM imaging mode**

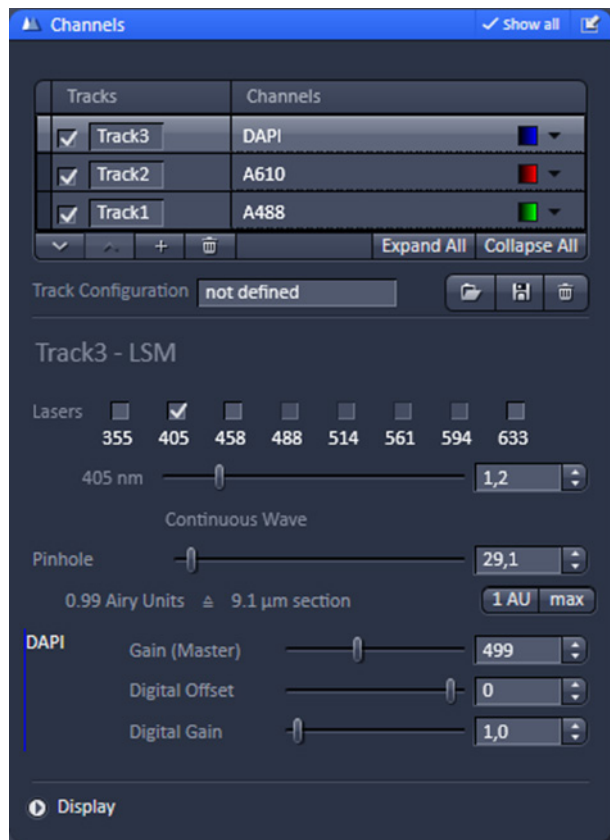


Fig. 146 Channels tool – Appearance for the LSM imaging mode



Fig. 147 Imaging Setup tool Tracks display—track selection of track 1 and 2 updated from the Channel tool

### 5.2.9.1 Defining Channels and Tracks

The **Channels** tool lists all tracks in the **Track Selection display** area that have been defined in the **Imaging Setup** tool.

The **Tracks** name and the used **Channels** for that track are indicated. Each track that is selected by mouse click will be highlighted and be displayed in the **Track Configuration display** area, which allows for individual settings of each track (Fig. 146).

Tracks are activated/deactivated for imaging with the check box.

Changes in the selection of the tracks in the **Channels** tool will automatically update the selection in the **Imaging Setup** tool and vice versa.

E.g. if Track 1 and Track 2 are selected in the **Channels** tool, they will be selected in the **Imaging Setup** tool as well (Fig. 147).

By clicking **Expand All**, all tracks will be selected and their settings displayed.

**Collapse All** de-selects all tracks and hides their settings.

You can either display one track or all tracks. There is no possibility to display several out of all tracks.

The color of a track can be set or changed selecting a LUT from the **Look Up Table (LUT)** drop down menu (Fig. 148).

The scroll bar allows access to all predefined colors.

The color is updated for the channels in the Imaging Setup tool of the corresponding track.

By pressing the **upwards pointing open arrow**, the highlighted track will move one position up in the displayed track array (Fig. 149).

Likewise, by pressing the **downwards pointing open arrow**, it will move one position down. The arrows are only active, if an upward or download movement is possible.

The sequence is updated in the Imaging Setup tool accordingly.

You can add up to 4 tracks by pressing the **+** button. You can delete tracks by highlighting them and pressing the **dust bin** button. The number of tracks is updated in the **Imaging Setup** tool accordingly.

You can load a predefined track configuration as a profile at the position of the highlighted track from the **Track Configuration** field (only available in the **Show all** mode) by pressing the **Load** button (symbolized by the **folder** icon) (Fig. 150).

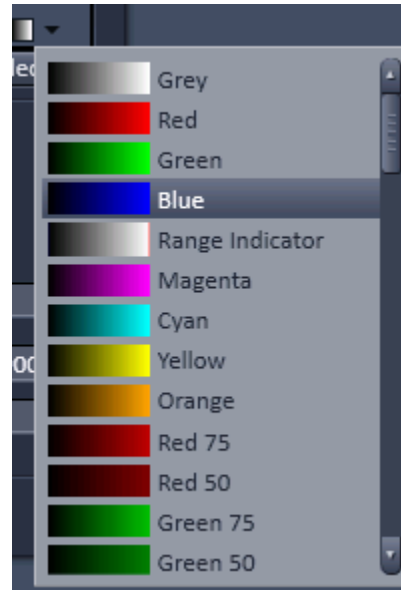


Fig. 148 Track LUT drop down menu

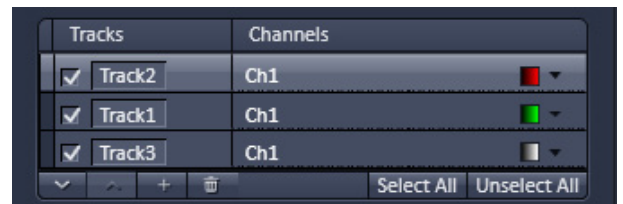


Fig. 149 Track selection display – Track 2 moved to the top, no further upwards movement possible



Fig. 150 Track configuration

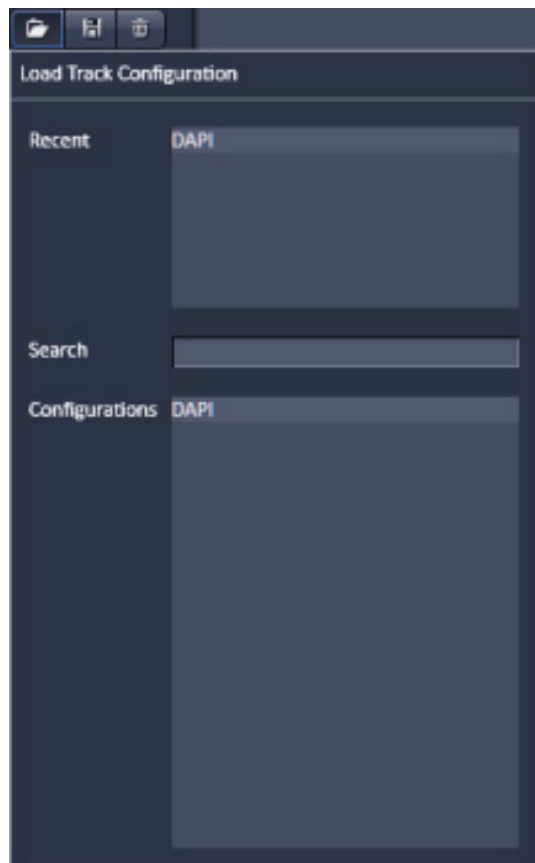


Fig. 151 Load Track Configuration panel

All saved track configurations will be listed in the **Load Track Configuration** panel (Fig. 151).

Select the appropriate one by highlighting it in the **Recent** section, which lists the recently used track configurations or from the **Configurations** section, where all saved track configurations are displayed.

To search for a track configuration, type in its name or part of its name in the **Search** field and only those track configurations will be listed that contain the typed in string of letters.

To delete a track configuration press the **Delete** button (symbolized by the **dust bin** icon). This opens the **Delete Track Configuration** panel (Fig. 152).

Select the configuration from the **Configurations** list by highlighting it or search for it by typing its name in the **Search** field.

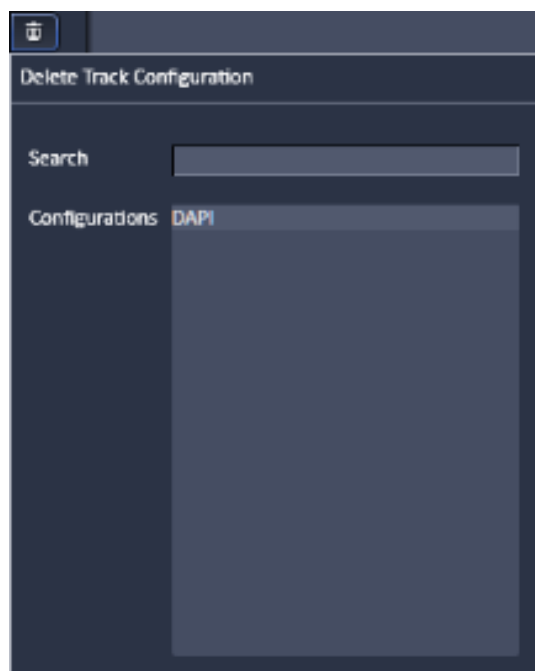


Fig. 152 Delete Track Configuration panel

The **Info** window pops up (Fig. 153).

Press **Yes** to delete the configuration, **No** to keep the configuration.

To save a configuration press the **Save** button (symbolized by the **disc** icon).

This opens the **Save current Track configuration as** panel (Fig. 154).

Type in an appropriate name in the **Configuration** field and press **Ok** to save the configuration in the data base or press **Cancel** to abort the process.

The name of the track can only be changed when saving the track (Fig. 155).

If a highlighted track is saved with a certain name or a predefined track with a name is loaded into a highlighted track, the new name will appear in the **Tracks** designation box automatically.

Track designation in the **Imaging Setup** tool will automatically be updated (Fig. 156).

The total set of parameters for one or multiple tracks can be stored as an acquisition configuration using the save option in the **Experiment Manager** field of the **Acquisition** panel.

Using multiple tracks is the preferred method to clearly separate weakly overlapping emission signals.

The **Display** panel (Fig. 157) provides two functions. **Auto copy from last acquired** applies the display parameters (brightness, gamma, contrast) to the following images acquired. **Range indicator** overwrites the LUT set with the **Imaging Setup** tool and shows all subsequently acquired images with the LUT Range indicator.

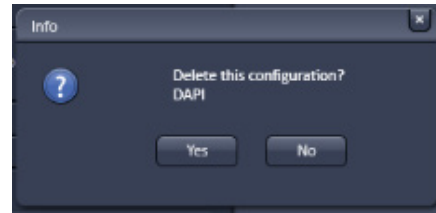


Fig. 153 Delete information window

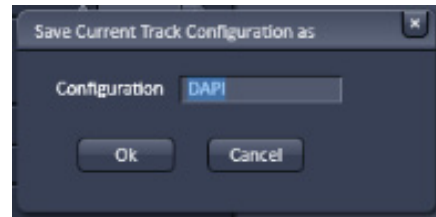


Fig. 154 Save Current Track Configuration as window

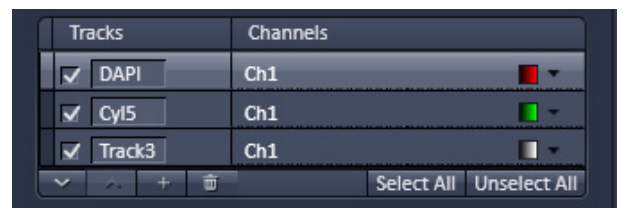


Fig. 155 Track selection display – Tracks renamed



Fig. 156 Imaging Setup tool Tracks display – Tracks renamed updated from the Channels tool

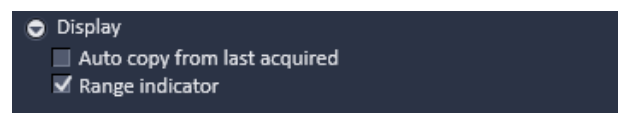


Fig. 157 Display panel

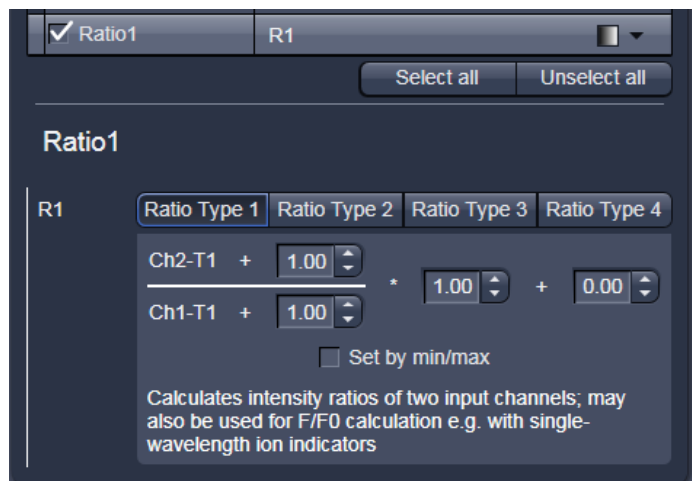


Fig. 158 Channel Settings panel of a Ratio Channel

### 5.2.9.2 Ratio Channels

The parameters for ratio metric imaging can be set when a ratio channel is selected.

- Click on the button of a ratio channel (e.g. **R1**).
- Clicking on the required tabs enables you to choose from four formulas (**Type 1** to **4**) for ratio calculation. The relevant decimal values can be entered in the input boxes. The entered values remain unchanged even after switchover to another formula and can be reactivated any time.

The formula type activated last is always used for ratio formation during the scan procedure. If the input box does not contain any value at all or no suitable value, the useful value last used will be activated.


The ratio channels are displayed as additional images.

Select the required formula and enter the relevant values.

Letters can be entered into the formula fields which will be valued as 1; it is also possible to make no entry, which will also be valued as 1, but will not be displayed.

Set by min/max allows the definition of the display scaling according to the expected minimal and maximal values.

- Laser lines and laser power are displayed according to each track. It is possible to vary laser intensities (in the same way as in the **Imaging Setup** tool).

 All parameters can be varied while imaging.

### 5.2.9.3 Using GaAsP Detectors and the temperature controlled side PMT for Photon Counting Imaging

In the LSM **Imaging Setup** tool activate any GaAsP detector like BiG.2, the 32 channel GaAsP Array detector or the temperature controlled side PMT (Ch2).

Select **Photon Counting** for the detector in the **Channels Tool** (Fig. 159).

In photon counting imaging a **Digital Offset** and **Digital Gain** slider is available, which can be used to adjust brightness and contrast of the image during scanning.

In photon counting mode an artificial maximum of detectable photons is set. For all GaAsP detectors and the side PMT (CH2) this value is defined by  $CR_{max}/\text{digital gain}$  ( $CR_{max}$  = maximal count rate defined by the software, which is 4 MHz for the BiG.2 and Ch2 and 2 MHz for CHs (32 channel GaAsP Array). Higher count rates are regarded as saturation. Note that too much light on the detectors (higher count rates for some ms) leads to detector shut down to avoid damage.

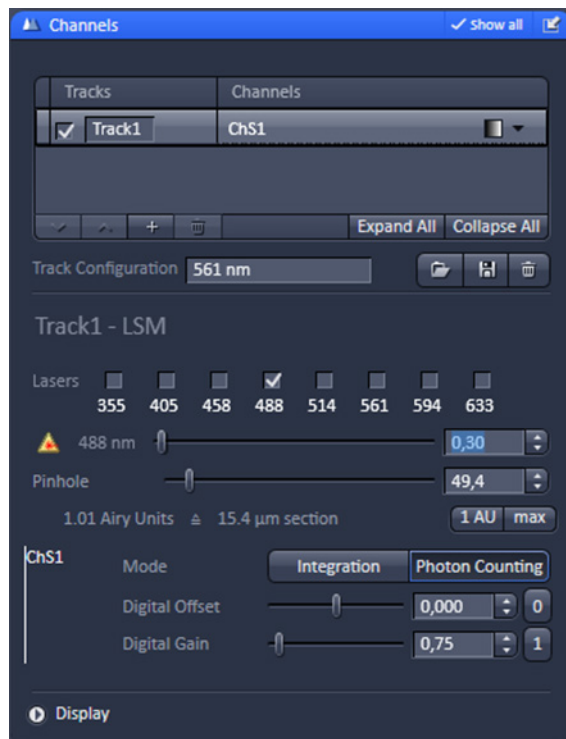


Fig. 159 Channels tool – Photon counting mode for GaAsP detector

#### (1) Display of Photon Count Images

There are two ways photon counting images can be displayed in the LSM software, in analog (grey value) or counting (raw data) mode.

You can toggle between the two modes in the **Maintain** area **Options / System Options** in the **Hardware** tab by deactivating or activating the **Keep raw data for photon count detectors** check box (Fig. 160).

If the box is checked, you will obtain the photon counts, if unchecked, grey values corresponding to photon counts.

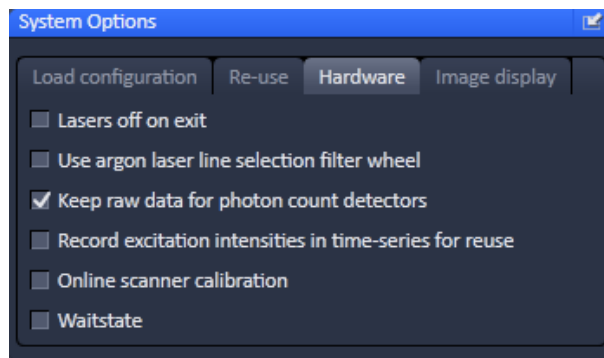


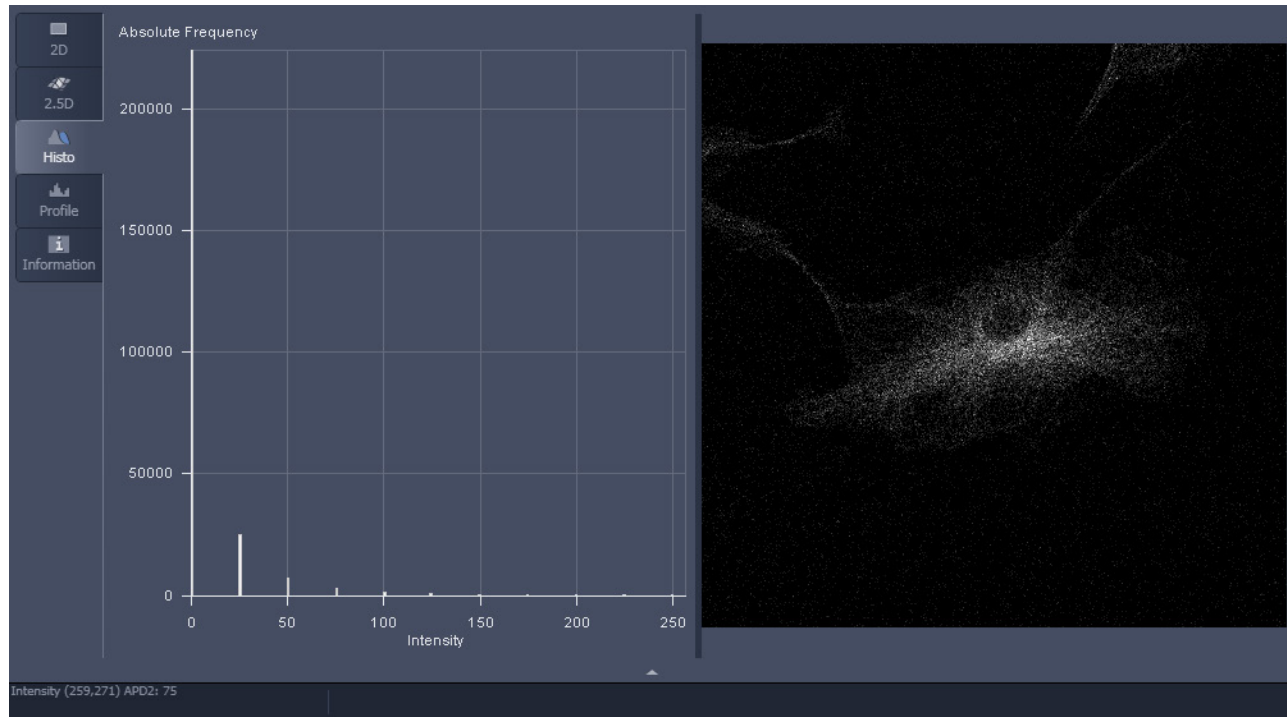
Fig. 160 Hardware tab in the Systems Options tool/Maintain tab

**(2) Analog (Grey Value) Display**

In this display, photons are transformed into grey values, which are displayed in discrete intervals in the histograms. Intervals can be calculated by:

$$\text{Interval} = (\text{pixel period} \times \text{frequency}) / (2n-1) = (\text{pixel period} \times \text{CRmax/digital gain}) / (2n-1),$$

where  $n = 8$  for an 8 bit image and  $n = 12$  for a 12 bit image (see Fig. 161 for an example).



**Fig. 161** Analog display in photon counting image. Settings were digital gain 1, scanning speed 8 corresponding to a pixel period or pixel dwell time 1.52  $\mu\text{s}$ , 8 bit image

**Example:**

With the GaAsP detector (Big.2), software limits the maximum count rate to 4 Mhz = 4 photons /  $\mu\text{s}$ .

At scanning speed 8 with a pixel dwelling time of 1,52  $\mu\text{s}$  one can obtain a maximum of  $4 \times 1,52 = 6,08$  photons. Since photons are integer, this value must be rounded down to 6 photons maximum / pixel.

The spacing interval is calculated for the 8 bit image as  $255/6=42.5$ . This value is rounded down to the next fifth value, which is 40.

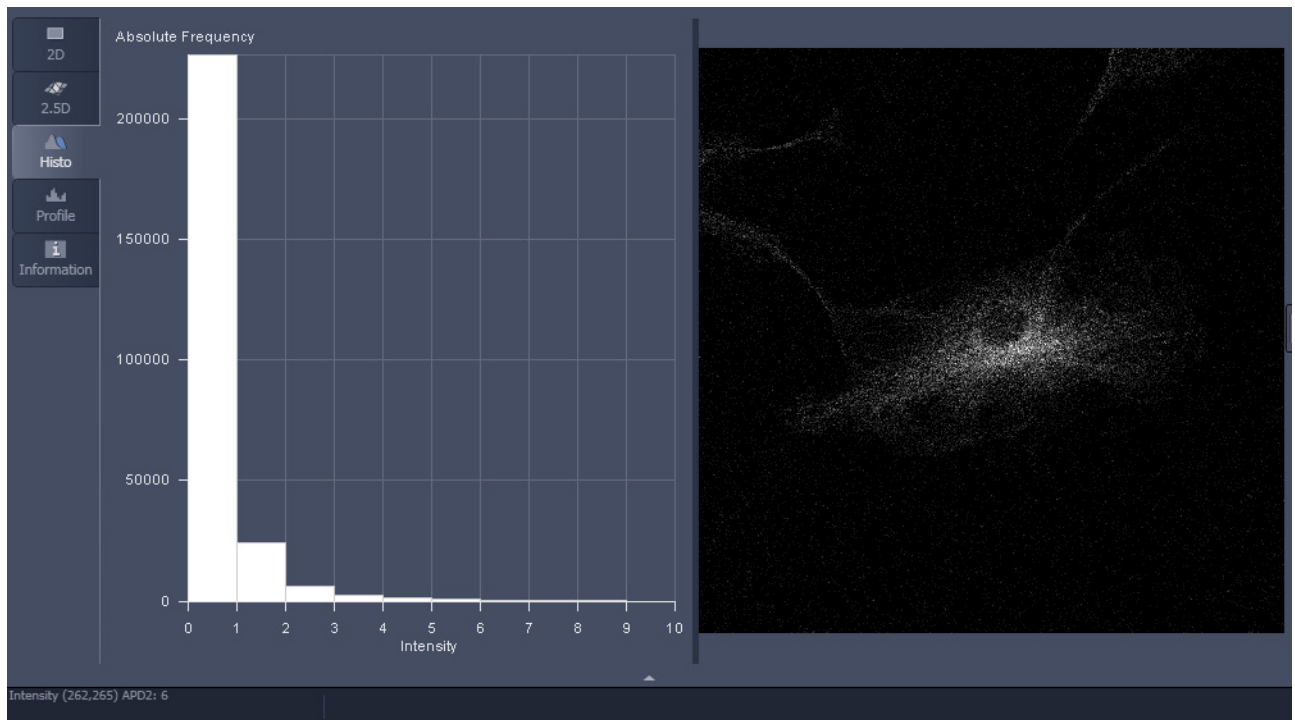
So 1 photon will correspond to a grey value 40,  $n$  photons to a grey value  $n \times 40$ , with a maximum  $n$  of 6).

Grey value 0 is reserved for 0 photons, 255 for any overflow. In this way, the histogram is stretched to cover as much as possible of the available grey scale. Therefore, even at lesser or greater photon counts, the image will maintain its brightness.



**(3) Counting (Raw Data) Format**

In this display, photons are displayed according to their number (Fig. 162).



**Fig. 162** Counting display in photon counting image. Settings were digital gain 1, scanning speed 8 corresponding to a pixel period or pixel dwell time 1.52  $\mu$ s, 8 bit image

In the **Status Area** the displayed value of the pixel to which the mouse points in the image is displayed as the number of photons.

- ☞ Counting images can not be used for further processing in the LSM software like mean of ROI function, statistics etc. They can be exported to have access to the raw data.

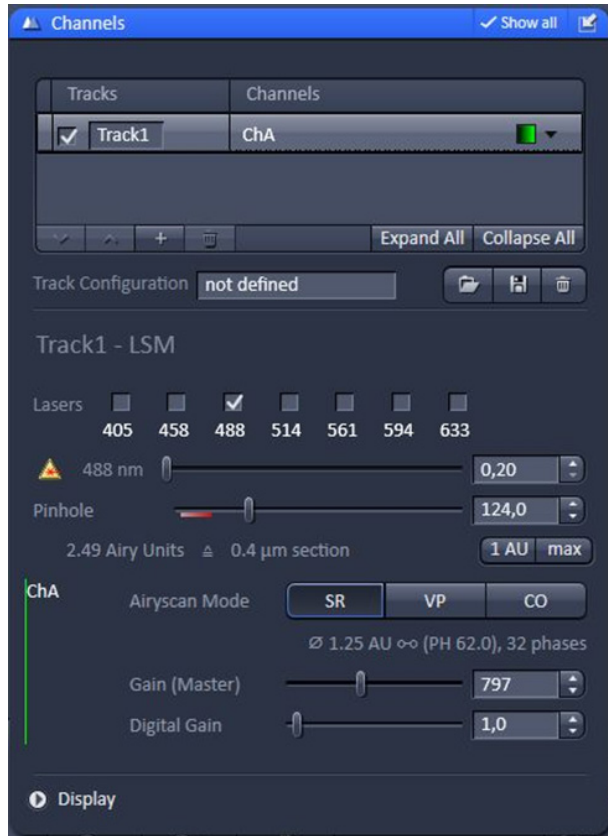


Fig. 163 Airyscan: Channels tool

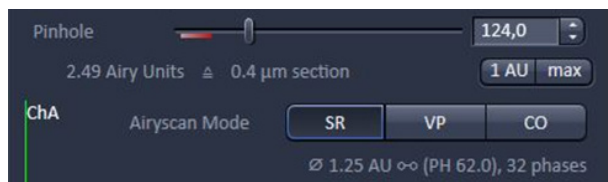


Fig. 164 Airyscan Mode: SR

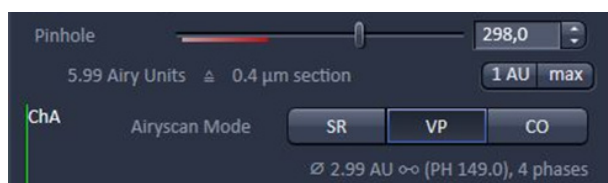


Fig. 165 Airyscan Mode: VP

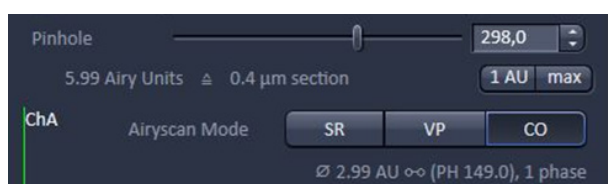


Fig. 166 Airyscan Mode: CO

### 5.2.9.4 Channel Settings for Airyscan

The detection settings of the Airyscan can be controlled in the **Channels** tool (Fig. 163).

The pinhole will be set automatically to a correct opening depending on the Airyscan mode.

The effective pinhole is defined by the Airyscan detection surface and its zoom optics.

The hardware pinhole will automatically be opened at twice the value, to avoid any signal loss.

The effective pinhole values will be displayed in the line below the Airyscan modes.

Detection gain is set in the same way as the internal detectors by the Gain and digital gain sliders.

#### SR, VP, CO, Pinhole

To set the system for increased resolution mode, press the **SR** button (Fig. 164). In this mode, the hardware pinhole has no effect and should not be changed from the default position.

To set the system for virtual pinhole mode, press the **VP** button (Fig. 165). In this mode, the hardware pinhole has no effect and should not be changed from the default position.

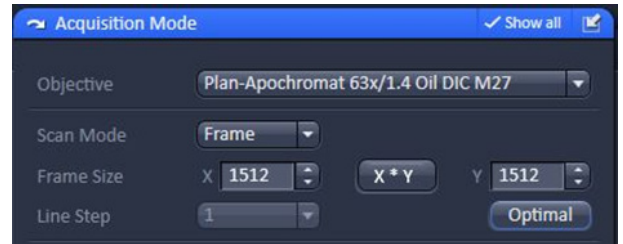
To set the system for conventional confocal mode, press the **CO** button (Fig. 166). In this mode, the hardware pinhole is effective and can be set at the required value for confocal sectioning.

### Optimal pixel number and size

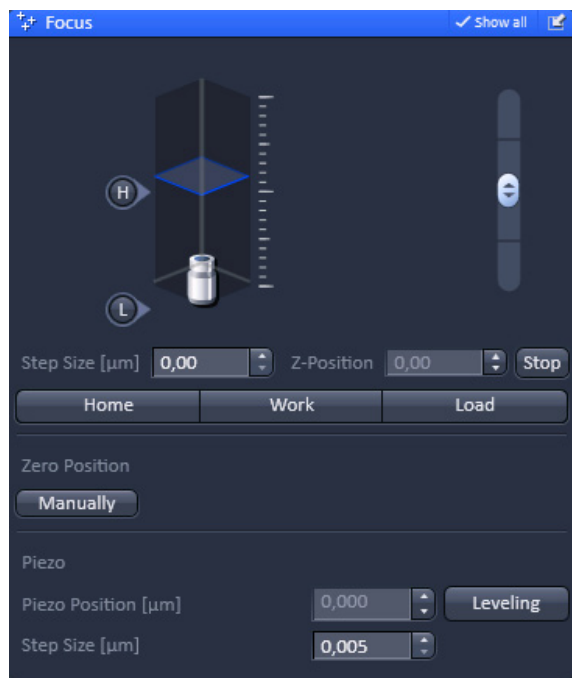
Depending on the detection mode, the required oversampling value for the pixel number and size changes.

This is adjusted automatically by using the **Optimal** button in the **Acquisition Mode** dialog (Fig. 167) after choosing a detection mode.

SR mode needs twice the sampling compared to VP and CO mode in order to realize the resolution increase.



**Fig. 167** Acquisition Mode: Airyscan settings



**Fig. 168** Focus tool

### 5.2.10 Acquisition Parameter – Focus

If the **Focus** tool tab is expanded the **Focus control** tool becomes available (Fig. 168).

The **Z-Position** display box shows the current z-position.

The number can be edited by typing or using the arrowheads. The nosepiece or stage will automatically update the new position.

By pressing the **Stop** button, you can stop the current movement. The **Step Size (µm)** display box shows the currently used step size for focus movement. The value can be edited by typing or using the arrowheads.

The **Home** button sets the z-position to the predefined zero value.

Pressing **Load** will lower the nose piece (z-position) for objective change.

**Work** brings the z-position back to the actual used position if the focus was zeroed or in **Load** position.

Home and Load positions can also be accessed from the z-position display by pressing the **H** or **L** buttons.

The z-position can be altered by grasping and sliding the **plane** or by using the arrow slider. The **plane** shows the actual z-position.

Pressing **Manually** in the **Zero position** field will set the current z-position to 0.

If a **Z-Piezo stage** insert is in use and active then pressing **Leveling** in the **Piezo field** will center the Piezo stage position in regard to the microscope focus drive.

The **Piezo Position (µm)** input box allows the position of the Piezo to be altered.

The **Step Size (µm)** display box shows the currently used step size for focus movement of the **Z-Piezo stage**.

#### Use of an optional high resolution focusing device (Piezo objective focus or Z-Piezo stage insert)


The **Piezo Position** is indicated as a numerical value. This value and with it the focus position can be changed. A change of this value updates the value of the microscope focus accordingly.

The Step Size, by which the Piezo focus moves when clicking on the arrows, can be set between 0.005 µm and 10 µm.

As soon as the focus position of the microscope is changed (via hand wheel or software), the piezo objective focus is automatically levelled.

- A click on the **Leveling** button moves the Piezo objective focus or Z-Piezo stage insert into the center position of its travel range and the focus position of the microscope is reset to compensate for the leveling. Therefore, the same Z-level remains visible (the current position is not set to zero).

The motor focus of the stand is operated in the same way via the relevant buttons. Moving into the **Work** or **Load** position is always performed via the motor focus and not via the Piezo objective focus.

 Please see CHAPTER 4: ANNEX for further information on the Piezo objective focus and Z-Piezo stage insert.

### 5.2.11 Acquisition Parameter – Focus Devices and Strategy

**Focus Devices and Strategy** aims to maintain focus stability in multi-dimensional acquisition experiments.

This tool is typically employed to compensate for Z-drift in time series experiments as well as for the tilt of samples when recording at multiple positions using a scanning stage.

**Focus Devices and Strategy** features four different autofocus modes to be used in combination with the acquisition tools **Time Series**, **Tile Scan** and **Positions**.

These modes employ either the optional module **Definite Focus** or the built-in detection capabilities of the LSM.

The set of available autofocus modes therefore depends upon a system's hardware configuration. The LSM-based autofocus modes **Fluorescence**, **Reflection** and **Autofocus Map** cannot be used if an acquisition strategy includes tracks with camera-based image recording.

The **Focus Devices and Strategy** tool (Fig. 169) provides controls for maintaining focus stability with the **Tile Scan** and **Positions** tools.

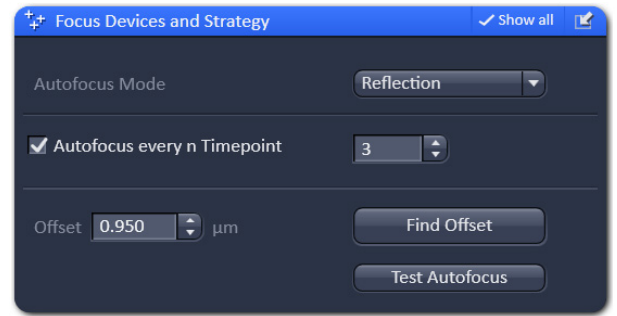


Fig. 169 Focus Devices and Strategy tool

#### Autofocus Mode

**Autofocus Mode** specifies the method to be used throughout the course of a multi-dimensional experiment.



The menu for mode selection features a maximum of four active modes (or Off mode):

- Fluorescence
- Reflection
- Autofocus Map
- Definite Focus

All LSM-based autofocus modes rely on the optical sectioning capabilities of a LSM for precisely locating signal intensity maxima in the Z-direction.

The Z-position of an intensity maximum found within the search range is used as a reference for the positioning of the imaging plane in the Z-direction.

In many cases, reference and imaging plane are not identical but differ by a fixed distance referred to as **offset** (see **Reflection** and **Autofocus Map** modes below).

Whenever a focusing action is executed, the Z-position of the imaging plane is updated.

**Off mode** 

If **Off** is selected, autofocus is inactive and will not be used.

If a multi-track acquisition includes a track that employs a camera for data capture, the autofocus mode is automatically set to **Off** in **Focus Devices and Strategy**.

**Fluorescence mode** 

**Fluorescence** uses the current track configuration for detecting fluorescent signals (as specified in the **Channels** tool) for identifying the focus reference plane.

In LSM-based multi-channel acquisitions (channels in a single or multiple tracks), the identification of the focus reference plane is based upon the intensity maximum of all channels.

Choosing the **Fluorescence** mode is useful e.g. when imaging monolayers of cells with stained nuclei.

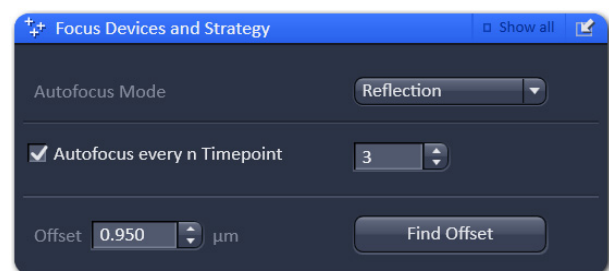
Here, the fluorescent signals of their nuclei provides an ideal reference plane for imaging the cells.

The **Fluorescence** mode is not an ideal choice for thick samples that do not feature a clearly detectable intensity maximum.

**Reflection mode** 

In contrast to the **Fluorescence** mode, the LSM-based **Reflection** autofocus mode uses incident laser light reflected at surfaces (e.g. glass surfaces of cover slips) for identifying reference planes.

Measuring the Z-position of glass surfaces through laser reflection is only possible in the presence of a refractive index mismatch. Readily detectable laser reflection occurs at the interfaces of either glass and air or glass and water-like media (e.g. cell culture media in glass-bottom dishes). The **Reflection** mode is ideal for maintaining focus stability in long-term observations of adherent live cells kept in glass-bottom dishes. **Reflection** cannot be used if no laser reflection is expected to occur at any of the glass surfaces (e.g. when using immersion oil and mounting media with a highly similar refractive index as glass). Among all laser lines activated in the imaging tracks (see **Channels** tool, section **Acquisition Parameter – Channel**), the **Reflection** mode uses the one with the longest wavelength for focusing. ZEN automatically sets the output power of this laser line and also configures the **Imaging Setup** for detecting laser reflection.



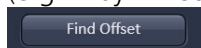
**Fig. 170** The offset value is either specified manually or determined automatically.

The distance between the Z-level of image recording and the Z-level of the reference plane (e.g. surface of a cover slip) is specified by the parameter **Offset**.

Offset is available in the **Reflection** and **Autofocus Map** autofocus modes (see below).

The **Offset** value can either be entered manually or measured automatically using **Find offset** (Fig. 170).

The system requires automatic measurements of Offset to be focused on the desired imaging plane (e.g. by visual inspection) before pressing




Find offset searches for a reflective surface (the focus reference plane) starting at the Z-level of the imaging plane. Next, it copies the increment between the Z-levels of the imaging plane and the focus reference into the **Offset** spin box. See description of **Positions** tool (section **Multidimensional Acquisition – Positions**) for details on how to specify **Offset values** in multi-position experiments.

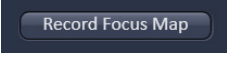
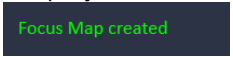
### Autofocus Map mode



**Autofocus Map** aims to minimize the time spent on maintaining focus stability in experiments that involve multiple cycles of data recording from arrayed samples. This autofocus mode is therefore helpful when working with e.g. microtiter plates that are slightly tilted or feature wells with uneven bottoms.

Autofocus Map is only available in the **Sample Carrier** method of the **Positions** tool and cannot be combined with **Tile Scan**.

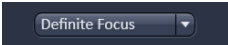
Before starting an imaging experiment using **Autofocus Map**, a **Focus Map** has to be recorded for all positions selected in the method **Sample Carrier**. If no **Focus Map** is present, ZEN displays the notification .

After pressing , ZEN uses laser reflection (see autofocus mode Reflection for details) to map the reference planes in all these positions. This information is stored (but not displayed) as a **Focus Map**. After the successful generation of a Focus Map, ZEN displays the notification .

The fundamental requirements as well as the strategy for using **Offset** are identical in **Autofocus Map** and **Reflection** (see above).

The same **Offset value** is applied to all positions of the sample carrier. As the **Focus Map** is only created once and its information subsequently used in all acquisition cycles, **Autofocus Map** provides a speed improvement when working with arrayed samples. Autofocus Map does not correct for Z-drift over time. If such compensation is needed, the autofocus mode **Reflection** should be selected for arrayed samples.

### Definite Focus mode



Selecting this mode activates the **Definite Focus** unit. Activity intervals (see below) are set like with all other autofocus modes. See operating manual of Definite Focus for reference.

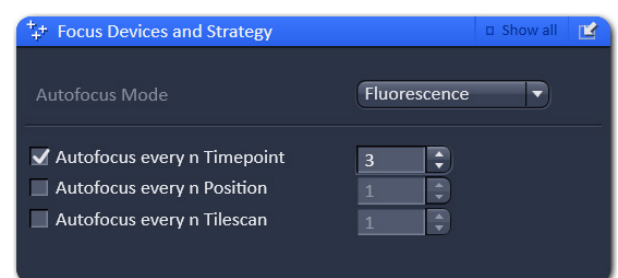
### Specifying Activity intervals for focus actions

Activity intervals for focusing can be specified for the **Fluorescence**, **Reflection**, and **Definite Focus** modes.

It is advisable to minimize the number of focusing activities in order to improve the speed of the overall acquisition and to protect delicate samples from laser damage.

However, optimal conditions need to be determined experimentally.

As soon as one of the acquisition tools **Time Series**, **Tile Scan**, or **Positions** is activated, focus intervals can be linked to these tools in **Focus Devices and Strategy** (Fig. 171).




**Fig. 171** Specifying activity intervals for focus activities

---

Here, the **Autofocus every n Timepoint** check box is checked and a value of **3** entered in the associated spin box.

A focusing event will be executed before the first acquisition and after the completion of three acquisition cycles. In this example, control of activity intervals is only linked to the acquisition of the time series.

The performance of the **Fluorescence**, **Reflection** and **Autofocus Map** autofocus modes can be readily tested with a defocused sample.

After pressing the  button, the system will be guided to the imaging plane.

An image acquisition will be triggered automatically as soon as the system arrives at this Z-position.

Next, the system will travel back to the Z-level it started from when  was clicked.

**Test Autofocus** is only available if **Show all** is active.

Testing applies the currently selected autofocus mode and performs the test at the current XY position.

With the modes **Reflection** and **Autofocus Map**, the value for **Offset** will be taken into consideration.

### Status information with LSM-based autofocus modes

The first focus action with one of the LSM-based modes is performed as a two-step procedure including a coarse focusing (XZ line scan) followed by a fine focusing step (XY frame scan).

ZEN displays the corresponding status messages  and .

Subsequent focusing is performed as an one-step approach and displays the status message

.



### 5.2.12 Acquisition Parameter – Stage

The following software description applies to systems which are equipped with a motorized scanning stage.

If the **Stage** tool window is expanded the **Stage control** tool becomes available (Fig. 172).

By pressing the **Stop** button you can interrupt any stage movement.

The **Move to Zero** button will move the stage to the current zero positions of the x and y coordinates.

The compass rose will move the stage in the direction of the arrowheads, which appear, when the mouse pointer is being in the field.


Fast movement is obtained with the outer rose, slow movement with the inner rose. The **X-Position (µm)** and **Y-Position (µm)** display boxes show the actual x and y coordinates.


You can edit the numbers by typing or using the arrowheads. If numbers were altered, the first click on the compass rose will bring the stage to the altered position.

The **Step Size (µm)** display box show the currently used step size for stage movement. The value can be edited by typing or using the arrowheads. The **Zero Position Set** button sets the x and y coordinates to 0.

If the **Mark** button is pressed, the current center position of the image will be stored. It can be recalled by selecting the position from the **Marks position list** drop down menu (Fig. 173).

Pressing the **Move to button** will bring the stage back to the position of the loaded position. By pressing **Remove**, the actual displayed position will be deleted. Pressing **Remove All** will delete all stored positions.

 If only one selected position is deleted, the position with the next number in sequence moves up one number.

 If a new **Zero** Position is **set** the coordinates of the marked positions are updated in relation to the new Zero Position.

The focus is moved to the marked position selected form the drop down menu by clicking **Move To**. Three different values for the **Speed Settings** are available. They can be assigned interdependently to **Speed 1-3**.



Fig. 172 Stage control tool

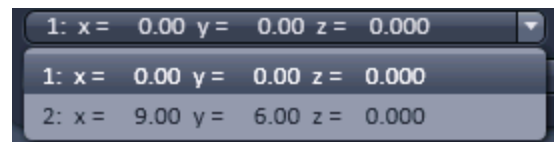


Fig. 173 Marks position list drop down menu



### 5.2.13 Acquisition Parameter – Shuttle and Find

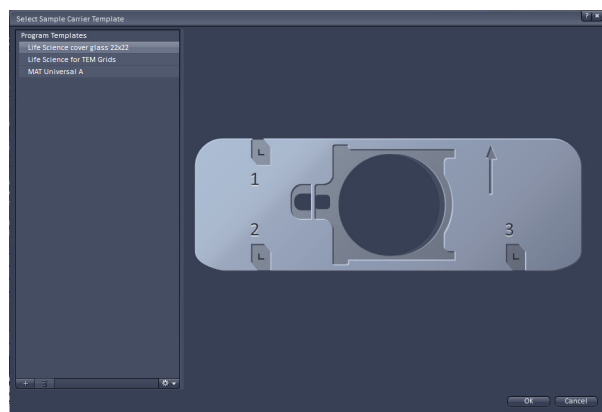
**Shuttle and Find** allows calibration and imaging of sample positions in laser scanning microscopes (LSM) for reproducible repositioning after transfer to scanning electron microscopes (SEM).

For **Shuttle and Find** different types of sample holders are pre-designed. In addition the user can define other correlative sample holders.

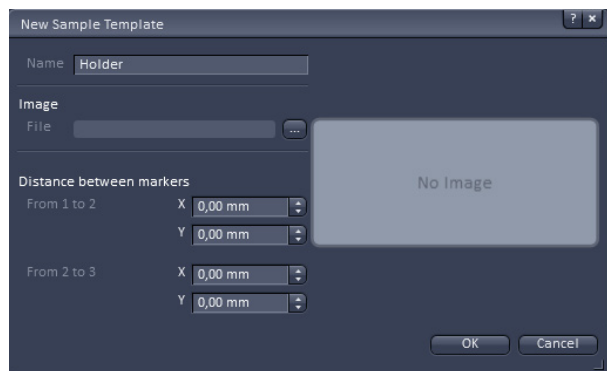
The correlative sample holders have three fiducial markers enabling a three point calibration.

The calibration can be done in transmitted light or reflected light.

-  A motorized microscope stage is mandatory.
-  The workflow is unidirectional from LSM/SR to SEM only.




**Fig. 174** Select Sample Carrier Template dialog



**Fig. 175** New Sample Template dialog

Different types of sample holders are available (Fig. 174), e.g.:

- Life Science cover glass 22x22
- Life Science for TEM Grids
- MAT Universal A
- etc.

-  The Life Science cover glass 22x22 or the sample holder for TEM Grids should not be used together with Axio Imager and Axio Examiner equipped with a level adjustable sample holder. During the calibration procedure the objective or neighbouring objectives will collide with the level adjustable holder.

#### Creating of user-defined correlative holders

In the calibration dialog window new correlative holder files can be defined (Fig. 175).

- Click on the **+** button in the **Select Template** dialog.
- Type in a name for the new holder / sample carrier. An image of the new holder can be loaded.

In the holder file the distances (in millimeters) between the first and the second marker and between the second and third marker have to be inserted.

The distances can be determined using the **Positions** button in the **Dimensions** control view and the functionality for **Marks** in the **Stage** tool in the Left Tool Area.

- Activate the **Positions** button and click on the first correlative marker.
- Determine the coordinates by clicking on **Mark** in the **Stage** tool.
- Go on with this procedure for marker two and three. Use coordinates for calculating the distances between the markers.

### Mounting of cover glasses or TEM grids

- Place the specimen (sample carrier) in the suitable sample holder and fix it:

Life Science Cover Glass 22x22:

- Remove the clamping frame (Fig. 176/1) using tweezers.
- Insert the cover glass (Fig. 176/2) in the sample holder (Fig. 176/3).
- Slide in the clamping frame into the sample holder until the clamps are clicking into place (Fig. 176/4).

Life Science for TEM Grids:

- Lift the spring (Fig. 176/5) of the appropriate position and turn it side wards.
- Insert the TEM grid (Fig. 176/6) into the provided holding spot of the holder (Fig. 176/7) and fix it with the spring.

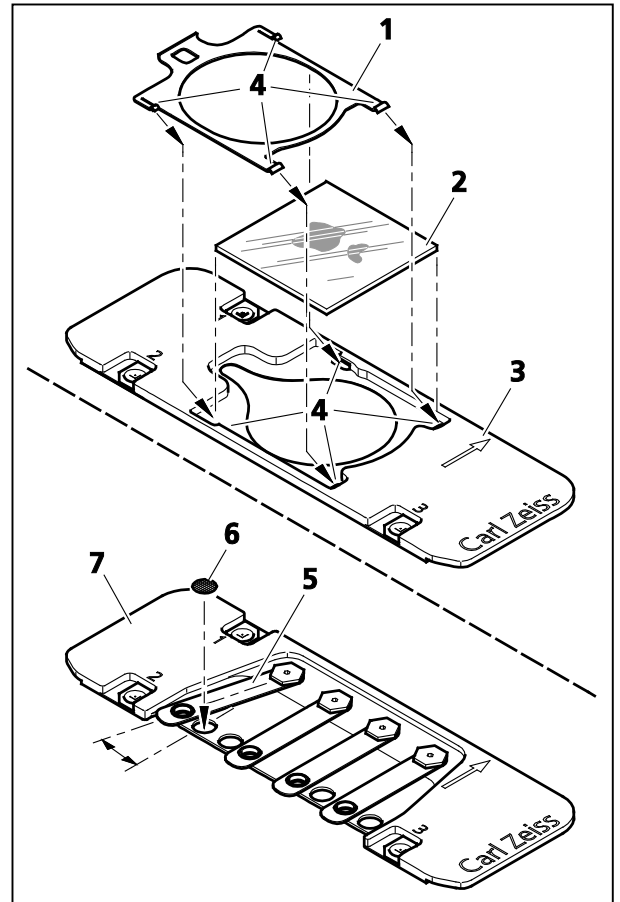


Fig. 176 Mounting of cover glasses or TEM grids

### Inserting a sample holder (various mounting frames are possible)

- Insert the sample holder into the mounting frame (Fig. 177/3) of the microscope stage in the following way:
  - for inverted stands, see Fig. 177/1
  - for upright stands, see Fig. 177/2

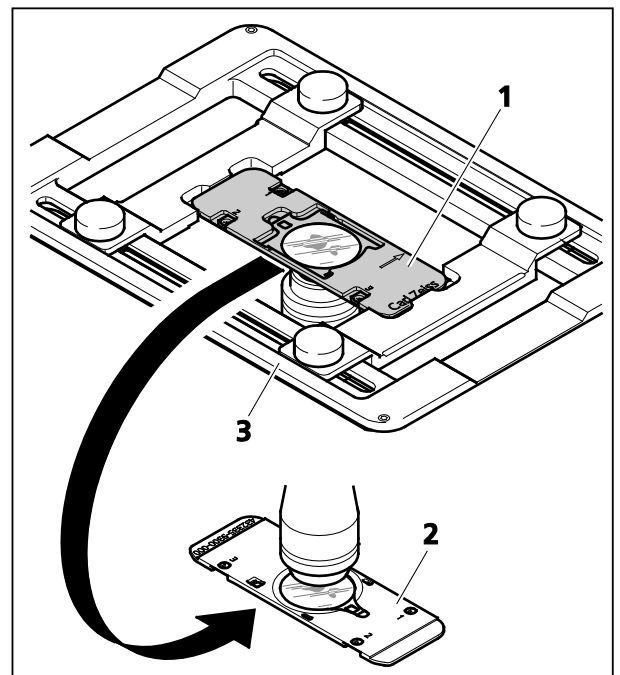


Fig. 177 Inserting a sample holder

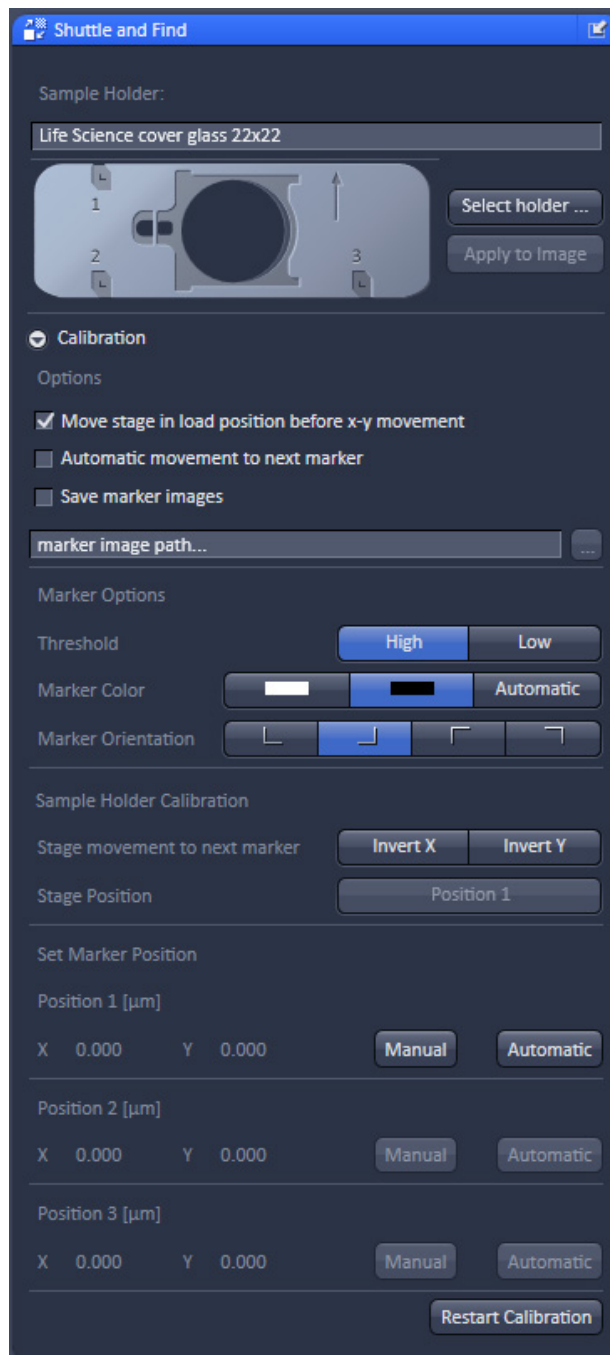


Fig. 178 Shuttle and Find tool

## Calibration

The calibration markers consist of one small and a large L-shape marker. The bigger marker is used for coarse orientation, whereas the smaller marker is used for the calibration.

- Set the microscope for eyepiece observation.
- Use a dry objective.
- Move the microscope stage to the marker position **1** of the specimen holder.
- Focus on the small marker.
- Select the **Acquire** tab and open the **Shuttle and Find** tool in the **Acquisition Parameter** tool group (Fig. 178).
- Select the appropriate holder type from the list by clicking the **Select holder ...** button, e.g.: **Life Science cover glass 22x22**.

The currently selected holder type is then shown in the **Sample Holder:** panel.

**Apply to Image** applies the current calibration to an acquired image. Do not remove the sample of the holder between image acquisition and calibration. Use this button only, when you forgot to calibrate the holder before you acquired the image.

- Choose general options for the calibration in the **Marker Options** field:

**Move stage in load position before x-y movement** moves the stage to load position before moving to the next relative calibration marker. In case of using an Axio Observer, the objective revolver moves to load position.

**Automatic movement to next marker** moves the stage automatically to the next marker during the calibration procedure if the position of the relative marker has been set manually or confirmed (automatic marker detection). If this checkbox is not activated, the stage has to be moved manually to the next marker.

**Save marker images** saves the marker images during the calibration. The images can be used to check the calibration afterwards. Click on the **Select Folder (...)** button to select a storage folder.

- Configure the beam path manually or select an appropriate configuration from the list (**Load Acquisition Parameters**).
- Click on the **Continuous** button to start the continuous scanning.
- Choose the options for marker recognition within the **Marker Options** field.

**Threshold: High – Low:** A low threshold for marker detection is used when the dimensions of the correlative L markers cannot be recognized precisely, e.g. when the sample holder is slightly filthy.

**Marker Color: White – Black – Automatic:** Select the color of the markers (as it appears in the image window) or leave it to automatic.

**White:** The marker is displayed white on a dark background.

**Black:** The marker is displayed dark on light background.

**Automatic:** The marker color is set automatically.

**Marker Orientation:** Select the correct orientation of the L-markers on your sample holder from the **Marker Orientation** field. Click on the corresponding button to set the same orientation like you see it in the live image.

**Sample Holder Calibration** field: The marker recognition during the calibration can be done either automatically or manually. During the calibration the stage can moved automatically to the next marker, when the **Automatic movement to next marker** checkbox is activated. If the stage is moving in the wrong direction, invert the direction by clicking on **X Invert** or **Y Invert** in the **Sample Holder Calibration** field.

If the first marker position was already set once and x/y coordinates are given, the stage can simply be moved to marker position one by clicking on the **Position 1** button.

### a) Automatic marker recognition

The software proposes the position of the marker visible in the live image.

- Click on the **Continuous** button to start continuous scanning.
- Move the stage to the first marker manually or click **Position 1** in the software in case the first marker position was already set once and x/y coordinates are given.
- Click **Automatic** in the **Position 1** field (Fig. 179).

The software will propose the position of marker 1 in a separate window (**Marker location found** dialog (Fig. 180)).

- Click on **Accept** in the **Marker location found** dialog to confirm the proposed marker position. Click **Reject** if proposed position is not correct.

☞ Contamination of the markers or weak contrast settings may interfere with the marker recognition.

☞ If the proposed position is not correct, either optimize the contrast settings or use the manual marker recognition.

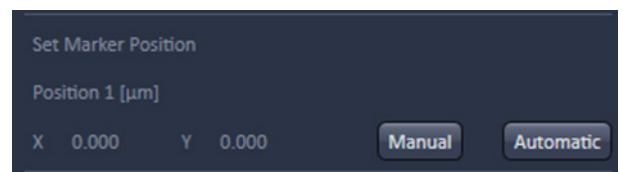


Fig. 179 Position 1 field

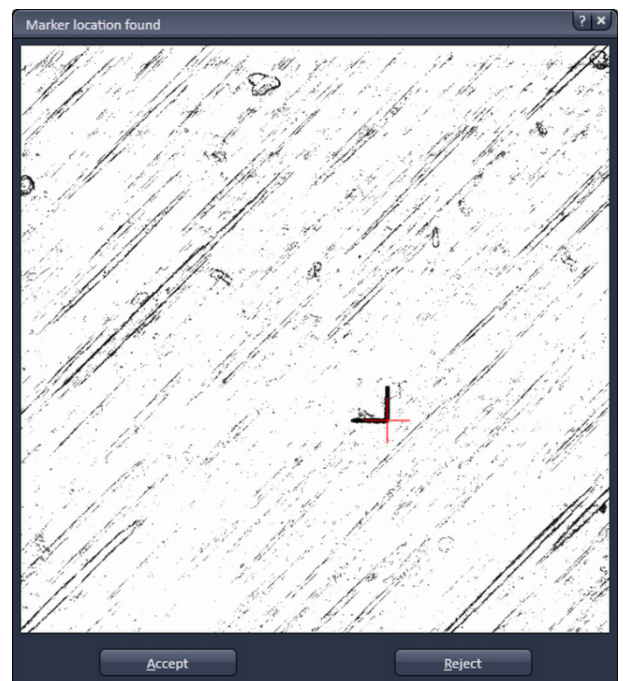


Fig. 180 Marker location found dialog

- If the **Automatic Movement to next Position** is activated, the stage will move automatically to the next marker (Position 2) after clicking **Accept**. Otherwise, the marker 2 has to be found manually.



**Fig. 181** Sample Holder Calibration field, Stage movement to next number

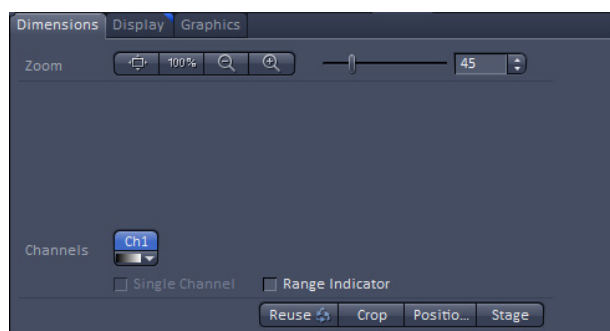
- If the stage is moving in the wrong direction, invert the direction by clicking on **X Invert** or **Y Invert** in the **Sample Holder Calibration** field (Fig. 181).
- When marker 2 is in position refocus and click on **Find Marker** in the Position 2 field.

- The system will propose the position for marker 2 in a **Marker location found** dialog. Confirm the proposal if the position is correct.

The stage moves automatically to marker 3.

- Click on **Find Marker** in the Position 3 field and confirm the position if correct.

The calibration is finished. The calibration can be started by clicking on **Restart Calibration** in the **Shuttle and Find** tool window.



**Fig. 182** Positions button in the Dimensions control tab of the 2D view


### b) Manual marker recognition

If the marker on the sample holder is not recognized or user-defined markers are used, the marker positions can be set manually.

- Activate the Acquisition Parameter **Positions** within the Acquisition Parameter list.
  - Click on the **Continuous** button to start continuous scanning.
  - Move the stage to the first marker.
  - Click on **Snap** to acquire a single image.
- Activate the **Positions** button in the **Dimensions** control tab (Fig. 182).
  - Click either on the calibration marker or a user-defined marker to set a crosshair in the image and thus define the position of the marker.
  - Confirm the position by clicking on **Manual** in the **Set Marker Positon** section within the **Shuttle and Find** tool.
  - If the **Automatic movement to next marker** checkbox is not activated, move the stage to the second marker and got on as described above.
  - Repeat the same procedure for the third marker.

### Image acquisition and saving

- Acquire images of your sample as you are used to.
- For saving (Fig. 183) the images together with coordinates and defined regions of interest or points of interest use the .dzi file format.
- Enter the name of the image and click on **Save**.

 It is possible to zoom the scan area using the **Acquisition Mode** tool, but it is not possible to rotate or slide the scan area.

### Mounting of the correlative sample holder into the SEM

- to use the specimen in a scanning electron microscope, remove the sample holder (Fig. 184/2) from the mounting frame of the microscope stage and insert it in the special SEM adapter (Fig. 184/1).



Fig. 183 File menu, Save As function

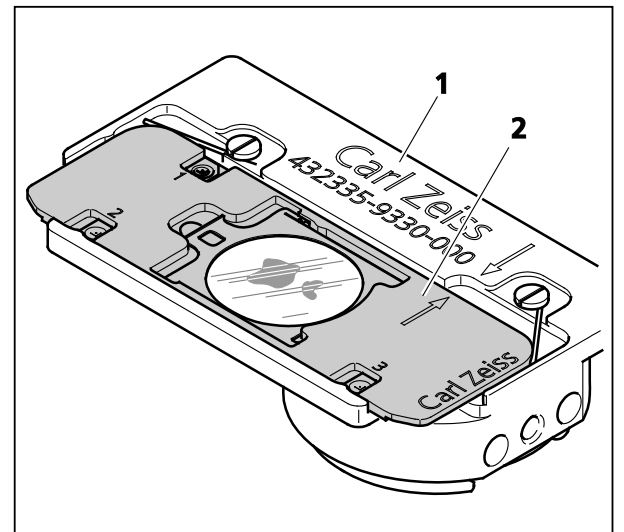


Fig. 184 Inserting the sample holder in the SEM adapter

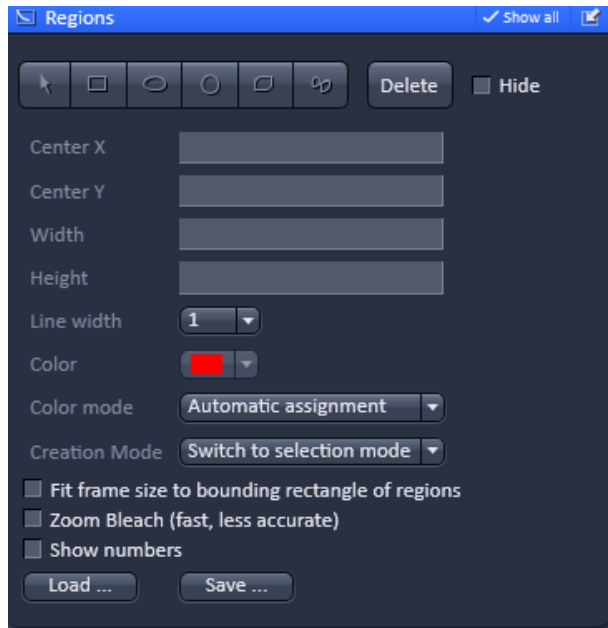


Fig. 185 Regions tool

### 5.2.14 Acquisition Parameter – Regions

The **Regions** tool tab is only available, if the **Regions** checkbox is ticked in the Multidimensional acquisition field. If the tool bar is expanded, the **Regions tool** becomes available (Fig. 185).

The **Regions** tool allows the user to define Regions of Interest (ROI) which are used for display for **WF**, **SIM** and **Laser WF imaging** modes as well as image acquisition, sample manipulation (bleaching) and image analysis for **LSM imaging** mode.

The control of the laser in **LSM imaging** mode via AOTF technology enables the restriction of the illumination to the defined region. The sample is only illuminated when data are acquired. In widefield techniques (**WF**, **SIM**, **LSM WF**), the whole sample is always illuminated, even if only the region is displayed.

The definition of the regions is done using an actual image of the sample and drawing the regions into this image (Fig. 186, Fig. 187). This makes it extremely easy to set the regions in the right position and dimension.

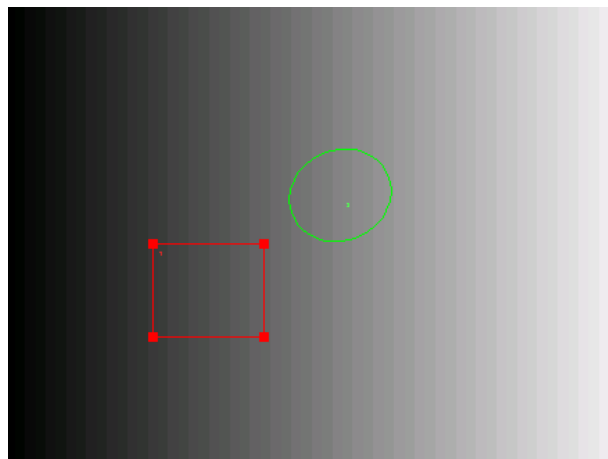


Fig. 186 Image with two defined regions, the square one is selected

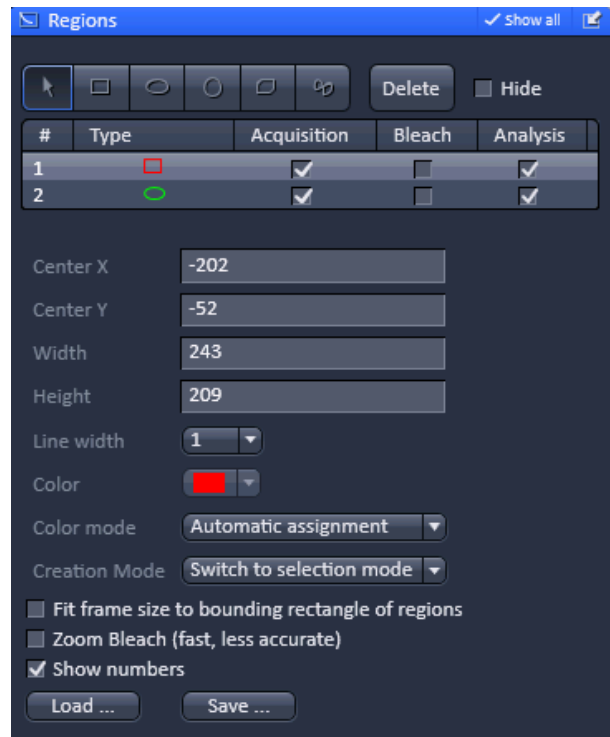


Fig. 187 Regions tool



The following tools are available in the **Tool selection** field:



Selects an existing region in the image. The outline of the region is marked with small rectangles to show it is active. The format and the position of the region can be changed clicking on the rectangles or the region outline and dragging it with the cursor. In addition the numerical values describing the position and size of the region are updated.



**Rectangle:** Drawing of a rectangle in the **Image Display** window; click and keep mouse button pressed, drag the rectangle in any direction, let go off the mouse button to end the procedure.



**Ellipse:** Drawing of an ellipse in the **Image Display** window; first click sets the center point, displayed line permits determination of the extension, second click sets the first dimension, then the second dimension and the rotation direction can be determined, third click sets the second dimension and direction and ends the procedure.



**Circle:** Drawing of a circle in the **Image Display** window; click and keep the mouse button pressed to set the center point, drag the diameter, let go off mouse button again to end the procedure.



**Polyline:** Drawing of a polyline figure in the **Image Display** window; first click sets the starting point, each further click adds a line, double-click on the starting point closes the figure and ends the procedure.



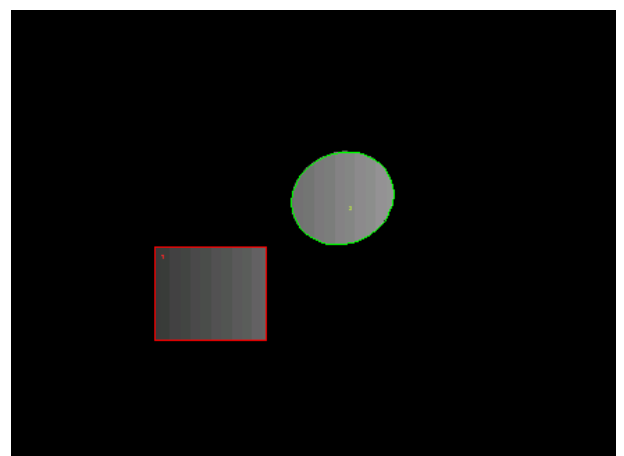
Closed **Bezier:** Drawing of a bezier figure in the **Image Display** window; first click sets the starting point, each additional click adds a line, double-click on the starting point closes the figure and ends the procedure.

By pressing the **Delete** button, the highlighted region will be removed. By ticking the **Hide** checkbox, the region will be hidden in the image.

All drawn regions will be listed in the **Region list** field. They are identified by an assigned number and its form.

The task (**Acquisition, Bleaching, Analysis**) for which a region will be used can be defined by ticking the respective boxes (Note that **Bleaching** is only useful in the **LSM imaging** mode).

E.g., if Acquisition is checked, only the defined region is illuminated (**LSM imaging** mode only) and displayed (Fig. 188). Any combination of these tasks is possible.



**Fig. 188** Image with two defined regions used for imaging

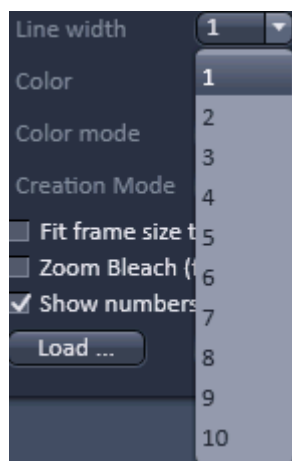


Fig. 189 Line width drop down menu

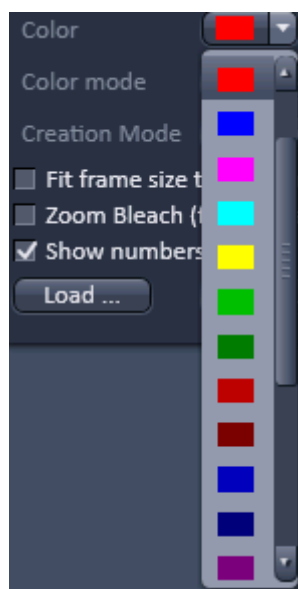


Fig. 190 Color drop down menu

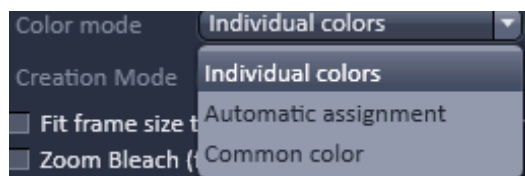



Fig. 191 Color mode drop down menu

When highlighting a ROI in the list, the numerical parameters for **Center X**, **Center Y**, **Width** and **Height** in pixels will be shown in **Region feature** field. In addition the ROI will be set to active in the image.

 Note, when a PALM (HR) image is displayed numbers will refer to the PALM image and not the SWF image, which normally do have different pixel resolutions.

It is possible to change the **Line width** from the Line width drop down menu (Fig. 189).

The **Color** of the outline of a ROI can be changed in the **Color** drop down menu (Fig. 190). The scroll bar gives access to all available colors.

Color selection is only possible if either **Individual colors** or **Common Color** is chosen in the drop down list of the **Color mode**.

The **Color mode** drop down menu allows defining how colors will be assigned to the outline of a region (Fig. 191). **Individual colors** allow the assignment of different colors to different regions.

If **Automatic Assignment** is chosen in the **Color mode** a color will be automatically assigned to each region as it comes.

The choice of Color is inactive in this mode. **Common Color** assigns the same color to all regions.

The **Creation Mode** drop down menu offers three different settings for defining ROIs (Fig. 191). **Switch to selection mode** activates the arrow tool once the region is drawn in the image. **Multiple elements** allow drawing multiple regions of the same type in a sequence. **One element only** restricts the number of ROIs to be drawn in the image to one. Any new region deletes the previous one.

The laser usually scans the entire line length, but is limited in the Y-direction by the ROIs outline. The Scan Time is therefore reduced. It is possible to reduce the movement of the scanner also in the X direction along the line by checking the box next

to **Fit frame size to bounding rectangle of regions**. This then corresponds to zooming in onto the region. The frame size will be updated accordingly in addition to the scan time. This applies for image acquisition using a ROI. This function will only be applied for the **LSM imaging** mode. For widefield modes (**WF**, **SIM**, **LSM WF**) it will be ignored.

If a region is used to define a position for bleaching within the sample, the bleach process can be accelerated by checking the box next to **Zoom Bleach (fast, less accurate)**.

In this case the scanner movement will be restricted to the bleach region zooming in onto this region. This may result in a less accurate positioning of the region as the definition of the region has been made in a different zoom in the image.

The bleach process will be faster than without this option. The gain in speed is dependent on the speed that is used for bleaching. If a high speed has already been chosen for bleaching the gain in speed will be minimal.

This function will only be applied for the **LSM imaging** mode. For widefield modes (**WF, SIM, TIRF**) it will be ignored

The numbers of the different regions will be shown in the image if the check box next to **Show numbers** is checked.

Regions can be saved by pressing the **Save...** button using **Windows Explorer**.

This process stores all regions currently displayed in the Regions tool in one file. Saved images can be loaded later on by pressing the **Load...** button using the **Windows Explorer**.

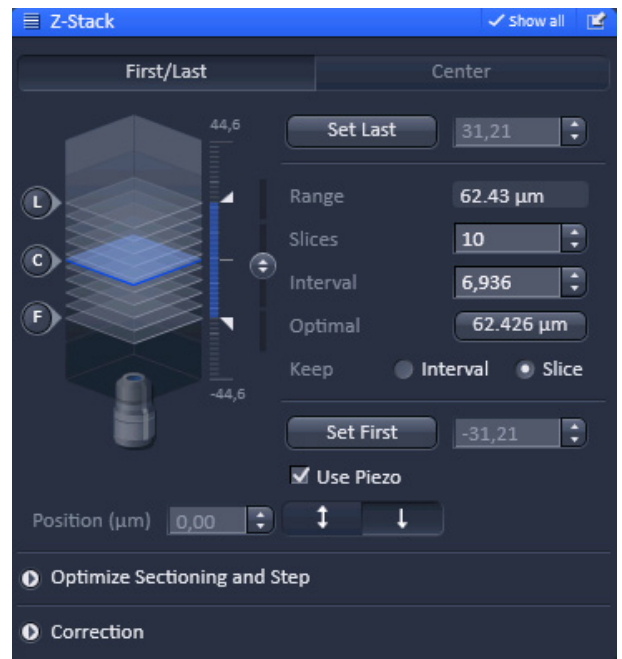
### 5.2.15 Multidimensional Acquisition – Z-Stack

The **Z-Stack** tool tab is only available, if the **Z-Stack** checkbox is ticked in the **Multidimensional acquisition** field. If the tool bar is expanded, the **Z-Stack** tool becomes available (Fig. 192). When **Start Experiment** is pressed the system will perform a Z-Stack.

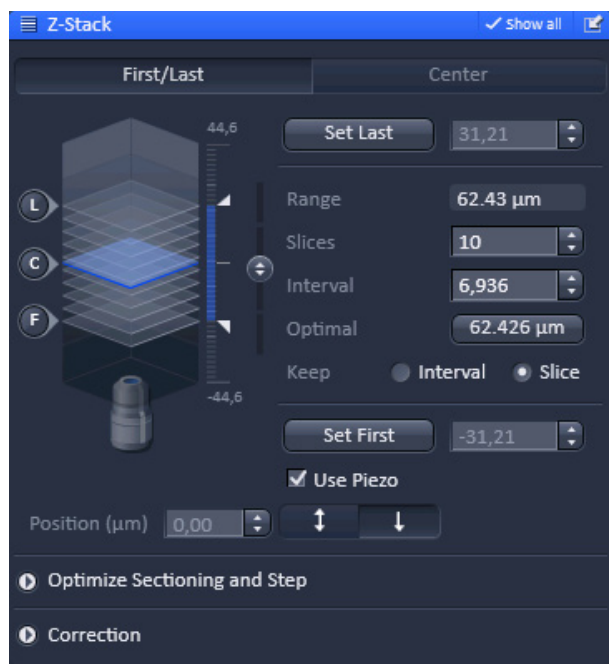
With the Z-Stack function a series of XY-images in different focus positions can be acquired resulting in a Z-Stack. In this way a 3 dimensional data set from the specimen is obtained.

The way in which the Z-Stack is acquired can be selected by pressing either the **First/Last** or **Center** mode buttons. The modes differ in the way the first and last images of the stack are selected. The **Center** mode is only available in the **Show all** mode.

In case a **Z-Piezo** stage insert focusing device is attached to the system, the Piezo device can be chosen for the acquisition of the stack.



**Fig. 192** Z-Stack tool First/Last mode with Z-Stack Navigation displayed for the LSM image mode



**Fig. 193** Z-Stack Navigation appearance for the LSM image mode

### 5.2.15.1 Performing a Z-Stack Using First/Last Mode

Press the **First/Last mode** button to open the **First/Last definition** panel.

Press the **Continuous** action button and focus onto the specimen.

While scanning change the focus using the **Acquisition Parameter - Focus** tool, the **Z-Stack Navigation** (Fig. 193) or use the focus drive of the microscope.

When you reach the position within the specimen, where you would like to start the stack, hit **Set First** and this position (in  $\mu\text{m}$  referring to the 0 position of the Z drive) will be taken as the first position in the stack.

Move the focus into the other direction until the end position within the stack is reached, then hit **Set Last**. These focus positions are then indicated next to **Set First** and **Set Last** buttons. The **Range** display box shows the total height of the stack in micrometers.

The **Slices** input box displays the number of slices of the stack. This number can be edited by typing or using the arrow keys. Changing the value for **Slices** automatically adjusts the **Interval** in a way that the total **Range** for the stack is maintained.

The **Interval** input box displays the z-distance (interval) between slices in  $\mu\text{m}$ . This number can be edited by typing or using the arrow keys. Changing the value for the **Interval** automatically adjusts the **Number of Slices** while keeping the total **Range** for the stack within the possibilities of fitting the calculated number of slices into the Range. The total Range may therefore vary to higher and lower numbers around the **initial value of the Range**.

Pressing the **Optimal** button (only available in **SIM** and **LSM** imaging modes, greyed out in **WF** and **Laser WF imaging** modes) sets **Interval** to match the Nyquist criteria (2 fold over sampling) and accordingly adjusts the **Slices** to keep the **Range** within the limits defined by **Set First** and **Set Last**. The optimal interval is displayed in the button in  $\mu\text{m}$ .

Within the **Keep** display field (only available in **Show all** mode) you have the option to switch between **Keep Interval** and **Keep Slice**. If **Keep Interval** is checked, the number of slices is adjusted to a new **Range** defined pressing **Set First** or **Set Last**. Likewise, when **Keep Slice** is checked, the value for the **Interval** between the slices is adjusted to a new Range defined by pressing **Set First** or **Set Last**.




The **Position ( $\mu\text{m}$ )** input box indicates the current position of the focus, no matter if the focus drive or a **Z-Piezo** stage insert was used for positioning. The focus is changed in small steps when clicking the arrow keys.

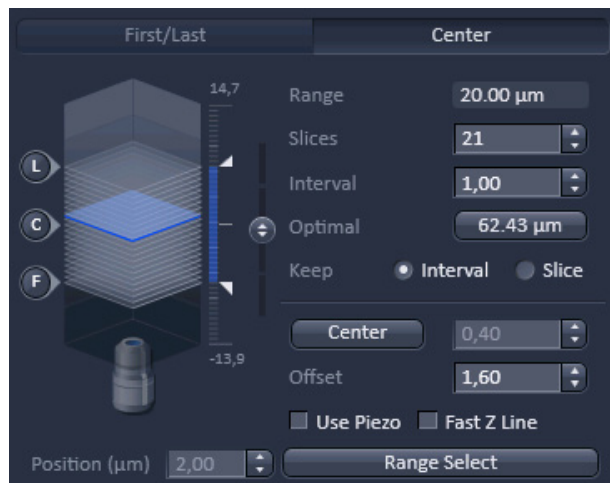
If the **Use Piezo** check box is ticked (only available, if a **Z-Piezo** stage insert is attached to the system), the **Z-Piezo** stage insert will be used to perform all Z movements triggered from the software. If the focus drive was used for **Set First / Set Last**, the system will transform this numbers for a matched **Z-Piezo** movement.

The **Fast Z Line** checkbox is only available in **Line Scan Mode** to be selected in the **Acquisition Mode** tool). It is not available with the **Z-Piezo**. If the check box is ticked and **Continuous** action button pressed a fast XZ scan for overviews is performed using a continuous movement of the microscope focus. The stack size is retained and the interval is adapted depending on the scan speed.

The **Z-Stack Navigation** field displays a graphical representation of the Z-Stack. The **white frames** represent the number and localization of the slices. The **blue frame** indicates the current focus position, also during image acquisition. By dragging the **blue frame** with the cursor, the current focus position changes accordingly. The **ruler** immediate on the right indicates the dimensions (range) of the Z-Stack. One can also change the focus position by using the slider tool right to the **ruler**. Click on the circle symbol with the double arrow and move it up- or downwards to change the focus. This tool might also be used for defining the first and last position for the Z-Stack.

The **F**, **C** and **L** buttons indicate the positions of the first slice, center slice and last slice of the stack, respectively. If you press a button, a scan will be triggered at the respective focus position

-  It is not relevant that the first and last position in the software match the absolute first and last position. The microscope will always move against gravity when acquiring the stack ignoring the assignment first and last.
-  The precision of the Z-Stack position can be optimized for very critical applications by taking care that the approach to the first and the last slice when marking the positions will be made from the same direction as the Z-Stack is finally acquired. As the Z-Stack acquisition is always performed against gravity it is recommended to move the objective (for inverted stand Axio Observer and upright stand Axio Examiner) from a lower position to the first slice and then further up to the last slice. During this process be sure to move the nosepiece in this one direction only and that you do not refocus.
-  To obtain best image quality with Z-Stacks using the nosepiece and which are critical regarding the focus impulse, a **Waitstate** can be activated. To this end go to the **Maintain** tab. In the **Option** field expand the **System Options** tab and select the **Hardware** tab. Tick the **Waitstate** check box. Such a wait state is only beneficial at certain acquisition speeds and not needed by default.



**Fig. 194** Z-Stack tool Center mode with Z-Stack Navigation displayed for the LSM image mode

### 5.2.15.2 Performing a Z-Stack Using Center Mode

Press the **Center** mode button to open the **Center definition** panel (Fig. 194). This mode allows setting the Range of the Z-Stack in relation to the current **Focus Position** which is indicated as **Offset**.

In addition it is possible in the **LSM imaging mode** to use the image of a XZ scan (line scan in Z) for positioning the Z-Stack range. This tool sets the first and last slice symmetrically in relation to a defined **Center** position. One should have an idea about the size of the stack when using this mode.

It is useful when several Z-Stacks of the same range should be acquired at different positions within the specimen, as the whole range of the stack can be set to a different position at once using the **Offset** function.

The values for number of **Slices** and **Interval** are taken over from any settings done in **First/Last** mode. The **Offset** defines the **Center** position of the stack in relation to the **Focus Position**.

The **Slices** input box displays the number of slices of the stack. This number can be edited by typing or using the arrow keys. Changing the value for **Slices** leaves the **Interval** untouched, but the total **Range** is adjusted.

The **Interval** input box displays the z-distance (interval) between slices in  $\mu\text{m}$ . This number can be edited by typing or using the arrow keys. Changing the value for the **Interval** automatically adjusts the number of **Slices** while adjusting the total **Range**. The **Slices** number will remain unchanged.

Pressing the **Optimal** button sets **Interval** to match the Nyquist criteria (2 fold over sampling) and accordingly sets the number of **Slices**. The optimal interval is displayed in the button in  $\mu\text{m}$ .

Within the **Keep** display field (only available in **Show all** mode) you have the option to switch between **Keep Interval** and **Keep Slice**. If **Keep Interval** is checked, the number of slices is adjusted to a new **Range** defined pressing **Set First** or **Set Last**. Likewise, when **Keep Slice** is checked, the value for the **Interval** between the slices is adjusted to a new Range defined by pressing **Set First** or **Set Last**.

The **Position ( $\mu\text{m}$ )** input box indicates the current position of the focus, no matter if the focus drive or a **Z-Piezo** stage insert was used for positioning. The arrow keys allow to change the focus in small steps. If the **Use Piezo** check box is ticked (only available, if a **Z-Piezo** stage is attached to the system), the **Z-Piezo** stage insert will be used to perform all Z movements triggered from the software. If the focus drive was used for **Set First** / **Set Last**, the system will transform this numbers for a matched **Z-Piezo** movement.

The **Fast Z Line** checkbox is only available in **LSM imaging mode** and only **Line Scan Mode** to be selected in the **Acquisition Mode** tool. It is not possible with the **Z-Piezo**. If the check box is ticked and **Continuous** action button pressed a fast XZ scan for overviews is performed using a continuous movement of the microscope focus. The stack size is retained and the interval is adapted depending on the scan speed.

---

Pressing the **Center** button will define the current focus position (as defined in the **Position ( $\mu\text{m}$ )** input box) as the center position of the stack. After pressing **Center** the whole range will move by the difference between of the previous center position and the new one. The number in the **Center** input box will then equal the number in the **Position ( $\mu\text{m}$ )** input box.

The **Offset input** box allows to define an offset between the actual focus position as displayed in the **Position ( $\mu\text{m}$ )** input box and the current center position as displayed in the **Center** input box. One can edit the number by typing or using the arrow keys. When defining a specific **Offset** the **Center** position will be recalculated as the actual position plus the offset. Accordingly the range of the Z-Stack is shifted to a different position in Z. Pressing the **C** button of the **Z Navigation** representation moves the actual **Focus Position** to the **Center** position and acquires an image at that position. A Z-Stack is then acquired at the new position when starting the experiment. Hitting **Center** moves the **Center** position back to the actual **Focus Position** setting the **Offset** again to zero.

Use the **F**, **C** and **L** buttons to get images from the first slice, center slice and last slice of the stack. The **Focus Position** updates accordingly. The **Offset** value then might be set to half of the Interval depending on the interval value and the number of slices, as with a lower number of slices or a large interval the real center position of the stack might be just between two slices.

Pressing the **Range Select** button will start a XZ-scan within the **Range** of the Z-Stack. This helps setting the **Range** of the Z-Stack without continuously scanning complete frames. The position of the first and last slice is indicated with a red line, the **Focus position**, which initially corresponds to the **Center** position, is indicated as a green line. Changing the **Offset** value moves the red lines in parallel to the new offset position, the green line, while the **Focus Position** is kept constant. Pressing the **C** button sets the **Focus Position** to the indicated **Center** position and the **Offset** back to zero. In parallel an image at the newly defined **Focus Position** is acquired and displayed. Alternatively, pressing **Center** sets the indicated **Center Position** back to the actual **Focus Position** moving the red lines back to the original position and setting the **Offset** back to Zero. The original values for Number of **Slices**, **Interval** and **Range** are always kept constant. The red lines can be moved independently from each other allowing an optimal adjustment of the Z-Stack range to the specimen. **Center** sets the green line to the center position between the red lines and adjusts the Focus Position accordingly. The original values for Number of **Slices** and **Range** are adjusted. The **Interval** is kept constant.



**Fig. 195** Use Z-Piezo for Z-Stack acquisition – appearance for the LSM imaging mode

### 5.2.15.3 Performing a Z-Stack Using a Z-Piezo

A Z-Piezo allows Z-Stacks to be acquired considerably quicker compared to the focus drive of the microscope stand. The speed advantage depends on the total travel range in Z and the speed of the acquisition of the individual image of a Z-Stack. The available travel range of a Z-Piezo device is much smaller compared to the Z drive of the microscope. A Piezo device allows performing smaller steps in Z with a higher absolute precision for the individual steps. A Piezo device is recommended for 3D measurements of objects and for 3D superresolution imaging (Airyscan).

Tick the **Use Piezo** checkbox (only available if a Z-Piezo device is attached) to activate the usage of the **Z-Piezo** device in the **First/Last** or **Center** modes (Fig. 195). In the SIM imaging mode this is the obligatory mode and hence the checkbox is permanently ticked.

Clicking on the **Leveling** button in the **Focus** tool moves the Z-Piezo stage to its center position in respect to the current focus position of the microscope focus drive. This function is used to set defined initial conditions. The total Range of the Z-Stack is limited depending on the type of Piezo. Hence from the center position the Z-Piezo stage can move half the total range each up and down.

Define the first and last slice using **First/Last** mode by pressing the **Set First** and **Set Last** buttons at the respective focus positions. Adjusting the value for Number of **Slices** or **Interval** is independent from each other and affects the Range of the stack. The Focus Position is not changed.

When changes are made to **Interval** or Number of **Slices** in **First/Last** mode, the values are taken over for the **Piezo** mode provided they are within the Z-Piezo stage focus work range. This also works in the opposite direction.

The direction for acquiring the Z-Stack using the **Z-Piezo** can be set by pressing the double-arrow button (bidirectional scan) or single-arrow button (unidirectional scan). This function is only available in the SIM, TIRF and LSM imaging modes. For bidirectional scan data acquisition is done also when the focus is moving backwards to the initial start position of the stack. This only applies, however, if multiple stacks are acquired in a time series. In unidirectional mode no data acquisition takes place during backwards movement to the initial position of the stack in this case. If only one stack is acquired the direction settings have no effect and data recording will always be unidirectional. A **Corr Z** input box is available (only in **SIM**, **TIRF** and **LSM imaging** modes) to correct for possible shifts of the stacks in Z using bidirectional mode.




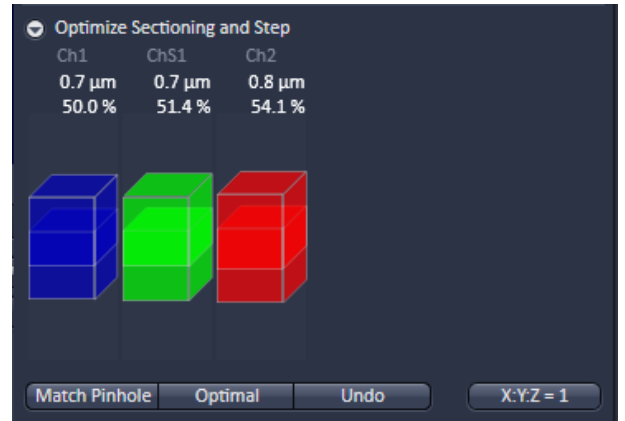
### 5.2.15.4 Optimize Sectioning and Step

Expand the **Optimize Sectioning and Step** field by pressing the triangle (Fig. 196). The **Optimize Sectioning and Step** function helps to set the optimal **Interval**. It is in this respect redundant to the **Optimal** button of the **First/Last** and **Center** modes. If more than one channel is used, the channel detecting the shortest spectral range determines the optimal interval.

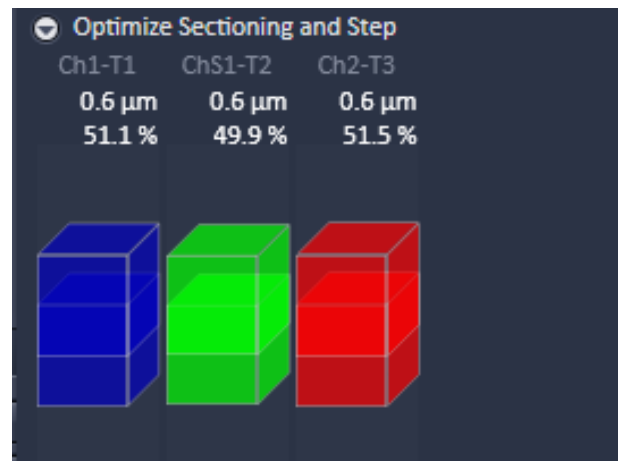
The percentage of overlap of subsequent image slices is indicated for each channel and each track. A 50% overlap is considered to be optimal representing a 2fold Nyquist setting.

The function **Match Pinhole** (Fig. 197) sets the pinhole to keep this optimal interval and in addition have the slice thickness for all detection channels approximately the same. This typically results in slightly thicker slices for channels detecting the longer wavelength range. In case the channels are assigned to different tracks and a Frame wise Multitracking scheme is applied, the pinhole diameter is set for each track such that the values of the resulting optical sections from the different channels are identical and have double the value of the optimal interval.

 Note that the settings of the pinhole might not result in matching optical sections. This is then due to the chosen objective (very low NA) which would require a smaller setting of the pinhole that is mechanically not possible. In this case chose a higher magnifying objective or start with a larger pinhole setting for the channel detecting the shortest wavelength range.



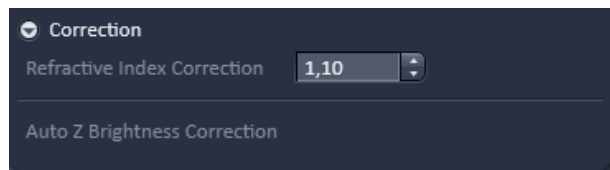
**Fig. 196 Optimize sectioning and Step – appearance for the LSM imaging mode**



**Fig. 197 Optimize sectioning and Step – appearance for the LSM imaging mode pinholes matched to generate equal slice thickness**

Pressing the **Undo** button (only available in the SIM and LSM imaging modes) resets to the previous value.

Pressing the **X:Y:Z = 1** button matches the settings in Z to the settings in X and Y. This produces a cubical voxel.



**Fig. 198** Correction field – appearance for the WF, SIM and Laser WF imaging modes



**Fig. 199** Auto Z Brightness Correction

### 5.2.15.5 Correction

Expand the **Correction** field by pressing the triangle (Fig. 198). The **Refractive Index Correction input box** allows you to consider the different refractive indices between the immersion medium of the objective ( $n'$ ) and the embedding medium of the specimen ( $n$ ), which can be set between 0.5 and 3 by typing or using the arrow keys. The number should correspond to the ratio  $r=n/n'$ .

**Auto Z Brightness Correction** (Fig. 199) allows setting of different values for the scan parameters **Gain (Master)**, **Digital Offset**, **Digital Gain** and **Laser Attenuation** of up to 10 freely selectable slices within a Z-Stack. During the scan procedure, the values of these parameters are automatically linearly interpolated between the neighboring positions within the Z-Stack unless **Spline interpolation** is selected. This function can be activated and deactivated with the check box **Use Correction**.

**Add** takes the above mentioned parameters and correlates them with the current Focus Position which is then added as a **Position** in the list (for example the first slice of a stack).

Adding a new position with a defined set of channel parameters cannot be done while scanning. The positions don't need to be listed in a specific order, the program will sort the values automatically in the background.

**Move to** moves the actual focus to the highlighted **Position** in the list without scanning. Starting a **Continuous** scan then allows setting or correcting the parameters and storing them again hitting **Add**. Highlighted positions can be removed (**Remove**) or the whole list can be deleted (**Remove all**).

The interpolation between the **Positions** in the list can be extrapolated (check the box next to **Extrapolate**) to the actual first and last slice of a Z-Stack if those are not part of the range of the **Positions** in the list.

When **Enable Test** is active, the settings of the **Position** list or the interpolated values calculated for the respective focus position are applied while scanning at single positions of the stack or while focusing through the stack using the **Focus** tool or the focus drive of the microscope. This allows controlling the settings before starting the actual acquisition of the stack.

A position list can be saved and loaded again for further experiments. Use the **Save...** and **Load...** button accordingly. Make sure the Z reference position of the list matches the reference position of the actual Z stack. It is highly recommended to set the Z focus to zero (ideally at the first or last slice of the stack) when defining the stack and the correction positions within the Z stack. For a subsequent experiment the position zero then has to be defined at the position of the first or last slice respectively. Then the correction parameters will be applied in the desired way. Setting the focus position to zero does not change the position values of the list!

### 5.2.15.6 Z-Stack Settings for Airyscan

In case a 3-dimensional acquisition is required, a Z-Stack (Fig. 200) can be defined the same way as when using the internal channels.

However, in order to realize the resolution increase of the **SR** mode in Z, a doubled sampling with smaller Z intervals is required.

This is done automatically when the **SR** mode is active.

#### Optimize Sectioning and Step, Optimal

In case the interval is defined manually, the optimizing sectioning and step dialogue shows the correct sectioning for the Z direction, and the required oversampling for the active **Airyscan** mode can be set by using the **Optimal** button (Fig. 201).

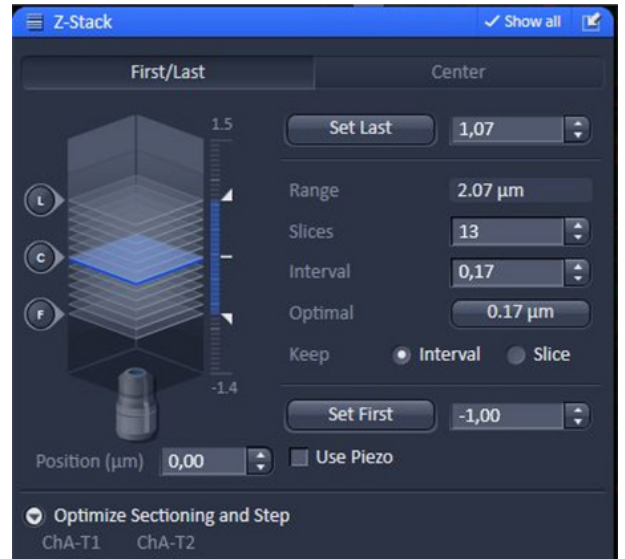


Fig. 200 Z-Stack tool: Airyscan settings

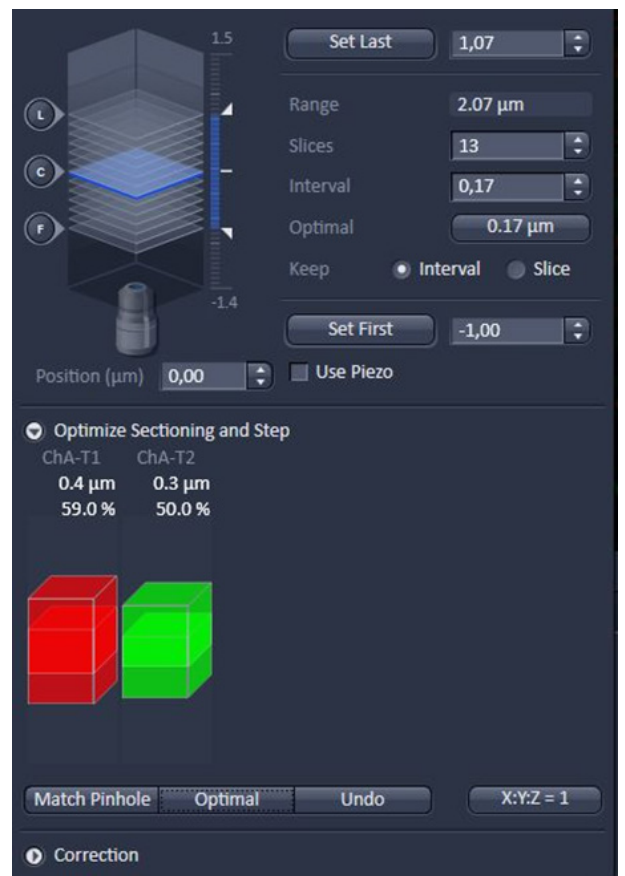


Fig. 201 Optimize sectioning and Step – appearance for Airyscan mode

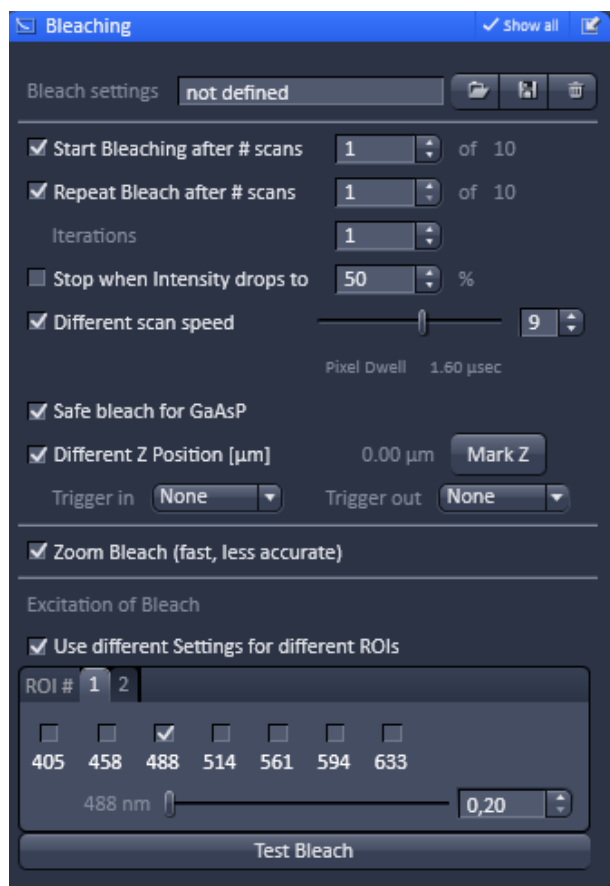


Fig. 202 Bleaching tool

### 5.2.16 Multidimensional Acquisition – Bleaching

When the **Bleaching** tool tab is expanded the **Bleaching** tool becomes available (Fig. 202).

The **Bleaching** tool is only available in LSM Imaging mode.

The use of this function permits setting the bleach parameters using the LSM 710 and LSM 780 systems for bleaching in spot, line or frame mode.

The **Bleach Settings** can be saved under a name and reloaded for later use. Existing settings can also be deleted from the list.

Bleaching works in conjunction with the acquisition of a series of images over time. During the sequential imaging of frames, lines or a spot, bleaching of the specimen can be performed according to the bleach settings defined in the **Bleaching** tool.

**Start Bleaching after # scans** expects a number, which indicates the amount of scanned frames, lines, or spots after which then the bleaching of the sample happens.

**Repeat Bleach after # scans** expects a number, which indicates the amount of scanned frames, lines, or spots after which then the bleaching of the sample is repeated.

The repeated bleaching also allows bleaching the sample to an intensity value calculated as % of the initial intensity within the region to bleach. To achieve this indicate the percentage value in the box next to: **Stop when Intensity drops to**.

The number of **Iterations** indicates the total amount of scans which are performed for bleaching the selected region (see also section during each bleach process).

A **Different scan Speed** for the bleaching process can be set independently from the scan speed which is used for imaging. A lower speed results in a longer pixel dwell time, which increases the efficiency of bleaching.

**Different Z Position:** If this option is active you can set the current stage position as the one in which the bleaching will be done by clicking **Mark Z**. This function is only available using the **Line** or **Frame** scanning mode.

When the imaging is performed in **Spot Mode** (chosen as acquisition mode in the **Acquisition Mode** tool), a **Different XY Spot Bleach Position** can be selected. Click **Spot Select** in the **Acquisition Mode** tool. A new image appears with a green **crosshair**. When clicking and dragging the crosshair a red crosshair becomes visible. The red crosshair marks the spot that is imaged (This is also indicated in the **Scan Area** of the **Acquisition Mode** tool. The green crosshair marks the spot that is bleached. Move the center of the crosshairs to the desired positions.

Use one out of four triggers with **Trigger In** to trigger the bleaching process. In addition, one out of four triggers can be used as **Trigger Out** signal to control an external device. (For a detailed description on the trigger use and interface see printed manual CHAPTER 4: ANNEX).

If a region is used to define a position for bleaching within the sample, the bleach process can be accelerated by checking the box next to **Zoom Bleach (fast, less accurate)**. In this case the scanner movement will be restricted to the bleach region zooming in onto this region. This may result in a less accurate positioning of the region as the definition of the region has been made in a different zoom in the image. The bleach process will be faster than without this option. The gain in speed is dependent on the speed that is used for bleaching. If a high speed has already been chosen for bleaching the gain in speed will be minimal.

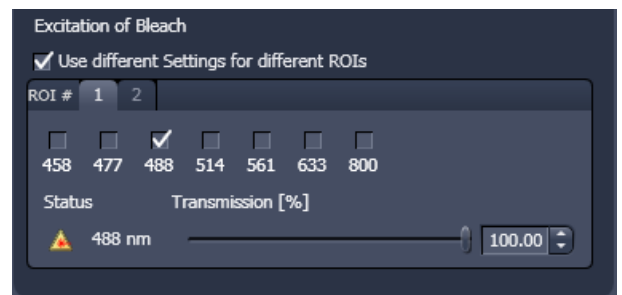
Define the region(s) for bleaching in the **Regions** tool (see section **Acquisition Parameter – Regions**). Only a region activated under Bleach is considered for bleaching. In the **Excitation of Bleach** area (Fig. 202) choose the laser line and laser intensity which is then used for bleaching.

It is possible to choose different laser lines and/or laser intensities for the bleach process of each region when activating the option: **Use different Settings for different ROIs**. A maximum number of six regions is possible. The numbers of the regions correspond to the numbers indicated next to **ROI#**. For each region, a tab is active which allows setting individual laser parameters for bleaching.

Define the region(s) for bleaching in the **Regions** tool. Only a region activated under Bleach is considered for bleaching. In the **Excitation of Bleach** area (Fig. 203) chose the laser line and laser intensity which is then used for bleaching.

It is possible to choose different laser lines and/or laser intensities for the bleach process of each region when activating the option: **Use different Settings for different ROIs**. The numbers of the regions correspond to the numbers indicated next to **ROI#**. For each region, a tab is active which allows setting individual laser parameters for bleaching.

The **Regions** tool is only available in the LSM imaging mode.



**Fig. 203** Excitation of Bleach area for setting laser line and intensity for bleaching

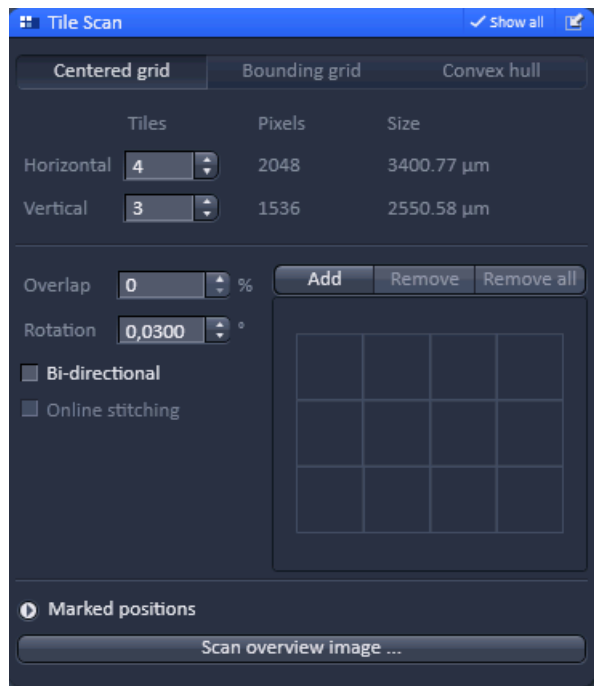


Fig. 204 Tile Scan tool – Centered grid active

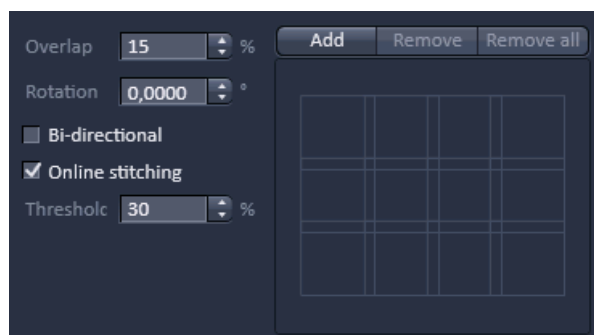


Fig. 205 Tile Scan tool – Overlap defined

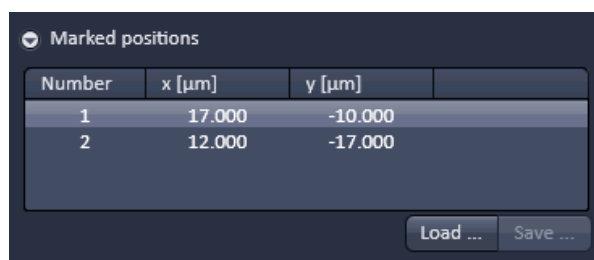


Fig. 206 Tile Scan tool – Marked positions

If the system is equipped with the software option TILES, the **Overlap** input box is available (Fig. 205). Define the overlap of the tiles as the **%** of the tile size. The extent of overlap will also be displayed in the **grid display** area. As soon as the Overlap is > 0 % the **Online stitching** checkbox becomes available. Online stitching cannot be activated if the HDR imaging is selected in the **Acquisition Mode** tool.

### 5.2.17 Multidimensional Acquisition – Tile Scan

When the **Tile Scan** tool tab is expanded the **Tile Scan** tool becomes available (Fig. 204).

This function permits a frame to be created as an overview image of the specimen. The size of the final tiled image depends on the settings for the image format set in the **Acquisition Mode** tool and the number of tiles.

The application of the **Tile Scan** function requires an objective with a minimum magnification factor of 2.5x.

The number of **Tiles** can be defined in the **Tiles Horizontal** and **Vertical** Input boxes. A maximum of 100 tiles can be set. The size of the final Tile Scan is displayed in **Pixels** and as a **Size** in µm. According to image format the number of **Pixels** changes. According to the objective used for imaging the **Size** of the Tile Scan changes.

The Tile Scan grid is displayed in the **grid display** area. It shows the number and location of the single tiles and also indicates any overlap.

The Tile scan is created around the absolute starting position of the stage. In case the stage does not move exactly horizontal to the scan field a **Rotation** value can be set in the **Rotation** input box to correct for this (available only in **Show all** mode). This can either be calibrated beforehand using a grid slide or any other specimen which displays clearly visible structures in horizontal direction.

Acquire smaller tile scans to see the effect of a specific value for **Rotation** until you find the right one. This value should be taken for the **Rotation**. Alternatively, use the **Tile Scan Rotation Macro** which provides an automatic **Rotation** calibration function. Take over this value to the main software before acquiring the tile scan.

When **Bi-directional** is active (available only in **Show all** mode) the image acquisition is performed also on the horizontal backwards movement of the stage.

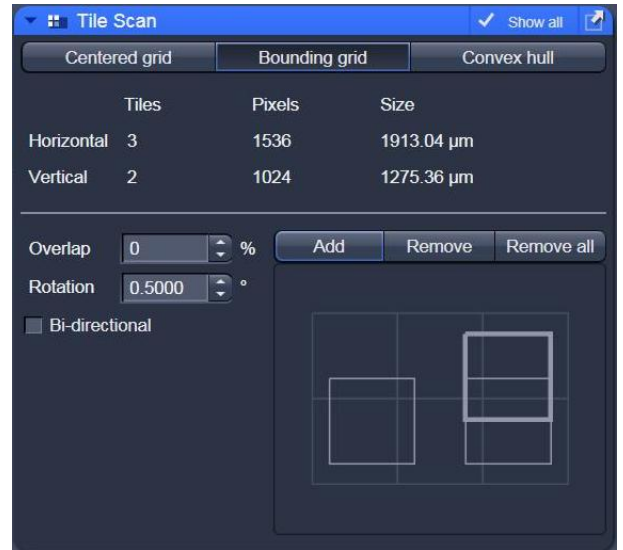
Tick the checkbox to activate online stitching. After ticking the checkbox the **Threshold** input box becomes available. Enter the desired threshold in %.

By pressing **Add** you can mark stage positions, which will be listed in the **Marked position** field in terms of Number as well as **x [µm]** and **y [µm]** coordinates (Fig. 206). By Pressing **Remove** the highlighted position will be removed from the list. Pressing **Remove all** will delete all positions. You can save a position list by Pressing the **Save...** button in the **Mark position** field via the Windows Explorer. You can load saved position list by pressing the **Load...** button via selection in Windows explorer.

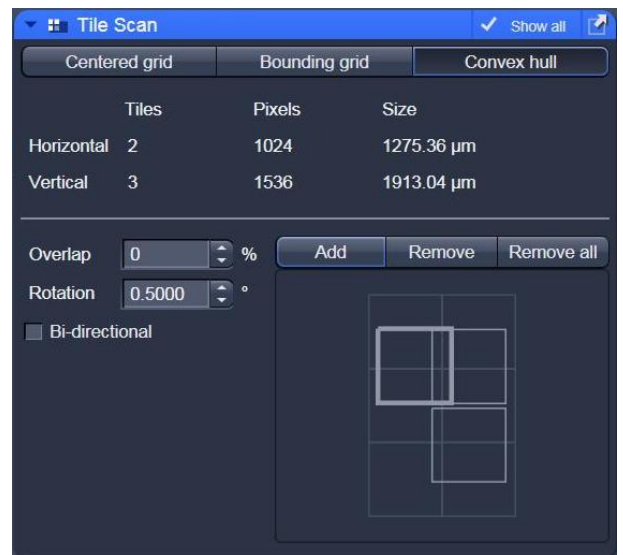
If **Centered grid** is selected, the current position will be the center of the Tile Scan.

If **Bounding grid** is selected positions that should be part of the tile scan have to be marked using **Add**. To this end click on the edge of the square to select the position, which will then be displayed with a thicker line width, and then press **Add**. Using these positions a bounding grid is created, which finally defines the dimensions of the tile scan (Fig. 207).

If **Convex hull** is selected positions that should be part of the tile scan have to be marked using **Add**. To this end click on the edge of the square to select the position, which will then be displayed with a thicker line width, and then press **Add**. Using these positions a convex hull is created, which finally defines the dimensions of the tile scan (Fig. 208).



**Fig. 207** Tile Scan tool – Bounding grid selected; two positions defined



**Fig. 208** Tile Scan tool– Convex hull selected

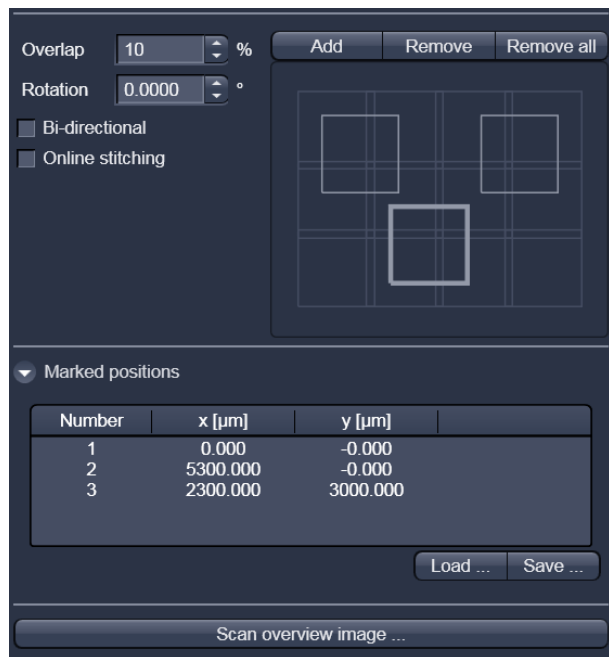


Fig. 209 Tile Scan: Marked positions

**Marked positions** are listed up. This list can be saved and loaded.

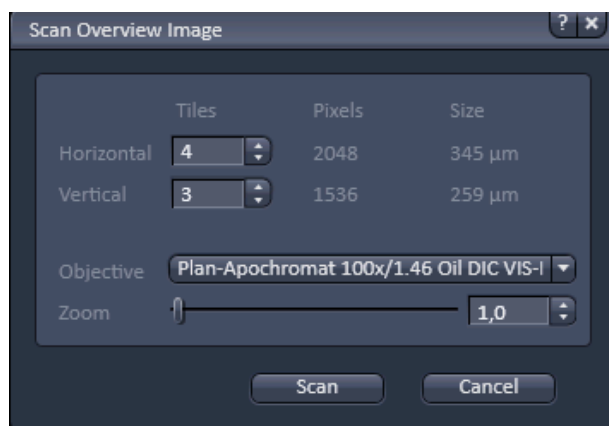


Fig. 210 Scan Overview Image window

### 5.2.18 Scan Overview Image for Tiling

Pressing the **Scan overview Image...** button opens the Scan overview Image interactive window (Fig. 210). Here you can define the number of **Tiles** by using the **Horizontal** and **Vertical** Input boxes (the extension of the scanned area will be displayed in **Pixel** and **Size (µm)** units), the objective from the **Objective** drop down menu and a potential zoom factor via the **Zoom** slider or Zoom input box with which to scan an overview image. In the LSM imaging mode, a true zoom is taken. For widefield modes, only the zoomed in part of the camera chip will be displayed. Changing **Objective** and **Zoom** will change the size, but leaves **Pixels** unchanged. This overview image can then be used to navigate in the sample (i.e. define positions for imaging). **Scan** starts the tile scan. **Cancel** closes the window without further action.



### 5.2.19 Multidimensional Acquisition – Time Series

When the **Time Series** tool tab is expanded the **Time Series** tool becomes available (Fig. 211). In the **Time Series** tool the parameters for the sequential acquisition of image frames (and lines for the **LSM image mode**) as time series are defined. Imaging in spot mode is only possible in combination with the settings of a time series acquisition in the **LSM imaging** mode. The options in this mode within the **Time Series** tool are limited and explained below.

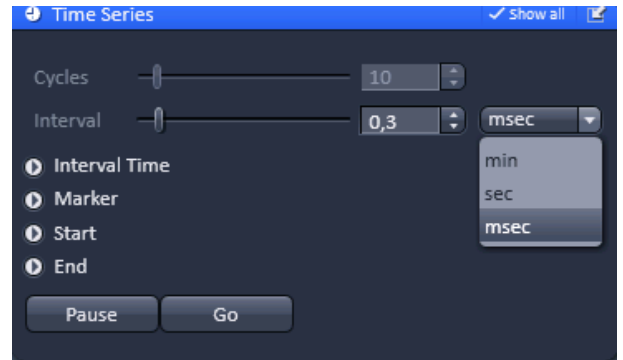


Fig. 211 Time Series tool

To set up a simple time series acquisition it is enough to define the number of **Cycles**, which corresponds to the number of frames (or lines), imaged. This number can be defined with the **Cycles** slider or the **Cycles** input box. A maximum value of 100,000 can be set. The amount of data that can be handled by the system is limited. If the maximum amount is exceeded a warning will appear. In this case, it is necessary to either change the destination for data storage and/or reduce the amount of cycles. The limit also depends on the imaging setup and the acquisition mode. Note that it is an upper limit of handling data files, but this is beyond the value of 100 Gigabits.

**Interval** defines a potential time interval, set in milliseconds (ms), seconds (sec) or minutes (min) by the **Interval** drop down menu, to separate the beginning of two cycles. A time shorter than the scan time for a frame (or line) is not effective. The interval time can be changed by using the **Interval** slider or **Interval** input box, also while scanning.

There are different advanced tools (only available in Show all mode) including

- Interval Time
- Marker
- Start
- End

#### 5.2.19.1 Interval Time

Expand the Interval field by clicking the triangle (Fig. 212). An **Interval Time** is a potential time interval between the end of one cycle and the beginning of the next cycle. The time and time unit for the delay time is set using the slider or input box of **Interval Time**. A cycle interval time is not effective if a cycle delay time is defined, since the interval time is always included in the delay. A total of six different delay times can be defined by adding further lines clicking on the + button.

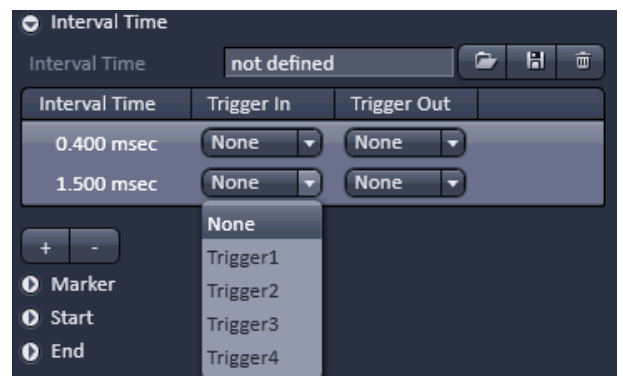
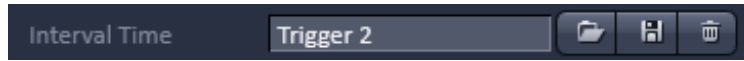


Fig. 212 Time Series tool – Interval Time

Clicking the - button deletes the currently highlighted delay time. Each delay time can be controlled using the **Trigger In** function.

(For a detailed description on the trigger use and interface see printed manual CHAPTER 4: ANNEX).

The trigger can be selected from the **Trigger In** pull down menu. Up to 4 triggers are available. The trigger has to be assigned in the firmware of the system. If no trigger is set the highlighted delay time will be effective for the time series acquisition. Additionally it is possible to send a trigger signal out using the **Trigger Out** pull down menu at the start of each delay time. Up to 4 Triggers are available. The trigger output port has to be assigned via the firmware of the system.

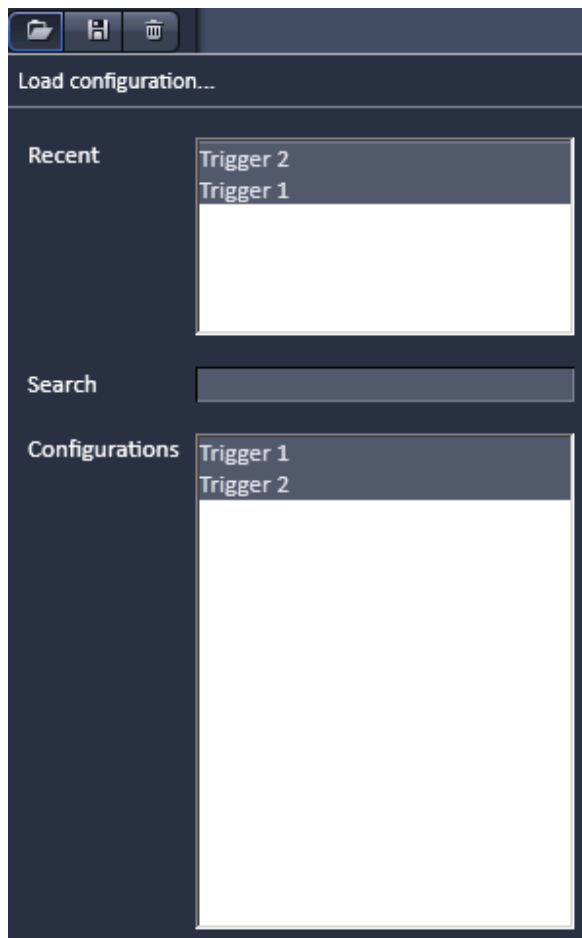


**Fig. 213** Interval Time

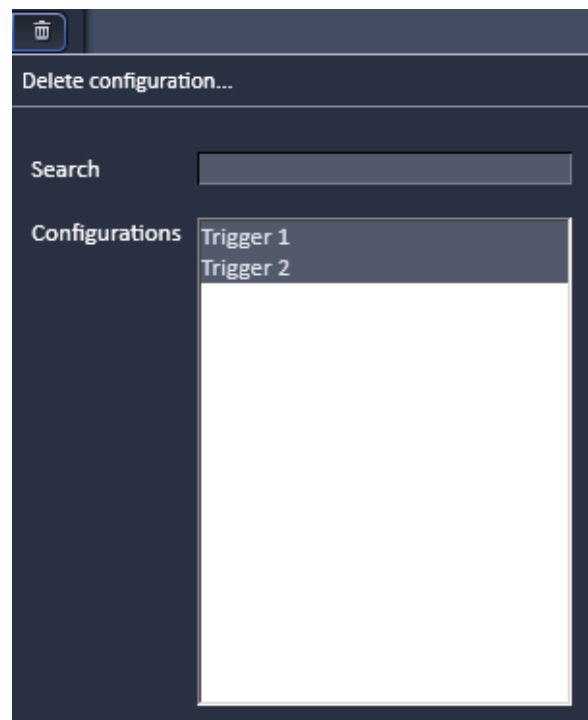
You can load a predefined timer configuration from the **Interval Time** field by pressing the **Load** button (symbolized by the **folder** icon) (Fig. 213). All saved timer will be listed in the **Load configuration...** panel (Fig. 214). Select the appropriate one by highlighting it in the **Recent** section, which lists the recently used timer configurations or from the **Configurations** section, where all saved timer configurations are displayed. To search for a timer configuration, type in its name or part of its name in the **Search** field and only those timer configurations will be listed that contain the typed in string of letters.

To delete a timer configuration press the **Delete** button (symbolized by the **dust bin** icon).

This opens the **Delete configuration...** window (Fig. 215).



**Fig. 214** Load configuration... panel



**Fig. 215** Delete configuration... panel

Select the timer configuration from the **Configurations** list by highlighting it or search for it by typing its name in the **Search** field. The **Info** window pops up (Fig. 216).

Press **Yes** to delete the configuration, **No** to keep the configuration.

To save a configuration press the **Save** button (symbolized by the **disc** icon). This opens the **Save current timer configuration as** panel (Fig. 217).

Type in an appropriate name in the **Configuration** field and press **Ok** to save the configuration in the data base or press **Cancel** to abort the process.

The delay time can be changed while scanning.

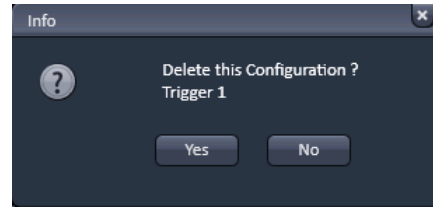


Fig. 216 Delete information window

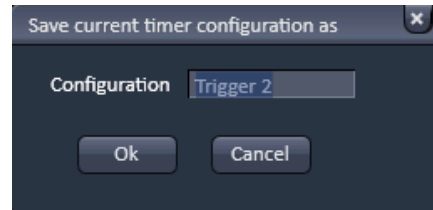


Fig. 217 Save current timer configuration as window

### 5.2.19.2 Marker

Expand the **Marker** field by clicking the triangle (Fig. 218). The **Marker** functionality provides the possibility to indicate the start or end of an external process in the data of the image series by connecting this external process to the selected **Trigger In** for that Marker. Up to 4 different triggers can be selected from the Trigger In pull down menu. You can edit a description of that marker in the **Description** box of the Marker, which will be visible in the image data using the Mean ROI functionality or the image gallery display mode. A **Trigger Out** signal can be set with each defined marker. Up to 4 different triggers can be selected from the pull down menu. By clicking **Set** a marker is set manually at any time during scanning. A maximum of seven different markers can be defined using the **+** button. The **-** button deletes the currently highlighted marker.

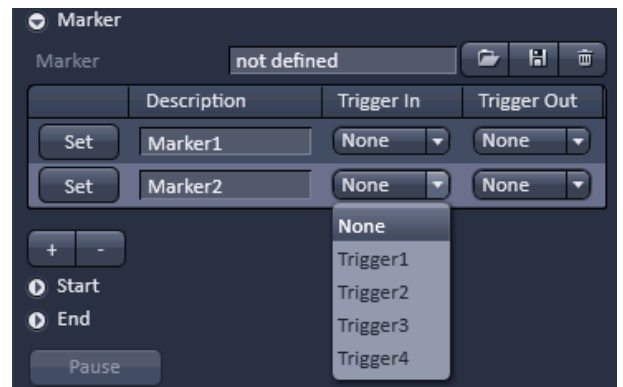


Fig. 218 Time Series tool – Marker

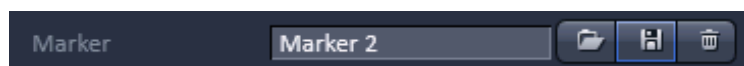


Fig. 219 Marker

You can load a predefined timer configuration from the **Marker** field by pressing the **Load** button (symbolized by the **folder** icon) (Fig. 219).

All saved marker configurations will be listed in the **Load configuration...** panel (Fig. 220).

Select the appropriate one by highlighting it in the **Recent** section, which lists the recently used marker configurations or from the **Configurations** section, where all saved marker configurations are displayed.

To search for a marker configuration, type in its name or part of its name in the **Search** field and only those marker configurations will be listed that contain the typed in string of letters.

To delete a marker configuration press the **Delete** button (symbolized by the **dust bin** icon). This opens the **Delete configuration...** window (Fig. 221).

Select the marker configuration from the **Configurations** list by highlighting it or search for it by typing its name in the **Search** field.

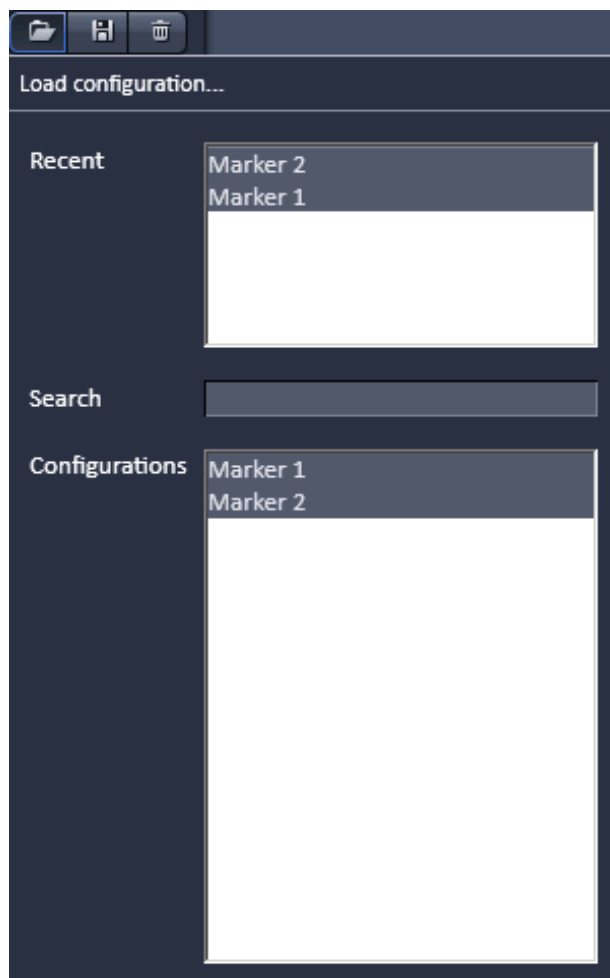


Fig. 220 Load configuration... panel

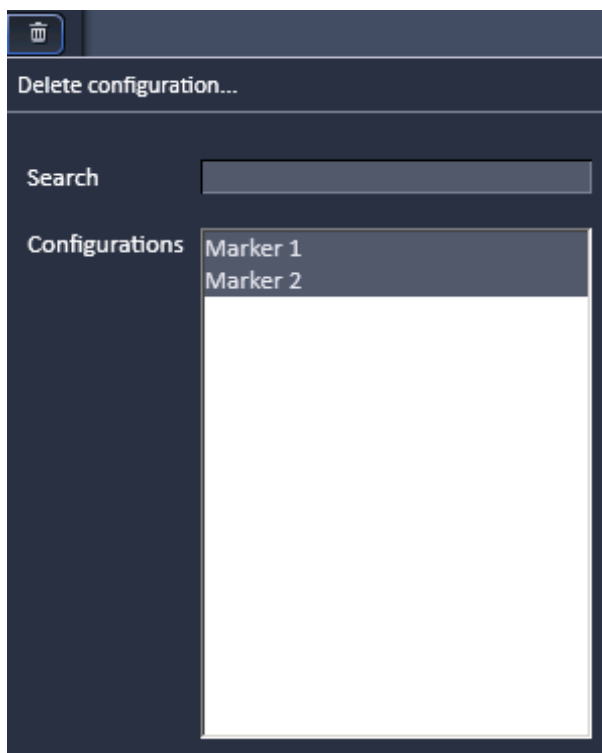


Fig. 221 Delete configuration... panel

The **Info** window pops up (Fig. 222).

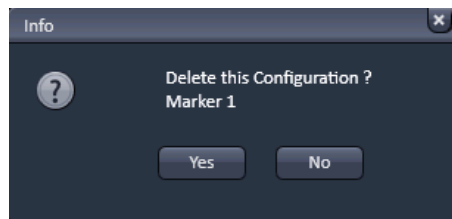
Press **Yes** to delete the configuration, **No** to keep the configuration.

To save a marker configuration press the **Save** button (symbolized by the **disc** icon).

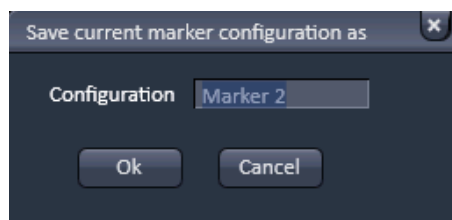
This opens the **Save current marker configuration as** panel (Fig. 223).

Type in an appropriate name in the **Configuration** field and press **Ok** to save the configuration in the data base or press **Cancel** to abort the process.

When the image series is stored, all the markers, including the time indication and the comments, are stored along with the image contents.



**Fig. 222** Delete information window



**Fig. 223** Save current marker configuration as window

The markers visible in the image series have different colors with the following meaning:

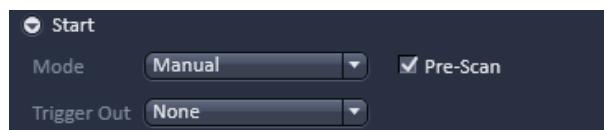
- **red:** manually set marker with time indication and comments
- **blue:** automatically set marker with change of delay
- **green:** automatically set marker at the beginning and at the end of a bleaching procedure

### 5.2.19.3 Start

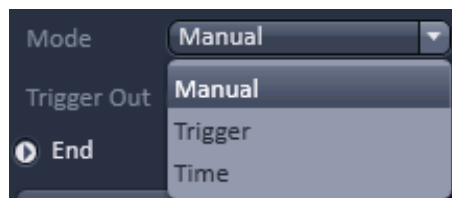
Expand the **Start** field by clicking the triangle (Fig. 224).

In the **Mode** drop down menu (Fig. 225) you can select the way the acquisition is triggered. You have the choice between Manual, Trigger and Time.

If **Manual** is selected the acquisition of a time series is started using the **Start Experiment** action button.



**Fig. 224** Start field



**Fig. 225** Start Mode drop down menu



Fig. 226 Start Mode drop down menu– Trigger selected

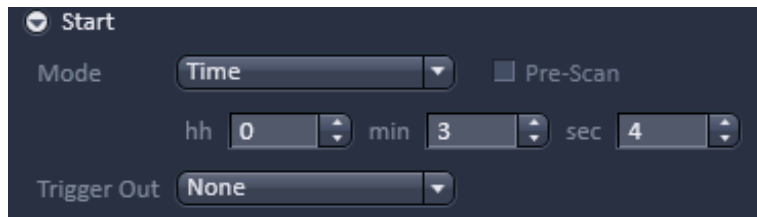


Fig. 227 Start Mode drop down menu – Time selected

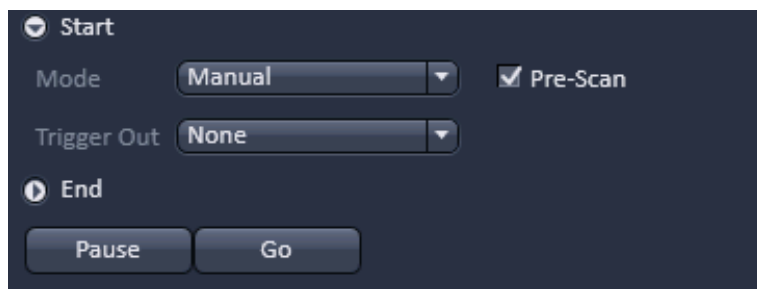


Fig. 228 Start – time series in process

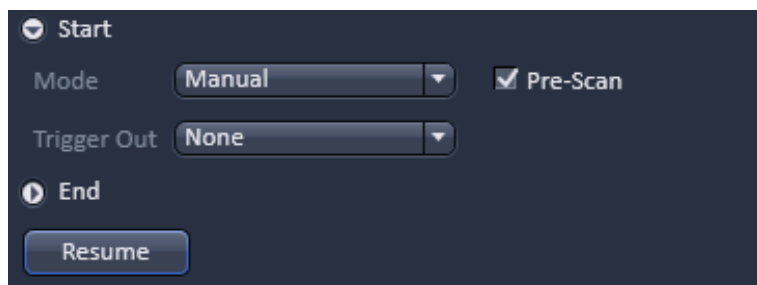


Fig. 229 Start – time series interrupted

If **Trigger** is selected the **Trigger In** drop down menu becomes available (Fig. 226) from which up to 4 triggers can be selected. After pressing **Start Experiment** button the system will display the message **Waiting for Trigger** and starts acquisition once it received the trigger in signal.

If **Time** is selected the **hh**, **min** and **sec** input boxes become available (Fig. 227), in which the hours, minutes and seconds can be edited. After pressing **Start Experiment** button the system will display the message **Waiting for Start Time** and starts acquisition after the defined computer time has been elapsed.

If the **Pre-Scan** checkbox is ticked (Fig. 228) a continuous scan is performed when clicking **Start Experiment** button, but no image series is acquired until you hit the **Go** button, which becomes visible next to the **Pause** button in the lower part of the control window. Once the **Go** button was pressed it will disappear.

When Pressing the **Pause** button, which becomes active after **Start Experiment** was pressed, the time series is interrupted and the current scan is finished. The labeling of the button changes to **Resume** (Fig. 229) and if the **Resume** button is pressed the time series is immediately continued.

It is possible to send a **Trigger Out** signal with the start of the times series. The **Trigger Out** drop down menu allows defining up to 4 trigger out signals.

### 5.2.19.4 End

Expand the **End** field by clicking the triangle (Fig. 230).


In the **Mode** drop down menu (Fig. 231) you can select the way the acquisition is triggered. You have the choice between Manual, Trigger and Time.

If **Manual** is selected the acquisition of a time series ends using the **Stop button** or after the defined number of cycles.


If **Trigger** is selected the **Trigger In** drop down menu becomes available (Fig. 232) from which up to 4 triggers can be selected. The system will interrupt the acquisition once the trigger in signal is received.


If **Time** is selected the **hh**, **min** and **sec** input boxes become available (Fig. 233), in which the hours, minutes and seconds can be edited. The system interrupts the acquisition after the defined computer time has been elapsed.


It is possible to send a **Trigger Out** signal with the end of the times series. The **Trigger Out** drop down menu allows defining up to 4 trigger out signals.

 If the entered number of cycles is processed without a set trigger impulse been given to end the procedure, the Time Series is finished.

If a trigger signal to end the scan arrives before the cycles have been processed, the Time Series will only be interrupted. **Waiting for Trigger** will be displayed in the status line. The Time Series can now be continued via a new trigger signal or ended via **Stop**.

 A Time Series is finished when the end **Time** is reached. If the entered number of **Cycles** has been processed, the Time Series is finished before the end Time. If the number of cycles has not yet been processed until the end Time, the Time Series is also finished. The end time for the Time Series can be changed online. Bleach times will be added to the total time for image acquisition.

 If a time series is interrupted before its programmed end, the programmed number of images will be taken over in the database. However, only those images are stored which were created before interruption of the time series. This is due to the fact that the original image parameters are to be taken over via the **Reuse** function.

 It is possible to stop and restart a time series via TriggerIN and have the data concatenated in one file by alternating between the Start and End function. For example starting the time series with TriggerIN 1 and stopping it via TriggerIN 2. Alternating between the two trigger inputs in essence pauses the time series for a desired time.

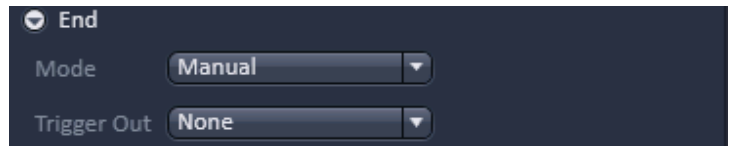


Fig. 230 End field

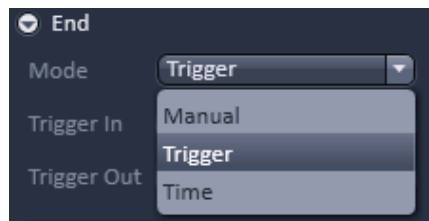


Fig. 231 End Mode drop down menu

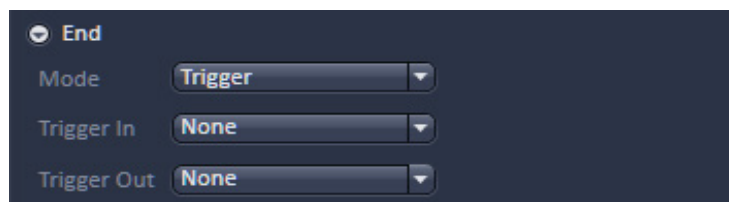


Fig. 232 End Mode drop down menu – Trigger selected

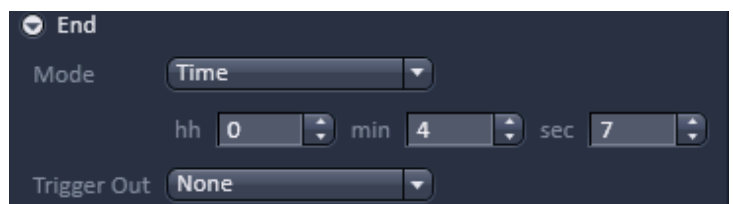


Fig. 233 End Mode drop down menu – Time selected

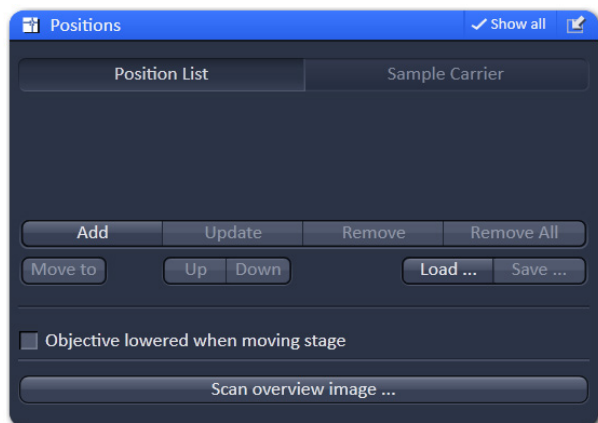


Fig. 234 Positions tool



Fig. 235 Positions List control panel

## 5.2.20 Multidimensional Acquisition – Positions

When the **Positions** tool tab is expanded the **Positions** tool becomes available (Fig. 234).

This function comprises two main applications.

First, it is used to take images of a specimen at freely defined positions (**Positions List mode**).

Second, it is used to image specimens, typically cells, which are grown in sample carriers like plates with a set number of wells (**Sample Carrier mode**).

### 5.2.20.1 Position List

Press the **Position List** button to obtain the **Position List** control panel (Fig. 235)

Clicking the **Add** button adds the current position and its coordinates to the list of positions. Displayed are the number of the positions, their **x (µm)**, **y (µm)** and **z (µm)** coordinates and also their **offset** values (µm). See the description of **Setting individual offset values for positions in Position List mode** (below) and also the tool description of **Focus Devices and Strategy** for details on offset values (section **Acquisition Parameter – Focus Devices and Strategy**). Highlighted positions can be removed by pressing the **Remove** button. Alternatively the whole list can be deleted by pressing the **Remove All** button.

It is also possible to move the stage to the highlighted position by clicking the button **Move to**. The order of positions in the list can be modified by pressing the buttons **Up** or **Down**.

You can save and load pre-saved positions by pressing the **Save...** and **Load...** buttons, respectively, which will open Windows Explorer.

The list of positions is consistent with the positions defined in the **Stage** tool.

☞ When the list of positions is deleted in the **Position list**, it is also deleted in the **Stage** tool. This is not the case the other way round.

☞ It is recommended to save the position list as relative positions. The format "Positions list files (relative)" should be selected in the Windows Explorer. This format allows to reuse the positions for other experiments later on. Just make sure that the reference position for the list (for example the position 0) matches with the actual zero position in your sample. Start with positioning the sample at the desired zero position and set the stage to zero before loading the position list.




### 5.2.20.2 Sample Carrier

Press the **Sample Carrier** button to obtain the **Sample Carrier** control panel (Fig. 236).

The last used sample carrier will be displayed in the **Sample Carrier** display area. If no sample carrier is defined, the area remains empty.

You can define the sample carrier by clicking on **Properties** of the **Carrier definition** field.

By using the **Columns** and **Rows Number** input boxes, you can define the numbers of columns and rows of the carrier. In the **Columns** and **Rows Distance (mm)** input boxes, you can define the distance between the single wells of the carrier in horizontal and vertical direction, respectively (Fig. 237).

You can load a predefined carrier configuration from the **Carrier definition** field by pressing the **Load** button (symbolized by the  icon) (Fig. 238).

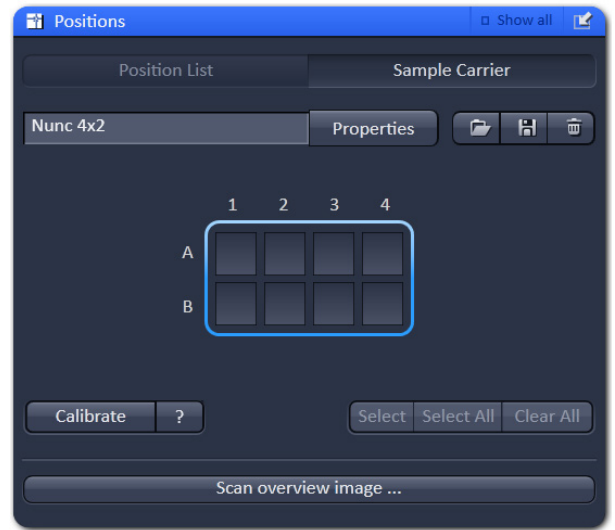


Fig. 236 Sample Carrier control panel



Fig. 237 Properties Pop up window



Fig. 238 Carrier definition field

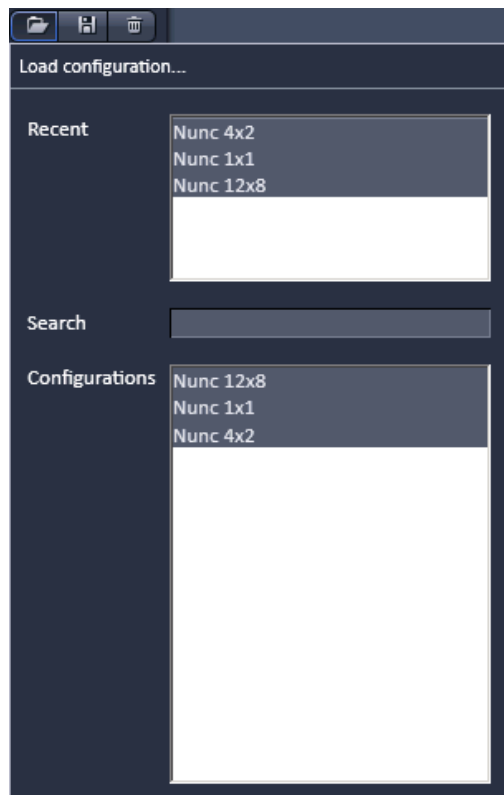


Fig. 239 Load configuration... panel

All saved marker configurations will be listed in the **Load configuration...** panel (Fig. 239).

Select the appropriate one by highlighting it in the **Recent** section, which lists the recently used marker configurations or from the **Configurations** section, where all saved carrier configurations are displayed. To search for a carrier configuration, type in its name or part of its name in the **Search** field and only those carrier configurations will be listed that contain the typed in string of letters. The name of the currently loaded carrier configuration will be shown in the display box.

To delete a carrier configuration press the **Delete** button (symbolized by the **dust bin** icon). This opens the **Delete configuration...** window (Fig. 240).

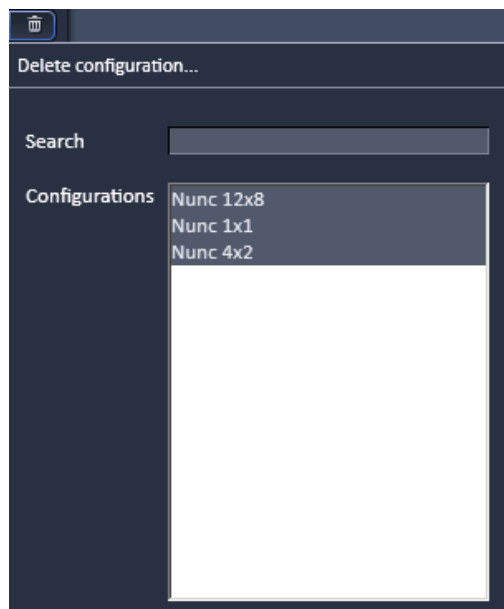


Fig. 240 Delete configuration... panel

Select the carrier configuration from the **Configurations** list by highlighting it or search for it by typing its name in the **Search** field. The **Info** window pops up (Fig. 241).

Press **Yes** to delete the configuration, **No** to keep the configuration. To save a carrier configuration press the **Save** button (symbolized by the **disc** icon).

This opens the **Save current carrier configuration as** panel (Fig. 242). Type in an appropriate name in the **Configuration** field and press **Ok** to save the configuration in the data base or press **Cancel** to abort the process.

To assign the actual position of the stage with a position in the sample carrier, move to the center of a well in the actual plate under the microscope then click **Calibrate** followed by clicking the field in the sample carrier representing this well of the plate. This assignment will be kept until changed repeating this procedure and that well will turn blue.

Pressing the **?** button (Fig. 243) will display a help text how to calibrate the position of the sample carrier.

If you click on any other than the blue highlighted well, the stage will move to this well based on the distances defined in the carrier properties. This will be than the blue highlighted one.

By pressing **Select** you can highlight those wells of the sample carrier that should be sequentially used by just clicking on them (Fig. 244). All selected wells will turn blue. By clicking on a selected blue highlighted well, it will be deselected. By pressing **Select all**, all wells will be selected for imaging. By pressing **Clear all**, all wells will be deselected. As long as **Select** stays pressed, the wells will be sequentially approached starting at the let upper position to the right lower one (A1, A2...;B1, B2,...).

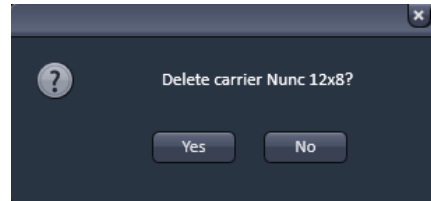


Fig. 241 Delete information window

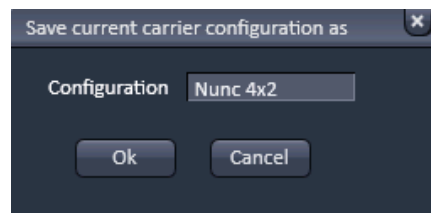


Fig. 242 Save current carrier configuration as window

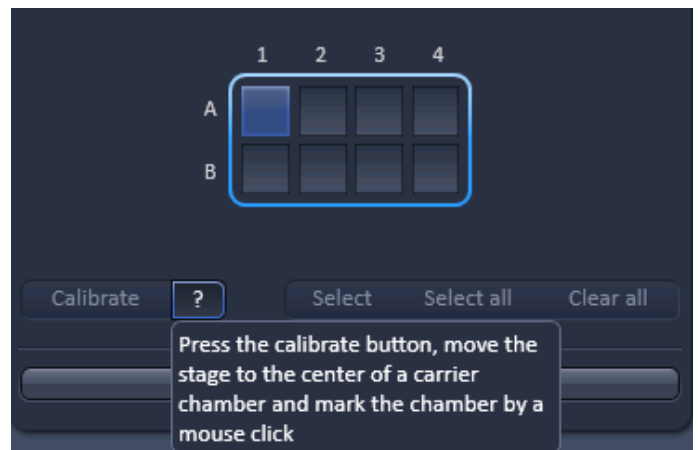


Fig. 243 Calibration of sample carrier

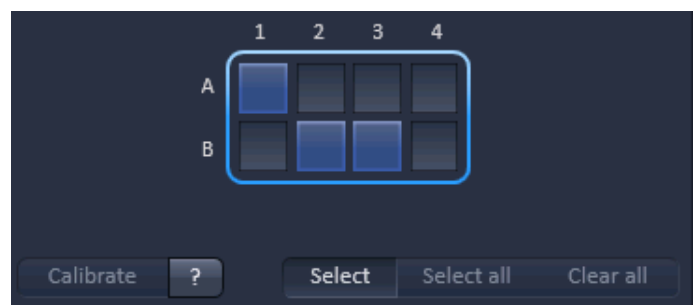


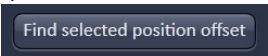
Fig. 244 Selection of wells in a sample carrier

### 5.2.20.3 Setting Individual Offset Values for Positions in Position List Mode

The **Focus Devices and Strategy** tool contains the controls for maintaining focus stability when using the **Positions** tool (e.g. selection of autofocus mode and activity intervals).

If **Show all** is active for the **Positions** tool, it is possible to assign individual offset values to each position when using the **Position List** mode. This feature is exclusively available if the autofocus **Reflection** mode is selected in **Focus Devices and Strategy**.

To modify the **offset value** of individual positions a position is selected by mouse click.

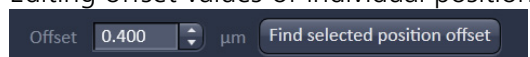
Next, the offset value is either typed into the offset spin box or determined automatically after pressing the  button.

Offset values of individual positions must be modified within the context of the **Positions** tool and not in **Focus Devices and Strategy**.

If individual offset values are specified in position lists, these values are ignored upon switching to an autofocus mode other than **Reflection**.

In the case of the method **Sample Carrier**, ZEN assumes identical offset values across all positions in arrayed samples. Use the tool **Focus Devices and Strategy** to specify the offset value when using this method. See tool description of **Focus Devices and Strategy** for details on autofocus modes and offset values (section **Acquisition Parameter – Focus Devices and Strategy**).

Editing offset values of individual positions is available in Position List for the **Reflection** autofocus mode



### 5.2.20.4 Lowering Objective when Moving the Stage

Some acquisition experiments require the objective lens to be lowered (or raised depending on the microscope) before moving the scanning stage to the next position (e.g. required if certain plate formats are used).

With the tool Positions, this is possible when activating  check box.

This feature is available to **Position List** and **Sample Carrier** if **Show all** is active.

### 5.2.20.5 Scan Overview Image

Pressing the **Scan overview Image...** button opens the **Scan overview Image** interactive window (Fig. 245). Here you can define the number of **Tiles** by using the **Horizontal** and **Vertical** Input boxes (the extension of the scanned area will be displayed in **Pixel** and **Size (µm)** units), the objective from the **Objective** drop down menu and a potential zoom factor via the **Zoom** slider or Zoom input box with which to scan an overview image. In the LSM imaging mode, a true zoom is taken. For widefield modes, only the zoomed in part of the camera chip will be displayed. Changing **Objective** and **Zoom** will change the size, but leaves **Pixels** unchanged. This overview image can then be used to navigate in the sample (i.e. define positions for imaging). **Scan** starts the tile scan. **Cancel** closes the window without further action.

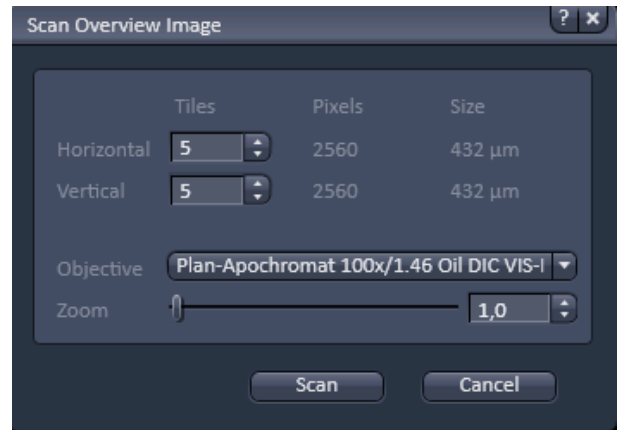


Fig. 245 Scan panel

### 5.2.21 Multidimensional Acquisition – Information on Experiment

The **Information on Experiment** tool (Fig. 246) displays the information of the current experiment in terms of

- Channels / Bit Depth
- Dimension
- Required Disk Space
- Duration for 1 frame

Any changes in the settings will be automatically updated in regard to the displayed parameters.



Fig. 246 Information on Experiment tool

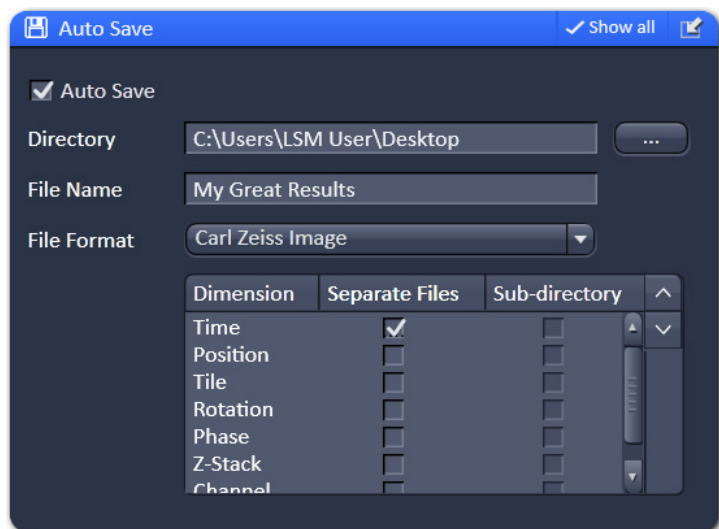


Fig. 247 Auto save tool

The selected directory will be displayed in the **Directory** display field. The name of the file has to be typed into the **File Name** display box. The image series will then be saved with this file name (or name of the sub-directory) extended by the exact date and time of the image acquisition.

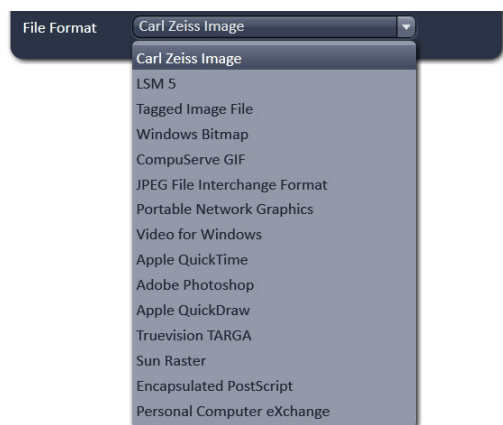



Fig. 248 File format drop down menu

The file format can be selected from the **File Format** drop down menu (Fig. 248). The scroll bar can be used to have access to all listed file formats.

In the **Dimension selection** field you can define how the image series is saved. For each dimension you can define by ticking the respective **Separate Files** checkbox to save this dimension in separate files. The file names of the single files will have extensions of a letter indicating the dimension (t for time series, z for Z-Stack, p for position etc.) preceding a number that indicates the frame number of the series. If none is checked, the whole image series will be saved in one file. If the **Sub-directory** checkbox is ticked in addition, all separate images of the specified dimension will be saved in a newly created sub-directory having the same name as the file. This option is not available for the Carl Zeiss Image (CZI) file format. If the Separate Files checkbox is not ticked, ticking the respective Sub-directory checkbox is of no consequence.

The activation of **Auto Save** is indicated as a disc icon in the graphical scheme of the experiment next to the main tool group.

 Autosave does not save those image data which are acquired and processed with HDR function. Only the non processed data are stored.

## 5.2.22 Multidimensional Acquisition – Auto Save


If the **Auto Save** tool tab is expanded the **Auto Save** tool becomes available (Fig. 247). Images that are acquired by clicking the Start Experiment can be automatically written to the hard disc, so that when image acquisition is disrupted, the data up to the disruption point will be available.

If data should be automatically saved, the **Auto Save** check box has to be ticked. A directory, to which the file will be saved, has to be specified in the **Directory** field. You can specify the directory by clicking the ... button in the Windows Explorer.

### 5.2.23 Image Optimization

This section describes an example how to acquire an image, using an excitation wavelength of 561 nm and a fluorescence emission range above 570 nm. Use the MBS 488/561 as the main dichroic beam splitter. We presume that no predefined configuration is available for this imaging task.

The description applies to the use of any microscope.

 Data acquisitions is impaired when keeping the computer busy with other tasks then acquisition like processing data or using other software in the mean time. This might slow down image acquisition and can even interfere with the timing of the acquisition.

#### 5.2.23.1 Requirements

- Position the specimen under the objective and focus onto the desired imaging plane.
- Activate **Show all Tools** and open the **Imaging Setup** tool. Chose **Channel** mode for the image acquisition (Fig. 249).
- Switch on the Laser 561 nm.
- Click on the laser icon, select the 561 line, and set the transmission slider to about 3 % (this laser has an output power of 10 mW, other lasers have up to 100 mW depending on the type of laser and the imaging device used; be careful when setting the power for imaging with other lasers for imaging other dyes). Make sure other lasers are not checked (Fig. 250).
- Optimize the laser intensity subsequently via the slider when imaging.
- Activate channel 1 (Ch1) via the check box (Fig. 249).

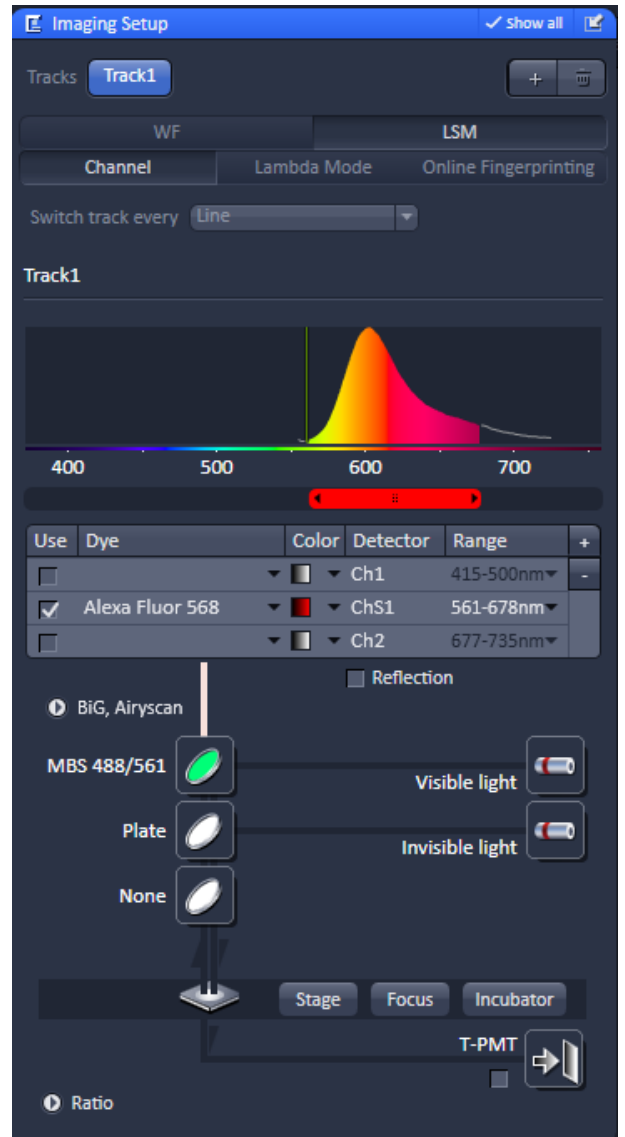


Fig. 249 Imaging Setup – imaging mode selection and track activation

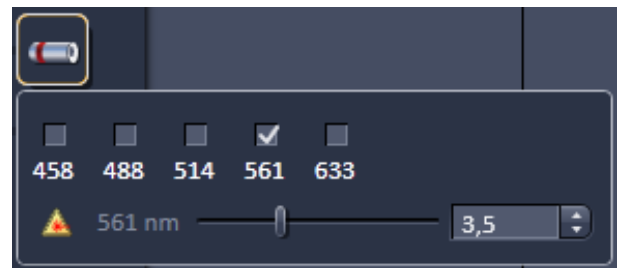
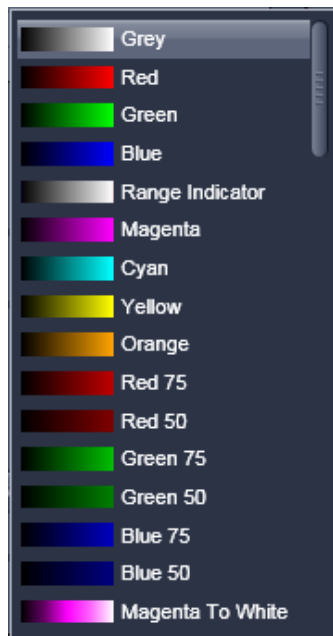


Fig. 250 Laser line and laser power selection



**Fig. 251** Channel color selection

- Activate channel 1 via the check box. You may want to assign a different color to the channel which will be taken over for the initial display of the image. Click the color triangle and select the desired color from the drop down menu (Fig. 251).
- Use the dye triangle to display the emission spectrum of your dye.
- Use the slider for the respective channel (Fig. 249) to set the required detection band (e.g. 566-644nm).
- If required, deactivate all the other channels (ChS, Ch2, transmission, R1-2) via check box.
- Click on the icon of the main dichroic beam splitter and select **MBS 488/561** or any other MBS indicating the 561 line.

The beam path in the **Imaging Setup** tool now displays the way the potential emission signal takes. Channel 1 receives the red part of the spectrum. The settings are suitable for imaging dyes like Rhodamin, TRITC or Cy3.

For overlaying fluorescence and transmitted-light images, click on the **T-PMT** (Transmission) button in the **Beam Path and Channel Assignment** panel.

All transmitted light applications like

- phase contrast
- differential interference contrast (DIC)
- polarization contrast (Pol)
- darkfield

can be performed if the hardware of the microscope is equipped with the necessary optics. We recommend DIC as standard contrast because the suitable objectives have a higher transmission than the ones for phase contrast. This enhances detection sensitivity.


In case intensity fluctuations occur e.g. with 405 nm lasers, a different attenuation level should be chosen. In case this is not possible, a different laser line needs to be selected for the T-PMT acquisition or track.




### 5.2.23.2 Defining the Scan Parameters

- Open the **Acquisition Mode** tool (Fig. 252).
- Select **Frame** mode and a **Frame Size** of 512 x 512 to start with.
- The **Optimal** button automatically adjusts the frame size to match the magnification and resolution of the objective. Thus, images are acquired without collecting redundant image information.
- The Scan Speed is set to 9 per default. A lower speed produces better images as the light collection per pixel is higher. Use a speed from 7 to 9 to begin with.
- Start with the following settings on the **Averaging** panel:
 

Bit depth:	8 bits
Number:	1 (no averaging)

 Additional parameters like scan direction are displayed in **Show all** mode. Scan direction is per default set to unidirectional.

 The default settings for Acquisition Mode are suitable for good image quality and do not need to be changed for initial scanning.

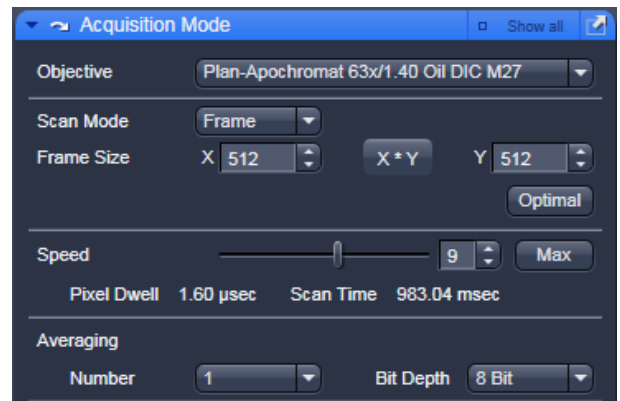


Fig. 252 Acquisition Mode tool

### 5.2.23.3 Defining the Detection Parameters

- Activate the **Channels** tool (Fig. 253).
- Set the **Pinhole** to one Airy Unit clicking 1 AU.
  - The pinhole diameter should be so small that there is still enough variation for the setting of the Gain (Master) and that sufficient image information is still available. 1 Airy is a good value to enable a confocal fluorescence XY-image to be obtained.
  - A small pinhole diameter will increase the depth of focus, but reduce the light intensity received by the PMT photomultiplier (for reflection mode confocal images start with a pinhole value of 0.5 Airy Units).
- Use the **Set Exposure** button.
  - The system determines the settings for the Gain (Master) and digital offset to match the scan speed, pinhole size and laser power.
  - Finally, the system builds up the image.

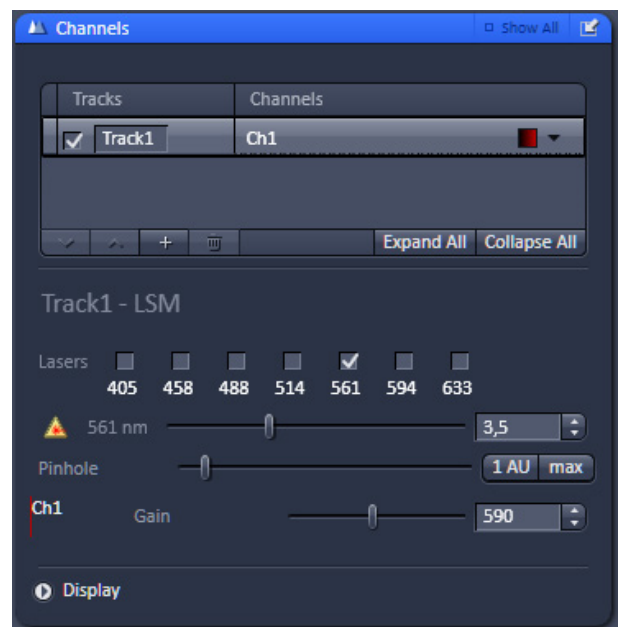
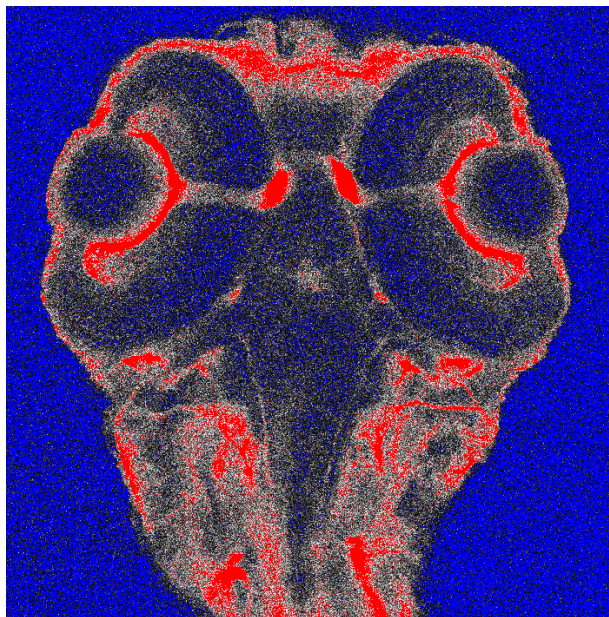
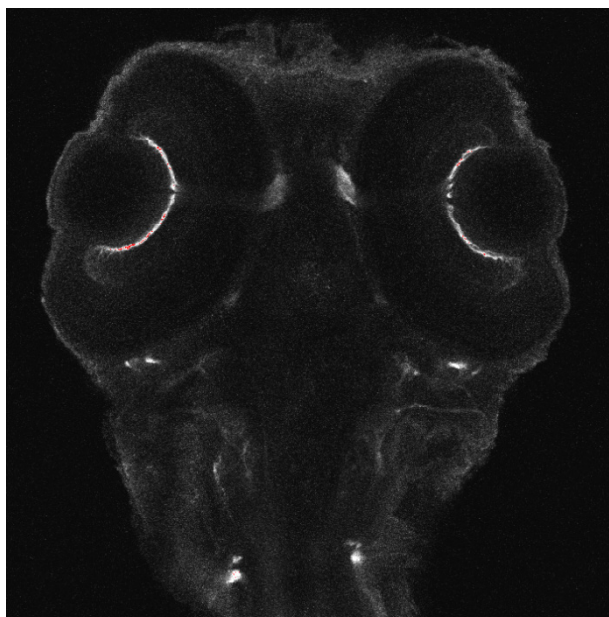


Fig. 253 Channels tool



**Fig. 254** Image displaying bad adjustment of gain and offset (blue regions are underexposed, red regions are overexposed)



**Fig. 255** Image displaying good adjustment of gain and offset



Image optimization can be achieved faster if you select a smaller frame, since less data have to be processed.

The greater the number of averages selected using **Mean** as average **Method**, the better the image quality will be; the scan time is prolonged accordingly.

#### 5.2.23.4 How to Optimize Image Quality

As a rule, the first scanned image is not ideal, since the settings of the laser and therefore also the photomultiplier might not match the light output. More often than not, the screen image is dull and needs subsequent optimization.

- Use the lookup table **Range Indicator** (see section **Dimensions**). This display mode shows overexposed regions in red and underexposed regions in blue. Some red and some blue pixels should be visible to ensure the signal is spread over the dynamic range of the detector and no image information is lost.
- Start a Continuous scan and quickly adjust the laser power, Gain (Master) and offset to set the image into the dynamic range.
- Try to lower the impact of laser light onto the sample. Reduce the laser power and adjust the gain accordingly.
- To adjust the black level (background), use the **Digital Offset** slider so that areas without picture content just show a trace of blue.
- If necessary, re-amplify brightness with the **Digital Gain** slider.
- Stop scanning.
- Save the imaging configuration again as this time it will also save the correct settings for the detector, the laser, and the pinhole.

The signal-to-noise ratio can be substantially improved by reducing the scan speed to an acceptable level and averaging over several scans (i.e. with an average **Number** greater than 1 for the **Mean** average **Method** in the **Scan Control** window).

- Use the **Speed** slider in the **Acquisition Mode** tool set the slowest acceptable scan speed.
- In the **Number** text box of the **Averaging** panel enter the number of images to be averaged.

A similar procedure applies for image optimization if more than one channel is used and simultaneous image acquisition is performed.

Make sure the suitable lasers are switched on and the channels are activated.

Pay attention to address the right channel when pinhole size, detector gain, and amplifier offset are controlled as these are set individually for each channel.

Use the split view (see section **Split View**) to see the effect of the controls onto each channel separately.

If the acquisition is performed sequentially in with multiple tracks it is faster to activate only one track at a time for image optimization.

### 5.2.23.5 How to Optimize Imaging with Airyscan

#### Laser, Gain (Fig. 256)

For correct results with the Airyscan detection and processing, overexposure needs absolutely to be avoided.

By modifying

- Laser power
- and detection Gain

the detection can be set to the required level.

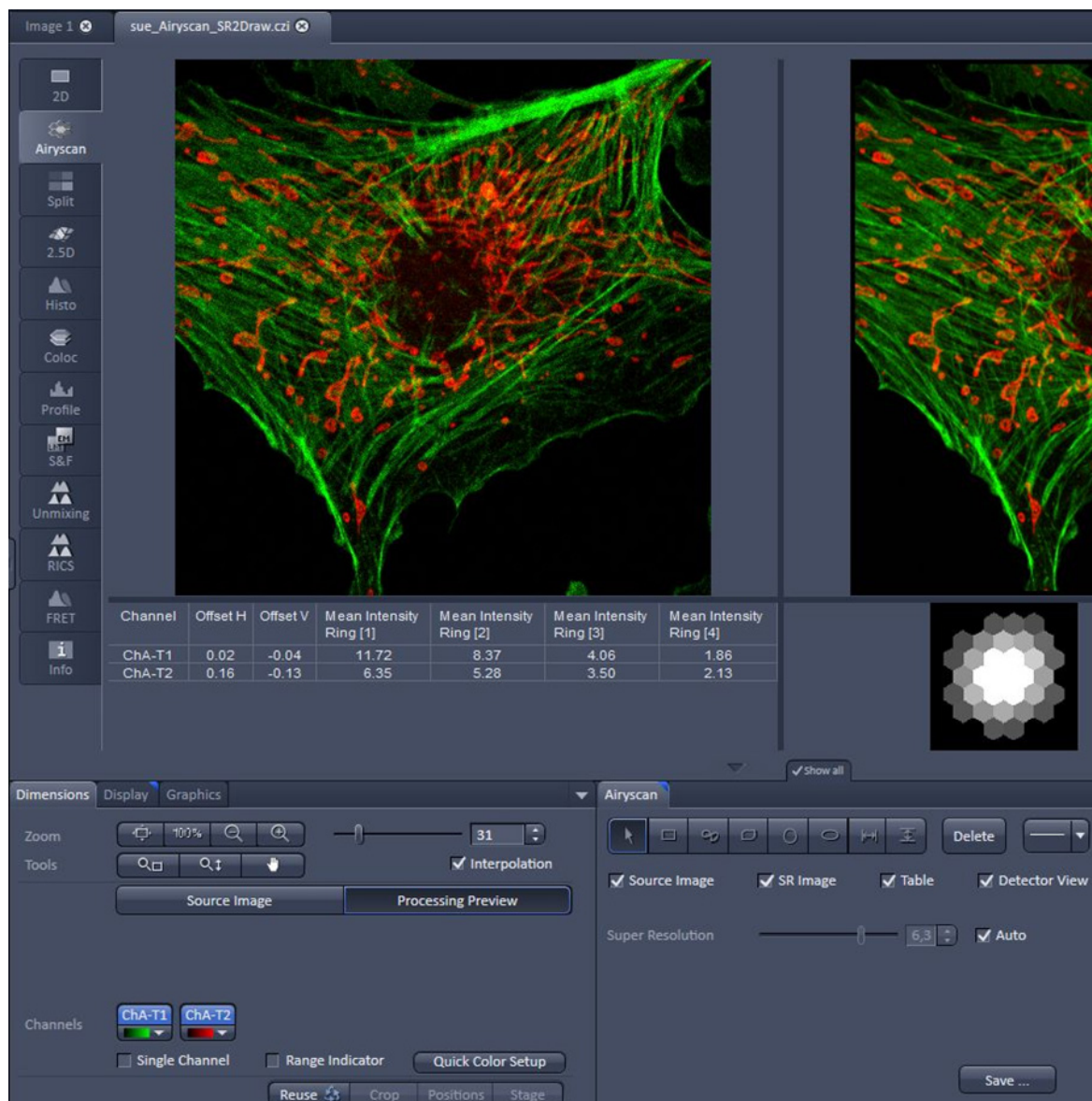


Fig. 256 Optimize imaging with Airyscan

**Raw data sum image, Range Indicator (Fig. 257)**

In order to fine tune the detection, the raw sum image (source image, left) of the Airyscan should be observed carefully.

Use the checkbox of the **Range Indicator** color palette to see overexposed pixels in red.

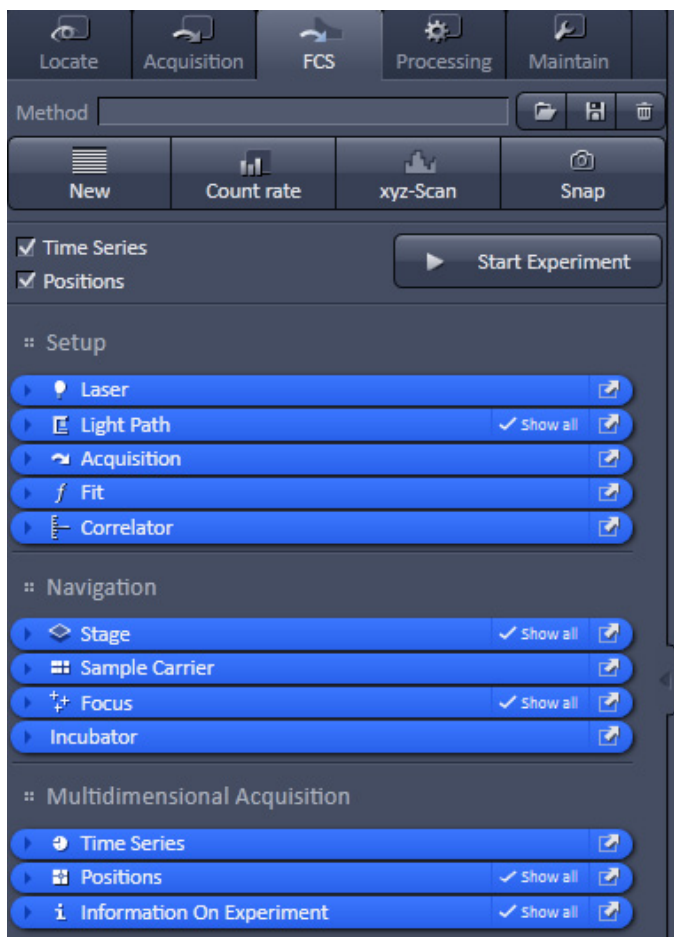


**Fig. 257** Airyscan View: Fine tuning the detection

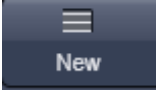

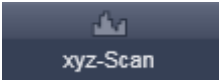

### 5.3 FCS Tab














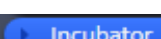


The major functions can be selected from the **FCS** tool group (Fig. 258) in the **FCS** tab. To open saved files click the **File** button in the menu bar.

The **FCS** tool group consists of (grey) Action Buttons and (blue) tool tabs.



**Fig. 258 FCS tool group (Note that Time Series and Positions tabs are only available, when the corresponding boxes have been checked)**

	<p><b>New Document</b> action button</p>	<p>Opens a new FCS window document in a new container within the Center Screen Area. If active, all new data will be added to the document. Old data can be added to the new document by drag and drop from stored documents.</p>
	<p><b>Countrate</b> action button</p>	<p>Opens the <b>Countrate</b> window, which displays counts per second (CR), correlation amplitude (G(0) and counts per molecule per second (CPM)</p>
	<p><b>xyz-Scan</b> action button</p>	<p>Will trigger a scan in x, y, z, xz and yz as defined in the <b>X-Y-Z Scan</b> tool.</p>
	<p><b>Snap</b> action button</p>	<p>Triggers one measurement using the settings at the highlighted position from a set of defined positions.</p>

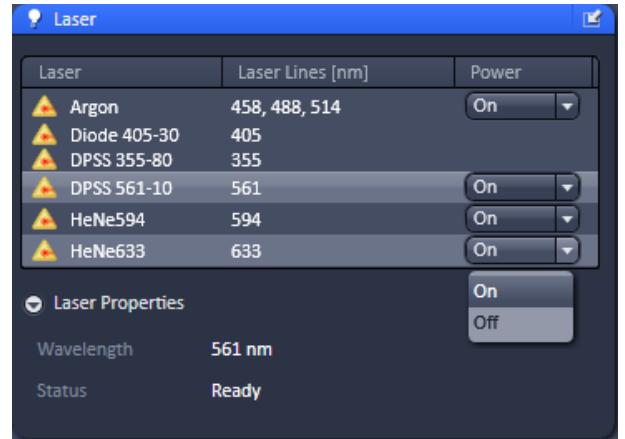
	<b>Start Experiment</b> action button	Triggers measurements according to the settings at all defined positions.
	<b>Stop</b> action button	Will end an active measurement. Data will be available to store up to the end point. Note this button only appears in the place of the <b>Snap</b> action button if this or the <b>Start Experiment</b> button was pressed and an active measurement was triggered.
	<b>Stop current step</b> action button	Will end an active measurement. Data will be available to store up to the end point. Note that this button replaces the <b>Start Experiment</b> button, if the latter was pressed.
	<b>Method</b> drop down menu	Store, delete and load pre-defined methods to be used in the measurements; enter experimental info and document data
	<b>Tool</b> activation area check boxes	Activate certain toolbars in the display
	<b>Laser</b> tool [Setup]	Control to switch on / off lasers and check their status
	<b>Light Path</b> tool [Setup]	Define, store, delete and load predefined light paths; select laser lines and power; adjust pinhole
	<b>Acquisition</b> tool [Setup]	Set measurement times, channel color, pinhole size, pupil filing factor (if available)
	<b>Fit</b> tool [Setup]	Define fit models and select model for data analysis
	<b>Correlator</b> tool [Setup]	Set up correlation parameters to be used in the experiment
	<b>Stage</b> tool [Navigation]	Control movement of motorized stage
	<b>Sample Carrier</b> tool [Navigation]	Define, save, load and orientate sample carrier
	<b>Focus</b> tool [Navigation]	Define and control focus position
	<b>Incubator</b> tool [Navigation]	Define and control environmental conditions
	<b>Time Series</b> tool [Multidimensional Acquisition]	Set kinetics (only available, if <b>Time Series</b> box is checked)
	<b>Positions</b> tool [Multidimensional Acquisition]	Define and orient a sample carrier in x, y and z.; set measurement positions (only available, if the <b>Position</b> box is checked)

### 5.3.1 Setup – Laser

Open the **Laser** tool by clicking the **Laser** tab in the **Setup Manager** tool group (Fig. 259). Close the tool box by clicking again.

Select **On** from the respective pull down menu to switch the laser on.

The HeNe lasers and Diode lasers will be switched on automatically after software start. For each laser the properties are displayed if the **Laser Properties** window is opened.



**Fig. 259 Laser tool box with Laser Properties Information window opened**

See section 5.2.5 for further details on the lasers.

### 5.3.2 Setup – Light Path

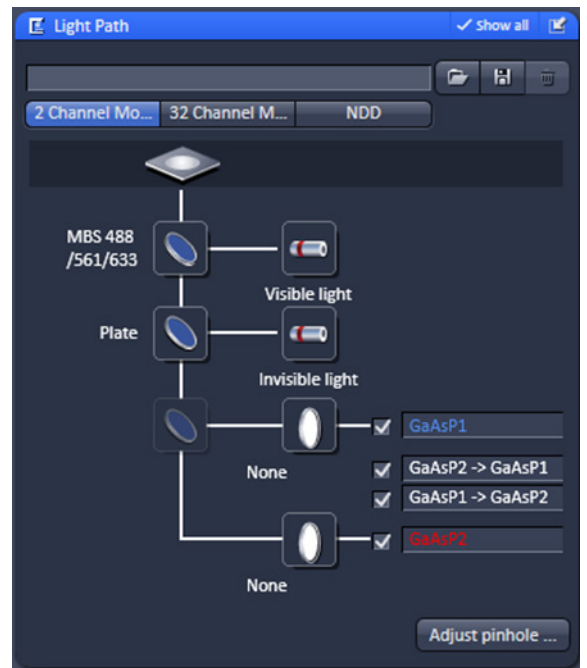
The **Light Path** tool allows new / existing beam path configurations to be created / edited and saved. Existing beam paths can be deleted with the **Delete** function.

- Click on the **Light Path** tab to open or close the tool.

The display will change for different configurations.

The following combinations are possible:

- 1.) 32 GaAsP array / one side PMT and optional 2 Channel Module (BiG.2) and/or NDD (BiG.2 as NDD) (Fig. 260)
- 2.) 3 ch with one GaAsP and one side PMT and optional 2 Channel Module (BiG.2) and/or NDD (BiG.2 as NDD) (Fig. 260)
- 3.) 2 Channel Module (BiG.2) and / or NDD (BiG.2 as NDD)




**Fig. 260 Light Path tool for 32 channel system with BiG.2 on DC out and NDD port**

If more than one detector type is available, the respective beam path can be selected by pressing the corresponding tab, where **2 Channel Module** represents BiG.2 on the direct coupling port of the scan head; **32 Channel Module** or 3 Channel Module represents the Quasar detector (32 channel GaAsP array or 1 channel GaAsP with 2 flanking multialkali PMTs); and **NDD** represents BiG.2 on NDD port (Fig. 260). Two detector types are available simultaneously that can perform FCS.

### (1) Saving and deleting beam paths

You can save a beam path by typing in a memorable name into the drop down menu selection box and pressing the **Save** button (floppy disc icon). If you save a beam path under the existing name you will be prompted to confirm overwriting the old configuration. Press **Yes** to overwrite, **No** to keep the old configuration.

You can delete a beam path by selecting it from the drop down menu and pressing the **Delete** (dustbin icon) button.

 Before saving an altered beam path a pinhole alignment should be performed. Pinhole positions will be linked to the selected beam path and called up whenever that beam path is selected later.

### (2) Loading a predefined beam path

You can select a saved beam path configuration from the drop down menu. The selected beam path will then be loaded and shown with its settings in the displayed diagram. You can alter the beam path if required.

Procedure to load and reconfigure an existing beam path:

- Select a corresponding beam path from the **Light Path** drop down menu list box.
- Change settings as required.
- Save the configuration under the old name to overwrite the existing configuration or under a new name to keep the old configuration.

### (3) Define a new beam path

A new light path is defined by choosing the appropriate filters, dichroics and laser lines in the **Light Path** diagram. Note that for BiG.2, filters are exchanged manually by exchanging the filter cube (consisting of SBS, EF1 and EF2).



### 5.3.2.1 Light Path for 2 Channel Module (BiG.2 on DC out port)

BiG.2 has two GaAsP detectors that can be used simultaneously to acquire two autocorrelation functions (AC) per each channel. There are also two cross-correlation (CC) channels available, where the channels are correlated to each other.

#### Selection of dichroics and filters

From top to bottom you have the following dichroics and filters available.

#### Main dichroic beam splitter (MBS):

The MBS reflects the specified laser lines and allows the resulting fluorescence spectrum to pass through.

- Click on the MBS icon to open a list of dichroics (Fig. 261).
- Select the appropriate one by a mouse click.
- Close the list by clicking the icon again.
- You have two major beam splitters, one for the Visible light and one of the Invisible light (if applicable). A plate should be placed in the dichroic that will not be used. If the system is not equipped with a violet laser line, the **Invisible light** major beam splitter is not available.

#### Secondary dichroic beam splitter (SBS):

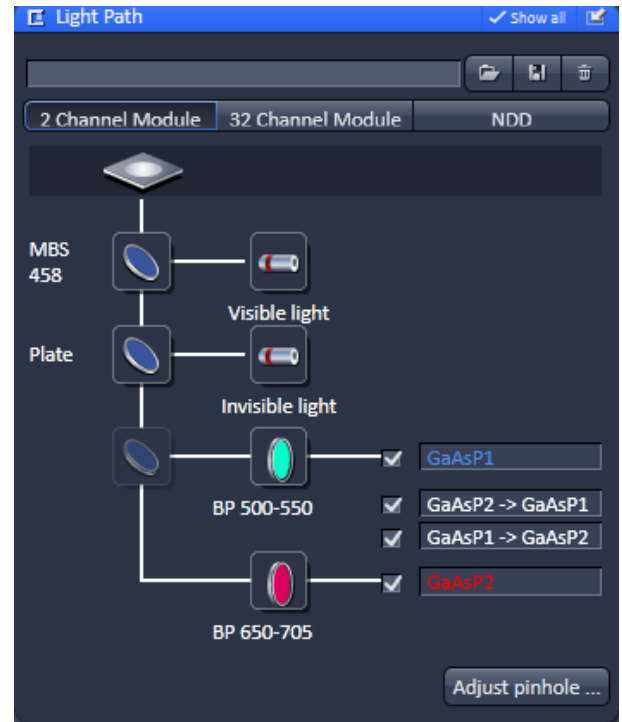
The SBS splits the fluorescence spectrum onto the various detection channels. The long pass (LP) filter lets wavelengths pass above the specified border wavelength and reflects wavelengths below. The short pass (SP) filter lets wavelengths pass below the specified border wavelength and reflects wavelengths above. The SBS is positioned in a 45° angle to the incident beam.

The icon is inactive, as the SBS is part of the filter cube together with the emission filters, which has to be replaced manually.

#### Emission filter 1 and 2 (EF1 and EF2):

The EF is used to narrow the fluorescence spectrum. The band pass (BP) filter allows the range within the specified border wavelengths to pass through. The long pass (LP) filter allows the range above the specified border wavelength to pass through. The short pass (KP) filter allows the range below the specified border wavelength to pass through. The EFs are positioned in a 90° angle to the incident beam.

- ☞ The secondary beam splitter within the scan head, which deflects the signal either to the 2 channel module (BiG.2) or to the 3/32 channel is set automatically to mirror/plate as needed.



**Fig. 261 Light Path tool for 2 Channel Module**

The icons are inactive, as the EFs are part of the filter cube together with the SBS filter, which has to be replaced manually. The filter are indicated to SW within the Filters Tool window (Maintain tab). Note, that if the filter is exchanged manually and the database is not updated, the old filter names will stay.

To adjust the pinhole for this beam path press **Adjust pinhole...** and proceed as described below.

### **Selection of channels**

You can select channels by activating the **Channel** check boxes:

- AC GaAsP1 and AC GaAsP2 are physical channels for auto-correlation
- CC GaAsP2 → GaAsP 1 and CC GaAsP → GaAsP are software channels for cross-correlation, whereby AC GaAsP 2 is shifted versus AC GaAsP and vice versa

You can enter a special comment (for example the used dye or a memorable name) into the editing field next to the activating checkboxes.

### 5.3.2.2 NDD Light Path (BiG.2 as NDD)

BiG.2 can be attached to the transmitted (NDD-T) and/or reflected (NDD-R) position (not more than two BiG.2 modules in can be used on one system in total) up to four GaAsP detectors can be used simultaneously to acquire up to four autocorrelation functions (AC), one for each channel. Each of these channels can be cross-correlated to itself or to any of the other activated channels (CC), but a total number of ten cross-correlation channels is the upper limit.

#### Selection of dichroics and filters

From top to bottom you have the following dichroics and filters available.

#### Main dichroic beam splitter (MBS):

The MBS reflects the specified laser line and allows the resulting fluorescence spectrum to pass through.

- Click on the MBS icon to open a list of dichroics (Fig. 262).
- Select the appropriate one by a mouse click.
- Close the list by clicking the icon again.
- You have two major beam splitter filter wheels, one for the visible lasers (458 to 633 nm) and one of the invisible light (for UV, 405, 445 and NLO laser).

#### Secondary dichroic beam splitter (SBS):

The SBS splits the fluorescence spectrum onto the various detection channels. The long pass (LP) filter lets wavelengths pass above the specified border wavelength and reflects wavelengths below. The short pass (SP) filter lets wavelengths pass below the specified border wavelength and reflects wavelengths above. The SBS is positioned in a 45° angle to the incident beam.

The icon is not displayed, as the SBS filter wheel is set automatically for directing the light either to the internal detectors (3 or 32 Channel Module) or to the external detectors BiG.2 (2 Channel Module). This is dependent on which detectors are activated. For BiG.2 (also as NDD) the filter cube holds both, a beam splitter and two emission filters. The filter cube has to be replaced manually.

#### Emission filters:

The EF is used to narrow the fluorescence spectrum. The band pass (BP) filter allows the range within the specified border wavelengths to pass through. The long pass (LP) filter allows the range above the specified border wavelength to pass through. The short pass (KP) filter allows the range below the specified border wavelength to pass through. The EFs are positioned in a 90° angle to the incident beam.

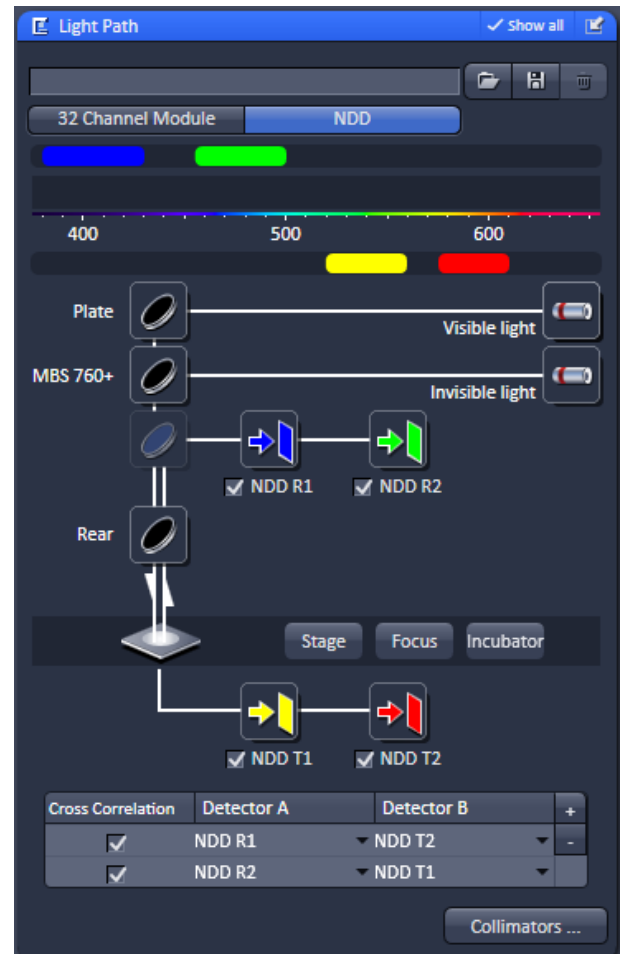
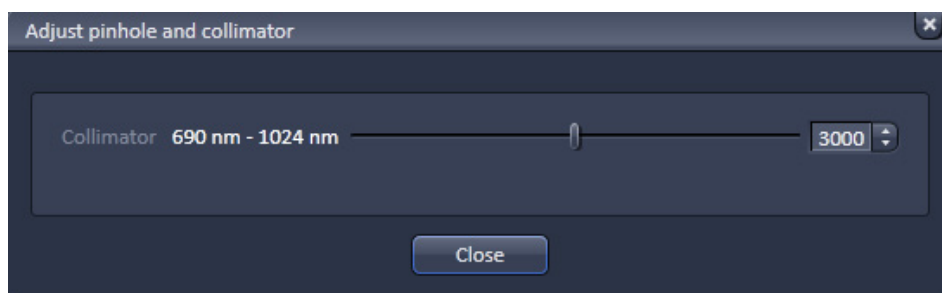


Fig. 262 Light Path tool for the BiG.2 on NDD port

The icons are not displayed, because the EFs are part of the filter cube together with the SBS filter, which has to be replaced manually. The filter are indicated to SW within the Filters Tool window (Maintain tab). The spectral detection band is displayed, and the type of filter is indicated in the tool tip for each detector.

BiG.2 can be combined with up to 4 NDD PMT channels. The Light Path only shows the GaAsP channels of BiG.2.

The **Collimators...** button opens the **Adjust pinhole and collimator** panel (Fig. 263). Use the slider, the arrows or the input box to adjust the collimator position of the infrared light path. Optimize the settings for maximum CPM (Counts per Molecule) rate.



**Fig. 263** Adjust pinhole and collimator panel

### 5.3.2.3 Light Path for 32 Channel Module

The 32 Module consists of an array of 32 GaAsP detectors plus two side PMTs. The side PMT of the longer wavelength region (Pmt2) can be used together with the GaAsP array detector for FCS. Up to six autocorrelation channels can be defined by setting respectable spectral bands. Each of these channels can be cross-correlated to itself or to any of the other activated channels (CC), but a total number of ten cross-correlation channels is the upper limit.

#### Selection of dichroics and filters

From top to bottom you have the following dichroics and filters available.

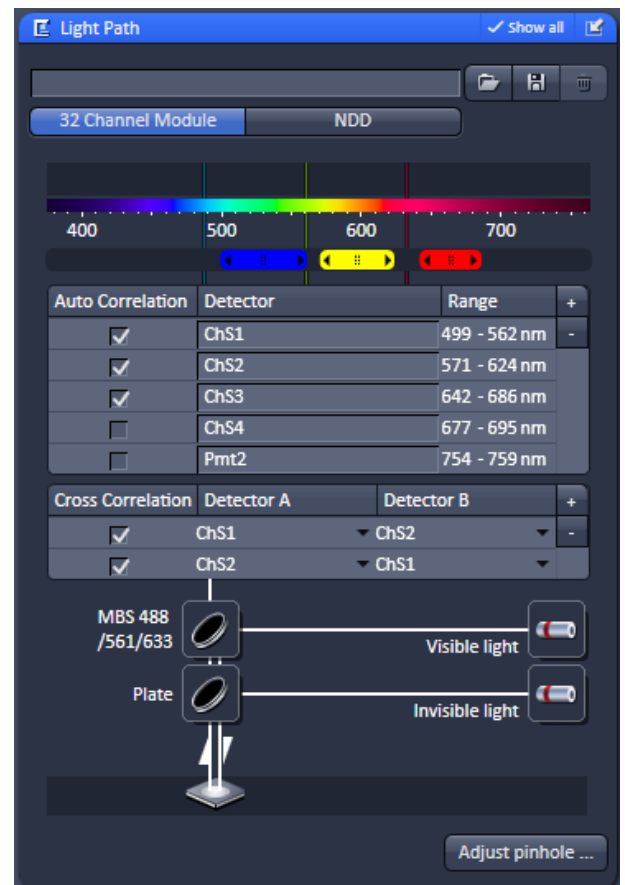
Main dichroic beam splitter (MBS):

The MBS reflects the specified laser line and allows the resulting fluorescence spectrum to pass through.

- Click on the MBS icon to open a list of dichroics (Fig. 264).
- Select the appropriate one by a mouse click.
- Close the list by clicking the icon again.
- You have two major beam splitters, one for the Visible light and one of the Invisible light.

There are no SBS nor EF filters, as a grating is used for spreading the light into its spectrum, which is projected onto the GaAsP array.

Press the **Adjust pinhole...** button to open the **Adjust pinhole** panel. Here you can adjust the pinhole for the respective beam path or method.



**Fig. 264** Light Path tool opened for the 32 Channel Module

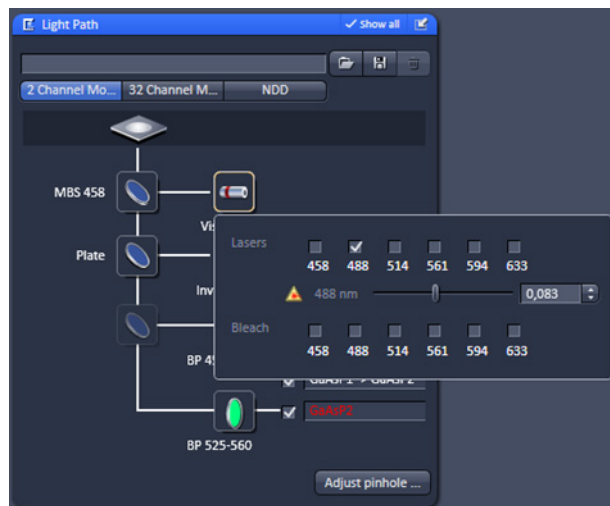


Fig. 265 Light Path tool with laser submenu

### 5.3.2.4 Selection of Laser Lines

- Press the **Laser** button to display the laser control expansion submenu (Fig. 265). Alternatively you have access to the **Laser Lines** in the **Acquisition** tab. They provide settings for:
  - **Lasers** for laser power used in measurement and pinhole adjustment,
  - **Bleach** for laser power used in bleaching

Since the expansion submenu will close when clicking in other areas, we recommend to use the **Laser Lines** from the **Acquisition** tab, if you want to adjust the count rate.

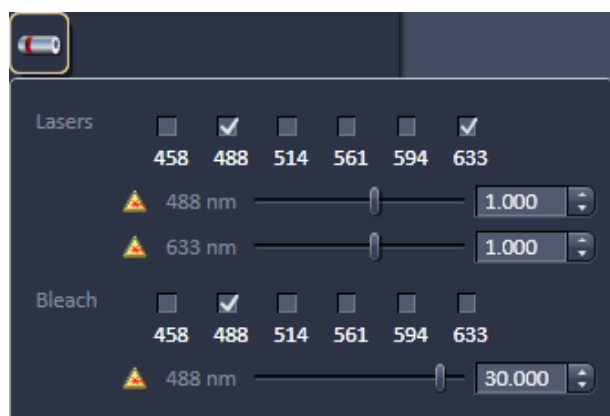


Fig. 266 Visible Light Laser panel



Fig. 267 Invisible Light Laser panel

### Lasers


- Press the **Visible Light** or **Invisible Light** tab to display the laser control panel used for measurements and pinhole adjustments (**Lasers** area) or bleaching (**Bleach** area) (Fig. 266). Press again to close the panel.
- Activate the lasers you want to use by checking the corresponding boxes. The lasers with sliders will appear. Set the requested laser attenuation (%) using the sliders, the arrows, or typing in the display field.

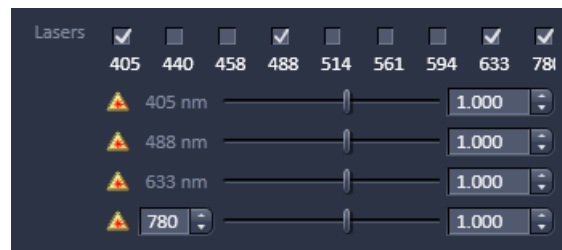
👉 Note, that lasers for measurements and (pre-)bleach can be selected independently from each other.

👉 If in **AOTF Dampening** a factor different from 100 % was chosen, the set AOTF value in **Lasers** and **Bleach** will be reduced by that percentage.

👉 Note, that lasers for measurements and pre-bleach can be selected independently from each other.

👉 The same options are available for the 405 and 440 lasers and the NLO laser, if available, in the **Invisible Light** laser selection box (Fig. 267).

 The **Lasers** functionalities for laser control are also available in the **Acquisition** tab (Fig. 268). Only that all visible and invisible lasers are displayed together (also applies if **Show All** mode is not set in the **Light Path** tool window).





**Fig. 268** Laser lines in the Acquisition tab

### Procedure for setting the laser power

- Set the laser attenuation using the sliders in **Lasers** from the **Laser** control panel in the **Light Path** tool or **Acquisition** tool. Open the **Count Rate** window by clicking the **Count rate** action button in the **FCS** tab. A good starting point is to set the intensity in such a way that a count rate between 50 kHz and 200 kHz is obtained.
- For most dyes, the Counts / Molecule setting should be optimized in a second step to a value just under its maximum by changing the laser power. If carriers of different slide thickness are employed the Counts / Molecule setting should be optimized by using the correction ring on the lens. The correction ring is turned counterclockwise or clockwise until a maximum value is obtained. The correction ring should also be used for adjusting the Counts / Molecule setting whenever the immersion media is changed. This is especially important in cases where the refractive index of the immersion media is different from that of the sample. When finished, close the **Count Rate** window using the **Close** button.

### Procedure for defining a new beam path configuration

- First tick the laser or lasers (in case of cross-correlation) you need for excitation of your sample.
- Then choose a major dichroic beam splitter which should correspond to the chosen laser(s).
-  Please note that you can use IR lasers for FCS, but there are no specifications for the performance of the instrument for this excitation.
- Activate the channels you want to use. It is recommended to give the channel a name which is easy to remember.
- Set the laser power.
- Perform a pinhole alignment or adjust the collimator settings.
- Store beam path or method, which uses the beam path.
-  **BiG.2** as 2 Channel Module or NDD you have to choose the right SBS and EF in the filter cube and place it manually. The filters are indicated to the software within the Filters Tool window (Maintain tab). Otherwise the system does not display the spectral range of the filters.

### 5.3.2.5 Pinhole Adjustment

The **Adjust Pinhole** panel allows you to set the pinhole diameter and to automatically align the pinhole position in x and y.

- Click on the **Adjust Pinhole** tab to open the **Pinhole configuration** panel (Fig. 269). Click on **Close** to leave the panel.



**Fig. 269 Adjust Pinhole panel**

#### Setting the Pinhole diameter

☞ Activate the channel you want to use and that is appropriate for your settings by pressing the respective **Ch** tab. In one channel settings only the active used channel will be available. In two or more channel settings both channels will be available. You can adjust the pinhole to either channel. The values for the pinhole alignment done with the last channel will be stored and used with a method.

You can set the pinhole diameter of the LSM using the Diameter slider, scroll arrows or the input box (Fig. 269). The display of the input box gives the diameter in  $\mu\text{m}$ . The Pinhole diameter in Airy units is calculated automatically and displayed beside the input box. The **1 AU** button allows you to set the pinhole size to 1 Airy unit by just clicking on it. Set the desired pinhole diameter using the slider, the scroll arrows or type into the input box.

☞ This will alter the pinhole diameter automatically also for the method in the **Pinhole** panel. If you need another pinhole size for doing the pinhole alignment be sure to reset it before saving the method.

- It is recommended to set the pinhole diameter to a size corresponding to the used excitation wavelength that corresponds to 1 AIRY unit:
  - 458 nm: 33  $\mu\text{m}$
  - 488 nm: 34  $\mu\text{m}$
  - 514 nm: 39  $\mu\text{m}$
  - 561 nm: 40  $\mu\text{m}$
  - 633 nm: 45  $\mu\text{m}$

Pinhole sizes are given in  $\mu\text{m}$  and AIRY units.

☞ Please note that there is only one pinhole for all detector channels of the various modules. NDD does not have a pinhole. You can adjust the pinhole to either channel. The values for the pinhole alignment done with the last channel will be stored along with the beam path or a method and used. A method is always saved together with the system configuration, acquisition and processing parameters. A beam path is saved only with the pinhole settings.

You can adjust the beam path to the pinhole of the LSM manually or automatically. Manual adjustment is not recommended, since the relevant procedure is very complex.



---


The pinhole is adjusted using a dye solution. The general approach is to move the pinhole cyclically in x and y until the intensity maximum is found. For each excitation wavelength a suitable dye must be used.

We recommend:

- Rhodamine 6 Green (Rh6G) or Alexa 488 for 458, 488 and 514 nm,
- Tetra-Methyl-Rhodamine (TMR) or Alexa 546 for 543 nm and
- Cy 5 or Alexa 633 for 633 nm.

It is also recommended to work with a relatively concentrated solution ( $10^{-6}$  mol/l) and low laser power to achieve smooth intensity curves.

- Press the **Coarse** button of x and y to perform a coarse adjustment in x and y. The pinhole will travel over the maximum range for each axis. Perform a fine adjustment in x and y by pressing the **Fine** button. The pinhole will travel only a limited distance around the peak found in the coarse alignment.


 If the pinholes are adjusted for the first time, the coarse adjustment must be performed first and then the fine adjustment, each time for x and y. For subsequent readjustments, the fine adjustment is normally sufficient.

- Click on the **X** and on **Y** auto adjust buttons to perform a coarse / fine alignment of the pinhole in x and y, respectively. In either case, the **Pinhole Adjustment** window will appear (Fig. 270). In the Count Rate/Position diagram, the crosses correspond to the measured intensity (count rate). The line corresponds to the intensity curve fitted to the data points to find the optimum pinhole position. The pinhole will be automatically positioned to the maximum. If a maximum will not be found in the fine alignment, the system will show a warning message. In this case, a coarse alignment must be performed before the fine adjustment.



**Fig. 270 Automatic Pinhole Adjustment in x coarse (left) and x fine (right)**


- You can also alter the position by typing into the input boxes or using the sliders or scroll arrows. If both coordinates are changed, the system will regard this as a new alignment.


 The pinhole does not move in z. The collimator for invisible light is set to the optimum position in the factory and care should be taken to change its settings. The collimation for the Visible light is done in the laser coupling and does not need optimization.


---

### Procedure to adjust Pinholes

- Mount a carrier with a suitable dye solution and orient the sample stage. Select the test sample.
- Select the beam path or the method with attached beam path you want to use.
- Set the laser power above 100 kHz, if possible.
- Open the **Pinhole Adjust** window (Fig. 270).
- Set the pinhole diameter as required
- Select the channel to which you want to adjust in a dual channel set up.
- Adjust both pinhole axes separately in the following order: x coarse, y coarse, x fine, y fine.

 Both pinhole axes x and y must be adjusted. Otherwise the pinhole alignment will not be stored.

 You might be able to increase count rate by adjusting the collimator in the **Collimator** panel for invisible light. To find the optimum collimator settings use either the count rate or images. This function should be changed with care only. The optimal collimator setting is pre-set in the factory. For visible light there is no need for collimation.

 In the Pinhole Alignment, the beam path is adjusted relative to the fixed pinhole. In a one channel setting, only the selected channel is active and the chosen laser line used. In a two channel setup both channels can be chosen for doing the pinhole alignment. If both laser lines are either from the VIS or InVIS range than only one channel has to be adjusted, since the same beam path is used. However, if one laser is from the VIS range and the other from InVIS, than you have to adjust both channels. If only one laser line is activated with two channels selected, for example when using a 50/50 beam splitter, than this laser line is used either for channel 1 or channel 2.

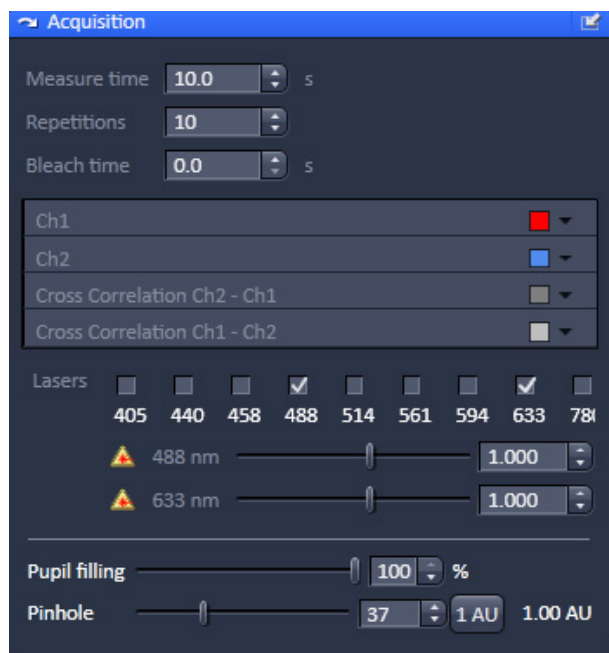



Fig. 271 Acquisition tool

### 5.3.3 Setup – Acquisition


#### Measure Time [s]

The **Measure Time** (Fig. 271) is the period of **one** measurement. As a rule of thumb the measurement time should be about 1000 x the diffusion time of a molecule under study. However, due to noise in the system a 10 s measurement time is a good start value to obtain good statistical results. Enter a number in seconds in the input box or use the scroll arrows.

 Note that the laser power set under **Measurement / Pinhole Adjust** in the **System Configuration Laser** panel will be used for the measurement. If no laser was activated but a measurement time entered, the system gives a warning. Confirm the warning if you want to continue anyway.

#### Repetitions


The **Repetitions** value determines the number of measurements, i.e. how often **Measure Time** is to be performed within the measurement. Enter a value in the input box or use the scroll arrows.

 Note that repetitions can be averaged into an average correlation function if required. This will improve statistics. An average of 10 x 10 seconds measurement is not but nearly as good as one 100 sec measurement. If bleaching becomes a problem, it might help to reduce measurement time and increase repetitions to obtain nearly as good statistical results while reducing bleaching.

#### Bleach Time (s)


The **Bleach Time** is the time prior to the measuring procedure during which the laser already has an effect on the sample. It is used to pre-bleach the sample, for example to bleach away immobile molecules that would not contribute to the correlation and would affect the correlation amplitude negatively.

The **Bleach Time** is taken into consideration only **once** (at the beginning of a measuring cycle). Enter a value in seconds in the input box or use the scroll arrows.

 Note that the laser power set under **Bleach** in the **System Configuration Laser panel** will be used for the bleach. If no bleach laser was activated but a bleach time entered, the system gives a warning. Confirm the warning if you want to continue anyway.

Procedure for setting the times for an experiment:


- Set the **Bleach Time**.  
Start with the **Bleach Time** of 0 s. If the signal decreases during the subsequent measurement, this might be caused by bleaching. As a remedy, you can pre-bleach the sample before measurement by setting the **Bleach Time** to a non-zero value. If no **laser** check box was activated, no bleaching occurs, but the measurement will be delayed for the bleach time.

- Set the **Measure Time**.  
If you do not have any idea about the behavior of your sample, start with a measurement time of about 10 seconds. Depending on the signal-to-noise ratio of your correlation curve, decrease or increase the measurement time.
  - Set the **Repetitions**.  
Start with **Repetitions** set to 1. If you want to obtain information about the variation of your fitted values later on, increase the repeat count to produce a measurement series. 10 times is a good value to start with.
-  The total duration of the measurement will be indicated as **Calculated duration** in the **Time Series** tab.
- Click on the **Acquisition** tab to open the **Acquisition** panel (Fig. 271). Click on any other tab to leave the panel.

In the **Channel** area you can assign from a look up table a color for each channel. Every channel selected under **Light Path** tab will be displayed. With BiG.2, NDD and the 3 Channel Module you have up to four channels, two auto- and two cross-correlation channels. With the 32 Channel Module you have up to eight auto-correlation channels and accordingly 8 faculty cross-correlation channels.

In the Lasers area you can activate any available laser by checking the corresponding box and set the attenuation power. The attenuation power will be updated between the **Acquisition** tab and **Light Path** tab. The set laser power will be used for the measurement and pinhole alignment.

In the **Pinhole** area the **Pupil filling** slider controls an optional iris in the excitation beam that allows you to enlarge the size of the confocal volume by decreasing the pupil filling. Only if present will the **Pupil filling** slider and input box be available in the Pinhole menu. You can enter a value by typing, using the arrows or the slider. The Pinhole slider allows you to set the diameter of the pinhole. The Airy units are displayed right of the Diameter slider. By pressing the **1 Airy** button the pinhole diameter will be set to 1 Airy unit for one selected laser line, or a compromise between all selected laser lines.

-  Note, if the system is switched to LSM mode, the pupil filling will automatically be set to 100 %. The last entered value will be taken when switching back to FCS mode.

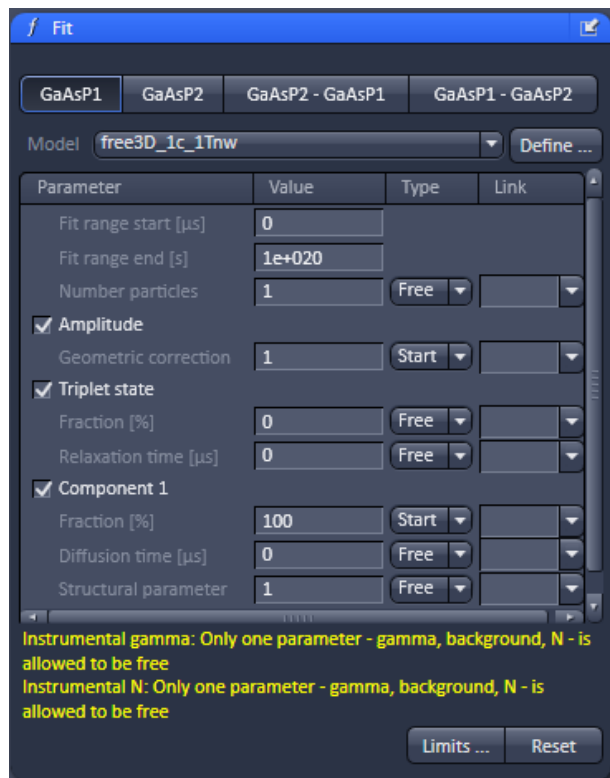


Fig. 272 Fit tool

### 5.3.4 Setup – Fit

The **Fit** tool allows you to load a model to be used for the measurement as well as to define new models. Loading a predefined method

The **Fit** tool menu allows you to load in a fit model and define how the parameters are to be fitted.


- Click on the **Fit** tool tab to open the **Fit** tool (Fig. 272). Click the tool tab again to close the panel.
- Select a channel by pressing a **Ch** button. There will be as many channels available (auto- and cross-correlation as had been selected in the **Light Path** tab).


The example shows a configuration with **GaAsP1** and **GaAsP2** auto-correlation as well as a **Cross Correlation** GaAsP1-GaAsP2 cross-correlation channels activated. Note that channels will only be active if selected in the current configuration. To each channel a different Fit model can be assigned.

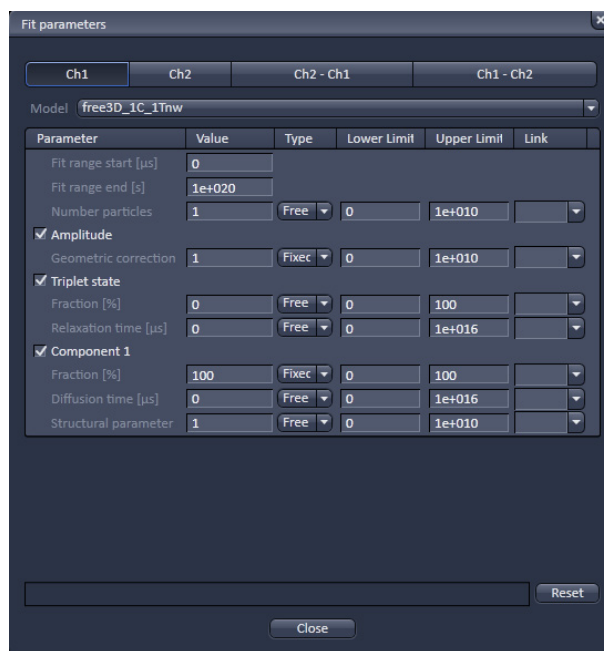
- Click on the arrow of the **Model** drop down menu to display a list of pre-defined models and select one of them. This will load the model for this channel. The model name will be shown in the **Model** display box and the corresponding model will be shown in the **Model** table. The table has the following entries:

- **Fit range start:** Designates the start value of the correlation function taken into account for the fit. You can change the value by typing in the display box.
- **Fit range end:** Designates the end value of the correlation function taken into account for the fit. You can change the value by typing in the display box.
- **Parameter:** designates the parameter by its name. You can activate or deactivate the parameter by ticking / de-ticking the check box. Only if the parameter is activated it will be taken into account for the fit.
- **Value:** designates the currently assigned value of the parameter. You can change the value by typing in the display box.
- **Type:** designates if a parameter is free floating or if its value is fixed or should be used as a start value. You can choose between these options in the drop down menu by selecting **Free**, **Start** and **Fixed**, respectively.
- **Lower Limit:** defines the lower limit value as a fit parameter; if this value is falls short, the fit is rejected and another (global) minimum is searched for. You can change the value by typing the value in the display box. The default value depends on the parameter, but is in most cases 0. (Only available if the **Limits...** button is pressed that will open the **Fit parameter** window (Fig. 273)).
- The text field displays in yellow any constraints or errors of the defined fit model.

- **Upper Limit:** defines the upper limit value tolerated from a fit; if this value is exceeded, the fit is rejected and another (global) minimum is searched for. The default value depends on the parameter. (Only available if the **Limits...** button is pressed that will open the **Fit parameter** window (Fig. 273)).
  - **Link:** links the parameter globally. Type **M**, **K**, **P**, **R** and **C** to link the parameter over measurements, kinetic indices, positions, repetitions and channels, respectively.
- The **Status** display window gives information on conflicts in the entries. For example, if the structural parameter was fixed to 5, but its lower limit set to 6, the system will report this conflict.
  - Before saving you can return to the old default settings by pressing the **Reset** button. This button is also available from the **Fit parameters** window, which can be opened by pressing the **Limits...** button and closed by pressing its **Close** button. **Reset** will undo all changes. If the method was saved, the new entries will be the default.

 Generally it is accepted that non-linear fitting procedures yield more reliable results when the number of free floating parameters is low. It is recommended to fix parameters which are known from independent measurements. Good candidates for fixing are diffusion times of the free dye and the free (i.e. not bound) partner, which can be determined in previous measurements. Another good candidate is the structural parameter that is an instrumental parameter.

 If you save the method all changes will be saved with the methods.



**Fig. 273** Fit parameter window



Fig. 274 Define Model panel


### 5.3.4.1 Defining a New Model

If the **Define** button is pressed, the **Define Model** panel will open. It is used to define model equations to which measured data can be fitted.

- Click on the **Define** button tab to open the **Define Model** panel (Fig. 274). Click the tab again to close the panel.

You have three options to define a model:

- **Correlation:** assemble a correlation model from predefined equations, which will be fitted analytically
- **PCH:** assemble a photon counting histogram model, which will be fitted numerically
- **Formula:** program a user defined model equation, which can be fitted analytically.

 For user defined models the options "free" and "globally link" are not available in the fit.

- Press **Ok** to save the current settings as a default.
- Press **Cancel** to leave the panel without setting the changes as a default.



### 5.3.4.2 Correlation Options

In correlation you can assemble a model with predefined terms.

- Press the **Correlation** tab to activate the options for assembling a correlation model (Fig. 275). Press any other tab to leave the panel.
- Normally the last defined model will be displayed in the **Equation Select** window. Selected terms will be displayed in blue and the assembled equation will be displayed in the  **$G(\tau)=1$**  display area. The name of the model will be displayed in the **Model** display box.
- You can load a pre-defined model from the **Model** drop down menu. Its name will then be displayed in the **Model** display box (Fig. 275).
- You can alter the model or leave it unaltered and rename it by typing the new name into the **Model** display box.
- You can save the model by pressing the **Save** button (floppy disc icon). If the name is pre-existing you will be prompted to confirm overwriting the old method. Press **Yes** to acknowledge, **No** to keep the old method.
- You can delete a method from the list by highlighting the method and pressing the **Delete** button (dustbin icon).

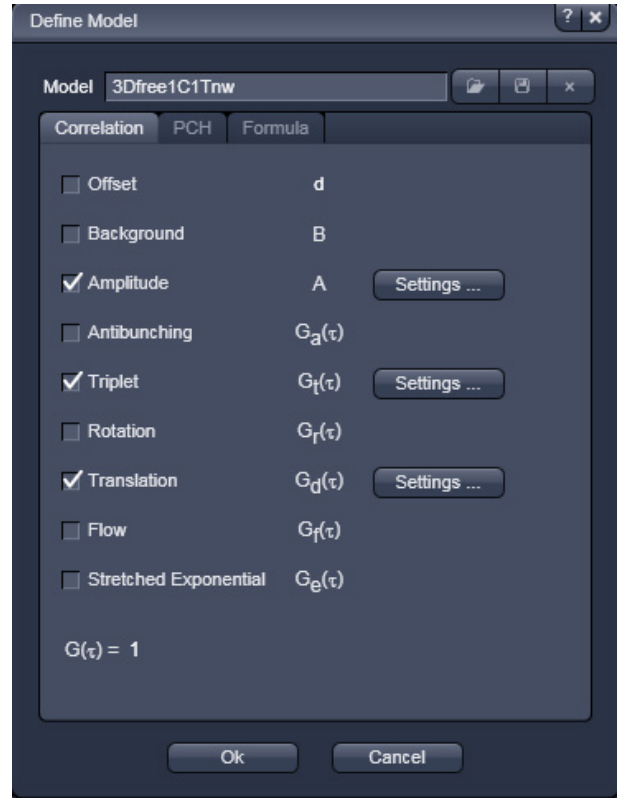


Fig. 275 Define Model panel – Correlation

### 5.3.4.3 Model Equations

In the following, the mathematical equations of the correlation functions and the fit equations will be more detailed. The acquired correlation functions must be fitted to models in order to retrieve meaningful parameters. It depends on the process, which model is the most appropriate. If the underlying process is known, the model can be chosen a priori. For example, if one studies diffusion in a membrane, a 2-D diffusion model should be applied. In other cases, the process is not known, for example, if one deals with free or anomalous diffusion. In this case, one can screen different potential models and look for the best fit taken into account the  $X^2$  value. Often two models work nearly the same, for example, a two component free diffusion model can give you as satisfactorily a fit as a one component anomalous diffusion model and without prior knowledge on the system it will be impossible to decide, which is the better one. In principle, models can be ruled out, if the fit does not work, however, a working model is only a potential candidate but does not signify it to be the correct one. Care should be taken to minimize the free parameters as much a possible to improve on the fit quality. It does not make too much sense to fit to three components without fixing parameters of at least one of them. For example, if the diffusion time of a free ligand can be determined in a pre-experiment, that value should be fixed to reduce the number of floating parameters for the evaluation of the binding experiment to its receptor.

The FCS software is designed to be flexible. That means that the user can define or assemble equations that do not make sense. Care should therefore be exerted and used formulas matched with the ones from literature to obtain meaningful results. Also, the presence of a model does not automatically mean, that the recorded data are of a quality that allows its usage. For example, anti-bunching requires a lot of care in data acquisition like long measurement times and cross-correlation to reduce dead times of the detectors and elimination of after-pulsing artefacts. It is in the responsibility of the user to set up his experiments accordingly.

#### (1) The correlation function

The auto-correlation function is defined as follows:

$$G^{\delta I}(\tau) = \frac{\langle \delta I(t) \cdot \delta I(t + \tau) \rangle}{\langle \delta I(t) \rangle^2} = \frac{\frac{1}{T} \cdot \int_0^T (\delta I(t) \cdot \delta I(t + \tau)) dt}{\frac{1}{T^2} \cdot \int_0^T (\delta I(t))^2 dt} = \frac{T \cdot \int_0^T (\delta I(t) \cdot \delta I(t + \tau)) dt}{\int_0^T (\delta I(t))^2 dt} \quad (1a)$$

or

$$G^I(\tau) = \frac{\langle I(t) \cdot I(t + \tau) \rangle}{\langle I(t) \rangle^2} = \frac{\frac{1}{T} \cdot \int_0^T (I(t) \cdot I(t + \tau)) dt}{\frac{1}{T^2} \cdot \int_0^T (I(t))^2 dt} = \frac{T \cdot \int_0^T (I(t) \cdot I(t + \tau)) dt}{\int_0^T (I(t))^2 dt} \quad (1b)$$

where  $\langle \rangle$  denotes the time average and  $\delta I(t) = I(t) - \langle I(t) \rangle$  describes the fluctuations around the mean intensity.

For long time average of  $I$  (no bleaching) the following relation exists:


$$G^I(\tau) = 1 + G^{\delta I}(\tau) \quad (1c)$$

### Definition of the cross-correlation function

The formalism for the cross-correlation function is identical to the auto-correlation function, with the exception that the signal in one channel is not compared to itself, but to a signal in a second channel. Lets assign the indices "r" and "b" for the red and blue channel, respectively, than the cross-correlation function would read as follows:

$$G_X^{\delta I}(\tau) = \frac{\langle \delta I_b(t) \cdot \delta I_r(t + \tau) \rangle}{\langle I_b(t) \rangle \cdot \langle I_r(t) \rangle} = \frac{\langle \delta I_r(t) \cdot \delta I_b(t + \tau) \rangle}{\langle I_b(t) \rangle \cdot \langle I_r(t) \rangle} \quad (1d)$$

$$G_X^I(\tau) = \frac{\langle I_b(t) \cdot I_r(t + \tau) \rangle}{\langle I_b(t) \rangle \cdot \langle I_r(t) \rangle} = \frac{\langle I_r(t) \cdot I_b(t + \tau) \rangle}{\langle I_b(t) \rangle \cdot \langle I_r(t) \rangle} \quad (1e)$$

 Note that the software for FCS calculated  $G^I$  functions, which do therefore converge to 1 and not 0. The acquired correlation functions are than compared to model equations.

### (2) Available model equations

In the following available equations used for the fits are given that define the accessible parameters. For some equations useful conversions to other parameters are listed as well. The total correlation is given by equation 2:

$$G_{tot}^I(\tau) = 1 + d + B + A \cdot \prod_k \sum_l G_{k,l}(\tau) \quad (2)$$

where **d** is the offset, **B** the background correction, **A** the amplitude and  $G_{k,l}(\tau)$  the correlation for a single process. The suffixes k and l signify correlation terms for dependent and independent processes, respectively, that are multiplied with or added to each other.

The total correlation is therefore the amplitude multiplied to the product of the single correlation terms that are dependent and hence convolute each other. This amplitude has to be corrected for background and any offset. In cases, when the processes are independent from each other, the single correlations terms add up, for example in cases where there is more than one component all bearing the same label or of bunching terms that are independent from each other. If independent and dependent processes are present, all independent terms will add up and are multiplied with the dependent terms.

One can distinguish between different classes of fluctuation processes: anti-bunching, bunching and diffusion.

## A. Amplitudes

The Amplitude of the correlation function is influenced by the offset, background and the number of particles in dependence of the geometric factor. The amplitude is also influenced by the process of correlation.

### A.1 The "1"

In a normal correlation, the curve converges to 1, in case intensities  $I$  are correlated as is the case with the FCS software. Note that in other cases, if fluctuations  $\delta I$  are correlated, the correlation function converges to 0, if no bleaching occurs.

$$G^{\delta I}(\tau) = 1 + G^I(\tau) \quad (2)$$

You can therefore easily convert  $G^I(\tau)$  to  $G^{\delta I}(\tau)$  values by adding a fixed offset of  $-1$ .

### A.2 Offset $d$

$$d = c \quad (3)$$

$c$  is any rational number that can be negative or positive.

In the FCS software the offset can be a fit parameter or a fixed value.

In some cases, especially if very slow or immobile components are present, there can be a positive offset from 1. This offset can be taken into account by fitting to  $d$ . On the other hand, if the offset is known, it can be fixed. The offset will be added to each correlation value.

### A.3 Background $B$

$$B = \left(1 - \frac{I_b}{I_t}\right)^2 \quad (4)$$

where  $I_b$  is the background intensity and  $I_t$  is the total intensity.

The FCS software treats the background always as a fixed value and never as a fit parameter. Thus the user has to define the background.

Note that the background in this case refers to a non-correlating background. If there is no background intensity,  $B = 1$ , otherwise  $B < 1$ . The background can be determined by measuring an unlabeled solution or cell at the same settings than the real experiment and recording the count rate  $I_b$ . The real experiment with the labeled species will give  $I_t$ . A non-correlating background will result in a lower amplitude and hence overestimation of molecule numbers, if not corrected for. Note the squared correction term.

**A.4 Amplitude A**

$$A = \frac{\gamma}{N} = G(0) - 1 \quad (5a)$$

where  $\gamma$  is the geometric factor accounting for the point spread function (PSF) and N the mean number of particles.

In the FCS software  $\gamma$  can be a fit or a predefined fixed value. In case  $\gamma$  is a fit value N must be fixed in the fit procedure. N is normally a fit parameter.

Please note that  $\gamma$  takes different values for different fitting models depending on the assumed intensity distribution of the point spread function (PSF):

$\gamma_c = 1.000$  (cylindrical),

$\gamma_{2DG} = 0.500$  (2-D Gaussian),

$\gamma_{3DG} = 0.350$  (3-D Gaussian),

$\gamma_{GL} = 0.076$  (Gaussian-Lorentzian).

$\gamma$  can also be calibrated, if a known concentration  $c$  of a dye is measured. In this case N can be fixed and  $\gamma$  fitted. The obtained number can be entered as the calibrated fixed number. N can be calculated from equation

$$c = \frac{N}{V \cdot L_A} \quad (5c)$$

with V being the confocal volume and  $L_A = 6.023 \times 10^{23} \text{ mol}^{-1}$  the Avogadro number.

The volume V is calculated from equation

$$V = \pi^{3/2} \cdot \omega_r^2 \cdot \omega_z \quad (5d)$$

with  $\omega_z$  axial focus radius and  $\omega_r$  the lateral focus radius. The radii themselves have to be determined by a calibration measurement using a dye with a high quantum yield and a known diffusion coefficient D from the fitted diffusion time  $\tau_d$  and the structural parameter S employing a free diffusion model with triplet state.


The following relations exist:

$$\tau_d = \frac{\omega_r^2}{4 \cdot D} \text{ for 1 photon excitation} \quad (5e)$$

$$\tau_d = \frac{\omega_r^2}{8 \cdot D} \text{ for 2 photon excitation} \quad (5f)$$

$$S = \frac{\omega_z}{\omega_r} \quad (5g)$$

Equations 5e or 5f, dependent on the excitation source, can be used to retrieve  $\omega_r$ ; with its knowledge  $\omega_z$  can be calculated from equation 5g.

 "N" can have different meanings in different fit models. For biology, normally the number of diffusing particles is of interest. In this case, if photo-physical processes (triplet, blinking, stretched exponentials) are involved, it is recommended to use their normalized forms, since then the number of molecules correspond directly to the number of diffusing particles. If photo-physical terms are not normalized, the number measured is the total number of diffusing particles and those undergoing photo-physical processes.

**B. Anti-bunching terms**

Anti-bunching is the phenomenon that a molecule cannot produce emitted photons as long as it stays in the excited state. Hence during the transition time required to drop back to the ground state, which corresponds in most of the cases to the lifetime if no other photo-physical processes are involved, no photon can be expected, which results in anti-correlation and hence a drop of the correlation function below 1.

**B.1 Independent to other terms**

$$G_a(\tau) = (1 - C - C \cdot e^{-\tau/\tau_a}) \text{ not normalized} \quad (6a)$$

$$G_a(\tau) = \left(1 - \frac{C \cdot e^{-\tau/\tau_a}}{1 - C}\right) \text{ normalized} \quad (6b)$$

where C is the amplitude and  $\tau_a$  the transition time, also referred to as the lifetime.

**B.2 Dependent in combination with other terms**

$$G_a(\tau) = (-C \cdot e^{-\tau/\tau_a}) \quad (6c)$$

C in this case is either a fit parameter or a fixed value and often takes the value 9/5.

There are two cases to be distinguished: First, if the anti-bunching is independent with other processes, than equations 6a and 6b in the non-normalized or normalized form must be used and the terms are multiplied with other correlation terms. In case the anti-bunching is treated dependent to other processes, than equation 6c is the correct one to use and the term is added to other correlation terms.

**B.3 Stretched exponential – anti-bunching**


This is a more general term adding frequency and stretched factors to the exponent.

$$G_k(t) = 1 - K_1 - K_1 \cdot e^{(-k_1 \cdot t/\tau_{k1})^{\kappa_1}} \text{ not normalized} \quad (6d)$$

$$G_k(t) = 1 - \frac{K_1 \cdot e^{(-k_1 \cdot t/\tau_{k1})^{\kappa_1}}}{1 - K_1} \text{ normalized} \quad (6e)$$

where  $K_1$  is the fraction of molecule, and  $\tau_{k1}$  the exponential decay time,  $k_1$  the frequency factor and  $\kappa_1$  the stretch factor.

$K_1$  and  $\tau_{k_1}$  are fit parameters;  $k_1$  is a fixed parameter and must be user defined;  $\kappa_1$  is either a fit parameter or can be fixed.

 Note, fixing  $k_1$  and  $\kappa_1$  to "1" results in a simple anti-bunching term.

#### B.4 Double stretched exponential – anti-bunching

This is a double exponential function, where the exponentials are subtracted.

$$G_k(t) = 1 - K_1 - K_1 \cdot e^{(-k_1 \cdot t / \tau_{k_1})^{\kappa_1}} - K_2 - K_2 \cdot e^{(-k_2 \cdot t / \tau_{k_2})^{\kappa_2}} \quad \text{not normalized} \quad (6f)$$

$$G_k(t) = 1 - \frac{K_1 \cdot e^{(-k_1 \cdot t / \tau_{k_1})^{\kappa_1}} + K_2 \cdot e^{(-k_2 \cdot t / \tau_{k_2})^{\kappa_2}}}{1 - K_1 - K_2} \quad \text{normalized} \quad (6g)$$

where  $K_1$  and  $K_2$  are the fractions of molecules, and  $\tau_{k_1}$  and  $\tau_{k_2}$  the exponential decay times,  $k_1$  and  $k_2$  the frequency factors and  $\kappa_1$  and  $\kappa_2$  the stretch factors.

$K_1$ ,  $K_2$ ,  $\tau_{k_1}$  and  $\tau_{k_2}$  are fit parameters;  $k_1$  and  $k_2$  are fixed parameters and must be user defined;  $\kappa_1$  and  $\kappa_2$  are fit parameters or can be fixed.



## C. Bunching terms

Bunching is the phenomenon of a burst of photons during a certain time interval, the duration of which is determined by photo-physical processes including triplet, blinking, flickering and protonation. These terms are exponential decay functions. Formally, they look the same, only the exponential decay might be different.

### C.1 Triplet

$$G_t(\tau) = (1 - T_t + T_t \cdot e^{-\tau/\tau_t}) \text{ not normalized} \quad (7a)$$

$$G_t(\tau) = \left(1 + \frac{T_t \cdot e^{-\tau/\tau_t}}{1 - T_t}\right) \text{ normalized} \quad (7b)$$

where  $T_t$  is the triplet fraction, that is the number of molecules undergoing triplet states and  $\tau_t$  the triplet decay time.

$T_t$  and  $\tau_t$  are fitted parameters.

Triplet is based on an un-allowed intersystem crossing from the excited to the so-called triplet state. This state lasts for 1 – 5  $\mu$ s. If the electron drops back to the ground state, no photon is emitted and hence during the triplet state the molecule is in a dark state. Triplet is indicated as a rise in the correlation amplitude, which is indicated as a deviation from the flattening curve at shorter correlation times. If not normalized, the triplet fraction contributes to the total number of molecules.

### C.2 Blinking

$$G_b(\tau) = (1 - T_b + T_b \cdot e^{-\tau/\tau_b}) \text{ not normalized} \quad (7c)$$

$$G_b(\tau) = \left(1 + \frac{T_b \cdot e^{-\tau/\tau_b}}{1 - T_b}\right) \text{ normalized} \quad (7d)$$

where  $T_b$  is the blinking fraction, that is the number of molecules in the dimmer state and  $\tau_b$  the blinking decay time of the dimmer state. Note, if the blinking term is not normalized, the number of blinking molecules will influence the total number of molecules.

$T_b$  and  $\tau_b$  are fitted parameters.

Blinking is based on the phenomenon that the electron distribution over conjugated systems can change in dependence on the local environment, for example changes in the pH, which will lead to molecules in a bright and dim or dark state. It is therefore a kinetic process that can be described in the following way with the following relations:



$$\tau_b = \frac{1}{k_F + k_R} \quad (7g)$$

$$T_b = \frac{k_F \cdot k_R \cdot (\eta_B - \eta_D)^2}{(k_F + k_R) \cdot (k_F \cdot \eta_B^2 + k_R \cdot \eta_D^2)} \quad \text{with the constraint } \eta_B > \eta_D \quad (7h)$$

with B and D representing the brighter and darker states,  $k_F$  and  $k_R$  the forward and backward reaction rates and  $\eta_B$  and  $\eta_D$  the emission yields or molecular brightness of molecule species (D or B) in Hz or the relative dimensionless brightness. In case, where darker state is completely dark ( $\eta_D=0$ ), equation 7h simplifies to

$$T_b = \frac{k_R}{k_F + k_R} \quad (7i)$$

Note that Blinking is referred to a process that does not lead to a covalent modification in the chemical bonds. If covalent changes occur the process is referred to as Flickering, which is formally treated in the same way.

### C.3 Dependent triplet and blinking

In this case the terms are just representatives for two dependent bunching terms that are linked by addition (double exponential term). Note that the triplet fraction, if present, could be potentially fitted to either of the terms.

$$G_t(\tau) = (1 - T_1 + T_1 \cdot e^{-\tau/\tau_{t1}} - T_2 + T_2 \cdot e^{-\tau/\tau_{t2}}) \quad \text{not normalized} \quad (7j)$$

$$G_t(\tau) = \left(1 + \frac{T_1 \cdot e^{-\tau/\tau_{t1}} + T_2 \cdot e^{-\tau/\tau_{t2}}}{1 - T_1 - T_2}\right) \quad \text{normalized} \quad (7k)$$

where  $T_1$  and  $T_2$  are the fractions of molecules in the triplet state, and  $\tau_{t1}$  and  $\tau_{t2}$  the triplet exponential decay times.

$T_1$ ,  $T_2$ ,  $\tau_{t1}$  and  $\tau_{t2}$  are all fitted parameters.

#### C.4 Independent triplet and blinking

In this case the terms are just representatives for two dependent bunching terms that are linked by multiplication. Note that the triplet fraction, if present, could be fitted to either of the terms.

$$G_t(\tau) = (1 - T_1 + T_1 \cdot e^{-\tau/\tau_{t1}})(1 - T_2 + T_2 \cdot e^{-\tau/\tau_{t2}}) \text{ not normalized} \quad (7l)$$

$$G_t(\tau) = \left(1 + \frac{T_1 \cdot e^{-\tau/\tau_{t1}}}{1 - T_1}\right) \left(\frac{1 + T_2 \cdot e^{-\tau/\tau_{t2}}}{1 - T_2}\right) \text{ normalized} \quad (7m)$$

where  $T_1$  and  $T_2$  are the fractions of molecules in the triplet state, and  $\tau_{t1}$  and  $\tau_{t2}$  the triplet exponential decay times.

$T_1$ ,  $T_2$ ,  $\tau_{t1}$  and  $\tau_{t2}$  are all fitted parameters.

#### C.5 Stretched exponential - bunching

In some reactions the kinetics cannot be fitted to simple exponential functions but require stretched exponentials.

$$G_k(t) = 1 - K_1 + K_1 \cdot e^{(-k_1 \cdot t / \tau_{k1})^{\kappa_1}} \text{ not normalized} \quad (7n)$$

$$G_k(t) = 1 + \frac{K_1 \cdot e^{(-k_1 \cdot t / \tau_{k1})^{\kappa_1}}}{1 - K_1} \text{ normalized} \quad (7o)$$

where  $K_1$  is the fraction of molecule, and  $\tau_{k1}$  the exponential decay time,  $k_1$  the frequency factor and  $\kappa_1$  the stretch factor.

$K_1$  and  $\tau_{k1}$  are fit parameters;  $k_1$  is a fixed parameter and must be user defined;  $\kappa_1$  is either a fit parameter or can be fixed.

Note, fixing  $k_1$  and  $\kappa_1$  to "1" results in a simple bunching term.

**C.6 Double stretched exponential - bunching**

This is a double exponential function, where the exponentials are added.

$$G_k(t) = 1 - K_1 + K_1 \cdot e^{(-k_1 \cdot \tau / \tau_{k1})^{\kappa_1}} - K_2 + K_2 \cdot e^{(-k_2 \cdot \tau / \tau_{k2})^{\kappa_2}} \quad \text{not normalized} \quad (7p)$$

$$G_k(t) = 1 + \frac{K_1 \cdot e^{(-k_1 \cdot \tau / \tau_{k1})^{\kappa_1}} + K_2 \cdot e^{(-k_2 \cdot \tau / \tau_{k2})^{\kappa_2}}}{1 - K_1 - K_2} \quad \text{normalized} \quad (7q)$$

where  $K_1$  and  $K_2$  are the fractions of molecules, and  $\tau_{k1}$  and  $\tau_{k2}$  the exponential decay times,  $k_1$  and  $k_2$  the frequency factors and  $\kappa_1$  and  $\kappa_2$  the stretch factors.

$K_1$ ,  $K_2$ ,  $\tau_{k1}$  and  $\tau_{k2}$  are fit parameters;  $k_1$  and  $k_2$  are fixed parameters and must be user defined;  $\kappa_1$  and  $\kappa_2$  are fit parameters or can be fixed.

This term is often required to fit protonation, with the second stretch factor and the frequency factors are set to "1".

**D. Diffusion terms**

Diffusion is driven by Brownian motion. We can distinguish translational, rotational and flow diffusion.

**D.1 Rotational diffusion**

In the most general form, rotation can be described as the sum of 5 exponential terms

$$g_r(\tau) = 1 - R_a + R_a \cdot \sum_{m=1}^5 c_m \cdot e^{-r_m \cdot \tau / \tau_{r,m}} \quad (8a)$$

with  $R_a$  being the amplitude,  $c_m$  the relative amplitude,  $r_m$  the frequency factor and  $\tau_{r,m}$  the rotational diffusion time.

However, there are special cases that are of more use.

In symmetric rotation, the general formula reduces to:

$$G_r(\tau) = 1 - R_a + R_a \cdot e^{-\tau / \tau_r} \text{ not normalized} \quad (8b)$$

$$G_r(\tau) = 1 + \frac{R_a \cdot e^{-\tau / \tau_r}}{1 - R_a} \text{ normalized} \quad (8c)$$

with  $R_a$  being the rotational amplitude and  $\tau_r$  the rotational diffusion time.

$R_a$  and  $\tau_r$  are both fit parameters.

If rotation occurs dependent from other processes, the formula used as an additive term is defined as:

$$G_r(\tau) = R_a \cdot e^{-\tau / \tau_r} \quad (8d)$$

$R_a$  in this case is either a fit parameter or a fixed value and often takes the value 4/5.

In case of asymmetric rotation, the term is as follows:

$$G_r(\tau) = 1 - R_a + R_a \cdot (c_1 \cdot e^{-r_1 \cdot \tau / \tau_{r,1}} + c_2 \cdot e^{-r_2 \cdot \tau / \tau_{r,2}}) \text{ not normalized} \quad (8e)$$

$$G_r(\tau) = 1 + \frac{R_a \cdot (c_1 \cdot e^{-r_1 \tau / \tau_{r,1}} + c_2 \cdot e^{-r_2 \tau / \tau_{r,2}})}{1 - R_a} \text{ normalized} \quad (8f)$$

with  $R_a$  being the amplitude,  $c_1$  and  $c_2$  relative amplitudes,  $r_1$  and  $r_2$  frequency factors and  $\tau_{r,1}$  and  $\tau_{r,2}$  the rotational diffusion times.

$R_a$ ,  $\tau_{r,1}$  and  $\tau_{r,2}$  are fitted parameters;  $c_1$  and  $c_2$  as well as  $r_1$  and  $r_2$  are fixed values and must be user defined.

Rotational frequencies take often the following values:

$r_1$	1
$r_2$	10/3

The relative amplitudes dependent on the polarization of the excitation light and the analyzer in the emission beam path and are as follows:

Ex	lin. pol.	lin. pol.	lin. pol.	unpol.	unpol.	unpol.
Em	parallel	perpendicular	all	parallel	perpendicular	all
$c_1$	80	20/9	860/9	5/9	215/9	20
$c_2$	64/9	4	4	16/9	1	1

**D.2 Translational diffusion**

In its general form, translational diffusion is defined as:

$$G_d(\tau) = \left( \sum_{i=1}^3 \frac{\Phi_i}{\left(1 + \left(\frac{\tau}{\tau_{d,i}}\right)^{\alpha_i}\right)^{e_{d1}} \cdot \left(\left(1 + \left(\frac{\tau}{\tau_{d,i}}\right)^{\alpha_i} \cdot \frac{1}{S^2}\right)^{1/2}\right)^{e_{d2}}}\right) \text{ with the constraint } \sum_i \Phi_i = 1 \quad (8g)$$

with  $\tau_{d,i}$  representing the diffusional correlation time of molecule species  $i$ ,  $S$  the structural parameter that is the ratio of axial to lateral focus radii,  $\alpha_i$  the anomaly parameter or temporal component of molecule species  $i$ ,  $e_{d1}$ ,  $e_{d2}$  fixed exponentials to define dimensionality of diffusion (1-D:  $e_{d1}=1/2$ ;  $e_{d2}=0$ ; 2-D:  $e_{d1}=1$ ;  $e_{d2}=0$ ; 3-D:  $e_{d1}=1$ ;  $e_{d2}=1$ )

$e_{d1}$  and  $e_{d2}$  are fixed values and have to be user defined. The following values define 1-, 2- and 3-D diffusion:

$e_{d1}$	$e_{d2}$	dimensionality
1/2	0	1-D
1	0	2-D
1	1	3-D

Note that in the FCS software these values are automatically selected with the choice of dimensionality.

$S$  is either a fit parameter or a fixed value. It is an instrumental parameter and can be determined by a calibration experiment using a dye solution with a known diffusion as a fit result.

$\alpha_i$  is either a fitted value for anomalous diffusion or a fixed value (set to "1") for free diffusion. The following relation exists

$\alpha$	Diffusion process
=1	Free diffusion
<1	Anomalous sub-diffusion
>1	Anomalous super-diffusion

Note that  $\alpha_i$  is set automatically to "1", if free diffusion is selected. If anomalous diffusion is selected, the parameter will float.

$\tau_{d,i}$  are fitted parameters. They can be converted to diffusion coefficients  $D_i$  using formulas 5e or 5f. The FCS software allows you to directly fit to  $D_i$  values, but in this case the lateral radius  $\omega_r$  has to be specified as a fixed value.

Please note that in the case of anomalous diffusion the following relations exist:

$$\tau^{\alpha}_{d,i} = \frac{\omega_r^2}{\Gamma_{2,i}} \quad 1 \text{ photon excitation} \quad (8h)$$

$$\tau^{\alpha}_{d,i} = \frac{\omega_r^2}{2 \cdot \Gamma_{2,i}} \quad 2 \text{ photon excitation} \quad (8i)$$

with  $\Gamma$  representing the transport coefficient of the fractional time dimension.

Please note the following relation between  $D$  and  $G$ :

$$D(t) = \Gamma \cdot t^{\alpha-1} \quad (8j)$$

If activating the fitting to the diffusion coefficient in the FCS the  $\Gamma$  values have to be calculated from the  $D$  values by the following conversion:

$$\Gamma = 4 \cdot D \quad (8k)$$

The  $\Phi_i$  values are fit parameters. They account for different brightness of different components. In principle, if molecules of different brightness are present, the apparent molecular brightness is defined as

$$\eta = \frac{\sum_{i=1}^3 f_i \cdot \eta_i^2}{\sum_{i=1}^3 f_i \cdot \eta_i} \quad (8l)$$

with  $\eta_i$  being the brightness of the molecules in kHz or the dimensionless relative brightness values. The brightness of the species has to be determined beforehand in control experiments.



Note that the brightness contributes as the square to the correlation function, in other words a double as bright molecule will contribute 4 fold more. Therefore, the fitted number of molecules must be corrected to obtain the real number  $N_{diff}$  of diffusing particles; please note that to obtain the diffusing particle number directly, other terms should be used in their normalized form:

$$N_{diff} = N \cdot \frac{\left(\sum_{i=1}^3 f_i \cdot \eta_i\right)^2}{\sum_{i=1}^3 f_i \cdot \eta_i^2} \quad (8m)$$

If one wants to know the true fraction  $f_i$  of each species, values those can be retrieved with the known brightness from the relation

$$\Phi_i = \frac{f_i \cdot \eta_i^2}{\sum_{i=1}^3 f_i \cdot \eta_i^2} \quad \text{with the constraints } \sum_i \Phi_i = 1 \quad \text{and} \quad \sum_i f_i = 1 \quad (8n)$$

If there is no brightness difference between the components,  $\Phi_i$  will become  $f_i$ .

You can fit directly to the fractions even in case of different brightness values. In this case, the brightness values have to be fixed parameters and defined by the user. The fit formula converts from equation 5a in combination with 8g taking into account the corrected amplitude to equation 8o:

$$G_{tot}(\tau) = \frac{\gamma}{N} \cdot \frac{\sum_{i=1}^3 f_i \cdot \eta_i^2}{\left(\sum_{i=1}^3 f_i \cdot \eta_i\right)^2} \cdot \left( \frac{\sum_{i=1}^3 \frac{f_i \cdot \eta_i^2}{\sum_{i=1}^3 f_i \cdot \eta_i^2}}{\left(1 + \left(\frac{\tau}{\tau_{d,i}}\right)^{\alpha_i}\right)^{e_{d1}} \cdot \left(1 + \left(\frac{\tau}{\tau_{d,i}}\right)^{\alpha_i} \cdot \frac{1}{S^2}\right)^{\frac{1}{2} e_{d2}}}\right)^{e_{d1}} = \frac{\gamma}{N} \cdot \left( \frac{\sum_{i=1}^3 \frac{f_i \cdot \eta_i^2}{\left(\sum_{i=1}^3 f_i \cdot \eta_i\right)^2}}{\left(1 + \left(\frac{\tau}{\tau_{d,i}}\right)^{\alpha_i}\right)^{e_{d1}} \cdot \left(1 + \left(\frac{\tau}{\tau_{d,i}}\right)^{\alpha_i} \cdot \frac{1}{S^2}\right)^{\frac{1}{2} e_{d2}}}\right)^{e_{d2}} \quad (8o)$$

with fixed brightness values  $\eta_i$ .

**D.3 Flow**

Flow signifies active transport either via cytoplasmic movement or directed transport.

If flow occurs in the absence of translational diffusion, the term is defined as follows:

$$G_f(\tau) = e^{-\left(\frac{\tau}{\tau_f}\right)^2} \quad (8p)$$

In the presence of translational diffusion, the term alters to:

$$G_f(\tau) = e^{-\frac{\left(\frac{\tau}{\tau_f}\right)^2}{1+\left(\frac{\tau}{\tau_d}\right)^2}} \quad (8q)$$

with  $\tau_f$  representing the average residence time for flow and  $\tau_d$  the diffusion correlation time.

Note, in the FCS software, the correct term is automatically loaded in dependence on the absence or presence of a translational term.

With the knowledge of the lateral radius  $\omega_r$  given as a fixed value, the software allows to fit directly to the velocity  $v$  instead of the average residence time. The following relation exists:

$$v = \frac{\omega_r}{\tau_f} \quad (8r)$$


#### 5.3.4.4 Definition of a Model

- To define a model press the **Term** tab of the term you want to be part of your final correlation equation. The tab will be highlighted in blue. Press the tab again to remove the term from the final equation. The tab becomes grey. You can choose from:
  - **Offset d**: Deviation from 1
  - **Background B**: Unspecific non-correlating background
  - **Amplitude A**: Number of molecules and geometric factor
  - **Antibunching  $G_a(\tau)$** : Antibunching correlation term
  - **Triplet  $G_t(\tau)$** : Exponential correlation terms for triplet state, blinking, flickering or other bunching correlation terms
  - **Rotation  $G_r(\tau)$** : Rotational diffusion correlation terms
  - **Translation  $G_d(\tau)$** : Translational diffusion correlation terms
  - **Flow  $G_f(\tau)$** : Flow correlation terms
  - **Stretched exponential  $G_e(\tau)$** : Stretched exponential correlation terms for kinetics
- All highlighted terms are assembled into the final equation that is displayed in  **$G(\tau)=$**  display area.
- For a selected term the **Settings** button becomes available. Press the **Settings** button to open the **Settings** panel. Press the **Settings** button again to close it.
- The **Settings** panel allows you to choose specific equations and assign values to parameters, if applicable. The **Settings Description** box provides information on the parameter or displays the formula of the equation. In addition it gives useful conversions of the fitted parameter to other interesting parameters.

The following settings are available:

#### Offset

- You can set the offset (Fig. 276) to 0 by pressing the **Normalized** button.
- You can define an offset by pressing the **Calibrated** button. This enables you to type in a value in the **Calibrated** selection box, or by setting a value using the arrows.

 Note, the offset can have positive or negative numbers and the value specified will be added to all correlation values.

The **Offset** description box gives you information on the offset.

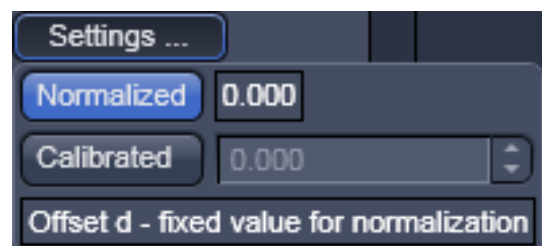


Fig. 276 Offset Settings panel

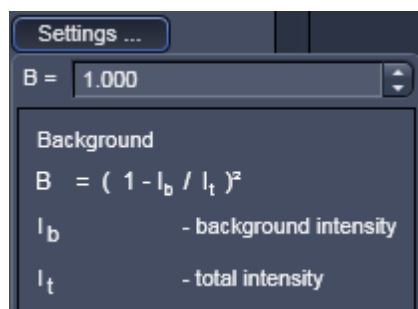


Fig. 277 Background Settings panel

### Background

- You can set an offset by setting a value in the **Background** selection box (Fig. 277). Either type in a value or use the arrows.

The description box gives you information on the background.

- If there is no background selected, the background correction factor will be set to 1.

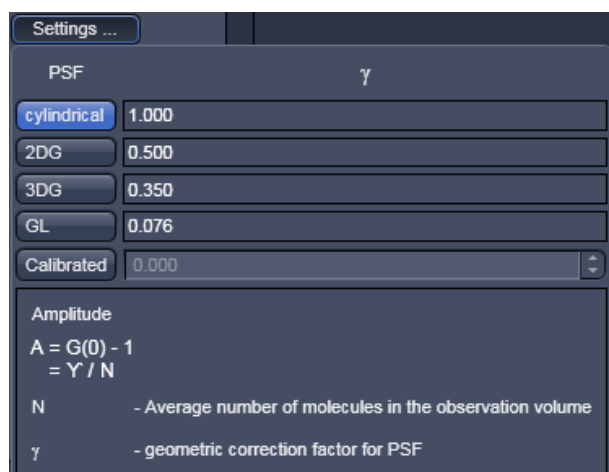


Fig. 278 Amplitude Settings panel

### Amplitude

- You can set a value for the geometric factor  $\gamma$ , which describes the point-spread function (Fig. 278).
- By pressing the **cylindrical**, **2DG**, **3DG** and **GL** buttons you can select a cylindrical, 2 dimensional Gaussian, 3 dimensional Gaussian (3DG) and Gaussian-Lorentzian (GL) PSF, respectively. If you press the Calibrate button, you can type in a user defined number in selection box or use the arrows to set a value.

The description box gives you information on the amplitude.

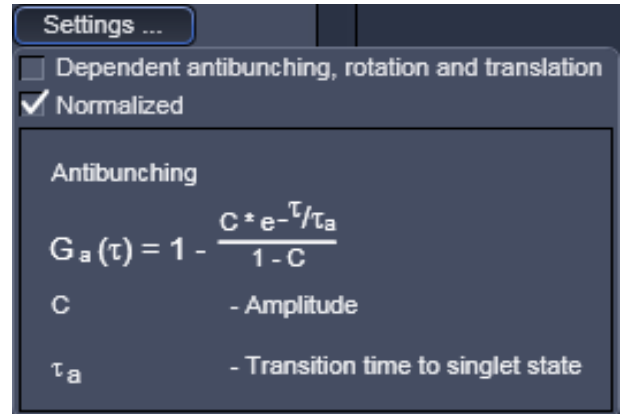
- At least one the  $\gamma$  factor or the number of molecules N have to be fixed in the fit procedure.

**Antibunching**

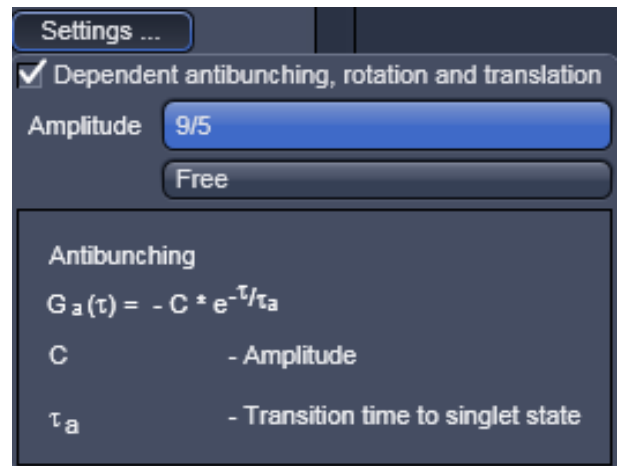
You can select the anti-bunching term in its normalized form by checking the **Normalized** check box or in its non-normalized form by unchecking the box (Fig. 279).

You can select the **Dependent antibunching, rotation and translation** form by checking the respective box. This equation will be used as an additive term to rotational and translational diffusion terms. You have the option to leave the amplitude value free to float or to set the value to 9/5 by pressing the **Free** or **9/5** buttons, respectively. The active selection will be highlighted in blue (Fig. 280).

The description box gives you information on the anti-bunching.



**Fig. 279** Antibunching Settings panel



**Fig. 280** Antibunching Settings panel - Dependent antibunching, rotation and translation active

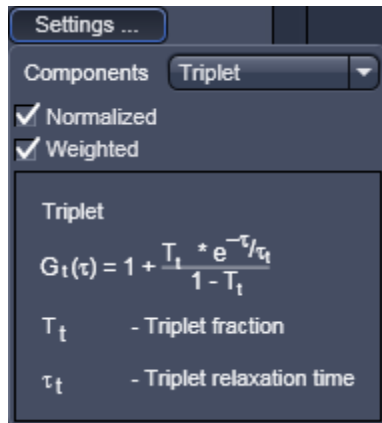


Fig. 281 Triplet Settings panel

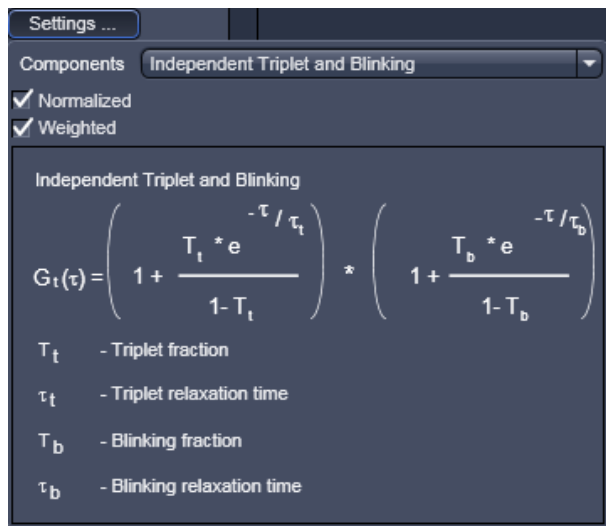


Fig. 282 Triplet Settings panel, independent triplet and blinking terms selected

## Triplet

The triplet represents bunching terms that are exponential decay functions.

You can select the triplet term in their normalized form by checking the **Normalized** check box or in their non-normalized form by unchecking the box (Fig. 281).

You can choose, if you want to the bunching terms to be weighted or not by checking or unchecking the **Weight** box. If no weights are applied, the fit follows the measured curve to minimize  $\chi^2$ . If no boundary values are set for the relaxation times, noise might also be followed and triplet fractions might show up to be too high. If weights are applied, noise is followed less. The following weight equation is used:

$$Weight(t) = 1 + 10^{-t(i)/3.2 \times 10^{-6}}$$

You have several options for the bunching terms which you can select by the **Components** drop down menu:

Triplet: 1 exponential function

Blinking: 1 exponential function

Independent Triplet and Blinking: Sum of 2 exponential functions

Dependent Triplet and Blinking: Product of 2 exponential functions (Fig. 282)

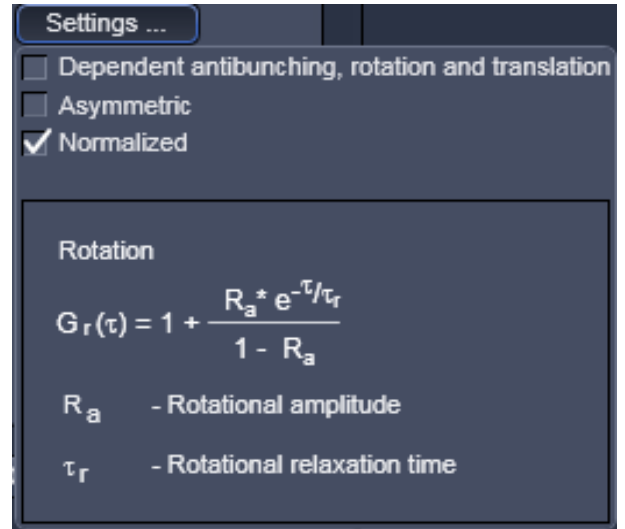
The name of the selected term is shown in the **Components** display box.

The description box gives information on the bunching terms.

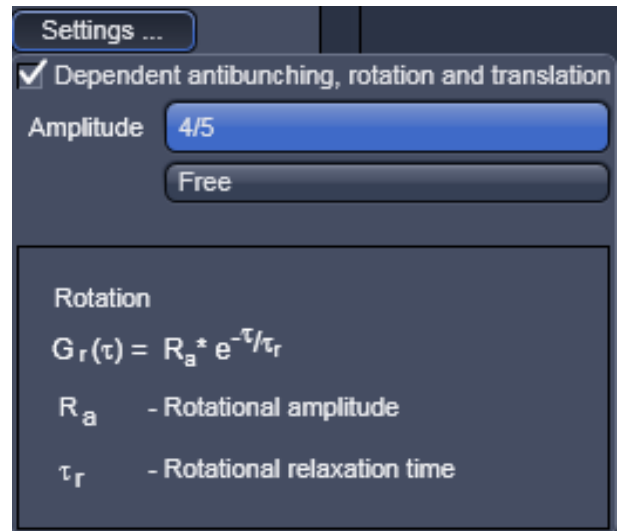
**Rotation**

You can choose between normalized and non-normalized rotation functions by selecting / deselecting the **Normalized** check box (Fig. 283).

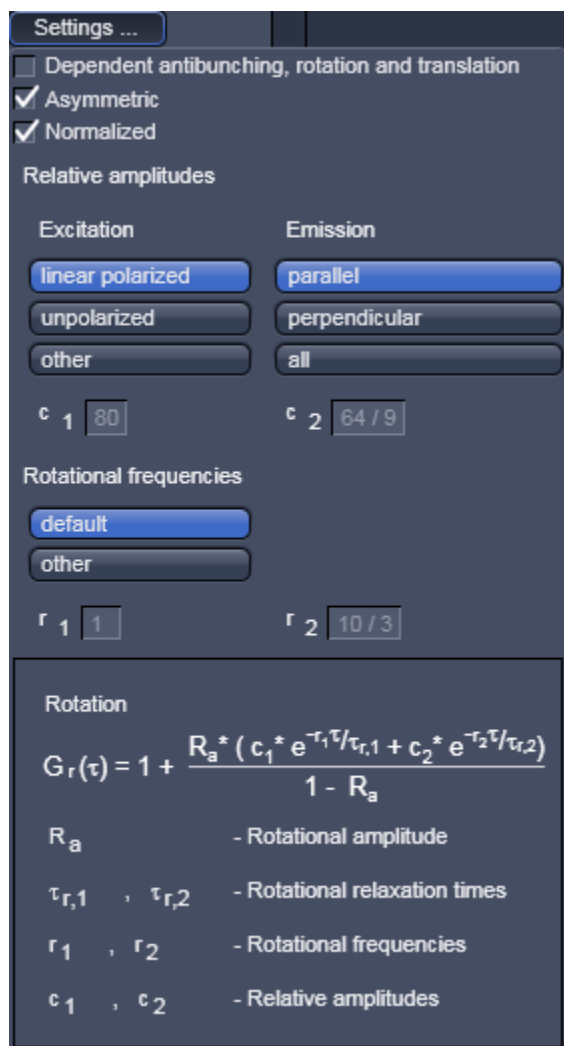
You can select the **Dependent antibunching, rotation and translation** by checking the respective box. This equation will be used as an additive term to anti-bunching and translational diffusion terms. You have the option to leave the amplitude value free floating or setting it to 4/5 by pressing the **Free** or to **4/5** buttons (Fig. 284). The active option will be highlighted in blue.



**Fig. 283** Rotation Settings panel



**Fig. 284** Rotation Settings panel, Dependent antibunching, rotation and translation active



**Fig. 285**      **Rotation Settings panel,**  
**Asymmetric rotation checked**

You can choose between symmetric rotation (1 exponential term) and asymmetric rotation (double exponential term) by selecting / deselecting the **Asymmetric** check box (Fig. 285).

If the **Asymmetric** box is checked, you can define relative amplitudes and rotational frequencies (note, these parameters are no fit values and have to be defined by the user).

Relative amplitudes are defined by selecting the excitation polarization (**linear polarized** or **unpolarized**) and the emission detection (**parallel**, **perpendicular** or **all**), by pressing the corresponding tabs, which will result in the corresponding values displayed in the **c1** and **c2** display boxes. Alternatively, if **others** is activated, you can type in user defined values.

Rotational frequencies can be selected by pressing the **Default** tab to load the default values. The corresponding values will be shown in the **r1** and **r2** display boxes. By pressing the **other** tab, user defined values can be entered.

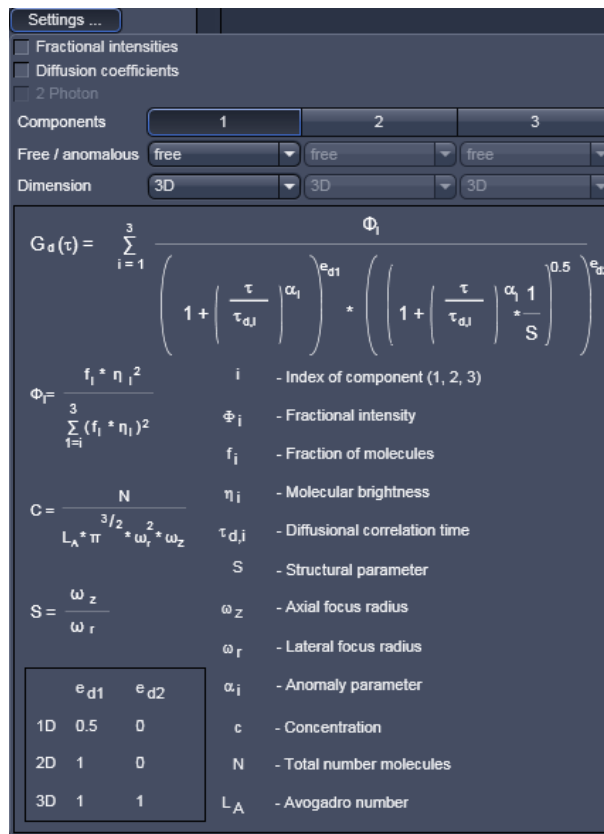
The description box gives information on the rotational diffusion terms.



**Translation**

You have the following possibilities for setting parameters (Fig. 286):

- You can either fit to fractions (used normally when no brightness differences are observed between different components) or to fractional intensities, by unticking or ticking the **Fractional Intensities** option check box respectively. In the latter case, you have to provide the absolute or relative brightness values of the components, which are entered into the **Molecular brightness** selection boxes.
- You can either fit to the diffusion time, or you can directly fit to the diffusion coefficient by unticking or ticking the **Diffusion coefficients** check box, respectively. In the latter case you have to provide the dimension of the radius of the confocal volume in the  $\omega_r$  selection box. Either type in a value or use the arrow keys.
- You must also specify if you use two photon excitation by checking the **2 Photon** check box, if since that will influence the fit formula in the case the **Diffusion coefficients** option was chosen.
- You can select the numbers of components (1, 2 and 3) by pressing the **Components 1, 2** or **3** buttons. The number of active components will be highlighted in blue.
- For each component you can select free or anomalous diffusion in the pull down menus of the **Free/anomalous** selection box.
- For each component you can set the dimensionality of diffusion in the pull down menus of the **Dimension** selection boxes. You can toggle between **1-D, 2-D** and **3-D**.
- For each component you can enter brightness values in the **Brightness** select boxes. These values are only displayed, if the **Fractional Intensities** option is selected. You can type in absolute values (that must have the same units) or relative values.



**Fig. 286 Translation Settings panel**

The description box gives information on the translational diffusion terms.

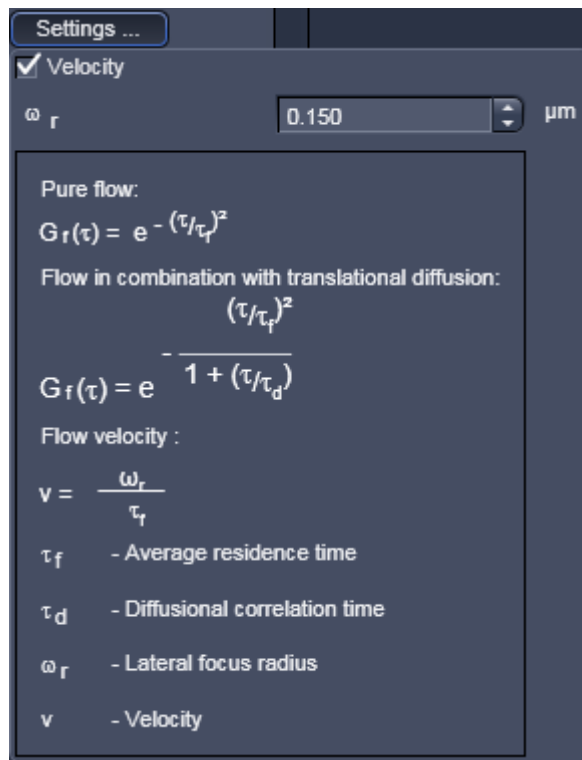


Fig. 287 Flow Settings panel

## Flow

You can determine, if you want to fit to the diffusion time or to the velocity directly by un-ticking or ticking the **Velocity** check box (Fig. 287). In the latter case you have to provide the radial dimension of the confocal volume in the  $\omega_r$  selection box. Type in the number or use the arrow keys.

The description box gives you information on the flow terms. Note, that the system automatically toggles between the pure flow and flow in combination with translational diffusion in cases where the **Translation** term is deactivated or activated, respectively.


### Stretched exponential

You can select between bunching and anti-bunching terms by pressing the **Bunching** or **Antibunching** buttons, respectively (Fig. 288).

You can select between 1 (mono exponential) or 2 (double exponential) stretched exponential terms by pressing the **Components 1** or **2** buttons. The active option will be displayed in blue

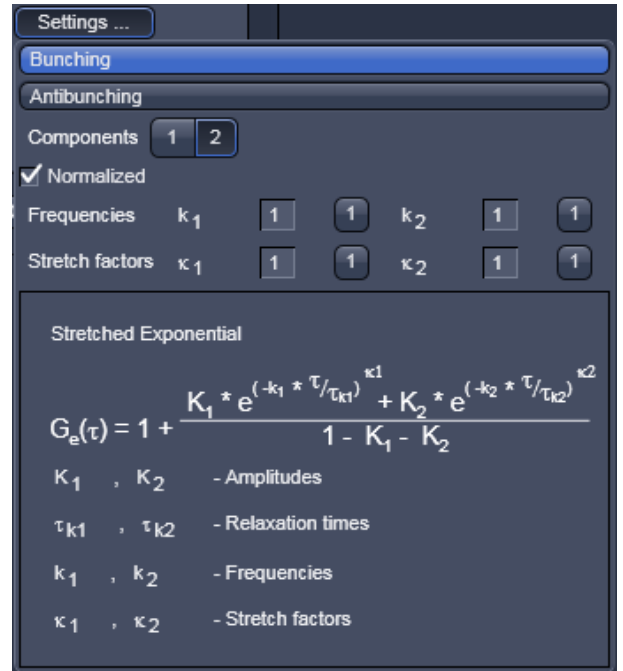
You can select between normalized and non-normalized terms by selecting / deselecting the **Normalized** check box.

You can select between dependent and independent stretched exponentials by choosing from the **Components** drop down menu. This becomes only available, if two components are active.

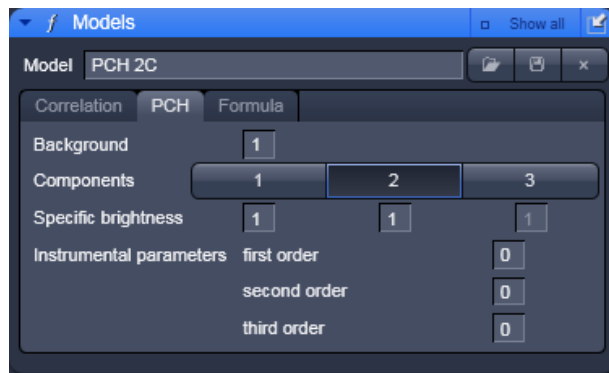
 Note, the frequencies and stretch factors are no fit parameters and must be defined in the **Frequencies**  $k_1$  and  $k_2$  as well as the **Stretch factors**  $\kappa_1$  and  $\kappa_2$  display boxes. Either enter a value or press the **1** button for the default setting.

The description box will give information on the stretched exponential terms.

For two components, only the formula for dependent processes is presently available.



**Fig. 288** Stretched exponential Settings panel



**Fig. 289** Model panel, PCH tab

### 5.3.4.5 PCH

In the **PCH** (Photon Counting Histogram) panel you can determine concentrations and the molecular brightness of molecules.

- Click on the **PCH** tab to open the PCH control panel (Fig. 289).

You have the following options:

- You can enter a background value, if you know the background in the **Background** display box. Enter a zero, if you assume no background. The background is no fit parameter.
- You can choose between 1, 2 or 3 components by activating the **Components 1, 2** and **3** buttons, respectively for each activated component you can enter a brightness value in Hz in the **Specific brightness** enter boxes. If you don't know the brightness, enter 1.
- You can enter **Instrumental parameters** values in the respective **first order, second order** and **third order** enter boxes. These values have to be determined in independent calibration experiments using a defined dye solution with a known brightness. The parameters correct for the deviation of the confocal volume from a true Gaussian distribution. Normally, only a correction for the first order parameter is necessary and recommended. Hence, in the calibration fit you will keep the first order parameter free and the second and third parameters fixed to zero. You can enter the determined first order number and fix it for later measurements.

### 5.3.4.6 Formula

The Formula panel allows you to define your own fit equation.

- Press the **Formula** tab to open the Formula panel (Fig. 290). Click any other tab to leave the panel.

In the **Formula** panel you will have a keyboard in the editor area which you can use to edit your formula. You can also type in directly in the **Formula** display box.

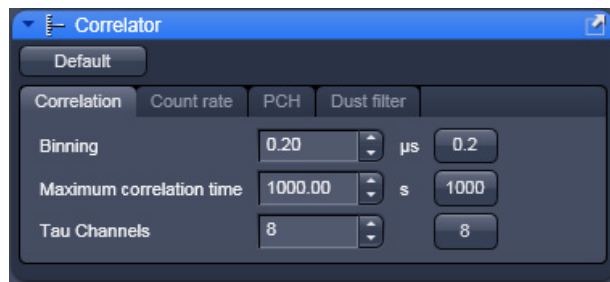
All variables that are defined at the beginning are taken as fixed variables, all others as fit parameters. If variables are defined you have to finish with the return key. Each defined variable must have an assigned number. This number will substitute for the variable in the equation.

A formula has always to be started with G as the dependent variable in the form of  $G(x)=$ , x any arabic letter. The formula is continuously parsed and any expected operation indicated in the description box at the bottom. The independent variable x is considered to have the SI unit [s] and the same holds true for any dependent parameter to it.

After finishing the formula by clicking into the display box in a line other than the end of the formula any remaining syntax errors will be displayed. If there are no syntax errors parameters and operations will be indicated.



Fig. 290 Model panel, Formula tab



**Fig. 291** Correlator tool – Correlation active

### 5.3.5 Setup – Correlator

In the **Correlator** tool you can define the fit and acquisition parameters for the measurement.

- Click on the **Correlation** tab to open the **Correlation** panel (Fig. 291). Click on any other tab to leave the panel.

All changed settings can be reset to the default settings by pressing the **Default** button.


You have the following options:


#### (1) Correlation


The **Correlation** panel allows you to specify, how the raw data will be processed for correlation analysis.


- Click on the **Correlation** tab (Fig. 291) to open the **Correlation** panel. Click any other tab to leave the panel.

Here you can set the initial correlator **Binning** time (in  $\mu\text{s}$ ), the initial number of direct Tau channels and the maximum Tau time used for the Multiple Time Algorithm. Adjust the numbers in the **Binning** (in  $\mu\text{s}$ ), **Maximum correlation time** (in s) and **Tau Channels** display boxes, respectively. You can either directly enter values or use the arrows. Default values can be entered individually by pressing the **0.2**, **1000** and **8** buttons. Please note that with the default settings, the algorithm works the fastest.

 The correlator **Binning** time determines the minimal bin time used in the correlation analysis and also the start correlation time, which will be identical to minimal bin time.

 The **Maximum correlation time** defines the end correlation time. It cannot exceed the measurement time. Hence, the value will only be used if equal to or smaller than 2/3 of the measurement time, if greater 2/3 of the measurement time will be used automatically.

 The correlator **Tau channels** define the number of linear increased Tau channels per multiple Tau step.

 The algorithm for auto-correlation functions is as follows. In the first correlation step all events within a certain correlation interval  $T$  are counted. The default  $T$  in the first correlation step ( $n=0$ ) equals 200 ns, which is 4x the maximum sampling rate of 50 ns, as limited by the dead time of the APDs and the electronics.  $T$  will be changed by the entry in the **Binning** display window. This corresponds to a clock speed of 20 MHz. Thus, for this correlation interval a maximum of 4 events can be counted. These events / correlation intervals are shifted against themselves for a time interval  $t$ . The first  $t$  equals the first  $T$  value, as a default 200 ns = 0.2 ms.  $t$  will be changed by the entry in the **Binning** display window.  $T$  is linearly increased by step sizes of 200 ns (or the entered value) for 8 times (direct tau) and than for another 8 times (multiple Tau), i.e. the maximum correlation time in the first step is  $16 \times 0.2 \text{ ms} = 3.2 \text{ ms}$  using the default settings. The direct and shifted events / correlation intervals are multiplied interval for interval and the products are added


together and normalized. The normalization result is defined as:  $(\text{result} \times \text{received clocks}) / (\text{pulse}^2)$  for auto-correlation or  $(\text{result} \times \text{received clocks}) / (\text{pulseA} \times \text{pulseB})$  for cross-correlation. The received clocks counted equal  $4 \times$  the number of correlation intervals, which are defined by the measurement time. At the end the relevant data for the next correlation step are processed. Here, the correlation interval is increased by a factor of 2. Hence, the correlation interval (T) in the n-th correlation step is  $T = 0.2 \text{ ms} \times 2^n$  for the default settings. The initial lag time for a certain correlation step corresponds to the last lag time of the previous correlation step added to the respective correlation interval. This value is then linearly increased 8 times. Therefore after step n, the correlation or lag time (t) ultimately corresponds to  $t = 16 \times 0.20 + 8 \times 0.2 \times 2^n \text{ ms}$ . The doubling of the correlation interval is performed on default 25 times. Thus the maximum is:  $t = 16 \times 0.2 + 8 \times 0.2 \times 2^{25} \text{ ms}$ .


## (2) Count rate

The **Count rate** panel allows you to specify the binning time used for the count rate trace.

- Click on the **Count rate** tab to open the **Count rate** panel (Fig. 292). Click any other tab to leave the panel.

You can either check the **Automatic** check-box, in which case dynamic binning will be applied, or you can de-activate the check box and enter a number of a constant binning time (in **ms**) in the **Binning** display window. You can either type in values or use the arrows. Units are displayed at the right of the display box. The default value of 1 ms can be selected by pressing the **1** button.

 If **Automatic count rate binning** is applied, the system averages three data points and rebins then data in dependence of the measurement time. The diagram will have a mean with fluctuations above and below the mean. In constant binning, data points are not averaged. This will result in a baseline with fluctuations above.

 In (automatic) dynamic binning the count rate trace will be adjusted to the measurement length. The count rate trace represents the averaged binned count rate versus measurement time, in other words photons / second therefore intensity. The bin window in dynamic binning now depends on the measurement time, whereby the bin window doubles, if 500 values are exceeded. In the first step, the binning time is 3.2 ms. For the next steps, the binning time ( $t_b$ ) becomes  $t_b = 3.2 \text{ ms} \times 2^n$ . The measurement time ( $t_m$ ), at which the binning time doubles is calculated according to  $t_m = 3.2 \text{ ms} \times 500 \times 2^n$ . In automatic binning mode, the **Binning** display window and the **1** default button will not be accessible.

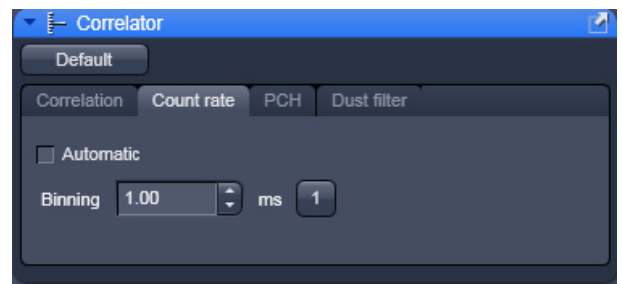


Fig. 292 Correlator tool - Count rate active

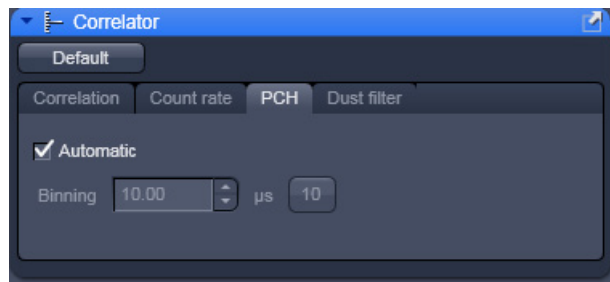



Fig. 293 Correlator tool - PCH active

### (3) PCH

In **PCH** panel the binning time used for the photo counting histogram can be selected.

- Click on the **PCH** tab to open the **PCH** panel (Fig. 293).

You can either check the **Automatic** check-box, in which case 32 different binning times will be used, or you can de-activate the check box and enter a number of a constant binning time (in  $\mu\text{s}$ ) in the **Binning** display window. You can either type in values or use the arrows. Units are displayed at the right of the display box. The default value of 10  $\mu\text{s}$  can be selected by pressing the **10** button.

 In automatic binning mode, binning starts with a value of 50 ns, which is doubled 32 times. So binning times are  $50 \times 2^n$ , with  $n=1$  to 32. The histogram with the best dynamic range (three standard deviations) will be selected and displayed. In automatic binning mode, the **Binning** display window and the **10** default button will not be accessible.

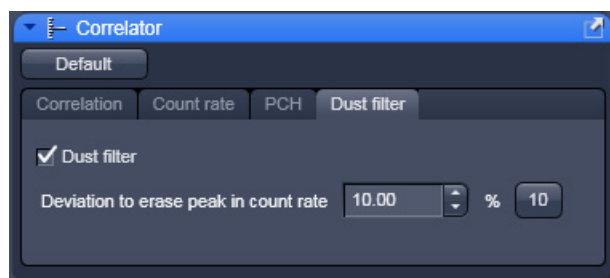


Fig. 294 Correlator tool - Dust filter active

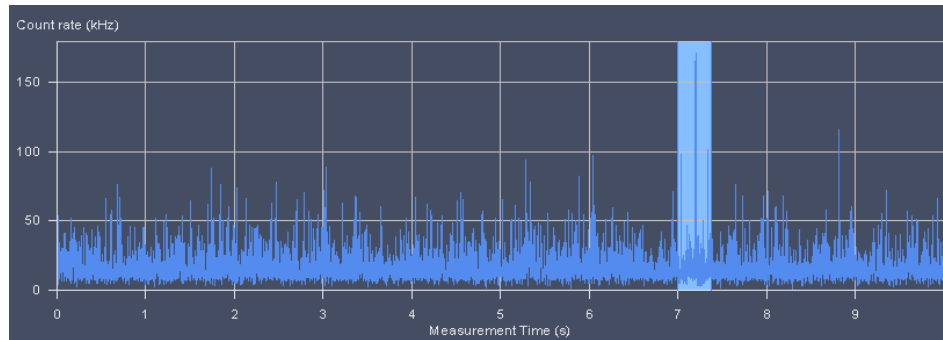
### (4) Dust filter

The **Dust filter** panel allows you to activate an electronic dust filter that will be active in operation during the measurement. You can define a threshold in the **Count rate** intensity that, if exceeded, will lead to a removal of the corresponding count rate region from the correlation analysis (Fig. 375).

- Click on the **Dust filter** tab to open the **Dust filter** panel (Fig. 294).
- Switch on or off the dust filter by ticking/unticking the check box.
- A threshold in % is set by typing in a value into or by using the arrows of the **Deviation to erase peak in Count rate** display window. All measurement points within a binned count rate time window having a deviation of more than the specified value from the average count rate will be cut out and not used for the correlation analysis (Fig. 295). The default value of 10 % can be activated by pressing the **10** button.



- ☞ Please note that the cut off count rate is defined as a value exceeding the average count rate during a certain measurement period (bin window) by a certain percentage. Thus, the consecutive fast succession of low peaks might accumulate the same count rate as one high peak within a certain period of time and hence, the cut off is not defined by the peak height but rather by the counts per binning time.



**Fig. 295** Count rate trace with cut out regions

### Dust filter

If the integrated count rate over a certain count interval will exceed the average count rate by that threshold, this special interval is discarded for correlation analysis. For example, if the system detects a count rate in a certain time interval that exceeds the average count rate by over 30 % and the threshold was set at 30, this interval will be discarded for correlation analysis. The time intervals before and after the discarded region are separately correlated and the results averaged. These holds also true, if more than one region is discarded. In this case all the single regions that are separated by cut our regions are separately correlated and the resulting average will be displayed.

- ☞ Note, that calculation of an average will be performed at the beginning of the measurement. If peak count rates will come at the beginning, this kind of dust filter does not work. Also, due to the necessity to average signals over a certain integration time, more than only the peak area will be discarded. Another outcome of the necessity to average the count rate signal is that several small peaks following close to each other will be treated as a huge peak and might be cut out. This means, in the **Automatic cut** mode accumulated count rates rather than peaks are removed. For cross-correlation experiments, any of the regions discarded in either autocorrelation function will not be used. Cut off regions are framed by stippled boxes and appear matted in the **Count Rate** window.

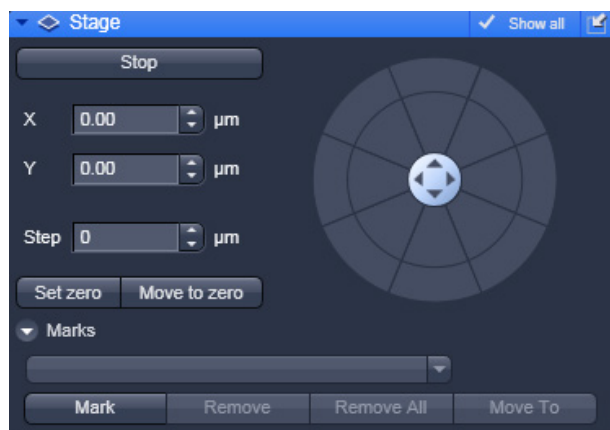


Fig. 296 Stage panel

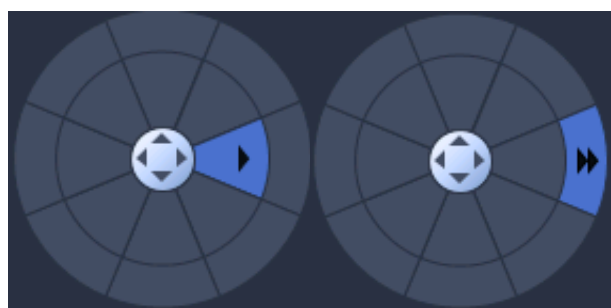


Fig. 297 Compass rose with mouse pointing to an inner (left) and outer (right) section

### 5.3.6 Navigation – Stage

- Click on the **Stage** tool tab to open the **Stage** panel (Fig. 296).

The **Compass Rose** allows you to move the scanning stage in the direction of the arrows that will become visible, when the mouse moves over a section (Fig. 297).

Clicking the arrow of the inner circle will cause the stage to move with normal speed. If you press the double arrow of the outer section the stage will move with fast speed.

You can define the step size by using the tabs of the **Step [μm]** box or typing a number. You can move with two speeds, fast with the outer rose and slow with the inner rose. If the carrier was moved by the compass rose or the joystick, the calibration will be lost.

The **X [μm]** and **Y [μm]** boxes display the current relative x and y positions of the stage. If you type in numbers in the boxes the first click on the compass rose will move the stage to this defined position. Further clicks will move the stage in the direction of the arrow pressed with the step size and speed selected.

You can stop the stage from moving to a defined position by pressing the **Stop** button. In this case the orientation of the carrier will be lost.

If the **Set Zero** button is pressed, the stage will be zeroed to the current position. You can move to the zero position by pressing the **Move To Zero** button.

- ☞ If the carrier is not oriented or positions are defined out of the range of the carrier, the stage might move the sample carrier out of the objective field.

**Marks** is only available if **Select all** is active. It allows you to define positions in an image by pressing the **Mark** button. You can give a marked position a name by typing a name in the **Marks display** box. You can move to a marked position by stage by selecting it from the drop down menu and pressing the **Move To** button. You can remove a marked position by loading it and pressing the **Remove** button. And you can remove all marked positions by pressing the **Remove All** button.

### 5.3.7 Navigation – Sample Carrier

The **Sample carrier** tool allows the definition and orientation of a sample carrier, so that single wells can be approached automatically.

- Click on the **Sample carrier** tool tab to open the **Sample Carrier** tool (Fig. 298).
- Press the tab again to close the tool. Without selecting a sample carrier, no sample carrier will be displayed in the **Orientation** display box.

You can define the properties of a new sample carrier by pressing the **Properties** button. This opens the **Properties** window (Fig. 299).

In **Columns** and **Rows**, enter the **Number** of columns and rows of your sample carrier or use the arrows for changing the numbers. You also have to enter the well to well **Distance** in mm, which you should measure with a ruler.

Save the new configuration by pressing the **Save** button (floppy disk symbol). This will open the **Save current carrier configuration as** dialog (Fig. 300).


Type in the **Configuration** name you want to use.  
Press **Ok** to save the configuration.

Press **Cancel** to close the dialog without saving. After saving the new defined carrier will be displayed in the **Orientation** display box.

To load a configuration from the database of saved configurations press the **Load** button (folder symbol). This opens the **Load configuration...** window (Fig. 301).

From the list of **Recent** configurations or all available **Configurations** select the one you want to open by clicking on the name. This will immediately open the respective sample carrier configuration in the **Orientation** display box.

If you type in a name in the **Search** input field, only this configuration will be listed in the **Configuration** field.

 If you type in a name that does not exist, the list will be empty.

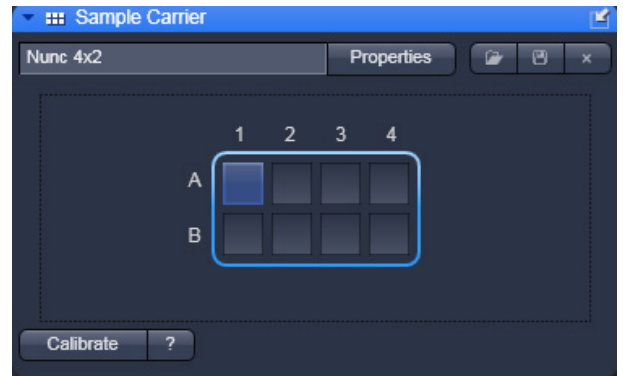


Fig. 298 Sample Carrier tool

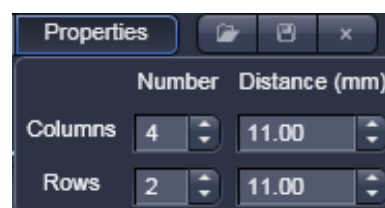


Fig. 299 Properties input window

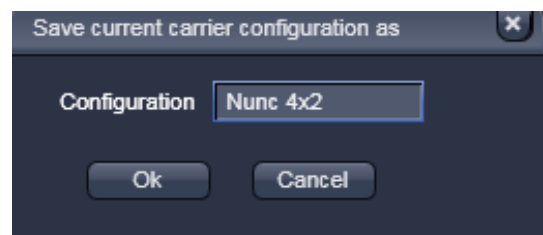


Fig. 300 Save current carrier configuration as dialog

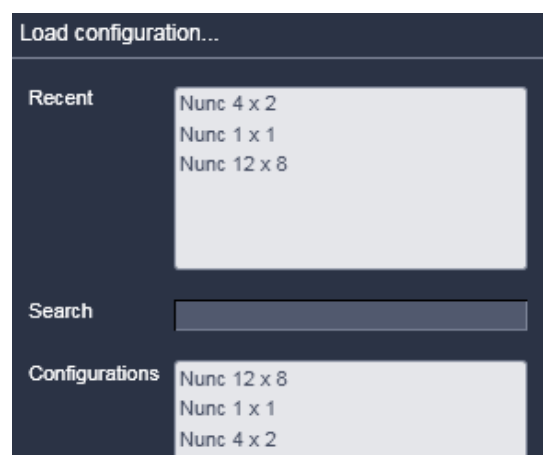
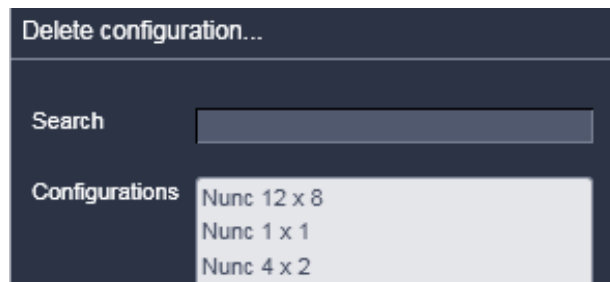
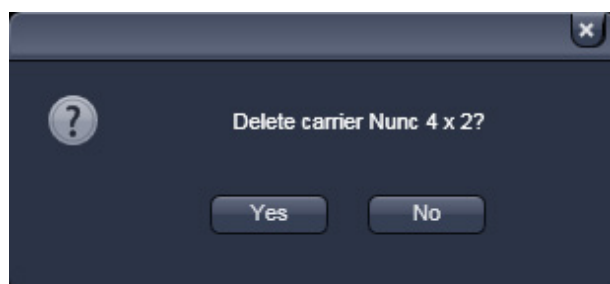


Fig. 301 Load configuration... window



**Fig. 302** Delete configuration window



**Fig. 303** Delete confirmation dialog

In order to delete a configuration, press the **Delete** button (**cross** symbol). This will open the **Delete configuration...** window (Fig. 302).

Select the configuration you want to delete by clicking on its name. You will be asked in the **Delete confirmation** dialog, if you want to delete the configuration (Fig. 303). Press **Yes** to delete the configuration, **No** to close the window without deleting. If you enter a name in the **Search** field, only this configuration will be displayed in the **Configurations** box.

If the typed name has no match in the configurations list, this will remain empty.

To calibrate the sample carrier, press the **Calibrate** button, which will stay active until pressed again or a well position was selected.

#### **Procedure for selection and calibration of a sample carrier**

From the **Load** button dropdown menu box select a pre-defined carrier. This will display the sample carrier in the **Orientation** box.

- If you want to edit a pre-existing carrier or want to create a new one press the **Properties** button open the **Properties** window.
- Enter the number of chambers and the distance (mm) between the chambers in the appropriate Column and Row input boxes.
- To orient the sample carrier in x and y click on the **Calibrate**.
- Position the center of one chamber over the center of the objective by clicking the arrow keys of the compass rose with the mouse or by using the control panel's joystick (if available).
- Click on the corresponding chamber in the **Orientation** window.
  - This chamber will be highlighted. When you have finished the **Calibrate** deactivates automatically. The stage is now oriented.

Now you can move any chamber into the measurement position by clicking the appropriate field on the sample carrier.

- The selected chamber is then automatically approached via the motorized microscope stage. When the defined position has been reached, the position of the chamber is displayed in the lower cleft corner in the **Positions** tool and is highlighted in blue.

- ☞ By pressing the **Help** button (? question mark icon), a **Help** window appears explaining the work flow for orienting the carrier.
- ☞ If the motorized stage is moved, calibration is lost.
- ☞ If you move from well to well without having calibrated the system, the system might overshoot the selected well position.
- ☞ The sample carrier window is only active if a motorized stage is attached to the system. No sample carrier will be displayed, if a manual stage is used.

### 5.3.8 Navigation – Focus

The function of the **Focus** tool allows you to position the focus in Z direction.

- Press the **Focus** tool tab to open the **Focus** tool (Fig. 304).  
Press anywhere outside the window to close the tool box.

The following functions are available:

**Zero Position** display field (only available if **Show all** is checked): Displays the current z-position. L indicates load, H home position. The arrows will move the focus continuously up and down as long as pressed.

**Step Size [μm]** allows you to enter the steps the focus will move.

**Z-Position** box displays the actual z-position. The arrows will move the focus with a step size defined in **Step Size [μm]**.

**Stop** button will interrupt an active z-movement.

**Work** button: Moves the stage / nosepiece back to the Work position. This is the position last set before the **Load** button was pressed.


**Load** button: Lowers the stage / nosepiece to a default position make it easier for you to change the sample carrier (or objective).

**Zero Position Manually** button will set the current z-position to zero.

If a z Piezo-stage insert is available the **Piezo** field will be displayed. The **Piezo Position [μm]** box displays the actual z-position of the Piezo-stage insert. The arrows will move the focus with a step size defined in **Step Size [μm]**. Pressing the **Levelling** button will move the middle position of the z Piezo-stage to the current z-position of the microscope stand's nosepiece.

**Mark position** button will store the current z-position.

**Reuse ##** button will move to the z-position that was defined by **Mark position**. The z position number ## will appear only, when **Mark position** has been pressed and indicates the z coordinate of the present position.

 The Z-position stored by activation of the **Mark position** button is a relative parameter and is only valid during the current session. Accordingly, this position can be approached in a defined way only during this session via **Reuse**.

**+200 μm** button: Moves the Z drive for +200 μm per mouse click upwards.

**-200 μm** button: Moves the Z drive for -200 μm per mouse click downwards.

If the sample is just a solution without structure, one cannot "focus" the instrument by looking at sample features. Cover slip reflection has to be used instead to find the glass- / solution interface. The position of the glass surfaces is detected most conveniently via line scanning.

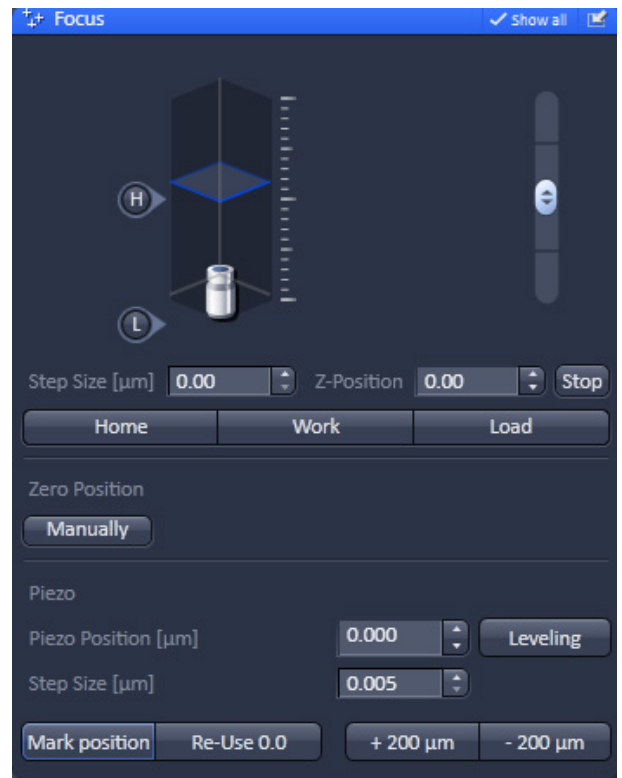
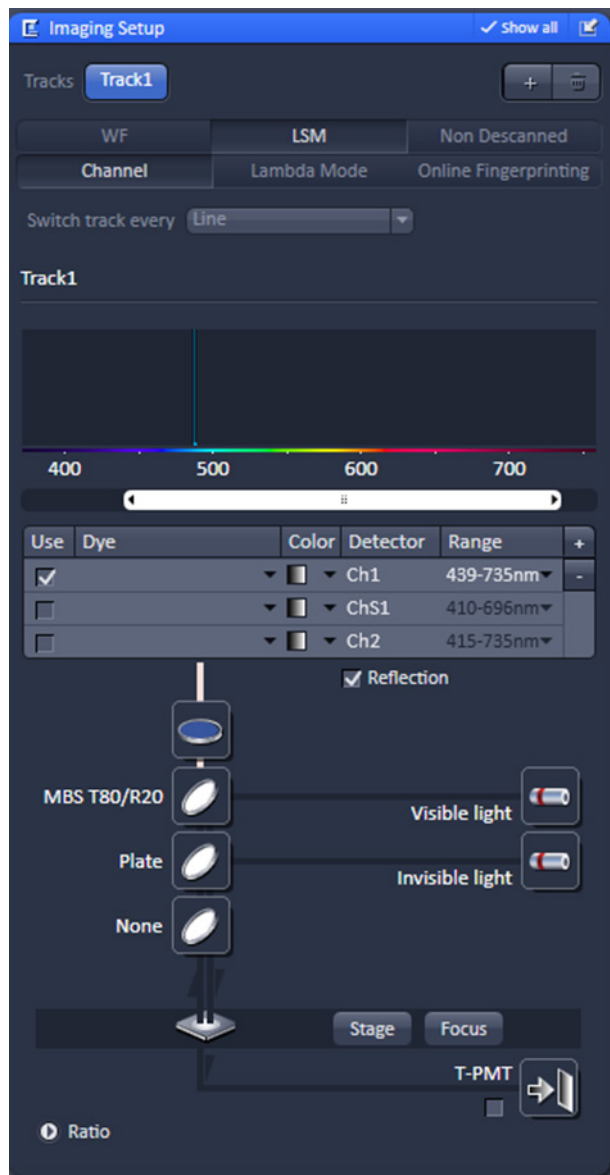


Fig. 304 Focus tool



**Fig. 305** Beam path configuration for finding glass reflection

Proceed as follows:

- Make sure that the front lens of the water immersion objective is wetted by a drop of water. Use fluorescence-free double-distilled water, since otherwise the immersion water will cause background fluorescence and deteriorate the correlation signal.
- Choose a chamber by clicking on one well in the **X, Y (Stage)** panel of the **Sample Carrier** tool.
- Set up a beam path in the LSM **Imaging Setup** tool (Fig. 305).

Convenient settings are:

- 488 nm line at 50 % tube current and 5 % AOTF
- MBS T80/R20 major dichroic beam splitter for visible light
- Plate major dichroic beam splitter for invisible light
- None for side port systems, Rear for rear port systems at the reflector position
- Reflection check box activated
- Appropriate spectral band in the detector channel to detect the reflected excitation light, for example 420 – 650 nm for 488 nm light

- Set up scan mode in the LSM **Acquisition Mode** tool (Fig. 306). Choose **Line** scan, highest Scan speed, 512 pixels and **Zoom 1** for convenience.
- Set up scan control in the LSM **Channels** tool (Fig. 307). Open Pinhole to maximum. Set detector gain between 200 and 300, and laser power to 2 %.

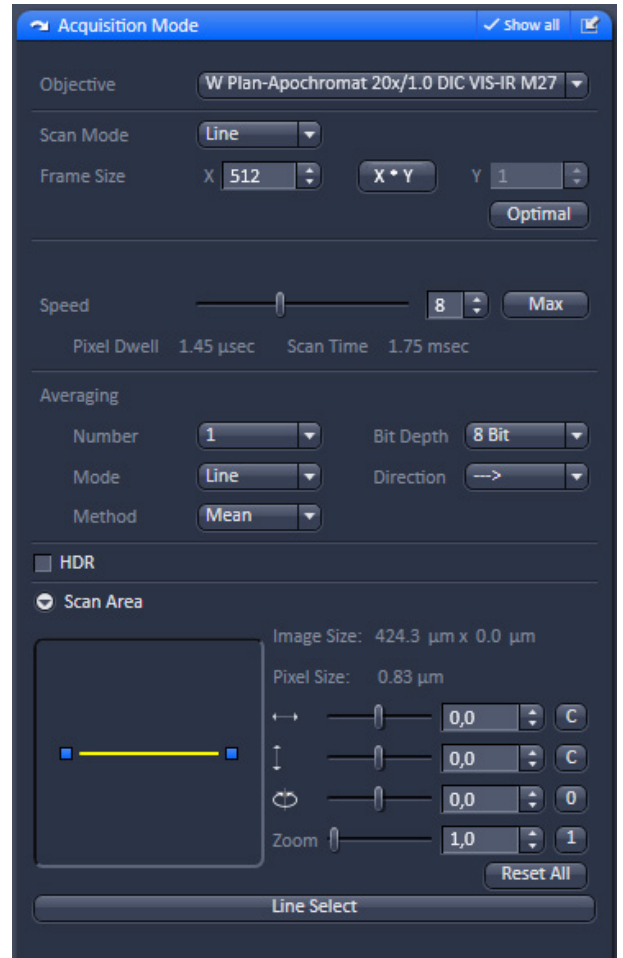


Fig. 306 Image settings for line scan mode

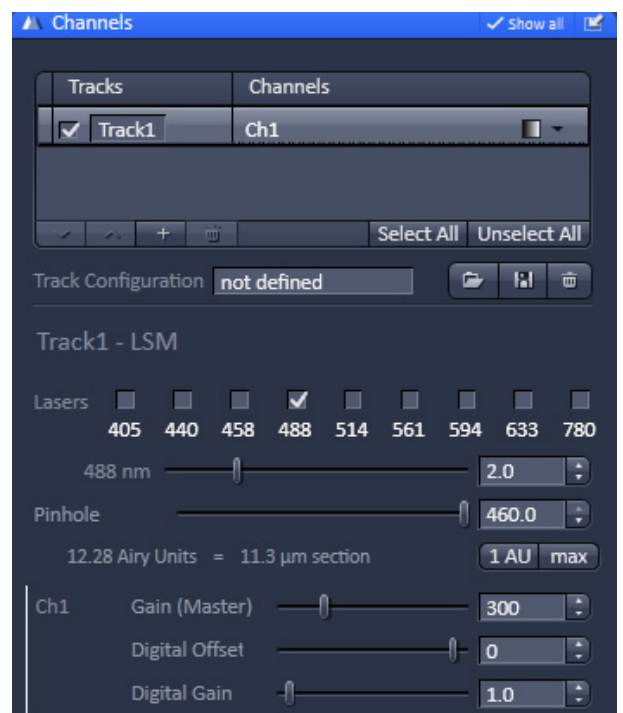
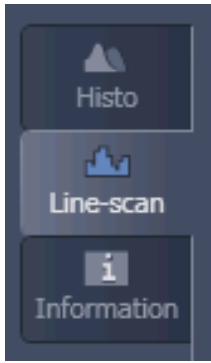
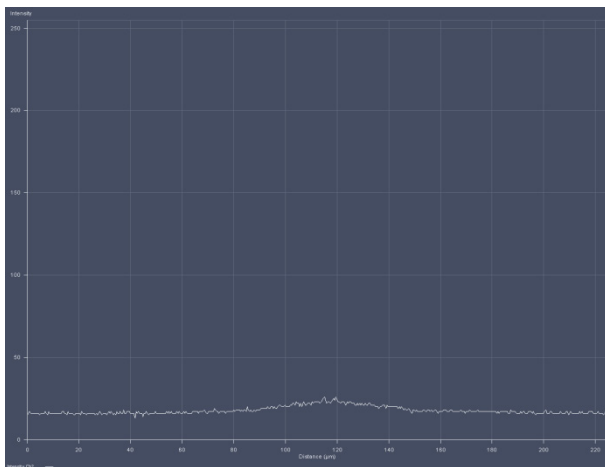


Fig. 307 Channel settings for finding glass reflection

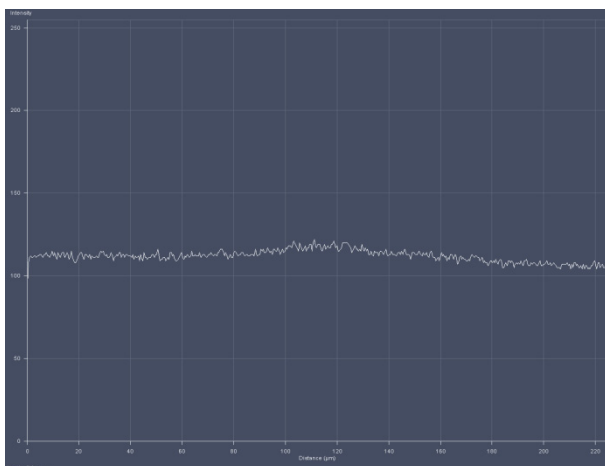


**Fig. 308** Selection of Line Scan diagram

- Press **Continuous** to start a continuous scan. Press the **Line Scan** tab (Fig. 308).
- The diagram (Fig. 309) shows a line with a bump, which is the result of reflected light on the optical axis not focused yet on the lower glass surface. You might adjust the line to lower or higher values by altering the gain or laser power.
- Move the objective cautiously upward by turning the Z focus knob of the microscope stand. A lens moving upward will be indicated by increasing numbers in the position field of the **Z (Focus)** panel window.
- If the focus position approaches the lower cover slip surface, the position of the line will shift to higher values (Fig. 310).



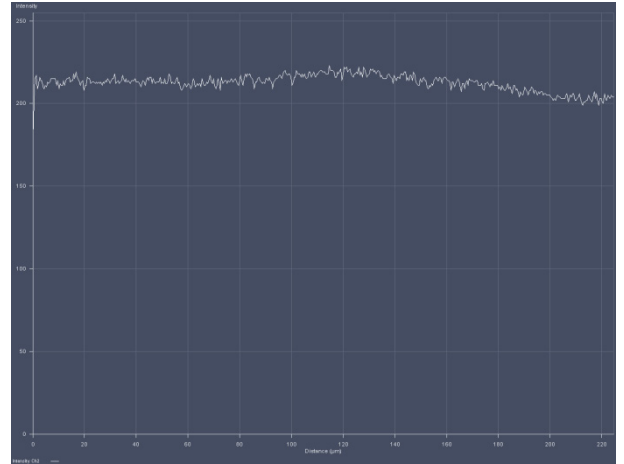
**Fig. 309** Selection of Line Scan diagram



**Fig. 310** Line diagram near the lower cover slip surface

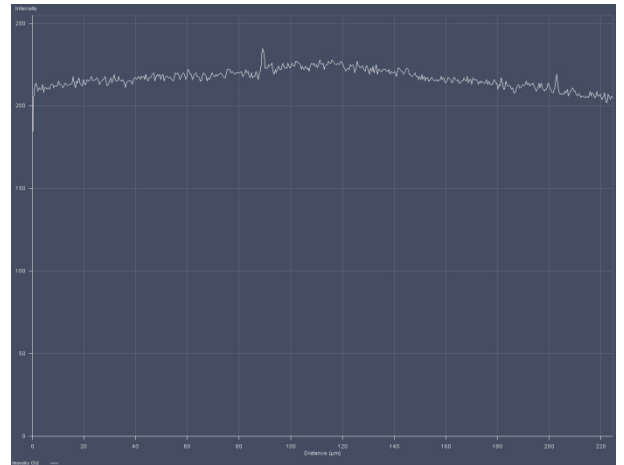


- Continue moving upwards slowly. The line position will reach its maximum (Fig. 311).

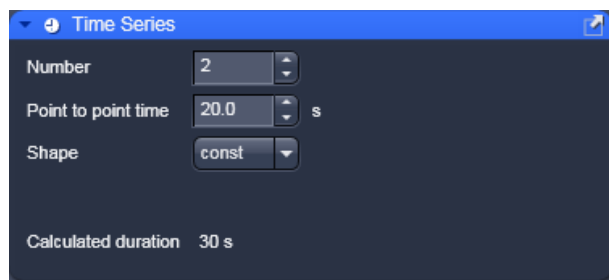


**Fig. 311** Line diagram at lower cover slip surface

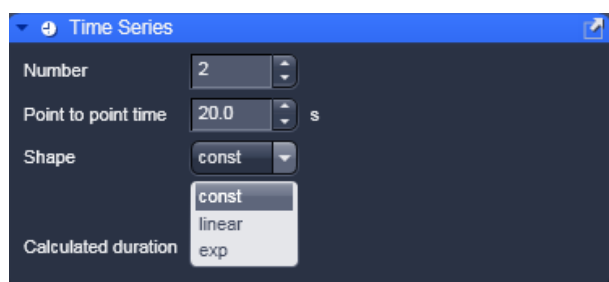
- Having slowly moved over a short distance the line position will decline again to a minimum and then rise again to a second maximum (Fig. 312), which corresponds to the upper cover slip surface.
- Store the reached position by using the **Store** button.
- Now you can position the detection volume into the sample in a well-defined way:  
If you use one of the C-Apochromat water immersion objectives, position the detection volume 150 - 200 µm deep into the sample to get rid of disturbing interface effects. The easiest way of doing this is by clicking the **+200 µm** button.



**Fig. 312** Line diagram at upper cover slip surface



**Fig. 313** Time Series tool – constant shape activated



**Fig. 314** Time Series tool – shape drop down menu



**Fig. 315** Time series tool – linear shape activated



**Fig. 316** Time series tool – exponential shape activated

### 5.3.9 Multidimensional Acquisition Tools – Time Series

The **Time Series** tool is only available if the **Time Series** box in the tab activation area is checked (Fig. 338).

In the **Time Series** tool you can set kinetics parameters.

- Click on the **Time Series** tool tab to open or close the **Time Series** tool (Fig. 313).


You have the following input boxes:

#### Number

Indicates how often kinetic data points will be taken. Enter a number in the input box or use the scroll arrows.

#### Point to point time

Defines on how the single kinetic data points will be spaced in time.

-  Note, if the spacing is too short for a kinetic data point to be finished, the system will take the minimal required time, i.e. it completes the data point and immediately starts the next.

#### Shape

allows you to choose from three possibilities of distributing the time spacing between single data points: **const** (constant) (Fig. 314), **linear** (Fig. 315) and **exp** (exponential) (Fig. 316). Choose the appropriate entry from the drop down menu.

#### Summand

allows to define the linear increase in the spacing between data points if **linear** was chosen in **Shape**. **Factor** allows to define the exponential increase in the spacing between data points if **exp** was chosen in **Shape**. For **const** this option is disabled. Select a summand / factor by choosing an appropriate one from the drop down menu. Note that only predefined values are available.

If the kinetic will last longer than one day, a warning is displayed (Fig. 317). Click **Ok** to continue.

Define the following variables:

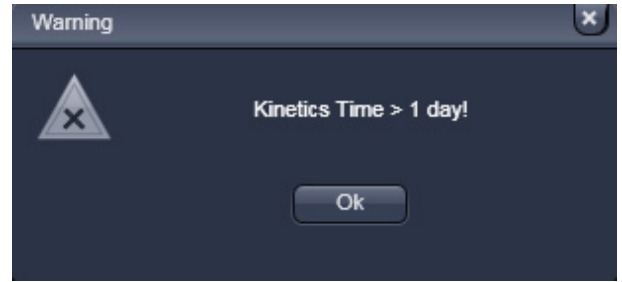
Time delay between consecutive data points =  $p_i$   
(given start value =  $p_0$ )

Start time of the measurement:  $p_{t,i}$

Number of data points:  $n$

Data point counts =  $i$  (note:  $i$  starts with 0; so for the first data point  $i = 0$ ; or general  $i = n-1$ )

Summand/Factor =  $f$



**Fig. 317 Kinetic warning**

In **const** (constant) the period between two successive data points is constant and will be exactly the time selected in the **Point to Point time** selection box.

With the definition of variables for **const**:  $p_i = p_0$ ;  $p_{t,i} = i \times p_0$ ;  $i > 0$

In **linear** the period between two successive data points as specified in the **Point to Point time** selection box is increased linearly by a summand of which the initial value is defined in the **Summand** selection box.

With the definitions of variables:  $p_i = p_0 + (i-1) \times f$ ;  $p_{t,i} = i \times p_0 + (i-1) \times f$ ;  $i > 0$

In **exp** the period between two successive measuring cycles as specified in the **Point to Point time** selection box is increased by an exponential factor of which the initial base is defined in the **Factor** selection box. Note, that the first measurement is therefore assigned a 0 for the exponent.


With the definitions of variables:  $p_i = p_0 \times f^{i-1}$ ;  $p_{t,i} = p_0 \times (\sum f^{i-1})$ ;  $i > 0$

### Procedure to set up a kinetic

- Enter the time spacing you want to start with in the **Point to Point time** input box of your kinetics measurement.
- Enter the number of data points in the **Number** box. Remember that the first data point is counted as "0".
- In the **Shape** selection box, set one of the shape options **const**, **linear** or **exp**.
- Enter a number in the **Summand or Factor** selection box.
- The **Use Kinetics** check box has to be ticked.

The system will display in the **Calculated Duration** box the total time of the experiment taken into account measurement times, kinetic data points and the time the system needs for mechanical switches.

 The start of the single data points can be retrieved from the **Save Info** panel.

 The duration of the kinetic measurement will be displayed in the **Calculated Duration** display box and in the **Time** selection area.

### 5.3.10 Multidimensional Acquisition Tools – Positions

In the **Positions** tool you can select the carrier and the sample or laser position by the stage or by the scanners.

- Click on the **Positions** tool tab to open the **Positions** tool (Fig. 318). Click again to close the tool.
- ☞ If no carrier was adjusted in the **Carrier Position** tool, no carrier will be displayed. You can omit the adjustment if you work with cells in a single chamber.
- ☞ Carriers will be schematically displayed with rows indicated by capital Arabic letters and columns by numbers (Fig. 321).

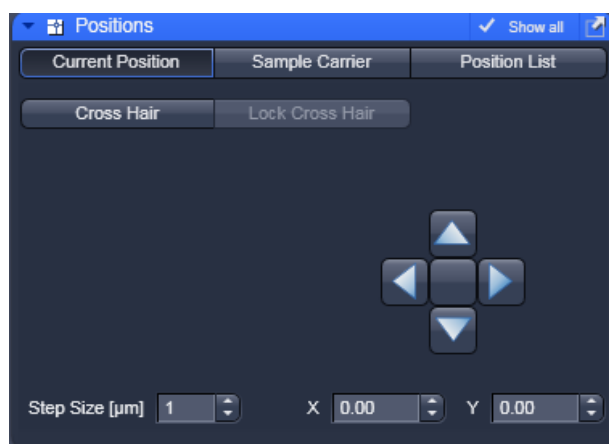


Fig. 318 Current Positions panel

**Stage control** (only available if **Show all** is activated)

- Activate the **XY Stage** tab to activate stage or scan mirror positioning.
  - Move the stage in the appropriate position by clicking on the arrow keys of the **Compass Rose**. Each mouse click moves the microscope stage in the appropriate direction by one step.
  - Set the required step width via the **Step-size (µm)** the input box or by using its scroll arrows. The travel speed of the microscope stage can be set to steps **1**, **2** and **3**. Step 2 is preferably used for standard positioning. Step 1 (slow speed) should only be used for very precise positioning, since positioning for longer paths requires more time. Step 3 is suitable if large vessels are used, since precise center positioning only plays a minor role in such cases.
- The current x and y positions are displayed in the **x-Position** and **y-Position** input boxes. You can use the input boxes to change the position by typing in a number or using the scroll arrows. The next click on one of the compass rose arrows will bring the stage or to that position. The next click will move the stage or scanner with the current speed and step sizes in the indicated direction.
  - ☞ If well positions are changed in **Sample Carrier** the system will automatically activate the **XY Stage**. The **Sample Carrier** tab will only be available for scanning stages. It is deactivated for manual stages. Even if the **Scanner** button was activated in **Position List**, going to **Sample Carrier** will automatically deactivate the **Scanner** and activates the **X,Y-Stage** mode. If you take an image of the well than the position can be changed in **Scanner** mode within the well.
  - ☞ When the required chamber is approached by joystick or the compass rose in **Current Position**, orientation of the carrier will be lost. Thus positioning has to be done visually via inspection of the carrier in this case.

- ☞ If the **XY Stage** button is activated, all positioning will be done via the scanning stage.
- ☞ This mode corresponds to the **Sample Carrier** mode, if **Single Position** is selected. Regardless which well is selected, in the result table of the **FCS results** window the position is indicated as "1".

### (1) Current position

In **Current Position** you can select a position from a scanned image. The scanner will be automatically taken for positioning.

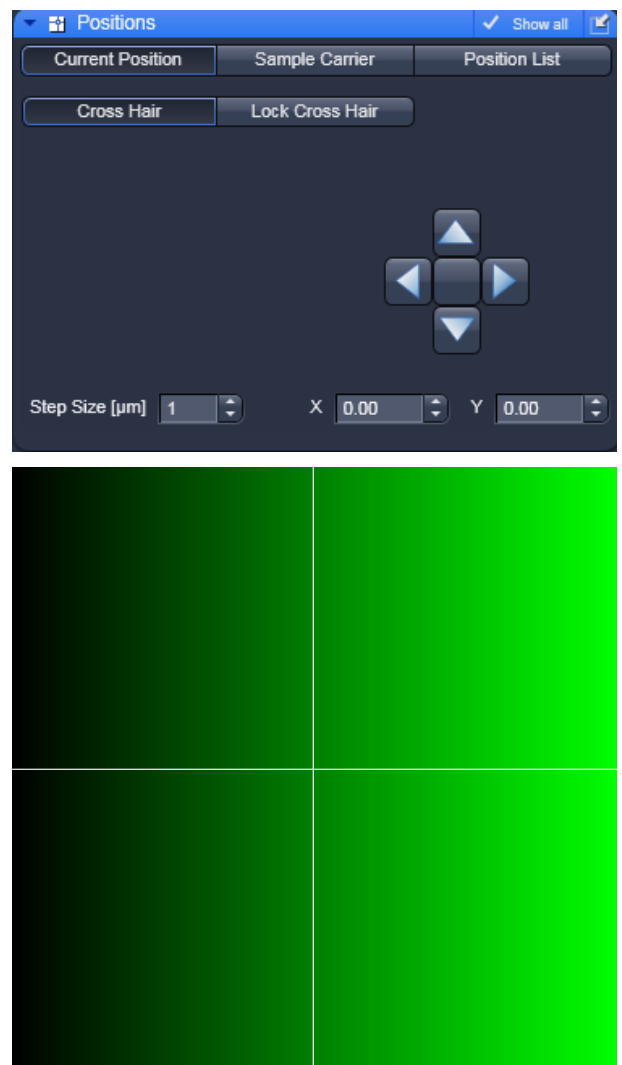
- Click on the **Current Position** tab to open the **Current Position** panel (Fig. 318).

#### Cross Hair

When using this method, FCS measurements are performed on the selected position. By triggering a measurement the scanner will move to the indicated position. If the **Cross Hair** was not activated, the beam stays at the optical axis and if no cropping or panning has been done this position corresponds to the middle of the image. In other cases the position of the laser beam with a panning within the image has to be determined by a bleach experiment. You can use the overlay tool to indicate in the image where the laser position is. Bleach a hole in a suitable sample like a dried dye layer and record coordinates.

- Image your sample.
- Press the **Cross Hair** button (Fig. 319). This will display a cross hair in your scan image. Click again to remove the cross hair. Position the crosshair at the coordinates you want to take the reading. The crosshair will be positioned on the site were you click with the left mouse button. We recommend not to close the **Scan** window after setting the crosshair. Then the crosshair will be preserved within the new scan. Fix the cross hair by pressing the **Lock Cross Hair** button. This prevents the cross hair from moving by an accidental click in the image window.

- ☞ Using **Cross Hair** the **Scanner** is used for positioning.



**Fig. 319** Current Position display with cross hair activated (above) and image with cross hair displayed (below)

## (2) Sample carrier

The **Sample Carrier** is used to approach a single well or multiple wells sequentially in an automatic mode.

- Click on the **Sample Carrier** tab to open the **Sample Carrier** panel (Fig. 321).
- ☞ The movement of the carrier is only correct, if it was adjusted by positioning a well on top of the objective, pressing the **Calibration** button and selecting that well.

### Definition of a carrier

Define a carrier in the **Properties** drop down menu. You can save the carrier, delete a saved one or load a predefined one with the appropriate controls.



Fig. 320 Properties pop up menu

### Selection of a sample carrier

In the **Properties** drop down menu box you can select a pre-defined carrier. This will display the sample carrier in the **Orientation** box.

- If you want to edit an existing carrier or want to create a new one press the **Properties** button (Fig. 320) to open the **Properties** window.
- To orient the sample carrier in x and y click on the **Calibration** button.
- Position the center of one chamber over the center of the objective by clicking the arrow keys of the compass rose with the mouse or by using the control panel's joystick (if available).

- Click on the corresponding chamber in the **Sample Carrier** window (Fig. 321).
  - This chamber will be flashing up briefly. The stage is now oriented. Note that there is no further indication that the stage was oriented.
- Now you can move any chamber into the measurement position by clicking the appropriate field on the sample carrier. The selected chamber will be highlighted in blue. Note that if **Single position** is selected, the well will be approached immediately after selecting it. To select multiple positions, use **Row by row (meander)** or **Column by column meander (meander)**. Here the well(s) will be approached only after triggering a measurement.
- You can load, save and delete a carrier by pressing the **open folder**, **floppy disc** or **cross** buttons.
  - The selected chamber is then approached automatically via the motorized microscope stage. When the defined position has been reached, the position of the chamber is displayed in the lower left corner in the **Positions** tool and is highlighted in blue.



Fig. 321 Sample Carrier panel

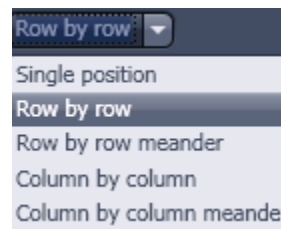




Fig. 322 Working direction drop down menu


-  By pressing the **Help** button (? question mark icon) button, a **Help** window appears explaining the work flow for orienting the carrier.
- Focus into the sample using the line scanning.
- Select the carrier. The stage will move to the selected well.
- Perform measurement by pressing the **Start Experiment** action button.
-  The laser beam will stay at the optical axis, because positioning of the well is done by the scanning stage. If you want to have the scanner position within the well, you have to go to the LSM image panel, image the solution and position by stage or scanning mirrors.
- Select the working direction from the **Working Direction** pull down menu (only visible if **Show all** is activated) (Fig. 322).

## Single Position


Only a single well can be activated. The scanning stage will automatically move to the activated well without the need to trigger a measurement.


To select the chamber you want to take the measurement in (only one is selectable) click on the one you want to use. The motorized stage moves the selected chamber to the defined position under the objective and the current well will be highlighted in blue. If no scanning stage is available, positioning has to be done manually or by the scanners, and the **Sample carrier** tab will not be available.


- If you want to move to other positions within a well, you can do so by imaging the solution and define positions in **LSM image**.


 In **Sample Carrier** only the **X,Y Stage** tab is active and the stage is used for positioning, if a motorized stage is available. Otherwise the tab is not active.

- Select one of the three speeds from the **Speed Settings** drop down box.
- Select the step size from the **Step Size (µm)** scroll menu (or the input box) with the scroll arrows or numerically.
- The current position will be indicated in the **x-Position** and **y-Position** selection boxes.

 Before clicking on a chamber you have to orient the carrier. For a non-oriented carrier, all chambers are displayed in grey. Please orient first before you select a position. After orientation, the selected well will appear blue.

 You can also use the arrow buttons or the joystick to move the microscope stage, but in those cases, the orientation gets lost. The selected chamber will not be highlighted any more in blue. You can set the size of the steps to be performed via the **Step Size (µm)** scroll menu (or the input box) and the speed in the **Speed Settings** drop down menu.

 Regardless which well is selected, in the result table of the **FCS results** window the position is indicated as "1".

 The measurement will be triggered by pressing either the **Snap** or the **Start Experiment** action button.



### Multiple positions

- Select from the **Working Direction** drop down menu an entry other than **Single position**.
- Select as many individual well positions as required (all are selectable) by just clicking on them. All selected wells will be highlighted in blue. You can deselect a highlighted well by just clicking with the right mouse button on it again.  
Alternatively, a whole block of chambers can be selected / deselected by drawing a frame which contains the centers of the selected / deselected chambers.

By pressing the **Select All** button, all wells will be selected.

By pressing the **Clear All** button, all wells will be deselected.


Selected wells will be highlighted and will be approached sequentially as follows:

**Row by row:** Measurement is performed row by row. Each row starts from the left site.

**Row by row meander:** Measurement is performed row by row. Rows start alternatively from the left and right. First row starts from the left.

**Column by column:** Measurement is performed column by column. Each column starts from the top.


**Column by column meander:** Measurement is performed column by column. Columns start alternatively from the top and bottom. First column starts from the top.

 If the **Snap** action button is pressed, only the first highlighted position will be approached. To approach all listed positions sequentially press the **Start Experiment** action button.

### (3) Position list

The **Position List** panel can be used to define several measurement positions in a scanned image, which will be approached sequentially. You can approach these positions either with the scanning stage if the **XY stage** button is activated, or by the scanning mirrors, if the **Scanning** button is activated.

- Click on the **Positions List** tab to open the **Position List** panel (Fig. 323). Click on any other tab to leave the panel.
- Select between **Scanner** and **XY stage**.

 Please note, if you toggle between **Scanner** and **XY Stage**, all marked positions will be lost.

- Press the **Select** button. This activates the cursor (cross line) to define positions in the scan image. You can position the cross line via the cursor.  
Activating / deactivating the **Select** button will show or hide added positions.

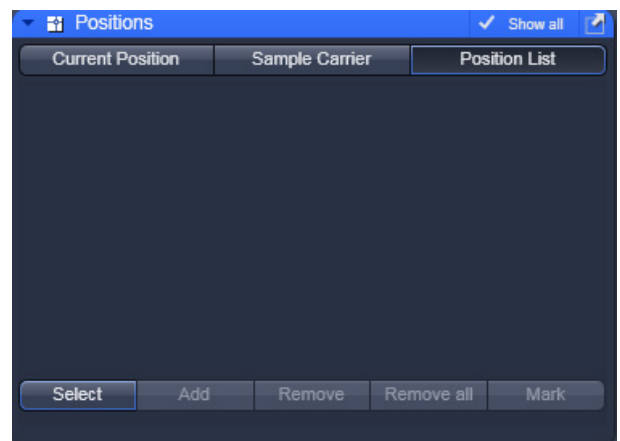
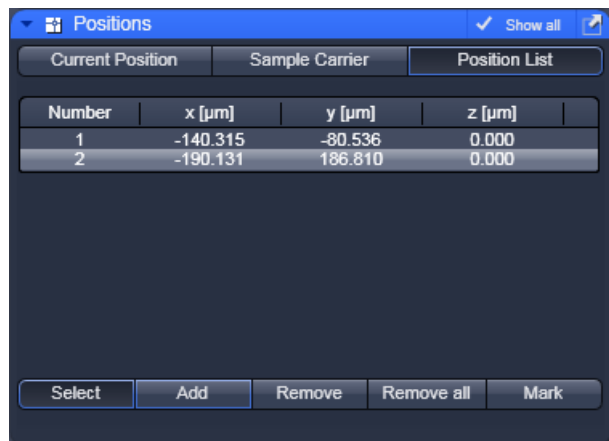
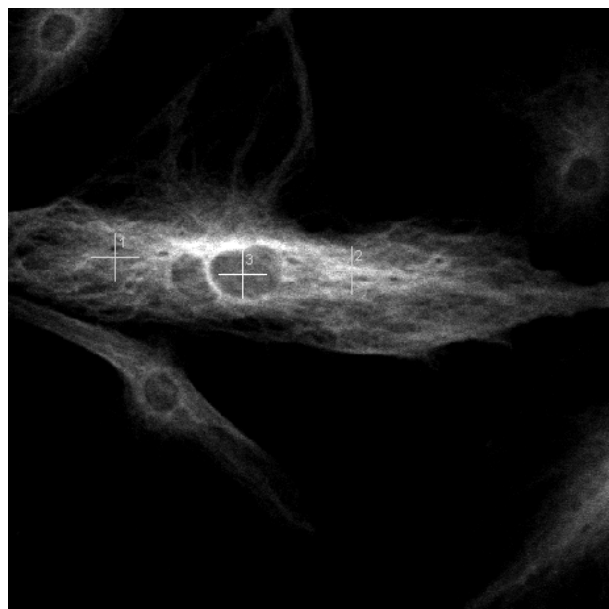


Fig. 323 Position List panel



**Fig. 324** Position list with 3 positions selected



**Fig. 325** LSM scan image with 3 selected positions

- Move the cursor to the desired position in the scan image (drag and drop). Press the **Add** button to add the position marked with the crossline to the **Positions** list (Fig. 324). A crossline is set at the selected cursor position in the image (Fig. 325). To select further positions click at the appropriate position in the image and then press **Add**. If more than one position is selected the crosslines are getting current numbers. The Position list displays the numbers and coordinates of the positions in the **Number**, **x (µm)**, **y (µm)** and **z (µm)** display boxes.

In a Z-Stack, you can also vary the Z-plane in which measurements are to be performed. For this purpose, select the required Z slice in the stack or set the Z value via the focusing drive of the microscope.

- ☞ If the **Scanner** button is pressed, the scanner will be positioned to the high-lighted position if the **Count Rate** action button is pressed. If the **X,Y Stage** button is pressed, the stage will not be positioned to the high-lighted position. Only after triggering a measurement the stage will move to the indicated position and will go back to the initial position after the end of the measurement. If you want to obtain the count rate by pressing the **Count Rate** button at the indicated position using the **X,Y Stage** control, you have to start a measurement beforehand.

- ☞ Positioning is only valid for the active (and stored) scanned image. If different images are open, be sure to use the one corresponding to your present sample.

- Press the **Remove** button to remove selected (highlighted) positions from the **Positions** list and the corresponding crossline in the scan image.
- Press the **Remove all** button to remove all positions and all crosslines in the scan image.
- Press the **Mark** button to fix the crosslines as overlay elements in the scan image (Fig. 325). The crosslines will also stay visible in the scan image if the **Select** button is deactivated. If you call up an image later you have to activate the overlay function and a line drawing element to display the crosslines.

- ☞ Positioning is performed by scanning mirrors if the **Scanner** button or by the scanning stage, if the **XY Stage** button is pressed. If more than one position was selected, measurement is only taken at the highlighted position if the **Snap** action button is pressed. To approach all listed positions sequentially the **Start Experiment** action button must be pressed.

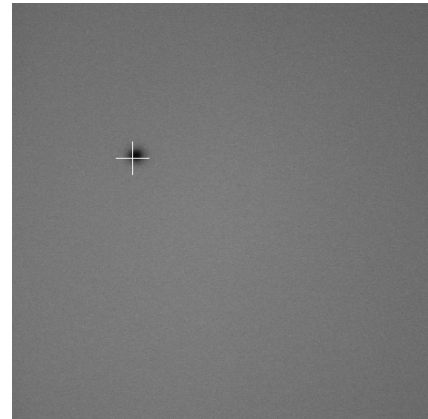
- ☞ The X-, Y- and Z-coordinates of the selected positions are only stored in the **Positions** table and not in the scanned image (stack). Accordingly, all the marked positions in all Z-planes are displayed in the scanned image (Z-Stack), no matter in which Z-plane they are.
- When finished, click on the **Snap** or **Start Experiment** action button to start the FCS measurements at the highlighted or all listed positions, respectively. The measurement procedure starts and the **Image FCS diagram** window appear in a container.

#### (4) Hysteresis correction of Scanning mirrors

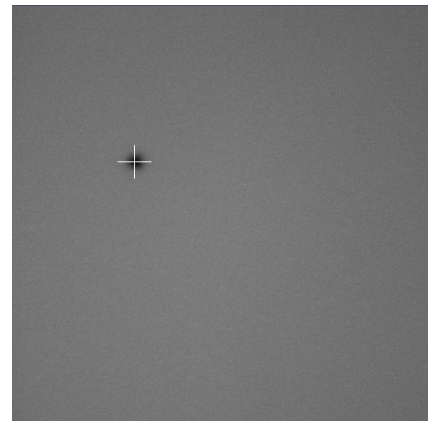
In general, there is no need to compensate between defined positions and the actual measurement positions using the scanning mirrors.

However, the precise arrest position of the mirrors depends on the used scan zoom and speed and small offsets can occur and offsets may exist due to scanner hysteresis (Fig. 326).

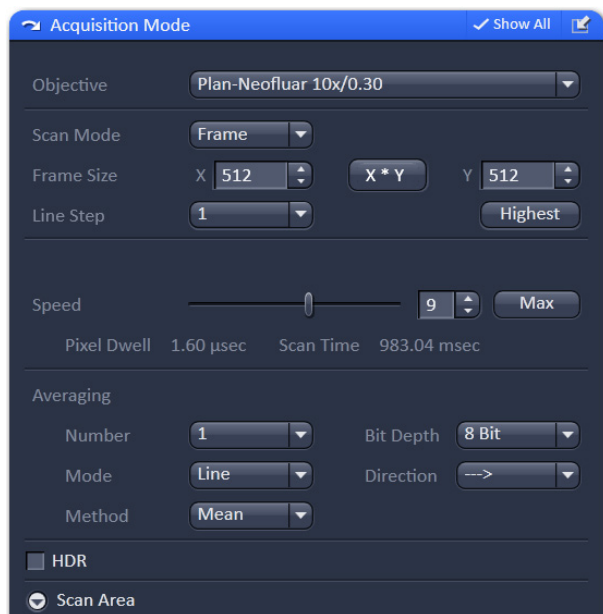
To adjust for differences, the compensation sliders of the bidirectional scan can be adjusted to decrease the offset (Fig. 327).



**Fig. 326** Scanner positioning before hysteresis correction



**Fig. 327** Scanner positioning after hysteresis correction

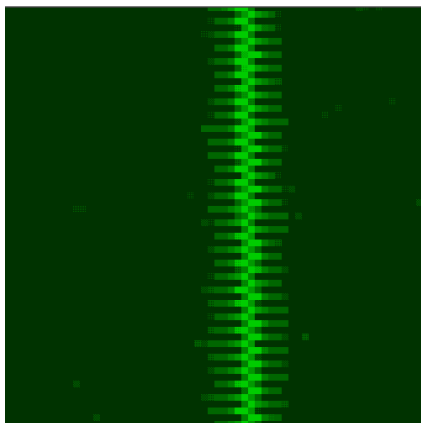


**Fig. 328 Pixel Depth, Scan Direction & Scan Average window**

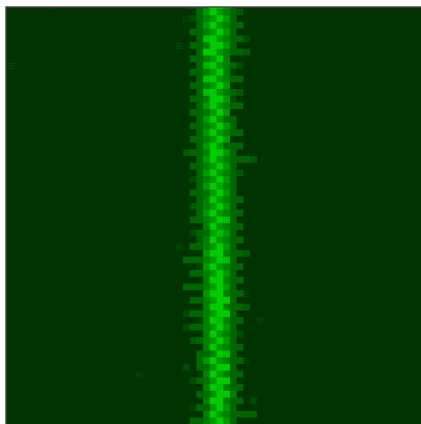
To compensate for scan zoom and scan speed go to the **Acquisition Mode** tool of the **LSM Online Acquisition** tool group. Use a sample with high contrast, like "Convolvria", and focus. Activate **Bidirectional Scan** (double arrow) under **Direction** (Fig. 328). During scanning press the **Auto** button. The system will adjust automatically the **Scan Corr X** and **Y** values. Alternatively you can do the compensation manually.

If the **Scan Corr** is not adjusted, you will see a pixel shift (Fig. 329). Alter the **Scan Corr** values to compensate any pixel shift in the following way:

Move the **Scan Corr X** slider until the pixel shift is at the minimum (Fig. 330). Rotate the image by 90° and redo the same adjustment for **Scan Corr Y**.



**Fig. 329 Image of a line before pixel shift compensation in x**



**Fig. 330 Image of a line after pixel shift compensation in x**

### 5.3.11 Navigation – Incubation

Open the **Incubator** tool by clicking the **Incubator** tab in the **Navigation** tool group (Fig. 331).

You will have access dependent on the attached equipment to

- Temperature (°C) control
- Atmosphere (%) control
- Y-module (°C) control

To have access to the respective controls, you have to expand the fields by pressing the triangles (Fig. 331).

The **Temperature (°C)** panel allows you to control up to 4 independent heating channels that are linked to certain devices (e.g. incubator XL, heating insert P, objective heater etc.) that are assigned to different channels. Enter the desired nominal temperature via the input boxes by typing in the numbers or by using the arrows to set the parameters. Check the corresponding box to activate the desired **Channel**. The numbers on the right will display the actual temperature. If a sensor is available, its temperature will also be displayed.

The **Atmosphere (%)** panel allows defining the O<sub>2</sub> and CO<sub>2</sub> concentration via the input boxes. Either type in the numbers or use the arrows to set the parameters. In order to monitor O<sub>2</sub>, CO<sub>2</sub> and humidity levels, check the corresponding boxes. Actual values will be displayed on the right. If a humidifier is available it can be activated by checking the **Humidity** box. The actual humidity reading is displayed on the right.

The Y-Module (°C) panel allows setting the temperature for two independent thermostats (circulators), that can be selected via the **Selected** drop down menu. Each **thermostat** has two output channels, **01** and **02**. Type into the input boxes or use the arrows to define the appropriate temperature for each module. Activate the modules by checking the corresponding boxes. The actual values will be displayed to the right of each module.



**Fig. 331** Incubation tool – Expanded fields for atmosphere and temperature control

### 5.3.12 Multidimensional Acquisition Tools – Information on Experiment

- Click on the **Information on Experiment** tab to display a detailed description of the highlighted method including name, comments, configurations and parameter settings (meta data) (Fig. 332). Click a second time to close the information window. The scroll bar can be used to view the complete information.
- The **Copy** button will copy the content of the **Information On Experiment** window to the clipboard (only available if **Show all** is activated).
- The **Print** button opens the **Print Setup** window. Set the print parameters and start the print function by clicking **Ok**. The **Print Setup** window will be closed automatically and the content of the **Information On Experiment** window will be printed as a hardcopy.

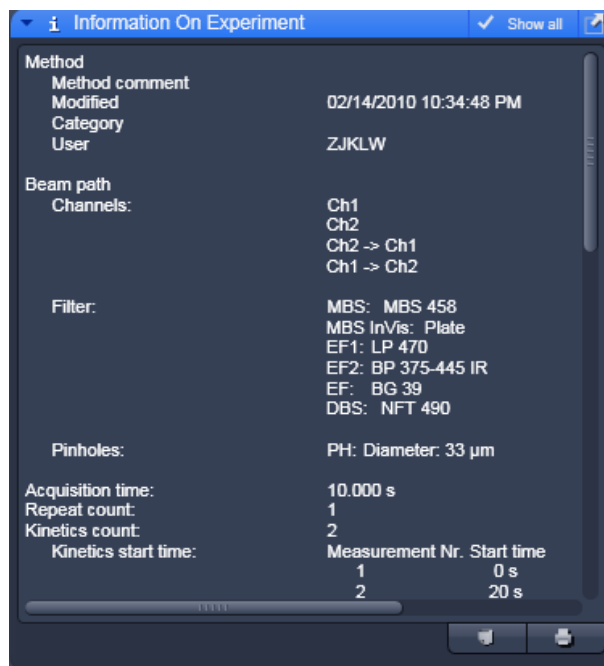



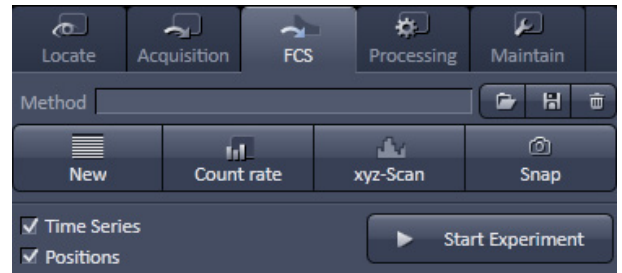
Fig. 332 Information on experiment tool

### 5.3.13 Action Buttons for FCS

The Action buttons are used to trigger measurements and to adjust the measurement conditions. The following buttons are available (Fig. 333):

- **New:** opens up a new Image FCS Diagram within a container.
- **Count rate:** opens the **Count rate** window.
- **xyz-Scan:** triggers a one dimensional (x, y, z) or two dimensional (xy, xz, yz) scan.
- **Snap:** Starts a single measurement at the first (Sample Carrier) or highlighted (LSM Image) position.
- **Start Experiment:** Starts sequential measurements on all marked or highlighted positions.
- **Stop:** Ends or interrupts the current measurement (Appears only when a measurement is actively running and replaces than the **Start Experiment** and the **Snap** buttons simultaneously).

 Scans and measurements are performed according to the settings and methods defined in the FCS tools.



**Fig. 333** Action buttons

Above and below the **Action** buttons the **Method** tool and **Activation** tab areas are available.

Besides the action button the **Method** tool allows to save, load and delete methods. The active tab area allows some of the tabs to be activated by checking the corresponding boxes.

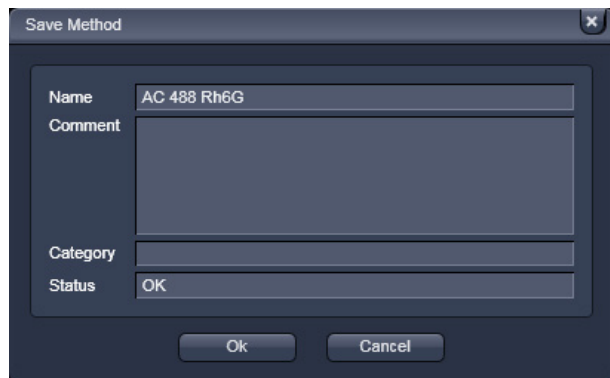


Fig. 334 Save Method panel

### 5.3.14 Method Tool

The **Method** tool allows to store (**floppy disc** button), load (**open file** button) and to delete (**cross** button) methods.

#### (1) Storing a method

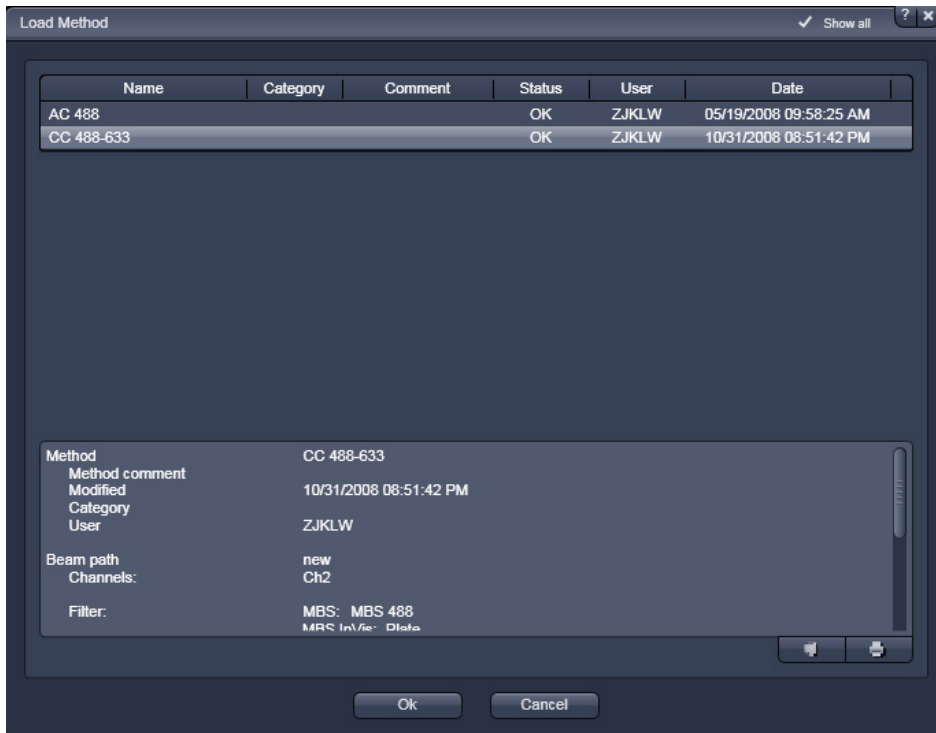
The **Store** button (**floppy disc** symbol) will allow you to save all settings (**Light Path, Acquisition, Correlator**) into a method.

- Click on the **Store** to open the **Save Method** panel (Fig. 334). Click again to close the panel.
- You can save the method by pressing the **Ok** button. If the method name exists already, the system will prompt you to confirm overwriting the old method. Press **Yes** to overwrite, **No** to keep the old method settings. If the system settings deviating from default expectations, it will give a warning. For example, if no pinhole alignment was done or if a dual color experiment was set up with one channel or one laser, a corresponding warning will be displayed. Press **Yes** for continuing anyway, **No** for returning to the method without saving. If you press **Cancel**, the **Save Method** windows will close without saving the method.
- You can enter a new method name or replace the old one by typing into the **Name** display window. You can enter a category name or replace an old one by typing into **Category** display box.
- You can give a comment or replace an old one by typing it into the **Comment** display box.



**(2) Loading a method**

The **Load** button (**open file** symbol) will allow you to load a pre-defined method. The configurations will be displayed; however, hardware settings change only if a measurement is triggered.



**Fig. 335 Load Methods panel**

- Click on the **Load** button.

This opens the **Method** panel (Fig. 335). Another click will close the window again. Scroll tabs will allow viewing all the contents. The **Methods** panel lists all existing measure methods for selection or deletion.

- You can select the analysis method you want to use by highlighting the corresponding entry from the list with a single click and pressing the **Ok** button.
- Press **Cancel**, to close the **Load Method** panel without loading the highlighted method.
- You can view all the meta data in the Settings display box (only available if **Show all** is activated). This entry corresponds to the information of the **Information on Experiment** tab. Using the **Copy** button you can copy the content to the clipboard. The **Save** button allows you to save the information in a text file.
- All parameters will load with this method.

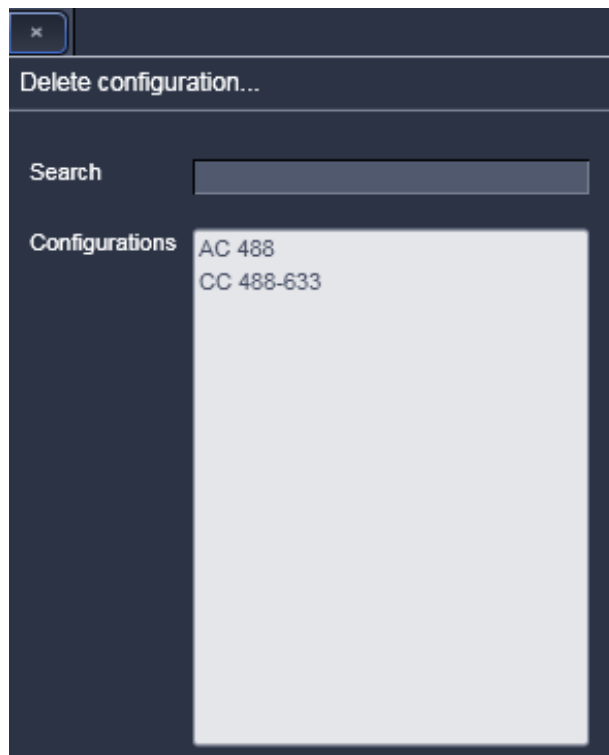


Fig. 336 Delete configuration... window

### (3) Deleting a method

The **Delete** button (**cross** symbol) allows you to delete a method from the database.

- Click on the **Delete** button. A **Delete configuration...** window will appear (Fig. 336).
- To search a configuration, enter the respective name in the **Search** display field. If there is no match with the **Configurations** list, no method will be highlighted. You can also choose a method from the **Configurations** clicking on it.
- The **Delete Method** panel will appear requesting confirmation of this action (Fig. 337). Press **Yes** to delete the method from the data base, **No** to keep the method.

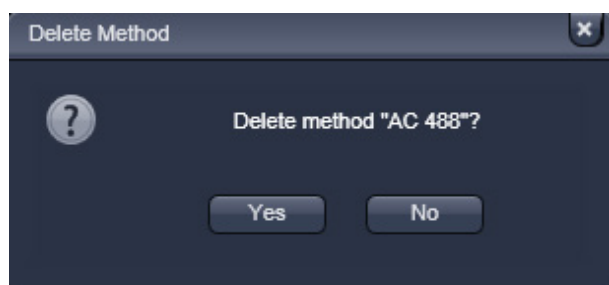


Fig. 337 Delete Method panel

### 5.3.15 Activation Tab Area

In the activation area you can select certain tabs to be displayed in the tool area or no by just checking the corresponding boxes (Fig. 338).

Those tools are mainly for Multidimensional Acquisition, which are needed only in special cases.



**Fig. 338** Activation tab area

### 5.3.16 New

If a measurement is triggered by pressing the **Snap** or **Start Experiment** button and no active **FCS diagram** window is open in the Container, a new window will be opened displaying the count rate trace, correlation function, pulse density histogram and photon counting histogram as selected and the measurement is recorded according to the **System Configuration, Acquisition** and **Correlator settings**.

If one or more windows are open, the measurements will be added to the active window.

If you want to open a new window, press the **New** button. This will open a new empty FCS diagram window (Fig. 359).

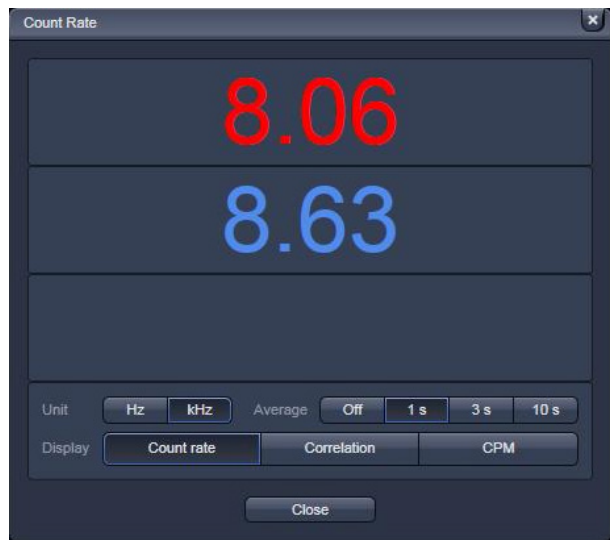


Fig. 339 Count rate window with count rate display

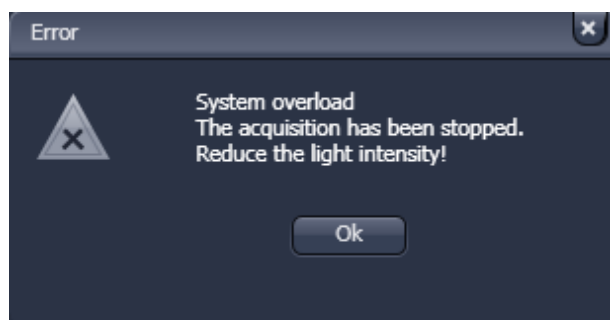


Fig. 340 Overload display



Fig. 341 Count rate window with correlation display

### 5.3.17 Count Rate

- Click the **Count rate** button to open the **Count rate** window (Fig. 339).

#### a) Display

Select one of the display modes **Count rate**, **Correlation** or **CPM** (Counts / molecule) by pressing the corresponding button. The arrow buttons of the scale tab allow to adjust the measuring range.

- Click the **Count rate** button in the **Display** line to display the count rate per second (CR) for each activated physical channel (Fig. 339). This value is constantly updated and calculated each 0.5 ms, if **Averaging** is switched **Off**. If system overload occurs, an error message will be displayed and the APDs switched off in order to avoid damage (Fig. 340). Press **Ok** to continue and laser light intensity or concentration of your sample.
- Click the **Correlation** button to display the correlation amplitude ( $G(0)$ ) of each activated physical and Software channel (Fig. 341). This amplitude is constantly updated and calculated each 0.5 ms if **Averaging** is switched **Off**. The expanded display for each channel can be closed by the **Channel 1**, **Channel 2** and Cross Correlation arrows.

- Click the **CPM** button to open the counts per molecule per second (CPM) (Fig. 342). This value is constantly updated and calculated each 0.5 ms if **Averaging** is switched **Off**. The blue bar indicates the extend of the CPM graphically. The expanded display for each channel can be closed by the Channel 1 and Channel 2 arrows.

### b) Unit

Select the units of the **Count rate** and **CPM** displays in **Hz** or **kHz** by toggling between the corresponding buttons.

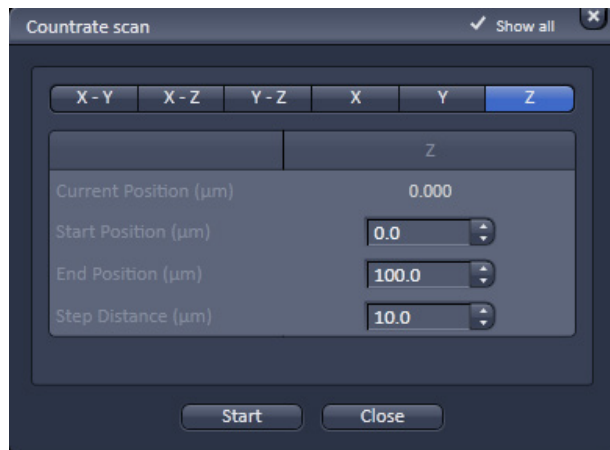
### c) Average

Averaging for **1 s**, **3 s** or **10 s** or switch averaging **Off** by pressing the corresponding button. Note, if an average is set, the values for CR, G(0) and CPM will be updated only per the average time. In **Off** updates are displayed every 50 ms.

- ☞ You can expand and shrink the **Count rate** window using the black arrows in the right lower corner.



Fig. 342 Count rate window with counts per molecule rate display



**Fig. 343** Countrate scan window for x, y and z scans


### 5.3.18 X-Y-Z Scan


The X-Y-Z Scan panel allows you to perform scans in the x, y and z directions and combinations thereof. Especially in the z direction, it helps to position the focus to the correct position, e.g. in a cell membrane.


- Click on the **xyz-Scan** button to open the **Countrate scan** window (Fig. 343). Click the **Close** button to close the window.
- Position your sample in x, y and z.
- Choose the scan you want to perform by pressing either of the **X-Y**, **X-Z**, **Y-Z**, **X**, **Y**, and **Z** buttons. The pressed button with a blue frame indicates the active scan direction.

- Define the extent of the scan by using the **Start Position (µm)** and **End position (µm)** input boxes or their scroll arrows. You can see the current position in then **Current Position (µm)** display box. The **X**, **Y** and **Z** directions are indicated above the input boxes.
- Define the step size by using the **Step Distance (µm)** input boxes.
- Perform the scan by pressing the **Start** button from the **Countrate scan** window.


During the scan the count rate is displayed for the selected channels. Dependent on the scan modalities the count rates for the selected channels are plotted in a line plot (x, y and z) (Fig. 344) or frame plot (xy, xz and yz) (Fig. 345). In the frame plot intensities are color coded. The maximum intensity in Hz is displayed in the **Maximum count rate channel 1** and **2** display boxes.

 Please note, that x and y scans are performed by the stage regardless if the **Scanner** button in the **Measurement** tool group is pressed or not. Z Scans are performed by the nosepiece.

 Scans will be performed relative to the actual position. The actual position will always be displayed as the 0 coordinates.

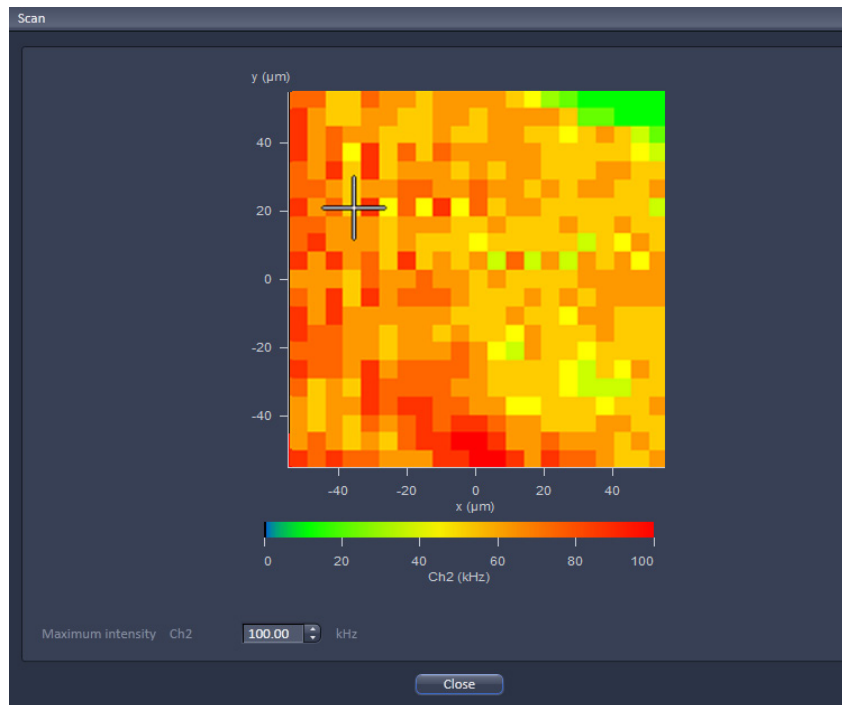
 A maximum (or minimum) in the resulting curve or plot usually indicates a region of interest.

- When the scan has been finished, the vertical black line (line plot) or the cross-lines (frame plot) can be used to re-position the focus. Just drag the bar or cross-lines with the left mouse button held down to the new position and release the mouse. By clicking the **Ok** button the stage or nosepiece will move to the new position and the scan window closes. The **Abort** button will be inactivated for a finished scan. You can press **Ok** or **Abort** during the scan to interrupt the scan. **Ok** will close the window and the old position is kept. **Abort** does not close the window, so you are still able to reposition. Press **Ok** to leave the scan window.

 Note that the **X**, **Y**, **XZ** and **YZ** options are only displayed, if the **Show all** box is checked.



**Fig. 344 Z Scan result window (line plot)**

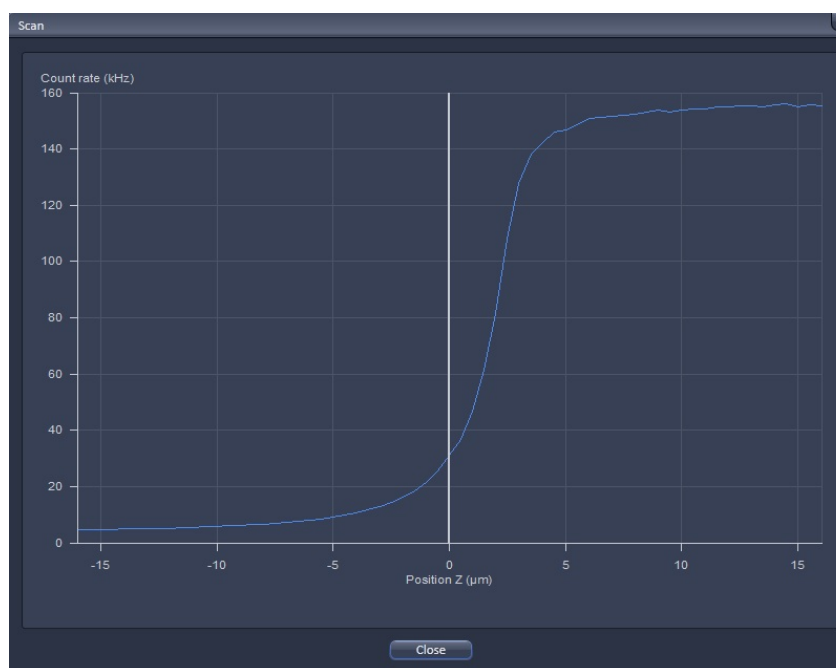


**Fig. 345 XY scan result window (line plot)**

The data of the **Count rate scan** window can either be copied to the clipboard or written to a text file. A click in the **Count rate scan** window with the right mouse button will open the context menu for line or two dimensional scans.

- Select the line **Copy data to clipboard** with a click of the mouse if you want to insert the data into other WINDOWS programs directly via the clipboard. The Paste function enables you to insert these data directly into the required program.
- Select **Write text to file** to save the data in an external ASCII file (.txt).

You can zoom in by spanning with the left mouse button held down a region of interest (not available for a frame plot). You can rest the zoom by selecting the line plot by defining the zoom area with.



**Fig. 346** Z Scan image

### Z Scan for finding a labeled cell membrane

- Press the **xyz-Scan** FCS action button to perform a z scan. The z scan is performed and the measured intensity is displayed in dependence of the z-position (Fig. 346). The red line in the diagram shows the actual z-position. Peaks (normally two from the two lower and upper membranes) show levels of high signal intensity and may correlate to labeled membranes. Note, that if the glass surface happens to be in the z scan range it will also give a peak. To determine its position, just perform a z scan at a position where is no cell. If the glass reflection contribute so much

that the peaks of the membranes are hidden due to scaling, you have to shorten the lower range end. Place the red line at the peak that corresponds to the membrane to select this z-position. Note that z scan is performed relative to the current position, which will be assigned to 0.

- If no clear signal can be detected, or the peak of interest lies too close to the border, close the scan window and perform a new z scan. Choose a different z range by modifying start and end positions to values that lie closer to the position at which the signal should be expected.
- If the z-position has been selected, close the **Z Scan** window by clicking on the **Close** button.
- Press the **Snap** or **Start Experiment** action buttons to perform an FCS measurement. The FCS measurement is performed at the same XY position as the z scan.

The z scan is especially appropriate to position the confocal volume on a cell membrane. Due to the shape of the confocal volume, the membrane should not be approached from the side but instead rather from the top of the cell. Please note that it is better to use the upper membrane for measurement, since the lower membrane might be too close to the glass bottom surface resulting in disturbing reflections. Besides using the **Z Scan** you can also position the membrane manually, albeit with less precision.



---

### (1) Manual Focusing on the Membrane

- Acquire an image of the cell.
- Place the focus above the cell and scan continuously.
- Focus slowly down until you see a fluorescence signal.
- Stop focusing.

If the signal is too low for imaging, the membrane can still be detected using the **Z Scan** feature.

### (2) Focusing on the Membrane by a Z Scan

The **Z Scan** measures the count rate at previously defined x, y positions. It is performed without table movement, which is at the fixed position of the laser beam.

- Acquire an image of the cell, focus through manually and select an equatorial section (middle of cell). Optional: Perform a **Z-Stack** that includes the membranes of the cell with the LSM and select an equatorial section.
- Go to the **Measure** tool to **Acquisition** and the **Positions** submenu. Position the region of interest at the site of the fixed laser beam in **Current Position** using the **Crosshair** or use the crossline in the **LSM image** to mark the position. In the latter case, **Scanner** must be active, since the **XY-Stage** will approach the marked position only during a measurement!
- Go to the **X-Y-Z Scan** tool and activate **Z**. The **Z Scan** display shows the current z-position of the laser beam.
- Select the **Start** and **End Position** and enter the **Step Distance**. If you have chosen an equatorial section going 10  $\mu\text{m}$  up and 10 mm down from the displayed current position are good values to start with. Also a step distance of 0.5  $\mu\text{m}$  should work well.

#### 5.3.19 Snap

If the **Snap** button is pressed, a measurement is triggered according to the **System Configuration, Acquisition** and **Correlator settings**.

However, in regard to positions **Snap** triggers the measurement only at the highlighted or current position.

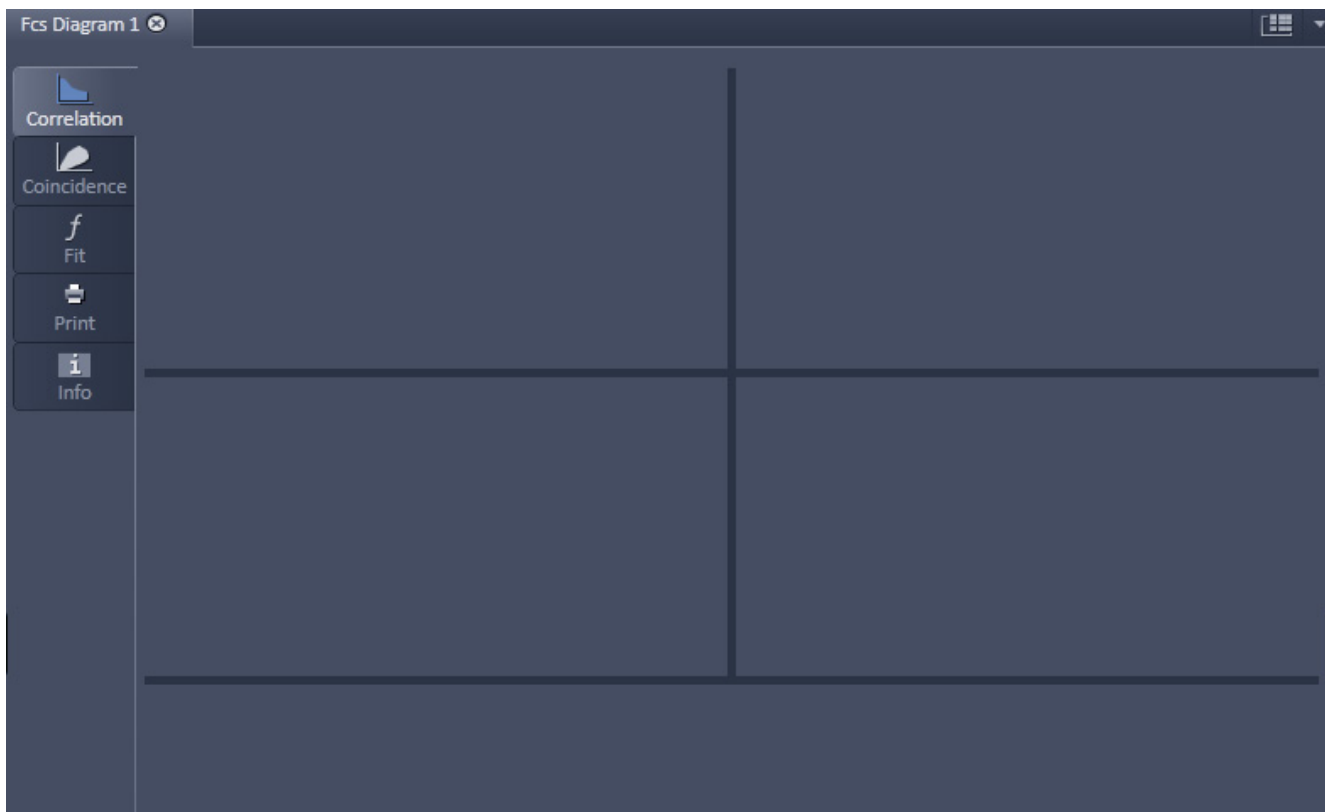
#### 5.3.20 Start Experiment

If the **Start Experiment** button is pressed, a measurement is triggered according to the **System Configuration, Acquisition** and **Correlator settings**.

All selected positions will be approached sequentially.

### 5.3.21 Taking FCS Measurements

- Click on the **New** document button to open a new **FCS Diagram** in an **Image Container**. New diagrams per session will be numbered starting with 0 (Fig. 347).
- Click the **Close** button (cross symbol) in the tab to close the **FCS Diagram**. The **Close Image** window will appear and prompt you to acknowledge closing the diagram if anything on the data was altered. Press **Yes** to save any changes, **No** to discard the alterations and **Cancel** to return to the diagram (Fig. 347).
- A scrollbar at the bottom of the window will allow you to view all data in case the content does not fit the window size.



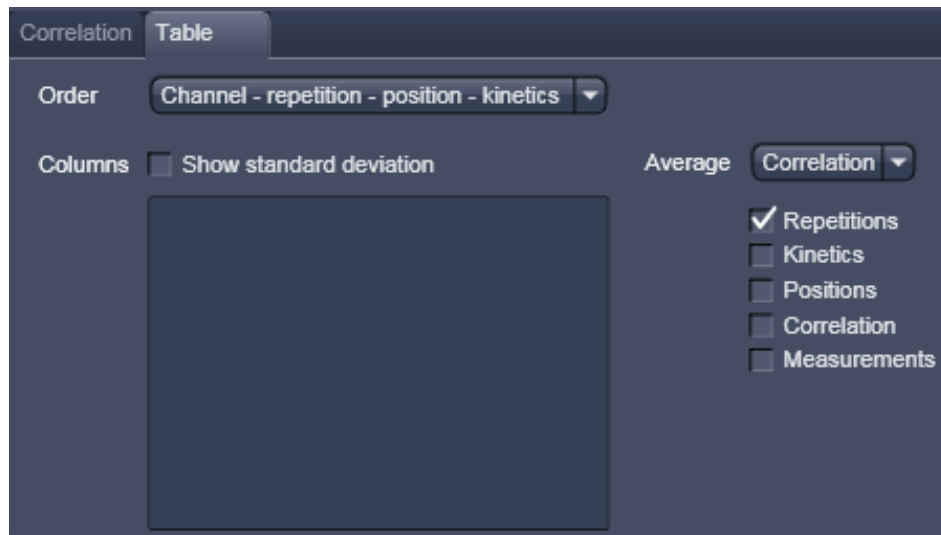
**Fig. 347** Image Container with new FCS Diagram opened

The arrow in the container can be used to expand or shrink the display in the vertical direction. The Open Image container on the right displays all currently open files. Its arrow can be used to expand or shrink the FCS diagram window horizontally.

If one of the **Option** tabs below the diagram are pressed, the corresponding options will be displayed. For the FCS diagram the **Correlation** and **Table** tabs (Fig. 348 and Fig. 349) are available.



**Fig. 348** Correlation tab



**Fig. 349** Table tab

The FCS diagram contains five layers, which can be selected by pressing the corresponding tab:

- **Correlation:** Displays the count rate trace, correlation function, photon counting histogram and pulse density histogram. It also displays the result table.
- **Coincidence:** Displays the coincidence diagram of a two channel measurement.
- **Fit:** Displays the fit graph and residuals as well as the used model.
- **Print:** Displays the layout and content of the hardcopy.
- **Information:** You can select a name, give a comment and view the meta data.

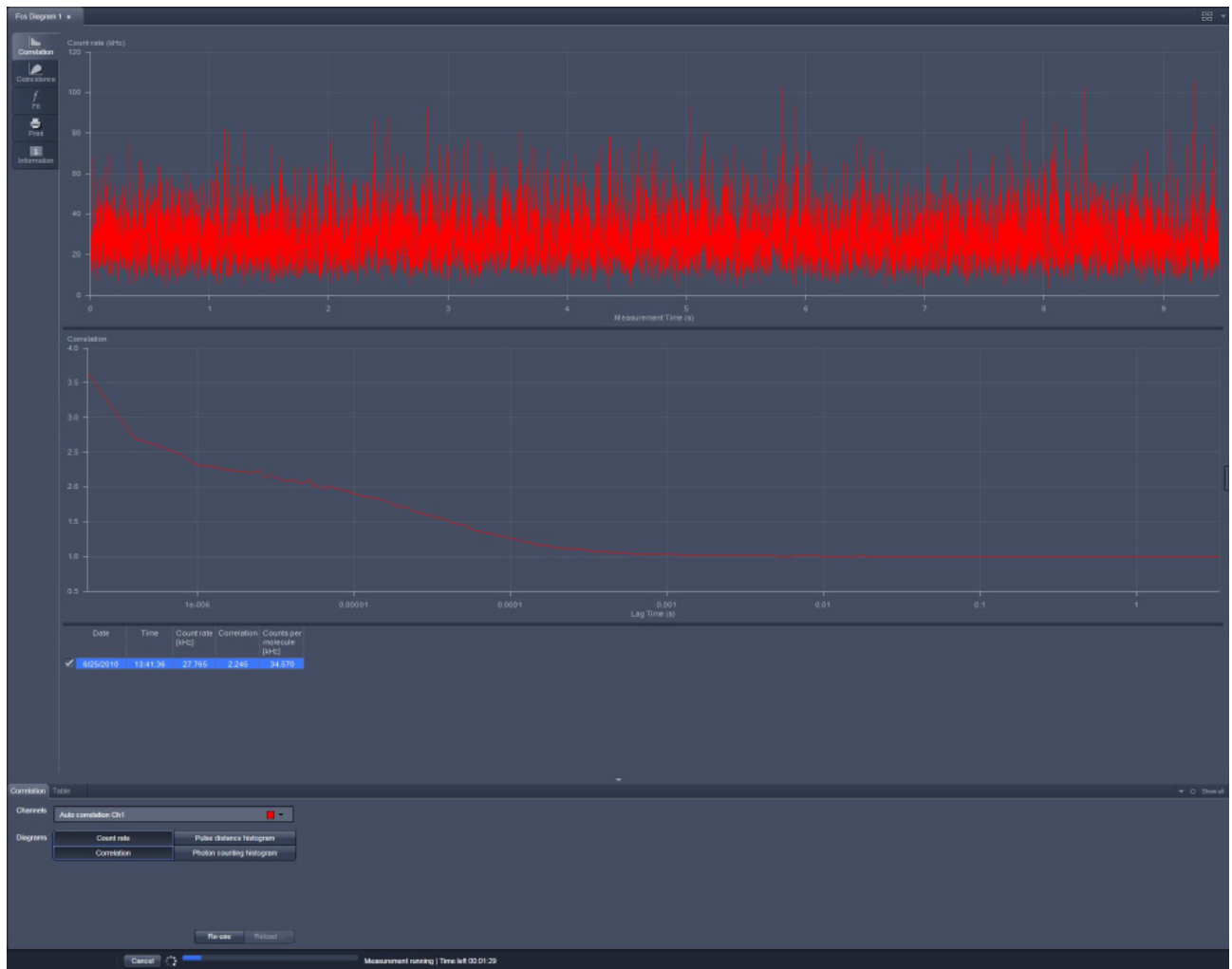


**Fig. 350** Close image window

☞ Pressing **New** will open an empty FCS diagram. To generate data in the **FCS Diagram** you have to trigger a measurement by pressing the **Snap** or **Start Experiment** button. After the measurement you can store the data and open it for later use. Stored data will be loaded in an extra FCS diagram in the specified container.

☞ If you close an **FCS Diagram** without prior saving, you will be asked in the **Close image** dialog, if you want to save the data (Fig. 350). Press **Yes** to save the diagram, **No** to discard the diagram or **Cancel** to interrupt the process.


### 5.3.21.1 Start and End of a Measurement



**Fig. 351 FCS Correlation window during data acquisition**

After setting the parameters the measurement can be run.

- Click on the **Snap** or **Start Experiment** action button to start the measurement and data analysis process. If **Snap** was chosen, exactly one measurement at the first **Carrier** or highlighted **LSM Image** (Fig. 351) position will be performed. If **Start** was selected, measurements will be performed on all selected positions in a sequence.

 Status lines at the bottom of the data evaluation window and in the **Open Image** display area show the progress of a current measuring procedure online. For non saved modified data a warning sign (orange triangle) will be displayed in **Open Images** (Fig. 358).

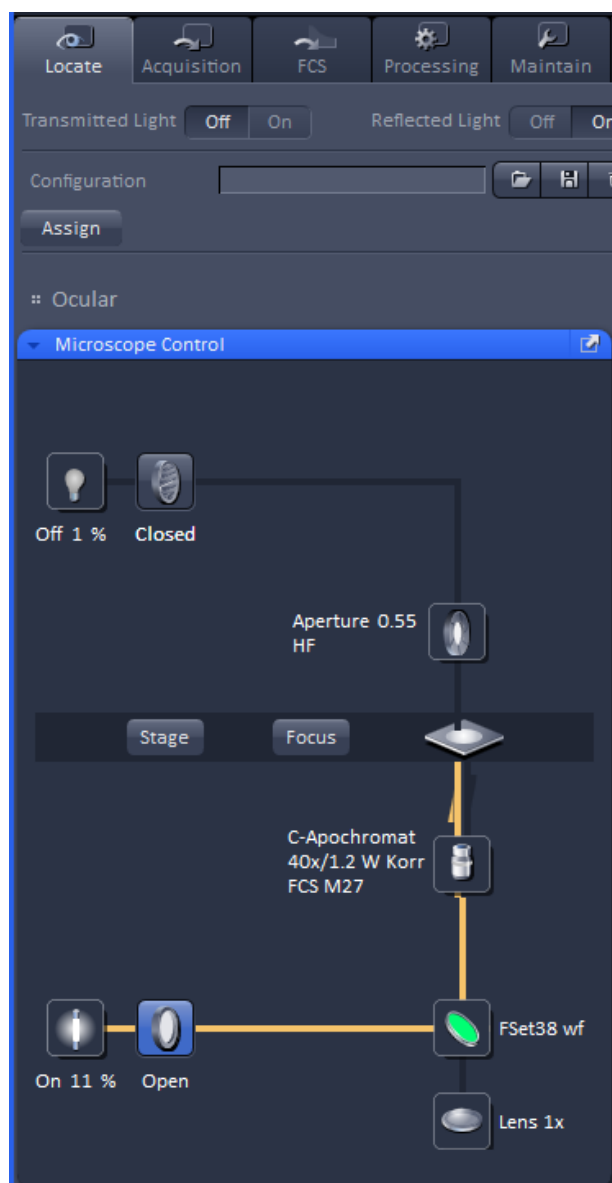
- Click on the **Stop** button to end the measurement. Only complete measurements will be available for storage; the interrupted measurement will be lost.
- Save the data in the **File** menu.

**(1) Positioning in solution**

- Align a carrier in the **Carrier Position** tool. Focus into the solution.
- Go to the **Measure** tool and the **Acquisition** panel. Choose **Current Position** or **Sample Carrier** and select the well(s) for the measurement.

**(2) Positioning in a cell**

Before positioning you have to select appropriate cells and image those. An overview of fluorescent expressing cells is best achieved by using the binoculars in transmitted and epi-fluorescent mode. Once cells with adequate expression levels have been identified they can be imaged with the LSM. Alternatively, suitable cells can be searched by using low zoom values in the LSM.



**Fig. 352** Microscope Control tool

**Visual inspection of the cells via binoculars**

- In the main toolbar, activate the **Locate** tab.
- Open the **Microscope Control** tool (Fig. 352).

The **Microscope Control** tool permits motorized functions including objective and reflector change settings as well as the illumination mode like transmitted or reflected light of the connected microscope to be controlled via the software.

☞ These microscope functions can also be operated directly on the microscope stand via assigned buttons or through the touch screen, if available. In that case, any changes are recorded by the software and displayed in the relevant windows / panels.

☞ For side and base port systems, the reflector has to be on a none position.

The **Microscope Control** tool contains the following functions:

**HAL On/Off** button for transmitted light: If the button is pressed, the control panel appears and the shutter automatically opens (Fig. 353). If you press the **On** button, the light intensity of the HAL lamp can be varied via the input box or slider. The light path will be highlighted by color in the diagram. Press the **On** button again to shut down the light. The color temperature for photo documentation can be switched on via **3200 K** button.

**HAL transmitted light Open/Close shutter** button: The shutter for transmitted light from the HAL lamp is switched on and off by repeated pressing.

**Condenser** button: The numerical aperture of the condenser is set via input box or slider. The turret position can be selected from graphical pop-up menu (only for motorized condensers).

**Stage** button: If the stage button is pressed, the Stage control panel will appear (Fig. 354). By pressing the **Stop** button you can interrupt any stage movement. The **Move to Zero** button will move the stage to the current zero positions of the x and y coordinates. The compass rose will move the stage in the direction of the arrowheads. Fast movement is obtained with the outer rose, slow movement with the inner rose. The **X-Position (µm)** and **Y-Position (µm)** display boxes show the actual x and y coordinates. You can edit the numbers by typing or using the arrowheads. If numbers were altered, the first click on the compass rose will bring the stage to the altered position. The **Step Size (µm)** display box show the currently use step size for stage movement. The value can be edited by typing or using the arrowheads. The **Zero Position Set** button set sets the x and y coordinates to 0.

**Focus** button: If the focus button is pressed, the **Focus** control panel will appear (Fig. 355). The **Z-Position** display box shows the current z-position. The number can be edited by typing or using the arrowheads. The nosepiece or stage will automatically update the new position. By pressing the **Stop** button, you can stop the current movement. The **Step Size (µm)** display box show the currently use step size for stage movement. The value can be edited by typing or using the arrowheads. The **Home** button sets the z-position to the predefined 0 value. Pressing **Load** will lower the nose piece (z-position) for objective change. **Work** brings the z-position back to the actual used position if the focus was zeroed or in **Load** position.

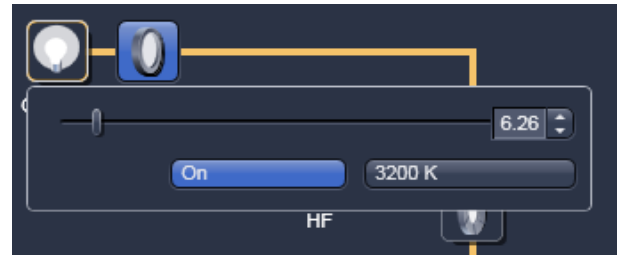


Fig. 353 Locate - Microscope Control tool

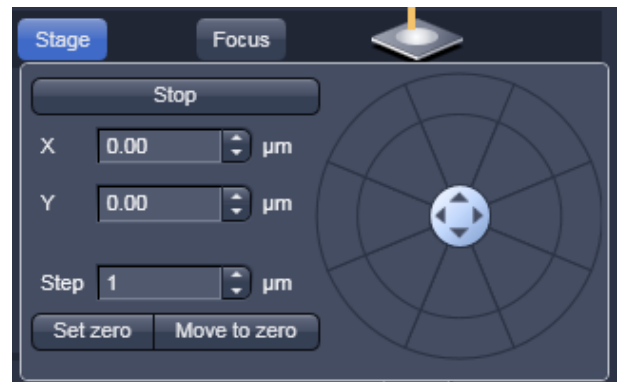


Fig. 354 Locate - Microscope Control tool, Stage

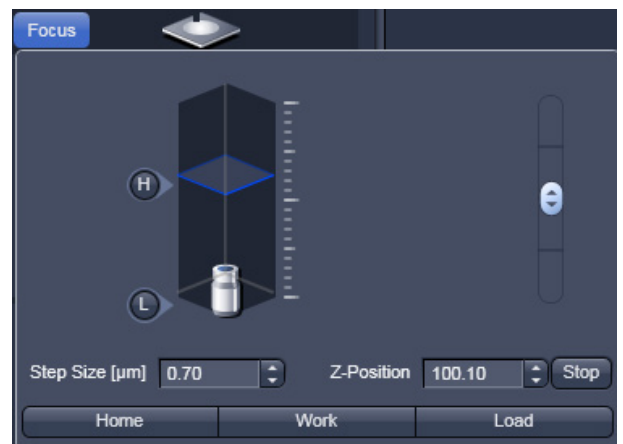


Fig. 355 Locate - Microscope Control tool, Focus

Home and Load positions can also be accessed from the z-position slider by pressing the **H** or **L** buttons. The z-position can be altered by grasping and sliding the **plane** or by using the arrow slider. The **plane** shows the actual z-position.

**Objective** button: The objective can be selected via graphical pop-up menu. Please note, that for FCS only the C-Apochromat 40x/60x W N1.2 is specified.

**Reflector** button: The reflector cube can be selected via graphical pop-up menu.

**Tube Lens** button: The tube lens can be selected via graphical pop-up menu.

**HBO Reflected Light Open/Close Shutter** button: The shutter for reflected epi-fluorescent light from the HBO lamp is switched on and off by repeated pressing. The light path will be highlighted in color.

### For transmitted-light observation

- Switch the HAL lamp on by the **HAL On/Off** button and adjust the light intensity.
- Activate the condenser function with the **Condenser** button.
- Press the **Objective** button to swing the required objective for FCS measurements into the working position.

### For Reflected-light Observation (Epi-fluorescence)

- Turn on the HBO power supply switch.
- Switch the HBO **Reflected Light Open/Close Shutter** into the Open position.
- Select the desired filter in the reflector turret by clicking the **Reflector** button. The filter will be automatically moved into the beam path to enable observation in epi-fluorescence.
- Select the desired tube lens by clicking the **Tube Lens** button. Normally, the correct lens 1x will be chosen automatically when the **Locate** tab of the main tool bar is pressed.
- Swing the required objective for FCS measurements into the working position by selecting the objective with the **Objective** button. We recommend to use the C-Apochromat 40x/1.2 W corr because of its optimized optics.



### 5.3.21.2 Loading Stored Data Files

To load stored data files you can use the **File** menu from the main toolbar (Fig. 356).

- Go to **File** and then choose **Open**. This will open the **Open** dialog box for the selection of drives, directories and subdirectories in which data files have been stored (Fig. 357).
- If you want to load a data file from another folder (drive / directory), click on the arrow button to the right of the **Look in** box. This opens a drop-down list box in which you can select from all available folders.
- Select the appropriate data file(s) via mouse click. Choose the extension you need and select the file you want to open. Data formats that will be recognized in are .fcs, and .raw. Raw and FCS data files (.raw/.fcs) will load together in a diagram if selected together. You can also open Images (.ism/.czi) which are affiliated with the measurement.
- Alternatively you can select recent .fcs files directly by choosing the corresponding file from the file list of the **Open** menu.

The status bar in the **Open Images** area displays the time progress for loading an image (Fig. 358).

- You can also drag a file from the Windows Explorer and drop it into the container in order to open the file.
- This will open the data files or images in new **Image FCS Diagrams** or new **Image**, respectively, in a new container. Note that the FCS and image will be loaded into different diagrams.

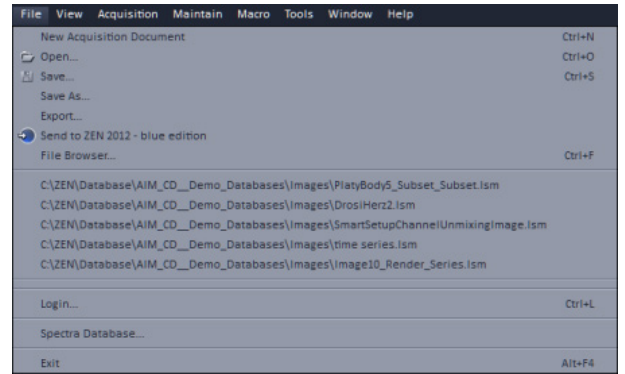


Fig. 356 File menu

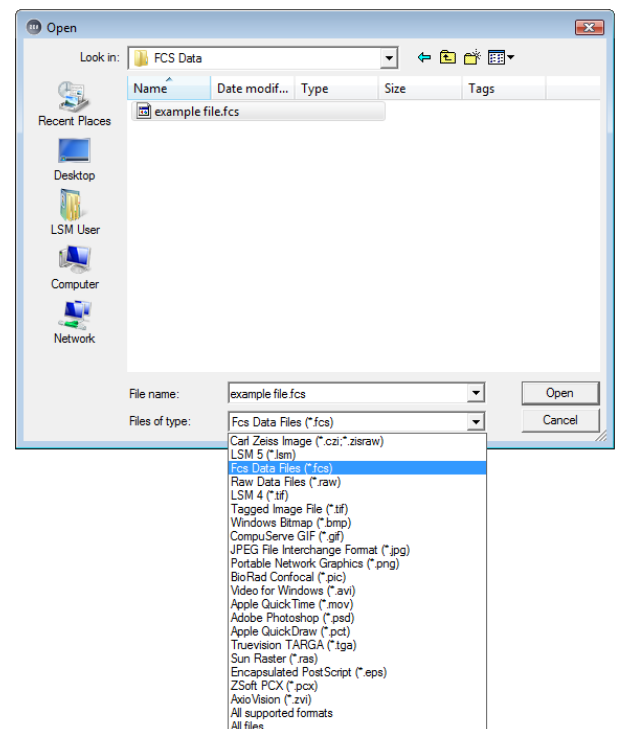


Fig. 357 Open dialog

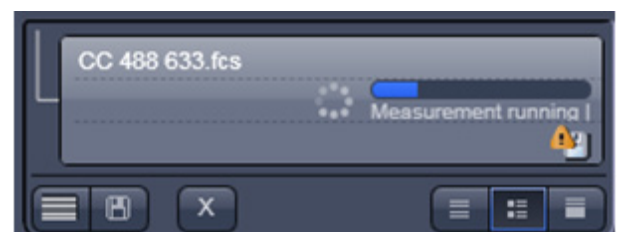




Fig. 358 Open Images with measurement in progress


The **Image FCS Diagram** consists of four data layers:

- FCS Correlation
- FCS Coincidence
- FCS Fit
- FCS Print

Each layer will display the data as they were stored last. As default, the first layer **FCS Correlation** will be displayed. Select other layers by pressing the corresponding tabs.

 If a file format is loaded that is not recognized by the FCS software, an empty **Image FCS Diagram** will open.

 If a corrupted .fcs or .raw data file is loaded, an empty **Image FCS Diagram** will be loaded.

 If a .fcs data file is associated with .raw data files, raw data files will be loaded in the **Image FCS Diagram** as well.

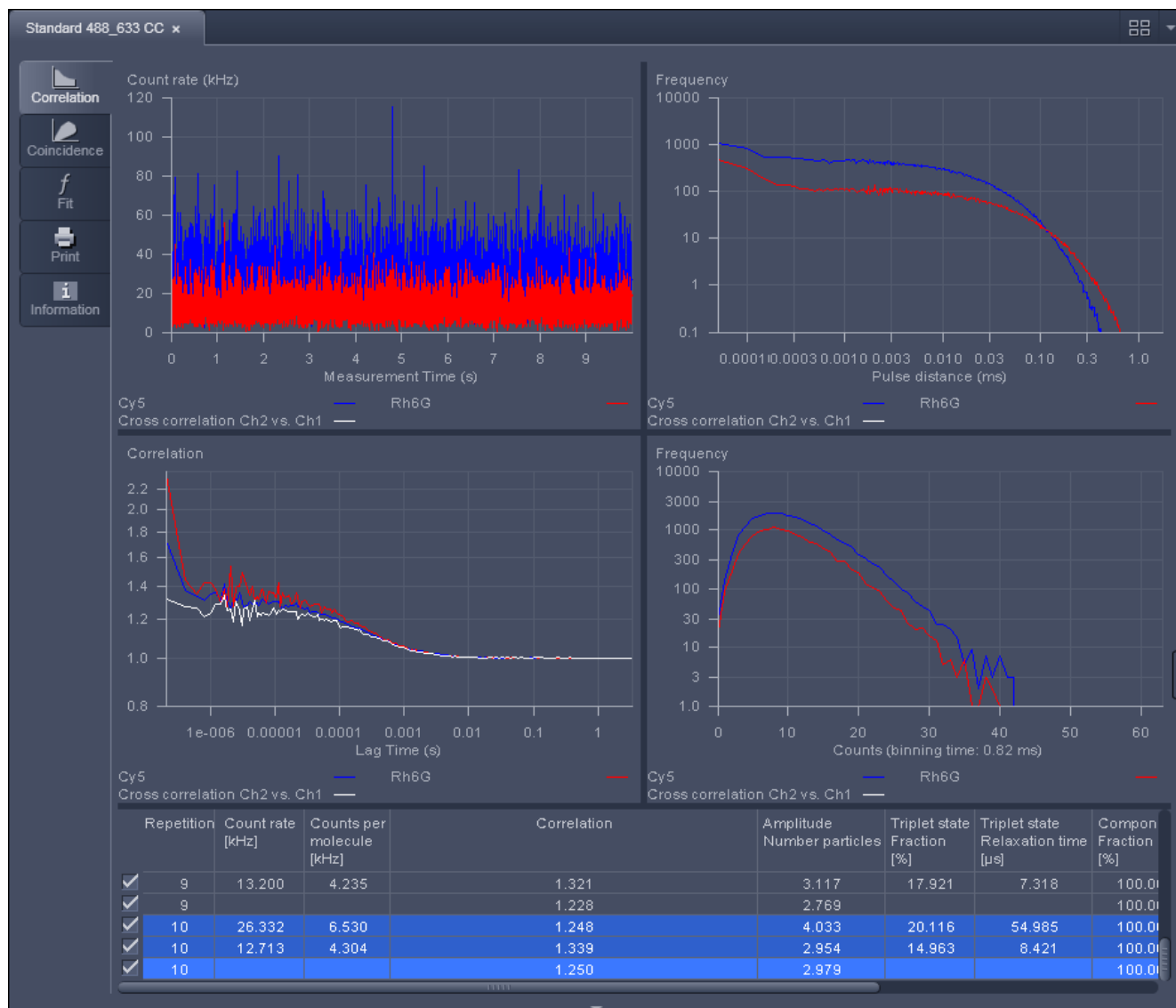
### 5.3.21.3 FCS Correlation Diagram

- Click on the **FCS Correlation** tab to activate the FCS Correlation display mode (Fig. 359).

The **FCS Correlation Diagrams** display graphic curves including **Count Rate**, **Correlation Function  $G(\tau)$** , **Pulse Density Histogram** (Photon Counting Histogram) and **Pulse Distance Histogram**. It also displays the **Result Table**. A scrollbar at the bottom of the diagram allows to view the content of the displayed window in case it is too small to show all data within the container size.

Choose the single diagrams you want to display by activating the corresponding buttons in **Diagrams** of the **Options / Correlation Diagrams** field. Selected diagrams will be highlighted in blue. By clicking on the appropriate button, the diagram can be toggled between **ON** and **OFF**.

The **FCS Correlation Diagram** can be expanded horizontally and vertically by closing the **File Handling Area** and by pressing the downward pointing arrowhead beneath the Table scrollbar. The arrowhead will point upwards and pressing it again will restrict the vertical extension of the diagram again. The size of the single diagrams and the table can be matched as required by moving the border lines. Click on the border line, hold down the mouse button, move the line in the required direction and release the mouse button.

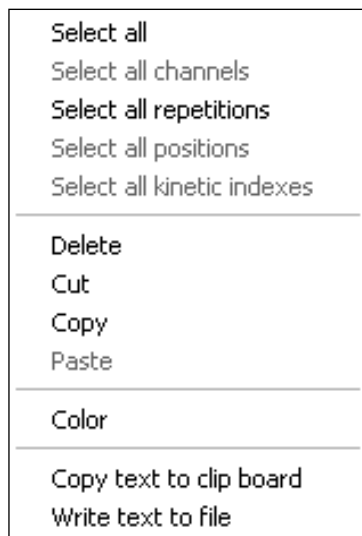


**Fig. 359** Image Container with FCS Diagram containing loaded data and FCS Correlation selected

The **Result Table** below the diagrams displays the measuring results. The width of the columns can be changed by moving the border lines. Also the order of the columns can be changed. For this purpose, click on the head line of the relevant column, hold down the mouse button and move the column to the required position. When the mouse button is released, the column is inserted in the new position. A scrollbar at the bottom of the table allows one to view all parameters that might not fit within the width of the table. A scrollbar on the right allows access to all repetitions.

The quality of the fit is displayed in the **chi<sup>2</sup>** display box of the **Fit table**. The X<sup>2</sup> (chi<sup>2</sup>) value should approach zero for highest quality.

- To select a line in the table, click on it with the mouse (multiple choice is possible by pressing the **Shift** or **Ctrl** key additionally). Selected lines are highlighted in color and displayed in the legends of the diagrams. The corresponding graphs are shown color coded in the graphic displays.



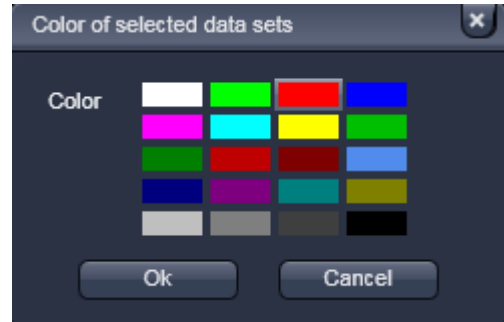
Selection of lines and properties of the table can be defined by pressing the right mouse button, when the cursor is within the table. This will open the **Result Table** context menu (Fig. 360) offering different options.

**Fig. 360** Result Table context menu

<b>Select all</b>	All measurements (rows) in the table will be selected regardless which line is highlighted.
<b>Select all channels</b>	All rows belonging to the same repetitive measurement as the highlighted row will be selected.
<b>Select all repetitions</b>	All rows belonging to the same channel of a repetitive measurement as the highlighted row will be selected.
<b>Select all positions</b>	All rows belonging to the same measurement position than the highlighted row will be selected.
<b>Select all kinetic indices</b>	All rows belonging to the same kinetic time point than the highlighted row will be selected.
<b>Delete</b>	The highlighted rows will be deleted.
<b>Cut</b>	The highlighted rows will be stored in the clipboard. Only if the data are pasted in a new window, the data are deleted from the old one.
<b>Paste</b>	Will paste rows currently stored in the clipboard into the table.
<b>Color</b>	Allows to select a color for the selected data sets
<b>Copy text to clipboard</b>	The contents of the table will be copied into the clipboard and can be opened in other text programs.
<b>Write text to file</b>	Will store the table in a .txt file. You will be prompted to choose a name and a folder.
<b>Properties</b>	Choosing <b>Properties</b> will open the <b>Table Properties</b> window (Fig. 365).

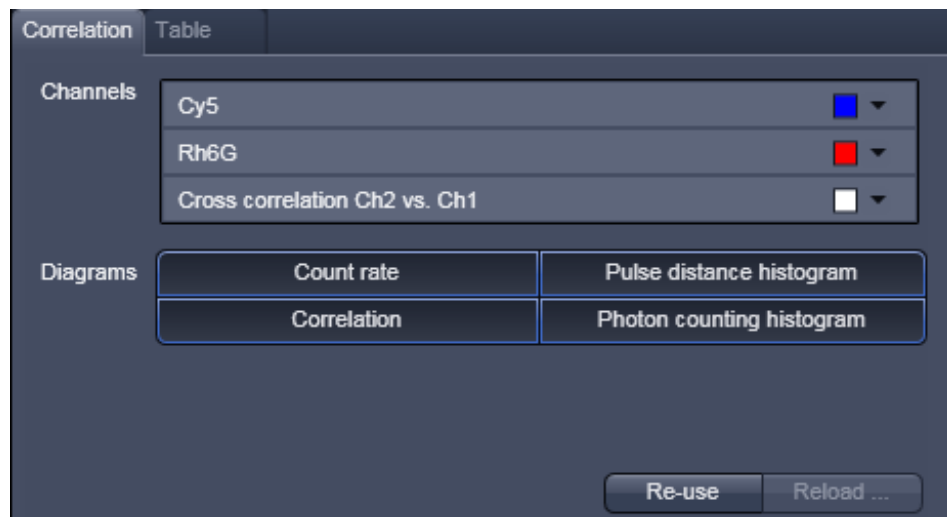
### Color assignment to FCS curves

- Select those FCS curves in the result table with the right mouse button and pressing the **Ctrl** key, for which you want to assign a new color.
- Click with the right mouse button in the table and select **Color** from the context menu. This will open the **Color of selected data sets** (Fig. 361) submenu window.
- Select the color you want to assign and press **Ok**. All selected curves will be displayed in the color. If you do not want to change color, press **Cancel**.



**Fig. 361** Color of selected data sets submenu window

#### 5.3.21.4 Image View Controls – Correlation Tab



**Fig. 362** View Options

In the **Correlation** tab (Fig. 362) you can handle files and displayed graphs.

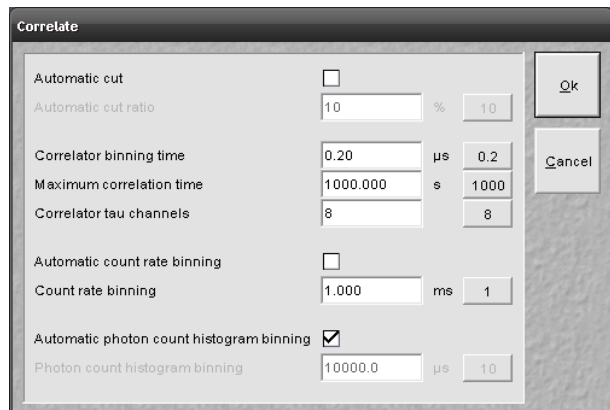
Three submenus are available:

- **Channels** display window
- **Diagrams** display window
- **Data handling** area

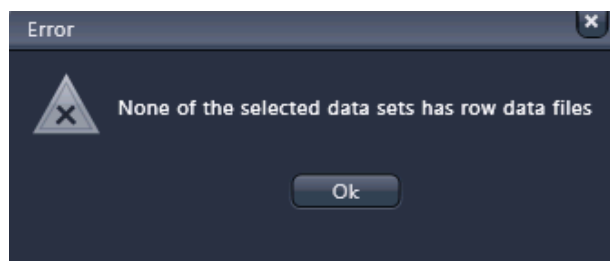
The **Channels** display window allows you to select a color for graphs of a channel using the drop down menu. All active channels will be displayed.

## Reuse

With a click on the **Reuse** button, the configuration used to record the selected measurement will be loaded.



**Fig. 363 Correlate window**




**Fig. 364 Correlate Error window**


## Reload

With **Reload** the current active measurement will be reopened. If raw data have been stored and attached to the measurement the **Correlate** window will appear (Fig. 363).

You can redefine the following settings:

- Automatic dust filter
- Correlator settings
- Count rate settings
- Photon count histogram settings

 Only those measurements will be recalculated with the new settings which have been selected in the original table. All other measurements will be opened unchanged. To select all measurements use the table context menu opened with a right mouse click in the table and choose the line **Select all**.

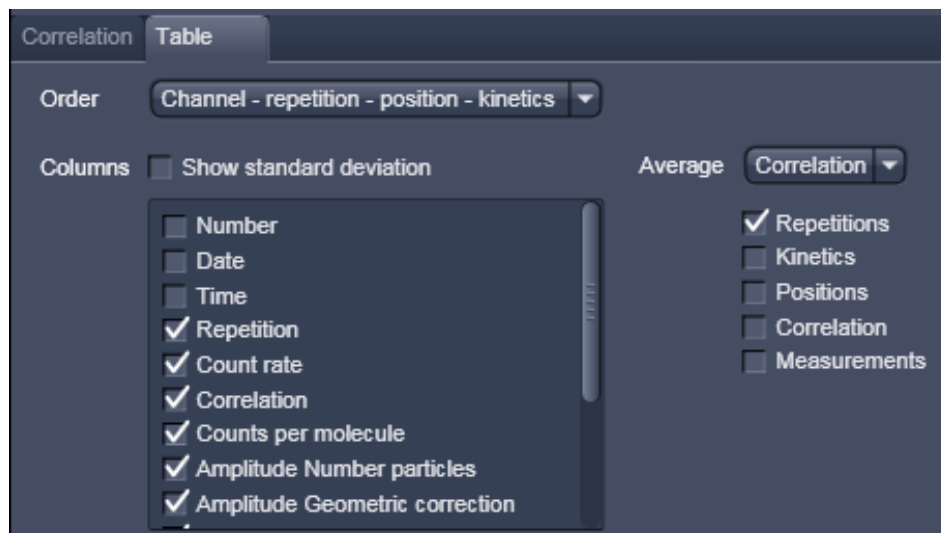
 If no raw data have been stored or are associated with the .fcs file or the measurement, an error message will be displayed (Fig. 364). No manipulation of the data is possible. Click **Ok** to continue working with the unmodified data set.

## Automatic dust filter

If the **Automatic cut** box is checked, you can type in a threshold in % in the **Automatic cut ratio** display box. This sets the threshold intensity for an electronic dust filter. The value (0 ... 100) will define the threshold in percentage. A default value of **10 %** can be selected by pressing the button on the right.

### 5.3.21.5 Image View Controls – Table Tab

The **Table** tab (Fig. 365) chosen from the **Option tool area** displays several options:



**Fig. 365 Table tab**

- In the **Average** display window you can select, how the data are averaged. You can either select **Fit results**, in which case the single values of the parameters are averaged, or **Correlation results**, where the single data points of each correlation functions are averaged and an average correlation function is calculated, from the drop down menu. You can check, from what measurements (**Repetitions, Kinetics, Positions, Correlation**) you want to built the average from by checking the corresponding boxes.
- In the **Order** display window you can choose, how different measurements are grouped together. The hierarchy of grouping of categories is determined by their listed sequence from the drop down menu.
- If the **Show standard deviation** box is checked, all parameters will be displayed with their values and the calculated standard deviation from different measurements.

 Only in the latter case the displayed average correlation function can be meaningfully fitted.

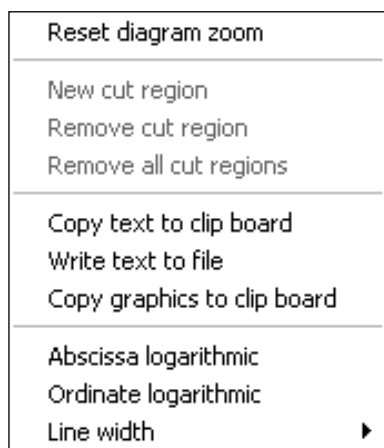
The **Displayed columns** selection window allows you to change the appearance of the table with regard to columns to be displayed. All parameters with their boxes checked will be visible in the table. The order of the displayed columns can be adjusted using drag and drop in the table.

Each row contains a check box on the left-hand side. Deactivation of these check boxes will exclude the relevant rows from all subsequent evaluation procedures like averaging. These settings will be stored by saving the data. Immediate reactivation is possible via the check box, if required. The scroll bar allows viewing all content of the display box.

**(1) Count rate trace**


In the **Count Rate** diagram the count rate(s) (CR) in kHz is plotted vs. running time. If a cross correlation set-up is used, the count rate trace for each channel is displayed. If you have set an electronic dust filter in the **Measurement** tool in **Processing**, loaded raw data files with an electronic dust filter activated or placed cut limits manually the cut off regions will be displayed as matted areas.

You can zoom in the diagram by pressing the left mouse button and drawing a rectangle of the area you want to zoom in. After disengaging the button, the zoom image will be displayed.



**Fig. 366** Count Rate context menu

By clicking the right mouse button within the diagram you obtain the **Count rate** context menu (Fig. 366).

- If you have zoomed in, you can go to the original image size by choosing the **Reset diagram zoom** option.
  - If you have a raw data file available, you can define cut regions by choosing the **New cut region** option. The cut region size can be adapted by two sliders. The cut out region is thereby displayed as a matted box (Fig. 295). You can select independent cut regions for different channels of a cross correlation experiments. In cross-correlation calculations, a cut region in one channel will automatically define the same cut region in the other channel. You can select more cut regions by repeatedly choosing this option.
  - These regions can overlap. **Remove cut region** will remove the last cut region. By repeatedly choosing this option, the cut regions in the reverse order of their creation will be removed. **Remove all cut regions** will remove all cut regions simultaneously.
-  The remaining parts of the count rate disrupted by cut out regions will be separately correlated and the average will be calculated and displayed.
- **Copy text to clipboard** will copy the diagram coordinates into the clipboard, from which they can be pasted into other programs like Excel. **Write text to file** will store the diagram coordinates in a .txt file. You will be prompted to choose a name and a folder before saving.
  - Choosing **Abscissa logarithmic** or **Ordinate logarithmic** will display the abscissa or ordinate in a logarithmic scaling.
  - The **line width** allows you to select the thickness of the graph. Six settings are possible.



**(2) Correlation G( $\tau$ )**

The diagram shows the correlation functions for each activated channel. The zoom function can be used to display certain diagram areas of interest in an enlarged form. Use the left mouse button to click on the margin of the area of interest in the diagram, keep the mouse button pressed and draw a rectangular above the area of interest in any required direction. On release of the mouse button, the selected area is displayed in an enlarged form in the diagram. The scaling of axes is matched automatically.

By clicking the right mouse button you can choose between different options in the **Correlation** context menu (Fig. 367).

- Select the line **Reset Diagram Zoom** with the left mouse button to reset the zoom value.


The data (measuring values) of the diagram can be copied to the clipboard or stored directly as an ASCII file via the context menu.


- Select the line **Copy data to clipboard** with a click of the mouse if you want to insert the data directly into other WINDOWS programs via the clipboard. The Paste function permits direct insertion of these data into the required program.
- Select the line **Write text to file** to store the data in an external ASCII file (.txt). Normalized values will also be exported in this way.

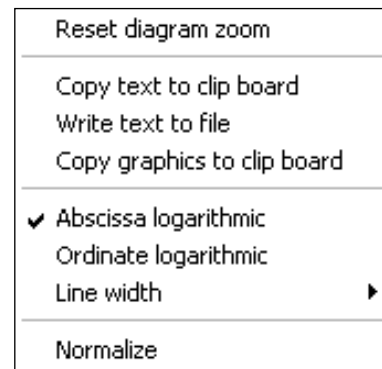
 Note that the **Export** button in the **Display Correlation** window will only export the original values.

The diagram display can be manipulated with the context menu as follows:

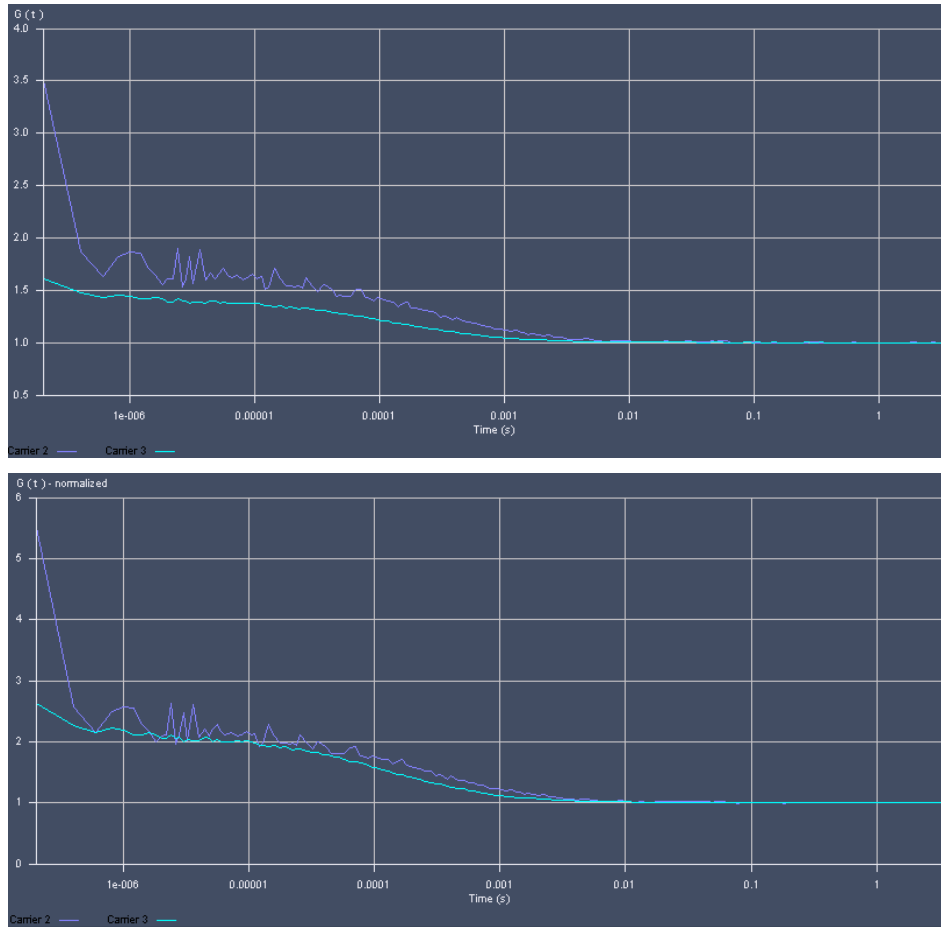
- Selection of **Abscissa logarithmic** will scale the x-axis logarithmically
- Selection of **Ordinate logarithmic** will scale the y-axis logarithmically.
- The **line width** allows you to select the thickness of the graph. Six settings are possible.
- Selection of **Normalize** will normalize the curves to 2 (Fig. 368):

 If **Normalize** is selected the G(0) value corresponding to the number of diffusing particles will be normalized to 2, not the total correlation to which also other processes like triplet state can contribute. All other values (subtracted by 1) will then be multiplied by the correction factor defined by the ratio of 1 to [G(0)-1] and increased by 1, hence  $G(\tau)_{\text{normalized}} = [1 / (G(0)-1) * (G(\tau)-1)] + 1$ . Deactivating **Normalize** will display the normal correlation curve.

 Normalization only works for a curve, for which a fit has been conducted in **FCS Fit** and hence a G(0) is available.



**Fig. 367 Correlation context menu**



**Fig. 368** The Correlation Curve window in normal (upper graph) and normalized (lower graph) display

### (3) Pulse distance histogram

This diagram shows the frequency plotted against the times elapsed between two subsequent pulses (or: photons recorded from the detector). To obtain this histogram, the time distance between two photons is evaluated from the raw data.

You can zoom in the image by pressing the left mouse button and drawing a rectangle of the area you want to zoom in. If the button is disengaged, the zoom image is displayed.

By clicking the right mouse button you can choose between different options in the **Pulse Distance Histogram** context menu (Fig. 369).

- **Reset diagram zoom** will reset any zoomed image.
- **Copy text to clipboard** will copy the diagram coordinates into the clipboard, from which they can be pasted into other programs like Excel. **Write text to file** will store the diagram coordinates in a .txt file. You will be prompted to choose a name and a folder before saving.
- Choosing **Abscissa logarithmic** or **Ordinate logarithmic** will display the abscissa or ordinate in a logarithmic scaling.
- The **line width** allows you to select the thickness of the graph. 6 settings are possible.

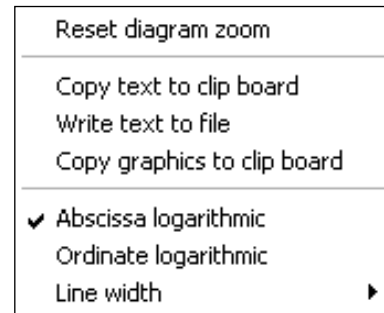


Fig. 369 Pulse Distance Histogram context menu

### (4) Photon counting histogram

This diagram (also called Photon Counting Histogram) shows the frequency plotted against the photon number in a certain time bin. To obtain this histogram, the number of pulses (or: photons recorded from the detector) in a moving time window are recorded and included in a histogram. You can determine the binning time in the **Measure** tool in **Processing** under PCH or if you load a raw data file with the **Reload** button.

You can zoom in the image by pressing the left mouse button and drawing a rectangle of the area you want to zoom in. If the button is disengaged, the zoom image is displayed.

By clicking the right mouse button you can choose between different options in the **Pulse density Histogram** context menu (Fig. 370).

- If you have zoomed in, you can go to the original image size by choosing the **Reset diagram zoom** option.
- **Copy text to clipboard** will copy the diagram coordinates into the clipboard, from which they can be pasted into other programs like Excel.
- **Write text to file** will store the diagram coordinates in a .txt file. You will be prompted to choose a name and a folder before saving.

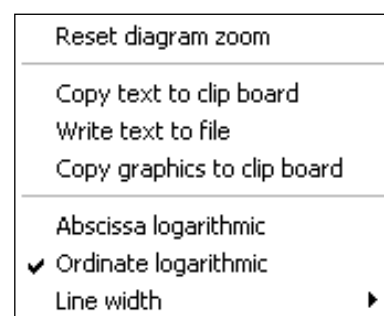
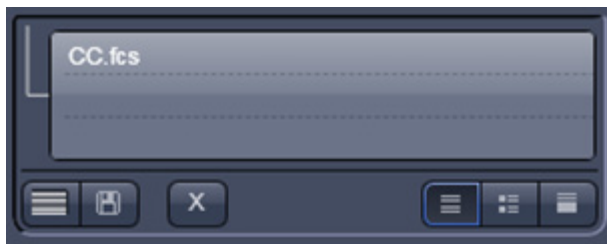
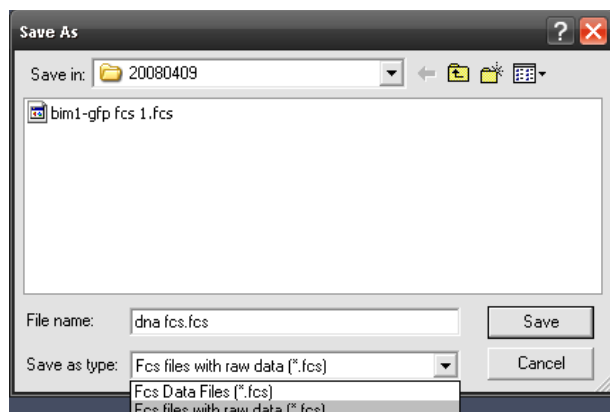


Fig. 370 PCH context menu

- Choosing **Abscissa logarithmic** or **Ordinate logarithmic** will display the abscissa or ordinate in a logarithmic scaling.
  - The **line width** allows you to select the thickness of the graph. 6 settings are possible.
- ☞ With the ordinate set to a logarithmic scale all zero frequencies will be displayed as vertical tabs, since the log0 goes to infinity low values.



**Fig. 371** Open images column



**Fig. 372** Save Raw Data window

### 5.3.21.6 Saving Correlation Results

You can save correlation data in the **File** menu of the menu bar.

#### (1) Save and Save as

- **Save** will save the data in .fcs format and will overwrite an older version. This function is also available in the **Images and Documents** column (Fig. 371) by pressing the **disc** button.
- **Save as** allows you to save the whole data set (curves, fitting results, fit parameters, raw data) to a disk. If **Save as** is pressed you will have the choice between **FCS data files (.fcs)** without raw data or **FCS files with raw data (.fcs)** attached by selecting the appropriate settings from the pull-down menu (Fig. 372).

☞ Note that raw data are only available, if the **FCS files with raw data was selected.**

The **Save FCS** menu offers the possibility of entering a file name in the **Name** field and to choose an appropriate **Directory**.

☞ Note that it is only possible to store the data as ANSI text. Binary file formats of previous releases are no longer available.

☞ If raw data were saved along with the FCS file, the raw data of each single measurement channel will be stored attached to the .fcs file. .raw files will bear the same name than the .fcs file with name extensions, which identify the repetition and the channels.

☞ You can enter a sample comment in the **Sample Comment** display box by typing. This comment will be saved along with the data.

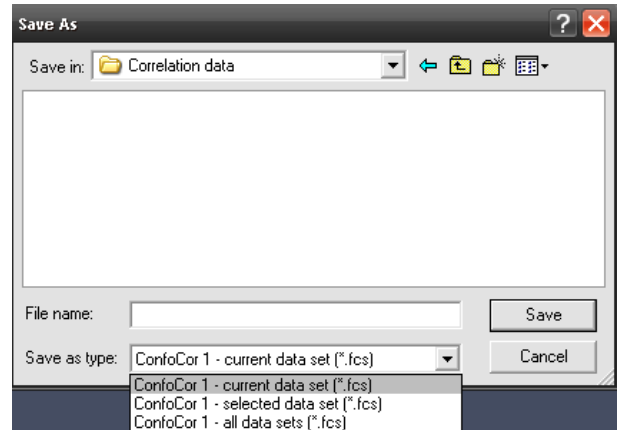
## (2) Export

With **Export**, the measured data will be exported in a ConfoCor 1-compatible format and can be handled using the FCS Access Fit program.

In the **Export** window you can enter a name in the **File name** field and a type in the **Data type** field. In the **Save in** pull down menu you can select a directory.

You can specify if only the selected rows (highlighted), the current row (the current selected one) or all rows will be exported (Fig. 373).

Exported files can be opened again with the **File Open** button. All selected files will be loaded in one **FCS Correlation diagram**.



**Fig. 373** Save Raw Data window

### 5.3.21.7 Coincidence

The coincidence analysis generates a two-dimensional color-coded count rate histogram (Fig. 374) in this diagram. During the measurement the count rates in channel 1 (red) and channel 2 (blue) are registered in small time windows and the respective frequencies are calculated. The count rate in channel 1 is then plotted versus the count rate in channel 2. All values are incremented in the diagram and count rates occurring simultaneously in both channels will populate the diagonal of the diagram.

- ☞ All the table functions in the **Coincidence** mode are identical to those in the **Correlation** mode
- ☞ The **Coincidence diagram** is currently only a display help and data cannot be exported. There are no options available for the Coincidence diagrams. Coincidences can support analysis in case of rare event detection of a standard cross-correlation experiment, when the measurement time drops short for sufficient statistical significance, because it might be prohibitively long - as a rule of thumb; approximately 1000 transitions of a labeled species are required to generate a correlation curve of sufficient quality.

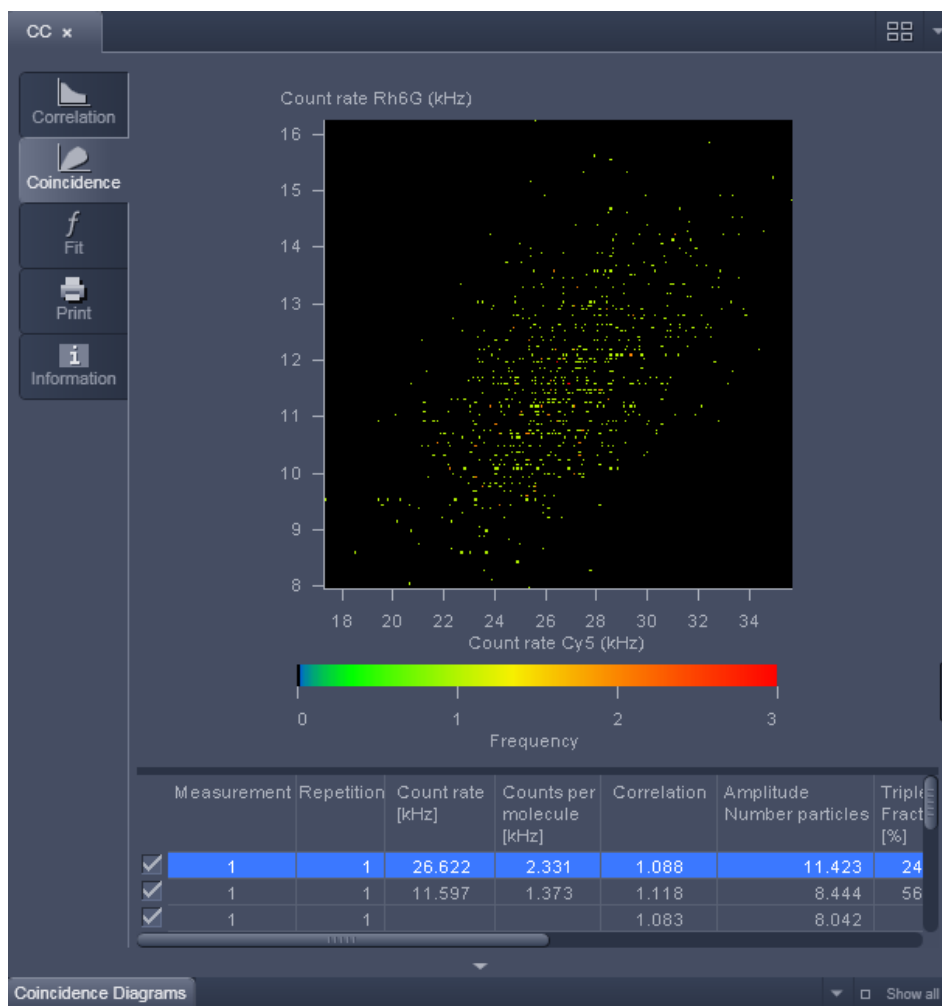


Fig. 374 Coincidence diagram panel

### 5.3.21.8 Fit

- Click on the **Fit** tab to activate the **Fit** display mode (Fig. 375).

In general this menu allows you to work with already measured and probably also fitted correlation curves. The intention is to have the possibility of performing other fit using different fitting parameters if the automatic fit did not yield optimal results.

The panel is divided in Diagrams, Result Table, Model Field and Fit action buttons.

#### (1) Diagrams

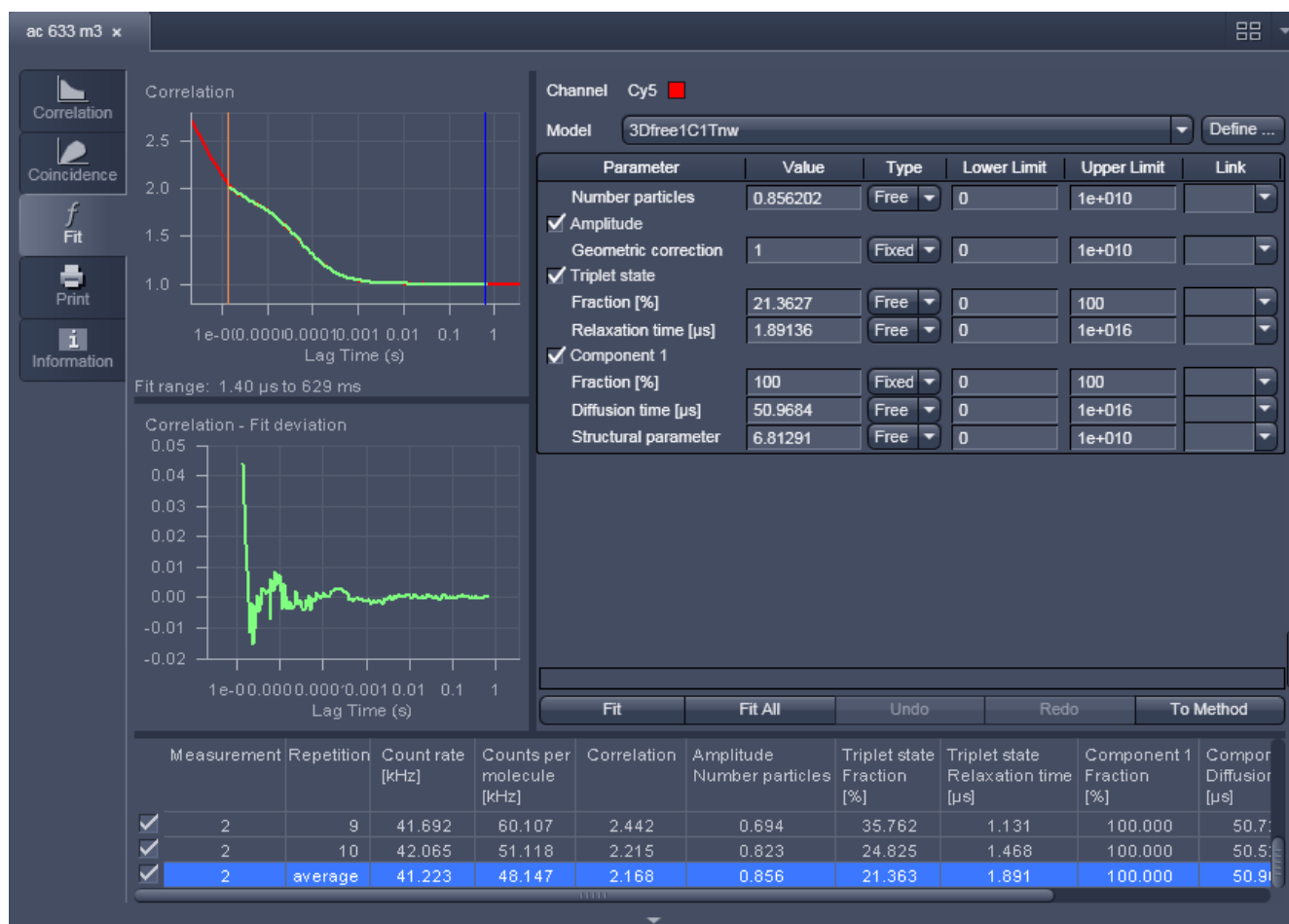


Fig. 375 Fit diagram panel for correlation analysis

For fitting to a correlation model the upper graph (Fig. 375) shows the **Correlation  $G(\tau)$  Fit diagram** (correlation plotted versus the correlation time) with the overlaid fit graph. It also displays the fit range defined by the red (start value) and the blue (end value) bars. The lower **Fit deviation** curve depicts the fit residuals. If an experiment is loaded for which no fit has been conducted yet, only the measured **Correlation  $G(\tau)$**  curve is shown and no overlaid fit curve. **The Fit deviation** diagram will be empty.

For fitting to a PCH model the upper graph (Fig. 376) shows the **PCH Fit diagram** curves (frequency against count rate per bin) with the overlaid fit graph. If an experiment is loaded for which no fit has been conducted yet, only the measured curve is shown and no fit curve. **The Fit deviation** diagram will be empty.

The **Line width** pull down menu allows to select the line width for the selected graph.



**Fig. 376** Fit diagram panel for PCH analysis

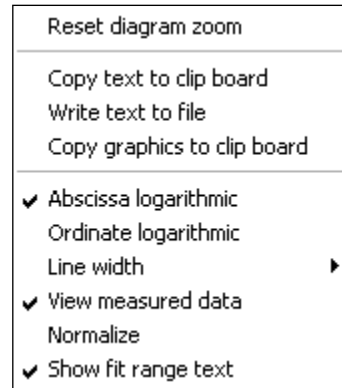
The **Zoom** function of the **Fit diagrams** can be used to display certain diagram areas of interest in an enlarged form:

- Use the left mouse button to click on the margin of an area of interest in the diagram, keep the mouse button pressed and draw a rectangular area above the area of interest in any required direction. On release of the mouse button, the selected area is displayed in an enlarged form in the diagram. The scaling of axis is matched automatically.

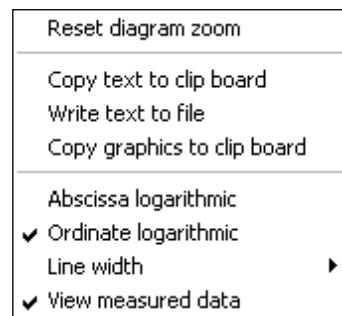
The context menu can be used to reset the zoom to its original value, copy the data, and adjust the display.



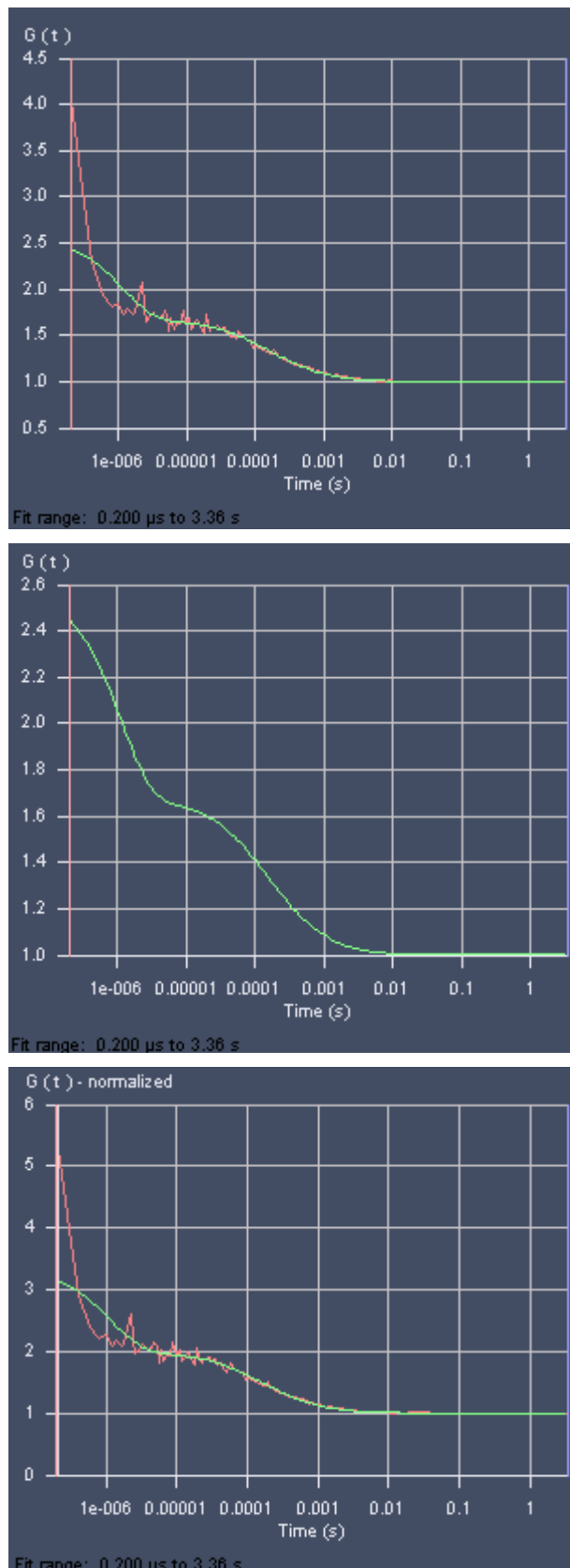
- Click on the diagram with the right mouse button to open the context menu for the **Fit Correlation** (Fig. 377) respectively **Fit PCH** diagrams (Fig. 378).
- A click on the **Reset Diagram Zoom** with the **left** mouse button will reset the zoom value. The zoom can be changed by framing an area you want to zoom in with the left mouse bottom pressed. Upon release of the mouse button, the selected area will be zoomed in. Each graph will rescale automatically according to the maximum values.
- Select the line **Copy data to clipboard** with a click of the mouse if you want to insert the data directly into other WINDOWS programs via the clipboard. The **Paste** function permits direct insertion of these data into the required program.
- Select **Write to file** to store the data in an external ASCII file (.txt). Only the coordinates of displayed curves are exported.
- Select **Abscissa logarithmic** or **Ordinate logarithmic** to scale the x- or y-axis, respectively, logarithmically.
- Select **Line width** to select the width of the displayed graph. The width selection becomes available by pressing the arrow.
- Select **View measured data** will display the measured Correlation or PCH curve in addition to the Fit curve. If this option is not selected, only the Fit curve is displayed.



**Fig. 377** Context menu of the Fit Correlation diagram



**Fig. 378** Context menu of the Fit PCH diagram



**Fig. 379** Fit Correlation Curve (standard display), with fit curve only, in normalized form

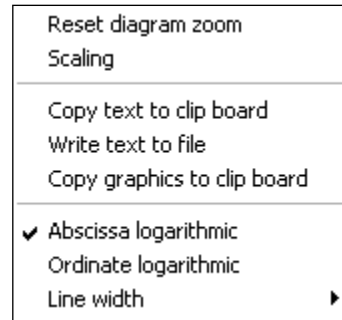
- Select **Normalize** to display the correlation curves in a normalized form (Fig. 379). The amplitude of the diffusion contribution will be normalized to 2, not the total amplitude, if other term like triplet state were used in their normalized form. This option is only available for the **Fit Correlation** diagram.
- Select **Show fit range text** to display the start and end values of the fitted data of the correlation curve defined by the red and blue bars. The positions of the bars can be adjusted by drag and drop. This option and the bars are only available for the **Fit Correlation** diagram. **Start Channel** and **End Channel** determine which part of the correlation curve should be fitted to the model. The start and end position of the channels will be displayed as correlation times (in  $\mu\text{sec}$ ) and not in absolute channel numbers, since those will change dependent on the **Correlator** settings defined in the **Measure** tool in **Processing** panel.

The zoom function can be used to display certain areas of interest in the **Fit deviation** diagram.

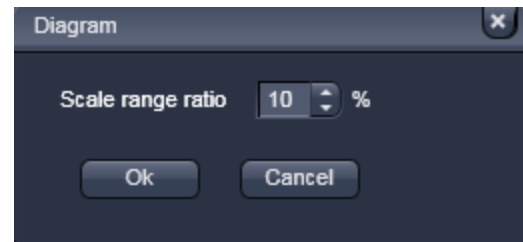
- Use the left mouse button to click on the margin of the area of interest in the **Fit deviation** diagram, keep the mouse button pressed and draw a rectangular above the area of interest in any required direction. On release of the mouse button, the selected area is displayed in the diagram in an enlarged form. The scaling of axes is matched automatically.

The context menu of the **Fit deviation** diagram (Fig. 380) can be used to reset the zoom to its original value, copy the data, and adjust the display.

- Click on the diagram with the **right** mouse button. The **Fit deviation** context menu opens.
- Click on the line **Reset Diagram Zoom** with the left mouse button to reset the zoom to its original value.
- Select the line **Scaling** to open the **Diagram** scaling window (Fig. 381). Enter the required percentage value (from 1 to 100) for the scaling and click on **OK** to rescale, **Cancel** to keep the old value. The scaling of the G(t) axis will be adjusted.
- Select the line **Copy data to clipboard** with a click of the mouse if you want to insert the data directly into other WINDOWS programs via the clipboard. The Paste function permits direct insertion of these data into the required program.
- Select **Write to file** to store the data in an external ASCII file (.txt).



**Fig. 380** Context menu of the Fit Deviation diagram




**Fig. 381** Scaling menu

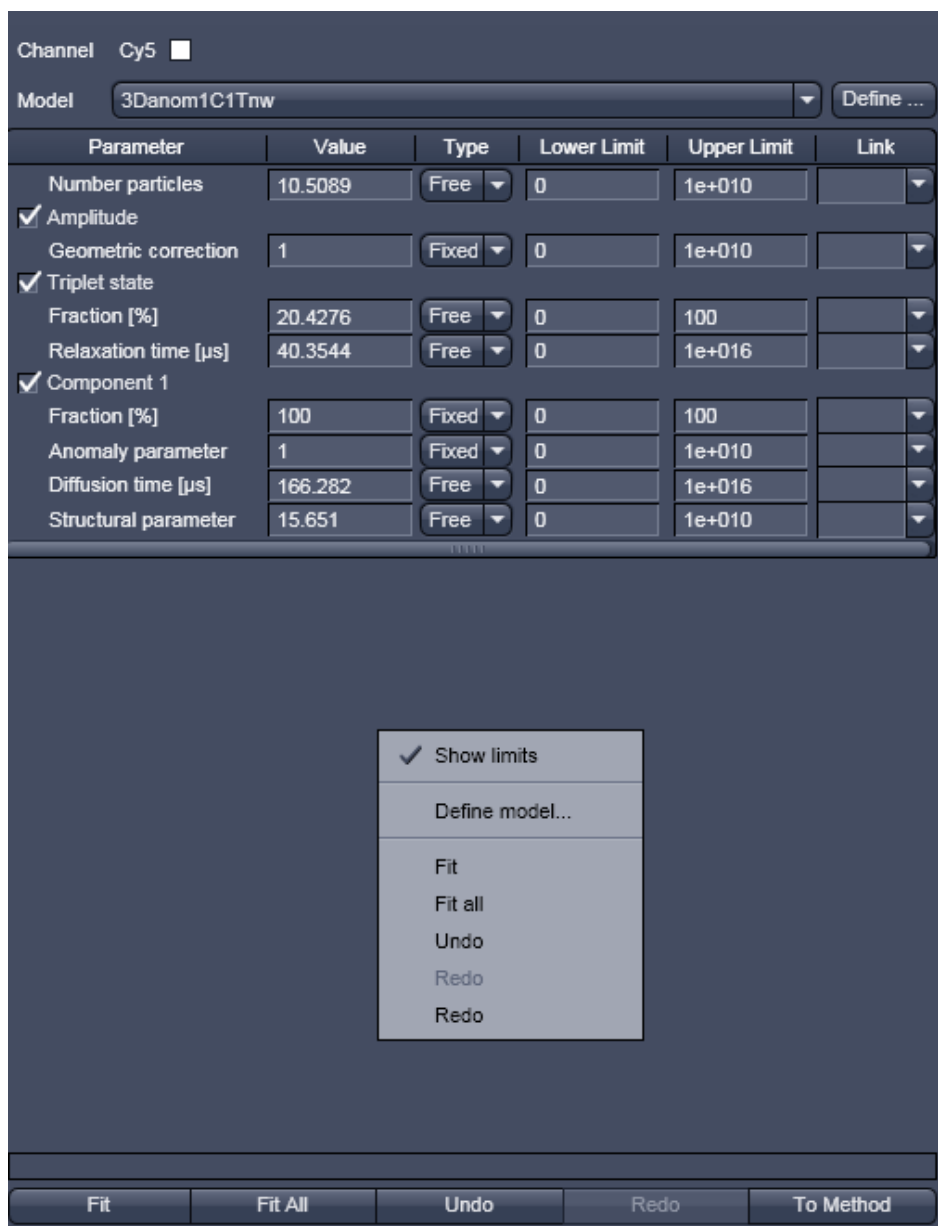
**(2) Fit table**

The **Fit Table** displays the values of the fitted parameters and will be updated after pressing the **Fit** tab.

 All the **Fit table** functions in the **FCS Fit** mode are identical to those in the **Fit** application.

Measuring rows in the **Result table** can be activated / deactivated by checking / unchecking the corresponding check boxes. Deactivation of these check boxes will not exclude the relevant rows from all subsequent evaluation procedures, but only from the average. Average curves are updated in respect to the rows taken into consideration.

-  Lower and upper limits are only displayed if selected. To select, click with the right mouse button into the result table to open the context menu (Fig. 382).



Channel Cy5

Model 3Danom1C1Tnw Define ...

Parameter	Value	Type	Lower Limit	Upper Limit	Link
Number particles	10.5089	Free	0	1e+010	
<input checked="" type="checkbox"/> Amplitude					
Geometric correction	1	Fixed	0	1e+010	
<input checked="" type="checkbox"/> Triplet state					
Fraction [%]	20.4276	Free	0	100	
Relaxation time [μs]	40.3544	Free	0	1e+016	
<input checked="" type="checkbox"/> Component 1					
Fraction [%]	100	Fixed	0	100	
Anomaly parameter	1	Fixed	0	1e+010	
Diffusion time [μs]	166.282	Free	0	1e+016	
Structural parameter	15.651	Free	0	1e+010	

Context menu:

- Show limits
- Define model...
- Fit
- Fit all
- Undo
- Redo
- Redo

Buttons: Fit, Fit All, Undo, Redo, To Method

**Fig. 382** Fit table with the Show limits menu activated in the context menu

**(3) Channel display field**

The Channel display field shows the active channel (selected name and color), for which the **Fit All** button applies. It is the last selected channel. If for example, you have selected rows in the Result table belonging to channel 1, channel 2 and a cross correlation channel, the last selected channel will be displayed and if you press **Fit** all selected rows will be updated. If you press **Fit All**, only the rows belonging to the displayed channel will be updated.

**(4) Model field**

Load a suitable model from the **Model** pull down menu. The name of the model will be displayed in the **Model Display** box. All the terms and components of the model will be displayed in a tabular form. You can deselect and select terms by unchecking / checking the boxes on the left of each term.

After selecting a model the corresponding model will be displayed in the Fit table. All parameters belonging to one term are listed as a block in the **Parameter** column, which shows the term and parameter names.

The current parameter values are displayed in the **Values** column. You can edit a value by typing. The handling of the parameter is defined in the **Type** column. By clicking with the left mouse button in the respective field, a button tab becomes available. Use the arrow head to open the drop down menu. Three options for the parameter setting will become available (Fig. 383):

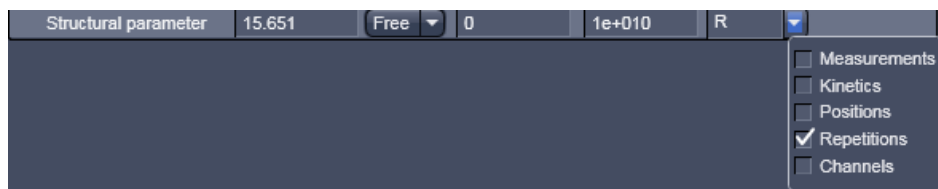


**Fig. 383** Type drop down menu

- If you select **Free**, the parameter will be defined as free. After the fit, the field will contain the fit result for the parameter. The start values of the parameter (initial guesses) will be calculated by an algorithm.
- **Fix** allows you to fix the parameter. This is useful if you know its value from other measurements.
- **Start** will assign a start value to the parameter and leaves the parameter free to fit. In this case, no initial guesses will be made.

Upper and lower values for the fit parameters can be entered in the fields of the Upper limit and Lower limit columns. Defaults are the extreme possible values. If fit limits fall short or are exceeded, the fit will try to find another solution or will fail.

The global link status of a parameter is displayed in the Link column. By clicking with the left mouse button in the respective field, a button tab becomes available. Use the arrow head to open the drop down menu. Five options for the linking a parameter will become available (Fig. 384):



**Fig. 384** Link drop down menu

- **Link measurement:** links a parameter from different measurements (abbreviated **M**)
- **Link kinetic indexes:** links a parameter from the same time points (abbreviated **K**)
- **Link positions:** links a parameter obtained from measurements at the same site (abbreviated **K**)
- **Link repetitions:** links a parameter for all repetitions of one measurement (abbreviated **R**)
- **Link channels:** link a parameter for the same channels (abbreviated **C**)

You can select the type of linkage by checking the corresponding boxes. More than one link can be activated. After closing the button tab, the linkage type is displayed as a one letter abbreviation. If a linkage is activated that does not apply for a measurement, it will be just disregarded. Global fitting will fit all linked parameters of different measurements to the same value. All repetitions regardless of being selected or not in the result table will be taken for global fitting. If you want to exclude measurements from the global fit, they have to be deleted from the result table.

- Select one or more rows in the **Fit Table**, for which you want to perform the fit. All curves of the selected row will be displayed. The last selected row will determine the channel that will be displayed in the **Channel** display field.
- ☞ PCH can be fitted only one-dimensional. If a cross-correlation measurement is activated, the PCH model will be automatically replaced by a correlation model.
- Set the range of the curves to be fitted by setting the red and blue bars in the correlation diagram (PCH diagrams do not have this option and the whole data set is always fitted). Press the **Fit** button to fit the loaded curves to the model. If you press **Fit all** all measurements with the same channel as the one displayed in the **Channel** field will be fitted as well.
- ☞ All other channels will not be fitted and the model has to be selected anew, if such a row with a different channel is selected.

By pressing the **Define...** button (or selecting the **Define model** from the context menu of the **Fit table**) the **Define model** window will open with the same functionalities as described in the **Set up Fit** toolbar.

### (5) State display box

The **State** display box (Fig. 385) above the Fit action buttons informs you about the fitting conditions. Whenever some inconsistencies are present, e.g. having parameters free that depend on each other, like the geometric factor and the number of molecules, the system gives a warning about the mistake.

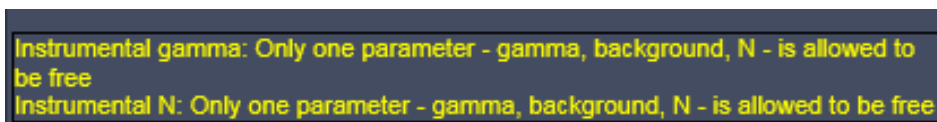


Fig. 385 State display box

### (6) Fit action buttons

The **Fit** action buttons enable you to perform a fit and adapt the fit process (Fig. 386).

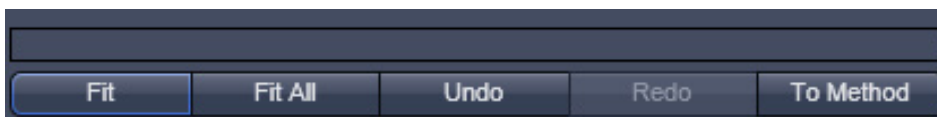


Fig. 386 Fit action buttons with empty State display box

**Fit:** will perform a fit for all highlighted measurements (rows) according to the loaded model.

When the fit is completed, the free parameters will be replaced with the new fitting results and the fit graph and result table will also be updated.

**Fit all:** will perform a fit for all measurements (rows) that have the same channel as the one displayed in the **Channel** display field. All other channels will not be fitted. If you change to a row with a different channel, the last assigned model will load for that row.

**Undo:** cancels a previous command. Repeatedly pressing will cancel commands in the reverse of their execution.

**Redo:** re-executes a previously undone command and hence will become only active, if an action was performed. Repeatedly pressing will re-execute previous undone commands in the order of their previous execution.

**To Method:** writes the current displayed **Model** settings into the method. Hence parameter values and their type of the selected fitting model are assigned to the model used in the current method. If you want to keep the changes permanently, the method has to be stored.

 Note that all actions are also available in the context menu of the **Fit table**.

### 5.3.21.9 Print

Click on the **Print** tab to activate the **Print Diagrams** display mode (Fig. 387).

The **Print Diagrams** window shows an overview of the results presented in tables and / or graphs, and relevant measuring parameters. This result overview can be printed directly on a connected printer.

In the **Print Diagrams** the following print functions can be selected by pressing the corresponding button:

**Print:** Starts the print function.

**Printer Setup:** Opens the printer setup window to set the print parameters.

#### (1) Amount

**Compressed:** Selects the **Compressed Report** preview without diagrams.

**Standard:** Selects the **Standard Report** preview with correlation and fit curves.

**Full:** Selects the **Full Report** preview with all diagrams and tables.

#### (2) Data sets

**All:** Prints all measurements.

**Selection:** Prints all selected / highlighted measurements.

**Current:** Prints the last selected / highlighted measurement only.

To print a report, proceed as follows:

- Select the **Compressed**, **Standard** or **Full** button.
- Select the **All**, **Selection** or **Current** button.
- If required, change the printer settings using the **Printer Setup** button.
- Click on **Print** to start the print procedure.



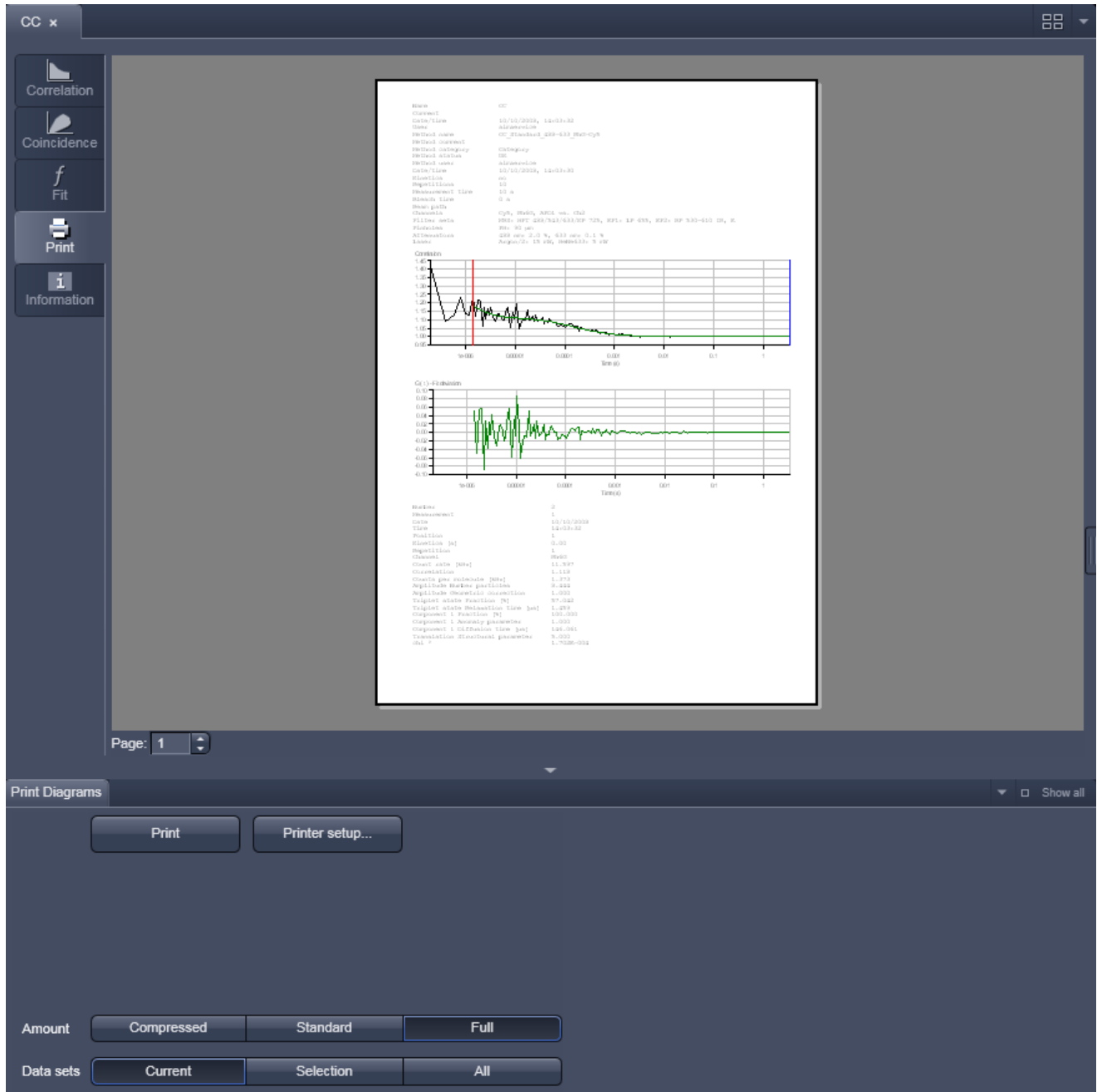


Fig. 387 Print panel

## 5.3.21.10 Information

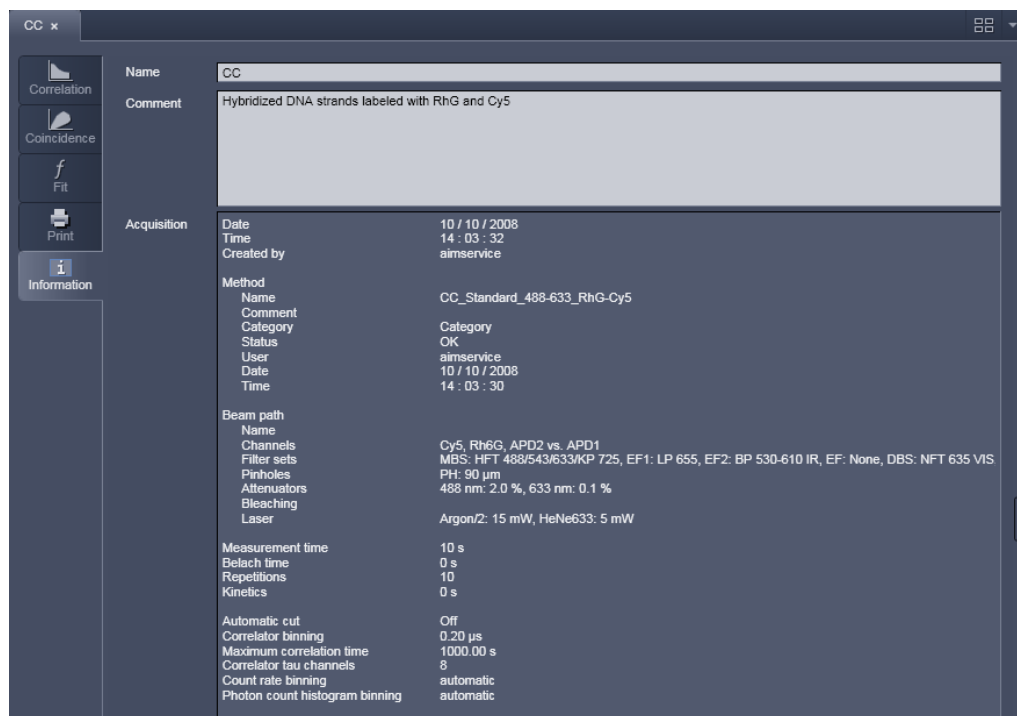


Fig. 388 Information panel

The information panel (Fig. 388) contains three blocks: **Name**, **Comment** and **Acquisition**.

**Names:**

This is an entry box, where you can input the name of the experimental set up.

**Comments:**

This is an input box, where you can write details of the measurement protocol.

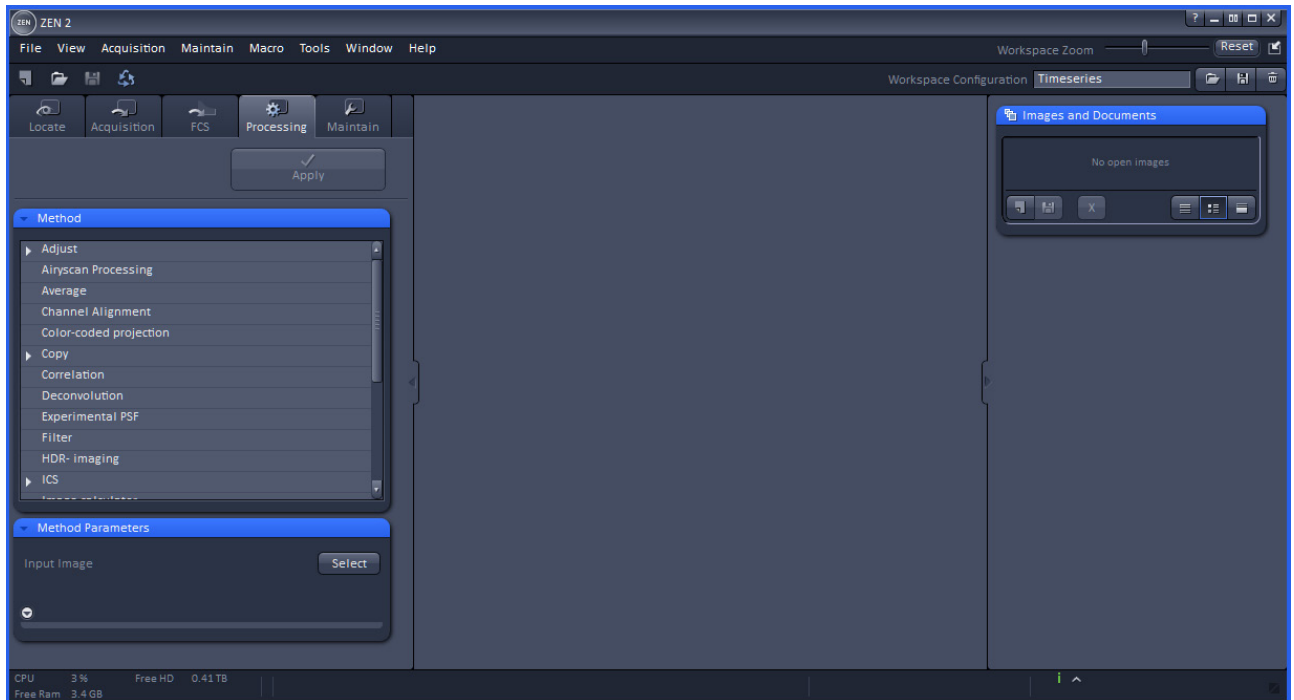
**Acquisition:**

This is a display box showing the instrumental settings (Meta data).

## 5.4 Processing Tab

### 5.4.1 General Structure of the Processing Tab




Click on the **Processing** tab to have access to the processing functions. The list of available Processing tool will be displayed (Fig. 389). The scrollbar must be used to have access to all functions.



**Fig. 389 Processing tool**

The **Processing** tool provides a number of methods for image processing and analysis using mathematical operators and algorithms, which include:


– Adjust	– Airyscan Processing
– Average	– Channel Alignment
– Color-coded projection	– Copy
– Correlation	– Deconvolution
– Experimental PSF	– Filter
– HDR-imaging	– ICS
– Image calculator	– Ion Concentration
– Lightsheet Processing	– Linear unmixing
– Maximum intensity projection	– Modify Series
– PALM	– Particle Tracking
– Stitch	– Structured Illumination


-  All processing tools can be used with stored and reloaded images or with newly acquired images (that need not be stored before processing).
-  Please note that for PALM images, although stored in a .czi format, only the PALM and Channel Alignment Processing tools are available, which can recognize tables. If you want to apply other Processing tools, the PALM image based on the table has to be converted to a true image. Such a function is available as a sub-function in the PALM Processing tool. Calculated SIM images, on the other hand, have the same format as normal widefield images.
-  Note that all .lsm and .czi images can be loaded into a function, but in order for that function to make sense, the .lsm or .czi image format must have the right dimensions.


The **Processing** tool tab (Fig. 390) is structured into different fields.


The top field or header (just beneath the **Main tool tab** area) contains the **Apply** button. The button is only active when an image is selected. If the **Apply** button is pressed, the selected or active processing tool operations will be applied to that image.

The next field contains the list of **Processing** tools. Select the desired tool by clicking on it. The active tool will be highlighted.

 Next is the image selection field. Highlight the image in the image container that you want to select. Load the **Input image** by pressing the **Select** button. **Select** will load the active image in the container. Alternatively, first press **Select** and then click on the image in the image container. With some image processing tools, two images can be loaded. Then select the first image to be loaded in the image container and press the **Select** button for **Input image**. Then select the second image to be loaded in the image container and press the Select button for **Input image 2**.

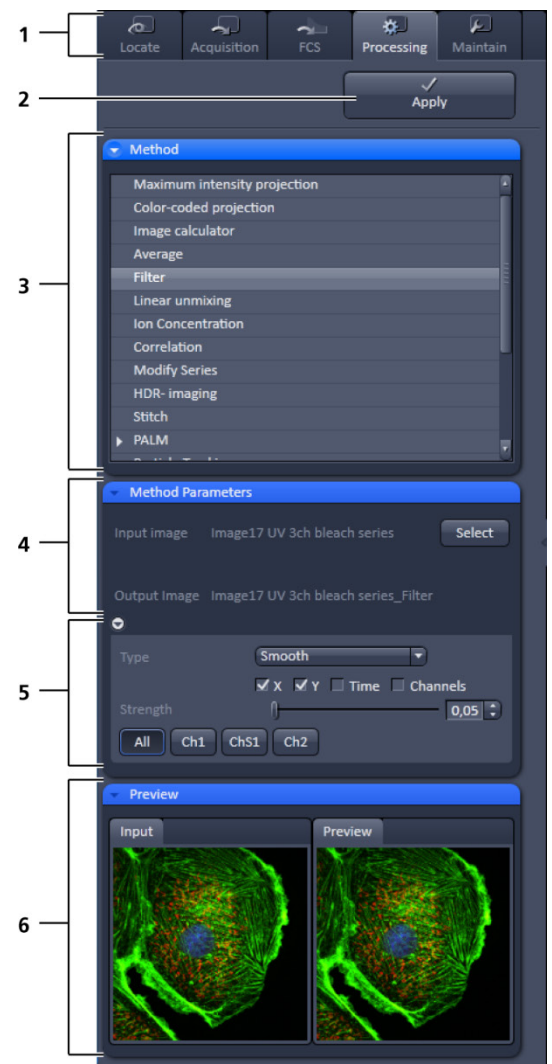
 Note that once an image is loaded by pressing **Select**, it cannot be unloaded but only be replaced by another one. This holds also true if the Processing tool is changed; the previous loaded image will stay selected. If another image is to be loaded, just highlight that image in the image container and press **Select** again. The newly selected image will replace the old one.

 If two input images are selected (**Input image** and **Input image 2**), they have to match each other in their dimensions. If they do not match, a warning is given. Acknowledge the warning to continue with the processing. The message will also be displayed if you load a new image pair that does not match in dimensions to the old pair. Since you can only load one image at a time, this will lead to a mismatch between the old **Input Image 2** and the new **Input Image**. Acknowledge the warning to continue loading the second new image.

 It is the responsibility of the user to check if an operation is suited for an image.

Once an image is selected by pressing the **Select** button, the **Output Image** name field with the name of the processed image will appear. The name can be later changed when the processed image is saved.

The next field is the method specific **Settings** panel that can be expanded / collapsed by pressing the triangle repeatedly. The triangle only appears when a processing tool is highlighted. It displays all the operational options for a specific processing function, if applicable, for the loaded image. Note that some



- 1 Main tool tabs
- 2 Apply button
- 3 Method panel with the available processing methods
- 4 Method Parameters panel with the input image and output image selection field
- 5 Method Parameters panel with with the method-specific settings
- 6 Preview panel with input and preview thumbnails

**Fig. 390 Processing tool structure**

**Processing** functions do not contain additional options and the field remains empty. Only those functions will be displayed that match the dimensions of the image parameters and that can be applied to the loaded image.

Once an **Input image** is selected, the **Preview** panel becomes available at the bottom field. It shows the **Input image** (or **Input Image** and **Input Image 2**, which can be selected by pressing the respective thumbnail) on the left and the **Preview** image on the right. In addition, a new View tab – the **Preview** tab – is opened for the image in the **Center Screen Area** (Fig. 391).

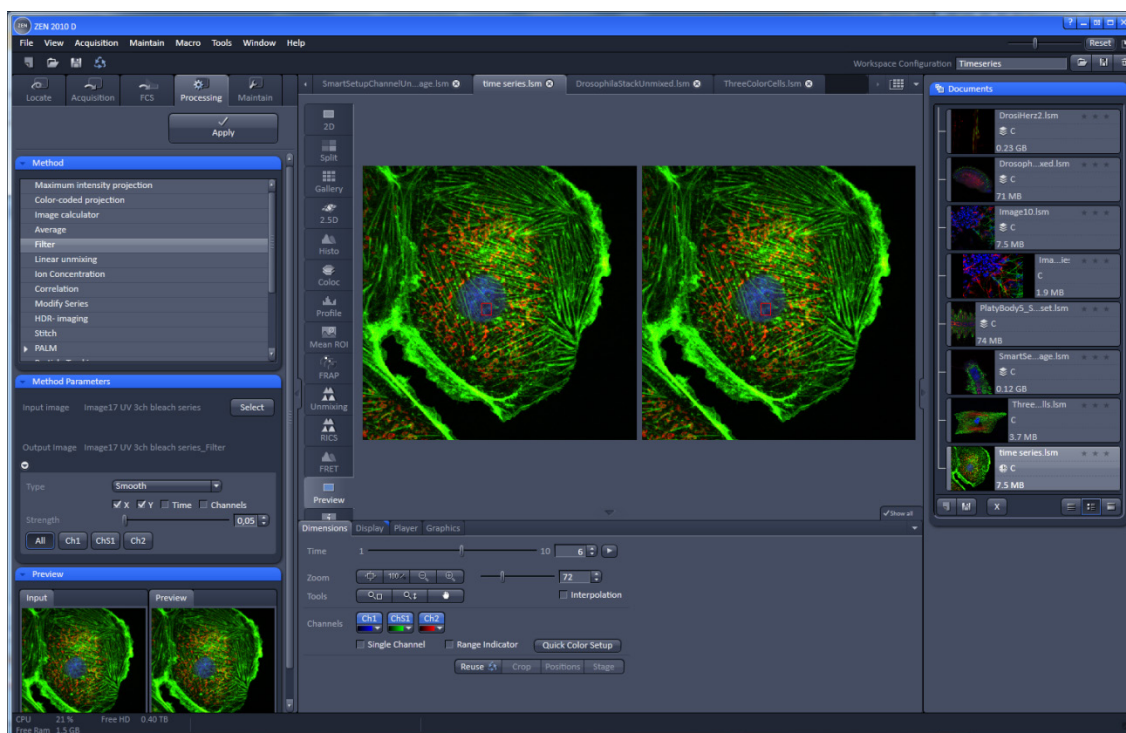


Fig. 391 Preview view tab in the Left Tool Area

The **Preview** tab shows the preview in more detail. The **Preview** thumbnail is always displayed in the **Processing** main tool tab, even when the view in the **Image Display** is changed. If in doubt which Image is selected as processing input, always refer to the displayed thumbnails. Both Previews – in the thumbnail as well as in the automatically generated Preview View tab in the Center Screen Area – are immediately updated.

### 5.4.2 Processing – Airyscan Processing

Licensing		Instrument	
standard	<input checked="" type="checkbox"/> optional	<input checked="" type="checkbox"/> LSM	ELYRA Lightsheet Z.1

Tool accepts Z-Stacks and time series and combinations of both. See full description of tool for details.

**Airyscan Processing** provides the 2D and 3D processing function for image data acquired with Airyscan in superresolution (SR) and virtual pinhole (VP) mode.

The highlighted image or image series in the central View container is selected upon clicking the **Select** button.

For images acquired in SR mode, the processing strength is per default preset with the **Auto** function activated.


For changing the parameter, uncheck the **Auto** function and use the slider or editing box to set a new value (Fig. 393).

2D processing is available for 2D and 3D data sets (also over time). 3D processing is available for 3D data sets (Z-Stacks also over time) only.

- To process Airyscan data, choose the **Airyscan Processing** function in the method list (Fig. 392).

#### Auto

- Klick on the open image you want to process and press **Select** (Fig. 393) in the method parameters dialogue. Make sure the right image is visible in the input window.
- For auto processing, activate the **Auto** checkbox. In the preview window you can check again whether the right image type is selected.

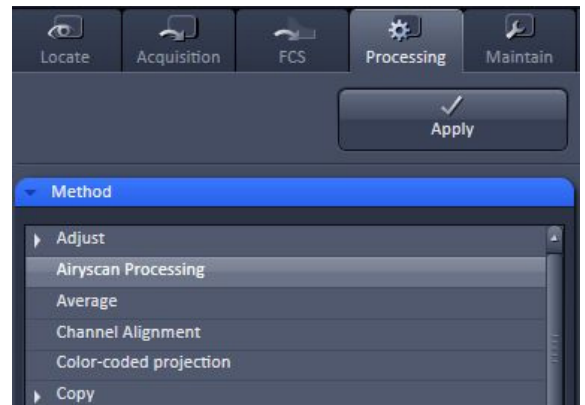
 Note that this preview will not show a full SR processing result.

- Press the **Apply** button at the top of the dialog.

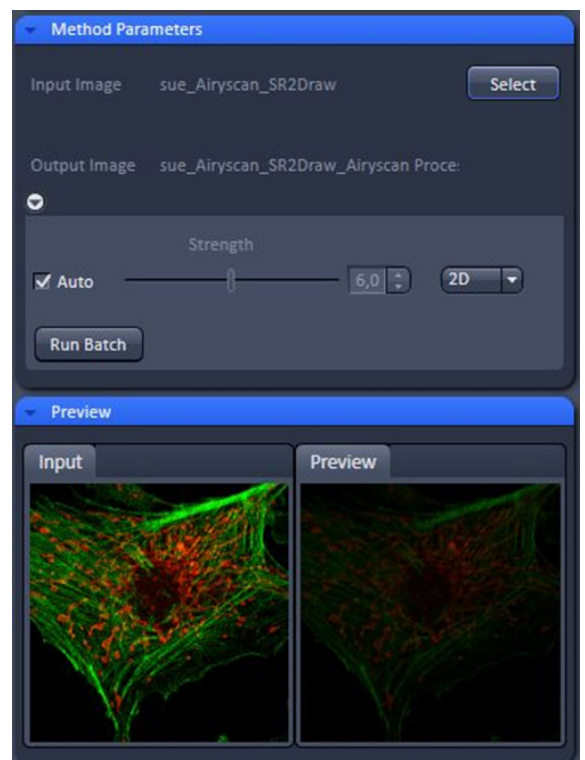
Processing will start and might take a few minutes.

A new image will open with the result of the auto processing.

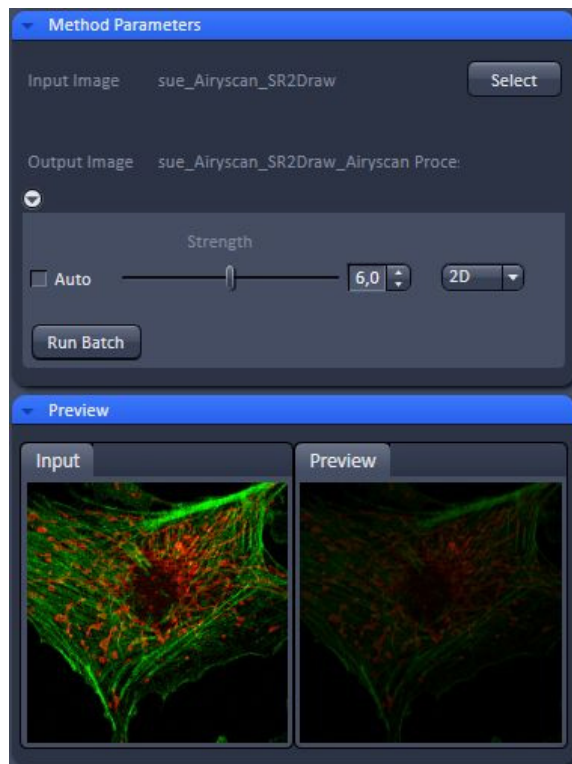
All images in a time series or Z-Stack will be processed.



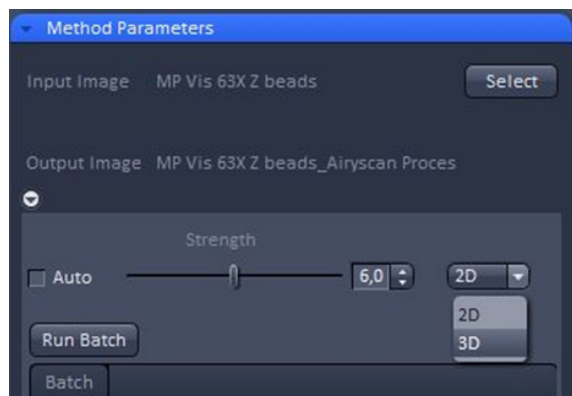
**Fig. 392 Processing tab with Method selection list**



**Fig. 393 Airyscan Processing tool: Method Parameters, Auto**




**Fig. 394 Airyscan Processing tool:  
Method Parameters, Manual**



**Fig. 395 Airyscan Processing tool:  
Method Parameters, 2D, 3D**

### Manual


- For manual processing, deactivate the **Auto** checkbox (Fig. 394).
- In the preview window you can check again whether the right image type is selected.

 Note that this preview will not show a full SR processing result.

- Use the strength slider to get a stronger or weaker result as with the auto processing. You might use the same values as used in the 2D preview processing in the **Airyscan** tab.
- Press the **Apply** button at the top of the dialog.

Processing will start and might take a few minutes.

A new image will open with the result of the manual processing (Fig. 394). All images in a time series or Z-Stack will be processed.

 Note that with 3D data you have the choice of a 2D or a 3D processing by selecting the method from the dropdown list (Fig. 395). A 3D processing will take longer but will result in a higher resolution increase since also the axial Airy data will be used for the processing.

### VP data processing

In case a VP mode image was selected, the manual processing slider will function for virtual pinhole parameter adjustment.

This allows to adjust the confocal sectioning after acquisition by binning the respective airy rings together.

- Press the **Apply** button at the top of the dialog.

Processing will start and might take a few seconds.

A new image will open with the result of the selected sectioning. All images in a time series or Z-Stack will be processed.



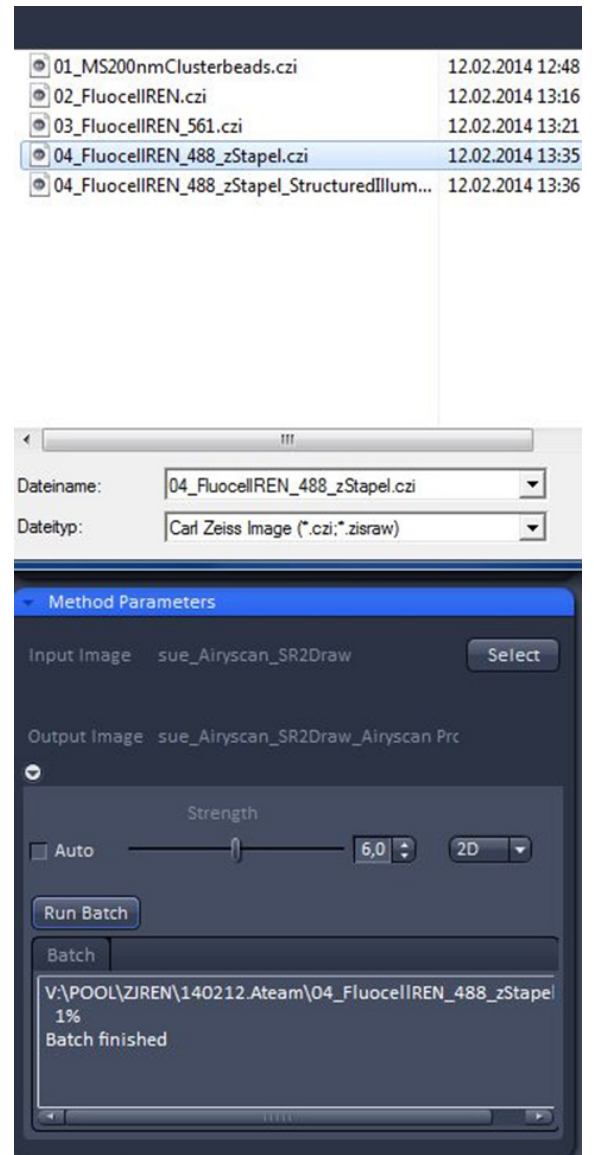
## Batch

- For batch processing press the **Run Batch** button (Fig. 396) and select the respective directory and files from the file selection window which opens at the top.
- After confirming your selection the batch processing will start and might take a few minutes to hours depending on the number and type of files selected.

All files will be processed with the same processing strength.

Processing can be stopped clicking **Stop Batch**.

The status of processing (% of progress/batch finished) is displayed in the Batch panel which appears in the Method tool once a batch process has been started.

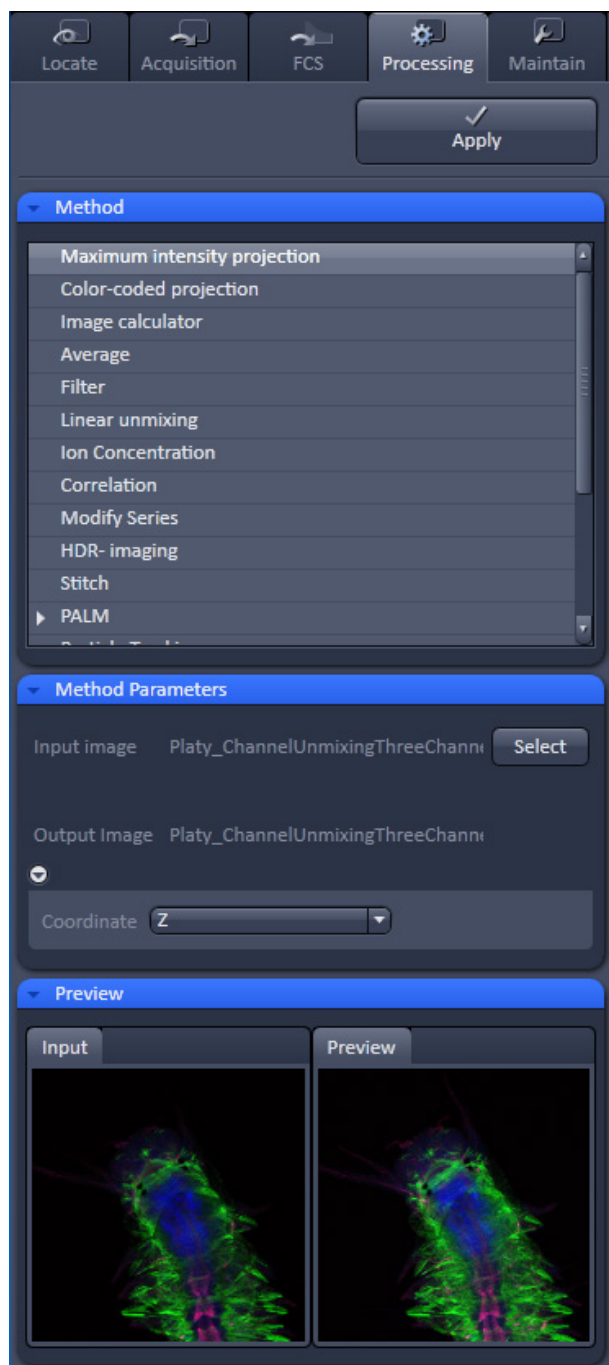


**Fig. 396** Airyscan Processing tool:  
Method Parameters, Run Batch

### 5.4.3 Processing – Maximum Intensity Projection

Licensing		Instrument		
<input checked="" type="checkbox"/> standard	<input type="checkbox"/> optional	<input checked="" type="checkbox"/> LSM	<input checked="" type="checkbox"/> ELYRA	<input checked="" type="checkbox"/> Lightsheet Z.1

Tool accepts Z-Stacks and time series (incl. combinations with several other dimensions). See full description of tool for details.



**Fig. 397** Processing – Maximum Intensity Projection

The **Maximum Intensity Projection** function generates a maximum intensity projection image along the z-, time- or channel dimension of a multidimensional image data set (Fig. 397).

- To open the **Maximum Intensity Projection** Processing tool, select it from the list in the **Processing** main tab.
- Click on the triangle buttons to show or hide the **Method Parameters** and **Preview** panels of the function.
- Select the **Input Image** with the **Select** button and choose the dimension along which you want to generate a maximum intensity projection from the **Coordinate** pull down menu (z, time, channel) in the Settings panel.
- Clicking the **Apply** button creates the maximum intensity projection as a new image document using the name shown in the Output image display for the Select field.

The maximum intensity projection creates an output image whose pixels contain the maximum value over all images in the stack at the particular pixel location.

#### 5.4.4 Processing – Color-coded Projection

Licensing		Instrument		
<input checked="" type="checkbox"/> standard	<input type="checkbox"/> optional	<input checked="" type="checkbox"/> LSM	<input checked="" type="checkbox"/> ELYRA	<input checked="" type="checkbox"/> Lightsheet Z.1

Tool accepts Z-stacks and time series (incl. combinations with several other dimensions). See full description of tool for details.

The **Color-coded projection** function generates a maximum intensity projection image along the z-, or time- dimension of a multidimensional data set (Fig. 398). Instead of using the colors assigned to the channels, it displays the position in z or in time with a color gradient.

- To open the **Color-coded projection** Processing tool, select it from the list in the **Processing** main tab.
- Click on the triangle buttons to show or hide the **Method Parameters** and **Preview** panels of the function.
- Select the color gradient by choosing an appropriate look up table (LUT) from the **LUT** drop down menu.
- You can select from the **dimension** drop down menu any dimension of the image. The color gradient will apply for the selected dimension. These include **Z** (for a Z-Stack) or **T** (for a time series).
- Below the color gradients the corresponding depth or time is indicated in grey numbers and letters.
- Define the range (**ROI**) of the Z-Stack or time series to be used by using the sliders or the input boxes with arrows.
- Clicking the **Apply** button creates the color-coded projection as a new image document using the name shown in the Output image display for the Select field.

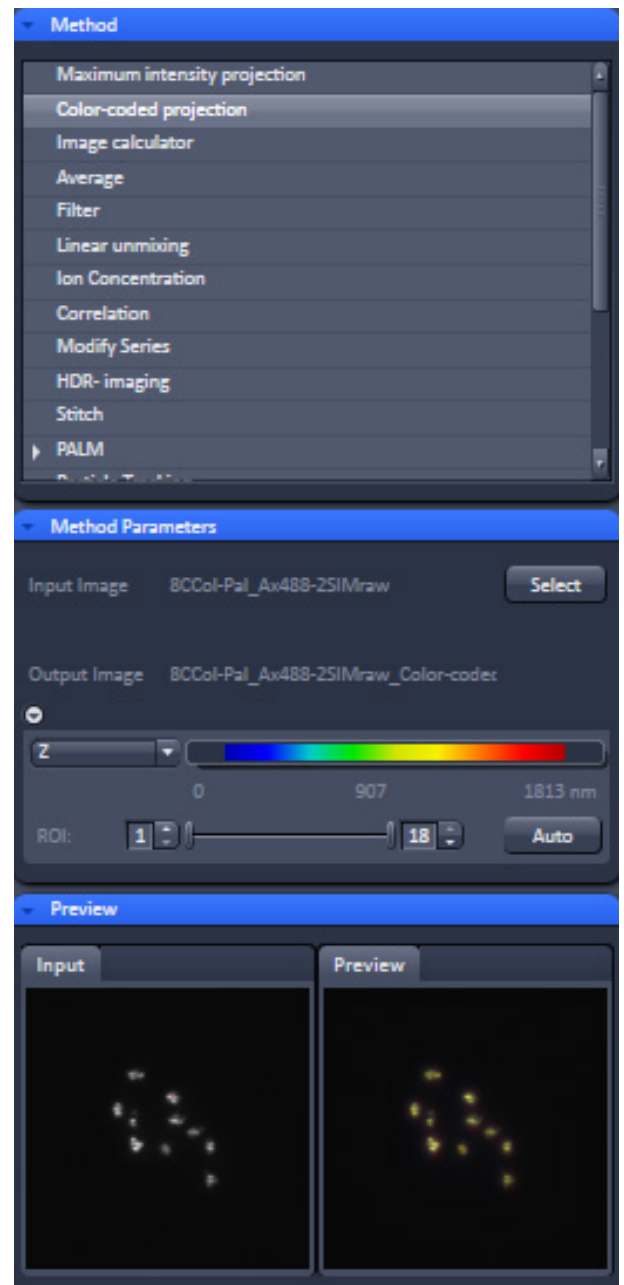
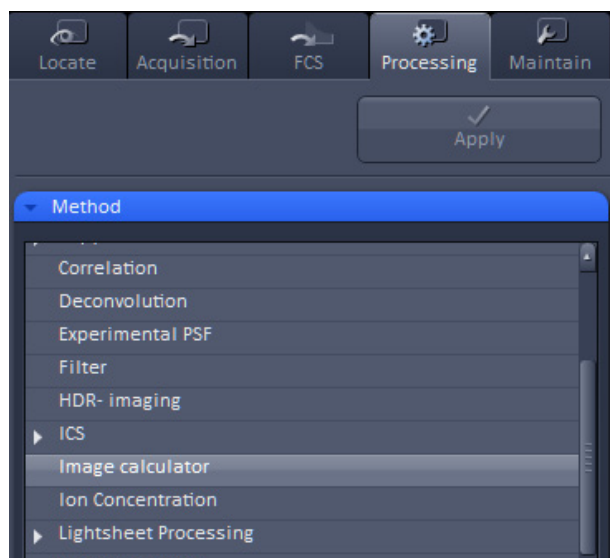
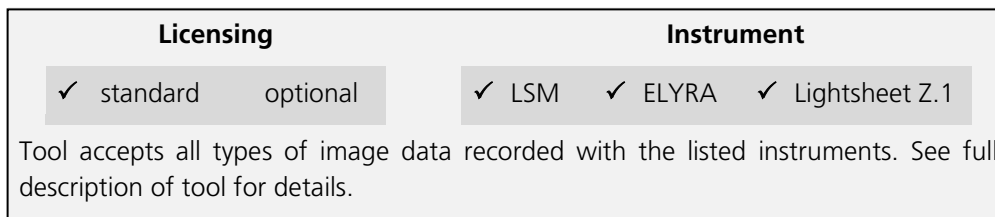


Fig. 398 Processing – Color-coded projection

### 5.4.5 Processing – Image Calculator



**Fig. 399 Processing – Image Calculator**

The **Image calculator** tool provides a calculator-style interface to apply arithmetic operators to the selected image.

- To open the **Image calculator** tool, click on the **Image calculator** in the list of the **Method** panel in the **Processing** main tool tab.
- Click on the triangle buttons to show or hide the **Method Parameters** and **Preview** panels (Fig. 399) for the function.

The two **Select** buttons in the **Selection** panel select the active image in the Image Display as **Input Image** and **Input Image 2**. The Output Image is automatically fed into a new image document. A specific input channel from a multi-channel image or series can be selected using the pull down menus next to the Select buttons.


The number in the **First image** display box, which can be edited, reduces the **Input 2 Image** series to the selected first frames of a time series. This can be used to normalize a time series to the values of its first image(s).

After loading 2 input images (source images S1 and S2) specifying the input channels, the calculator keyboard in the **Settings** panel allows the definition of an operator or a combination of operators which is represented by a formula in the formula display box. The operators will be inserted into the formula at the cursor position. The formula can also be typed in directly. By pressing **Input 1** or **Input 2** source image 1 or 2 will be loaded, respectively at the position of the cursor.

For an overview of the available more advanced operators, please refer to the formula panel that is shown in a pop-up window after clicking the **Operators...** button (Fig. 400).

By highlighting the selected operator, a description of the function of this operator is displayed in the lower part of the operators list (Fig. 400).

All image calculations in this tool work pixel by pixel and start with the upper left pixel regardless of the image size for the two images or image series.

 When choosing images of different data depth, the check box next to **Intensity range 0...1** should be marked. This normalizes the image intensity for all images to values between 0 and 1.

All actions performed in the Image Calculator have immediate effect on the previews. After pressing the Apply button on the top of the Processing **main tab**, a new image document with the resulting image is created.

A good example application for the Image Calculator is offsetting/normalizing two images or an image series with a reference image to enhance contrast for small changes in intensity:

- Select a time series as Input 1 and the first frames of these series (or another offset image) as Input 2.
- Then type/edit an operator as shown in Fig. 401 that enhances the relative changes in the image with respect to the relatively bright signal level, for example:  

$$S1 - S2 / 2 = \text{source 1} - \frac{1}{2} * \text{source 2}.$$

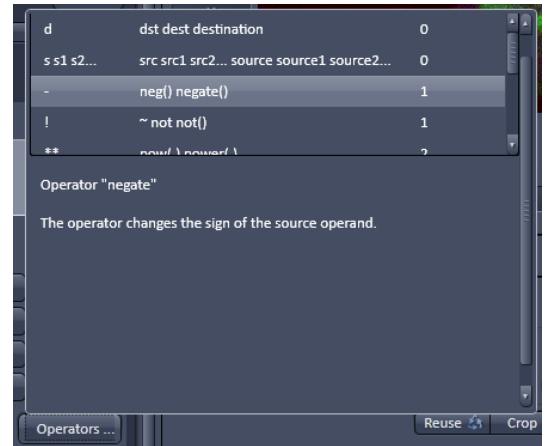


Fig. 400 Operators window

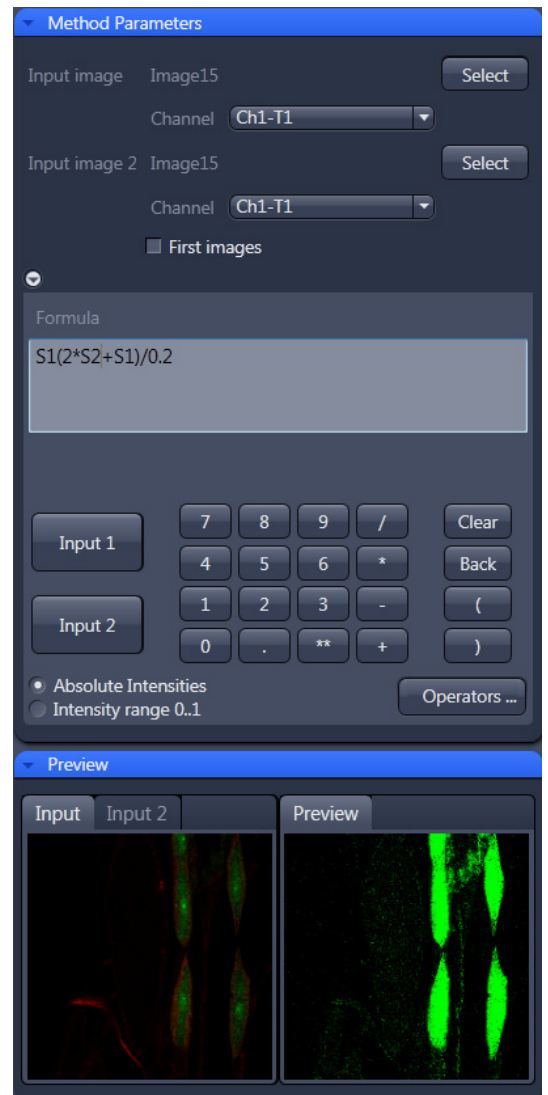


Fig. 401 Image calculation window

## 5.4.6 Processing – Average

Licensing		Instrument		
<input checked="" type="checkbox"/> standard	<input type="checkbox"/> optional	<input checked="" type="checkbox"/> LSM	<input checked="" type="checkbox"/> ELYRA	<input checked="" type="checkbox"/> Lightsheet Z.1

Tool accepts all types of image data recorded with the listed instruments. See full description of tool for details.

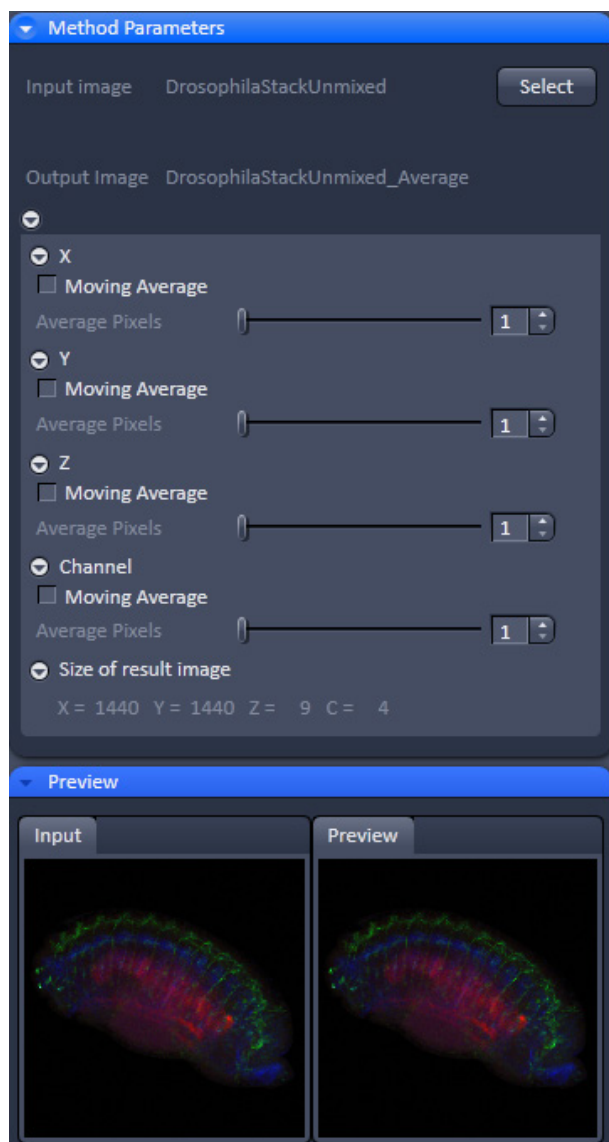


Fig. 402 Processing – Average

An average output image will be calculated according to the settings and the result presented in the **Preview** window.

The size of the resulting image in **X**, **Y**, **Z**, and **T** can be viewed in the **Size of result image** display.


If the **Apply** button is pressed, the averaged image will be opened as a new image in the container.


The **Average** processing function will calculate an image that can be averaged in pixel and time.

- Activate **Average** in the **Processing** tool.

The **Average** menu will appear. The **Average** processing function will calculate an average image.

- Click on the triangle buttons to show or hide the **Method Parameters** and **Preview** panels (Fig. 402) for the function.
- To select an image, click on the image in the container and press the **Select** button. This will be your **Input** image.
- Select how many pixels you want to bin in x-direction, y-direction, and time points by setting the respective values in the **X Average Pixels**, **Y Average Pixels**, **Z Average Pixels** and **Time Average Pixels** input boxes, which can be opened by clicking on the arrows.

 Note that **Z-Average Pixels** and **Time Average Pixels** are only available for Z-Stacks and time series. You can either enter a value, or use the sliders, or arrows of the input boxes.

 If a moving average for **Time** should be performed, the respective **Moving Average** box must be checked. In this case, consecutive averages comprised of the specified number of frames in **Average Pixels** will be computed.

5.4.7 Processing – Filter

Licensing		Instrument		
✓ standard	optional	✓ LSM	✓ ELYRA	✓ Lightsheet Z.1

Tool accepts all types of image data recorded with the listed instruments. It is generally advisable to perform certain processing steps (e.g. linear unmixing or SIM processing) before applying filters. See full description of tool for details.

The filter function permits the processing of images with a Median, Smooth, Sharpen, or Bandpass filter.

- To open the **Filter** tool, select it from the list under the **Processing main tab** (Fig. 403).
- Select the Input Image with the **Select** button and choose the filter of your choice from the Type pull down (**Median, Smooth, Sharpen, Band, and Gradient**).
- Select the channels you want to process with the **All, Ch-T1 or Ch-T2** buttons.

Once a filter has been selected from the type drop down menu, filter specific settings are available.

**Median Filter**

With the median filter, the gray value of each center pixel is replaced with the median value of the neighboring pixels. The viewed neighbor pixels are defined by a square of a certain size called the kernel. The modified pixel now is the center pixel of this pixel matrix.

The median value is defined as the middle value (not average) of all the gray values sorted in ascending order within a matrix.

Image noise will be reduced by the application of the median filter. The cut-off of regions will slightly blur. Local maxima will be flattened. The dynamic range will be reduced considerably.

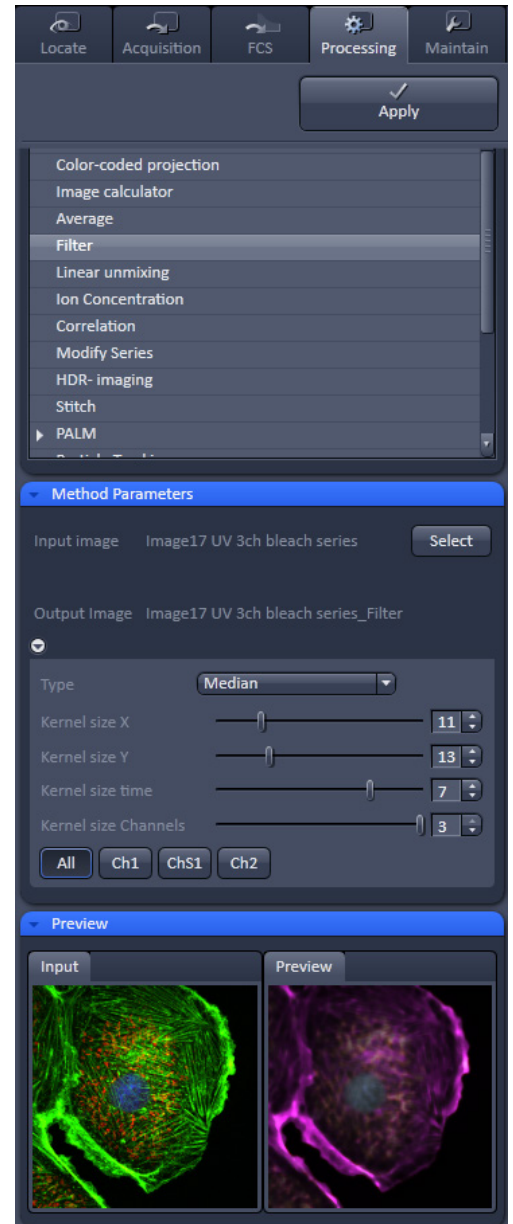


Fig. 403 Processing – Filter

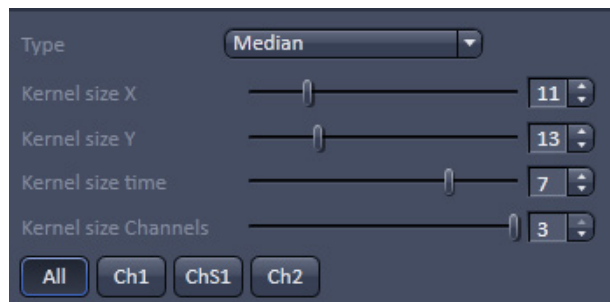


Fig. 404 Median filter

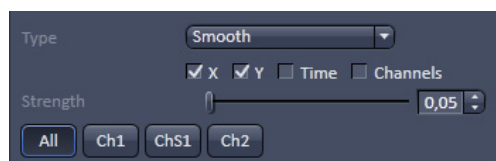


Fig. 405 Smooth filter

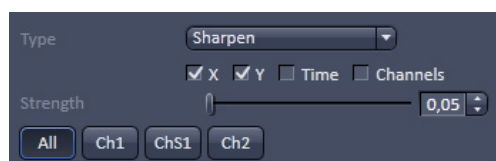


Fig. 406 Sharpen filter

The effect of the filter increases with the matrix size. This matrix / kernel size can be set for each dimension with the three sliders **Kernel size X**, **Kernel size Y**, and **Kernel size Z** in the **Filter Type** panel or by setting the size in the spin-box on the right hand side of each slider (Fig. 404). A larger kernel, however, also increases the processing time. Other settings of this filter cannot be modified.

### Smooth Filter

The smooth filter is a low pass filter with Gaussian characteristics. The gray value of each center pixel is replaced with the weighted average value of the surrounding neighbor pixels. The "neighborhood" is limited by the cut-off in pixels, set by the **Strength** slider. It has an analogous effect as the kernel size (Fig. 405).

If a dimension should be processed by this tool the respective **X**, **Y**, **Z**, and **Channels** check boxes must be ticked. The modified pixel now is the center pixel of the filter matrix.

Image noise will be reduced by the application of the low pass filter. Sharp edges of regions will blur. Local maxima will be flattened. The dynamic range will be reduced considerably.

### Sharpen Filter

With the sharpen filter, the original image is filtered with a low pass filter first. The result of this filtering is then subtracted from the original image. This will improve image sharpness.

The "neighborhood" is limited by the cut-off in pixels, set by the **Strength** slider. It has an analogous effect as the kernel size (Fig. 406). If a dimension should be processed by this tool, the respective **X**, **Y**, **Z**, and **Channels** check boxes must be ticked.



## Band Filter

With the band filter (Fig. 407), the original image is filtered with a "band blocker" filter. It filters out a certain frequency band with the position set by **Center**, width set by **Band Width** and a steepness of the edges set by **Strength**. This is particularly useful to remove periodic perturbances in the image.

If a dimension should be processed by this tool, the respective **X**, **Y**, **Z**, and **Channels** check boxes must be ticked.

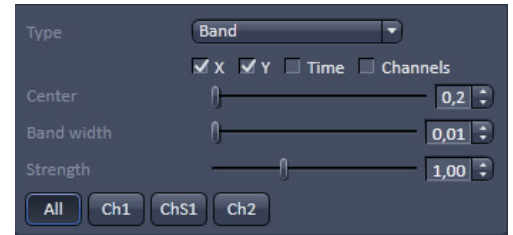


Fig. 407 Band filter

## Gradient Filter

The Gradient Filter visualizes the direction and rate of brightness changes from one pixel to the other. It illustrates if brightness changes smoothly or abruptly in the image (Fig. 408).

The gradient filter can be used for all dimensions present in one dataset. You can select it if you wish to perform it for all channels with the **All** button or individual channels with the according (e.g. Cam1 or Ch1) buttons.

The dimensions can be chosen by checking the according check-boxes.

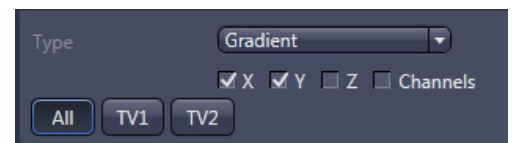
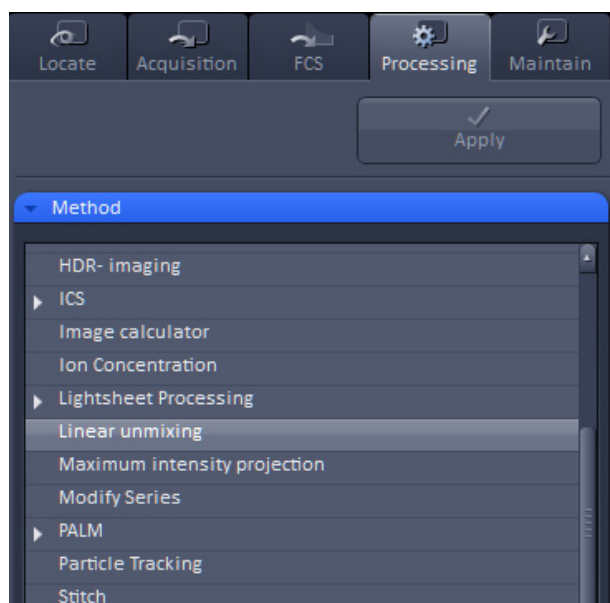


Fig. 408 Gradient Filter

### 5.4.8 Processing – Linear Unmixing

Licensing		Instrument	
✓ standard	optional	✓ LSM	ELYRA Lightsheet Z.1

Tool accepts lambda stacks and multi-channel image data (single images and multi-dimensional image data). *Linear Unmixing* was developed for processing LSM data. Successful processing of multi-channel images obtained with other systems is potentially possible as well (provided this input meets the requirements for unmixing). See full description of tool for details.



**Fig. 409 Processing – Linear unmixing**

The Linear Unmixing processing tool permits extracting the emission of single fluorescence dyes (e.g. GFP only, YFP only etc.) from strongly overlapping multi-fluorescence data acquired in multi-channel images and so-called "Lambda stacks" (only available in LSM imaging mode).

In brief, with the knowledge of the spectral characteristic of individual components within a multi-component sample, even heavily overlapping individual spectral characteristics can be mathematically extracted from an experimental multi-channel data. This method is a strictly pixel-by-pixel image analysis procedure.

Experimentally, fluorescence spectra of mono-labeled samples are acquired and stored in the Spectra Database as an external reference. Then a multi-channel image or Lambda stack (available only in **LSM imaging** mode) from the multi-labeled sample is acquired.

Finally, the individual components are mathematically extracted using the information from the reference spectra. Up to ten different reference signals can be fed into the least-square-fit based algorithm to produce a 10-channel multi-fluorescence stack without any partial overlap between the channels.

If no mono-labeled samples are available, the references can be obtained by the following methods:

- Interactively by user-selection of regions in the image where only one fluorescence dye is present (only available in the **Unmixing View** tab).
  - Automatically by software analyses of what the individual spectral signatures are. This processing function is called "Multi-channel Unmixing" or "Automatic Component Extraction" (ACE). Note: in some cases, spectrally acquired images are not appropriate for ACE or "Multi-channel Unmixing" and linear unmixing can lead to wrong results.
- To open the **Linear unmixing** tool, click on **Linear unmixing** in the **Processing** tool list under the **Processing** tab (Fig. 409).

- Pressing the **Select** button loads the active image from the **Image Display** and displays it as Input Image. Only Lambda stacks (only available in **LSM imaging** modes) or multi-channel images can be loaded.
- In the **Linear unmixing** panel (Fig. 410), the number of spectrally distinguishable fluorescent components within the imaged sample can be selected from the **Components** selection box. The number of extractable components cannot be higher than the number of acquired channels. The ZEN software is limited to a maximum of 10 components.

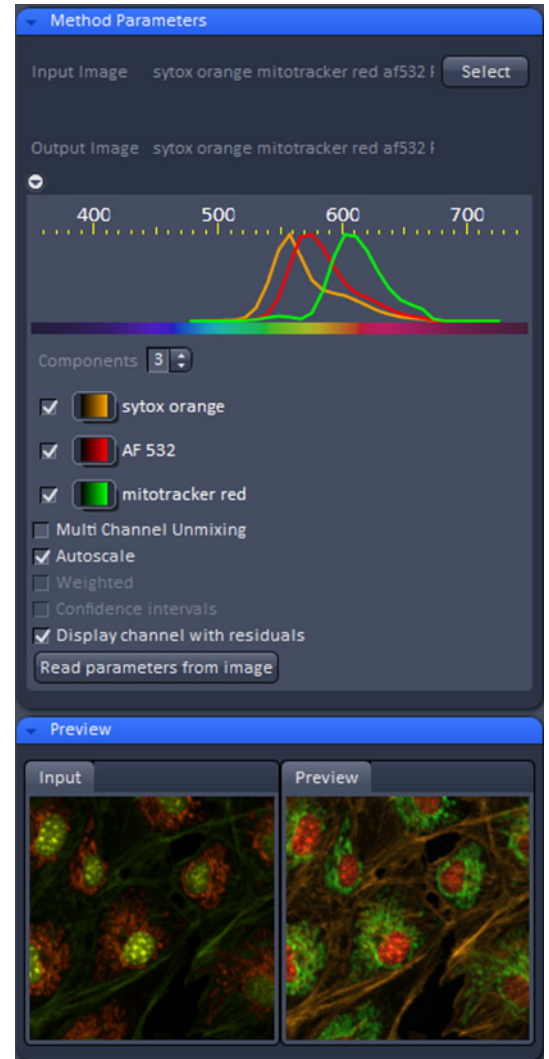
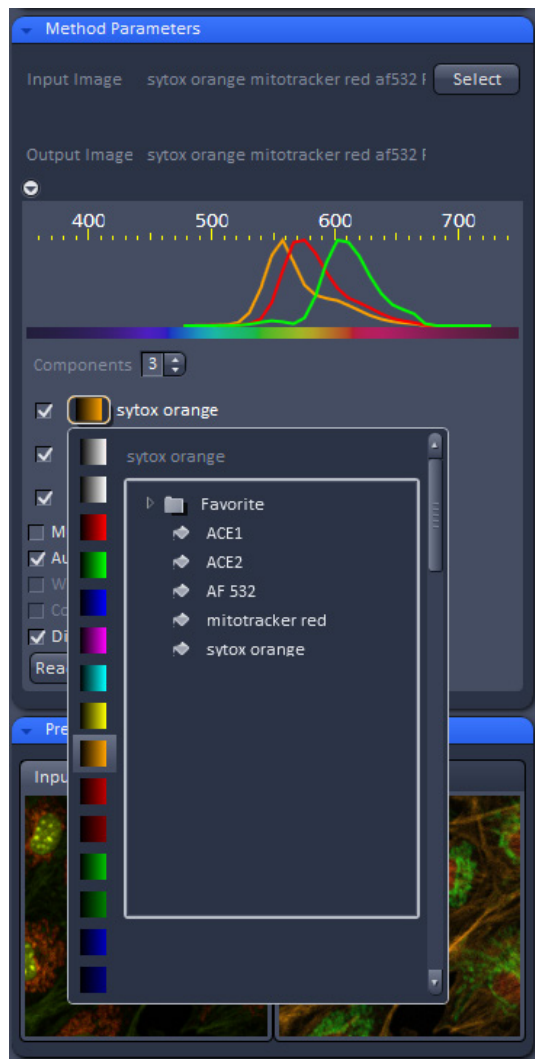


Fig. 410 Linear unmixing panel



**Fig. 411 Spectra and LUT assignment**

- Select the sample-specific fluorescence dye reference spectra from the Spectra Database (Fig. 411).
- Assign appropriate colors to the fluorescence channels by clicking on the color flag and choose from the available lookup tables (LUTs)
- If no predefined reference spectra exist:
  - Prepare reference samples and create spectra via the **Save to Spectra DB** button in the Unmixing View (see section **Processing – Linear Unmixing**).
  - or
  - Use the "Multi-channel Unmixing" functionality described below. (Note: in some cases, spectrally acquired images are not appropriate for "Multi-channel Unmixing" and linear unmixing can lead to wrong results – see discussion below.)
- After definition of the required reference spectra click **Apply**.

A new image with the resulting (unmixed) channels will be created (Fig. 412 and Fig. 413).

The following additional settings and functions are available for linear unmixing:

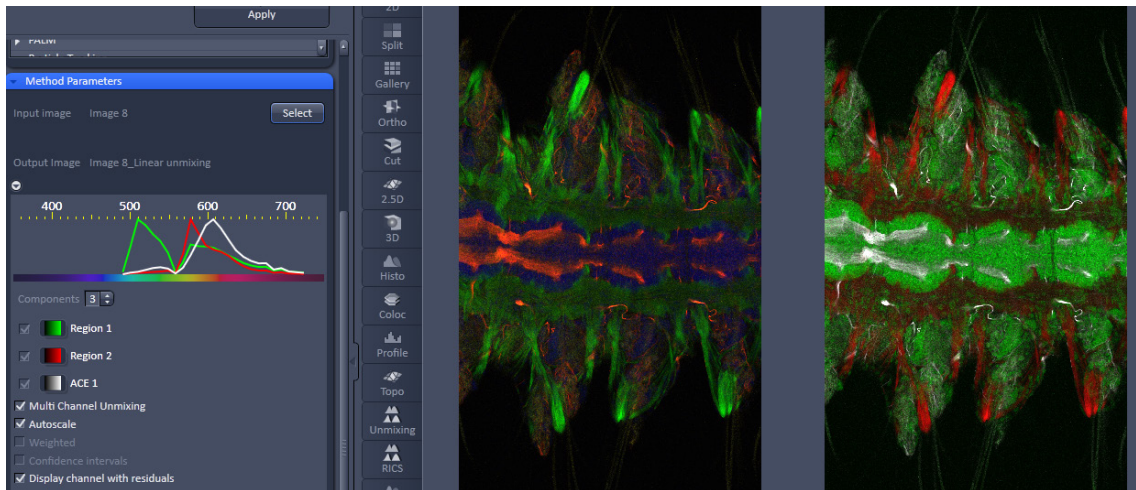
Auto scale balances the intensity of the unmixed channels to equal levels.

Display Channel with Residuals generates an additional channel in which the intensity values represent the difference between the acquired spectral data and the fitted linear combination of the reference spectra. In essence, the residual value is the biggest remaining "residual" from the least square fit routine. The residuals are a general measure for how good the fit of the algorithm has performed.

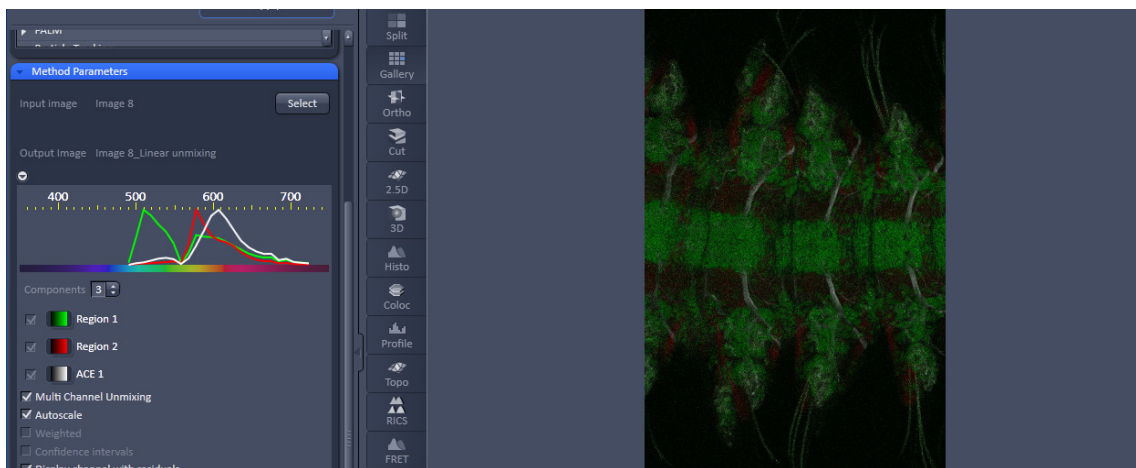
The higher the intensity in this additional channel, the worse is the fit of the spectra to the dataset. This shows that either the acquired data is not representing the sample (e.g., when information is lost by pixel saturation) or wrong/insufficient reference spectra have been chosen. In this case, new image acquisition with no overexposed/ saturated pixels is strongly recommended. In the case of wrong reference spectra, choosing/acquisition of different/new reference spectra can be necessary to improve the results.

**Weighted unmixing:**

When this option is checked, spectral channels with high noise contribute less to the unmixing result. This option includes a statistical analysis of the signal-related (Poisson-) noise and weighs the respective contribution for the fitting with the combination of reference spectra to the experimental data. Note: this option involves a more sophisticated unmixing algorithm and therefore takes longer than the basic unmixing analysis. Weighted unmixing generates improved unmixing results when acquisition channels are not so well balanced but still have a good signal-to-noise ratio.



**Fig. 412** Image Display window before unmixing in Preview



**Fig. 413** Image Display window after unmixing



**Display channels with statistical confidence:**

This option displays an additional channel per unmixed component which shows the relative statistical error in each unmixed component channel. This statistical uncertainty of the pixel intensity in the unmixed channel is calculated based on the (Poisson-) noise from the acquired (input-) channels, the bandwidth and –position and the quality of the reference spectra. The display can be interpreted best when an appropriate false color LUT is chosen. The error is displayed as percentage of unmixed channel pixel intensity. For example: A "confidence value", i.e., pixel intensity of 50 represents a 50% statistical uncertainty of the corresponding intensity in the unmixed channel. The higher the statistical error for the acquired pixel intensity (the shot noise), the higher is the intensity value of this pixel.

**Multichannel Unmixing:**

When this option is chosen, the unmixing algorithm is applied to a multi-channel image (up to 10 channels) without the use of reference spectra.

The calculation of residuals and the subtraction of background based on a background spectrum are not available. For heavily overlapping signals this method will yield poor results.

-  Avoid saturation of fluorescence signal in the data set to be unmixed. Saturation will generate a high signal in the residual channel. To get the best unmixing results, define an extra background channel, if possible.
-  Reference Spectra used for Linear unmixing of the Lambda stacks processed in the Unmixing View are stored with the resulting image and can be re-loaded using the **Processing → Linear unmixing** tool with the Read parameters from image button. This facilitates processing of a series of images or Lambda stacks all with the same parameters / reference spectra.

**5.4.9 Processing – Ion Concentration**

Licensing		Instrument	
standard	<input checked="" type="checkbox"/> optional	<input checked="" type="checkbox"/> LSM	ELYRA Lightsheet Z.1

Tool accepts single-channel or multi-channel, multi-dimensional data (typically time series data) of samples labeled with fluorescent ion indicators. *Ion Concentration* was developed for analyzing LSM data. Successful analysis of image data obtained with other systems is potentially possible as well (provided the input meets the requirements for intensity quantification). See full description of tool for details.

This Processing function permits the calibration of ion concentrations in physiological experiments.

To open the **Ion Concentration** tools click **Ion concentration** (Fig. 414).

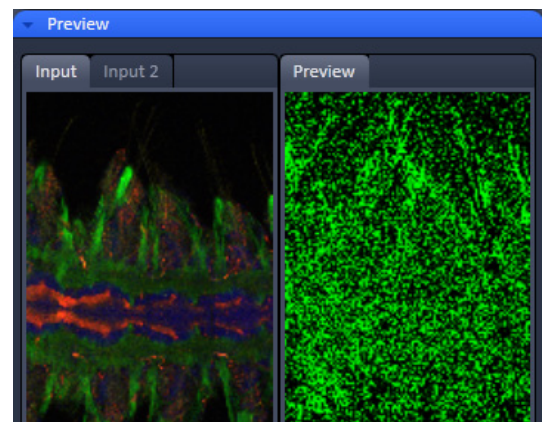
The two **Select** buttons select the active image in the **Image Display** as **Input Image** and **Input Image 2** (for background subtraction). The name of the automatically generated Output Image is shown under the name of the Input Images.

In the **Preview** panel at the bottom of the Ion concentration tool window, thumbnails of the input images as well as a preview of the output image are displayed (Fig. 415).

After opening the **Method Parameters** panel full window by clicking the little arrow, the full tool window opens and the following functions are available (Fig. 416).



**Fig. 414 Processing – Ion concentration**



**Fig. 415 Ion concentration panel**

Calibration graph

Opens the display for the resulting calibration curve.

Load ... Save ...

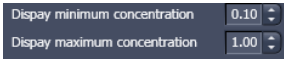
To load & save calibration curves from / to files.

buttons

Background (Input 2)

To select Input Image 2 as background image.

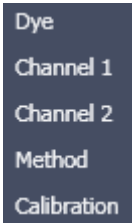
tick box



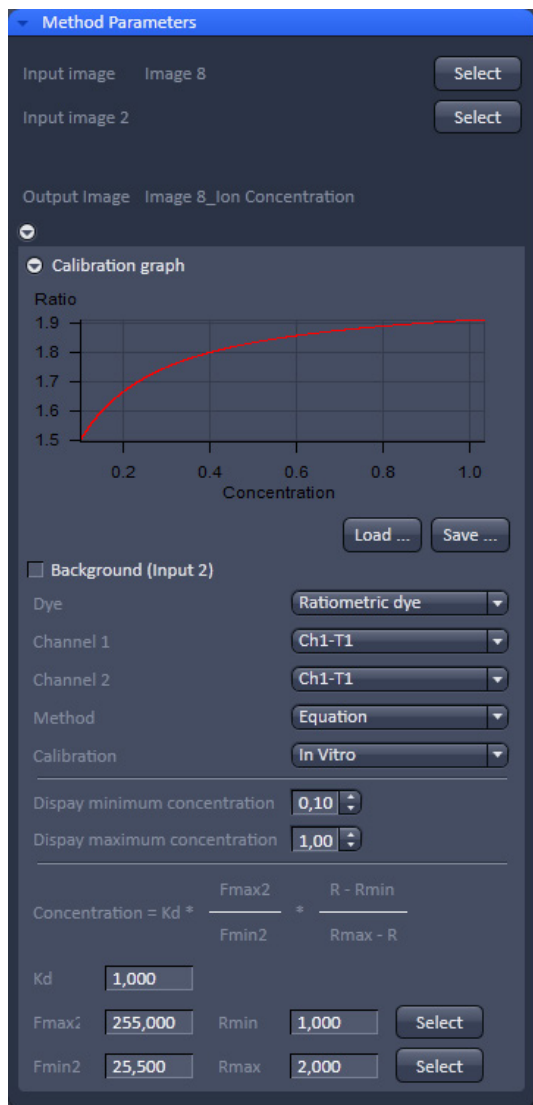
Spin boxes to set the Min and Max in the Output Image

Image scaling

Pull down menus for



To set three different calibration options, according to the dyes (single wavelength, vs ratiometric), the calibration method and if the calibration is carried out in vitro/situ. Ch 1 and 2 select the channels from Input Image 1.



From these pull downs, the following combinations of parameters can be chosen:

Dye: single wavelength vs. ratiometric

Available methods for single wavelength: Titration or equation (both, **in vitro** and **in situ calibration**).

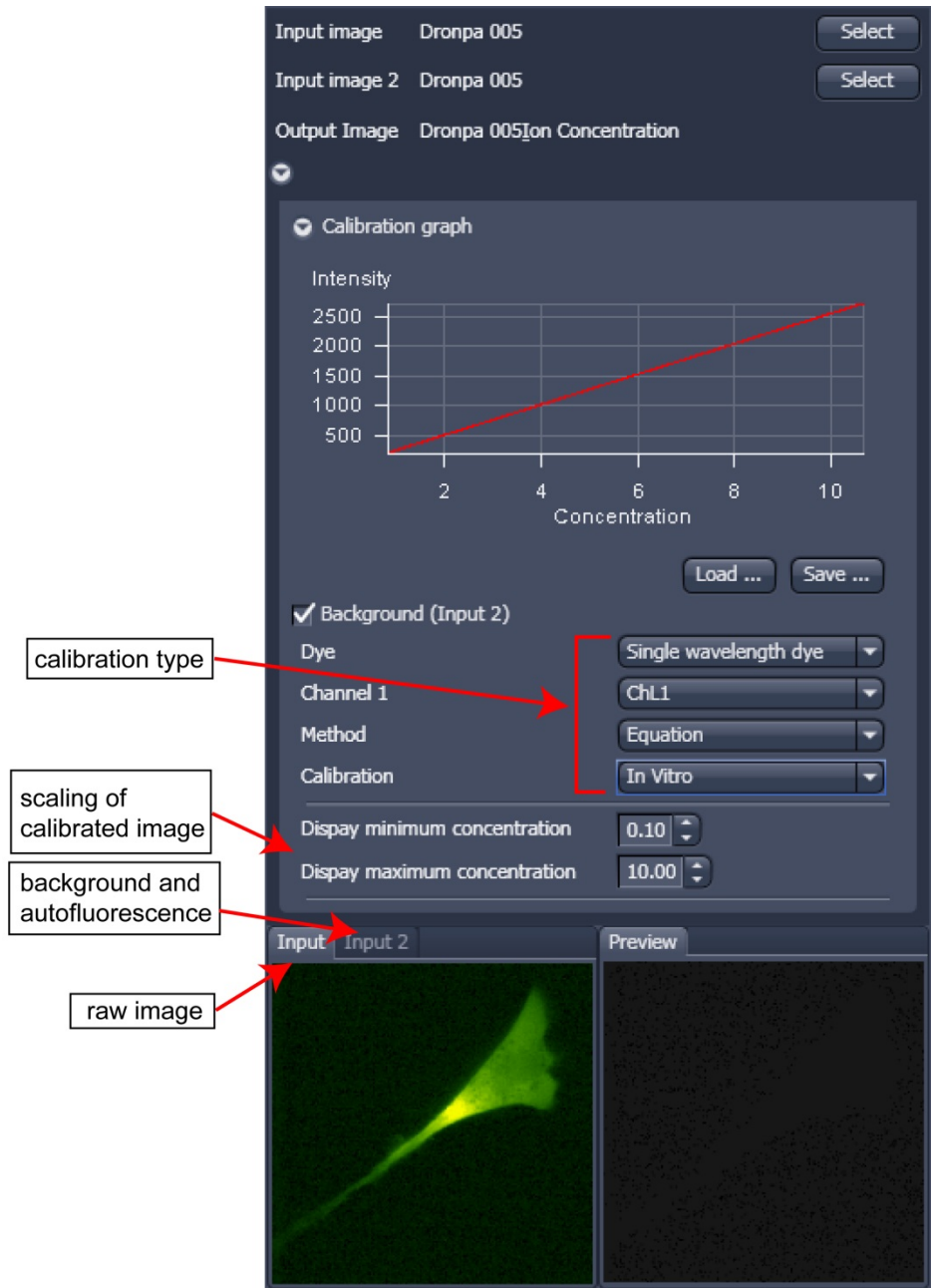
Available methods for **ratiometric** dyes: **Ratio**, **titration**, **equation**, and **unmixing**.

**Fig. 416 Fully opened Ion Concentration tool window - Ratiometric dye in equation mode**



**5.4.9.1 Single Wavelength Dyes – Offline Calibration**

- Subtract background/ autofluorescence image from raw images to obtain better raw data to start with (Fig. 417).
- Perform equation or titration calibration (compare F with a calibration curve → titration calibration or put F values in calibration formula).



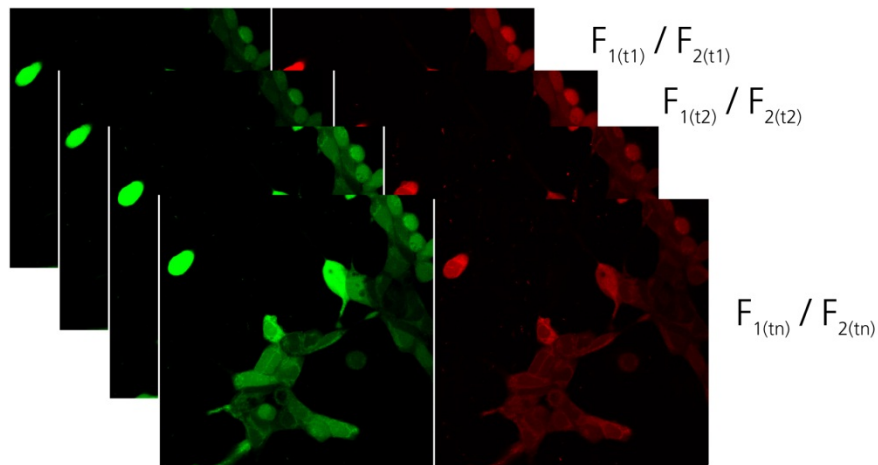
**Fig. 417 Ion concentration panel**

### 5.4.9.2 Ratiometric Dyes

- Fura-2, Indo-, SNARF, Cameleon, Ratiometric Pericam, Phluorin.
- Display fluorescence ratio  $R$  over time
- Display fluorescence ratio  $R$  corrected for background/autofluorescence over time
- Calculate absolute ion concentrations (pixel by pixel) via titration calibration (known ion concentrations applied to the cells – in situ – or in solutions – in vitro or equation calibration where possible [Fura-2, Indo-, SNARF])
- Calculation of  $R$  eliminates artifacts and uncertainties caused by
  - inhomogeneous dye distribution
  - photobleaching
  - may be applied with moving cells.

#### Ratiometric Dyes - Online Ratio (Fig. 418)

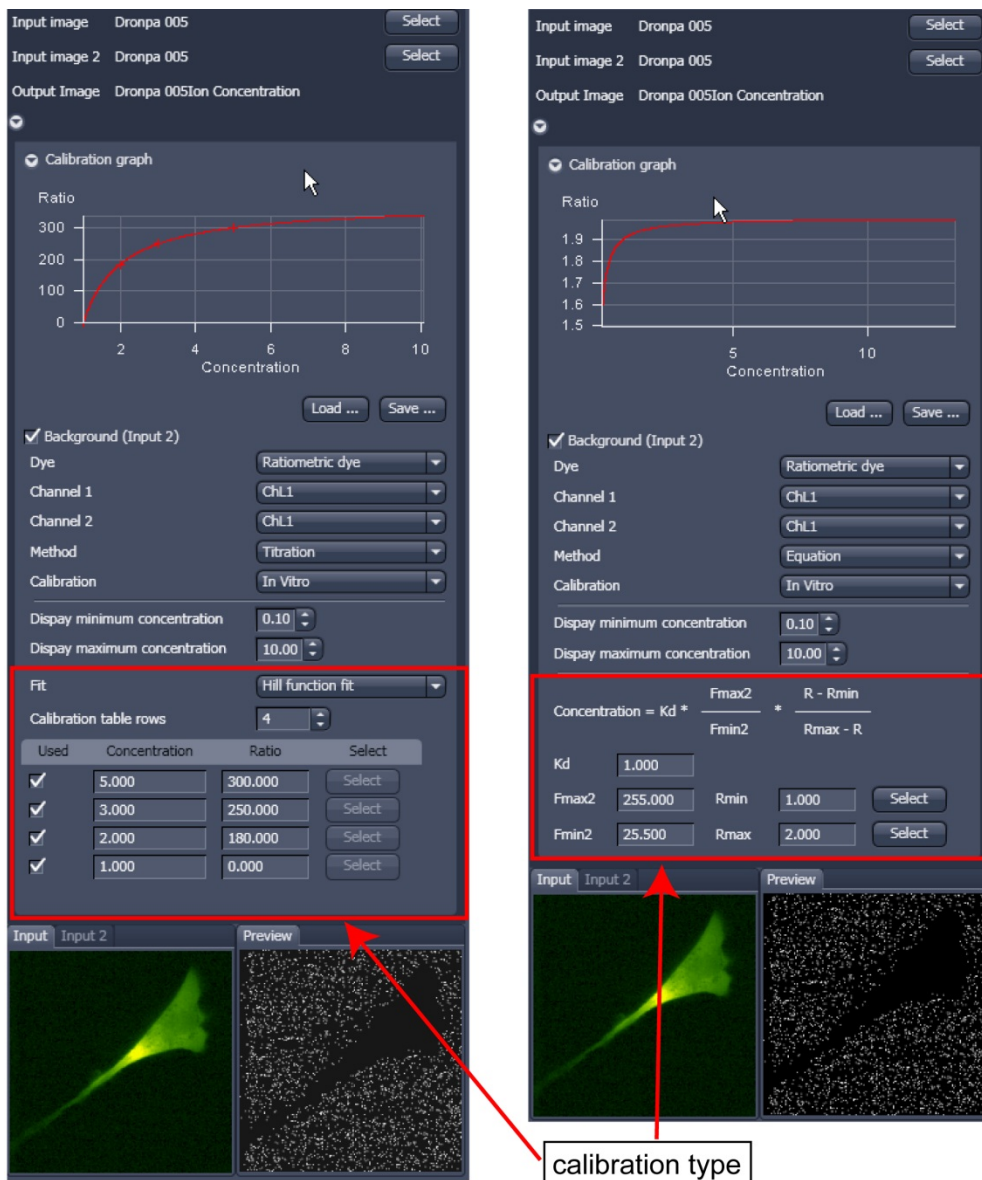
$$R(t_1) = F_1(t_1) / F_2(t_1), R(t_2) = F_1(t_2) / F_2(t_2) .$$



**Fig. 418** Ratiometric Dyes – online ratio

**Ratiometric Dyes - Calibration** (Fig. 419)

- Subtract background/autofluorescence images from raw images to obtain  
 $R_{korr} [=F1-F1_{Background}]/(F2-F2_{Background})]$   
 when calibration reference is not obtained with the experimental sample (in situ).
- Calculate ratio R.
- Perform equation- or titration calibration (compare R with a calibration curve → titration calibration or put R values in calibration formula).



**Fig. 419 Ion concentration panel**

Dye: Ratiometric dye

Channel 1: ChL1

Channel 2: ChL1

Method: Equation

Calibration: In Vitro

Display minimum concentration: 0.10

Display maximum concentration: 10.00

$$\text{Concentration} = K_d * \frac{F_{\max 2}}{F_{\min 2}} * \frac{R - R_{\min}}{R_{\max} - R}$$

Kd: 1.000

Fmax2: 255.000

Fmin2: 25.500

Rmin: 1.000

Rmax: 2.000

**Fig. 420 Ion concentration - Ratiometric dye, Equation Calibration**

### Ratiometric Dyes - Equation Calibration (Gryniewicz) (Fig. 420)

Fura-2, Indo-1,

$K_D$  (dissociation constant) taken from literature

$R_{\min}$ : derived from ion-free state of the dye (e.g. 0  $\text{Ca}^{2+}$ )

$R_{\max}$ : derived from ion-bound state of the dye (e.g. saturated with  $\text{Ca}^{2+}$ )

$F_{\min 2}$  and  $F_{\max 2}$  are the minimum and maximum fluorescence intensities at wavelength 2

$R_{\min}$ ,  $R_{\max}$ ,  $F_{\min 2}$  and  $F_{\max 2}$  may be determined in the cells under investigation (in situ) or in solutions (in vitro)

Calibration parameters may be saved and reloaded (\*.cal)

### Options for Calibration Image Selection (Equation- or Titration Calibration)

- Click into image window.
- Select source channel(s).
- Optional background subtraction
- Optional calculation of parameters from overlay region(s)

**5.4.10 Processing – Correlation**

Licensing		Instrument		
<input checked="" type="checkbox"/> standard	<input type="checkbox"/> optional	<input checked="" type="checkbox"/> LSM	<input checked="" type="checkbox"/> ELYRA	<input checked="" type="checkbox"/> Lightsheet Z.1

Tool accepts potentially all types of image files. See full description of tool for details.


- Activate **Correlation** in the **Processing** tool. The **Correlation** menu will appear (Fig. 421).

The **Correlation** processing function will display the spatial (only available in the **LSM imaging** mode) or temporal correlation of an image or image stack.

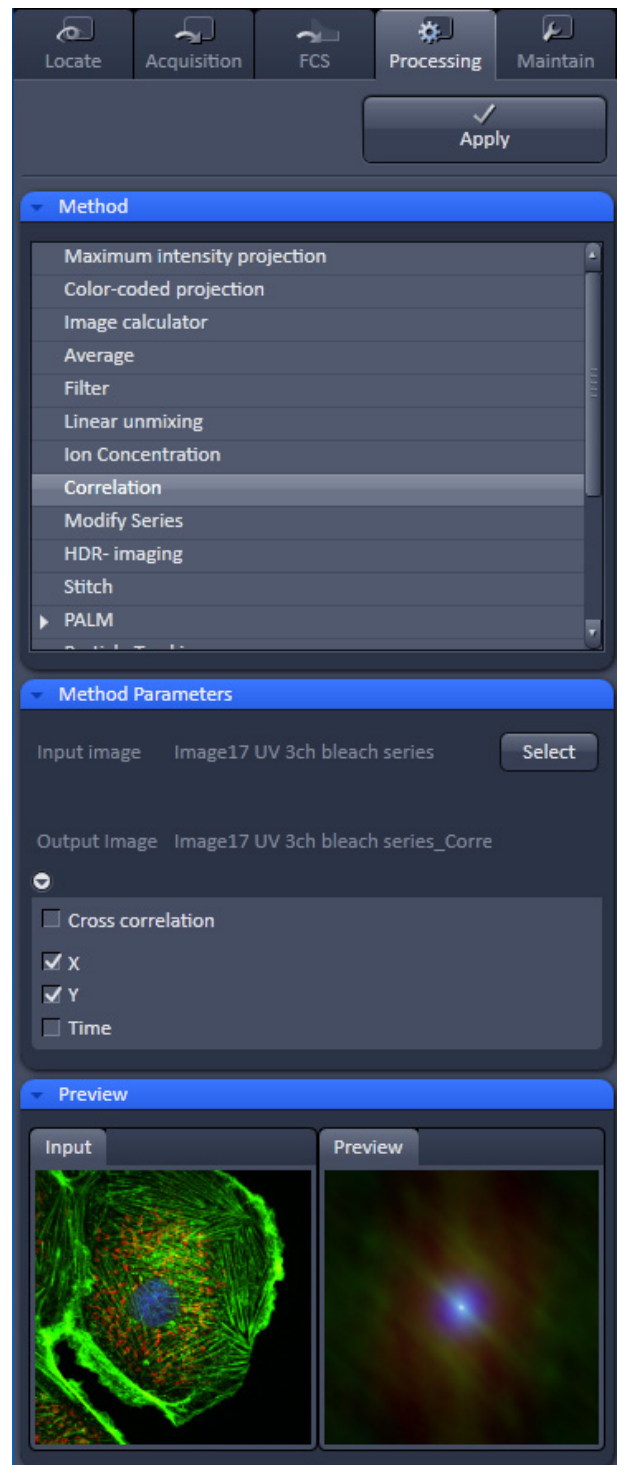
- To select an image, highlight the image in the image container and press the **Select** button. This will be your **Input** image.

As an output image the correlation image is computed and the result presented in the **Preview** window.

- You can select which kind of correlation you want to perform by activating the **X**, **Y**, **Z**, and **Time** check boxes to perform spatial correlations in x, y, and z-direction or a temporal correlation.

 Note **Z** and **Time** check boxes are only available for Z-Stacks or time series stacks.

- If the **Apply** button is pressed, the correlation image will be opened as a new image in the container.



**Fig. 421 Processing – Correlation**

5.4.11 Processing – Modify Series

Licensing		Instrument		
<input checked="" type="checkbox"/> standard	<input type="checkbox"/> optional	<input checked="" type="checkbox"/> LSM	<input checked="" type="checkbox"/> ELYRA	<input checked="" type="checkbox"/> Lightsheet Z.1

Tool accepts single image files (for concatenation) and multi-dimensional image series (typically time series and Z-stacks). See full description of tool for details.

This function allows modifying dimensions of images or image series (Fig. 422).

Depending on the input image (for example **Z-Stack** or **Time Series**) the available modifications vary, which are available in the Modify mode drop down menu (Fig. 423 and Fig. 424).

It allows modifying the acquisition date, rotating or mirroring the image(s), converting or reversing dimensions, renaming channels or making time series from Z-Stacks, tiles, or images from various positions. Furthermore it allows to concatenate time series or z-stacks when two input files are selected.

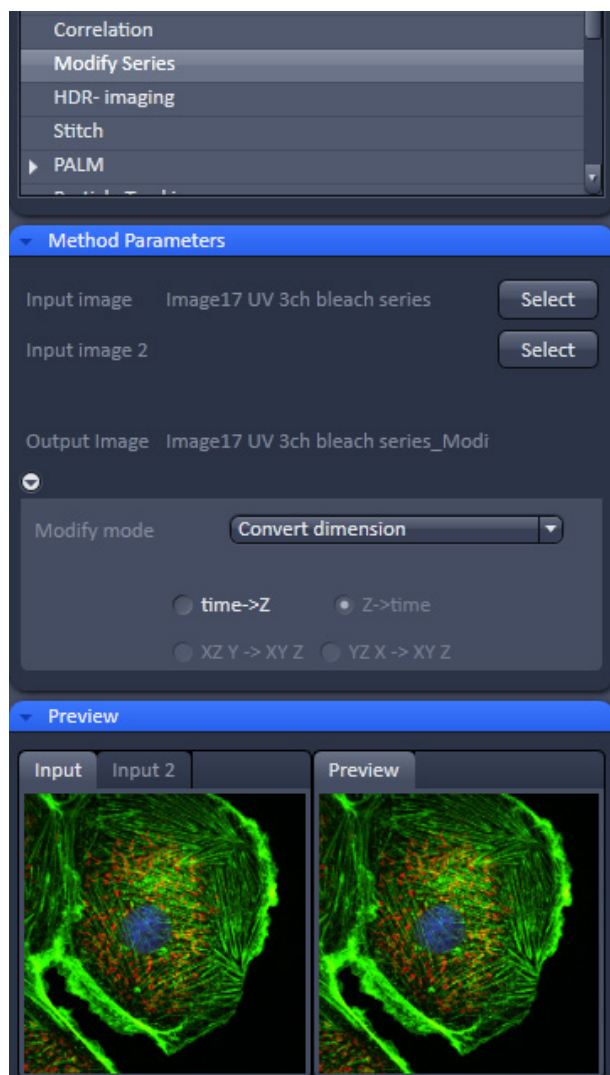


Fig. 422 Processing – Modify series

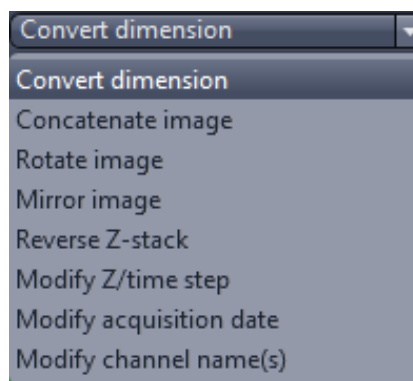


Fig. 423 Modify mode drop down menu – Z-Stack options

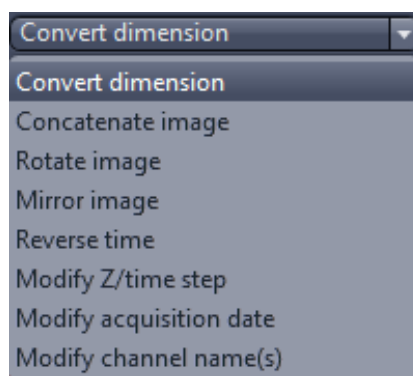


Fig. 424 Modify mode drop down menu – Time series options

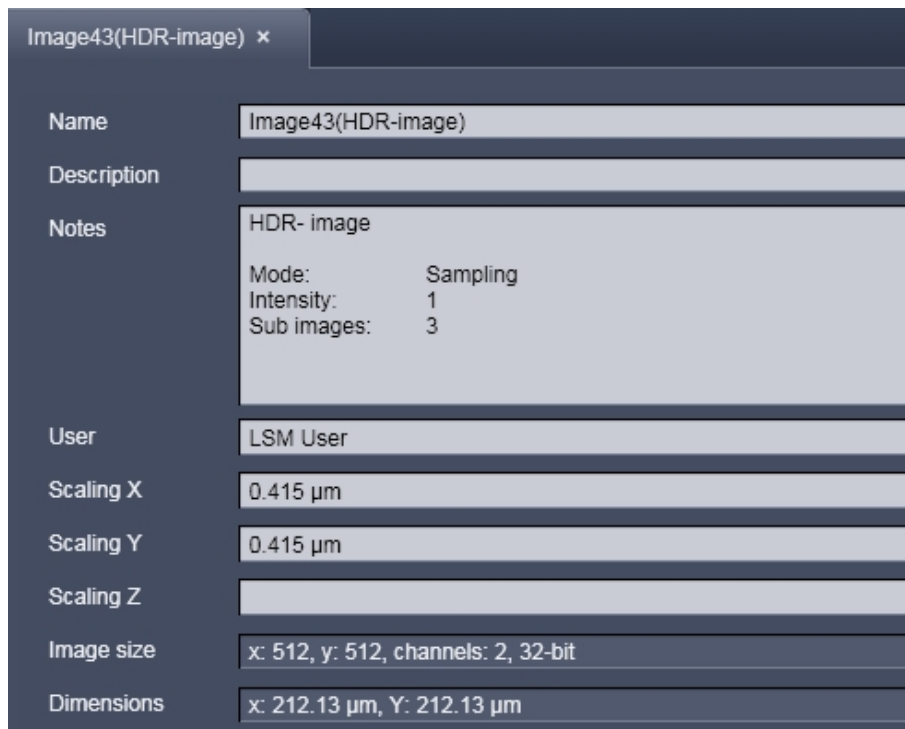
**5.4.12 Processing – HDR-imaging**

Licensing		Instrument		
standard	✓ optional	✓ LSM	ELYRA	Lightsheet Z.1

Tool accepts image data recorded with the optional feature "HDR" of the acquisition tool *Acquisition Mode*. In addition, input acquired either without using the feature "HDR" or on instruments other than LSM systems is potentially suitable for this processing tool as well (provided the input meets the requirements for HDR-imaging). See full description of tool for details.

Please see also the description of the HDR (High Dynamic Range) function (part of the Acquisition Mode tool) for details on HDR image recording with LSM systems.

HDR creates an image with a depth of 32-bit and therefore covers a far broader dynamic range than conventional images (8 to 16 bit).



**Fig. 425 Image info of a HDR image**

As a result of the HDR process, the grey scale is independent from the initial bit depth, but covers a range from 0-1.

Also, the grey stepping is much finer, with much better visibility of weak structures (Fig. 426).

The HDR method employed is also shown in the image info (Fig. 425).

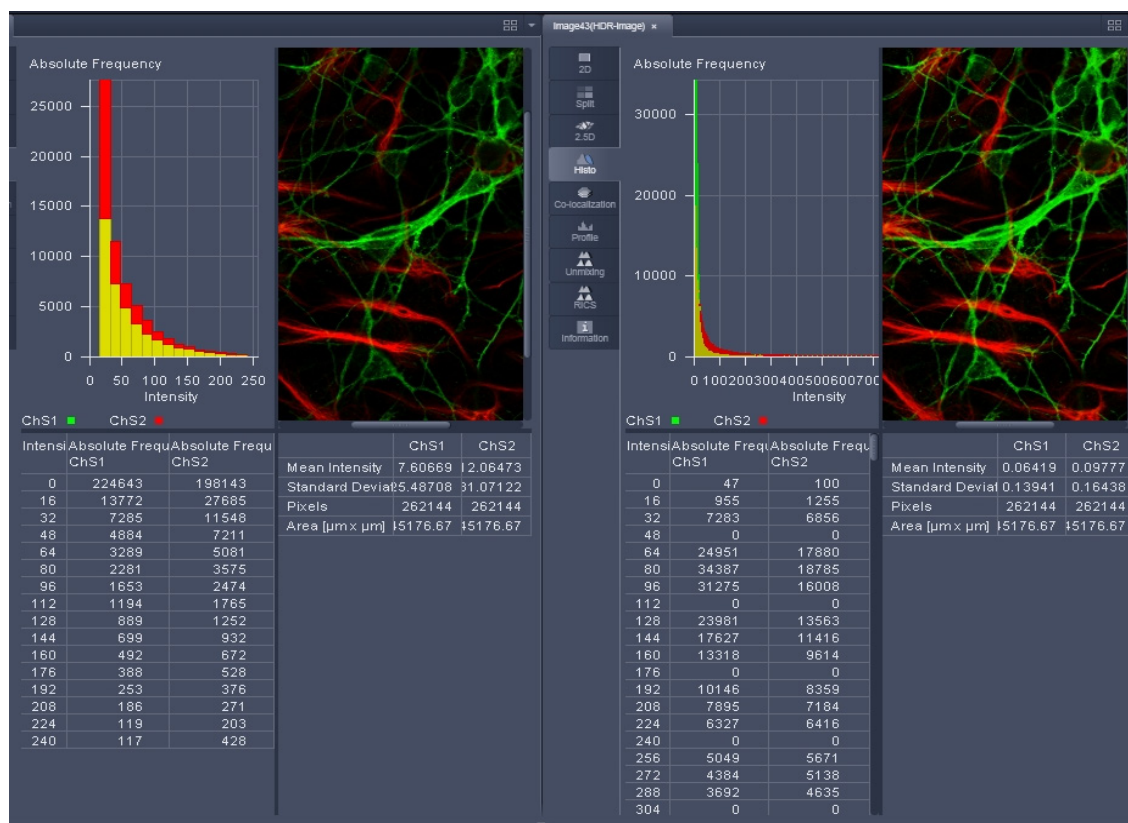


Fig. 426 HDR image display (left side without, right with HDR)

The **Sampling** mode is a meant to improve the image display as it equalizes the differences between the very high and the very low intensities in the image. However, it is not suitable for quantitative analysis as the level steps become non-linear.

The image re-calculation works already with a single image (**Frame** = 1) and is done in the following way taking **Intensity** 3.

Image x 1; cut off of grey levels above the dynamic range; Result divided by 1

Image x 2; cut off of grey levels above the dynamic range; Result divided by 2

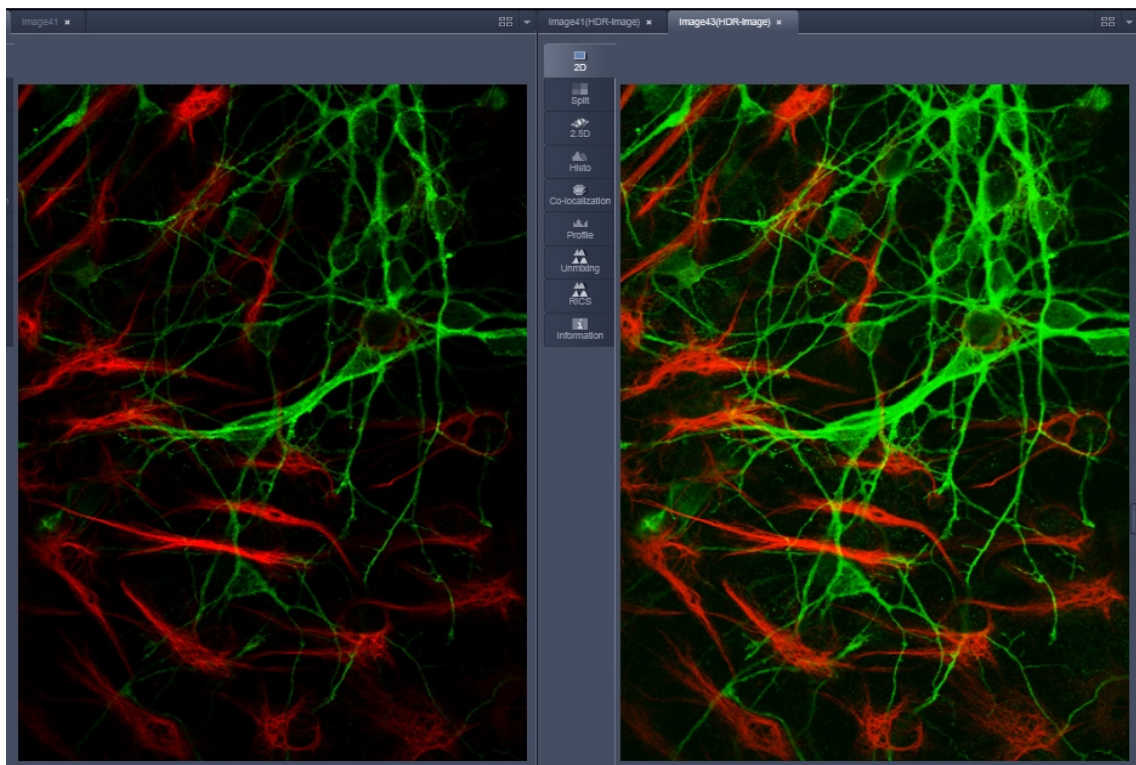
Image x 3; cut off of grey levels above the dynamic range; Result divided by 3

The three resulting images are summed up and again divided by 3. This procedure is adapted accordingly if a higher **Intensity** number is set. If two images are **acquired** (**Frame** = 2) and Intensity is still at 3, the second image is rated lower and is multiplied and divided in three steps with the value 4,5 and 6; The then 6 resulting images are summed up and divided by 6.

The image acquisition parameters are not changed for the acquisition of the two (or more) **Frames**.

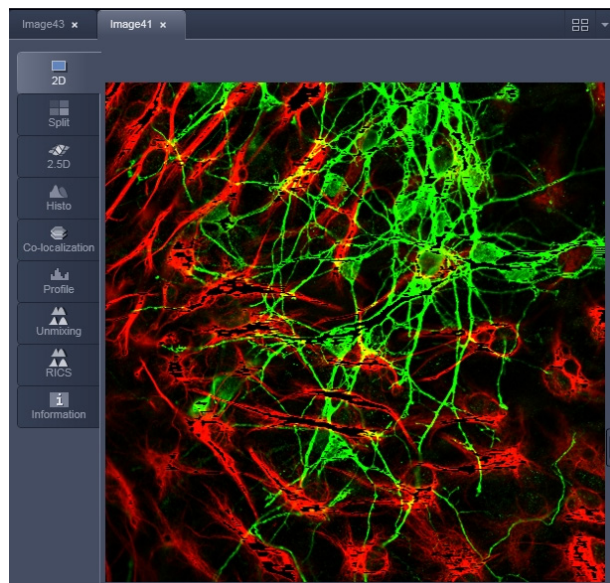


After acquisition, the grey dynamics of the image are automatically linearized (see description above) to match the range of the output display. This step visibly intensifies weak signals (Fig. 427).



**Fig. 427** HDR image display using Sampling mode (left side without, right with HDR)

Unlike the **Sampling** method, the **Illumination** method of HDR still provides a linear grey stepping which allows quantitative measurements. For the acquisition step with increased laser power, those regions of the image are excluded from exposures when no reasonable data can be obtained with any higher laser power.



**Fig. 428 HDR image display after using Illumination mode**

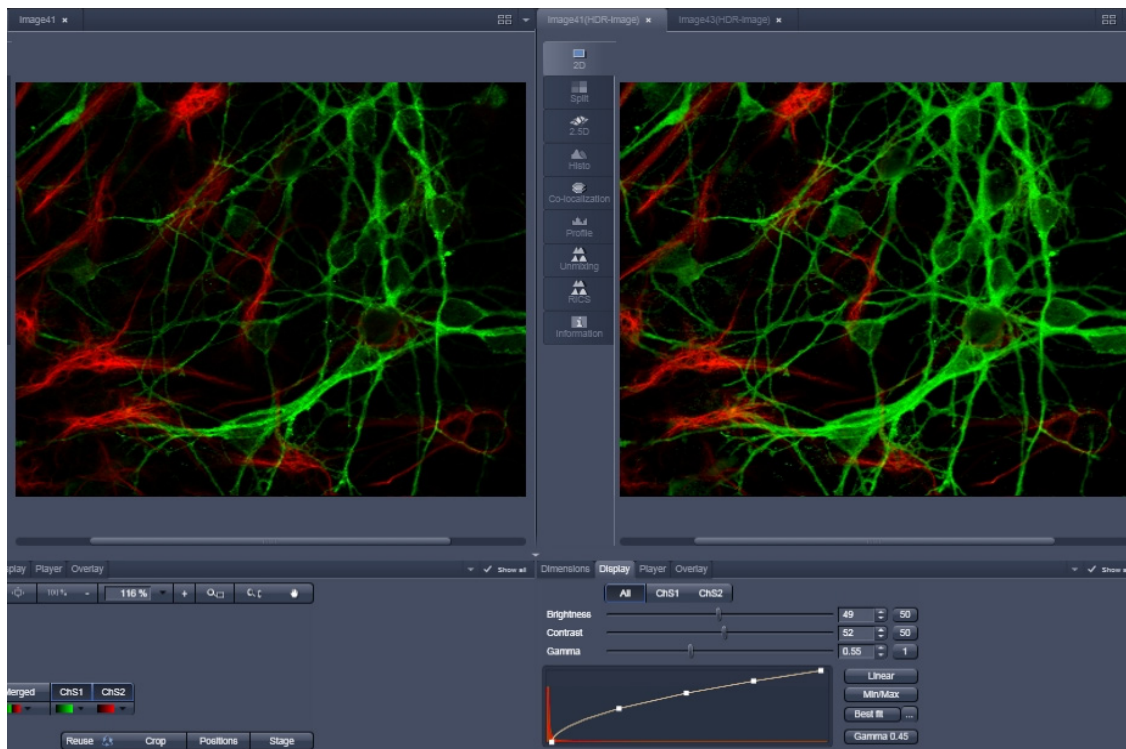
During data recording with the **Illumination** method, masks are applied to protect the sample from laser irradiation. The respective ROIs are displayed in an additional image (Fig. 428).

The calculation of the resulting image follows the same procedures as for the sampling mode. However, the regions, which are excluded from a second and/or third illumination step are divided by 2 instead of 3.

After acquisition, the grey dynamics of the resulting image are not automatically compressed to match the range of the output display.

Use the **Gamma** and **Contrast** sliders of the image display (Fig. 429) to adjust the image.

For manual adjustment, a result can be achieved which fits the individual requirements, without affecting the actual raw data stored with the image.



**Fig. 429 Image adjustment of the HDR image (left side without, right with HDR)**

### 5.4.13 Processing – Stitch

Licensing	Instrument
<div style="border: 1px solid gray; padding: 2px; display: inline-block;">                     standard   ✓ optional                 </div>	<div style="border: 1px solid gray; padding: 2px; display: inline-block;">                     ✓ LSM   ✓ ELYRA   Lightsheet Z.1                 </div>
Tool accepts image data recorded with the acquisition tool <i>Tile Scan</i> (incl. combinations with other multi-dimensional acquisition tools). Images recorded in SIM mode on ELYRA (SIM data) must be processed with the tool <i>Structured Illumination</i> before stitching. For optimal results, image data should have some degree of lateral overlap. See full description of tool for details.	

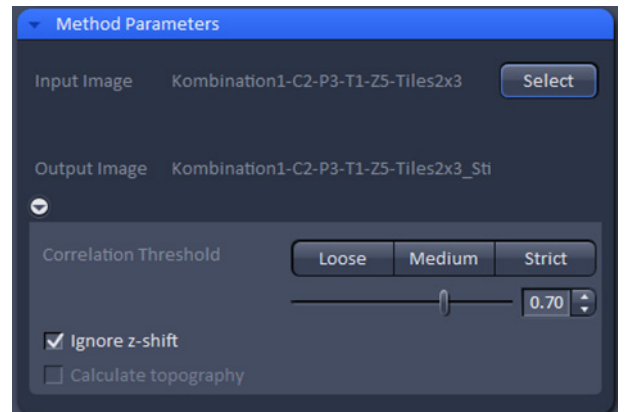
With this function tiled images acquired with Versions of ZEN 2012 and upwards and the tiling function can be stitched together in 2D and 3D.

Select a tiled image (or stack) with the **Select** button (Fig. 430).

The **Correlation Threshold** is defining the accuracy with which the algorithm detects similarities in the adjacent image planes.

If a 3D tile scan image has been acquired (Tile Scan combined with Z-Stack) then additional functions for the stitching procedure are available.

**Ignore z-shift** will in some cases reveal better results for the 3D stitch. Depending on the image data the last step of the stitch algorithm, which makes a correction of the Z-Stacks in Z looking at the overall image, can lead to unwanted shifts of the stacks in Z. This can be avoided when this option is checked.

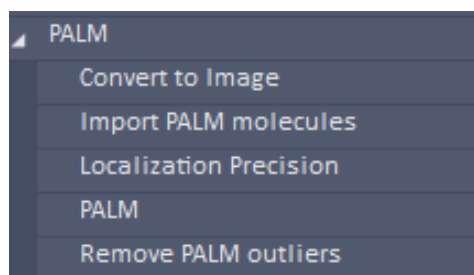


**Fig. 430 Processing – Stitch, Method Parameters tool**

**5.4.14 Processing – PALM**

Licensing	Instrument
standard <input type="checkbox"/> optional <input checked="" type="checkbox"/>	LSM <input type="checkbox"/> ELYRA <input checked="" type="checkbox"/> Lightsheet Z.1 <input type="checkbox"/>

Tool exclusively accepts PALM data. See full description of tool set for details.

**Fig. 431 Processing – PALM**

The **Processing PALM** tool (Fig. 431) is applied to data acquired in the **PALM imaging** mode. It subdivides in 5 subcategories.

- **Convert to Image:** Converts the table (vector map) of a PALM image to a bona fide image.
- **Import PALM molecules:** Import function for molecule tables
- **Localization Precision:** Attaches to an Experimental PSF a localization precision look up table based on simulations.
- **PALM:** Peak finding and localization
- **Remove outliers:** Filter to select for molecules surrounded by a threshold number of other molecules

#### 5.4.14.1 PALM – Convert to Image

The **Convert to Image** function allows converting the vector map of centroids to be transformed to a bona fide image.

Select the **Convert to Image** tab to select the **Convert to Image** processing tool (Fig. 432).

Highlight the PALM image in the image container you want to convert and press **Select** (Fig. 433). Press **Apply** to convert the HR channel to a true image.

The new file has the extension "name\_PALM-ConverttoImage" as a default.

It contains the **HR** channel and **SWF** channel as grey value pixel images for 2D PALM. For 3D PALM it will contain the Z-Stack HR image file; no SWF image is available for 3D PALM.

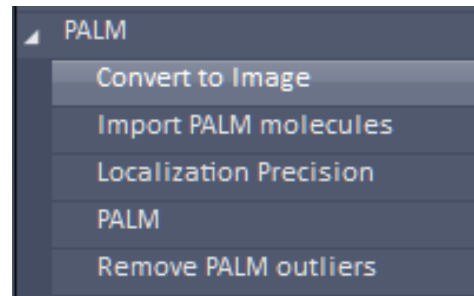


Fig. 432 Processing – Convert to Image tool selected

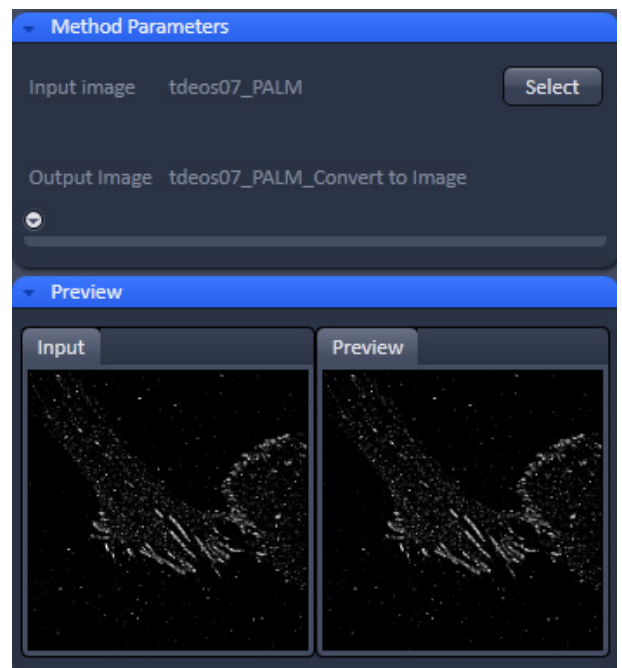
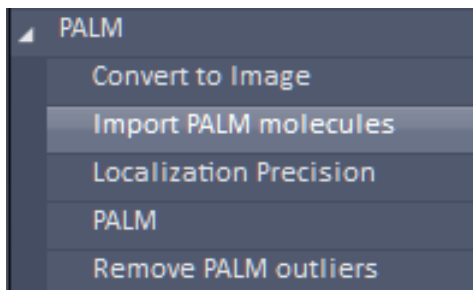


Fig. 433 Processing – Convert to Image

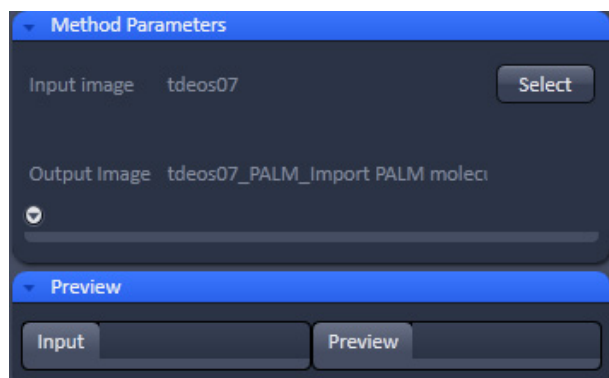


**Fig. 434** Processing – Import PALM molecules tool selected

#### 5.4.14.2 PALM – Import PALM Molecules


The **Import PALM molecules** function allows importing PALM molecule tables saved as text files (extension .txt) and reconstruct a PALM image from the table.

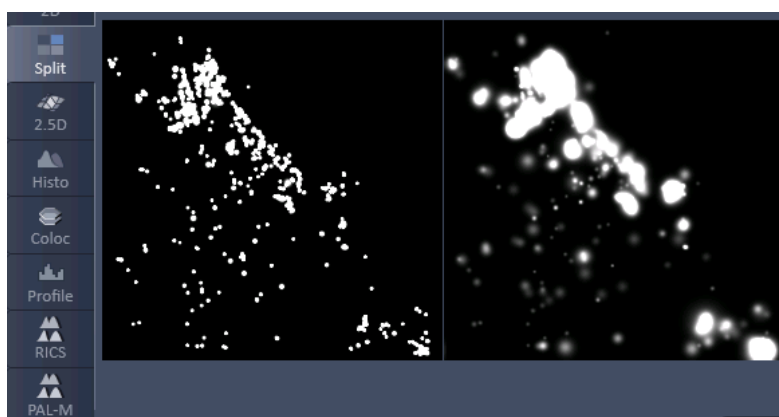
Select the **Import PALM molecules** tab to select the **Import PALM molecules** processing tool (Fig. 434).



**Fig. 435** Processing – Import PALM molecules

Press **Select** (Fig. 435) to open **Windows Explorer** and select the molecule table you want to import. Press **Open** to load the table and then press **Apply** to create the PALM and sum widefield images (Fig. 436).

 There are no tools available if the **Methods Parameters** tool area is expanded.




**Fig. 436** PALM image (left) and sum widefield image (right) in the Split mode after importing a molecule table


### 5.4.14.3 PALM – Localization Precision

Select **Localization Precision** to attach a Localization Precision look up table (LUT) to an Experimental PSF (Fig. 437).

Highlight the Image with the Experimental PSF (should be derived from the PSFs obtained by a 4  $\mu\text{m}$  stack of 100 nm beads) and press **Select** (Fig. 438).

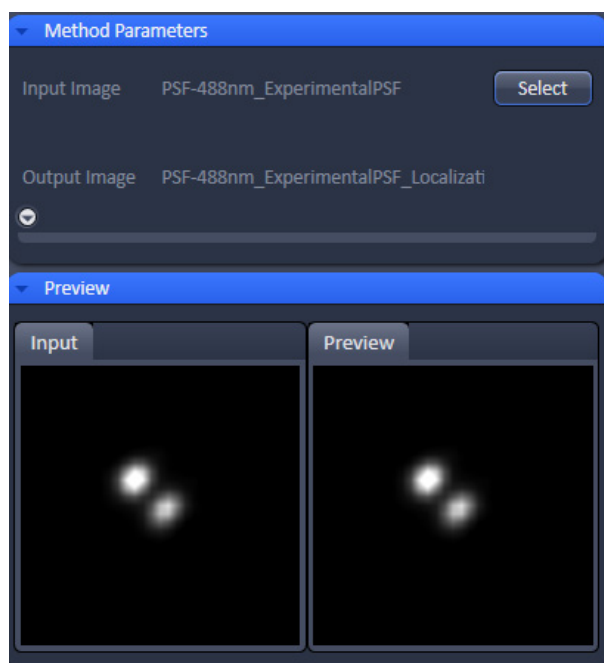
Press apply to obtain a file of the Experimental PSF with LUT attached. The file bears the extension "LocalizationPrecision".

 Please note that the localization precision will be estimated using a Monte-Carlo Simulation of the experimental PSF including noise. The generated lookup table will then contain the localization precision depending on the three parameters photon number, background variance and Z position.

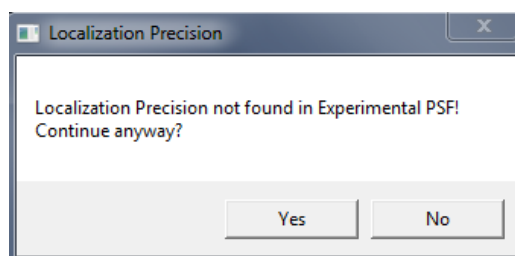
 The Experimental PSF with attache LUT should be used when fitting 3D PALM data. If only an Experimental PSF without LUT is used, a warning message pops up (Fig. 439). Press **No** to cancel processing or **Yes** if you want to continue. In this case, only a rough estimate of the localiszation precision will be given.



**Fig. 437 Processing – PALM Localization Precision tool selected**



**Fig. 438 Processing – PALM - Localization Precision with double-lobed Experimental PSF loaded**



**Fig. 439 Localization precision warning**

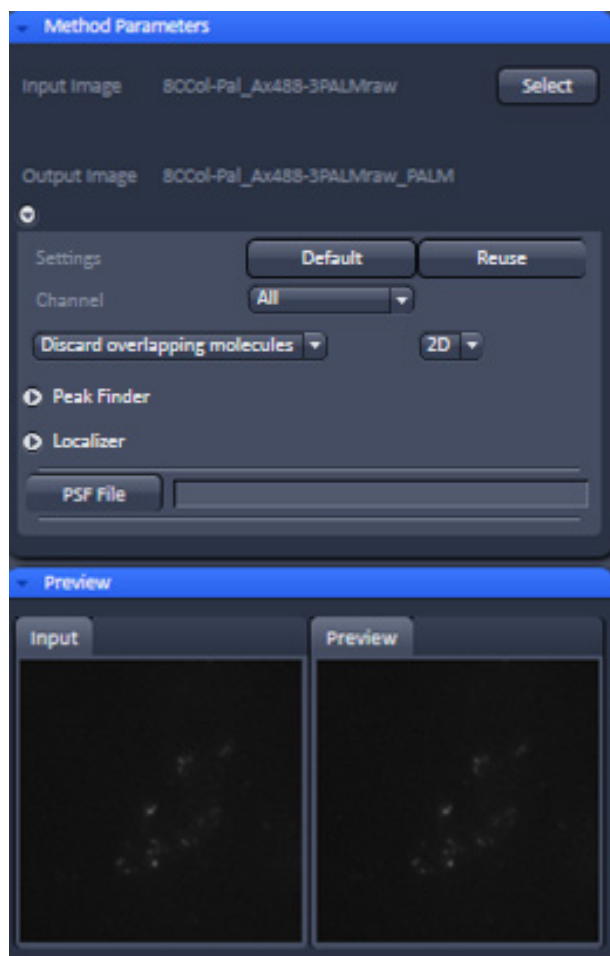


Fig. 440 Processing – PALM – PALM

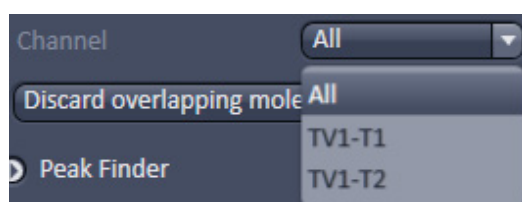


Fig. 441 Channel drop down menu of a dual channel data set

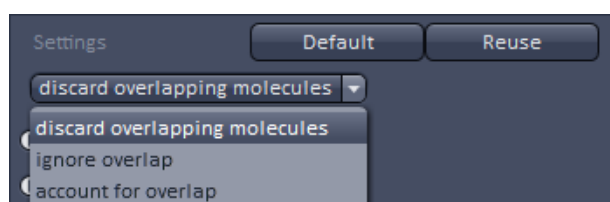



Fig. 442 Settings drop down menu

#### 5.4.14.4 PALM – PALM

The **PALM** function allows setting filters for peak finding and choosing a fit model for the localization calculations.

Select the **PALM** tab to select the **PALM** Processing tool (Fig. 431). Activate the image you want to process in the image container and press the **Select** button to load the image. Then expand the **Method Parameters** tool window to have access to the **Peak Finder** and **Localizer** (Fig. 440).

 You have to select the subdirectory **PALM** tab in order to have the PALM functionalities available. The directory **PALM** tab will not give access to the PALM tools.

Pressing the **Settings Default** button will reset all filter and parameter settings to the default values.

Pressing the **Settings Reuse** button will recall the parameter settings of the actively selected image.

The **Channel** drop down menu allows you in a multi-channel experiment to apply different settings to different channels, which are all listed (Fig. 441). If you select **All**, all channels will be fitted the same way. If you select a channel, and change settings, these setting will apply only to this channel. Note, even if only one channel is selected, every channel will be fitted according to the last settings.

The **Settings** drop down menu (Fig. 442) will allow you to define how peak events will be fitted. You have three options:

- **Discard overlapping molecules** (single emitter): only single emitters will be taken into account and fitted, whereas all multi-emitter events will be discarded.
- **Ignore overlap** (ignore emitter): all single- and multi-emitter events will be taken into account and fitted as single emitter events.



- **Account for overlap** (multi-emitter): multi-emitter events will be fitted taking into account the overlap. If selected, the **Maximum cluster size** slider and input box become available (Fig. 443). Here you can select the maximum number of molecules in the cluster that are used for computation. So a number of 10 means, for example, that clusters with 10 or less peaks will be taken, and those exceeding 10 will be discarded. We recommend to limit cluster size to 10 as otherwise computation can become time consuming.

White circles indicate that the particular emitters are used (if channel color is grey; otherwise the channel color is used), red circles that the emitters are discarded for the fitting process. For account of overlap the color stays white or in the channel color regardless if a cluster may be discarded due to the **Maximum cluster size** setting.

The **Dimension** drop down menu will display the dimensionality (2D or 3D) of the selected PALM image, which is automatically recognized if a .czi format is loaded (Fig. 444). It is possible to overrule the automatically chosen value.

In the **Channel** drop down menu you can select the channel for which the Processing should be conducted for a multi-channel image.

Expand the **Peak Finder** field to have access to the peak selection filters (Fig. 445). Two filters are available:

- **Peak mask size**
- **Peak intensity to noise**

Use the sliders or input spin boxes to set the corresponding values.


 We recommend to start with the default values for the peak mask size (9 for 2D; 19 for 3D data) and then optimize on behalf of the results. Note that in 3D-PALM using PRLIM (phase ramp localization imaging microscopy) with a double phase ramp, the PSF is split into two lobes (Fig. 446) that have a larger expansion than the classical PSF.



Fig. 443 Maximum cluster size field



Fig. 444 Dimension drop down menu



Fig. 445 Peak Finder Expansion field

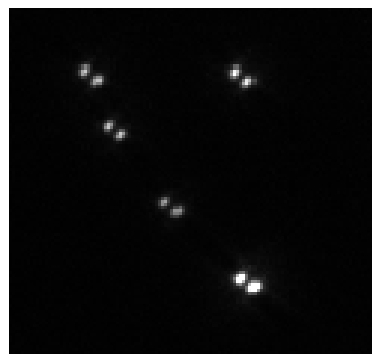
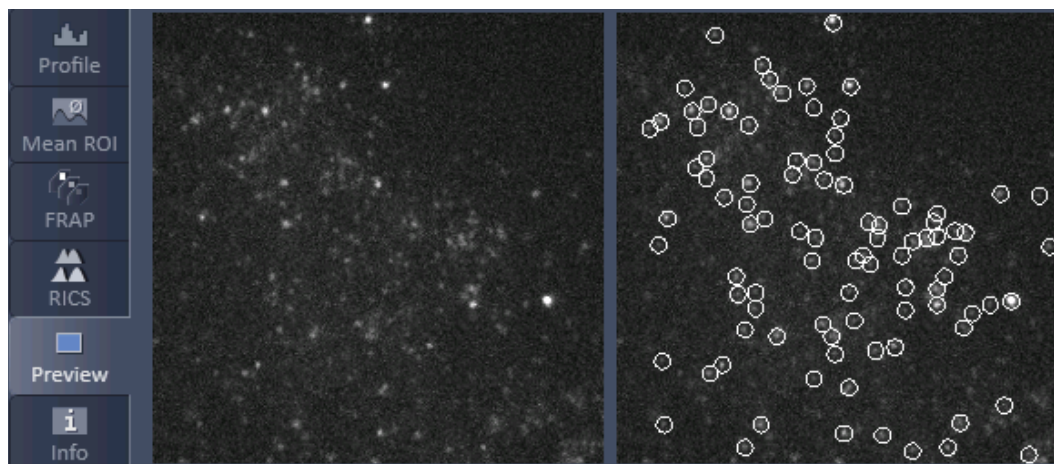


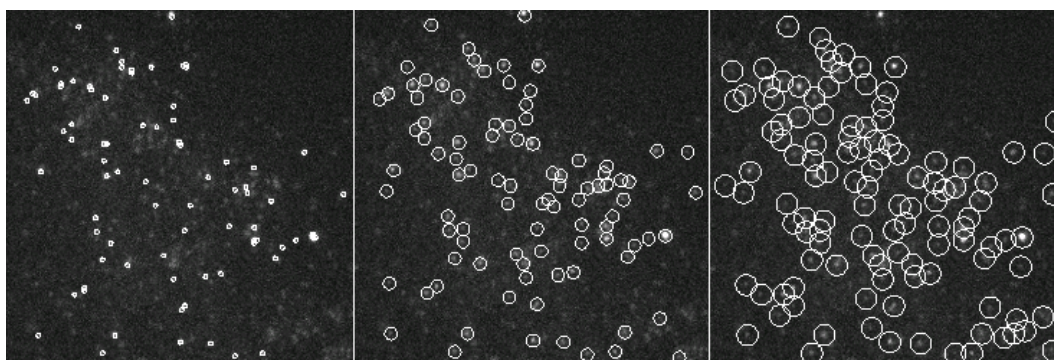
Fig. 446 Double lobed PSF created by a double phase-ramp in the pupil plane

The **Peak mask size** filter defines the radius in **pixel** units for a detected peak intensity that will be used to cut out the peak and put the peak into a new coordinate system. The size will also be used when fitting a 2D Gauss function to the intensity distribution of the peak.

If the image was selected by pressing the **Select** button, the **Preview** window of the Image in the image container will show all identified peaks circled (Fig. 447). The radius of the circles will correspond to the set value of the **Peak mask size** (Fig. 448).



**Fig. 447** Preview window of the image container for PALM processing



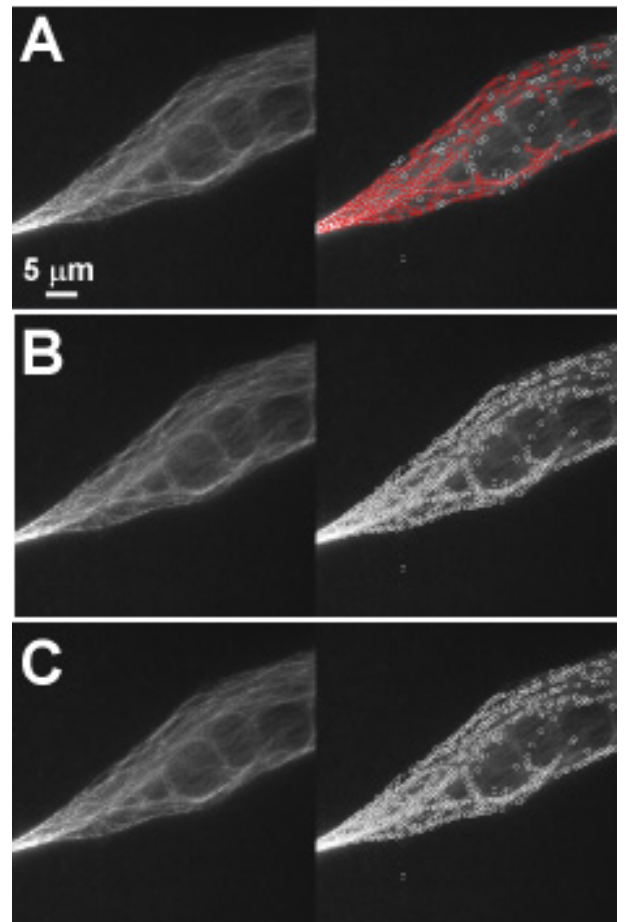
**Fig. 448** Preview window of the image container for PALM processing with the Peak mask size set to 3 (left), 9 (middle) and 15 (right) pixels

☞ The bigger the radius the more prone are closely juxtaposed peaks to overlap. The smaller the circles the more likely it is that one peak with a broad intensity distribution will be taken as two or multiple peaks. The preview can be taken to decide what the best radius will be. 9 and 19 pixels will work in > 95 % of the cases for 2D and 3D PALM experiments, respectively.

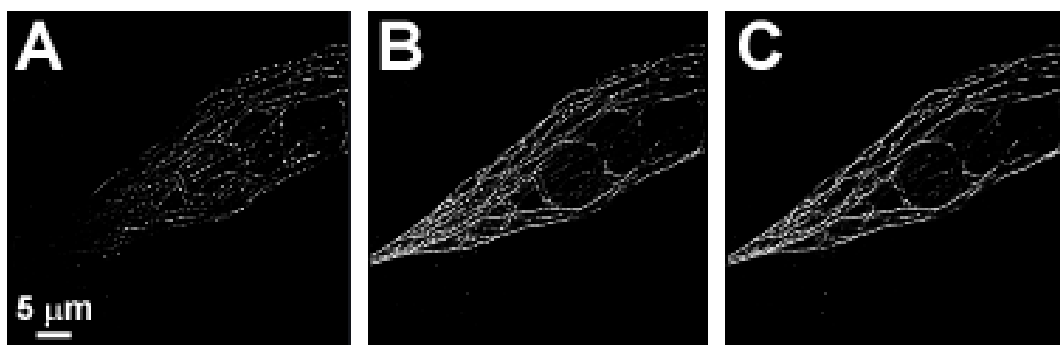
☞ If a circle around a peak lying at the borders of the image does not fit completely within the image, the peak is discarded.

If the **discard overlapping molecules** was selected from the **Settings** drop down menu, all identified peaks with overlapping circles will be indicated in red and discarded (Fig. 449). If **ignore overlap** or **account for overlap** was selected, overlapping peaks will not be indicated and all peaks will be circled in white.

- If **discard overlapping molecules** is selected, all overlapping peaks, indicated by red circles will be discarded. This will result in the highest accuracy, which is defined as the deviation of the fitted to the real peak position and localization precision (the standard deviation from the fit) (Fig. 450, **A**). This method is therefore the method of choice for single emitters and little overlap.
- If **ignore overlap** is selected, all single and overlapping peaks will be taken into account. However, fit accuracy will be decreased when multi-emitter events are fitted as the distribution of one emitter will influence the distribution of an overlapping one without this fact taken into account. Hence accuracy might suffer for multi-emitter events whereas localization precision will be sustained. (Fig. 450, **B**). This method is most suitable for slightly overlapping molecules.
- If **account for overlap** is selected all single and multi-emitter events will be taken into account. For multi-emitters the overlap of neighboring molecules is taken into account so losses in accuracy are minimized. There will be a slight decrease in the localization precision (Fig. 450, **C**). This method should be used, when molecules heavily overlap.



**Fig. 449** Preview window of the image container for PALM processing with the discard overlapping molecules (A), ignore overlap (B) and account for overlap (C) selected

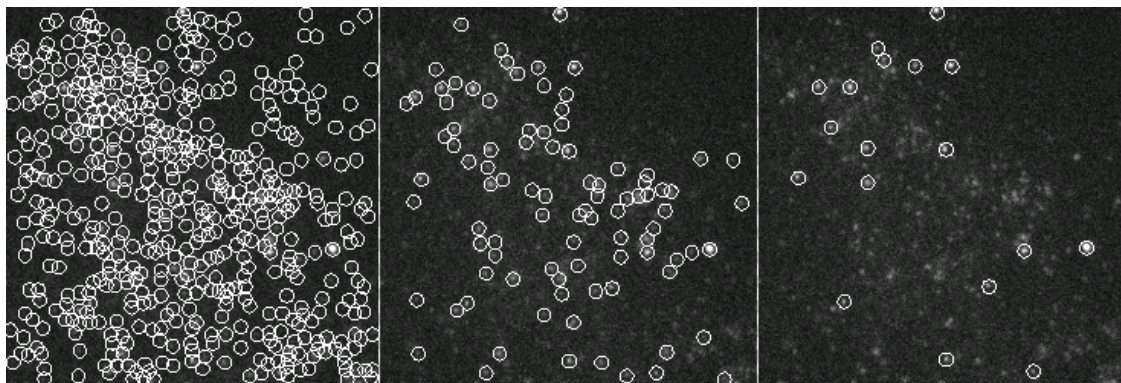


**Fig. 450** Analyzed data set of Fig. 449 using discard overlapping molecules (A), ignore overlap (B) and account for overlap (C).


The **Peak intensity to noise** filter defines the threshold of the signal strength of an identified peak over background, at which the peak is regarded to be genuine. The filter works as follows:

- The highest intensity peak with the intensity  $I$  is identified in the frame
- The mean intensity  $M$  and the standard deviation  $SD$  is calculated from the frame
- The Peak intensity to noise ( $PI$ ) is set.
- If  $I - M > SD \times PI$  than the peak is regarded to be genuine
- The peak is cut out of the frame and the next highest intensity peak is selected.
- The procedure is repeated until  $I - M < SD \times PI$ . Than the peak finding process will end for that frame.

All identified peaks above the threshold will be displayed per frame in the Preview window (Fig. 451).



**Fig. 451** Preview window of the image container for PALM processing with the Peak intensity to noise set to 3 (left), 6 (middle) and 10 (right)

 The higher the **Peak intensity to noise** factor, the more stringent is the peak selection. Too low numbers will result in noise being falsely identified as peaks; too high numbers will miss some genuine peaks. The preview can be taken to decide what the best value will be for the particular image series. The default value of 6 will work in > 95 % of the cases.


Expand the **Localizer** field to have access to the fit model used to localize peaks (Fig. 452). Three fit models are available that can be selected by the **Fit Model** drop down menu (Fig. 453) if 2D is selected from the Dimension drop down menu:

- **x,y 2D Gauss Fit**
- **Mask fit**
- **File PSF**


If **3D** is selected from the **Dimension** drop down menu, only **File PSF** is available. You should load an Experimentatl PSF with linked look up table for localization precision in order to obtain localization precisions in z in addition to x and y.


If **x,y 2D Gauss Fit** is selected, the intensity distributions of the identified peaks are fitted to a full 2D Gaussian function. The fit in each direction takes into account the influence of the other direction (x,y 2D Gauss).


If **Mask Fit** is selected, a Gaussian mask with a defined PSF width is used to match as best as possible the intensity distribution of a peak in x and y (Fig. 454). The PSF width can be set via the PSF Width slider or input spin box. Default value is the theoretical calculated PSF based on the objective lens and laser line used.

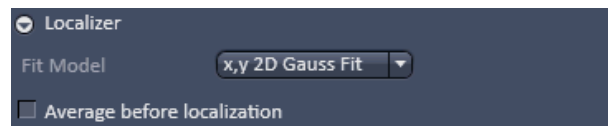
 Note that with the **Mask Fit** only one predefined PSF width will be used. Computation of the Fit will be faster for the **Mask Fit**, but less precise.

If **File PSF** is selected, you can select a PSF that will be used (Fig. 455). To this end press the **PSF file** button. This will open Windows Explorer, where you can select an appropriate file, the name of which will be displayed in the **PSF file** display box.

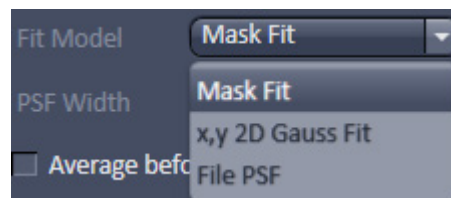
 The fit model in 2D defines the PSF width, which will be used to fit to the experimental results. It does not correspond to the size of the peak that is defined by the Peak Mask Size and that in the end will define the overlapping degree of neighboring peaks. In 3D the PSF with the attached look up table is a simulation where the PSF was modulated.

 The settings of the **Localizer** will not influence the peak finding process and hence the preview image.

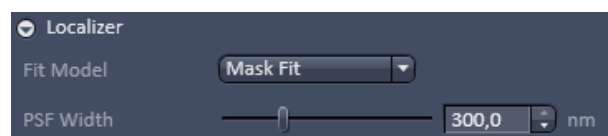
 In the Processing **PALM** function, peak finding and localization are always linked. If you want to just view localized peaks (molecules), you might select in the **PAL-Render** tab of the PALM image in the **Display** drop down menu **Centroids**.



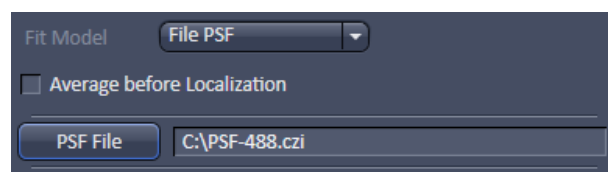
**Fig. 452** Localizer Expansion field with x,y 2D Gauss Fit selected



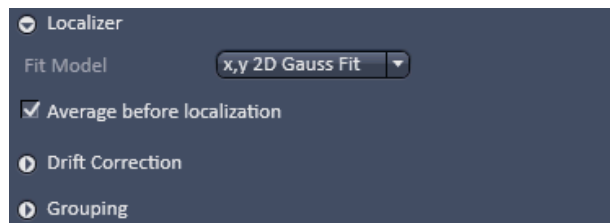
**Fig. 453** Fit Model drop down menu



**Fig. 454** Localizer Expansion field with Mask Fit selected



**Fig. 455** File PSF menu



**Fig. 456** Localizer Expansion field with **Average before localization** selected

If the **Average before Localization** check box remains inactive, every peak (event) will be localized independently and is regarded as being derived from one molecule. Later on, peaks can be grouped belonging to one molecule in the image container in the **PAL-Grouping** tab of the image (**localization before grouping**). If the check box is ticked, however, the system will group peaks (events) based on the filter settings that become available (Fig. 456) before localizing the grouped peaks (**grouping before localization**).

When **localization before grouping** is performed, the single peaks are first localized and then the localizations averaged. When **grouping before localization** is performed, than the peaks are first averaged and then localized.



**Fig. 457** Drift correction panel

There will be two filter settings when one performs grouping before localization:

- Filters for **Drift Correction** based on fiducial markers (like gold particles).
- Filters for **Grouping** the peaks (events).

Expand the **Drift Correction** field to have access to the **Drift Correction** tool (Fig. 457). If you want to perform a drift correction the **Drift Correction** check box must be ticked.

Note that for lateral drift correction the system needs to identify at least one fiducial marker based on the **Drift Correction** filter settings. Fiducial markers could be gold particles deposited on the glass surface of the dish. If the system cannot find a fiducial, no drift correction will be performed and in the **PAL-Drift** tab of the image no fiducials will be listed in the **Fiducial** table.

You can set two parameters to be associated with a fiducial by using the sliders or the spin input boxes:

- **Min on time [%]**. This defines the minimal number of frames out of the total frames acquired in percentage the molecule has to be on in order to be regarded as a fiducial. E. g. 75 % means that the molecule has to be on at least  $\frac{3}{4}$  of all the frames.
- **Capture radius [pixel]**. This defines the radius around a fiducial in which no other fiducial should be localized in order to be taken as a fiducial. E. g. if 2 pixels was set and within two pixels another fiducial is present, than both fiducials will be discarded.

Note that the settings of the **Drift Correction** will not influence the **Preview** image.


Note that using **Drift Correction** in the Processing tool is irreversible. Therefore, in the created image all drift related functions in the **PAL-Drift** tab will be inaccessible and greyed out.

Expand the **Grouping** field to have access to the **Grouping** tool (Fig. 458).


You can set two filters to be taken into consideration when peaks (events) are grouped:

- **Off Gap.** If peaks within the defined **Capture Radius** will be interrupted by more than the set value of consecutive frames, they will not be regarded belonging to the same molecules.
- **Capture radius [pixel].** If peaks in consecutive frames are not localized within the specified radius they are not regarded as belonging to the same molecule.

 Note that the settings of the **Grouping** will not influence the **Preview** image.

 Note that using **Grouping** in the processing tool is irreversible. Therefore, in the created **PAL-Grouping** tab all functions will be greyed out and not accessible.

If all parameters and filters are set press the **Apply** button. This will create the PALM image in the image container and the **PALM** view tab becomes available that allows further processing and analysis of the image. The container will display PALM image (**HR** channel) as well as the sum widefield image (**SWF** channel – not available for 3D-PALM) (Fig. 459).

 Note that in contrast to the TIRF image, which is the raw image of the point spread functions (PSFs), the sum wide-field image is the background corrected image of the PSFs and the PALM image is a vector map of centroids.

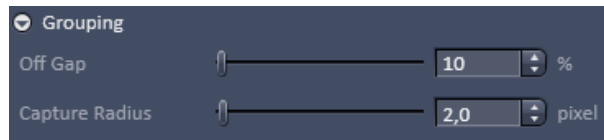


Fig. 458 Grouping panel

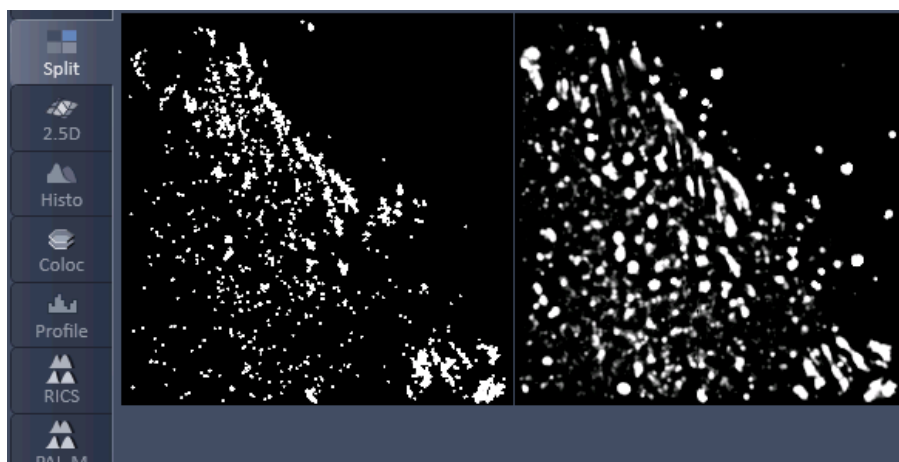
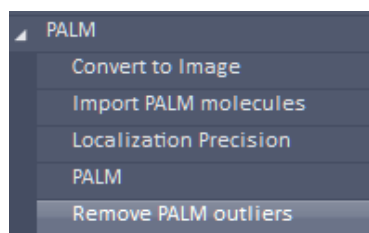
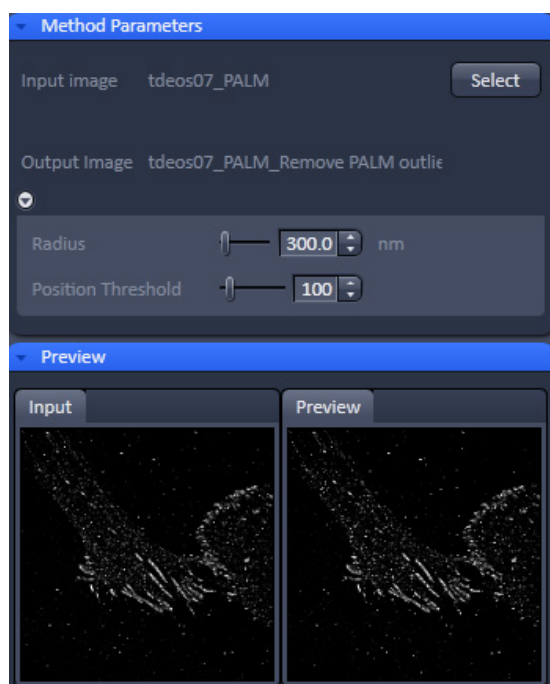


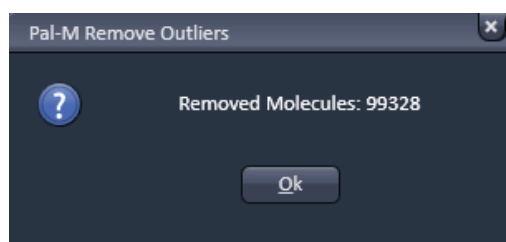
Fig. 459 PALM image (left) and sum widefield image (right) after PALM Processing



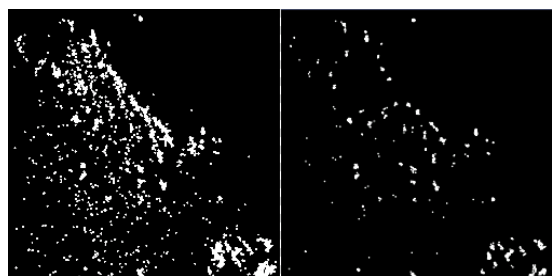
**Fig. 460 Processing – Remove PALM outliers tool selected**



**Fig. 461 Processing – PALM Remove PALM outliers**



**Fig. 462 Processing – PALM Remove Outliers message box**



**Fig. 463 PALM images before (left) and after (left) removal of outliers; Radius set to 3000 and Position Threshold to 100. Only those peaks / molecules in denser structures remain.**

#### 5.4.14.5 PALM – Remove PALM Outliers

The **Remove PALM outliers** function allows removing all molecules that within a defined radius will have less than the specified numbers of neighboring molecules.

Select the **Remove PALM outliers** tab to select the **Remove PALM outliers** processing tool (Fig. 460). Activate the image you want to process in the image container and press the **Select** button to load the image. Then expand the **Method Parameters** tool window to have access to the filter functions (Fig. 461).

You can set two parameters by using the sliders or the spin input boxes:

**Radius [nm].** The radius defines the distance from a localized position of a peak (molecule) in which all peaks falling within that distance are counted.

**Position threshold.** If the number of counted neighboring peaks (molecules) falls short of the set value, the respective peak (molecule) will be removed from the list and the PALM image.

☞ This tool will emphasize densely labeled structures and can help remove floating molecules and ghost signals.

☞ This tool works only for PALM images.

After setting the thresholds, press **Apply** to create the new image. A message will be displayed telling how many molecules have been removed from the input PALM image (Fig. 462).

Press **Ok** to have access to the newly computed image (Fig. 463).

☞ Please note that for 3D-PALM removing outliers applies only in 2D for a maximum intensity projection of the Z-Stack. Removing outliers does not apply for the z direction.



### 5.4.15 Processing – Particle Tracking

Licensing	Instrument
standard <input type="checkbox"/> optional <input checked="" type="checkbox"/>	LSM <input type="checkbox"/> ELYRA <input checked="" type="checkbox"/> Lightsheet Z.1 <input type="checkbox"/>

Tool was exclusively developed for tracking molecules or particles having a dot-like appearance in the image data.

The Processing **Particle Tracking** tool allows the identification of single molecules and follows their movement. Trajectories will be displayed.

In the image you have than the possibility in the **Particle Tracking** tab to calculate the mean square displacement and diffusion coefficients of the single molecules.

Highlight the **Particle Tracking** field to have access to the **Particle Tracking** tool (Fig. 464).



Fig. 464 Processing – Particle Tracking tool selected

Activate the image you want to process in the image container and press the **Select** button to load the image. Then expand the **Method Parameters** tool window to have access to the **Particle Tracking** tools (Fig. 465).

You can set different parameters to define the molecules and the calculation of the trajectories:

- **Peak intensity to noise.** Sets the signal over noise threshold according to  $I-M > SS \times PI$  ( $I$  = intensity of particle;  $M$  = mean intensity of image frame;  $SD$  = standard deviation of image frame;  $PI$  = peak intensity to noise).
- **Cut off.** Sets a filter to suppress molecules that deviate from the ideal Gauss shape, for example if there is a background structure.
- **Feature mask size [pixel].** Determines the mask used to cut out the particle.
- **Link range [frames].** Sets the lower limit in frames over which the particle has to be detected.
- **Displacement [pixel].** Sets the upper limit of distance the particle is allowed to have from one frame to the next.
- **Trajectory Length [pixel].** Sets the lower limit in the trajectory length a particle must have over the observed time period in order to be considered a particle.

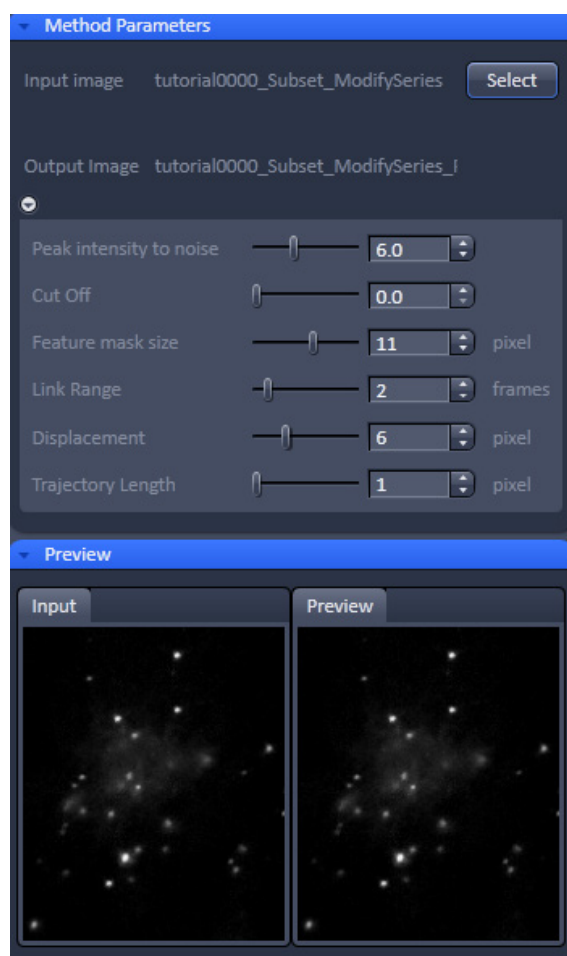
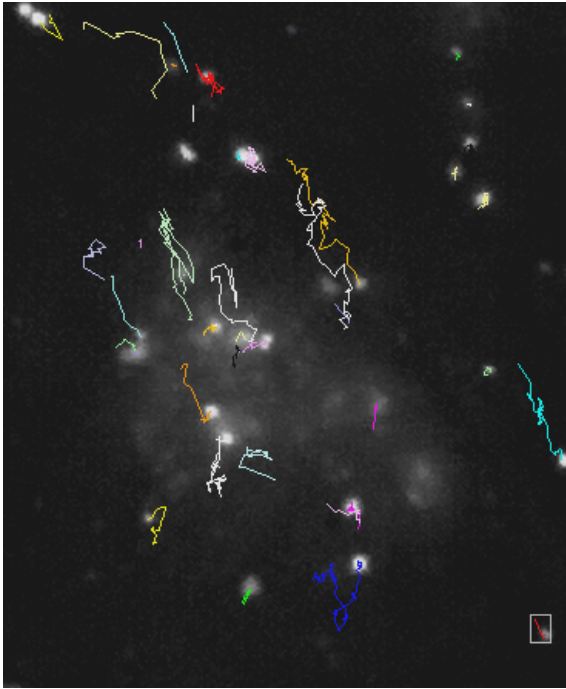



Fig. 465 Processing – Particle Tracking tool field

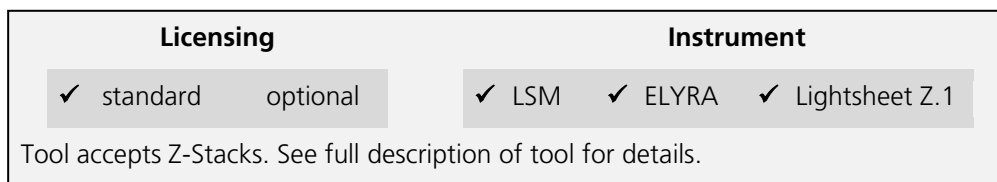


**Fig. 466** Image with trajectories of single molecules. The selected trajectory is boxed

Once the settings are complete press **Apply** to obtain the trajectories of the single molecules (Fig. 466).


 Please note, that Particle Tracking only works for 2D data sets.

**5.4.16 Processing – Experimental PSF**



This function allows determining the point-spread function (PSF) of sub-resolution beads and using this experimentally determined PSF as input for Structured Illumination processing.

Select the **Experimental PSF** tab to select the **Experimental PSF** Processing tool (Fig. 467). Activate the image (a 3D stack of sub resolution beads) you want to process in the image container and press the **Select** button for **Input Image** to load the image. Then expand the **Method Parameters** tool window to have access to setting parameters (Fig. 468).

 You can load a 3D stack of a widefield image or a non-processed raw data SIM image. LSM image formats are not accepted to determine the **Experimental PSF**.

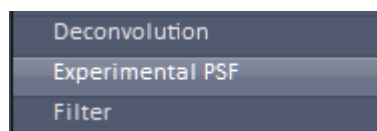
You have the possibility to automatically compute the Experimental PSF by choosing **Automatic** from **Mode** drop down menu (Fig. 469).

If you want to process manually and set quality parameters, select **Manual** (Fig. 470).

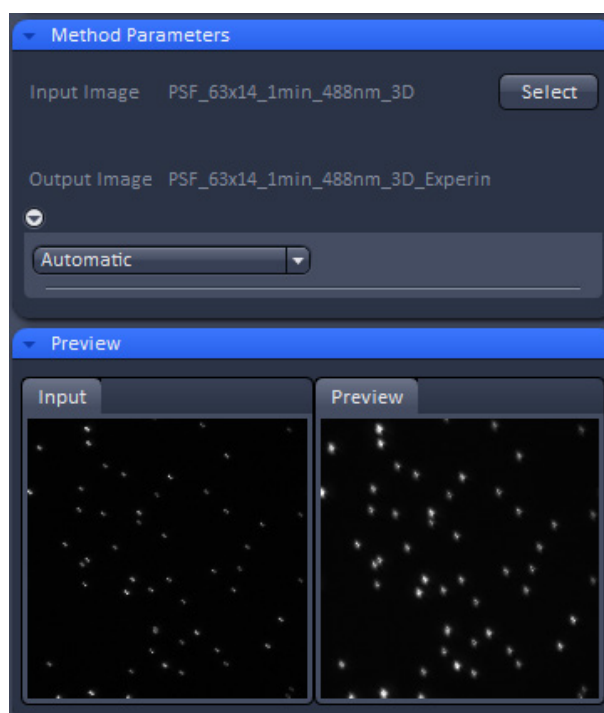
Pressing the **Default** button will load Standard values. Data will only be reused, if the result image is selected. Then pressing the **Reuse** button will load the values of the selected image. The options **Symmetrical** and **Damp Edge** are not included in the Reuse function.

When the **Symmetrical** check box is ticked, a radial symmetrization of the PSF will be performed. That means that a perfectly round PSF is calculated, even out of an oval PSF.

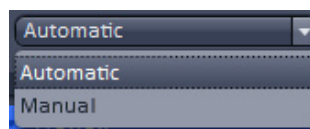
When the **Damp edge** check box is ticked, the edge of the PSF will be smoothed (with a smooth transition to zero at the edge).



**Fig. 467 Processing – Experimental PSF tool**



**Fig. 468 Experimental PSF – automatic mode**



**Fig. 469 Mode drop down menu**

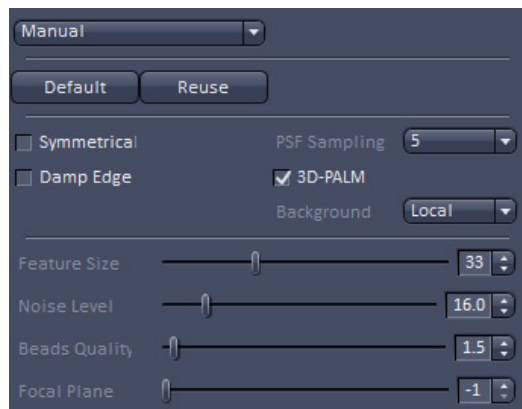


Fig. 470 Experimental PSF – manual mode

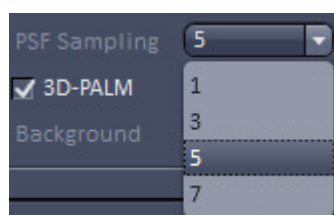


Fig. 471 PSF sampling drop down menu

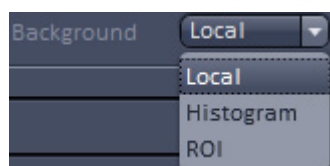


Fig. 472 Background drop down menu

The **PSF sampling** pull down menu allows you to interpolate the result to different degrees. Since the resulting PSF is an average of many PSFs corresponding to the localized beads and every bead is localized with the sub-pixel accuracy, one can obtain after averaging a PSF with higher resolution.

You can average the PSF by **1** (pixel size of the resulting PSF is the same or **1** times as in the original image), **3** (pixel size of the resulting PSF is **3** times smaller as in the original image), **5** (pixel size of the resulting PSF is **5** times smaller as in the original image) or **7** (pixel size of the resulting PSF is **7** times smaller as in the original image) times (Fig. 471).

The **3D PALM** box will be automatically checked, if the image data was acquired with the 3D-PALM slider inserted. In this case the double lobe structure of each bead will be aligned to the right lobe.

In the **Background** drop down menu you can decide the way background is determined (Fig. 472).

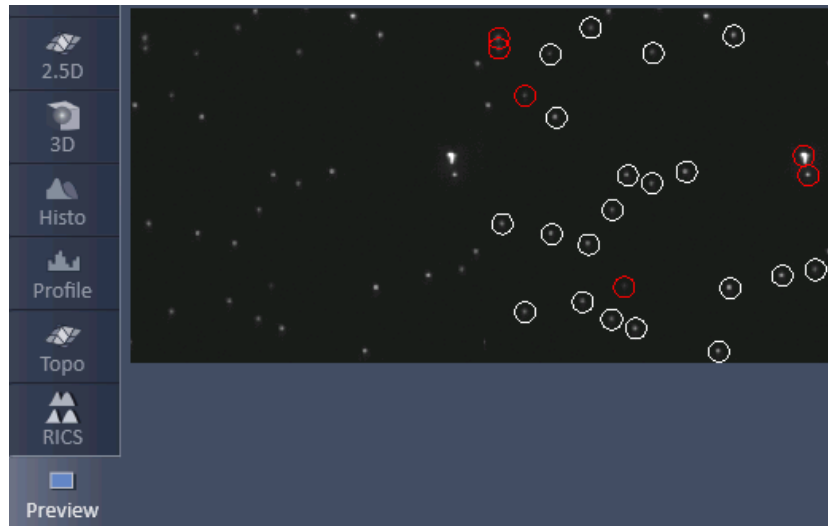
You have three options:

- **Local:** Background is computed from the periphery area of the mask defined in **Peak Mask Size**.
- **Histogramm:** Background is calculated from the histogram as at 10% cut off value.
- **ROI:** Background is computed from ROIs in the image (**drawn** with the Graphics tool). Note, this option is only available if ROIs have been defined in the image.

There are different filters that can be set by corresponding sliders or spin input boxes to select sub-resolution beads.

**Feature size** sets the mask size that is used to cut out the bead and to create the **Experimental PSF**. The extensions are displayed in the **Preview** tab of the image container as circles (Fig. 473).

White circles indicate that the particular PSFs are used (if channel color is grey; otherwise the channel color is used), red circles that the PSF are discarded for the calculation of the Experimental PSF.




**Fig. 473** Selection of beads in Preview tab

**Noise Level** sets the threshold of the intensity of the sub-resolution beads over background according to  $I - M > SD \times NL$  ( $I$  = intensity of bead;  $M$  = mean intensity of image frame;  $SD$  = standard deviation of image frame;  $NL$  = noise level). Lowest number means that everything (even noise) is taken into account; highest number means only the brightest beads will be used.

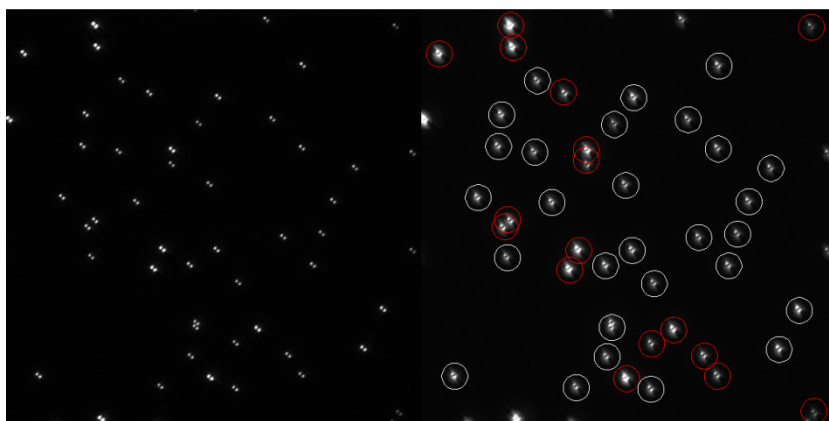
**Beads quality** evaluates two characteristics, the intensity (first moment) and the size (second moment). These two moments are calculated for every localized bead. Then the beads are sorted according to these characteristics, resulting in two sorted lists of beads. The beads that are closer to the medians in both orderings are assumed to have higher quality. The **Beads quality** defines how far the beads characteristics (intensity and size) may be away from the median value. The smaller the threshold, the closer beads should be to the median. Beads quality equals to 0 is likely to result in a single bead right in the middle. In this way also the bead shape (aspect ratio) is assessed. Lower input number means that only perfectly shaped round beads will be taken into account. Highest input numbers will take into account all beads, even ellipsoid shaped ones.

**Focal Plane** determines which plane is the focal plane. The default is **-1** (automatic). Here the system determines the focal plane automatically. The user can also select a frame, which is presumably the focal plane, by input the number of the frame within the stack.

All sub-resolution beads that will be taken into account will be circled by a white line. Those that do overlap with their circles or are considered unsuitable (beads beyond the quality thresholds) are outlined in red and will not be taken into account (Fig. 473).

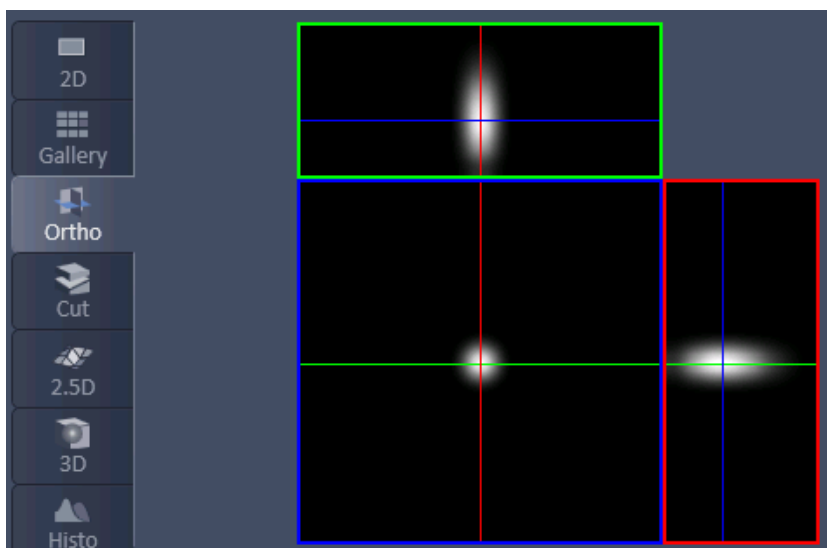
 Please note that you should use a 4  $\mu\text{m}$  stack of 100 nm beads, if you want to use the Experimental PSF for 3D PALM.

Once settings have been completed the **Preview** window displays beads that are not taken into account as red circles and those that are used in white circles (if channel color is grey) or in their channel color (if channel color is other than grey) (Fig. 474). Press apply to compute the Experimental PSF. The created file will have the extension "... .ExperimentalPSF. ...".



**Fig. 474** Preview window for bead selection using 3D PALM

Best results for an Experimental PSF for 3D data will be obtained, if beads are seeded sparsely, for example 10 - 20 beads evenly distributed in a 512 x 512 image.



**Fig. 475** Experimental PSF in Ortho view

If **Apply** is pressed an average PSF from all the beads taken into account will be computed (Fig. 475). For each channel a separate PSF will be displayed. The **Experimental PSF** can be saved (format .czi) and used for the **Structured Illumination - Structured Illumination** Processing tool in place of the **Theoretical PSF**. The size and pixel size of the **Experimental PSF** are recalculated and the PSF is interpolated to match the processed image.

**5.4.17 Processing – Structured Illumination**

Licensing	Instrument
standard ✓ optional	LSM ✓ ELYRA Lightsheet Z.1
<p>Tool accepts data recorded in SIM mode on ELYRA. In data sets containing other types of image data as well ("mixed mode" files), this tool selectively processes the SIM data. "Experimental PSF" (requires Z-stacks of point-like objects) and "Fourier Transform" accepts input other than SIM data as well. See full description of tool set for details.</p>	

The **Processing Structured Illumination** tool works exclusively for data acquired in the **SIM imaging** mode. It subdivides in 4 subcategories (

Fig. 479):

- **Fourier transform:** Calculates the spatial frequencies and displays them in an image. No phase information will be available.
- **Modulation contrast:** Determines the modulation contrast from an image with beads to serve as a diagnostic tool.
- **Structured Illumination:** calculates the high resolution image from the set of structured images
- **TIRF filtered:** Will apply the TIRF sectioning to the SIM image if the TIRF was added as the last frame.

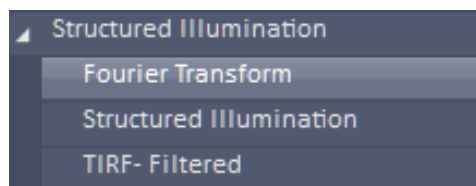


Fig. 476 Structured illumination – Fourier Transform tool selected

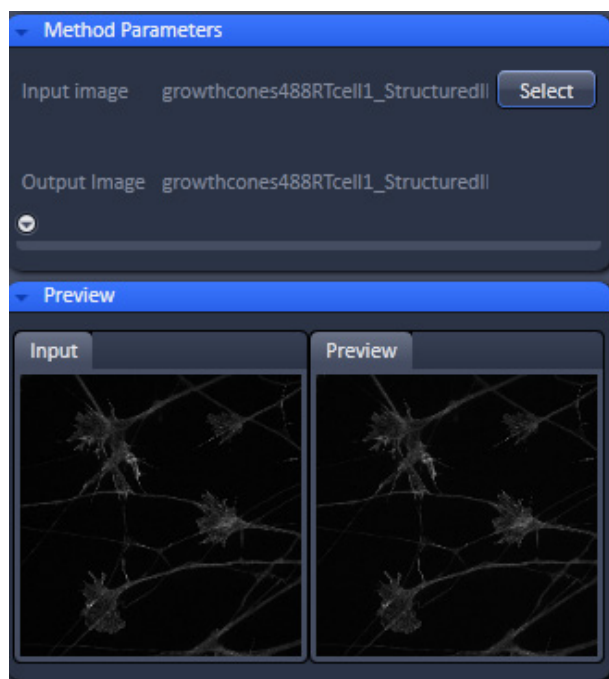


Fig. 477 Structured Illumination – Fourier Transform tool

#### 5.4.17.1 Structured Illumination – Fourier Transform

The **Fourier Transform** tool computes and displays the Fourier transform of the image (frequency space).

Note that the Fourier image will contain the information on the spatial frequencies, but does not contain phase information.

Select the **Fourier Transform** tab to select the **Fourier Transform** Processing tool (Fig. 476). Activate the image you want to analyze in the image container and press the **Select** button for **Input image** to load the image. Then expand the **Method Parameters** tool window to have access to setting parameters (Fig. 477).

If the **Log FT** check box is inactive, the result is the absolute value of the Fourier transform [ $\sqrt{\text{Real} \times \text{Real} + \text{Imag} \times \text{Imag}}$ ] with Real and Imag being the real and imaginary part of the Fourier transform. If **Log FT** is ticked, the result is the log-transform of the shifted absolute values [ $\log(1 + \text{Real} \times \text{Real} + \text{Imag} \times \text{Imag})$ ]. Log-transformation squeezes the dynamic range of the Fourier-transformed image, so that weaker intensities may become better visible.

Press **Apply** to compute the Fourier transforms of all image channels (Fig. 478).

The Fourier images can be used to assess the quality of the SIM calculations and retrieve the resolution enhancement.

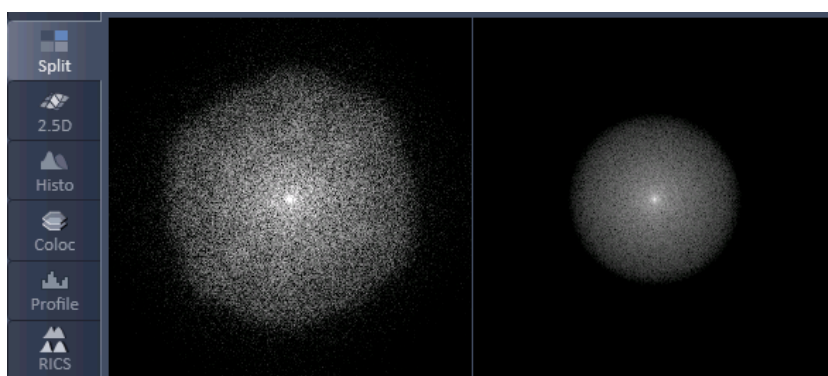


Fig. 478 Fourier transform images of SR (left) and WF (right) image in the Split view




### 5.4.17.2 Structured Illumination – Structured Illumination

The **Structured Illumination** function allows automatic or manual processing of a set of structured images obtained by phase shift and rotation of the grid.

Select the **Structured Illumination** tab to select the **Structured Illumination** Processing tool (

Fig. 479). Activate the image you want to process in the image container and press the **Select** button to load the image. Then expand the **Method Parameters** tool window to have access to setting parameters (Fig. 480).

 You have to use the subdirectory **Structured Illumination** tab when selecting the image to have access to the **Structured Illumination** tools. You will have no tools available if the directory **Structured Illumination** tab is selected.

If a region of interest (**ROI**) is defined in the image, then this **ROI** will be exclusively taken for image processing and the rest of the image will not be processed.

You can instead of processing only one selected image also load more images to be processed sequentially. To this end press the **Run Batch** button (Fig. 480). This will open **Windows** Explorer from which you can select all images you want to process. All selected files will be displayed in the **Batch display** window, which will appear when the files are opened by Windows explorer. The **Batch display** window also shows the current state of batch processing.



Fig. 479 Processing – Structured illumination tool selected

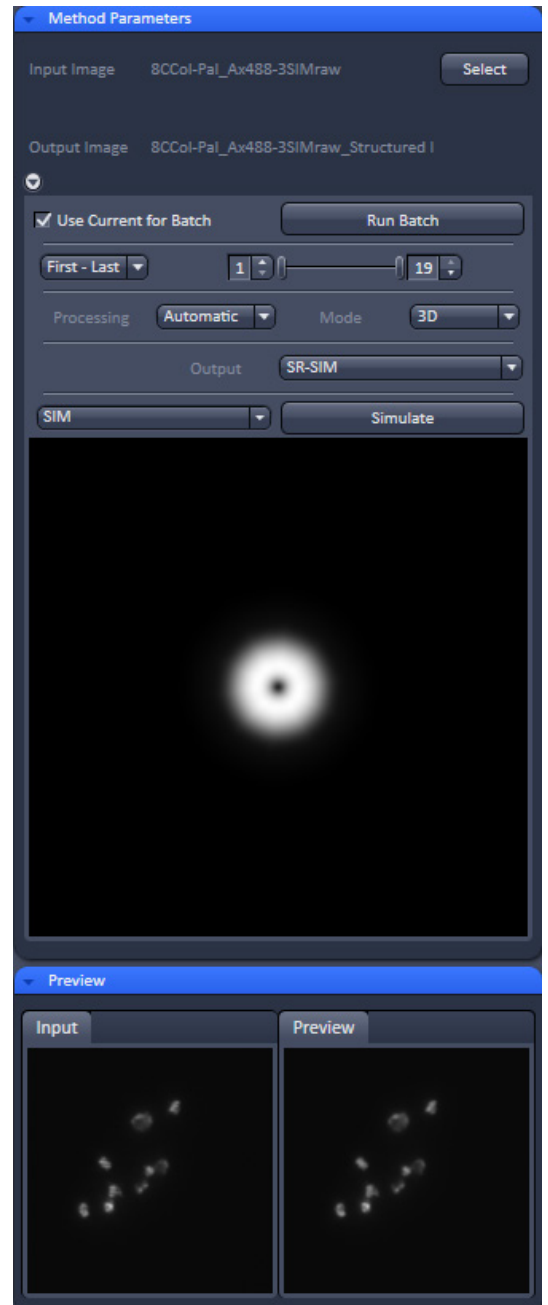
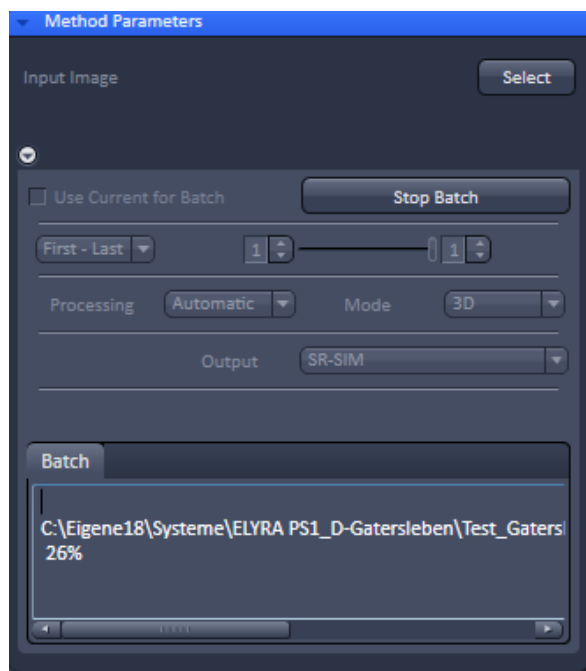


Fig. 480 Structured Illumination – Structured Illumination



**Fig. 481** Structured Illumination – Batch processing



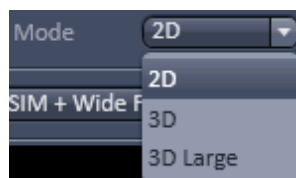
**Fig. 482** Stack processing mode drop down box



**Fig. 483** Setting of the first and last frame of a stack to be processed



**Fig. 484** Selection of one frame from a stack be processed



**Fig. 485** Mode drop down box

The **Run Batch** button will turn into a **Stop Batch** button (Fig. 481) once pressed. If the button is pressed, batch processing will be stopped, no matter if **Apply** was pressed or not and the button turns back to **Run Batch**.

☞ In batch processing all images can only be processed with one parameter setting. If images, however, have been processed already once and are linked to processing parameters by pressing the **Attach** button, those settings will be taken and the general setting overruled. If you want to overrule attached settings and fit all Batch files with the set and displayed parameters, you have to check the **Use current for Batch** box.

If a Z-Stack was acquired you have the option to tell the system how the frames of the stack should be processed from the **Stack processing mode** drop down box (Fig. 482).

You have the option between **First-Last** and **Single**.

When **First-Last** is selected the double-slider or the left and right spin input boxes can be used to define the first and last frame of the stack that should be processed (Fig. 483).

When **Single** is selected, the slider or spin input box can be used to define one frame in the stack that should be processed (Fig. 484).

With the **Mode** drop down menu you have the option to select, how the single frames of a stack are processed (Fig. 485). You have the option between **2D**, **3D** and **3D large**.

☞ Note that **3D** and **3D large** are only available, when the image to be processed contains a stack of >1 and **First-Last** was selected as the **Stack processing mode**. Otherwise, the Mode drop down menu shows only **2D** and is greyed.

When **2D** is selected, every frame is reconstructed with the information of that frame only and the structuring in the thirds dimension is not used.

If **3D** is selected, the information of the neighboring frames in regard to structuring information and out of focus contribution will be used in addition to the information of the frame itself. This will result in better x, y and z resolution and better contrast by removing the out of focus light to a greater extent at the cost of more computational power requirement.

If the stack is large, available memory might be limited. In this case a **Warning** is issued, recommending the usage of the **3D large** mode (Fig. 486). In this case, the stack is subdivided into individual smaller stacks, which are individually processed. The result images of the individual stacks are then automatically combined into one output image.



Fig. 486 Warning for memory shortage

If one selects a region of interest (**ROI**) in the image, than that **ROI** will be used for image processing. This also can help in reducing memory problems when processing huge stacks.

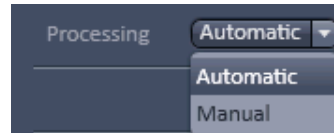



Fig. 487 Processing drop down box

In the **Processing** drop down menu one can select between **Automatic** and **Manual** processing (Fig. 487). If **Automatic** is selected, pre-set filter and parameter values will be used.

If **Manual** is selected these filters and parameters become accessible to be changed and the **Manual selection** field becomes accessible (Fig. 488).

 The **Automatic** mode is recommended for images with high modulation contrast. In case the modulation contrast is low one might benefit from changing the pre-set values.

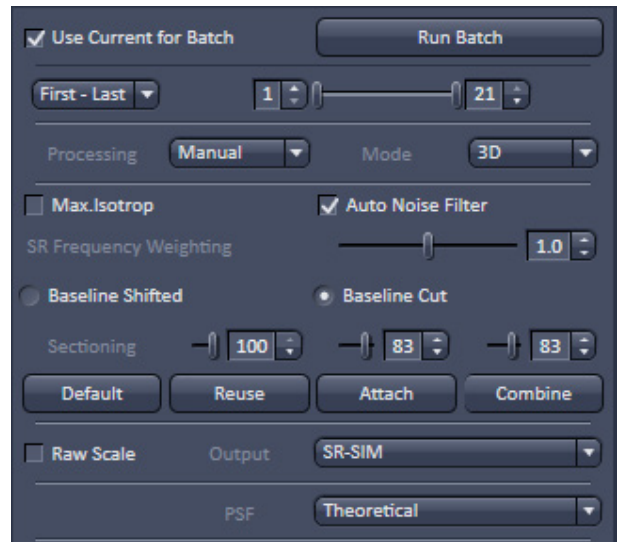


Fig. 488 The Manual selection field

In the **Channel** drop down menu (Fig. 489) **All** or single channels can be selected from a multi-channel image that should be processed. The **Channel** drop down menu is not displayed if the loaded image has only one channel.

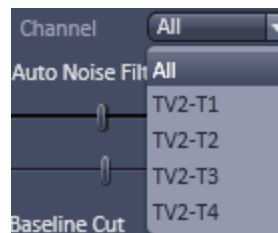
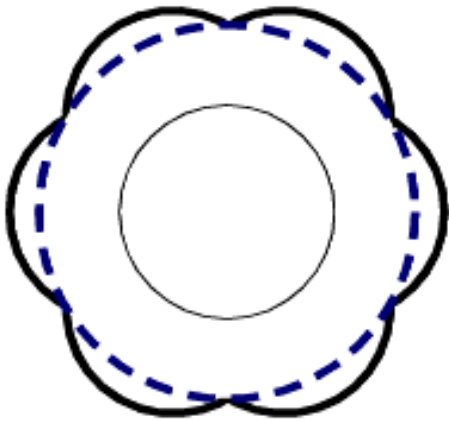
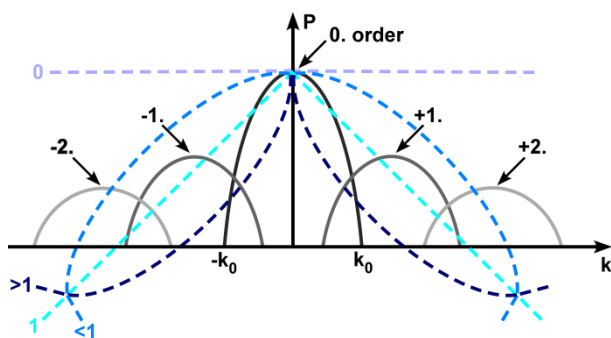


Fig. 489 Channel drop down box

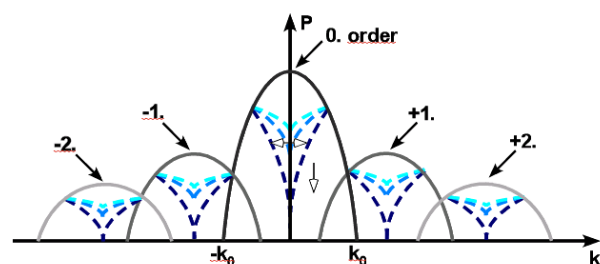
Due to the limited number of rotations more frequencies and hence higher resolution information can be obtained exactly at the rotation angles. The directions between the rotational angles contain lesser frequencies. All available frequency information will be used if the **Max.Isotrop** checkbox is not ticked. This gives rise to the flower like appearance of the Fourier transform, which extends wider at the rotational angles.



**Fig. 490** Fourier transform with **Max.Isotrop** disabled (strong solid line) and enabled (blue stippled line). The inner circle (light solid line) is the Fourier transform of the non-structured image



**Fig. 491** Sketch of the influence of SR Frequency weighting filter (blue stippled lines) on the spatial frequencies



**Fig. 492** Influence of sectioning filter (blue stippled lines) on the spatial frequencies. The open arrow indicates increasing strength, the double arrow the variance, which is pre-defined

If the **Max.Isotrop** checkbox is ticked, the software will compute the high resolution image with the same resolution in every direction that is it does not use the highest frequencies in the rotational directions and the Fourier transform will be circle like (Fig. 490).

If the **Auto Noise Filter** checkbox is not ticked, the **Noise Filter** slider is available, that can be used to set the noise filter for the so called Wiener de-convolution performed. The negative number indicates the power to 10 for the filter. The smaller the values (towards -11), higher frequencies are allowed leading to noisier and crispier images. If the **Auto Noise Filter** is ticked, the **Noise Filter** slider is not displayed.

The **SR Frequency weighing** filter (also known as HD goal filter) will affect more prominently the higher frequencies. You can set the value by using the slider or the spin input box. The filter is a kind of cone that multiplies the Fourier transform of the resulting image. Weighting changes the slopes of the cone from the convex (towards 0) to concave (towards 2) (Fig. 491). 0 is no filtering, 1 is a straight line, <1 is convex, >1 concave.

You can toggle between **Baseline Shifted** and **Baseline Cut**. In **Baseline Shifted** negative values that can arise as an artifact by the **Noise** or Wiener filter will be kept and an offset is added to the whole image, so that the minimal (negative) intensity becomes zero intensity (baseline shifted). In **Baseline Cut** negative values will be clipped by setting them to zero. No offset is applied.

The **Sectioning** (or Strength) filter removes the 0-frequencies for the 0<sup>th</sup> order with a pre-defined variance. It also removes the 0-frequencies from the non-shifted 1<sup>st</sup> (+1, -1) and 2<sup>nd</sup> (+2, -2) orders. Therefore bumps and deeps might be occasionally detected in the Fourier transformed image at the positions defined to the rotation angle and grating frequency. The higher the value, the more stringent the filtering will be and more of the lower frequencies will be removed (Fig. 492). Three filter sliders and spin input boxes for the 0 order, the 1<sup>st</sup> orders and the 2<sup>nd</sup> orders are available (from left to right) for input.

All parameters will influence the Optical Transfer Function (OTF) used for reconstruction. The shape of the OTF in x, y is displayed in the **OTF display** window below the **Manual selection** field.

The **Preview** tab shows the **Input** image and a **Preview** of the output image.

By pressing **Default** the current parameter values will be stored as default values. By pressing **Reuse** the last stored default values will be loaded.

Pressing **Attach** allows parameter values to be attached to an image. In normal case if any of the SIM parameters will be changed, they will be applied accordingly for the processing, but may not be saved into the image. Then if the image is saved, the values of the parameters applied for the image will be lost. If you attach the corresponding tag to the image by pressing the **Attach** button parameter values used to process the image will be attached to the image, even if it is not explicitly saved again. They will then be available for further processing, in particular for Batch processing.


In the **Output** drop down menu you can set, what kind of channels you want to display (Fig. 493). You have the option to display

- **SR-SIM + DCV + Widefield**
- **SR-SIM + DCV**
- **SR-SIM + Wide Field**
- **SR-SIM.**

Highlight the option you want to display. Channel designations are as follows: **SR** for SR-SIM, **WF** for Widefield and **D** for Deconvolution (DCV).

If the **Raw Scale** box is unchecked, output images will be normalized to the maximum dynamic range. Please note that in this case quantitative information is lost, however, images are displayed with best brightness and contrast. If you want to keep the original scaling for quantitative studies, you have to check the **Raw scale** box. In this case the original dynamic range is kept.

You can select between theoretically computed or experimentally determined PSF by choosing **Theoretical** or **Experimental** in the **PSF** drop down menu (Fig. 494). In case **Experimental** is selected, the **PSF File** button becomes available (Fig. 495). Pressing the button will open Windows Explorer, which allows you to select any pre-saved Experimental PSF. The file name of the loaded file is displayed in the **PSF File** display window.

 Note, if the number of the Experimental PSF channels is less than the number of the WF or SIM channels, the theoretical PSF will be used for the missing channels and a warning is generated. The program also checks the match of the excitation wavelengths between the PSF and WF / SIM channels. In case of mismatching, it generates a warning, but the experimental PSF will still be used.

By pressing **Apply** the high resolution image will be computed with the current parameter values (Fig. 496).

If a value is changed you have the possibility to press **Combine**. Then a new calculation is only done for the changed parameter and combined with the previous calculations on the unchanged parameters, which will save dramatically computational time. If **Apply** is pressed, calculations will be done on all parameters regardless of being changed or unchanged.

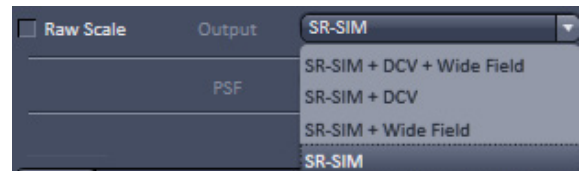


Fig. 493 Output drop down menu

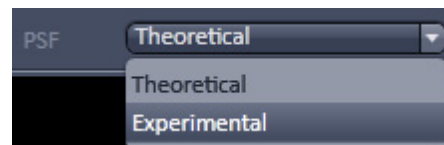


Fig. 494 PSF drop down menu

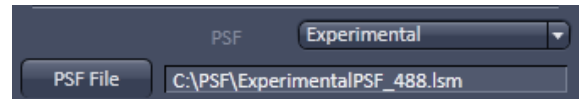


Fig. 495 PSF selection menu

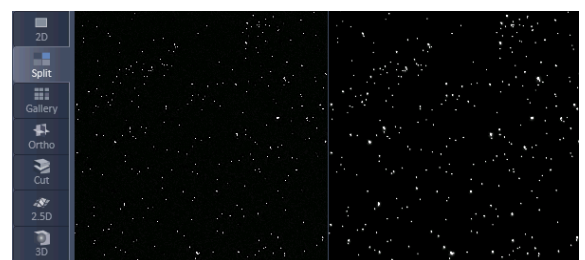
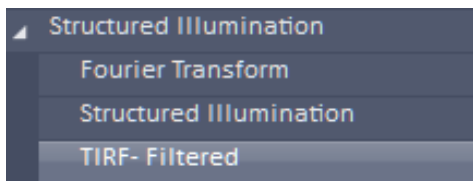
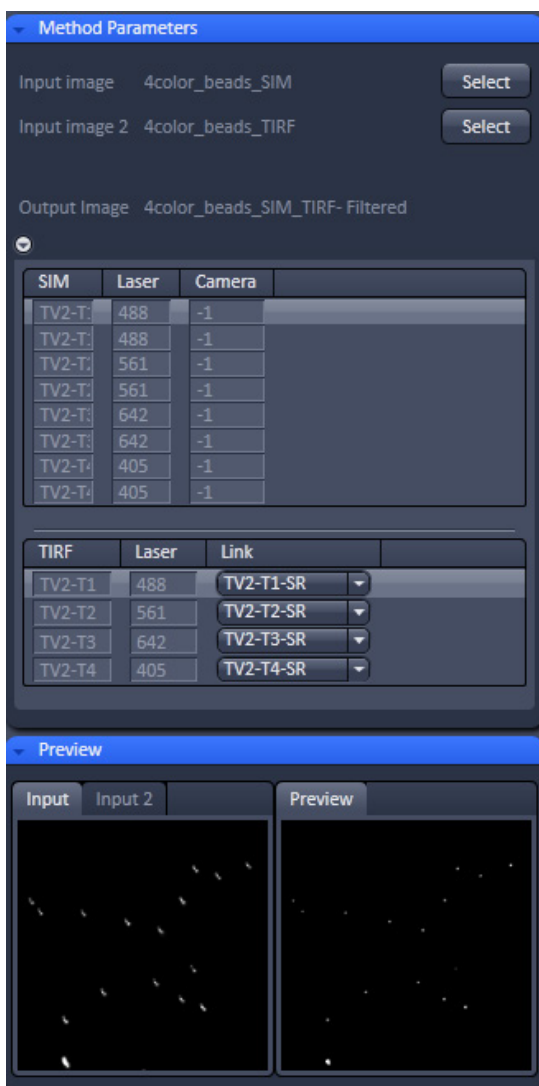


Fig. 496 SIM image (left) and widefield image (right) in the Split mode after SIM processing



**Fig. 497** Structured illumination – TIRF- Filtered tool selected



**Fig. 498** Structured Illumination – TIRF- Filtered tool

### 5.4.17.3 Structured Illumination – TIRF- Filtered

This function works for SIM images (stack) in combination with a TIRF image. The lowest frame (first frame) of the stack, preferentially one taken close to the coverslip, will be taken and combined with the TIRF. The SIM image contributes the x,y enhancement, the TIRF image the z-resolution of the TIRF.

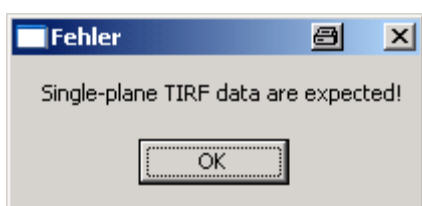
Select the **TIRF-Filtered** tab to select the **TIRF-Filtered** Processing tool (Fig. 497). Activate the SIM image you want to process in the image container and press the **Select** button for **Input image** to load the SIM image. Activate the TIRF image you want to use as the reference in the image container and press the **Select** button for **Input image 2**. Then expand the **Methods Parameters** tool window to have access to setting parameters (Fig. 498).

You can toggle between Input image 1 and 2 in the **Preview** tab window, which also displays a preview of the output image.

The **Image input** description field lists all the channels in the **SIM** column, the used lasers of a channel in the **Laser** column and the employed camera coded by a number in the **Camera** column.

The **Image input 2** description field lists all the channels in the **TIRF** column and the used laser of a channel in the **Laser** column.

It is important to load the SIM image as **Input image** and the TIRF image as **Input image 2** as the software expects it that way. If in **Input image 2** an image stack is selected, the system gives an error message as it expects a single plane (Fig. 499).

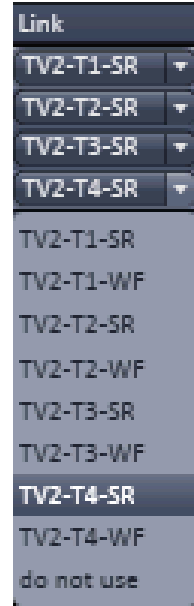


**Fig. 499** Error message for falsely loaded image dimensions in Input image 2

The **Link** drop down menu available for each channel displays all channels of the SIM **Input Image** (Fig. 500).

You can now link the TIRF channel to one of the SIM channels by highlighting the latter. Then the respective TIRF channel will be used to compute its z-resolution into the linked SIM channel.

When **Apply** is pressed, the new SIM image with the improved z-resolution in the lowest frame will be computed.

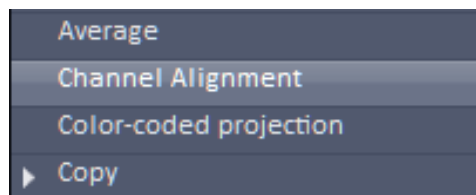


**Fig. 500** Link drop down menu

**5.4.18 Processing – Channel Alignment**

Licensing		Instrument		
✓ standard	optional	✓ LSM	✓ ELYRA	✓ Lightsheet Z.1

Tool accepts multi-color image data (including multi-dimensional data sets). See full description of tool set for details.



**Fig. 501 Processing – Channel Alignment tool selected**

The Processing **Channel Alignment** tool allows for correction of lateral drift and chromatic aberration between different channels of an image or between images.

Highlight the **Channel Alignment** field to have access to the alignment tools (Fig. 501).


Activate the first image you want to process in the image container and press the **Select** button for **Input image** to load the image.

If you want to load a second input, highlight it in the image container and press the **Select** button for **Input Image 2**.

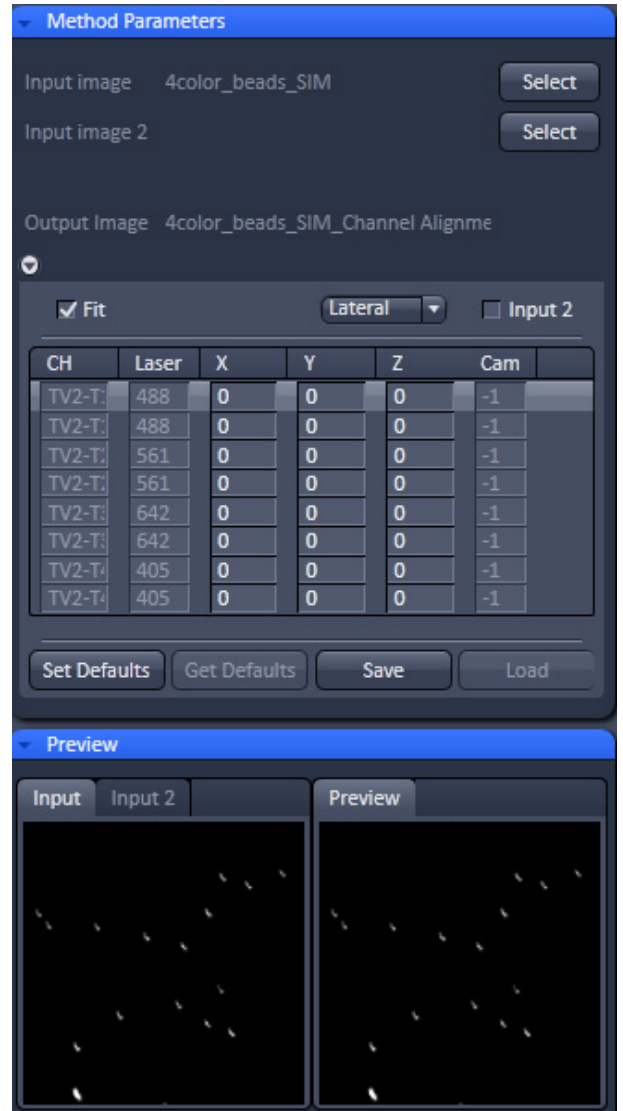
You can toggle between the two input images in the **Preview** tab display field. Then expand the **Method Parameters** tool window to have access to the **Channel Alignment** tools (Fig. 502).



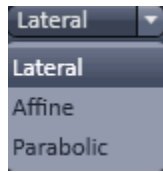
If the **Fit** check box is ticked and the **Input 2** checkbox inactive, than the software will align all channels of **Input image** having the same format to the first listed channel of the same format.

 Care should be taken about what channels will be aligned and in which order they appear. For SIM images the super resolution (**SR**) and the widefield (**WF**) channels are listed alternatively (pair wise). Since all channels are of the same format each channel (**SR** and **WF**) would be aligned to the first **SR** channel, since **SR** channels are normally listed before their corresponding **WF** channel. If this should be avoided, subsets of images containing only **SR** or **WF** channels have to be created in the Processing Tool **Copy Subset** and independently aligned. The situation is different for PALM images. The high resolution (**HR**) and sum widefield (**SWF**) channels are also listed alternatively, with the **HR** channels preceding their corresponding **SWF** channels, however, the format of the **HR** channels is different to the one of the **SWF** channels. In this case the software aligns all **HR** channels to the first listed **HR** channel, which will be the first displayed channel, and all **SWF** channels independently to the first listed **SWF** channel, which is second in the list.

With the **Fit** check box ticked, the **coefficient table** lists as the first column the Channel name **Ch** and as the last two columns the used **Laser** line and camera channel **Cam**. In between are listed the corresponding correction coefficients. You have the choice from the **Alignment mode** drop down menu between **Lateral**, **Affine** and **Parabolic** alignment.



**Fig. 502** Processing Channel Alignment tool field with one input image (with SIM and paired WF channels) selected



**Fig. 503** Alignment mode drop down menu for selected PALM image

CH	Laser	X	Y	Z	Cam
TV2-T1-SR	488	0	0	0	-1
TV2-T1-WF	488	-0.023	-0.009	-0.099	-1
TV2-T2-SR	561	-0.423	0.450	0.005	-1
TV2-T2-WF	561	-0.576	0.305	-0.087	-1
TV2-T3-SR	642	-1.234	-4.614	-0.080	-1
TV2-T3-WF	642	-1.859	-4.767	-0.087	-1
TV2-T4-SR	405	4.489	4.177	-4.432	-1
TV2-T4-WF	405	4.459	4.305	-4.246	-1

**Fig. 504** Correction table in the Lateral alignment mode

CH	Laser	X	Y	RX	RY	SX	SY	Z	Cam
TV2-T1-SR	488	0	0	0	0	0	0	0	-1
TV2-T1-WF	488	0.059	0.095	-0.000	0.000	0.000	-0.000	-0.098	-1
TV2-T2-SR	561	-0.234	1.130	4.082	-0.000	-0.001	-0.002	0.002	-1
TV2-T2-WF	561	-0.196	0.980	-0.000	0.000	-0.000	-0.002	-0.087	-1
TV2-T3-SR	642	-0.574	-3.535	-0.000	-0.000	-0.002	-0.003	-0.080	-1
TV2-T3-WF	642	-1.297	-3.311	-0.000	0.000	-0.002	-0.005	-0.089	-1
TV2-T4-SR	405	4.489	4.177	0	0	0	0	-4.432	-1
TV2-T4-WF	405	4.459	4.305	0	0	0	0	-4.246	-1

**Fig. 505** Coefficient table in the Affine alignment mode

CH	Laser	X	Y	X1	Y1	X2	Y2	Z	Cam
HR 1	0	0	0	0	0	0	0	0	-1
SWF 1	0	0	0	0	0	0	0	0	-1
HR 2	0	193.0	175.7	-1.506	-3.874	1.477	1.040	0	-1
SWF 2	0	0	0	0	0	0	0	0	-1


**Fig. 506** Coefficient table in the Parabolic alignment mode


**Lateral** (Fig. 503) is used to correct for linear lateral and axial drifts, that is in all directions. Linear alignments are performed in the x, y and z direction, when the **Applied** button is pressed. The respective offsets (coefficients) are displayed in the coefficient table in the **X, Y** and **Z** columns, respectively (Fig. 504).

For **SIM, WF** and **SWF** images, the software will use significant structures for performing the alignment. You can set a ROI and then the structure within the ROI is used. For **HR** (PALM) images at least one fiducial is expected. Without a fiducial, no alignment will be performed in this case.

**Affine** is used to correct for linear lateral (**X, Y**) and axial (**Z**) drifts, rotational offsets in the image plane in x and y (**RX, RY**) as well as a 1<sup>st</sup> order stretching in the image plane in x and y (**SX, SY**). The respective offsets (coefficients) are displayed in the **coefficient table** in the corresponding columns (Fig. 505). The scrollbar can be used to have access to all columns. For **SIM, WF** and **SWF** images, the software will use significant structures for performing the alignment. You can set a ROI and then the structure within the ROI is used. For **HR** (PALM) images at least three fiducials are expected. Without fiducials, no alignment will be performed in this case.

**Parabolic** is used to correct for linear lateral (**X, Y**) and axial (**Z**) drifts as well as chromatic aberrations, where a 2<sup>nd</sup> order stretching in the image plane in x (**X1, X2**) and y (**Y1, Y2**) is performed. The respective offsets (coefficients) are displayed in the **coefficient table** in the corresponding columns (Fig. 506). The scrollbar can be used to have access to all columns. **Parabolic** only works with **HR** (PALM) images and is displayed only in the **Alignment mode** drop down menu, when a **HR** (PALM) image is selected as the **Input image**.

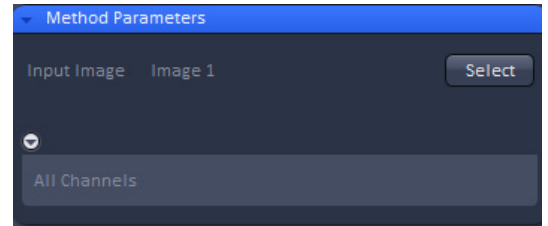
 The calculated coefficients in the **coefficient table** can be edited by hand. The correction will be exactly performed when pressing **Apply** according to the coefficients in the **coefficient table**.

 If the **Save** button is pressed, the **coefficient table** (with the coefficients) will be saved in a .bin file. These .bin file can be reloaded by pressing the **Load** button via the **Windows Explorer**. The **Load** button becomes only active when the **Fit** check box is not active.

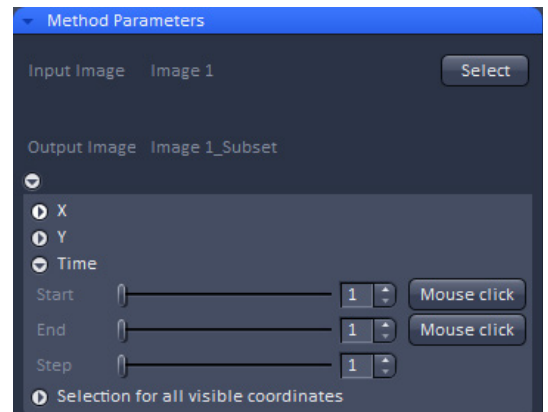
### Using the channel alignment tool for drift corection

The following procedure can be used to remove lateral drift in an image:

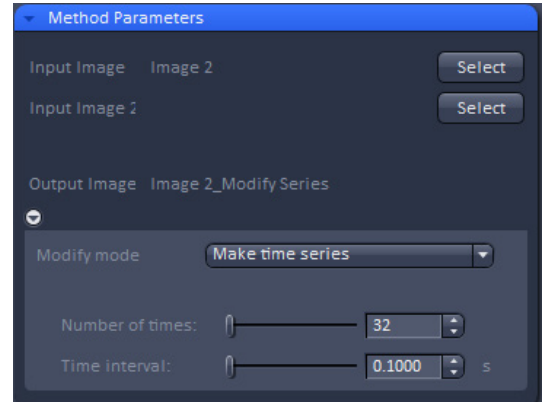
- Duplicate the time series. Select the time series in the processing tool **Copy** under the submenu **Duplication** (Fig. 507). Press **Apply** to obtain a copy from your time series.
- Generate reference image. Using the Processing tool **Copy** select the duplicate time series in the submenu **Subset**. Using **Time** select your reference image, for example the first image or the center image, by choosing for the **Start** and **End** value the same number (Fig. 508). Press **Apply** to extract that image from the time series.
- Generate reference time series. In the Proceesing tool **Modify** choose under **Modify mode** the entry **Make time series**. Select the exctracted image. Enter under **Number of times** and **Time intervals** the numbers from your original time series (Fig. 509) and press **Apply**. The result will be a time series with the same image at each time point.



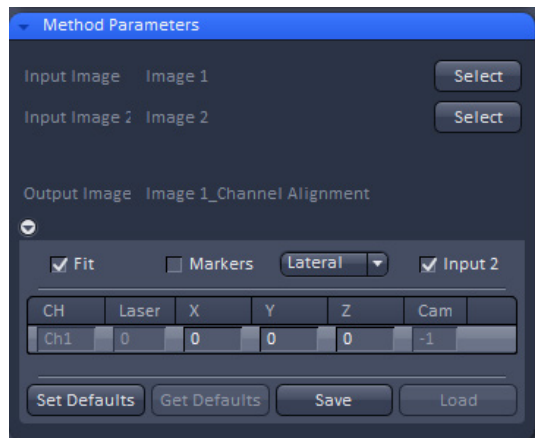
**Fig. 507** Methods Parameter of the Copy Duplicat Processing tool



**Fig. 508** Methods Parameter of the Copy Subset Processing tool

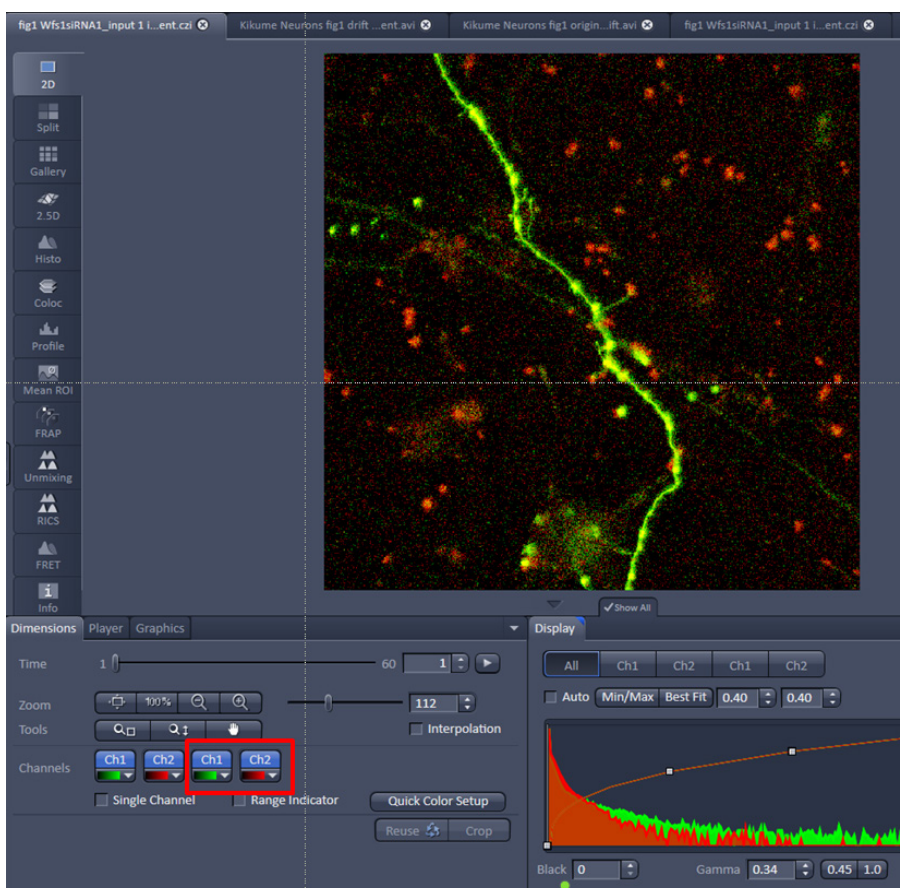


**Fig. 509** Methods Parameter with Make time series selected in Modify mode




**Fig. 510** Methods Parameter of the Channel Alignment Processing tool

- Apply drift correction. In the **Channel alignment** Processing function select the reference time series as **input 1** and the original time series as **input 2**. Check the **Fit** box and the **Input 2** box and leave **Marker** box unchecked (Fig. 510). Select **lateral** from the **correction mode selection** drop down menu. Press **Apply**. The resulting image will have a doubling in channels. The first half represents the original data set, the second half the drift corrected data set (Fig. 511). The number of channels depend on the number of channels of the original time series.
- Extract drift corrected channels. In the Processing tool **Copy** choose **Subset**. Select image with original and drift corrected channels. Select under **Channels** the second half of channels. Press **Apply** to obtain the final drift corrected image (without the original non-corrected channels).





**Fig. 511** The boxed channels represent the drift corrected ones.

 When the **Save Default** button is pressed, the present coefficients will be stored and can be recalled by pressing the **Restore default** button, which becomes active once the **Save default** button was pressed once.

If the **Input 2** check box remains inactive, the image selected for **Input image 2** is not considered for alignment. If the **Input 2** check box is ticked, then the channels of **Input image 2** are aligned to the corresponding channels of the **Input image** that is to those channels at corresponding positions in the list.

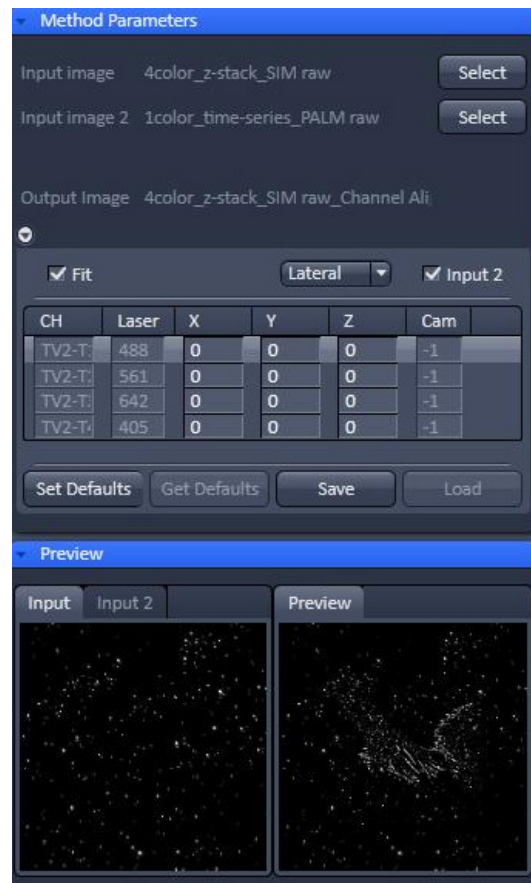
It is the responsibility of the user to align only images of the same dimensions and channels of the same format. If images will have different dimensions, for example a raw SIM Z-Stack and a raw PALM time the system will give no warning message telling the user that the images do not match (Fig. 512). It will load both images and aligns the channels according to their position as long as there are matching channels.

 If no **Input image** was selected and only an **Input image 2**, no alignment will be performed.

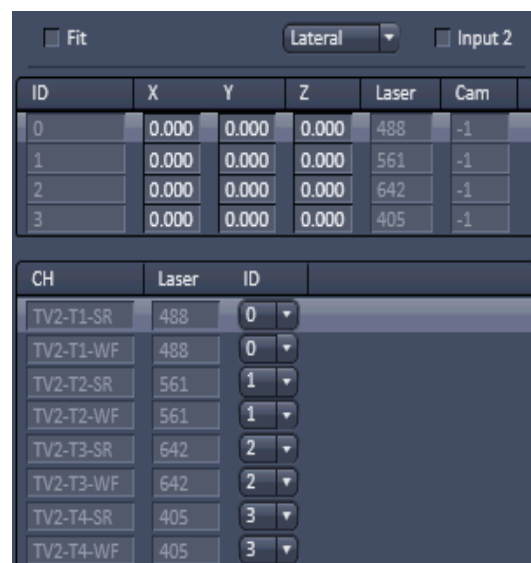
 Loaded images cannot be unloaded but replaced by other images in selecting the respective image in the image container and then pressing the **Select** button for **Input image** or **Input image 2**.

If the **Fit check** box is not ticked a second table, the **assignment table** will be displayed below the **coefficient table** (Fig. 513). In this case the selected image will not be fitted directly, but a loaded alignment will be performed on the image. Columns in the **coefficient** and **assignment** tables can be expanded by dragging the borders of the columns.

The **coefficient table** in this case has to be loaded from a .bin file by pressing the **Load** button or is still available from a previous alignment or obtained by pressing the **Restore Default** button, if values have been previously restored by pressing the **Save default** button. In any case, the listed coefficients (no matter what **Alignment mode** is associated) will be applied to the selected image. If the **Input 2** check box is inactive, this will be the image selected for **Input image**. If the **Input 2** check box will be ticked, it will be the image selected for **Input image 2**.

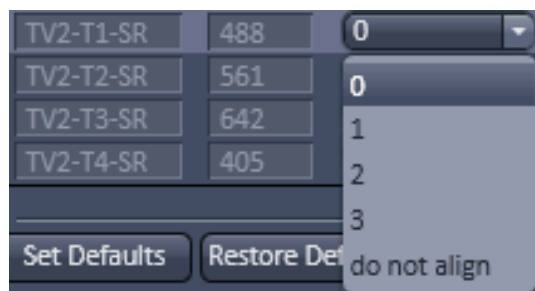


**Fig. 512** Two images mismatched in their dimensions (Z-Stack SIM raw and time-series PALM) images loaded



**Fig. 513** Coefficient table and assignment table

In either case, the other loaded image does not play a role. In the **coefficient table** the channel (**Ch**) assignment column is replaced by an identity (**Id**) column that numbers the channels in their ascending order starting with 0.




**Fig. 514** ID drop down menu

The assignment table represents the selected image, either **Input image** (**Input 2** check box inactive) or **Input image 2** (**Input 2** check box ticked).

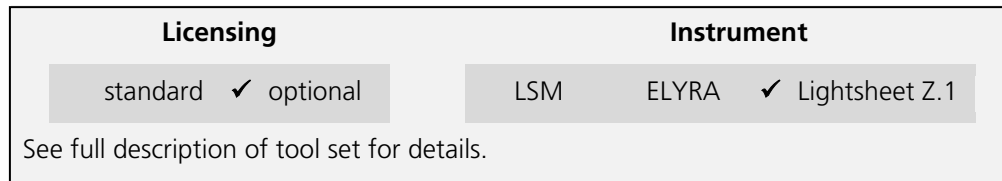
Note that the dimensionality must not be the same as in the **coefficient** table. The **assignment table** lists the channels (**Ch**) and the laser lines used (**Laser**). With the identity (**ID**) drop down menu (Fig. 514), an ID from the **coefficient table** can be assigned individually to a channel. That channel will then be corrected exactly with the coefficients of that **ID**.

If no alignment should be performed **do not align** can be chosen.

 The **channel alignment** tool is generically programmed to have high flexibility. Care should therefore be exerted in the control which channels are how aligned as there are no warnings, if unrelated channels are aligned to each other.

If you draw Regions of Interests (ROIs) in the image, they will be taken for alignment. For parabolic fit, you should have at least 3 well spaced regions. If you have fiducial markers, you can use them by setting the ROIs around them. Please be aware that in the z-direction the algorithm scans the whole z-Stack and takes the brightest area in the z-direction. If your beads are not the brightest structure, then the alignment will fail.

### 5.4.19 Processing – Lightsheet Processing



The **Lightsheet Processing** module allows one to process images that were acquired with the Lightsheet Z.1 using **Dual Side** illumination and/or with the **Multiview tool** tab.

Files need to be saved prior to any Lightsheet Processing task. If this is not the case the software will ask to save the data before proceeding.

 All images and registration files resulting from Lightsheet Processing can be found in a Result folder that is created in the folder of the original file, that was used for processing.

#### 5.4.19.1 Dual Side Fusion

This processing task can be used for the following datasets acquired with **Dual Side** illumination:

- Image (Snap function)
- Time Series
- Z-Stacks
- Combinations of Time Series and Z-Stacks
- Multiview experiments as well in combination with Time Series

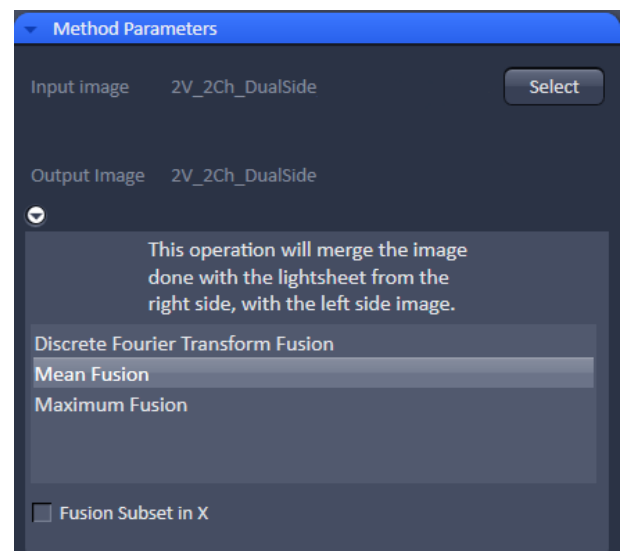
When a dataset has been acquired using **Dual Side** illumination, the dataset will have the illumination dimension saved in its metadata and the **Dimension slider** for Illumination is visible in the **Image Control area**. Both illumination sides are handled as single frames within the image. **Dual Side Fusion** provides three main options for merging both images from the different illumination sides into a single frame.

Choose the dataset you wish to perform the task by mark either option (Fig. 515).

#### Discrete Fourier Transform Fusion:

The fusion is performed based upon the published method ("Multiple imaging axis microscopy improves resolution for thick-sample applications", Jim Swoger, Jan Huisken, and Ernst H. K. Stelzer, OPTICS LETTERS / Vol. 28, No. 18 / September 15, 2003).

Fine structures and details are more visible after the fusion which might be worsened when using Mean Fusion. However, this process can create noticeable artifacts in the resulting image.



**Fig. 515 Processing – Lightsheet Processing. Dual Side Fusion**

**Mean Fusion:**

The average intensity for each pixel is calculated using the values from both illumination sides.

**Maximum Fusion:**

The intensity of each pixel of both illumination images is compared and the value with the higher intensity is used for the resulting image.

For **Mean Fusion** and **Maximum Fusion** the checkbox **Fusion Subset in X** can be activated (Fig. 516). With these controls it is possible to choose which area of the left and the right illumination image should be used for fusion.

When this function is chosen, the image is displayed in the **Preview Tab** within the image container (Fig. 517). In this preview mode the left hand image shows the original dataset and the right hand image the preview of processing. Using the **dimension sliders** within the **image control area** the **Z-Position**, **Illumination** side and **View** can be chosen.

In **Fusion Subset in X** the currently chosen View is displayed in the **Current View** box.

With the **Left** slider or spin box the area of the left illumination side is defined. This is marked at the slider itself with a red line, the spin box shows the pixel value of the y axis. Furthermore the cut off is shown in the preview image with a red line for easy orientation. It is best to set the **illumination slider** of the **image control area** to 1, showing the left side illumination of the original data.

Repeat the process with the **Right** slider and input box; here the marking lines are in blue and the **illumination slider** in the **image control area** should be placed to 2, showing the right side illumination of the original data.

The **Preview** in the image container will show the position of both sliders **Left** and **Right** as red and blue lines respectively (Fig. 517).

To avoid a visible change in intensity along the two cut off lines, for **Mean Fusion** with **Fusion Subset in X**, an overlap of both illumination sides should remain in the center of the image and the **Blending** slider should be used to define the number of pixels used within this overlap to crossfade both illuminations sides.

The position of the sliders **Left** and **Right** as well as the **Blending** value must be defined for each view individually.

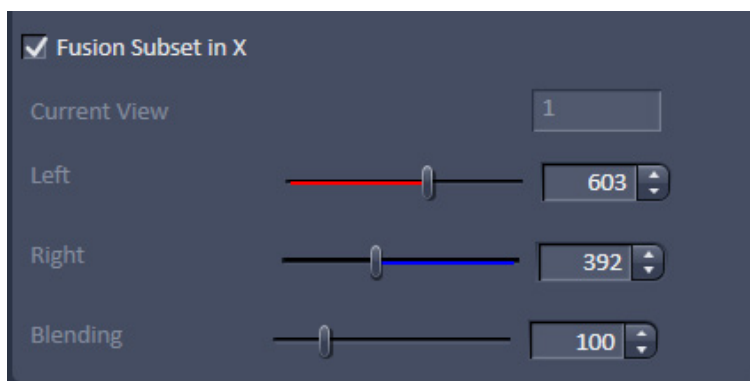
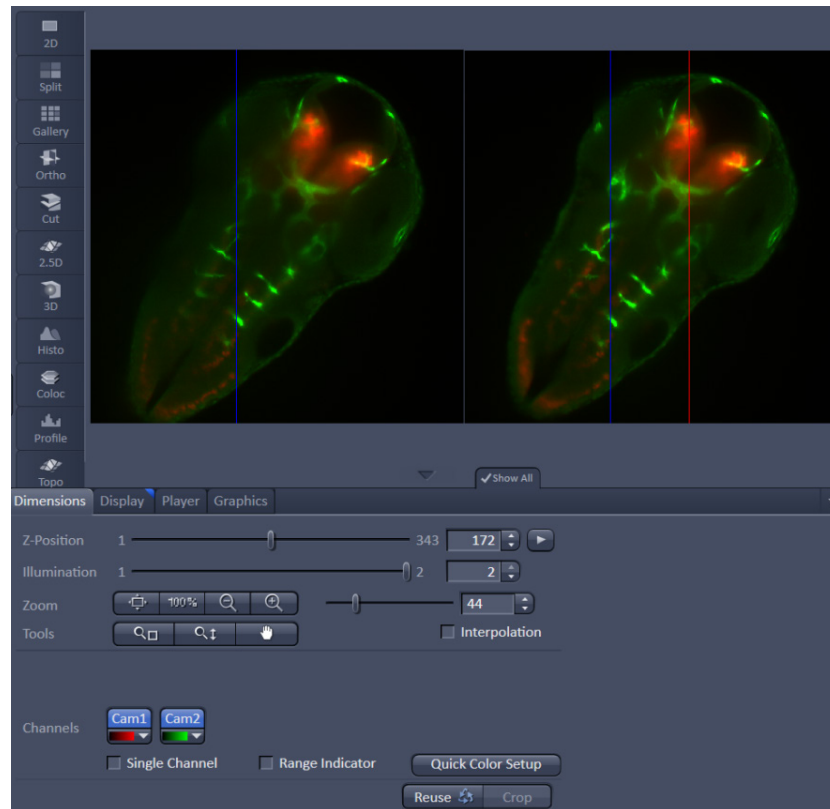


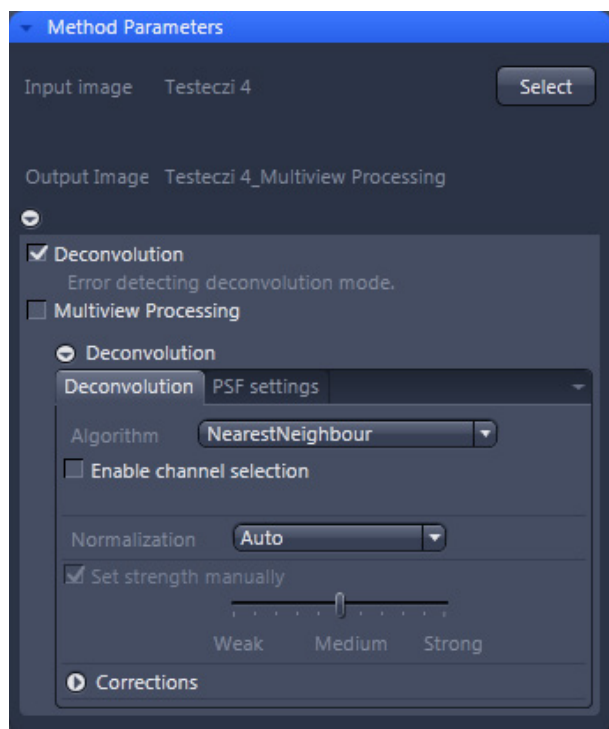
Fig. 516 Dual Side Fusion – Fusion Subset in X





**Fig. 517 Dual Side Fusion – Fusion Subset in X, Preview and Image control area**

After pressing **Apply**, a new .czi file will be generated. The original file name will be extended with "\_Dual Side Fusion". For this resulting dataset, the illumination dimension is no longer available.



**Fig. 518 Processing – Lightsheet Processing. Multiview Processing, Deconvolution**

## 5.4.19.2 Multiview Processing

### 5.4.19.2.1 Deconvolution

For the multiview datasets acquired with the Lightsheet Z.1, **Deconvolution** is an available option (Fig. 518).

The following datasets are available for this processing option:

- a) Multiview experiments before registration and fusion (single or dual side illumination)

In this case, deconvolution is performed for each frame from all Z-Stacks and all Views. The process uses a point spread function (PSF) valid for single view images.

- b) Multiview experiments after registration and fusion.

The deconvolution is performed on the fused dataset, hence only one Z-Stack needs to be processed. It uses a different point spread function (PSF) than what is used for the deconvolution before registration and fusion of a multiview experiment dataset.

The software automatically recognizes if the image has been registered and fused or not and adjusts the interfaces accordingly.

Two tabs are available for detailed configuring (**Deconvolutions** tab and **PSF settings** tab):

On the **Deconvolution** tab, select the desired algorithm and define the precise settings for it.

Use the drop-down list next to Algorithm to choose from the available deconvolution algorithms:

**Nearest Neighbour:** The Nearest neighbor method uses the simplest and fastest algorithm (Castleman, K.R., Digital image Processing, Prentice-Hall, 1079). Its function is based on subtraction of the out-focus information in each plane of a stack, taking the neighboring sections above and below the corrected Z-plane into account. This method is applied sequentially to each plane of the entire Z-Stack. It allows you to enhance contrast quickly, even if image stacks have not been put together optimally.

**Regularized Inverse:** The inverse filter is a genuine 3D method and generally achieves better results than the Nearest neighbor algorithm. It essentially involves dividing the Fourier transformation ("FT") of the volume by the FT or the PSF, which can be performed very quickly. In the real space, this corresponds to a deconvolution. In addition, a statistical method ("General Cross Validation – GCV") is applied which determines the noise component of the image and automatically sets the restoration strength to the optimum level in line with this. This process is also known as regularization. Z-Stacks must have been acquired at the correct (Nyquist or smaller) distance. The additional acquisition of z-planes above and below the structure of interest is recommended.

**Fast Iterative:** The "Fast Iterative" method is an iterative restoration method that uses only one iteration per convolution step (see Meinel, E.S.: Origins of linear and nonlinear recursive restoration algorithms. J. Opt. Soc. Am, 3 (&), 1986, 787-799). No regularization is used in this case. Due to the fast processing and convergence after just a few iterations, this method is suitable in particular for the processing of larger time lapse images. The results of the method can quickly lead to good results and remove most of the out-of-focus light. They do not create quantitative brightness conditions in the image. If under-sampled images are present, artifact formation may also result.

**Constrained Iterative:** The best image quality is achieved using the iterative maximum likelihood algorithm (see Schaefer et al.: "Generalized approach for accelerated maximum likelihood based image restoration applied to three-dimensional fluorescence microscopy", J. of Microscopy, Vo. 204, Pt2, November 2001, pp. 99ff.): This algorithm is able to calculate light from various focal planes back to its place of origin. Consequently, with this method it is possible to derive the 3D structure from fluorescence images with the correct brightness distribution and to visualize optical sections. It is also possible for missing information to be partially restored from neighboring voxels. The spatial resolution can be increased without artifacts up to a theoretical limit (one voxel). It is essential for Z-Stacks to have been acquired in accordance with Nyquist. Acquiring sufficient planes above and below the structure of interest is also imperative for achieving good results. As this is a complex mathematical method, the calculation can take longer, depending on the image size.

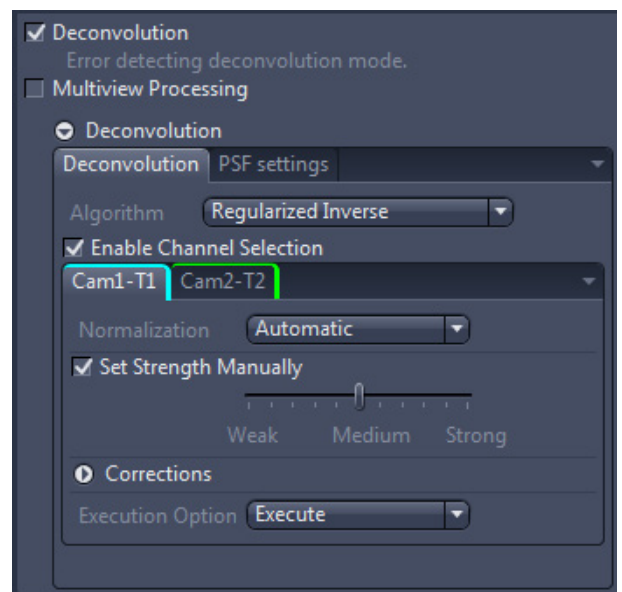
If the checkbox **Enable channel selection** is activated, the settings are applied on a channel-specific basis. This allows you to set parameters in a targeted way for each channel. You will see a separate colored tab for each of the channels (Fig. 519).

In the **Normalization** drop-down list, you can specify how the data from the resulting image are handled:

**Clip:** For non-registered and non-fused multiview images, this should be used as the default setting. It sets negative values to 0 (black). If the values exceed the maximum possible gray value of 65636 when the calculation is performed, they are limited to 65636 (pixel is 100% white).

**Automatic:** Normalizes the output image automatically. Not to be used for non-registered and non-fused multiview images.

In this case, the lowest value is 0 and the highest value is the maximum possible gray value in the image (gray value of 65636). The maximum available gray value range is always utilized fully in the resulting image.



**Fig. 519 Processing – Lightsheet Processing. Multiview Processing, Deconvolution, Enable channel selection**

**Adjust Strength checkbox:**

If you have selected the Nearest Neighbor algorithm or Fast Iterative, the set strength manually checkbox is always activated.

With the other Algorithm options, you can activate or deactivate this option using the check box next to **Set strength manually**. When activated, you can enter the degree of restoration using the slider.

To achieve strong contrast enhancement, move the slider towards Strong.

To achieve less contrast enhancement, move the slider towards Weak.

If the setting is too strong, image noise may be intensified and other artifacts, such as "ringing", may appear.

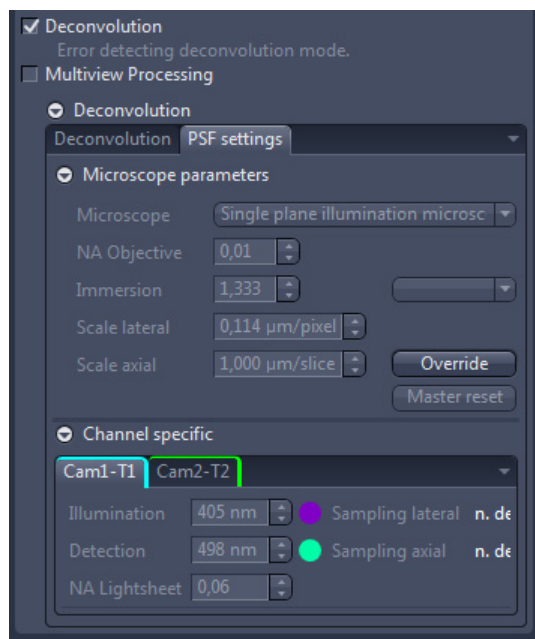
If **Set strength manually** is deactivated, it determines the restoration strength for optimum image quality automatically. The restoration strength is inversely proportional to the strength of the so-called regularization. This is determined automatically with the help of Generalized Cross Validation (GCV).

To expand the options for **Corrections**, use the black arrow-head button. Here you can find three additional corrections which can be activated or deactivated using the adjacent check boxes.

**Lamp Flicker checkbox:** Analyzes the total brightness of each z-plane. In the event of non-constant deviations in the total brightness between neighboring planes, a compensation factor is taken into account. Activate this function if you have acquired your images using an old fluorescent lamp that exhibits strong fluctuations in brightness.

**Decay:** Corrects changes in brightness (e.g. bleaching) of the sample during acquisition of the Z-Stack. This function should only be activated for widefield images. Use it if your sample undergoes strong bleaching during acquisition.

**Background Correction checkbox:** Analyzes the background component in the image and removes it before the DCV calculation. This can prevent background noise being intensified during DCV.

**W Plan-Apochromat 63x/1.0**

**Fig. 520** Processing – Lightsheet Processing. Multiview Processing, Deconvolution, PSF settings

On the **PSF settings** tab (Fig. 520), you can see and change all key parameters for generating a theoretically calculated Point Spread Function ("PSF").

☞ If an image is used that is not registered and not fused, a point spread function (PSF) is used that is specific for single view images (single view PSF) for the Lightsheet system. If an image is loaded that has already been registered and fused, a specific PSF is used for this dataset. This multiview PSF is calculated using the information on how many views and which rotations were used to acquire this particular dataset, taken from the image metadata.

Ordinarily, images that have been acquired using ZEN (stored as \*.czi) automatically contain all system parameters and image information, meaning that you do not have to configure any settings on this page. Most parameters are therefore grayed-out in the display. It is possible, however, that as a result of an incorrect microscope configuration, values may not be present or may be incorrect. You can change these here. The correction of spherical aberration can also be set here.

---

To edit any of the input boxes, press the **Override** button. To get back to the settings provided by the software, press the **Master Reset** button.

In the **Microscope Parameters** section are the most important system parameters for PSF generation that are not channel-specific displayed.

You can select the system used for data acquisition in the **Microscope dropdown** list. There are three options: Single plane illumination microscope, conventional microscope (also known as a widefield microscope), and confocal microscope for which the additional pinhole diameter parameter applies.

#### **Dimension:**

You can view and change the numerical aperture for the detection, which results as a combination of the detection optic and the used zoom setting, in the **NA Obj.** input field. So, it is not the numerical aperture of the detection optic alone which is indicated on the lens itself or displayed in the software.

The **Immersion input** field displays the refractive index of the immersion medium. Please note that this can never be smaller than the numerical aperture of the objective. You can make a selection from typical immersion media in the dropdown list next to the input field.

The **Scale lateral** input field displays the geometric scaling in the X/Y direction.

The **Scale axial** input field displays the geometric scaling in the Z direction.

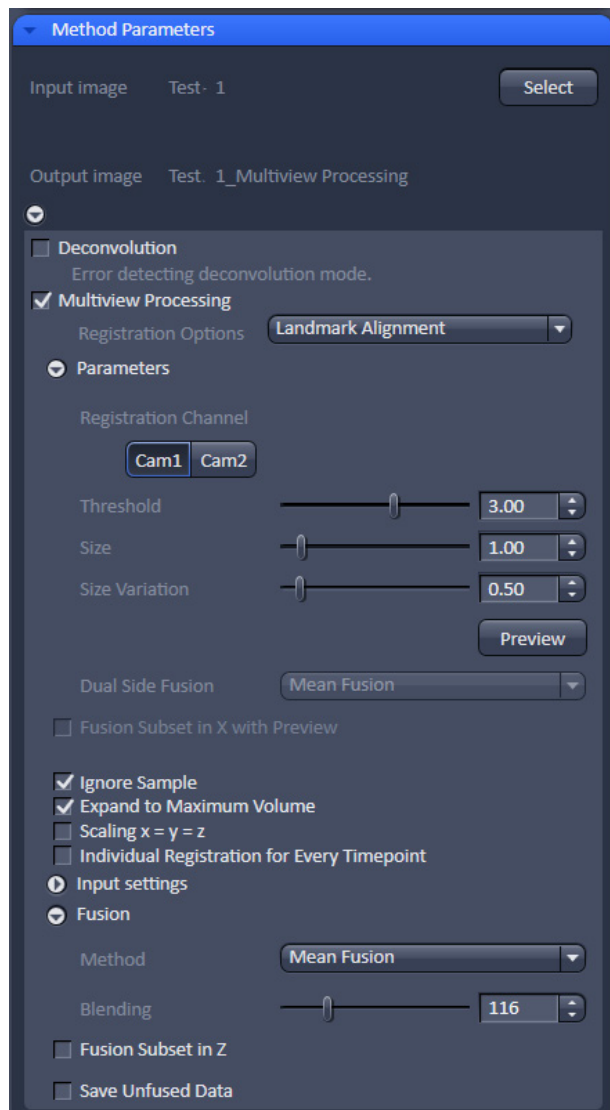
When scaling in this window is changed it will override the settings chosen in the **Multiview Processing** window (Fig. 521).

In the **Channel specific** section, you will find all settings that are channel-specific. This means that they may be configured differently for each channel.

The **Illumination** input box holds the excitation wavelength for the channel [in nm]. The maximum is assumed. The color field corresponds to the wavelength (as far as possible).


The **Detection** input box represents the maximum of the emission wavelength for this channel dye. The color field corresponds to the wavelength (as far as possible).

The **NA Lightsh.** input box displays the numerical aperture (NA), which is resulting from a combination of the illumination optics and the zoom settings used during image acquisition.



**Fig. 521 Processing – Lightsheet Processing. Multiview Processing**

#### 5.4.19.2.2 Registration Options

The **Registration Options** check-box next to **Multiview Processing** opens the interface to define the settings for the **Registration Parameters**, the **Input settings**, and the **Fusion options** for the data (Fig. 521). Each interface is accessed by pressing the  button next to it.

The following datasets can be processed with this task:

- Multiview datasets, single side illumination
- Multiview datasets, dual side illumination, Dual Side without Fusion
- Multiview datasets, dual side illumination, Dual Side with Fusion
- Multiview datasets, with Deconvolution
- Multiview datasets, without Deconvolution

The first step is to select the **Registration Options** using the drop-down menu. The choice will influence the **Parameters** interface.

The **Registration** will generate the transformation matrices so that all views are matched to overlay. As a result, a dataset is provided in which all Z-Stacks of all views should already largely overlay. The reference at which registrations starts is always View 1 of the dataset. This image can be used as a control. If one or more views do not have the same alignment, registration was not successful and the parameters must be adjusted.

When **Apply** is pressed and the registration process has finished, the transformation matrices are saved as an .xml file (Filename.czi.xml). Only the transformation matrix is saved if **Apply** is pressed and **None** is selected under **Fusion** (see below). This .xml file can be used for the **Use Registration From File** option.

The **Registration** must always be done before the **Fusion** of the data.

**Registration Options** are:

- Landmark Alignment
- Intensity Based Alignment
- Use Registration From File
- Interactive Registration

### 5.4.19.2.2.1 Landmark Alignment

For the **Landmark Alignment** (Fig. 522), the sample must have been embedded with appropriate fluorescent beads (fiducials) which can be recognized by the software. The beads can be present in the same channel as the image information. Another option is to image the beads alone in a second channel.

Select the Channel in which the beads are present by clicking the according **Registration Channel** button. One can select more than one channel for the registration process. For each chosen channel and individual registration will be performed; it is therefore advisable to use one channel for the final registration. To test which channel will lead to the best results, all channels can be chosen for later comparison of the results.

To define which structures within the images are the beads to be used for the Landmark Alignment, use the sliders and input boxes with arrows of

**Threshold:** brightness of beads,

**Size:** size of the beads, and

**Size Variation:** how much do the beads differ in size.

All values with these parameters are arbitrary units.

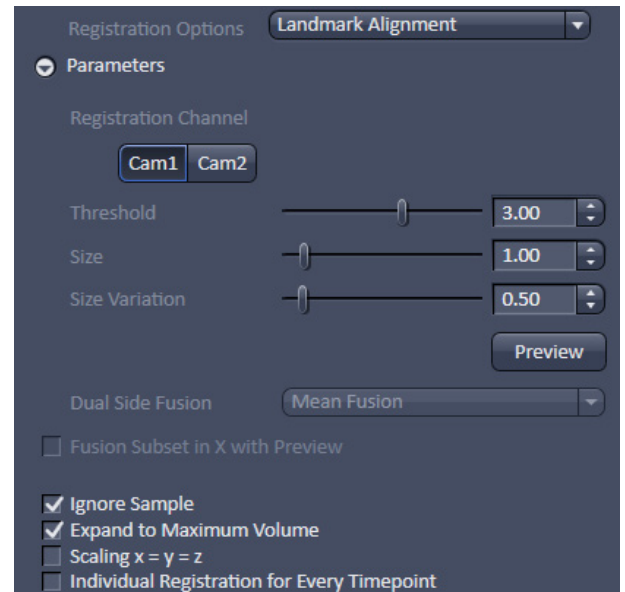
To check if the settings recognize the beads of the image, press the **Preview** button. This will circle all elements recognized as beads in the chosen and displayed image frame. Use the sliders in the **Dimensions View** control to change to a different view, z-slice, and time point and press again the **Preview** button. Control by using several different frames to see if the beads are recognized correctly before proceeding. Adjust the settings for **Threshold**, **Size**, and **Size Variation** until this is accomplished.

If your data was acquired with dual side illumination which has not yet been fused, the method to fuse both illumination sides is available in the **Dual Side Fusion** drop-down menu (**Mean Fusion**, **DFT Fusion**, **Maximum Fusion**).

**Mean Fusion:** The average intensity for each pixel is calculated using the values of both illumination sides.

**DFT Fusion** (Discrete Fourier Transform Fusion): The Fusion is performed based upon the published method ("Multiple imaging axis microscopy improves resolution for thick-sample applications", Jim Swoger, Jan Huisken, and Ernst H. K. Stelzer, OPTICS LETTERS / Vol. 28, No. 18 / September 15, 2003). Fine structures and details are more visible after the fusion, which might be worsened when using Mean Fusion. However, this process can create noticeable artifacts in the resulting image.

**Maximum Fusion:** The intensity of each pixel of both illumination images is compared and the value with the higher intensity is used for the resulting image.



**Fig. 522 Processing – Lightsheet Processing. Multiview Processing, Landmark Alignment Parameters**

For **Mean Fusion** and **Maximum Fusion** the checkbox **Fusion Subset in X with Preview** can be activated (Fig. 523). With these controls it is possible to define which area of the left and the right illumination image should be used for fusion.

When this function is chosen, the image is displayed in the **Preview Tab** in the image container (Fig. 524). In this preview mode the left hand image shows the original dataset and the right hand image the preview of processing. Using the **dimension sliders** within the **image control area** the **Z-Position**, **Illumination** side and **View** can be chosen.

In **Fusion Subset in X with Preview** the currently chosen View is displayed in the **Current View** box.

With the **Left** slider or input box the area of the left illumination side is chosen. This is marked at the slider itself with a red line, the input box shows the pixel value along the y axis. Furthermore the cut off is shown in the preview image with a red line for easy orientation. It is best to set the **illumination slider** of the **image control area** to 1, showing the left side illumination of the original data.

Repeat the process with the **Right** slider and input box; here the marking lines are in blue and the **illumination slider** in the **image control area** should be placed to 2, showing the right side illumination of the original data.

The **Preview** in the image container will show the position of both sliders **Left** and **Right** as red and blue lines respectively (Fig. 524).

To avoid a visible change in intensity along the two cut off lines, for **Mean Fusion** with **Fusion Subset in X**, an overlap of both illumination sides should remain in the center of the image and the **Blending** slider should be used to define the number of pixels used within this overlap to crossfade both illuminations sides.

The position of the sliders **Left** and **Right** as well as the **Blending** value must be defined for each view individually.

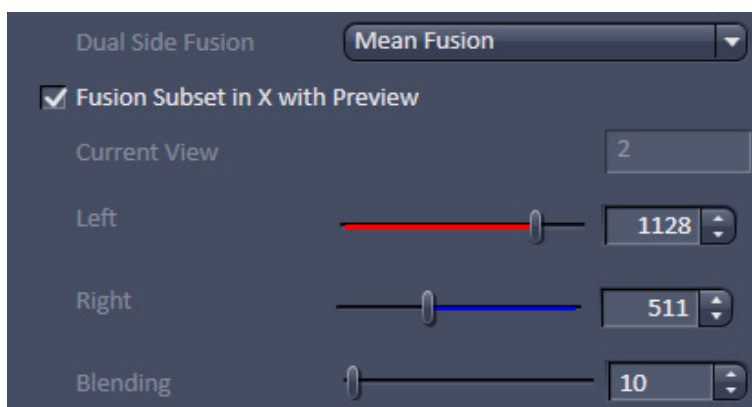
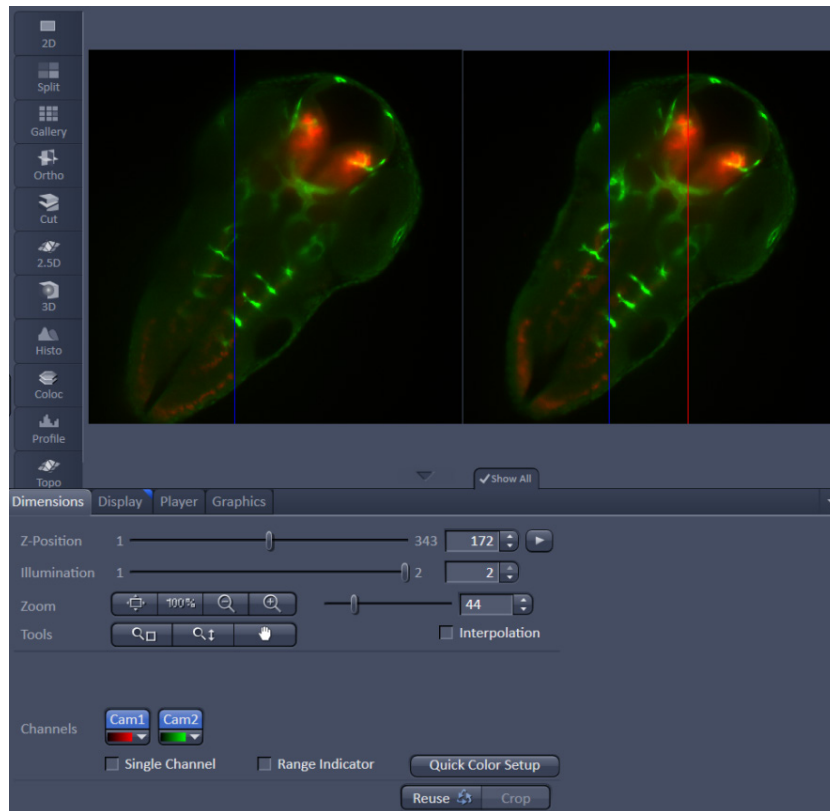


Fig. 523 Dual Side Fusion – Fusion Subset in X





**Fig. 524 Dual Side Fusion – Fusion Subset in X, Preview and Image control area**

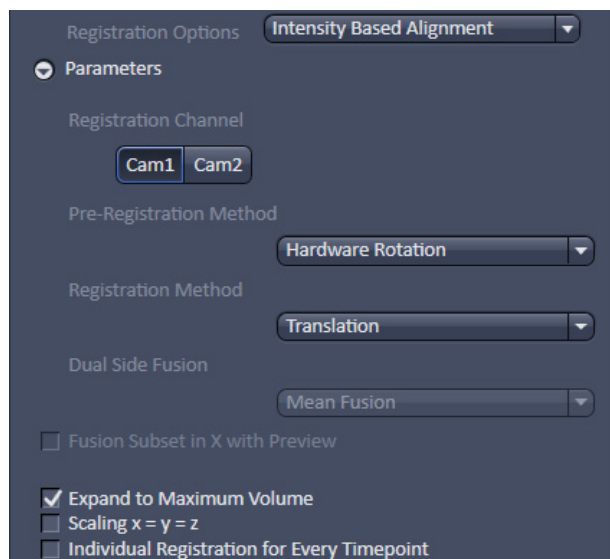
**Ignore Sample:** This option activates an additional function to find structures within the sample that were incorrectly labeled as beads (fiducials). These structures are not taken into account during the Landmark Alignment process; but they are not removed from the **Preview**.

**Expand To Maximum Volume:** This checkbox is activated as default. In a multiview experiment not all views might include all the information. When **Expand To Maximum Volume** is activated, the volume of the resulting dataset after registration and fusion is determined and additional black pixel (x,y) and z-slices are added to the views during registration. This prevents loss of data for later fusion.

**Scaling x=y=z:** The dimensions are downsized to the smallest to have the same size. If the scaling in **Deconvolution, PSF settings** (Fig. 520) is changed, the latter will override the scaling settings here.

**Individual Registration For Every Time point:** If the multiview experiment has been performed over time, this option becomes available.

- If **activated**, each time point generates a transformation matrix and each time point is registered individually. As a result, the time necessary for registration is multiplied by the number of time points and can rise substantially. However, if the motorized movement of the sample by the system has changed (e.g. due to thermic effects on the system: not fully warmed up at start, incubation, air conditioning of the room), the Individual Registration For Every Time point option becomes necessary.
- If **not activated**, one transformation matrix is generated for all the following time points based on the first time point. As a result, processing for registration has only to be done once which reduces processing time.



**Fig. 525 Processing – Lightsheet Processing. Multiview Processing, Intensity Based Alignment, Parameters**

#### 5.4.19.2.2 Intensity Based Alignment

The **Intensity Based Alignment** option does not need any fluorescent beads (fiducials) present in the sample since registration is done based on structural information within the image content. It is therefore advisable to select the **Registration Channel** which contains clearly defined fluorescent structures within the image. One can choose more than one channel for registration. For each chosen channel and individual registration will be performed; it is therefore advisable to use one channel for the final registration. To test which channel will lead to the best results, all channels can be chosen for later comparison of the results.

Registration can be done as a two-step process with a preceding **Pre-Registration** and afterwards the **Registration** (Fig. 525).

The **Pre-Registration** performs the process in a 2D maximum intensity projection of the Z-Stacks; while the **Registration** algorithm uses the complete 3D information of the Z-Stacks.

 It is advisable to perform first a **Pre-Registration** to move similar structures already into close proximity, which might facilitate the **Registration**.

You can select the following **Pre-Registration Methods** from the drop down menu:

**None:** No Pre-Registration is performed. Registration is then only done with the settings chosen in the Registration Method menu.

**Hardware Rotation:** The Views are rotated solely based on the information from the rotation positioning of the sample holder which are saved in the metadata.

**Trans Hardware Rotation:** The Views are rotated solely based on the information from the rotation positioning of the sample holder which are saved in the metadata. Additionally the x, y, and z axis are moved to match the Views.

**Correlation Hardware Rotation:** The Views are rotated solely based on the information from the rotation positioning of the sample holder which are saved in the metadata. Additionally the x, y, and z axis are moved to match the Views. Cross-correlation is used to determine the translation in x, y, and z.

To select the **Registration Method**, use the drop-down menu.

**Use Pre Register Only:** No Registration process is performed; only the result of the Pre-Registration is used.

**Translation:** The registration will correct along the x, y, and z axis only.

**Trans Rotation:** The registration will correct along the x, y, and z axis and also the rotation along x and y.

If your data was acquired with dual side illumination which has not yet been fused, the method to fuse both illumination sides is available in the **Dual Side Fusion** drop-down menu (**Mean Fusion, DFT Fusion, Maximum Fusion**).

**Mean Fusion:** The average intensity for each pixel is calculated using the values from both illumination sides.

**DFT Fusion** (Discrete Fourier Transform Fusion): The Fusion is performed based upon the published method ("Multiple imaging axis microscopy improves resolution for thick-sample applications", Jim Swoger, Jan Huisken, and Ernst H. K. Stelzer, OPTICS LETTERS / Vol. 28, No. 18 / September 15, 2003). Fine structures and details are more visible after fusion, which might be worsened when using Mean Fusion. However, this process can create noticeable artifacts in the resulting image.

**Maximum Fusion:** The intensity of each pixel of both illumination images is compared and the value with the higher intensity is used for the resulting image.

For **Mean Fusion** and **Maximum Fusion** the checkbox **Fusion Subset in X with Preview** can be activated (Fig. 526). With these controls it is possible to define which area of the left and the right illumination image should be used for fusion.

When this function is chosen, the image is displayed in the **Preview Tab** in the image container (Fig. 527). In this preview mode the left hand image shows the original dataset and the right hand image the preview of processing. Using the **dimension sliders** within the **image control area** the **Z-Position**, **Illumination** side and **View** can be chosen.

In **Fusion Subset in X with Preview** the currently chosen View is displayed in the **Current View** box.

With the **Left** slider or input box the area of the left illumination side is chosen. This is marked at the slider itself with a red line, the input box shows the pixel value along the y axis. Furthermore the cut off is shown in the preview image with a red line for easy orientation. It is best to set the **illumination slider** of the **image control area** to 1, showing the left side illumination of the original data.

Repeat the process with the **Right** slider and input box; here the marking lines are in blue and the **illumination slider** in the **image control area** should be placed to 2, showing the right side illumination of the original data.

The **Preview** in the image container will show the position of both sliders **Left** and **Right** as red and blue lines respectively (Fig. 527).

To avoid a visible change in intensity along the two cut off lines, for **Mean Fusion** with **Fusion Subset in X**, an overlap of both illumination sides should remain in the center of the image and the **Blending** slider should be used to define the number of pixels used within this overlap to crossfade both illuminations sides.

The position of the sliders **Left** and **Right** as well as the **Blending** value must be defined for each view individually.

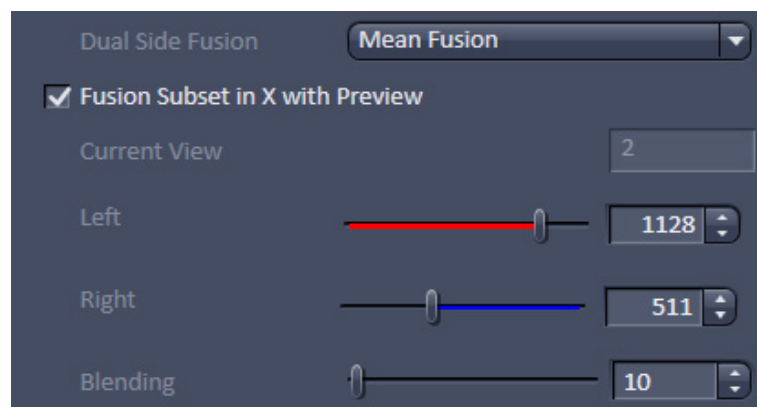
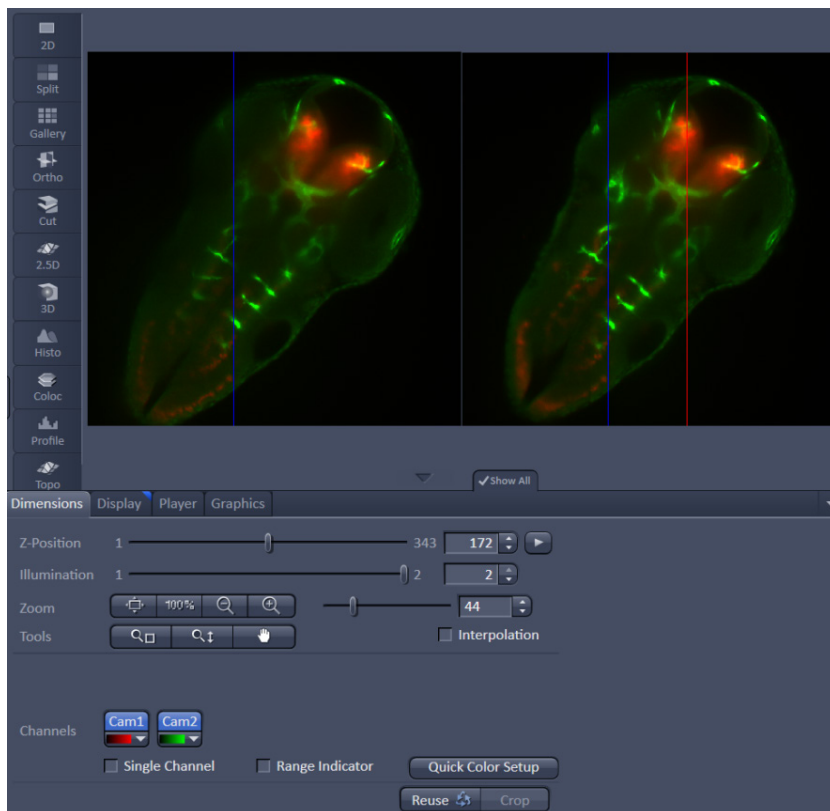


Fig. 526 Dual Side Fusion – Fusion Subset in X



**Fig. 527 Dual Side Fusion – Fusion Subset in X, Preview and Image control area**

**Expand To Maximum Volume:** This checkbox is activated as default. In a multiview experiment not all views might include all the information. When **Expand To Maximum Volume** is activated, the volume of the resulting dataset after registration and fusion is determined and additional black pixel (x,y) and z-slices are added to the views during registration. This prevents loss of data for later fusion.

**Scaling x=y=z:** The dimensions are downsized to the smallest to have the same size.

**Individual Registration For Every Time point:** If the multiview experiment has been performed over time, this option becomes available.

- If **activated**, each time point generates a transformation matrix and each time point is registered individually. As a result, the time necessary for registration is multiplied by the number of time points and can rise substantially. However, if the motorized movement of the sample by the system has changed (e.g. due to thermic effects on the system: not fully warmed up at start, incubation, air conditioning of the room), the Individual Registration For Every Time point option becomes necessary.
- If **not activated**, one transformation matrix is generated for all the following time points based upon the first time point. As a result, processing for registration has only to be done once which reduces processing time.

### 5.4.19.2.2.3 Use Registration From File

When the Registration for the dataset has been determined already and the transformation matrix has been saved as an .xml file (Filename.czi.xml), this option can be chosen. Click on the button next to **Registration File** to open a Windows Explorer window in which you can find and select the file.

With the drop down menus, the **Interpolation** mode and **Dual Side Fusion** processing can be chosen (see as well **Landmark Alignment or Intensity Based Alignment** section).

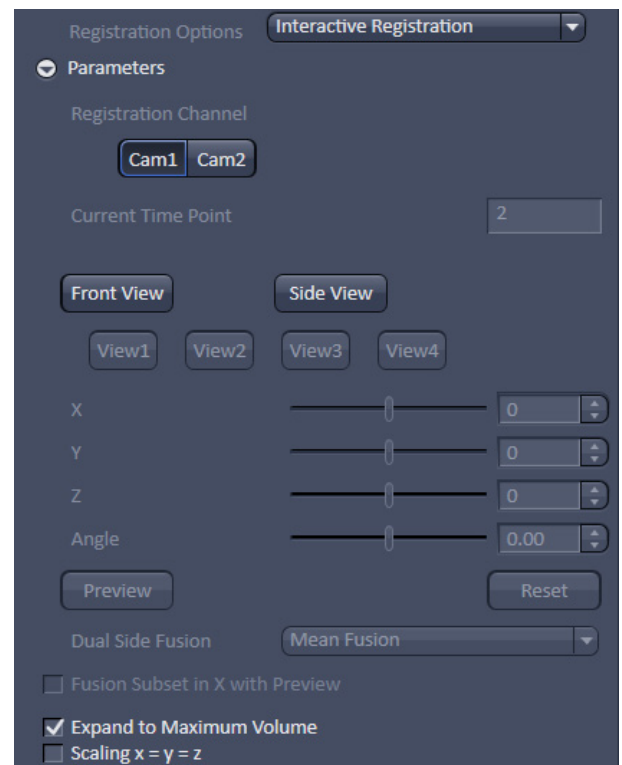
**Expand To Maximum Volume:** This checkbox is activated as the default. In a multiview experiment, the Z-Stacks are often of different sizes. When **Expand To Maximum Volume** is activated, it will use the maximum slice number (from one View) present in the dataset for registration. The additional z-slices needed in other views will be filled with black frames. This will ensure that no data is lost from views with larger z-dimensions. If this checkbox is not activated, the number of z-slices from the first View is taken as the default and larger Z-Stacks will be cut; there is a risk of data loss.

**Scaling x=y=z:** The dimensions are downsized to the smallest to have the same size.

### 5.4.19.2.2.4 Interactive Registration


**Interactive Registration** allows to register the recorded views of an experiment manually, when the other alignment options fail for that dataset (Fig. 528). The views of one channel at one time point of the experiment are the basis for the procedure. The z-stacks of the individual views are rotated based on the rotation information of the files meta data and transformed into channels resulting in one maximum intensity projection image. Within this newly generated image the views, now behaving as channels, can be moved in x, y, z and rotated to overlay each other. When all views are layed on top of each other, the **Apply** button will use the adjusted parameters to register, and when required fuse, the views for all time points of the experiment. An .xml file is created which can be used for the **Use registration from file** option. This .xml file can be found along with the processed data in the Result folder.

The first step is to chose the **Registration Channel** that should be used to manually overlay all views of the experiment by pressing the according button, e.g. **Cam1**. Only one channel can be used for this procedure, all other channels will not be displayed. If the experiment consists of a time series, one time point is selected with the **Time** slider and spin box of the **image control area**. This chosen time point is indicated in the **Current Time Point** box (Fig. 528).



**Fig. 528** Registration Options: Interactive Registration

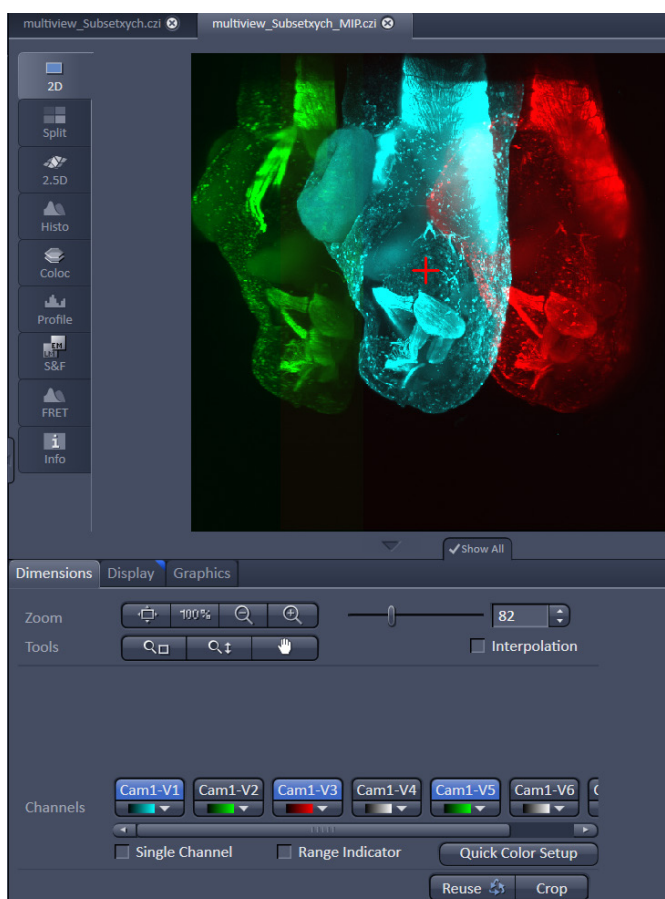
To generate the maximum intensity projection image either the **Front View** or the **Side View** button can be pressed. In the resulting maximum intensity projection image, each view is handled as a channel (e.g. Cam1-V1, Cam1-V2) of the image, a color can be assigned to each channel and it can be turned on or off in the **image control area** (Fig. 529).

 Be aware, the calculation of the maximum intensity projection of the **Front View** or **Side View** will take some processing time, depending on the size of the used dataset.



**Fig. 529** Interactive Registration – Views into Channel conversion of the maximum intensity projection image

It is of no consequence with which of the maximum intensity projections the process is started. In case of using the **Front View** button, the maximum intensity projection is calculated along the z-axis and the x,y axis are displayed in the resulting image (Fig. 530). The **Side View** button results in a maximum intensity projection along the x-axis, displaying the z- (horizontal) and y- (vertical) axis. The maximum intensity projection image is opened in a new **image window**, named Filename\_MIP.czi. The following steps are done on the basis of the maximum intensity projection, hence in this **image window**.



**Fig. 530** Interactive Registration – Maximum intensity projection (Front View) image with red cross overlay for view rotation (views Cam1-V1, Cam1-V3 and Cam1-V5 are visible in the image)

**View 1** is the master view and cannot be moved during the process, the button **View 1** is therefore inactive and grayed out. Any of the other views can be activated by pressing the according button (e.g. **View2**, Fig. 528). The activated view is automatically displayed in the image (the associated channel is turned on). To move the view relatively to View 1 the sliders and spin boxes can be used; **X** for the x-axis, **Y** for the y-axis, **Z** for the z-axis and **Angle** for a rotation. The axis that is not present in the maximum intensity projection is grayed out and inactive (**Z** for the **Front View** and **X** for the **Side View**).

Additionally to the rotation **Angle**, the position of the rotation point can be defined. This is done by positioning the **red Cross overlay** within the maximum intensity projection image window to the desired position, the view should be rotated around (Fig. 530).

The **Reset** button moves all views back to the position they were at, as the maximum intensity projection was generated.

Each view should be activated once with its corresponding button and positioned, resulting in a matching overlay to **View 1**. Afterwards the maximum intensity projection is switched to either **Front View** or **Side View**; displayed in the same image window.

Again all views must be moved using the according sliders **Y**, **Z** and **Angle** to produce a perfect overlay to View 1.

Switching from **Front View** to **Side View** should be repeated at least twice, to adjust the positioning of the views.

To control if the manual alignment is satisfactory, the **Preview** button produces a new image of the channel and the time point, which is registered with the provided settings. The **Preview** image will contain fused views, when **Mean Fusion** has been selected at the **Fusion Method** drop down list.

If the result is satisfactory, one can proceed with the remaining settings for **Multiview Processing**.

If the data was acquired with dual side illumination, which has not yet been fused, the method to fuse both illumination sides is available in the **Dual Side Fusion** drop-down menu (**Mean Fusion**, **DFT Fusion**, **Maximum Fusion**).

**Mean Fusion:** The average intensity for each pixel is calculated using the values of both illumination sides.

**DFT Fusion** (Discrete Fourier Transform Fusion): The Fusion is performed based upon the published method ("Multiple imaging axis microscopy improves resolution for thick-sample applications", Jim Swoger, Jan Huisken, and Ernst H. K. Stelzer, OPTICS LETTERS / Vol. 28, No. 18 / September 15, 2003). Fine structures and details are more visible after the fusion, which might be worsened when using Mean Fusion. However, this process can create noticeable artifacts in the resulting image.

**Maximum Fusion:** The intensity of each pixel of both illumination images is compared and the value with the higher intensity is used for the resulting image.

For **Mean Fusion** and **Maximum Fusion** the checkbox **Fusion Subset in X with Preview** can be activated (Fig. 531). With these controls it is possible to define which area of the left and the right illumination image should be used for fusion.

When this function is chosen, the image is displayed in the **Preview Tab** in the image container (Fig. 532). In this preview mode the left hand image shows the original dataset and the right hand image the preview of processing. Using the **dimension sliders** within the **image control area** the **Z-Position**, **Illumination** side and **View** can be chosen.

In **Fusion Subset in X with Preview** the currently chosen View is displayed in the **Current View** box.

With the **Left** slider or input box the area of the left illumination side is chosen. This is marked at the slider itself with a red line, the input box shows the pixel value along the y axis. Furthermore the cut off is shown in the preview image with a red line for easy orientation. It is best to set the **illumination slider** of the **image control area** to 1, showing the left side illumination of the original data.

Repeat the process with the **Right** slider and input box; here the marking lines are in blue and the **illumination slider** in the **image control area** should be placed to 2, showing the right side illumination of the original data.

The **Preview** in the image container will show the position of both sliders **Left** and **Right** as red and blue lines respectively (Fig. 532).

To avoid a visible change in intensity along the two cut off lines, for **Mean Fusion** with **Fusion Subset in X**, an overlap of both illumination sides should remain in the center of the image and the **Blending** slider should be used to define the number of pixels used within this overlap to crossfade both illuminations sides.

The position of the sliders **Left** and **Right** as well as the **Blending** value must be defined for each View individually.

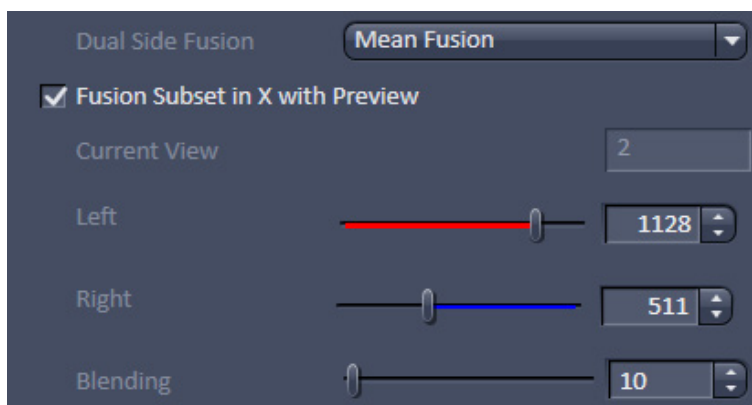


Fig. 531 Dual Side Fusion – Fusion Subset in X

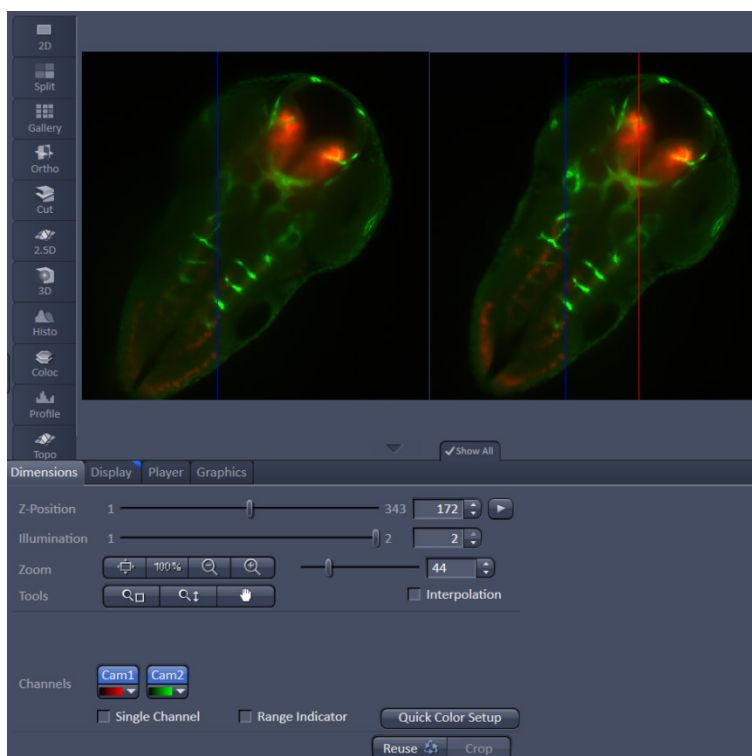


Fig. 532 Dual Side Fusion – Fusion Subset in X, Preview and Image control area



**Ignore Sample:** This option activates an additional function to find structures within the sample that were incorrectly labeled as beads (fiducials). These structures are not taken into account during the Landmark Alignment process; but they are not removed from the **Preview**.

**Expand To Maximum Volume:** This checkbox is activated as default. In a multiview experiment not all views might include all the information. When **Expand To Maximum Volume** is activated, the volume of the resulting dataset after registration and fusion is determined and additional black pixel (x,y) and z-slices are added to the views during registration. This prevents loss of data for later fusion.

**Scaling x=y=z:** The dimensions are downsized to the smallest to have the same size. If the scaling in **Deconvolution, PSF settings** (Fig. 520) is changed, the latter will override the scaling settings here.

**Individual Registration For Every Time point:** If the multiview experiment has been performed over time, this option becomes available.

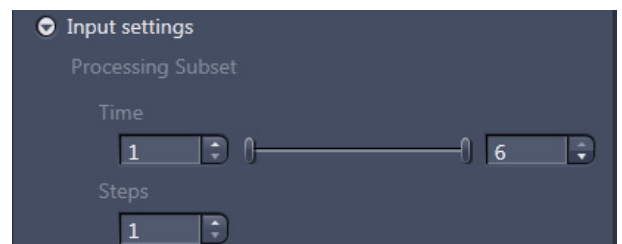
- If **activated**, each time point generates a transformation matrix and each time point is registered individually. As a result, the time necessary for registration is multiplied by the number of time points and can rise substantially. However, if the motorized movement of the sample by the system has changed (e.g. due to thermic effects on the system: not fully warmed up at start, incubation, air conditioning of the room), the **Individual Registration For Every Time point** option becomes necessary.
- If **not activated**, one transformation matrix is generated for all the following time points based on the first time point. As a result, processing for registration has only to be done once which reduces processing time.

### 5.4.19.2.3 Input Settings

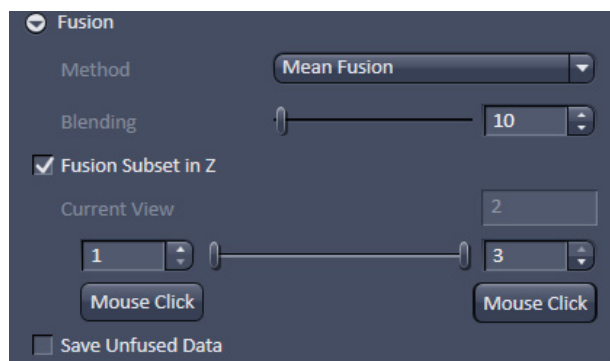
In this sub-menu, a subset of a present time series can be chosen for the Registration and Fusion processing (Fig. 533).

Use the two sliders or input boxes with arrows on each side to truncate the **Time** points. If not every time point in this period should be taken, the **Steps** can be defined with the input-box with arrows.

If a subset of a time series is defined this way, the resulting images will be numbered according to their new sequence, which might not be the same as in the input file.



**Fig. 533** Processing – Lightsheet Processing. Multiview Processing, Input Settings



**Fig. 534** Processing – Lightsheet Processing. Multiview Processing, Fusion

#### 5.4.19.2.4 Fusion

After Registration of the Views, the **Fusion** process can be performed (Fig. 534). This will lead to one Z-Stack or Z-Stack over time.

You can choose the following methods using the drop-down menu:

**None:** no Fusion is performed after Registration and Dual Side Fusion.

**Mean Fusion:** The pixel in the fused image is determined by averaging the intensity level of the pixels for the involved views.

**Mean Fusion + Multiview DCV:** This option is only available if the dataset has not undergone deconvolution before. The pixel in the fused image is determined by averaging the intensity level of the pixels of the involved views. After fusion, a deconvolution is performed. The **Deconvolution** interface becomes available when chosen (see above).

When all Z-stacks (hence all views) are fused into one Z-stack, the intensity values at the Z-stack borders can lead to visible edges. To prevent this, the borders of all Z-stacks can be faded during the Fusion process. With the **Blending** slider and input box with arrows, the amount of blending (smoothing) can be controlled. The value for **Blending** should be as low as possible, with typical values from 20 to 80; but this needs to be tested for every dataset.

It is possible to define which portion of the Z-stacks of the contributing views of the experiment shall be used for the fusion process. To do so the checkbox **Fusion Subset in Z** must be activated (Fig. 237). The view can be chosen with the according dimension slider of the **image control area**, and is displayed as **Current View**. For each of the views the z range can be chosen with the spin boxes or the sliders from each side. Alternatively a click on the **Mouse Click** button and afterwards onto the image (e.g. in the **Gallery View**) can be used to select the images to define the Z-range.

Whiles the whole Z-stacks are still used for registration (e.g. fiducials for Landmark based registration remain accessible), only the image information of the selected Z-range will be used for **Fusion**.


Portions of the Z-stacks, highly scattered and/or blurry content, can be discarded from the resulting fused image, to overall enhance the image quality. It must be considered for later deconvolution, that the calculated point spread function (PSF) of a multiview experiment, is based on the assumption that all views equally contribute to all areas of the image. This is not the case when using **Subset Z** and might result in artefacts of the deconvolution result.

If you want to keep the registered image as an interim result, even if the registration and fusion are done in one routine, activate the **Save Unfused Data** checkbox.

### 5.4.19.3 Online Multiview Processing

Processing of a multiview experiment dataset can be done online during data acquisition while the data is streamed onto a storage and analysis PC. ZEN software must be started on the storage and analysis PC and the master file (\*.czi) of the experiment can be opened.

It is possible to save dimensions of the experiment as individual files. To do so, the dimensions can be chosen with the according check box in the **Streaming** tool window (Fig. 535) of the **Maintain tab** (see as well section **Maintain Tab**).

 It is important that only the **Time** checkbox is activated for **Online Multiview Processing**, which is the default setting. If other dimensions are separated (e.g. channels) they are not included in the processing procedure and will be missing in the resulting file.

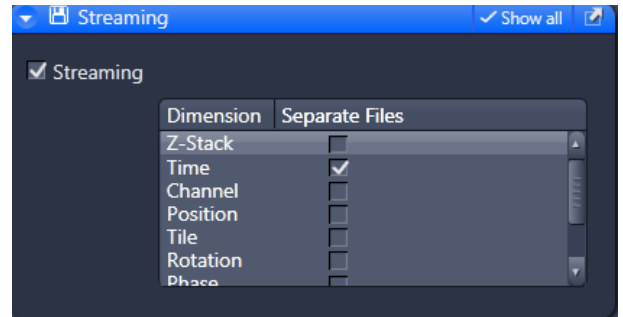


Fig. 535 Streaming tool window

When time series are acquired with the Lightsheet Z.1, the first time point is a master file with the following appearance: Name.czi (e.g. FishEmbryogenesis.czi). For each time point, a separate file is additionally formed in the same folder with the nomenclature: Name(time point-1).czi (e.g. FishEmbryogenesis(221).czi). This master file must be selected in the **Method Parameters** window. There, the settings for processing can be chosen as described in the section **Multiview Processing**.

When pressing the **Apply** button, processing will start for the already acquired images of the time series.

The registration option: **Interactive registration** is not available for **Online Multiview Processing** and is missing from the according drop down menu. To use this registration during the acquisition of the time series, please proceed as following. Open one time point of the experiment and choose the **Multiview Processing** option and press the **Select** button. Follow the description in section **Multiview Processing** to perform an interactive registration. When pressing the **Apply** button, an .xml file is created in the **Result** folder, which holds all registration information. The **Result** folder is created within the folder of the original dataset.

Proceed by opening the master file (first time point) of the ongoing experiment and choose **Online Multiview Processing**. Press the **Select** button and choose **Registration from file** from the drop down menu. Follow the instructions in section **Multiview Processing**.

## 5.4.20 Processing – Copy

Licensing		Instrument		
✓ standard	optional	✓ LSM	✓ ELYRA	✓ Lightsheet Z.1

Tool accepts all types of image data as input. See full description of tool set for details.

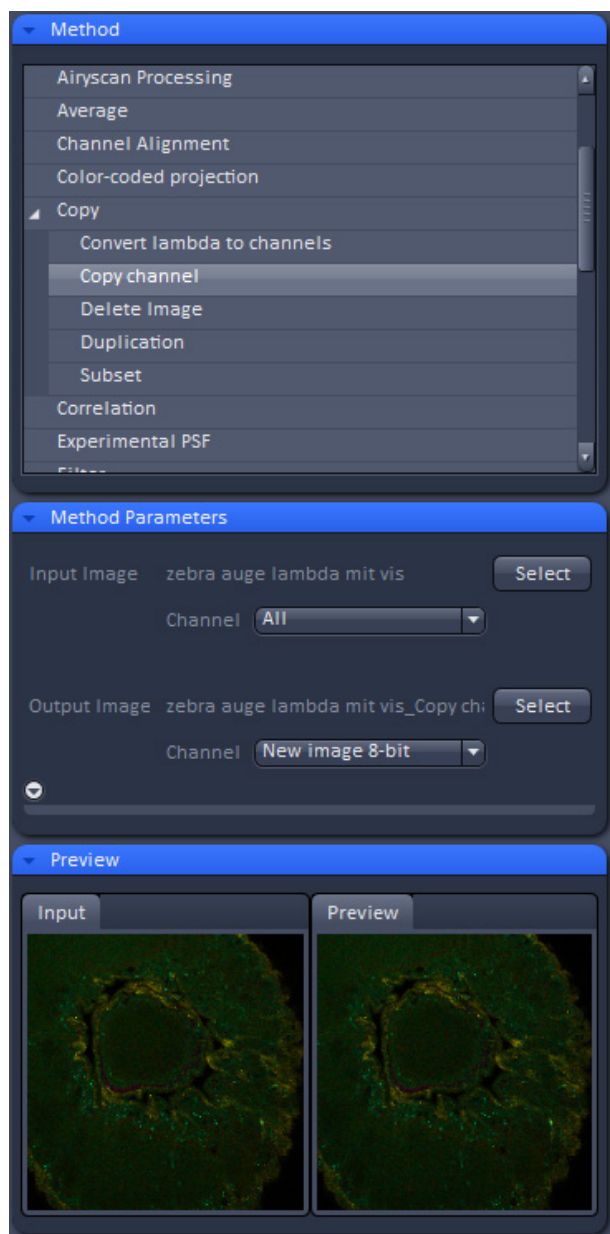


Fig. 536 Processing – Copy

The Copy function provides means to copy or duplicate images.

**Convert lamda to channels**

**Convert lamda to channels** converts images acquired in Lamda Mode to multichannel images where each detector element represents a separate channel in the new image (Fig. 536). All view and processing options available for multichannel images apply to the new image.

**Copy Channel**

**Copy Channel** produces a copy of the selected image.

The first **Select** button in the selection panel selects the active image in the **Image Display** as Input Image. The **Channel** selection pull down menu specifies which channel to copy.

The second **Select** button is used to choose a destination image if the copied channel is to be added to an existing image document. In the second **Channel** selection pull down menu the destination channel is specified – or a new image document can be chosen as destination.

Pressing **Apply** starts the copy process.

☞ For Z-Stacks or Time Series, the entire series for the selected channel is copied.

**Duplication**

**Duplication** creates a new image document which is a duplicate of the selected input image.

### Delete Image

Single images or series of images can be deleted from the selected image series (input image) acquired as time series or Z-Stacks or combinations of those.

The **Select** button selects the active image in the **Image Display** as the **Input Image** to be processed.

In the tool-specific settings panel, the parameters for the interpolation procedure are set.

Opening for example the x-subset panel (Fig. 537) brings up three sliders to set the **Start** and **End** coordinates of the new data set.

Pressing the **Mouse click** button selects the respective coordinate by clicking on the original image in the **Preview View** in the image display area (Center Screen Area). The **Step** coordinate determines how many data points in the respective dimension are dropped out. For example: setting **Step** to 3 takes 1 and drops 2 pixels along the respective dimension, reducing the data to 1/3. The scaling is calculated to remain correct in the resulting image.

### Subset

The **Subset** function is a set of tools to truncate a multidimensional data set in all available coordinates to the desired size (Fig. 538).

These subset panels are available for all coordinates of the selected image (x, y, z, t, view, illumination). The panel **Selection for all visible coordinates** is shown in Fig. 539. It always applies only to those coordinates open within the subset-panel (above).

The **Select by mouse click in image** option allows one to click in the Image Display and the respective coordinates are set (if displayed in the image: x, y in the 2D view, z, view and illumination in the gallery view, etc.).

The **assign from viewer** selects the coordinate from the slider in the **Dimensions View Options** control block.

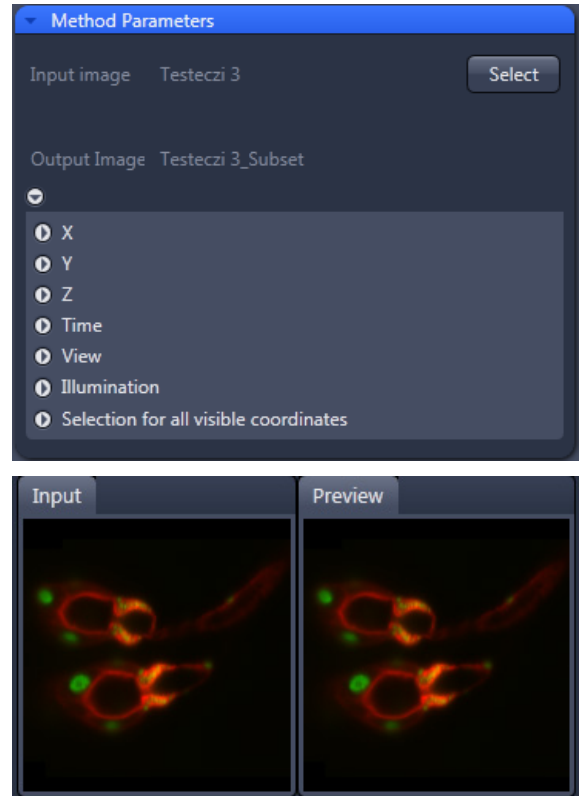


Fig. 537 Subset tool with loaded Multiview (Lightsheet Z.1) image

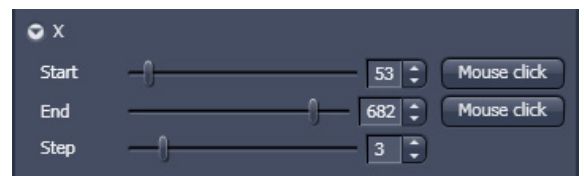


Fig. 538 Subset panel for x-coordinate

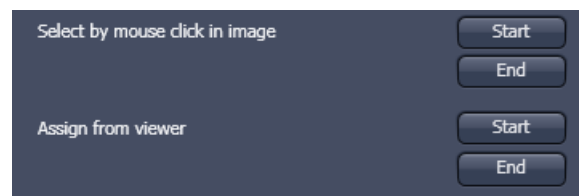
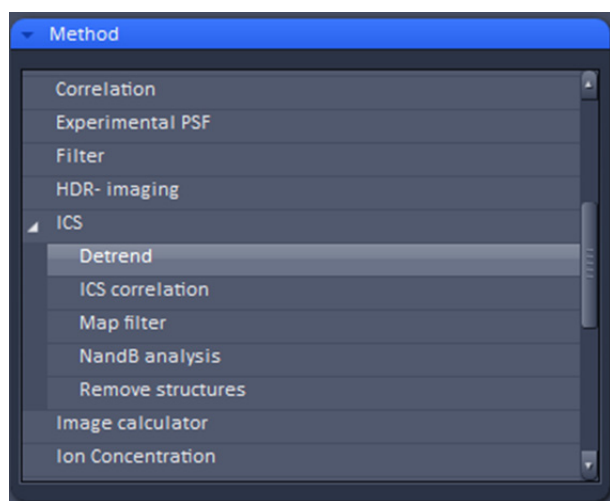


Fig. 539 Subset panel for "visible"

## 5.4.21 Processing – ICS

Licensing	Instrument
standard <input type="checkbox"/> optional <input checked="" type="checkbox"/>	<input checked="" type="checkbox"/> LSM    ELYRA    Lightsheet Z.1

Tool accepts exclusively input acquired with LSM 710 and LSM 780. See full description of the tool set and section on *RICS (Raster Scanning Image Correlation Spectroscopy)* for more details on requirements to be met.



**Fig. 540** Processing – ICS

- Activate **ICS** in the Processing tool by clicking on the arrow.

The **ICS** menu provides the following sub-processing functions: **Detrend**, **ICS correlation**, **Map filter**, **NandB Analysis** and **Remove structures** (Fig. 540).

### 5.4.21.1 Detrend

- The Detrend function is a high pass recursive filter.
- Click **Detrend** in the **ICS** tool. The **Method Parameters** menu will show the input options for this function.

- Select the desired image in the image container, then click **Select** to define this image as the **Input** image.

The resulting output image using the time constant parameter is shown in the **Preview** tool and the Preview View tab in the image container.

Input images are time series images.

The **Time constant** used to detrend the image is the number of images it takes for the recursive filter to decay to  $1/e$ . Use a smaller number for detrending faster moving larger objects like vesicles and a higher number for detrending bleaching effect or slower cell movements.

### 5.4.21.2 Remove Structure

- Activate **Remove structures** in the **ICS** tool. The **Remove structures** menu will appear.
- To select an image, highlight the image in the image container and press the **Select** button. This will be your **Input** image.

As an output image an image with the selected average subtracted is computed and the result presented in the **Preview** window.

- If the **Apply** button is pressed, the averaged subtracted image stack will be opened as a new image in the container.



**Fig. 541** Remove structure drop down menu

You have four options that can be selected via the **Remove Structures** drop down menu (Fig. 541):

**None, Slowly moving structure, Immobile structures (+Stack) and Immobile structures (+Plane).**

If **None** is selected, no average will be subtracted and the original image is kept. If **Slowly moving structure** is activated the **Average frames** input box becomes available. Type in the required number (minimum is 2) or use the slider or arrows for input. The number defines the number of frames that will be averaged and subtracted in a gliding way from the original stack in the following way:

- From a stack of  $n$  frames take successive  $m$  moving average frames with an overlap of  $m-1$  and average these. The outcome is a new stack with  $n-m+1$  gliding or moving average frames. Calculate from each of the average frames the overall average of all pixels, which is a scalar.
- Subtract the  $i$ -th of the gliding average frame from the  $(i-1)+m/2$  original frame and add the  $i$ -th scalar. In this way, the first frame to be used from the original stack is  $m/2$  and the last  $m/2+(n-m+1)$ . This creates a new stack of  $n-m-1$  frames that is the output image.

If **Immobile structures (+Stack)** is selected, the average frame of the stack will be computed and subtracted from each original frame. This creates a new average subtracted stack of the same size. An average value of all pixels from all frames is computed, which is a scalar, and added to each pixel of the single frames of the average subtracted stack to avoid negative numbers. The resulting stack is the output image.

If **Immobile structures (+Plane)** is selected, the average frame of the stack will be computed and subtracted from each original frame. This creates a new average subtracted stack of the same size. Average values of all pixels from each of the original frames is computed, which is a scalar, and added to each pixel of each corresponding single frame of the average subtracted stack to avoid negative numbers. The resulting stack is the output image.

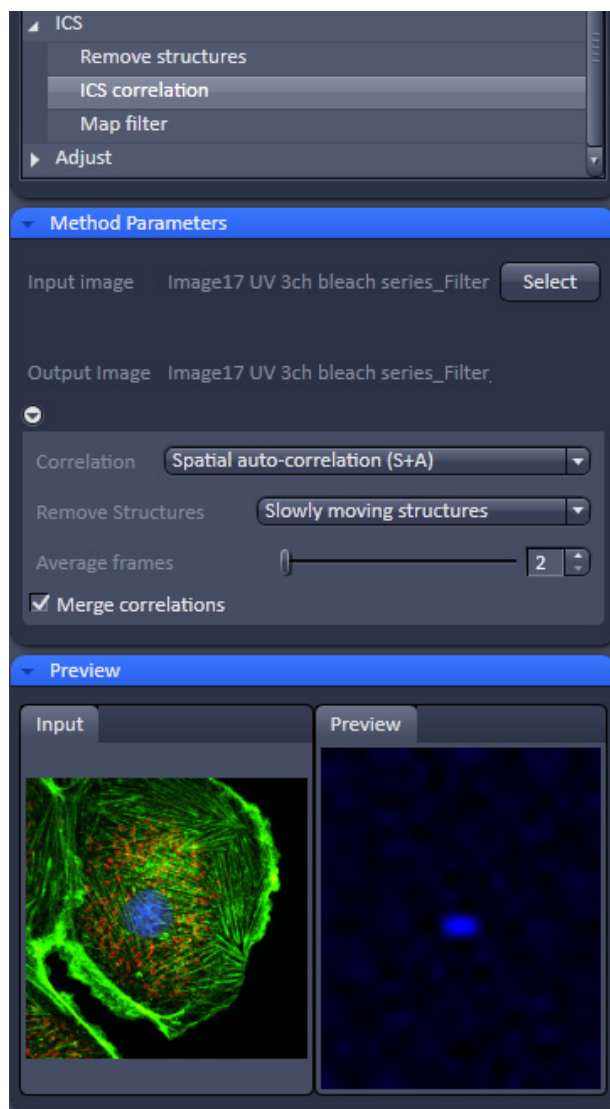


Fig. 542 Processing – ICS correlation

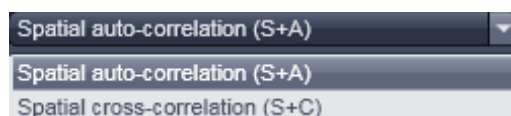


Fig. 543 Correlation drop down menu

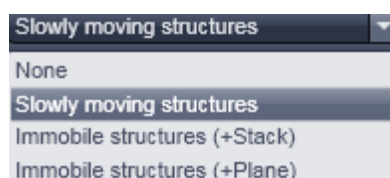


Fig. 544 Remove structures drop down menu

### 5.4.21.3 ICS Correlation

- Activate **ICS correlation** in the **ICS** tool. The **ICS correlation** menu will appear (Fig. 542).
- Highlight the image in the image container and press the **Select** button. This will be your **Input** image.
- This function is only available in the LSM imaging mode

A correlation image will be computed based on the settings and displayed in the **Preview** window. As an output image an image with the selected average subtracted is computed and the result presented in the **Preview** window.

- The correlation to be computed can be selected from the **Correlation** drop down menu (Fig. 543). For one channel recordings, only **Spatial auto-correlation (S+A)** is available, for a two channel recording in addition **Spatial cross-correlation (S+C)**.

The way of average subtraction can be selected from the **Remove structures** drop down menu (Fig. 544).

- You can select between **None** (no average subtraction), **Slowly moving structures** (subtraction of moving average, the frame size of which can be selected in the **Average frames** input box), **Immobile structures (+Stack)** and **Immobile structures (+Plane)** (subtraction of total average and adding average scalar of all pixels from one frame to each corresponding frame).



**5.4.21.4 Map Filter**


- Activate **Map filter** in the **ICS** tool. The **Map filter** menu will appear (Fig. 545).
- To select an image highlight the image in the Image container and press the **Select** button. This will be your **Input** image map.

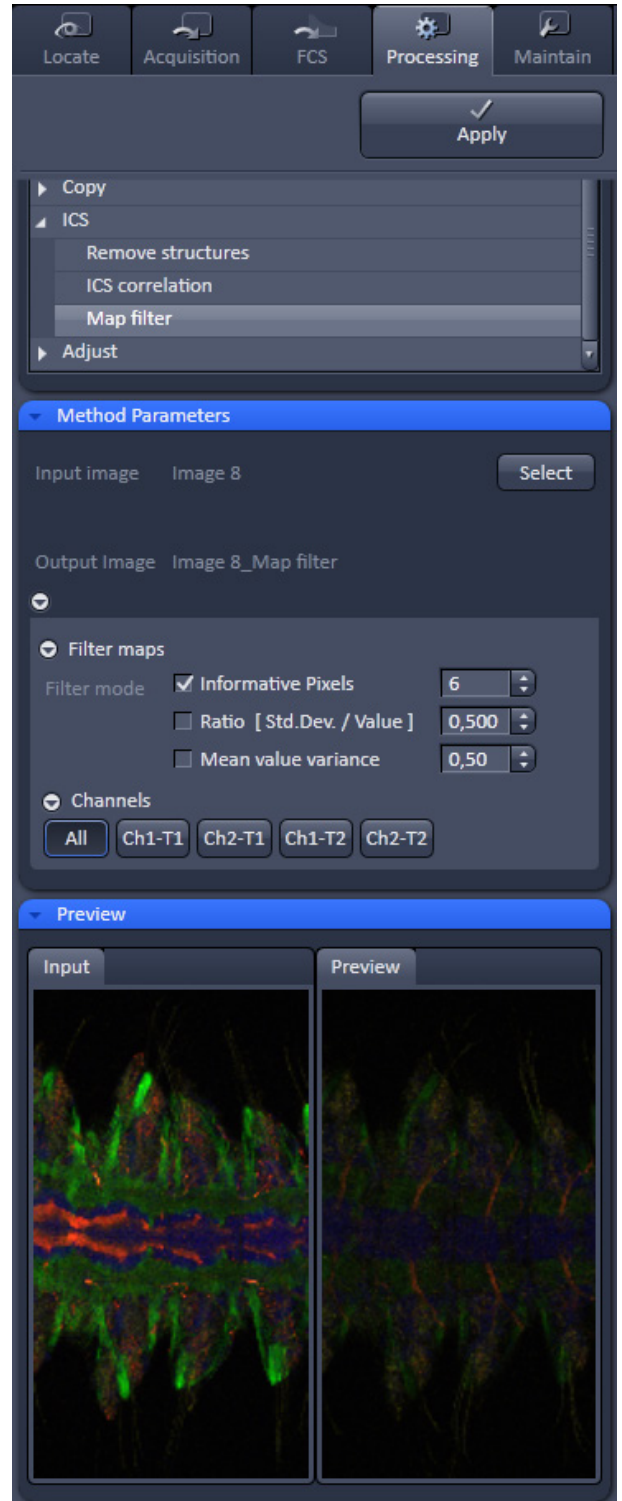
As an output image map an image map with the selected filters applied is computed and the result filtered image maps will be opened as a new image maps in the container.

The way of filters to be applied can be selected in the **Filter maps** menu, which can be opened by the arrow, by checking the **Ratio [Std.Dev./value]** and the **Mean value variance** check boxes.

 Note that both filters can be applied together by checking both boxes.

- Thresholds for the filters can be entered in the corresponding input boxes by typing or by using the arrows. Pixels with values exceeding the threshold will be displayed in black and will be discarded for the scaling of the map.
- You can define if all maps should be filtered by pressing **All** button in the available filter display area.
- If you want to apply filtering only to a specific map (**Number of particles**, its standard deviation **Std.Dev.**; **Diffusion coeff. [ $\mu\text{m} \times \mu\text{m} / \text{s}$ ]**, its standard deviation **Std.Dev.** and **X<sup>2</sup>**) the **Filter all maps** box must not be ticked and the corresponding map button pressed, which is indicated by highlighting in blue.

 Note that filtering is never applied to the **X<sup>2</sup>** map, even if it was selected.



**Fig. 545 Processing – ICS Map filter**

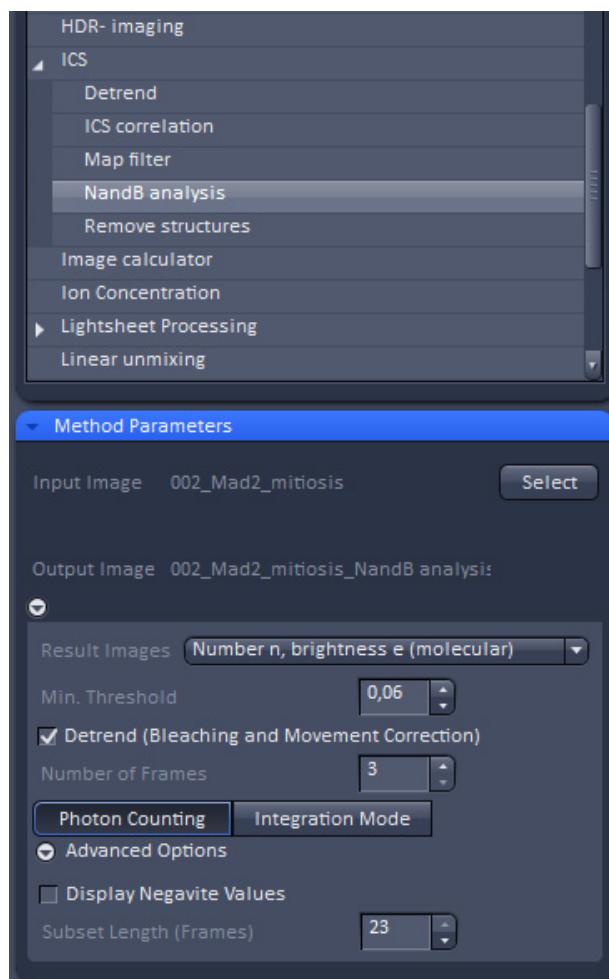


Fig. 546 NandB Method Parameters tool

#### 5.4.21.5 NandB Analysis

- The function **NandB** (Number&Brightness) **Analysis** calculates the image content in two ways:
  - It counts the photons per second per molecule referred to as the **Brightness**.
  - It counts the number of molecules referred to as **Number**.
- Click **NandB Analysis** in the **ICS** tool. The **Method Parameters** tool shows the input options for this function (Fig. 546).
- Select the desired image in the image container, then click **Select** to define this image as the **Input** image.
- The tool works with time series images which should be acquired along the following guidelines:
  - It is necessary to oversample the images in XY at least by a factor of 3 but better by up to a factor of 10. A pixel size of about 30 nm is beneficial as the method needs to be able to detect the fluctuation of the molecules within the confocal volume.
  - The imaging speed needs to be adapted to the speed of the molecules movement. For most experiments a speed of 6 or 7 (around 1 frame per second) has proven to be a fairly good setting. The scanner needs to be fast enough to "walk along" with the molecule: Too slow, and the molecule "escapes", too fast, and the molecule "stays behind".

#### For example:

EGFP (about 20nM) in buffer pH7.4:  $D=90 \mu\text{m}^2/\text{s}$  -> Set the **Pixel dwell time to 25-32  $\mu\text{s}/\text{pixel}$**  and the **Pixel size to 80-50nm**

- Within the **Method Parameters** tool the following choices can be made:
  - Result Images **Number N, brightness B (measured)**; This method calculates the apparent number of molecules N and apparent brightness of molecules B according to the following formula:

$$B = \frac{\sigma^2 - \sigma_0^2}{(k)\text{-offset}} = \frac{S^2 \varepsilon^2 n + S^2 \varepsilon n}{S \varepsilon n} = S(\varepsilon + 1)$$

$$N = \frac{((k)\text{-offset})^2}{\sigma^2 - \sigma_0^2} = \frac{\varepsilon n}{\varepsilon + 1}$$

- Result Images: **Number b, brightness e (molecular)**; This method calculates the number of molecules  $n$  and their brightness  $e$  according to the following formula:

$$n = \frac{((k) - \text{offset})^2}{\sigma^2 - \sigma_0^2 - S((k) - \text{offset})}$$

$$e = \frac{\sigma^2 - \sigma_0^2 - S((k) - \text{offset})}{((k) - \text{offset})S}$$

#### Legend for the fomulas:

$N$ and $n$	are apparent and corrected number of particles, respectively
$B$ and $\varepsilon$	are apparent and corrected brightness, respectively
$\langle k \rangle$	is the mean signal expressed in digital levels (DLs)/pixel
$\sigma^2$	is the signal variance
$\sigma_0^2$	is the readout noise
offset	is the dark signal (DLs/pixel)
$S$	is the photon conversion factor (DLs/photon)

**Min. Threshold** sets a threshold for the intensity values to be taken into account for the calculation. This is useful if the background in the image is interfering with the calculation. If the pixel value is below [peak image value x Min. Threshold], the pixel is not processed. Intensity, number and brightness are set to 0.

**Detrend (Bleaching and Movement Correction)** is a high pass recursive filter that corrects for bleaching artefacts and the (much slower) movements for example of cells. When activated, the "trend" (moving average – average over the whole time series) will be subtracted from the input time series prior to N&B analysis. **Number of Frames** is the number of images it takes for the recursive filter to decay to 1/e. Use a smaller number for detrending faster moving objects like vesicles and a higher number for detrending bleaching effects or slower cell movements.

**Photon Counting:** If the input image has been acquired in Photon Counting mode, this button is automatically set active.

**Integration Mode:** If the input image has been acquired in Integration mode, this button is automatically set active. For images acquired in integration mode the following parameters are displayed and can be adapted:

**Offset:** Is set to 0 per default and does typically not need to be changed. The value 0 is taken for photomultiplying detectors. It is the value take for the calculation (see formulas above).

**Readout Noise:** Is set to 1 per default. This is a parameter typical for PMT type detector. Other detectors like cameras do have another value. It equals  $\sigma_0^2$  within the formulas above.

**Photon Factor:** Is the photon conversion factor taken from the meta data of the image (if available) and describes the digital levels per photon ( $S$  in the formulas above).

### Advanced Options

**Display Negative Values** shifts the offset such that also negative values are displayed as a greylevel above zero.

**Subset Length (Frames)** allows to define subsets of time series and have a value processed for each subset. This might be helpful for the analysis of time series with a high number of frames.

- The resulting output image using these settings is shown in the **Preview** tool and the Preview View tab in the image container.
- Click **Apply** to process the image series. For each input channel, the analysis produces three output channels: The original intensity image, I, the Number image, N, and the Brightness image, B or, if selected, the Number image n and the brightness image e.
- Use the **Coloc** View Tab to display the result as a scatter plot where either the Number or Brightness image is plotted against the intensity image.
- The table shows the mean number or brightness value along with the mean intensity value of the total image or a selected area. This allows for example to distinguish between regions where molecules are present as monomers or dimers.

### See also the following literature for further information on N&B analysis:

Mapping the Number of Molecules and Brightness in the Laser Scanning Microscope, Michelle A. Digman et al, Biophysical Journal Volume 94 March 2008 2320–2332

Determination of Particle Number and Brightness Using a Laser Scanning Confocal Microscope Operating in the Analog Mode, ROOSHIN B. DALAL et al, MICROSCOPY RESEARCH AND TECHNIQUE 71:69–81 (2008)

**5.4.22 Processing – Adjust**

Licensing		Instrument		
✓ standard	optional	✓ LSM	✓ ELYRA	✓ Lightsheet Z.1*

Tool accepts all types of image data as input. See full description of tool set for details and potential restrictions.  
\* Except Auto Adjust Shading Correction

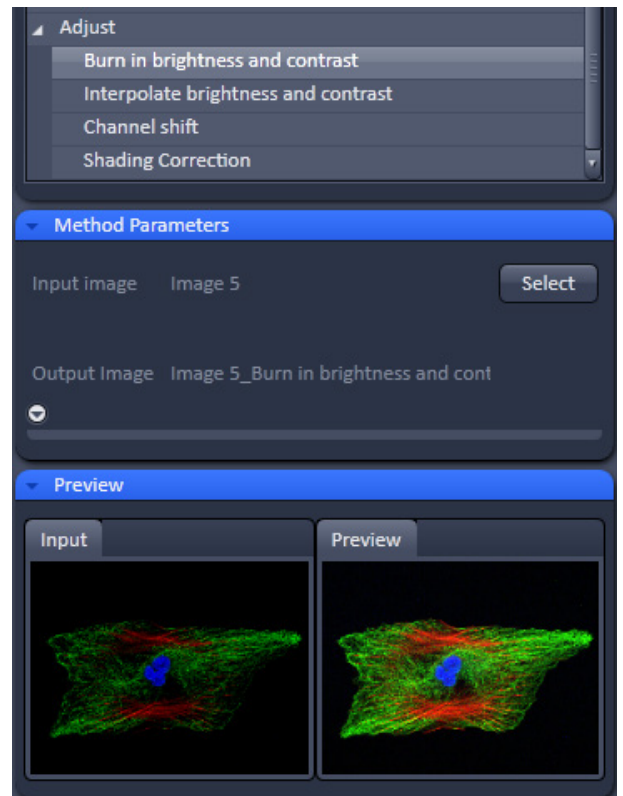
This tool allows brightness and contrast adjustments to your image as well as shifting two images against each other (Fig. 547).

**5.4.22.1 Burn in Brightness and Contrast**

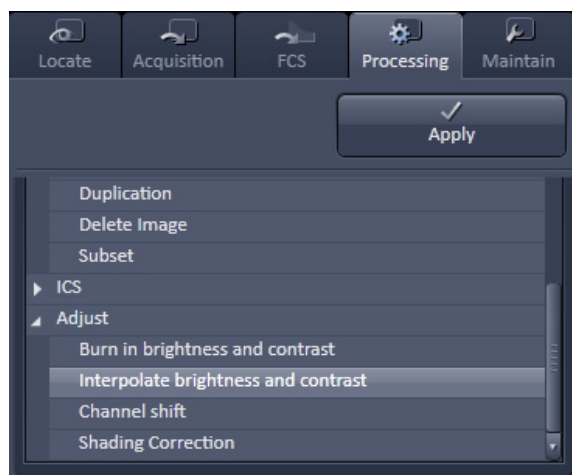
The **Burn in brightness and contrast** function creates a new image document in which the current brightness and contrast settings from the Display View Options control block (see section **Center Screen Area / Image Containers - Display and Image Analysis**) are permanently written into the image file (Fig. 547).

The **Select** button selects the active image in the **Image Display** as the Input Image to be processed.

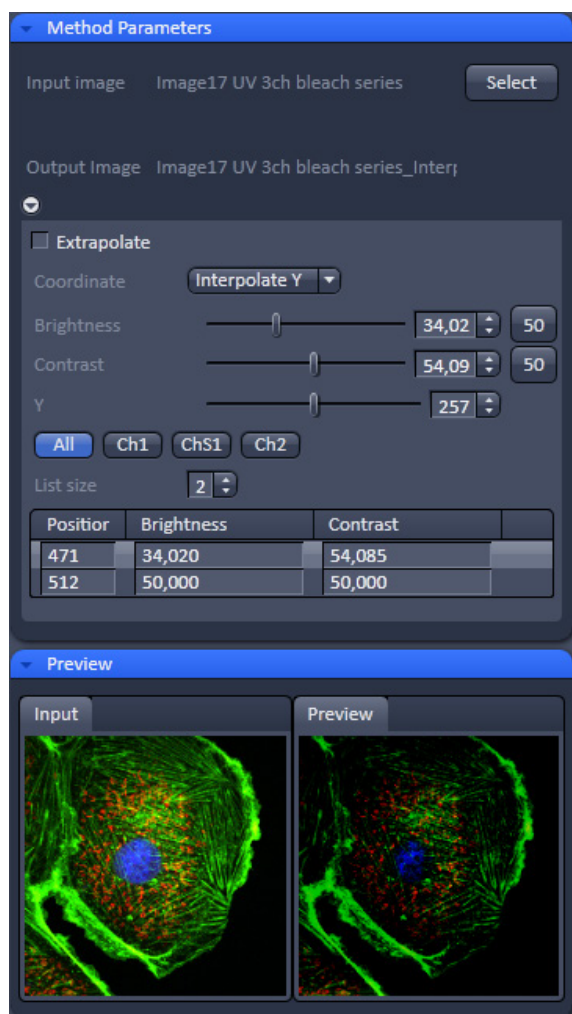
- After adjusting the brightness and contrast in the Display View Options control block, click Apply to create the new image document with the burnt in contrast and brightness settings.



**Fig. 547 Processing – Adjust with Burn in brightness and contrast**



**Fig. 548** Processing – Adjust with Interpolate brightness and contrast




**Fig. 549** Processing – Adjust with Interpolate brightness and contrast tool with loaded Z-Stack

### 5.4.22.2 Interpolate Brightness and Contrast

This function permits a continuous contrast and brightness adjustment in a Z-Stack or Z-Stacks over time by interpolation between the starting and end values of the respective image series. This permits a post-acquisition compensation of signal loss in, for example, thick tissue imaging where excitation and detection efficiency decrease significantly. Interpolation can be defined for the entire image or only for individual channels. In addition, a set of coordinates for which intensities are kept fixed during the interpolation calculation can be defined (Fig. 548).

The **Select** button selects the active image in the **Image Display** as the Input Image to be processed.


In the **Interpolation** panel (Fig. 549), the parameters for the interpolation procedure are set.

- In the **Coordinate** pull down, select the dimension for the interpolation. Depending on the image data type, x, y, z, and time are the possible options.
  - Use the **List size** spin box to set the number of fixed data points. The table in the **Interpolation** panel will be extended to the selected number of rows.
  - Highlight a row of your choice by clicking on it. Then use the **Brightness**, **Contrast** and Z (or t) slider to set the values for this fixed data point. The numbers in the table will be updated according to the slider position. Then highlight the next row, set the parameters and keep setting the fixed data points for all rows.
  - Use the available **All**, **Ch1-T1** and **Ch2-T2** channel buttons to select the channel for interpolation or click on the **All** button if the entire image is to be interpolated.
  - Having set the parameters, click on the **Apply** button. Interpolation will be performed in a new **Image Display** window.
  - The newly created image (series) can be stored using the **Save As** function.
-  If you de-activate the Extrapolate check box, only the slices lying between the first and last fixed data point (table rows) will be taken into account for interpolation. Otherwise, brightness and contrast will also be changed for the other slices.

### 5.4.22.3 Channel Shift

**Channel shift** is used to produce a congruent image with relation to the pixels of the various channels (Fig. 550).

This pixel correction function is particularly important in UV applications.

 This is a manipulation of your data that has to be considered very carefully when co-localization analysis is part of your experiment.

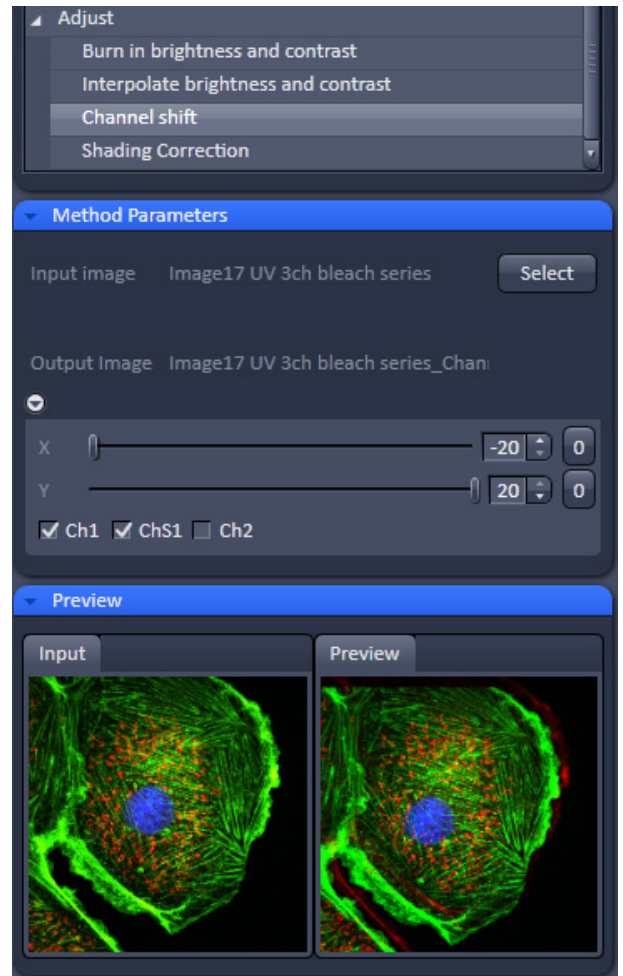
The **Select** button selects the active image in the **Image Display** as the Input Image.

The image has to be a multi-channel image.

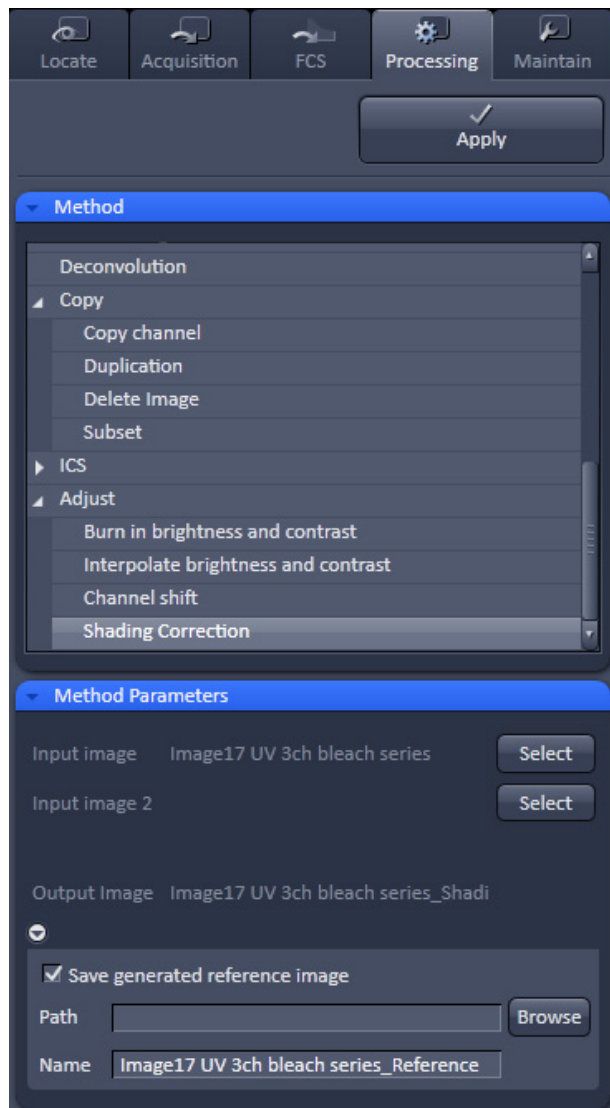
- Select the channels you want to shift by ticking the Ch1-T1 or Ch2-T2 check box:
- Use the X and Y sliders or spin boxes to define the shift in pixels to select the pixel shift in the horizontal and vertical direction. Clicking the Zero next to the spin-boxes resets the shift to the original position.

A preview is automatically generated at the bottom of the **Channel Shift** tool in the **Processing** tab of the Left Tool Area. At the same time, a large preview is shown in the **Preview** view tab in the Image display in the Center Screen Area.

- Click on the **Apply** button to generate a new image with the set pixel shift.



**Fig. 550 Processing – Adjust with Channel shift**



**Fig. 551 Processing – Adjust with Shading correction**

#### 5.4.22.4 Shading Correction

Shading Correction is a tool to manipulate images which are unevenly illuminated over the field of view. This works with single images, time series, Z-Stacks, or tiled images. Click **Shading correction** to open the interface for using that function (Fig. 551).

**Select** the image (or image series, tiled image, or Z-Stack) for which the shading correction should be applied by clicking **Select** next to **Input image**. When clicking **Apply** the system calculates a reference image from the input image(s) which is used to correct the input image(s). The corrected image is displayed in the center screen area.

In addition, the calculated **reference image** can be stored and used for further shading corrections of other images. Therefore the check box in the lower part of the tool box must be checked. Specify the folder where the image should be stored in the text box next to **Path**. **Browse** opens the windows folders from which you can select. A suggestion for the name of the image is made based on the original name of the image. Change this if needed.

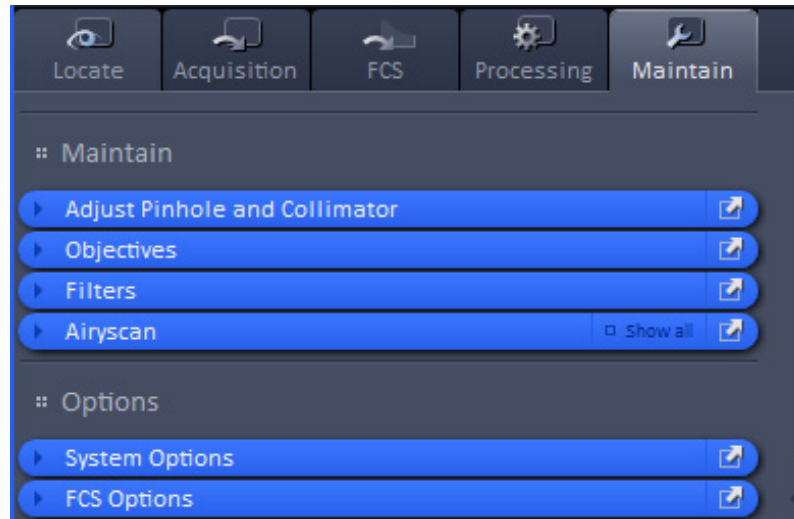
This reference image can then be loaded and selected as a reference image for the shading correction of subsequent images, which are then processed much quicker.

The reference image must be taken from an image that was acquired with identical settings for objective, zoom, image format, and orientation.



## 5.5 Maintain Tab

Press the **Maintain** tab to have access to the **Maintain** tool group area (Fig. 552). The maintain tool group allow to adjust hardware settings.



**Fig. 552** Maintain tab – tool group area

The Maintain area is divided into the **Maintain** and **Options** field.

The tool tabs in the **Maintain** field allow the calibration and adjustment of hardware settings. The following options are available:

- Adjust **Pinhole and Collimator** (for LSM imaging mode),
- Define **Objectives**,
- Define Filters for external detector modules (NDD, BiG)
- Set options for Airyscan

The tool tabs in the **Options** field allow customize hardware and software settings. The following options are available:

- **System Options**: Options for LSM and ELYRA
- **FCS Options**: Options for FCS data acquisition



**Fig. 553** Maintain tool group – Adjust Pinhole and Collimators

### 5.5.1 Maintain – Adjust Pinhole and Collimators

Expand the **Adjust Pinhole and Collimator** tab to have access to pinhole and collimator adjustment (Fig. 553).

This function is only available for the **LSM imaging** mode.

This function permits pinholes and collimators to be optimally aligned and adjusted to the used beam path. The function can be called up in the **Maintain** panel in the **Adjust Pinhole and Collimator** tool of the **Maintain** tool group (see Fig. 554).

The position of the pinhole (X-Y-Z-coordinates) in relation to the detector makes a major contribution to image optimization.

In all existing standard configurations, the pinholes have already been adjusted at the factory. These settings are taken over for active operation when a standard configuration is loaded.

If you want to create a setting that differs from the standard configurations, adjust the pinhole as follows.



**Fig. 554** Adjust Pinhole and Collimator tool

---

### 5.5.1.1 Pinholes Section Panel

The **Pinholes Section** panel has the following options:

<b>Description</b> field	Display of the relevant active channel.
<b>Diameter [μm] slider</b> <b>Position X Vis [μm] slider</b> <b>Position Y Vis [μm] slider</b> <b>Position X InVis [μm] slider</b> <b>Position Y InVis [μm] slider</b>	Setting of diameter, X-, Y- and Z-position of the pinhole in relation to the beam path (Z-position can be set only for PH1) using the slider or arrow buttons Status display for setting procedure: green for ready and red for busy.
<b>Stored Pos</b> button	Pinhole setting is reset to the position last stored.
<b>Adjustment: Adjust Automatically</b> button	Automatic pinhole adjustment (not available in some systems).
<b>Fast Adjust Mode</b> check box:	If this check box is activated, the pinhole adjustment is only performed in a limited area. Used for readjustment (not available in some systems).

No further software function can be activated and executed while automatic pinhole adjustment is running.

### 5.5.1.2 Collimators Section Panel

The **Collimators Section** panel has the following options (Fig. 555):

<b>Name</b> drop down menu	Selection of the collimator (IR / VIS or UV / VIS) to be adjusted via <b>the drop down menu</b> .
<b>Description</b> field	Display of the relevant active Collimator
<b>Position [mm]</b> field	Setting of collimator position using the slider or arrow buttons; the display to the left of the slider indicates the current position Status display for setting procedure: green for ready and red for busy.
<b>Current Position</b> button	Stores the current collimator position.
<b>Stored Pos</b> button	Sets the collimator to the stored value.
<b>Adjustment Move to Opt Pos</b> button	Starts the automatic collimator adjustment. Available for some objectives.

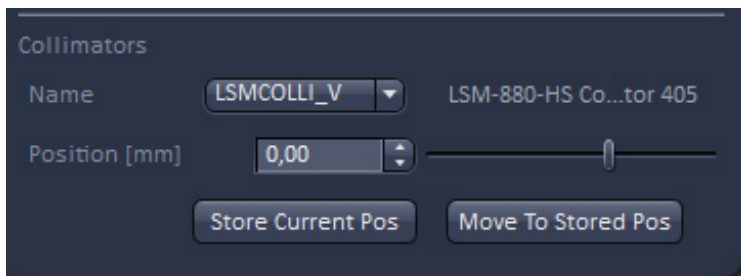


Fig. 555 Collimator section panel


### 5.5.1.3 How to Adjust the Pinhole and Collimator

Adjustment of pinholes can be performed manually or automatically.

#### Temporary optimization of the adjustment:

The position of the pinhole relative to the detector in terms of X-Y-Z coordinates contributes substantially to image optimization.

Requirements to make the influence of pinhole position changes on image brightness immediately visible:

- The image must be scanned by the continuous scan method.
  - Select a fast scanning speed.
  - Measurement with Average Number 1 only (no averaging of several measurements).
  - On the **Channels** tool in the LSM **Acquisition Parameter** tool group select the pinhole diameter so as to have the best possible image contrast (see Fig. 556).
- Open the **Adjust Pinhole and Collimator** tool in the **Maintain** tool group in the **Maintain** panel.
  - Select the pinhole to be adjusted from the **Name** list box.
  - Use the **Diameter** slider to set the smallest possible size which produces a good, high-contrast image. This setting changes the pinhole diameter.
-  Image optimization can be effected with the **Range Indicator** or in the **Line-Scan** mode.

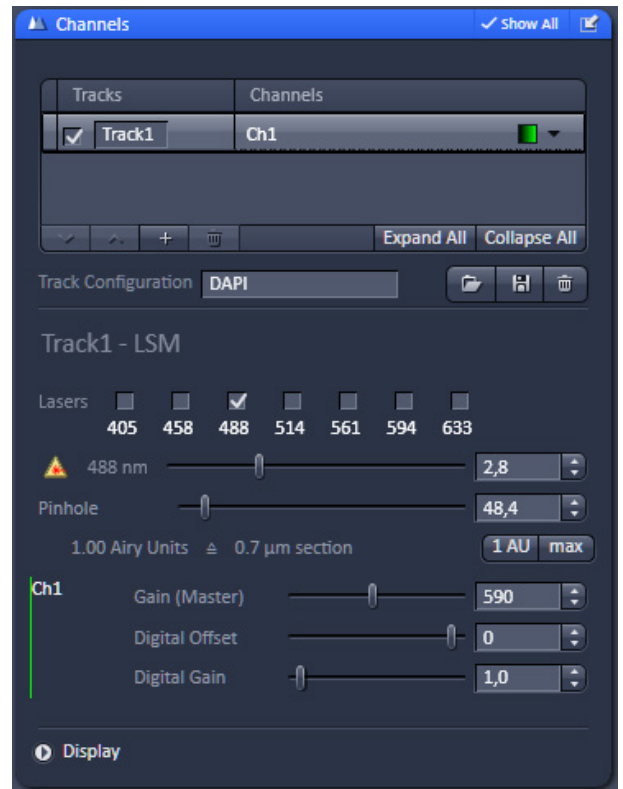
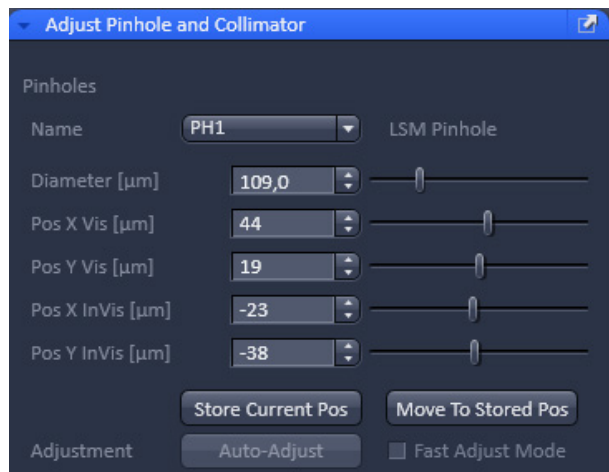


Fig. 556 Channels tool



**Fig. 557 Manual pinhole adjustment**



**Fig. 558 Adjust Pinhole and Collimator tool – Collimators panel**


- Click the LSM **Continuous** action button to start a continuous scan. Optimize the pinhole position in X, Y and Z (Z only for PH1) relative to the PMT using the **Position X [µm]**, **Position Y [µm]** and **Position Z [µm]** sliders to maximum image brightness (see Fig. 557).
- The collimation for the visible laser lines (VIS range = 458 to 633 nm) is preset and cannot be changed.

- You have access to the collimators for the inVIS lasers = UV (355 nm), 405nm, 440nm and NLO (multiphoton lasers). Each coupling port is equipped with a motorized collimating optics. Select the collimator for the port with the drop down list next to **Name** (Fig. 558). The collimators name is then displayed next to the drop down list and in the tool tip of the text.
- Moving the **Position [mm]** slider in the **Collimators** panel allows the collimator to be adjusted to maximum image brightness. Optimum collimator adjustment obtained in this way can be stored by clicking the **Current Pos** button. The Collimators are pre-set from the factory and care should be exerted by changing its position.


- Collimator positions are stored for each combination of wavelength(s) and objective. This allows to optimize settings for excitation wavelength combinations when working with lasers in the inVIS (UV or NLO) and VIS range, or for combinations of IR lines (NLO). The settings are mainly influenced by the chosen objective.
- Collimator settings for NLO lasers are set only for one wavelength when the system is installed. Store additional values if necessary for other objective / wavelength combinations by clicking **Store Current Pos**.
- Stored collimator positions are automatically set when changing wavelengths and/or objectives.


**Automatic pinhole adjustment:**

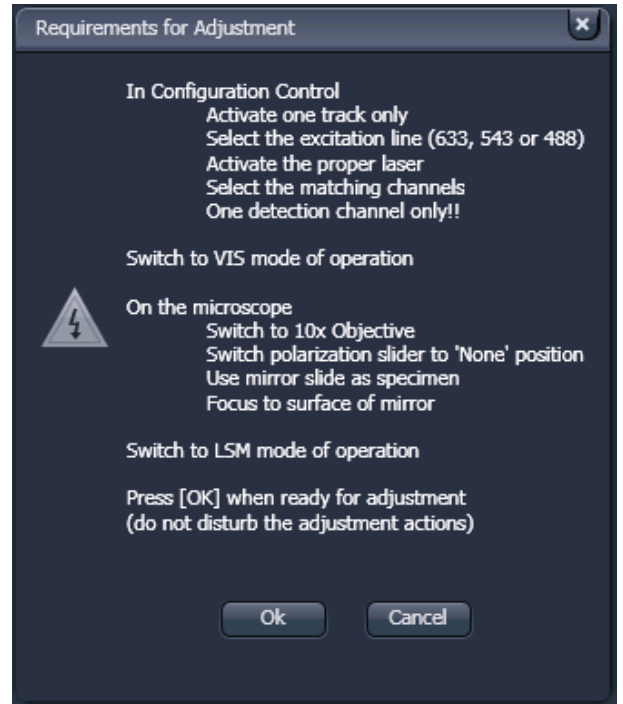
The automatic adjustment allows the pinholes to be used with any combination of beam splitters and more than one active channel.

 Please do not make any program manipulations while the automatic pinhole adjustment is running (status display is red - busy).

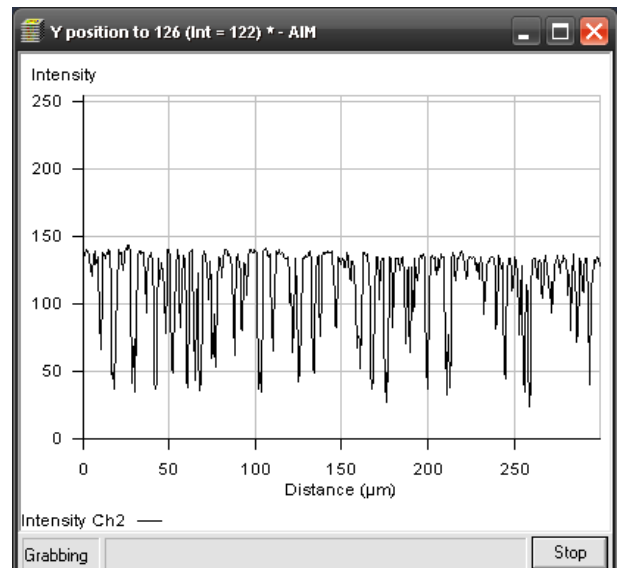
- Click on the **Adjustment Adjust Automatically** button.
  - The **Requirements for Adjustment** window will then appear.
- Meet the requirements listed in the **Requirements for Adjustment** window (Fig. 559). Press **Cancel** to abort the automatic pinhole adjustment. Press the **OK** button to proceed.
  - Pinhole adjustment will then run automatically and the Scan window will appear (see Fig. 560). The adjusting procedure takes approx. 3 min.
  - The determined data are stored automatically and will be available for all further examinations using the same configuration.

 A change of the pinhole diameter made manually in the **Pinholes section** panel will update the pinhole diameter in the **Channels** tool and vice versa.

 Pinhole adjustment should be done on a regular basis (monthly, depending on system usage).



**Fig. 559 Requirements for Adjustment window**



**Fig. 560 Pinhole adjustment scan window**

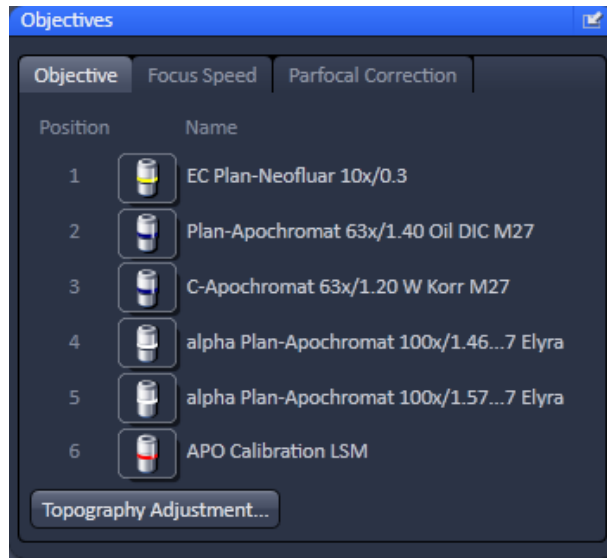


Fig. 561 Maintain tool group – Objectives

## 5.5.2 Maintain – Objectives

Expand the **Objective** tab to have access to objective definition and selection (Fig. 561).

With this function one can assign an objective to its respective position in the nosepiece, e.g. when an objective was added newly or replaced by another one without having to leave the software. Once the objective is activated its focus speed and parfocality can be set.

### 5.5.2.1 Objective

Press the **Objective** tab to have access to the Objective definition window (Fig. 561).

Press an Objective icon to have access to the **Change Objective** expansion window for the respective objective (Fig. 562) with the following functions

- Add Objective
- Show/Edit Objective
- Remove Objective
- Select objective.



### 5.5.2.2 Select Objective

Select the **Objective** tab from the **Objective** tool, which will show the **Name** of all objectives with an assigned nosepiece **Position**. If **Automatic Component Recognition (ACR)** is available the correct objective Name and Position will be updated automatically. Otherwise you have to proceed manually as follows after screwing the objective into then nosepiece:

Click on the **Objective icon** button of the respective nosepiece position, which is indicated on the nosepiece. This will open the Objective selection menu (Fig. 562).

In the Change Objective area open one of the available directories of Favorite Objectives (showing all the objectives that have been previously selected), User Defined Objectives (showing all the objectives that have been previously defined by an user) (Fig. 562) or Potential Objectives (showing all objectives listed in the used ZEN database). Expanding the field opens the respective objective list directory (Fig. 564). An expansion triangle is only available, when objectives are available in the respective directory (Fig. 562). The scroll bars allow having access to all entries in the list.

- Select the correct objective by highlighting it. Press the **Select Objective** button. Note that the button becomes only active, if an objective was selected. The Name of the objective will appear at the corresponding position.
- Click anywhere outside the expansion window to close it.

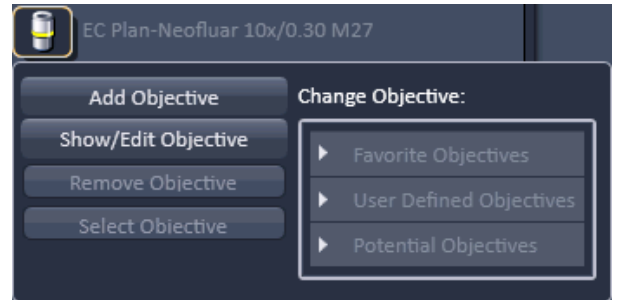


Fig. 562 Objective selection



Fig. 563 Objective selection – User Defined Objectives with empty directory

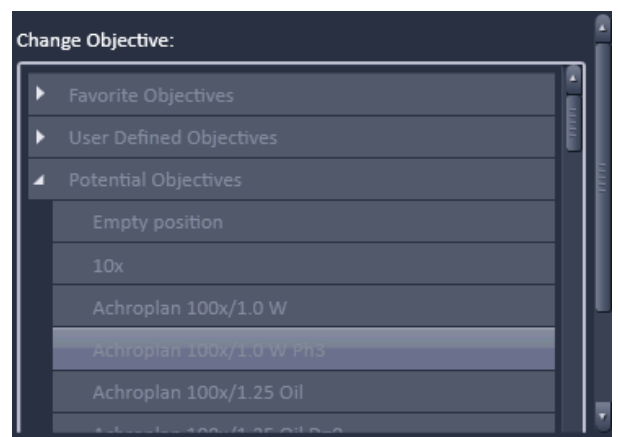
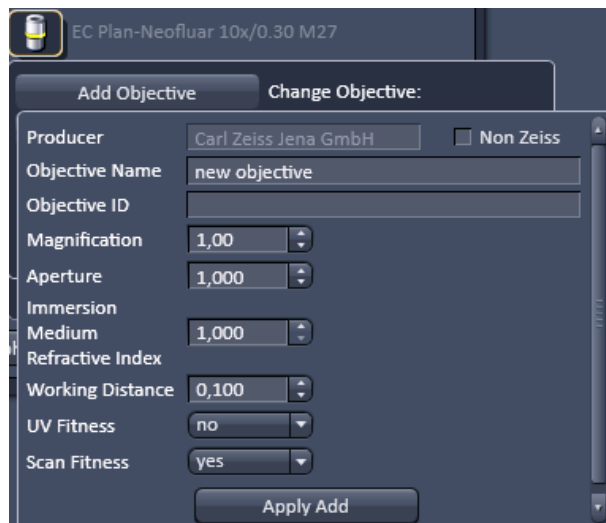
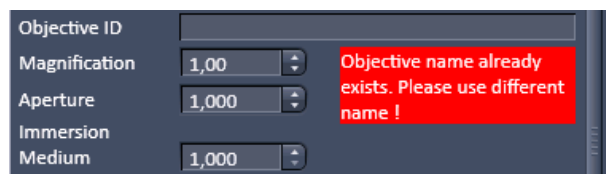


Fig. 564 Objective selection – Potential Objectives directory



**Fig. 565** Adding a new Objective – Editing field



**Fig. 566** Objective Name warning message

### 5.5.2.3 Add Objective

This function allows adding objectives to the **User Defined Objective** database.

- Click on the Add Objective buttons. The Create new Objective expansion window will appear (Fig. 565). The scrollbar allows access to the whole field.
- Enter the parameters of the new objective in the appropriate display boxes or drop down menus. The text of those boxes that are inactive for editing, are greyed.
- Press the **Apply Add** button to store the newly defined objective in the **User Defined Objective** directory.

If the **Non Zeiss** check box is ticked, objectives from other manufacturers can also be included in the database.

If the name of the objective already exists, a warning is displayed telling the user to rename (Fig. 566).

### 5.5.2.4 Remove Objective

This function allows removing objectives from the User **Defined Objective** database (Fig. 567).

Expand the **User Defined Objective** directory and highlight the objective you want to delete.

Press the **Remove Objective** button in order to delete the selected objective. Note that the Remove Objective button only becomes available, if an objective from the user Defined Objectives directory was chosen. You will be prompted to confirm to delete the objective in the **Delete Objective** pop up window (Fig. 568). Press **Yes** to delete the objective from, **No** to keep it in the database or **Cancel** to abort the process.

### 5.5.2.5 Show/Edit Objective

This function allows viewing the parameters of an objective from all objective directories. Editing the parameters is only possible for the **User Defined Objective** database (Fig. 569).

Expand the **Favorite Objective**, **User Defined Objective** or **Potential Objective** directory and highlight the objective you want to view. This will open the View tab.

In case of an objective listed in **User Defined Objective** directory, parameters can be edited within the display boxes (those parameters not to be edited will be greyed) or the drop down menus. Press the **Apply Edit** button (only available for user defined Objectives) to make the changes take effect and store the new annotations.

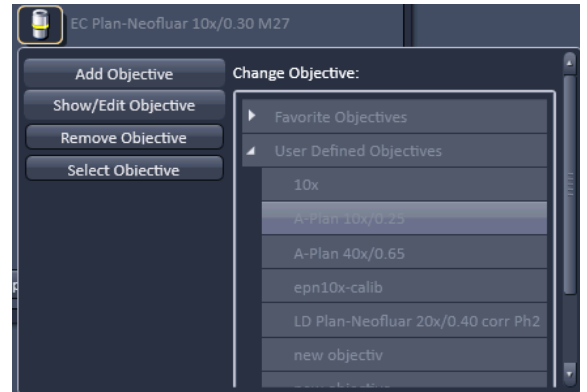


Fig. 567 Remove objective

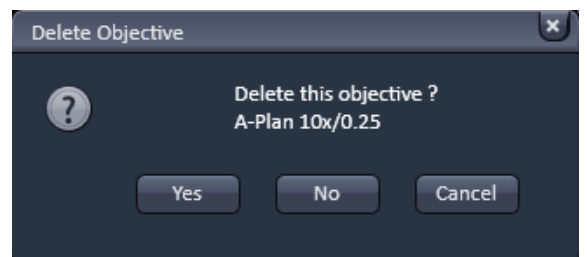


Fig. 568 Delete objective window

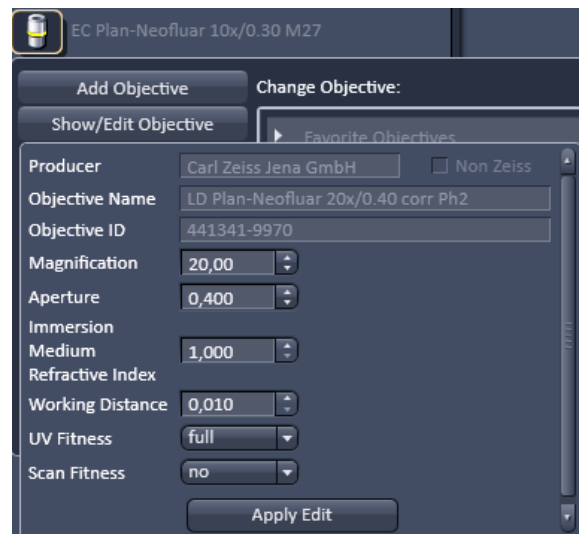


Fig. 569 Show/Edit objective

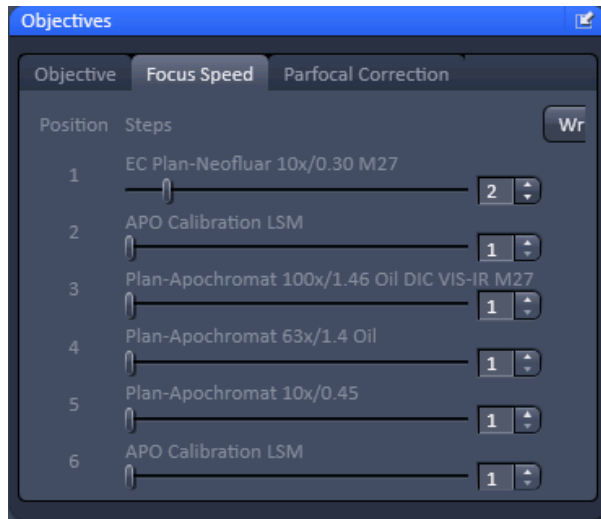


Fig. 570 Focus Speed window

### 5.5.2.6 Focus Speed

Press the **Focus Speed** tab to have access to the **Focus Speed** definition window (Fig. 570).

The **Focus Speed** can be changed for every single listed objective. Use the speed slider beneath the objective's name or the input boxes to set the speed. By pressing the **Write** button the new settings will apply for computer and manual control.

### 5.5.2.7 Parfocal Correction

Press the **Parfocal Correction** tab to have access to the **Parfocal Correction** definition window (Fig. 571).

If the **Parfocal correction active** check box is ticked in the **Activation** field the parfocal correction is active (Fig. 572).



#### CAUTION

If Parfocal Correction is in use, a motorized stage can damage your objective! A respective warning is displayed in the **Activation** field.

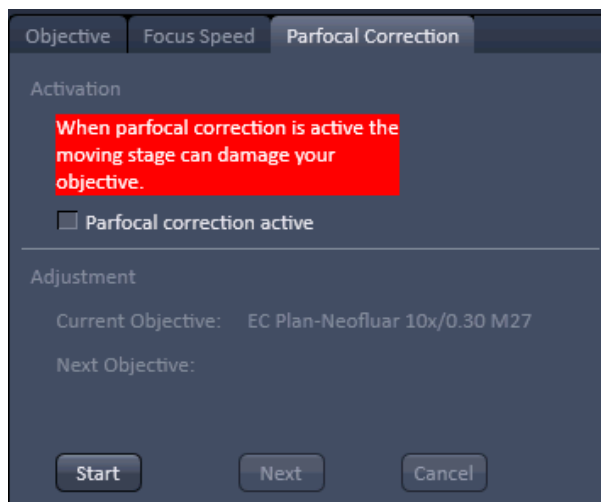


Fig. 571 Parfocal Correction window – Activation

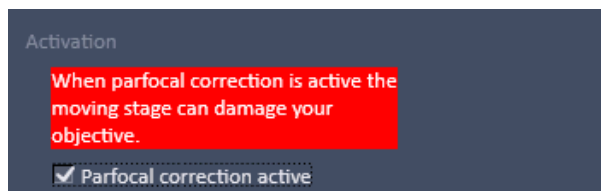


Fig. 572 Parfocal Correction window – Activation

For adjustment proceed as follows:

Position a thin sample (cell or grid) in the sample holder of the stage and focus with the first objective in the nosepiece.

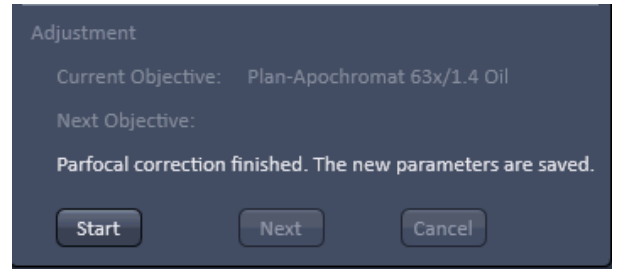
Press the **Start** button in the **Adjustment** field for adjusting the individual objectives (Fig. 573). The first objective in the list will be automatically selected and the **Start** button turns inactive. The **Current Objective** and **Next Objective** display areas list the respective objective.

A message is displayed asking the user to continue by pressing **Next**. The **Next** button only becomes available when the Start button is pressed. If **Next** is pressed the next objective in the nosepiece is selected and the parfocal adjustment performed.

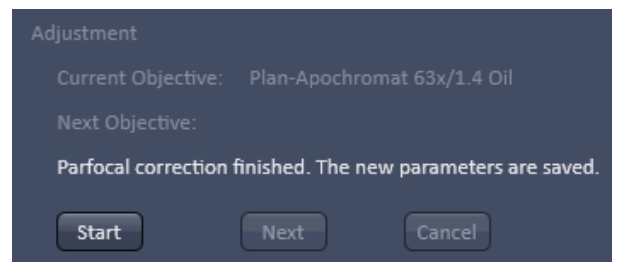
Press the **Cancel** button if you want to interrupt the Parfocal correction procedure. The **Cancel** button only becomes available when the **Start** button is pressed.

Press **Next** again until all objectives have been selected. You can cancel the process any time by pressing the Cancel button.

After the last objective has been corrected an info message informs the user that the Parfocal correction is finished (Fig. 574). The **Next** and **Cancel** buttons become inactive and the **Start** button active again. Press **Start** to repeat the Parfocal correction.



**Fig. 573** Parfocal Correction window – Adjustment finished



**Fig. 574** Parfocal Correction window – Adjustment

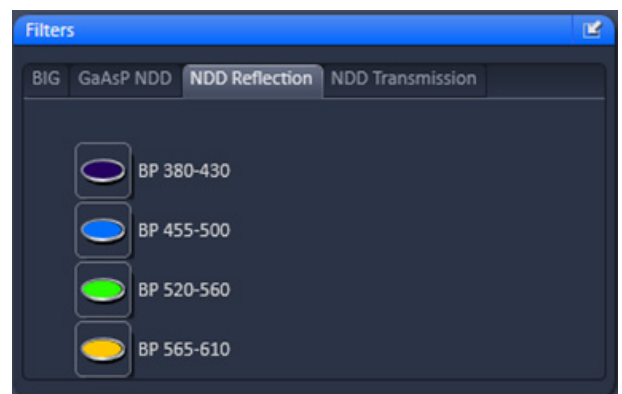
### 5.5.3 Maintain – Filters

Filters, which are changed manually by the user, have to be indicated to the software. This is necessary for some processing functions like channel unmixing.

Each tab shows the external detectors coupled to one port (**NDD reflection, NDD transmission, BiG, GaAsP NDD**).

Select a tab and click the filter icon to open a drop down list with selectable filters. Confirm your selection clicking **Ok**.

Customized filters are not listed until they have been configured using the Software: ZEN Configuration Tool (see CHAPTER 3: ADDITIONAL SOFTWARE TOOLS).



**Fig. 575** Filters tool

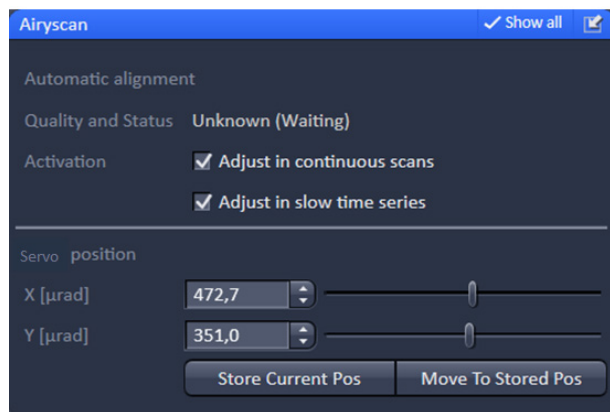



Fig. 576 Airyscan tool

### 5.5.4 Maintain – Airyscan

The **Airyscan** tool provides options for automatic alignment of the Airyscan detector.

As a superresolution detector the alignment within the detection beam path is critical and it is recommended to have both alignment options, **Adjust in continuous scans** and **Adjust in slow time series** activated at all times.

 The function will not be activated automatically upon starting the system if it has been deselected before shutting down the system. When starting the software, a message will remind you of activating the adjustment options.

**Quality and status** indicates the current status of the detector alignment.

**Unknown (Waiting):** No alignment done or possible. Make sure the Airyscan detector is activated and the gain is set high enough to detect emission light. A continuous scan allows for the self alignment to be performed.

**Bad (Waiting/Adjusting):** Automatic alignment is in progress.

**Waiting:** The system is waiting for position analysis feedback.


**Adjusting:** Adjustment is performed. During the alignment the system toggles between these two processes.

**Good (Waiting/Adjusting):** Automatic alignment is in progress. Waiting: System is waiting for position analysis feedback; Adjusting: Adjustment is performed. During the alignment the system toggles between these two processes.

For image acquisition the status should be indicated as **Good (Waiting)**.

Adjustments will only be performed during continuous scans (if activated) or during delay times of several seconds between imaging cycles of a long term time series acquisition (if activated).

To activate the automatic self adjustment of the Airyscan, make sure at least one of the automatic alignment modes is activated. The system will self adjust during continuous scans or slow time series acquisition.

 Note, that this display and adjustment is not available in VP and CO mode. To get optimal adjustment in VP and CO mode, it is recommended to switch to SR mode from time to time and run a continuous scan.

The detector view of the Airyscan tab shows the intensity distribution of the detection elements. This also allows a judgement whether the system is adjusted correctly. The brightest element should be in the center with a drop of the signal towards the periphery.

In case the detector has not been used for longer periods of time in SR mode or not at all, a continuous scan should be run for alignment before image acquisition is started in SR mode.

The sliders in the **Servo position** panel (**Show all** activated) are used to manually adjust the detector in X (**X (μrad)**) and Y (**Y (μrad)**).

A position (XY) is already stored and can be defined again as default (**Store Current Pos**). This position can be reset in case the automatic alignment fails because the detector is too far off. Click **Move To Stored Pos** and start continuous scanning again.

### 5.5.5 Options – System Options

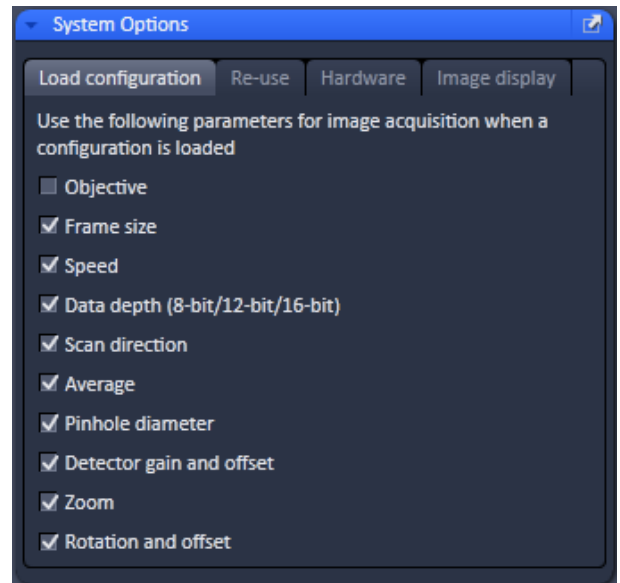
The **System Options** tool allows setting hardware parameters. Expand the tool to have access to the **System Options** setting window (Fig. 577).

The left and right pointing triangles give access to all functions by sliding the tabs to the left and right directions.

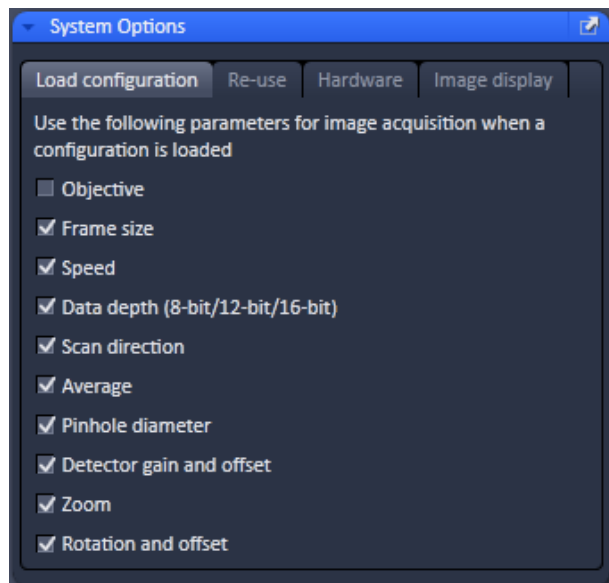
The following user-accessible program **Settings** of the ZEN software are available

- **Load configuration**
- **Reuse**
- **Hardware**
- **Image display**

Click on the respective tab or select the function from the Settings drop down menu to open the respective panel.



**Fig. 577** System Options tool



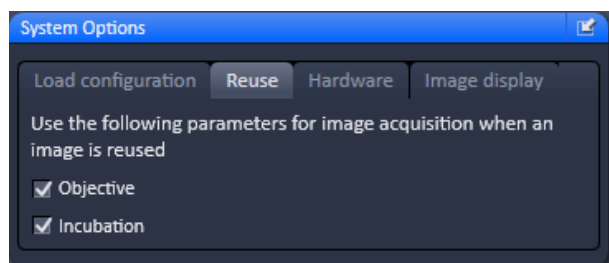
**Fig. 578** System Options – Load configuration panel

### 5.5.5.1 System Options – Load Configurations

Press the **Load configurations** tab to open the **Load configurations** panel (Fig. 578).

**Load configuration** lists parameters that, when their respective check box is ticked, will be taken into consideration when an image configuration is saved and loaded. The following parameters are available:

- Objective
- Frame size
- Speed
- Data depth
- Scan direction
- Average
- Pinhole diameter
- Detector gain and offset
- Zoom
- Rotation and offset



**Fig. 579** System Options – Reuse panel

### 5.5.5.2 System Options – Reuse

Press the **Reuse** tab to open the **Reuse** panel (Fig. 579).

**Reuse** lists parameters that, when their respective check box is ticked, will be taken into consideration when the **Reuse** button for a loaded image is pressed. The following parameters are available:

- Objective
- Incubation



### 5.5.5.3 System Options – Hardware

Press the **Hardware** tab to open the **Hardware** panel (Fig. 580).

**Hardware** lists parameters that, when their respective check box is ticked, will set several hardware defaults.


By activation of the **Lasers off on exit** check box the lasers are automatically switched off when the ZEN software is closed. The lasers are allowed to cool for five minutes before they are switched off.

By ticking the **use argon laser line selection filter wheel** (only applicable in LSM imaging mode) the line selection filter in the LSM head is used for additional excitation laser line suppression.

If the **Keep raw data for photon count detectors** (only applicable for the **LSM imaging** mode) is ticked, the actual photon counts will be assigned to each pixel and displayed in histograms. If no ticked photon counts will be converted dependent on the color depth into grey values.

The Z-Stack **Waitstate** function delays the image acquisition during time series or Z-Stacks in case vibrations of the stage occur and are registered at the beginning of individual images. The default is off. The delay is set to 350 ms. This can occur for specific image acquisition settings and is dependent on the speed, the stage and the objective in use.

**Online scanner calibration** (OSC) (only applicable for **LSM imaging** mode) assures the calibration of the scanners for uni- and bidirectional scanning is on as default setting. The default is on and it is recommended to keep the calibration on at all times. If that function is not checked it might be required to calibrate the scanners in x and y manually when bidirectional scanning is used for image acquisition. Nonlinear bidirectional distortions especially at high acquisition speeds (10-15) can only be removed by OSC.

 The function will not be activated automatically upon starting the system if it has been deselected before shutting down the system. When starting the software, a message will remind you of activating the online scanner calibration.

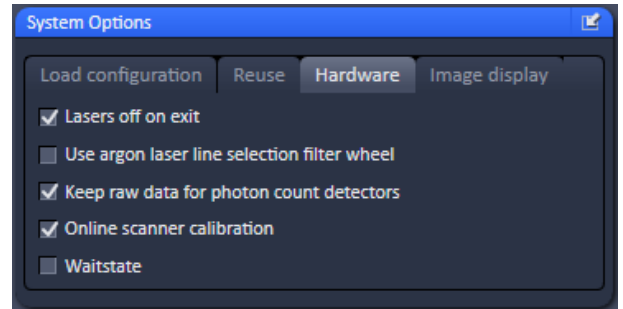
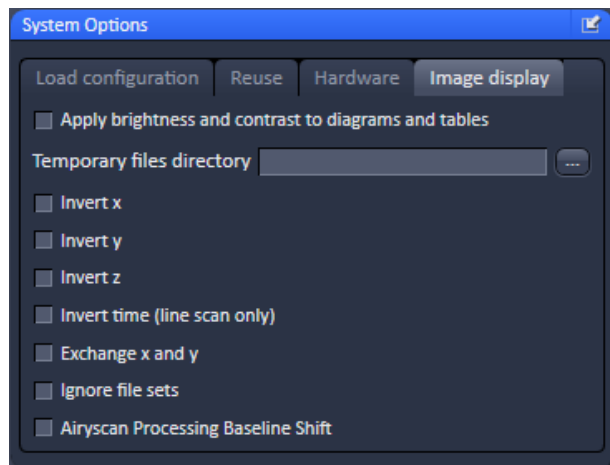


Fig. 580 System Options – Hardware panel



**Fig. 581** System Options – Image display

#### 5.5.5.4 System Options – Image Display

Press the **Image display** tab to open the Image display panel (Fig. 581).

If the Apply brightness and contrast changes to diagrams and tables is ticked any changes in brightness and contrast of the image will also affect the image data shown in diagrams or tables. If not ticked any changes in the Image Display will not affect the original image data. The default setting is off.

The Temporary files directory can be chosen manually by pressing the ... button via Windows explorer. For large datasets it is advisable to use a drive other than the C-Drive of your computer.

When ticking the **Interpolate** checkbox Interpolates the signal between pixels and thus smoothens the image. This interpolation is not saved with the original image data and can be active also during acquisition.

Ticking the **Invert x** check box will invert the x-coordinate in the display. The original data set is not changed.

Ticking the **Invert y** check box will invert the y-coordinate in the display. The original data set is not changed.

Ticking the **Invert z** check box will invert the z-coordinate in the display. The original data set is not changed.


Ticking the **Invert time (line scan only)** check box (only available in **LSM imaging** mode in **Line Scan**) will reverse the time points. The original data set is not changed.

Ticking the **Exchange x and y** check box will exchange x for y coordinates and vice versa. The original data set is not changed.

**Ignore file sets** provides the possibility to open all files, including the master file, as a separate file. Master files are generated when images are saved in individual files along time point, stage position, tile, Z stack position and/or channel. This is defined within the Autosave Tool. Per default the option is not active and such subfiles are opened as one file if the master file (the first file set of all) is opened. Only the subsequent files can be opened individually unless this function is active.

Note: When a file set is opened via the masterfile and modified (i.e. cut region, subset etc.) and then saved again, the new data set will be saved only in one file and not in file subsets like the original data.

**Airyscan Processing Baseline Shift** sets the values of the histogram in the Display function tab of the Airyscan View tab to a new grey level baseline of 10.000. Negative values will be displayed as being smaller than 10.000 and can be displayed if wanted. If this function is inactive, negative values will be cut from the histogram and the baseline is set to 0.

 For changing this setting you have to (store and) reload an image.

Due to the nature of the Airyscan detection and the signal reassignment to the respective airy orders, the display curves (histogram) of the processing preview are complex and have a wide dynamic range, though the majority of the signal will be at a small number of grey values. To get a balanced view, the display settings are adjusted automatically. Also, a baseline shift will be set. By default, this **Airyscan Processing Baseline Shift** checkbox is activated.

Optionally, this baseline shift can be deactivated. This allows the display of negative intensity results of the processing. Such results will be displayed in the range from 0 to 10,000 in the grey range histogram.

### 5.5.6 Options – FCS Options


Open the **FCS Options** tool (Fig. 582). The tool has three tabs:


- Data,
- Measure,
- Auto Save.


#### 5.5.6.1 FCS Options – Data


##### Saving Raw Data During Measurement

If the **Save raw data during measurement** check box is activated (Fig. 582), raw data will be saved temporarily in a specified directory on disc (Fig. 583). Each single measurement will be saved in a single raw data file. The name of the raw data file is an identifier to the .fcs measurement it belongs and the channel. This option is used when access to the raw data is required to analyze the data in a different way in respect to correlation and PCH settings or within other programs.

 If the check-box is de-activated, no raw data will be saved.

 Temporary raw data will be deleted from the specified file upon closing the Image FCS diagram. You will be prompted in the **Save raw data** dialog box, if you want to save the raw data. Press **Yes** to save the raw data permanently along with the .fcs file in a specified directory, which can be defined in the **Save** dialog box. Press **No** to discard the raw data. Note that raw data are saved along with the .fcs measurement file in the same folder. They are attached to the .fcs file via a relative file path. If you save the same measurement again without the option **Save Raw Data**, then the raw data files will be reassigned an absolute file path and the connection to the .fcs file is lost.

 Please note, if the **Auto safe** checkbox is ticked in the **Auto Save** submenu, temporary raw data will be stored permanently and have to be deleted manually. Care has to be taken to avoid disc space limitations, since raw data files can be huge.

 Each single measurement is stored in one raw data file. For two channel experiments, each channel will be stored in a separate file.

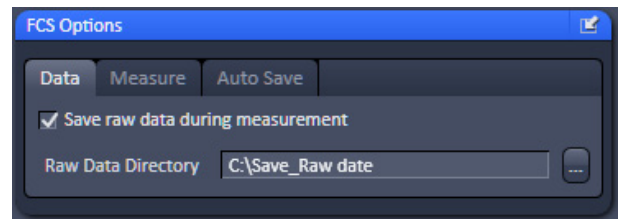


Fig. 582 FCS Options, Data

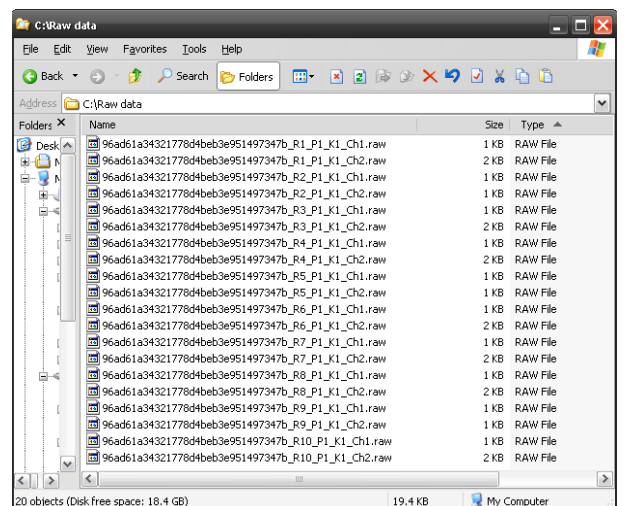








Fig. 583 Stored temporary raw data

-  The names of the raw data files are identical to the .fcs measurements, when stored along with them plus an extension that characterizes the measurement. Temporarily stored raw data do not contain the measurement name and have only the extensions.
-  If you store a measurement along with the raw data, but than a second time without, the connection between the .fcs and .raw files is lost. Instead of a relative directory location an absolute directory location is assigned to the .raw data files. When opening the .fcs file, no manipulations will be possible in this case.
-  You can open raw data in the File menu of the **Main tool** bar. You can either open the whole .fcs measurement, in which case all raw data will be loaded, or you can select single .raw data files.

### Raw Data Formats

Raw data files can be opened directly. They are also opened automatically if linked to an .fcs measurement. In this case all raw data files associated with the .fcs file will be opened in the same window.

-  Raw data are not automatically stored in a permanent way.
-  Raw data formats are up compatible, but not down compatible. Hence the old raw data format can be read in the newer Software versions but not vice versa.
-  The sampling rate is set to 15 MHz. Depending on the detector used for FCS measurements, a maximum data rate of up to 16 Mbyte/sec is achieved.

The recorded word has the following structure (Fig. 584):

Bit	Meaning
0 (LSB) ... 7	clock counter value (starting at 1) during the triggering event trigger events are pulse recordings or counter overruns zero is reserved and only transmitted at the end of the measurement
8	1, if pulse recorded in channel 1 during cycle bt1; else 0
9	1, if pulse recorded in channel 2 during cycle bt1; else 0
10	1, if pulse recorded in channel 1 during cycle bt2; else 0
11	1, if pulse recorded in channel 2 during cycle bt2; else 0
12	1, if pulse recorded in channel 1 during cycle bt3; else 0
13	1, if pulse recorded in channel 2 during cycle bt3; else 0
14	1, if pulse recorded in channel 1 during cycle bt4; else 0
15 (MSB)	1, if pulse recorded in channel 2 during cycle bt4; else 0

**Fig. 584 Structure of the recorded word**

Two examples should make the format clear (Fig. 585). The tables show part of the running pulse train (from left to right) divided into clock cycles. "1" in the corresponding box indicates that a pulse arrived in this cycle. The "counter" row shows the counter readings. The lowest row indicates when the word has been recorded.

				bt1	bt2	bt3	bt4								bt1	bt2	bt3	bt4		
CH 1				1		1						...								
CH 2					1							...								
counter	120	121	122	123	0	0	0	1	2	3	4	...	254	255	0	0	0	1	2	
							↑ W1										↑ W2			

Example 1

				bt1	bt2	bt3	bt4								bt1	bt2	bt3	bt4		
CH 1				1		1						...				1				
CH 2												...					1			
counter	120	121	122	123	0	0	0	1	2	3	4	...	254	255	0	0	0	1	2	
							↑ W3										↑ W4			

Example 2

**Fig. 585 Examples of the recorded word**

**Example 1 - The following words will be recorded:**

- at W1:  
high byte: 00011001(bin) = 19 (hex); low byte: 123 (dec) = 7B (hex); resulting word = 7B19 (hex)
- at W2:  
high byte: 00000000(bin) = 00 (hex); low byte: 255 (dec) = FF (hex); resulting word = FF00 (hex)

**Example 2 - The following words will be recorded:**

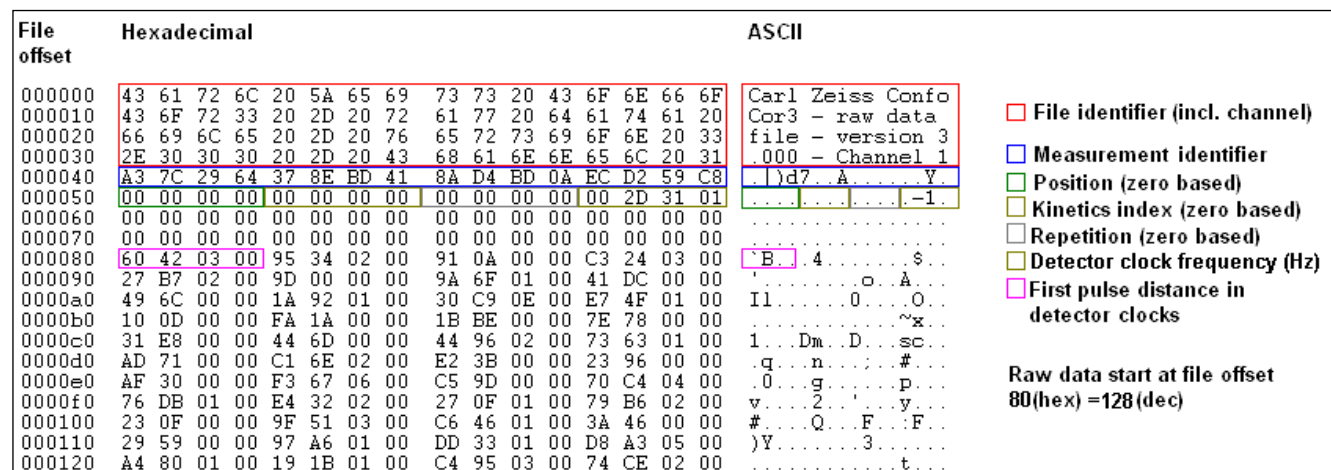
- at W3:  
high byte: 00010001(bin) = 11 (hex); low byte: 123 (dec) = 7B (hex); resulting word = 7B11 (hex)
- at W4:  
high byte: 00100100(bin) = 24 (hex); low byte: 255 (dec) = FF (hex); resulting word = FF24 (hex)

The first 30 bytes of the raw data file contain the comment "ConfoCor\_x\_-\_Raw\_data\_file\_1.0" and have to be ignored.

**LSM Rel. 4.x and all ZEN versions**

This format is already processed into one that describes the time distance between photons.

The format is explained in Fig. 586. The figure displays the raw data in an editor that shows the raw data in file offset, hexadecimal and as ASCII.



**Fig. 586 Rel. 4.x and ZEN raw data format**

The first 64 bytes (bytes 0-63) represent the file identifier with the channel number.  
 The next 16 bytes (bytes 64-79) is the measurement identifier. The identifier is a randomly created number that will be assigned to all channels, repetitions, positions and kinetic indices of the same measurement. Hence, in a cross-correlation experiment, the two auto-correlation pairs that belong together can be identified.  
 The next 4 bytes (bytes 80-83) encode the position of the measurement and are zero based.  
 The next 4 bytes (bytes 84-87) encode the kinetic index and are zero based.  
 The next 4 bytes (bytes 88-91) encode the repetition number and are zero based.  
 The next 4 bytes (bytes 92-95) encode the detector frequency in Hz.  
 The next 32 bytes (bytes 96-127) are reserved for comments and set to 0.  
 The next 4 bytes (bytes 128 -corresponding to a file offset of 7F (hex)=127 (dec)-to 131) code for the first pulse distance in detector clocks.  
 The next bytes (starting from byte 132) code for follow up pulse distances.

### 5.5.6.2 FCS Options – Measure

#### Move Stage During Measure

If the **Move stage during measure** check box is activated, the stage will move during a measurement (Fig. 587).

This option allows you to move the stage forth and back during the entire measurement time. This option is useful during rare event detection when large, slowly moving objects in extremely small concentrations have to be registered. Since these aggregates are diffusing very slowly without such movement the measurement times would be prohibitively long. It should be taken into account that, in this case, the data stream is analyzed with the coincidence analysis rather than by correlation analysis.

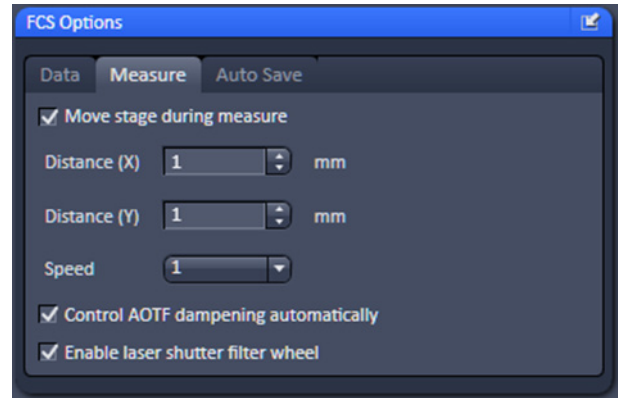



Fig. 587 FCS Options, Measure

If the **Move stage during measure** check box is ticked, the following settings are possible in the dialog:

- Travel distance of the stage in millimeters: Only integer numbers of millimeters are possible. Type into the **Distance x** and **Distance y** display boxes or use the arrowheads.
- Speed of the stage: Only the three preset stage speeds 0.48 mm/s, 4.81 mm/s and 24.01 mm/s are possible. Select 1, 2 or 3 from the **Speed** dialog box using the pull down menu.
- Travel direction: The stage can be moved along the x- or y-axis of the stage. In this case the value in **Distance x** or **Distance y** are set to 0, respectively.

 Turning points in the stage movement and turbulent medium can cause correlation signals. Watch out for these artifacts.

#### Control AOTF Dampening Automatically



If the **Control AOTF dampening automatically** check box is ticked, the laser AOTF setting will be extended into the lower dynamic range. Please note that in case two activated laser are set at different ranges, the one in the lower range will be set to the lowest available AOTF of the higher range.

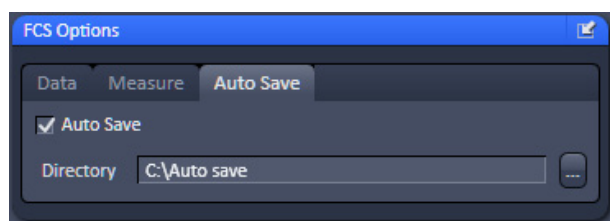
If the box is unchecked, the AOTF can be suppressed overall by a certain percentage. By moving the slider of the **AOTF Power (%)** selection box, the respective dampening factor can be set.

## Enable Laser Shutter Filter Wheel

If additional shutters (before the HeNe lasers and DSSP lasers and a line suppression filter wheel for the Argon laser) are available in the laser module, they can be activated by checking the **Enable laser shutter filter wheel** check box.

In this case, if the HeNe and DSSP filters are not used, a shutter will be placed in front of them; a line selection filter will be used for the laser line activated for the Argon laser.


-  If activating more than two lines of the Argon laser, no line selection filter will be used.
-  This function is recommended when measuring close (within 0.2  $\mu\text{m}$ ) to the cover slip glass to suppress any residual excitation light.

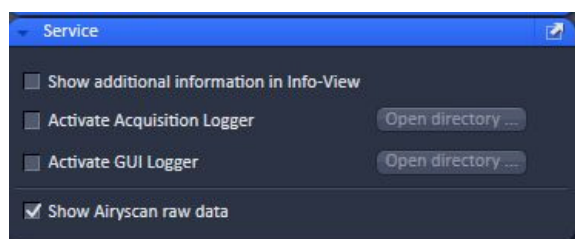


**Fig. 588** FCS Options, Auto Save

### 5.5.6.3 FCS Options – Auto Save

The **Auto Save** panel (Fig. 588) enables you to instruct the program to save the results automatically and continuously during the measurement process. All data recorded until a for example a software failure will be available this way. This function is recommended when performing long measurements. If the **Auto Save** check box is ticked you can specify the directory in the **Directory** selection box, to which the measurement should be saved.

-  Only .fcs and hence ANSI format files are saved in this directory. .raw data files are still saved in the directory specified under **Save raw data during measurement**. However, if the **Auto Save** option is active, temporary raw data files will be saved permanently and not only temporarily and will be available if a software failure occurs. The **FileName** entry indicates that .fcs files will be saved. This entry cannot be changed.



**Fig. 589** Options, Service

### 5.5.7 Options – Service

Only for service use.

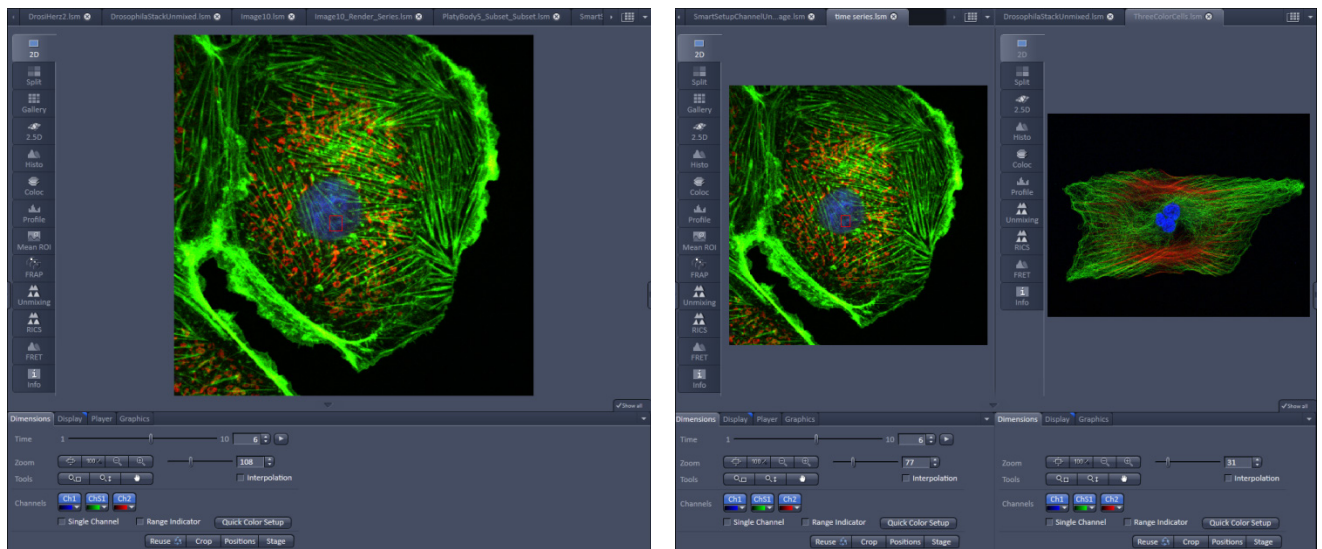


## 6 Center Screen Area / Image Containers - Display and Image Analysis

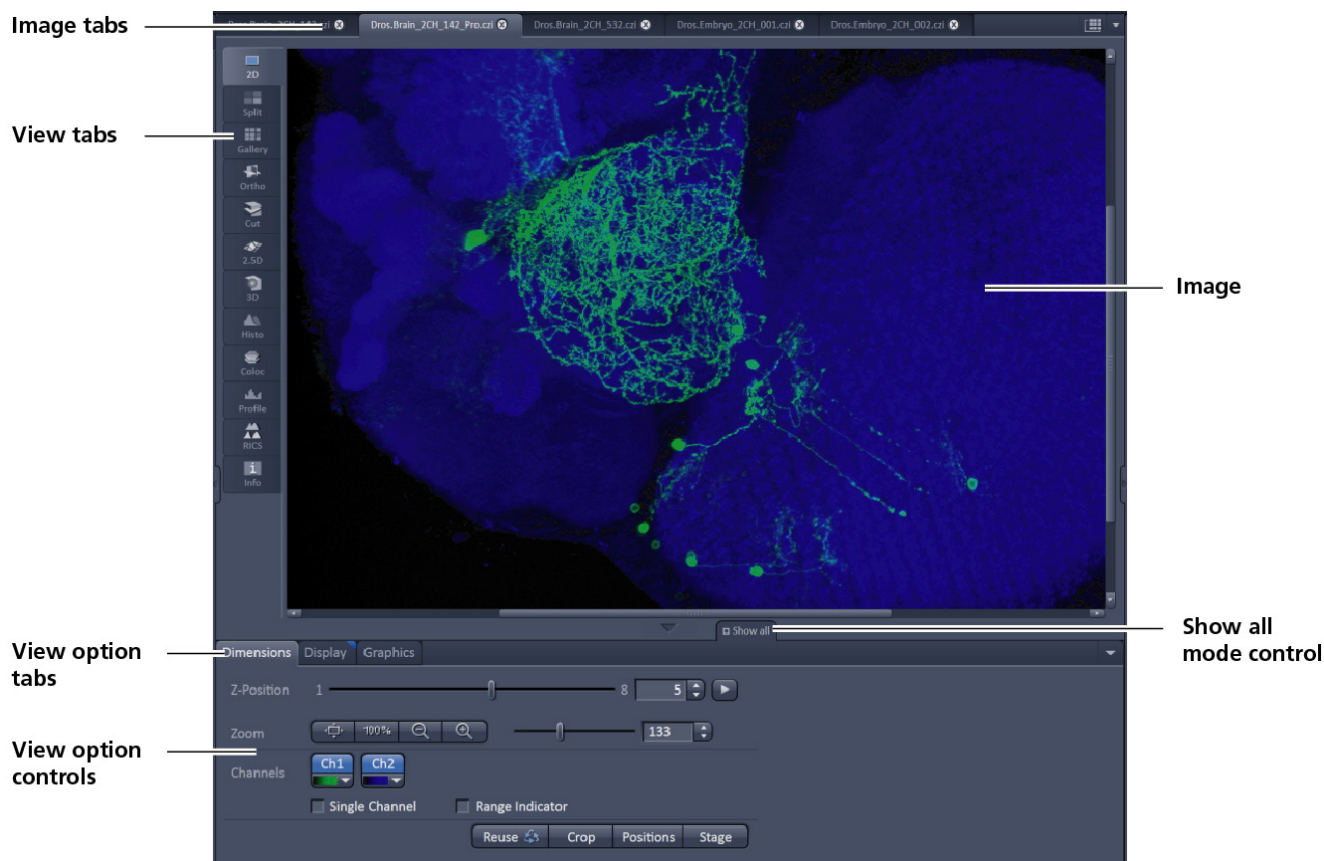
### 6.1 Structure and Functional Concept of the Center Screen Area and the Image Display Container

#### 6.1.1 General Structure

In this section, the Center Screen Area of the **ZEN Main Application** window is described. The **Center Screen** area can be set up to hold 1, 2 or 3 **Image Containers**. Fig. 590 shows the layout with one or two Image Containers.




**Fig. 590** The Center Screen Area of the ZEN Main Application window – Left: 1 Image Container, Right: 2 Image Containers



**Fig. 591 Image Display window – image tabs show options**

### View tabs:

The View tabs make all viewing options and image analysis functions directly available from the main view. Switching from one View tab to another, changes the view type for the currently active image, keeping the image in the foreground. This avoids several display windows for different analysis tools and keeps all information always right at hand.

 After switching between several open images, upon returning to a previously activated Image tab, the image document "remembers" which view type was activated before and displays the same parameters upon return to this image.

### Image tabs:

The Image tabs show every opened window so they are easy to find and access even when the **Open Images** panel in the **Right Tool Area** is hidden/minimized. This way of organizing open images avoids the problem of many opened image display windows lying on top of each other. The **Image Container** concept allows large numbers of images open at the same time and having them all easily accessible while keeping the workspace organized and tidy. **Image** tabs can show the image file name only (Fig. 592/a), the name and a small image thumbnail (Fig. 592/b) or the file name and a larger image thumbnail (Fig. 592/c). This can be configured in the Container Context menu (see Fig. 594).

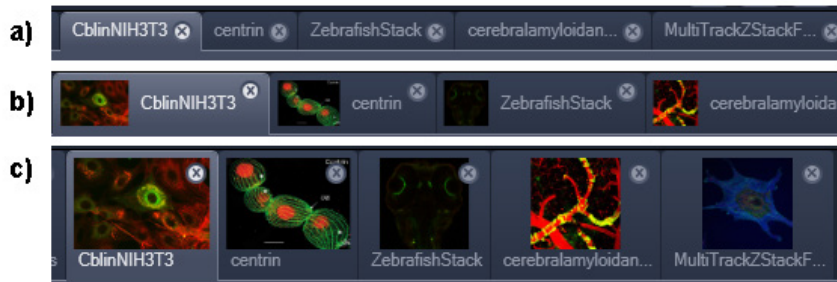
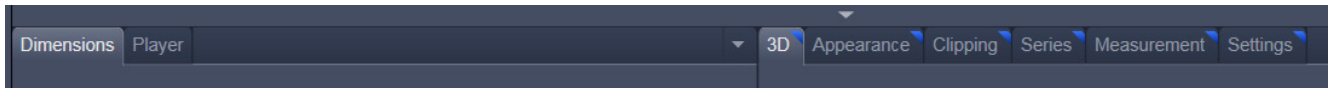



Fig. 592 Image Display window; –image tabs show options

### View Option control tabs:

These tabs allow individual activation / deactivation of the available **View Option** control blocks by clicking on the tabs. Available but hidden View Option Control tabs are grey. Active tabs are displayed in front of the others:



### The **View Option** control tabs:

The **View Option** control tabs are placed in the area under the image display. Each block hosts functionally related tools for image analysis, display modification and data manipulation. There are two groups of **View Option** control tabs: A general one which contains the blocks **Dimensions**, **Display**, **Player** and **Graphics**. The second group consists of **View** tab-specific tool tabs hosting tools that are functionally linked to only one view type. The View tab specific control tabs are marked with a blue triangle on their upper right corner.  The control tabs of the general group and their respective tools are described in the section for **2D View** (the first and default **View** tab).

### Tab mechanics:

All tabs of the two groups can be dragged out of their groups and placed freely in the **View Options Area**. Where ever it is possible to drop a grabbed tab – the underlying area is displayed in blue:

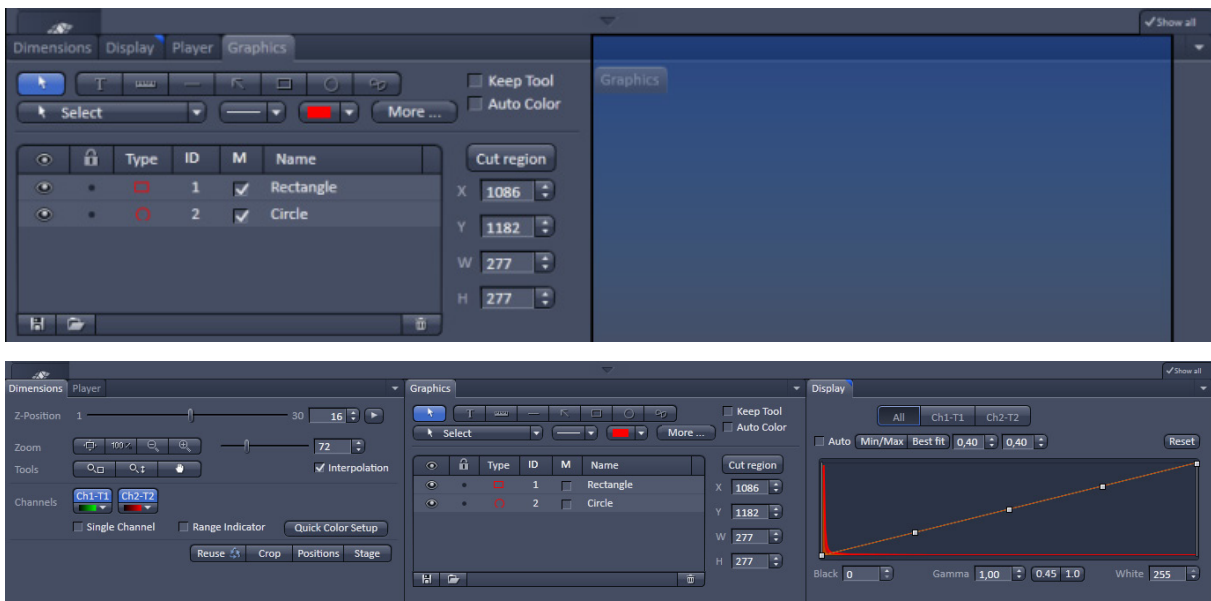
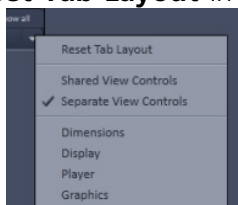


Fig. 593 General View Options control blocks

In order to reset the tab layout – use the entry **Reset Tab Layout** in the context menu or click on the



triangle  to access the View Options Area menu.

**Show all mode of the View Options Area:**

Activating the **Show all** mode  of the View Options Area has two effects:

- a) In every view options control tab all the available tools are shown; de-activating the **Show all** mode hides less often used tools.
- b) All available view options control tabs are shown; de-activating the **Show all** mode hide less often used tabs.

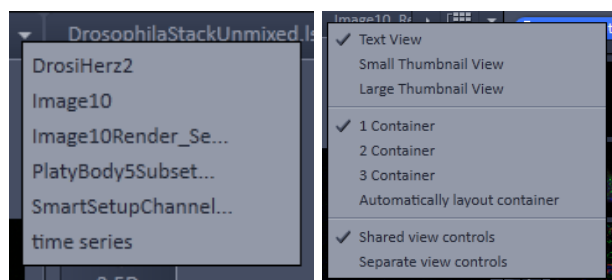
Any changes done with these tools have immediate effect on the image display but not on the saved data. To permanently store your results you have to save the data as described in section **Processing – Copy**.



**Fig. 594** Control area of the top of the image container

**Image Handling and Container Layout Configuration:**

The control area (Fig. 594) on the top right corner of the Image Display is for scrolling (click on the left or right triangle button) and listing the Image tabs which cannot be displayed if too many images are opened (left click on the down triangle).



**Fig. 595** Open Image pull down menu (left) and context menu of the Center Screen Area (right)

This is just an alternative way of handling the open images (Fig. 595, left).


The main tool for this purpose is the **Open Images** panel (see section **Right Tool Area, Data Management and Storage**).

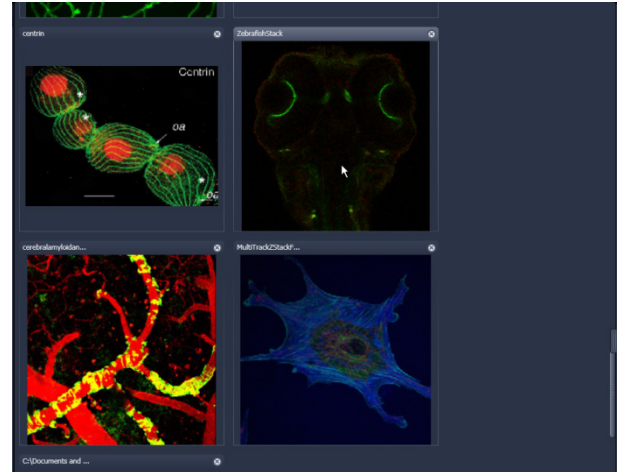
A right click on the image tab row opens the context menu (Fig. 595, right). for the layout of the Center Screen Area.

**The Image Display:**

The Image Display contains and displays the image data or –depending on the active view type – a combination of image data, overlays, graphs and tables. The content is automatically maximized to the available image or display size.

**Expose Mode:**

Clicking the **Expose Mode** button  in the top right corner of the Image Display opens a field of thumbnails in the image display with one large thumbnail for each open image. Whenever you lost track of your open images, open the Expose Mode and click once in the image you are looking for and it will be immediately brought to the foreground of the Image Display (Fig. 596).

**Fig. 596** Expose Mode Display**6.1.2 Container Configuration with the Container Context Menu**

Clicking on the container background with the right-mouse button opens a context menu for:

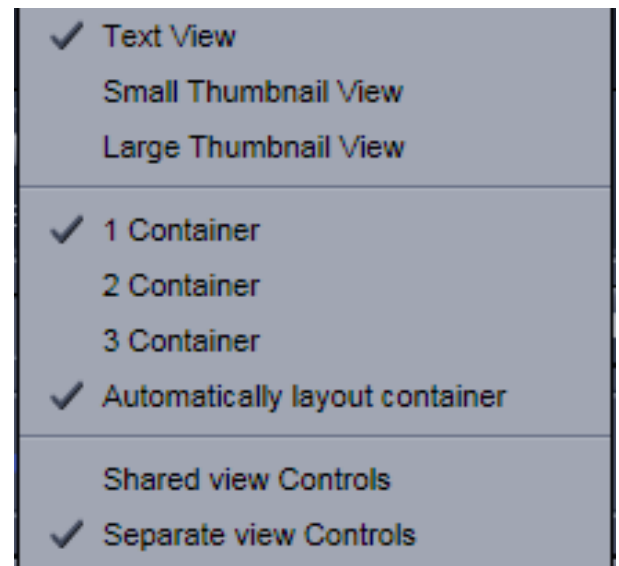
- setting the view for the Image tabs (see above),
- choosing to split the Center Screen Area in 1, 2 or 3 containers and setting the automatic container layout
- choosing between separate or shared view controls between the containers.

The same menu is available in the menu bar in the **View** part of the menu.

Splitting the Center Screen Area in several containers has the advantage that side-by-side comparison of image data becomes very easy.

The disadvantage is that the individual container necessarily becomes smaller. Up to 3 containers can be chosen. The "Automatically layout container" option is switched on by default and fixes the container width in layouts with multiple containers. In two-monitor setups it also fixes the right edge of the first container to the monitor edge.

If **Separate view Controls** are chosen, each container has its own set of View Options control blocks. If a **Shared view Controls** is chosen, the set of View Options control tabs spans the whole area under the containers. The tools and functions always apply to the currently active container / image.

**Fig. 597** Container Context menu

## 6.2 2D View

This function allows to

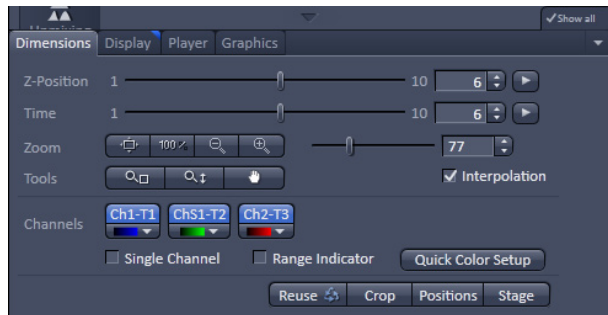
- display a single image in frame mode,
- display multiple channel images in superimposed mode.

The following **View Option** control blocks apply to this View Type:

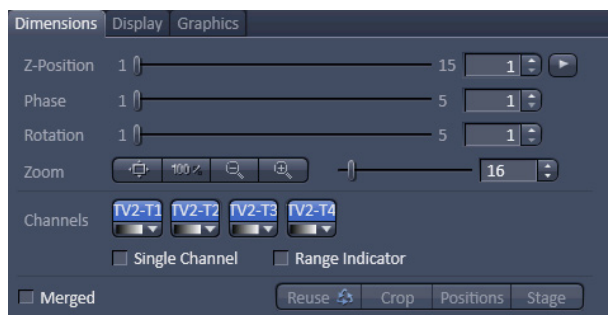
**Dimensions, Display, Player** and **Graphics**.

In the 2D view, only the general **View Option** control blocks are displayed. These view option blocks are also available in those other view options in which the functions are applicable.

The general view option control blocks are only described in this section.



**Fig. 598 View Options control block - Dimensions**



**Fig. 599 View Options control block – Dimensions for SIM images**

### (1) Dimensions – Zoom

In the **Dimensions View Options** control block, there are the **Zoom** and **Tools** function lines related to changing the zoom factor of a displayed image.


Any changes on these elements affect the displayed image immediately. The zoom function can be performed online.

### 6.2.1 Dimensions





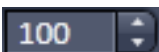



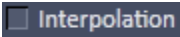
The **Dimensions View Options** control block holds the tools to modify the image display with respect to the (multiple) dimensions of the image data set.

The sections (slices) in the dimensions can be scrolled with sliders (**Z-Position** and **Time** in Fig. 598) and also directly addressed with setting numbers in the spin-boxes next to the sliders.

For **SIM** raw images you will have in addition available sliders for the Phases and Rotations of the grid (Fig. 599).

The small  button on the right hand side of the spin-boxes (**Z-Position** and **Time**) starts and stops an animation in the respective dimension. This basic animation cannot be customized. For all other player-functionality refer to the **Player View Block**.

The functions of the **Zoom** and **Tools** lines are:


-  **Zoom Normal:** The image is fitted automatically to size of the **Image Display** window which is always the originally displayed size.
-  **Zoom 100 %:** displays one pixel of the image also as one pixel on the screen.
-  **Zoom -** reduces the image.
-  **Zoom +** enlarges the image.
-  **Spin-box and slider:** type in your magnification value in percent directly. The zoom factor can be set alternately by moving the slider. The spin-box displays the current zoom factor in %. 100% corresponds to the original size.
-  **Zoom selection via mouse:** draw the area to zoom in directly on the image.
-  **Zoom-Mouse:** allows you to enlarge / reduce the zoom factor of an image using the left / right mouse button, provided that the cursor is inside the image.
-  **Navigation hand:** allows you to scroll the position of a zoomed image inside of the image window.
-  **Interpolation check box:** activates / deactivates the zoom interpolation function.

**(2) Dimensions – Channels**

The **Channels** functions are designed to switch on/off channels or the display of the merged image as well as to assign color look-up tables (LUTs) to the individual channels:



Clicking on the **Ch1-T1** **ChS1-T2** **Ch2-T3** buttons switches the respective channels on/off in the display.

Clicking on the  buttons or white arrow opens the channel color lock-up-table to select the color, LUT or no color for this channel (see Fig. 600).

The **Single Channel** check box activates / deactivates single mode operation.

The **Range Indicator** check box activates / deactivates the **Range Indicator** function.

Clicking on the **Quick Color Setup** button opens a selection menu. Here you can change the image view between **BGR**, **GRB**, **RGB**, **Grey** and **Range** indicator mode quickly.

Any changes on these functions affect the displayed image immediately.

If the display area of the channels is not enough to display all channels a slider becomes available below the listed channels.

That allows you to scroll through all channels (Fig. 601).




**Fig. 600 Image Display - Dimensions - Channel color lock-up-table**



**Fig. 601 Image Display - Dimensions**

### (3) Dimensions – Reuse

Clicking the  button transfers **ALL** acquisition parameters (exception: objective and collimator, see below) from the stored image data to the **Microscope Hardware Settings / Control tools** and applies those parameters directly to the system.

The acquisition parameters of an image are displayed in the Information View (section **Information View**).

In the **Maintain** tab (section **Options – System Options – Reuse** tab), it can be set whether the objective and the collimator settings are also "re-used" and applied to the system. **Reuse** of the microscope objective only works in microscopes with motorized objective revolvers.

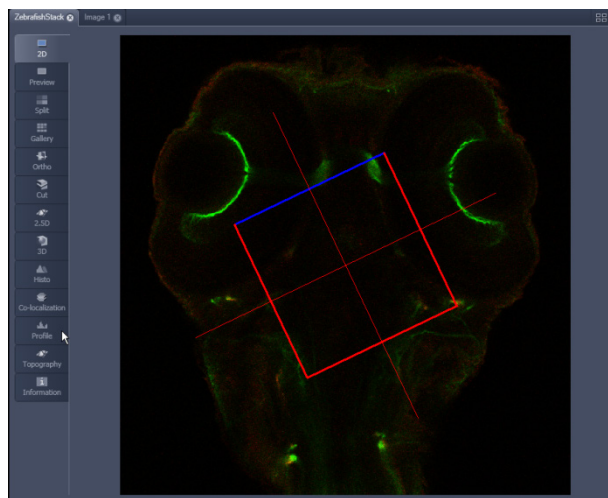




Fig. 602 Image Display - Dimensions - Crop

### (4) Dimensions – Crop





This function allows to interactively define the size and orientation of a rectangular scan area on the image displayed in the **Image Display** window.

The defined area is synchronized with the **Zoom, Offset and Rotation** parameters in the Scan Area panel (partially **Show** all mode) in the Acquisition Mode tool (section **Acquisition Parameter – Acquisition Mode**).

Click on  will display the **Crop Rectangle** in the **Image Display** (Fig. 602). Any changes done with the **Crop Rectangle** are setting the scan parameters immediately. On the next execution of a scan (**Set Exposure, Live, Continuous, Snap**) these new scan parameters will be applied. To reset the crop function and use default values set **Zoom=1, Offset=0** and

**Rotation=0** in the **Scan Control** window in the Scan Area panel in the **Acquisition Mode** tool (or click "reset all" in the same panel). When the  button is de-selected, the scan parameters are reset as well.

The **Crop Rectangle** is controlled via the following functional elements:

- Offset**  Click into the crop rectangle, keep the left mouse button pressed and drag the crop rectangle to the required position. Release the mouse button.
- Zoom**  Click on a corner of the crop rectangle, keep the left mouse button pressed and set the required size. Release the mouse button.
- Rotation**  Click on one end of the crosslines, keep the left mouse button pressed and set the required rotation angle. Release the mouse button. The first line scanned is highlighted in blue.
- Side ratio**  Click on any of the intersection points between crossline and crop rectangle, keep the left mouse button pressed and change the side ratio as required. Release the mouse button.



**(5) Dimensions – Positions**

When clicking Positions a crosshair will be displayed at the cursor position in the image. With a mouse click the position of the crosshair in the image will be added to the Positions list in the Stage tool and the Positions tool.

**(6) Dimensions – Stage**

Stage will show the cursor as a rectangle with a crosshair in the centre. With a mouse click the stage (and therefore the sample itself) will be repositioned. The image position with the cross hair will become the centre position of the stage and therefore the centre position of a next image

**6.2.2 Display**

In the **Display** View Option control block, the intensity minimum can be set to the Black value and the intensity maximum to the White value of the image using the **Min/Max** button.

Clicking on the **Best fit** button sets the intensity minimum to Black and percentile value and the intensity maximum to White and percentile value.

Activating the  **Auto** check box sets the intensity minimum and maximum values automatically.

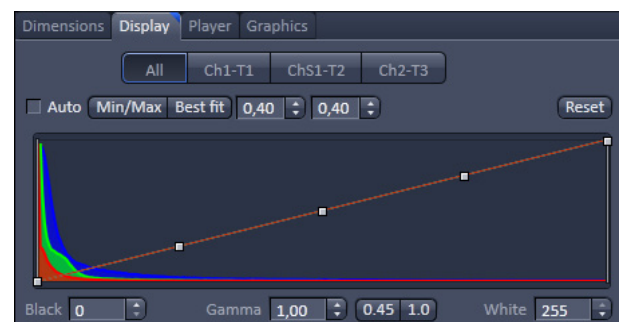
With the **0,40** spin-boxes you can set the lower and upper percentile values.

The **Black**, the **Gamma** and the **White** values of the displayed image can be adjusted (Fig. 603) individually.

With the **All** **Ch1-T1** **ChS1-T2** **Ch2-T3** buttons, the effect of the settings can be restricted to an individual channel or be applied to all channels. By default, the settings apply to all channels simultaneously.

The parameters can be changed using the spin-boxes – or directly by typing in numbers in the number-field. With the **Reset** button, the original settings are easily re-set.

The settings in this View control block apply only to the Image Display and are NOT changed in the original data set. To write the changed settings to the image data set, use the **Burn in Brightness and Contrast** function in the **Processing** tab (section **Processing Tab**).



**Fig. 603 View Options control block - Display**

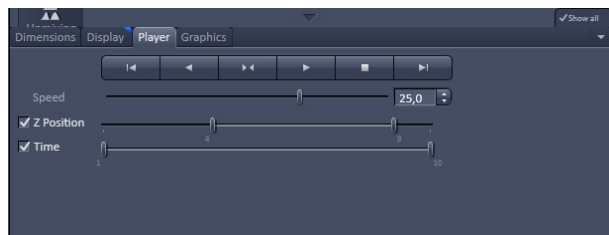


Fig. 604 View Options control block - Player

### 6.2.3 Player

This function allows to

- animate frames of a Z-Stack or a time series
- specify animation parameters such as range and animation speed

When the image displayed in the **Image Display** window is neither a Z-Stack nor a time series this View Option control block is empty.

The **Player View Option** control block is controlled by the following elements:

#### Z Position

The **current position** slider is displayed in the View Option control block **Dimensions** and can also be moved manually or by entering the slice number in the input box. The slider can be accessed only, when the player animation is off.



**Start** and **End** slider: The setting of the **Start** sliders limits the number of slices to be used for the animation. Slices before **Start** and after **End** are not taken into animated. These sliders can be changed during automatic animation.



Starts the forward motion of the automatic animation. After the last slice has been passed, restart is made at the first slice.



Starts backward motion of the automatic animation. After the first slice has been passed, restart is made at the last slice.



Starts the combined forward / backward motion of the automatic animation, i.e. when the last slice has been reached, the backward motion is activated, and the forward motion is activated again on reaching the first slice.



Stops the automatic animation.



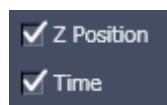
Move to the first slice.



Move to the last slice.

#### Speed

**Speed** can be set through a slider or spin-box (selection box).

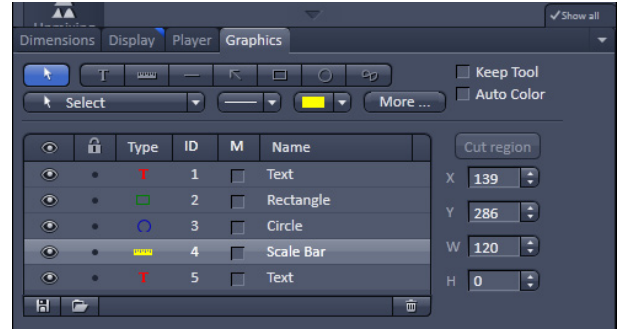


**Multidimensional** animations can be selected by including individual dimensions by checking tick boxes.

### 6.2.4 Graphics

This function allows to

- select from a set of drawing functions such as rectangles and arrows,
- add a scale bar to the image, as well as text annotations,
- use a set of interactive measurement functions for length, angle, area and size,
- add a text box that displays the coordinate of a hidden dimension (e.g., the z-position in a Z-Stack or the timestamp in a time series).



**Fig. 605 View Options control block - Graphics**

#### Functional Description

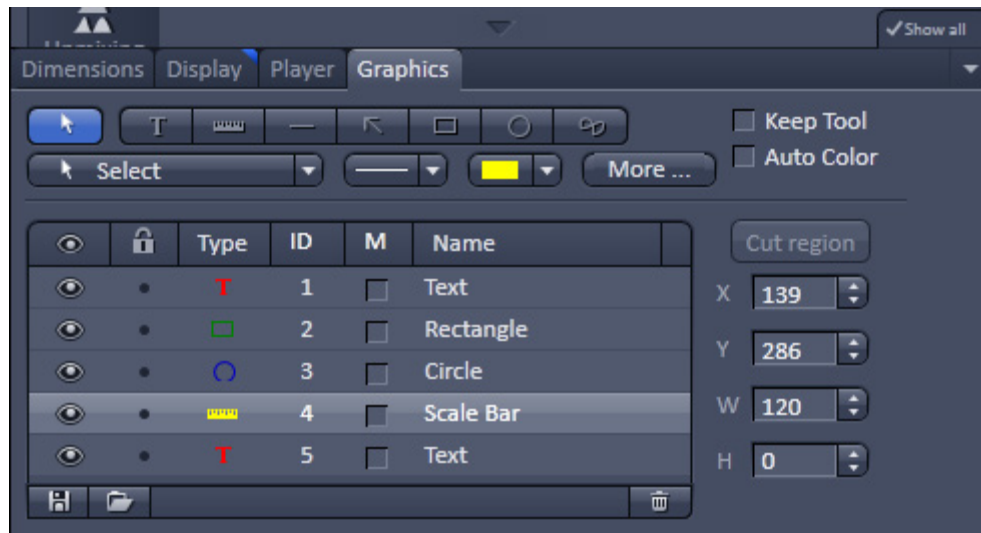
The graphics function uses a plane separate from the image plane (the graphics plane) and therefore does not change the content of the image(s).

The **Graphics** view option control block is available in all View Types except **2.5D**, **Lambda Coded** and **Preview**.


Any changes done with this function are effective immediately.

The overlay graphics can be stored in the images or separately in a file from where they can be re-loaded.

#### Available functions in the Graphics View Control Block



**Fig. 606 Graphics view control block**

The following list describes the most common functions in the **Graphics** view control block. More can be found in the  pull down menu.



**Select tool:** Activation of the mouse cursor for selection, resizing or movement of an graphic element in the Image Display.

Resizing: Click on the handle and hold down the mouse button, drag the handle, release the mouse button.

Movement: Click on the line and hold down the mouse button, move the entire element, release the mouse button.



**Text (Annotation) tool:** Creation of a text box in the Image Display.

After clicking on T, the Text window will be displayed, and text can be entered via the keyboard. The Font ... button enables you to select the font style and size in the Font window. The entered text will be displayed in the left upper corner of the Image Display window after clicking on OK and can be moved to the required position using the mouse. The Text window can also be activated with a double-click on a created text box, and the entered text can be edited subsequently.

Insert opens up a further window which allows you to annotate coordinates, time and Z-position with either automatic or user definable units and precision. This annotation is updated during image acquisition and can be exported with the image. The annotation can be stamped into already existing images.



**Scale bar:** Creation of a horizontal or vertical scale bar with default increments in the Image Display. Click and hold the mouse button for the starting point, drag horizontal or vertical scale, release the mouse button to end the procedure.



**Line tool:** Creation of a straight line in the Image Display.

Click and hold down the mouse button, draw a line in any required direction, release the mouse button to end the procedure.



**Line with arrow button:** Creation of a line with arrow in the Image Display window.

Click and hold down the mouse button, drag the line in any required direction, release the mouse button to end the procedure.



**Rectangle tool:** Creation of a rectangle in the Image Display.

Click and hold down the mouse button, draw a rectangle in any required direction, release the mouse button to end the procedure.



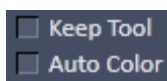
**Circle tool:** Creation of a circle in the Image Display.

Click and hold down the mouse button, draw a circle in any required direction, release the mouse button to end the procedure.



**Closed Bezier tool:** Creation of a closed bezier figure in the Image Display.

The first click sets the starting point, each additional click adds a further line, a click with the right mouse button ends the procedure and closes the figure.



**Keep Tool check box:** keeps the selected tool for creation of further objects, if activated.

**Auto Color check box:** sets the color of the object automatically, if activated.



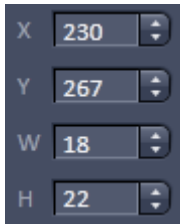
**Line thickness pull down:** sets the line thickness of the selected element.



**Color selection pull down:** In this pull down, different colors can be assigned to the graphic elements with a click of the mouse. A selected color is automatically assigned to the currently selected graphic element and to all elements created afterwards.



**Cut Region tool:** The region of a Z-Stack or 4D-image surrounded by an graphic element is extracted and displayed separately in a new Image Display. This function is only active if the active graphic element defines a closed contour or volume.



**Coordinate and dimension display:** shows the XY coordinates of the object center and the width and height of the graphic element.

**Function elements of the graphics list box:**



Activate/deactivate the display of the graphic element in the image.



Locks / unlocks the graphic element in the image



Shows the type of the graphic elements as an icon.



Shows the number of the graphic elements.



Activate/deactivate the display of the parameters of the graphic elements, e.g. A = area for a closed object; L = Length of the line (or circumference of a closed object); Angle for a line/arrow or angle.



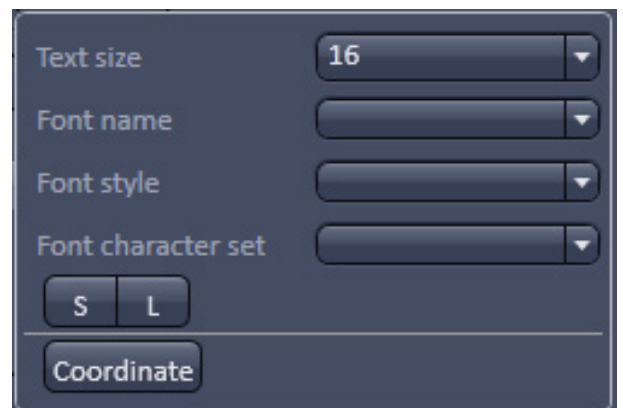
Shows the name of the graphic elements.



**The More** options (Fig. 607) allow the selection of the following text parameters in the appropriate list box:

- Text size
- Font name
- Font style
- Font character set

Clicking on the **S** or **L** buttons toggles between small or large font size.



**Fig. 607 View Options Graphics - More**

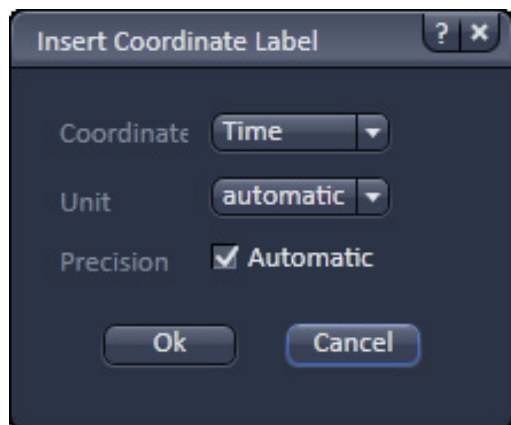





Fig. 608 View Options Grapics - Coordinate

To insert a **Coordinate Label** in the image display, click the **Coordinate** button in the **More ...** dialog. The coordinate settings dialog (Fig. 608) offers the available settings and upon clicking OK, the selected coordinate is displayed as a text field in the image display. This text field is always immediately updated when the slice/section/time point is changed in the display by changing settings in the **Display View Option** control block or, for example, starting the **Player** animation. This feature is particularly useful to display time or z-position in an exported animation movie for presentations (see Fig. 606).

To load / save graphics from / to a file use the **Load**  / **Save**  buttons in this View Options control block. To delete a graphic element from the image select this element and click on the **Delete**  button.

Naming and location in the file system can be set individually.

### 6.2.5 Preview View

The Preview View Type is an enlarged copy of the thumbnail Previews described in the section **Processing Tab**.

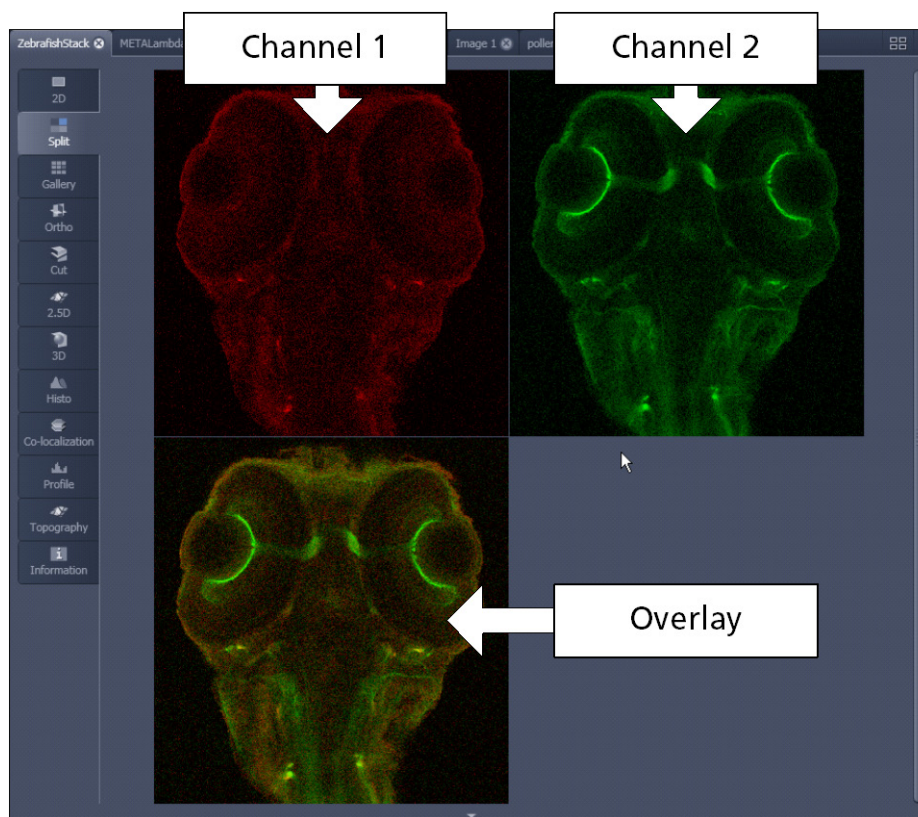
### 6.3 Split View

This function allows to

- display the individual channels of a multi channel image as well as the superimposed image.

The settings of the **Dimensions**, **Display**, **Player** and **Graphics** view options control blocks apply with the following additional features:

- The **Dimensions** View Options control block shows the **Merged** tick box to activate / deactivate the display of the channel overlay and a **Zoom All** button is added synchronize zooming to the Dimensions view control block.
- Graphic overlay elements are always displayed in all channel displays.



**Fig. 609** Image Display, Split view type

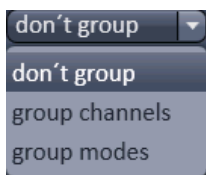


This function is useful to optimize the individual channels in a multi channel image acquisition together with the **Range Indicator** palette.



**Fig. 610 Image Display - Dimensions – Channels with mixed modes**

In the ELYRA and LSM 7 ELYRA systems channels of different imaging modes can be combined. For example, if SIM (SR channel) or PALM (HR channel) images are computed they can be displayed in combination with widefield (WF channel) or sum widefield (SWF channel) images (Fig. 610).

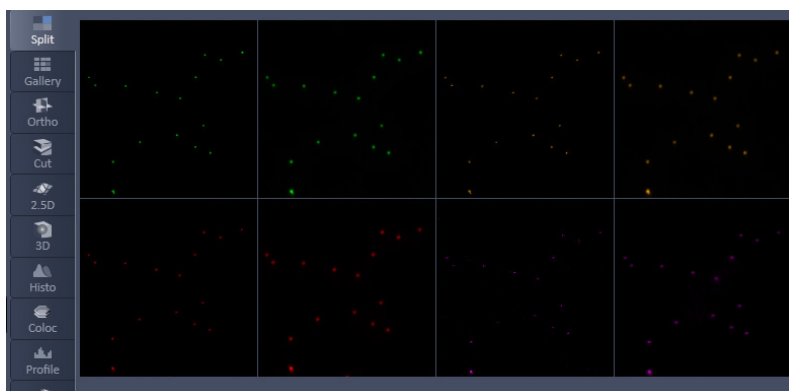


**Fig. 611 Mixed mode grouping drop down menu**

Channels if not rearranged by the user, are by default displayed by their color that is the different modes are listed together.

If the Software recognizes such **mixed mode** channels, the **mixed mode grouping** drop down menu becomes available (Fig. 611).

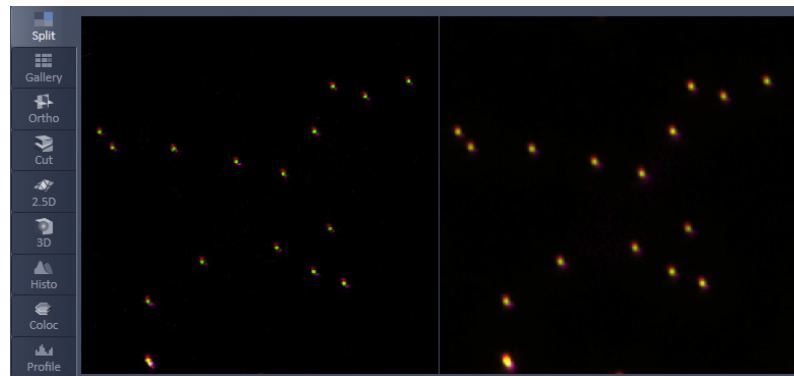
You have three options to group the **mixed mode** channels. If you choose **don't group**, all channels will be displayed split (Fig. 612).



**Fig. 612 Image Display, Split view with mixed modes – don't group: 4 color channels with the 2 modes displayed together**

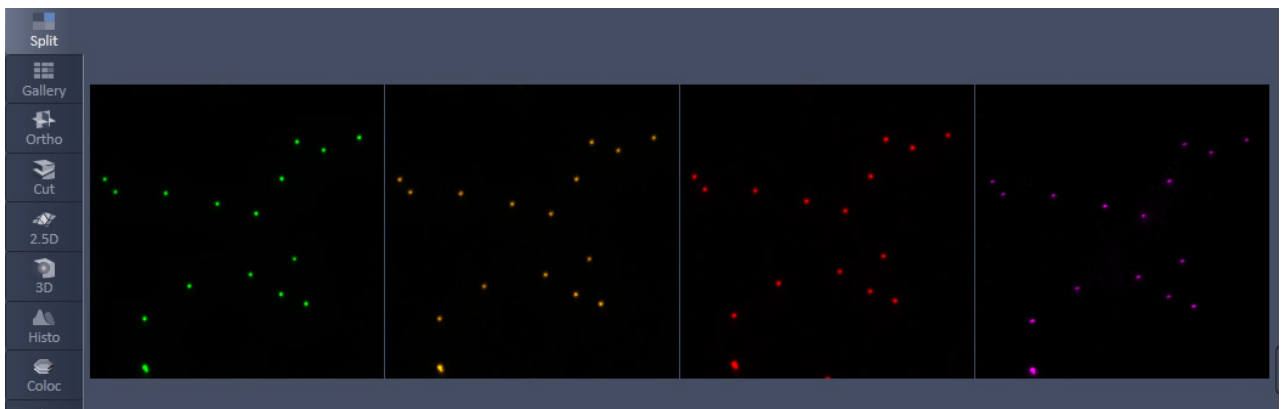


If **group channels** is selected all channels belonging to the same color will be merged in one image (Fig. 613).



**Fig. 613** Image Display, Split view with mixed modes – group channels: 4 color channels with 2 modes merged

If **group modes** is selected all channels belonging to one mode will be merged in one image (Fig. 614).



**Fig. 614** Image Display, Split view with mixed modes – group modes: 2 mixed mode channels with 4 colors merged

## 6.4 Gallery View

This function allows to:

- display images (Z-Stack, time series, combination of both) side by side in a tiled fashion,
- add data relevant to the displayed images (Z-Stack slice distance, time of acquisition or wavelength),
- extract a subset of images from the original stack and store the result as a new image (controls for this function are in the **Processing** tab function **Copy** → **Subset** (see section **Processing – Copy**).

The settings of the **Dimensions**, **Display**, **Player** and **Graphics** View Options control blocks apply.

The additional view-specific **Gallery** View Option control block includes a tick box to switch on and off the display of the slice coordinates in the Gallery display. If this text is activated, transparent mode and color can be selected in this control block too (see Fig. 615).

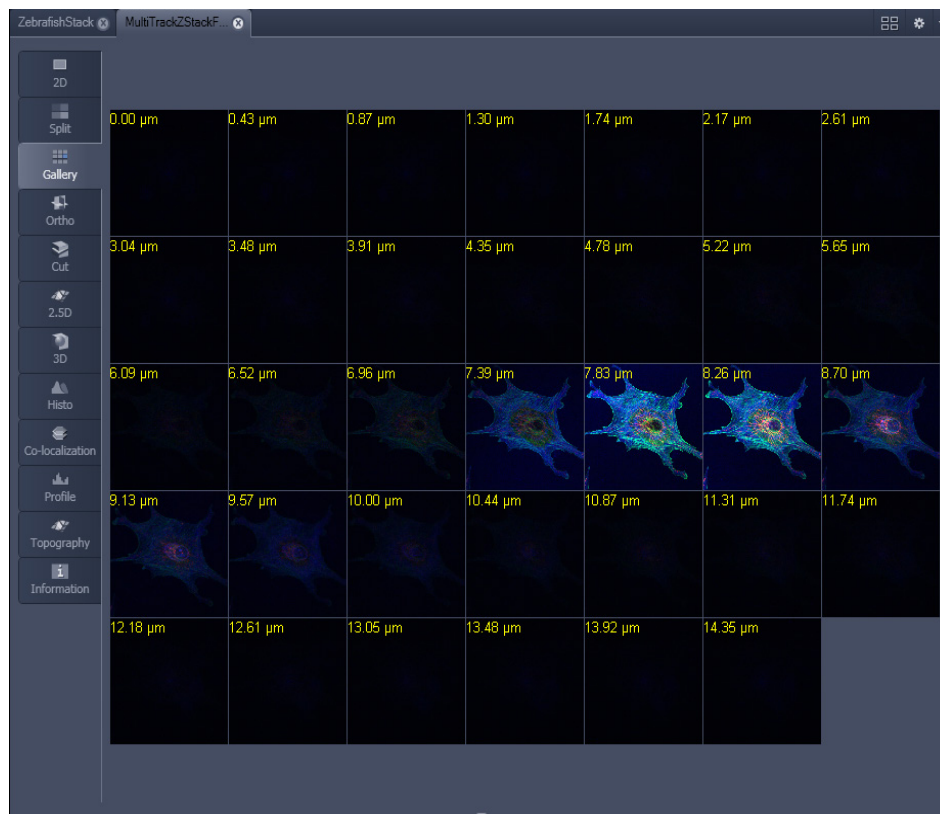


Fig. 615 Image Display window - Gallery display

## 6.5 Airyscan View

When data are acquired with Airyscan, the Airyscan View Tab becomes available.

### 6.5.1 Airyscan – View Option Tab Dimensions

All Airyscan display and online processing functions can be done in the **Airyscan** tab (Fig. 616). The tab shows both the Airyscan source image and an online processing image side by side. The improvement obtained in resolution and SNR with the Airyscan can be observed in realtime this way. In addition, the intensity values of the detected Airy rings and the detector intensity view is displayed.

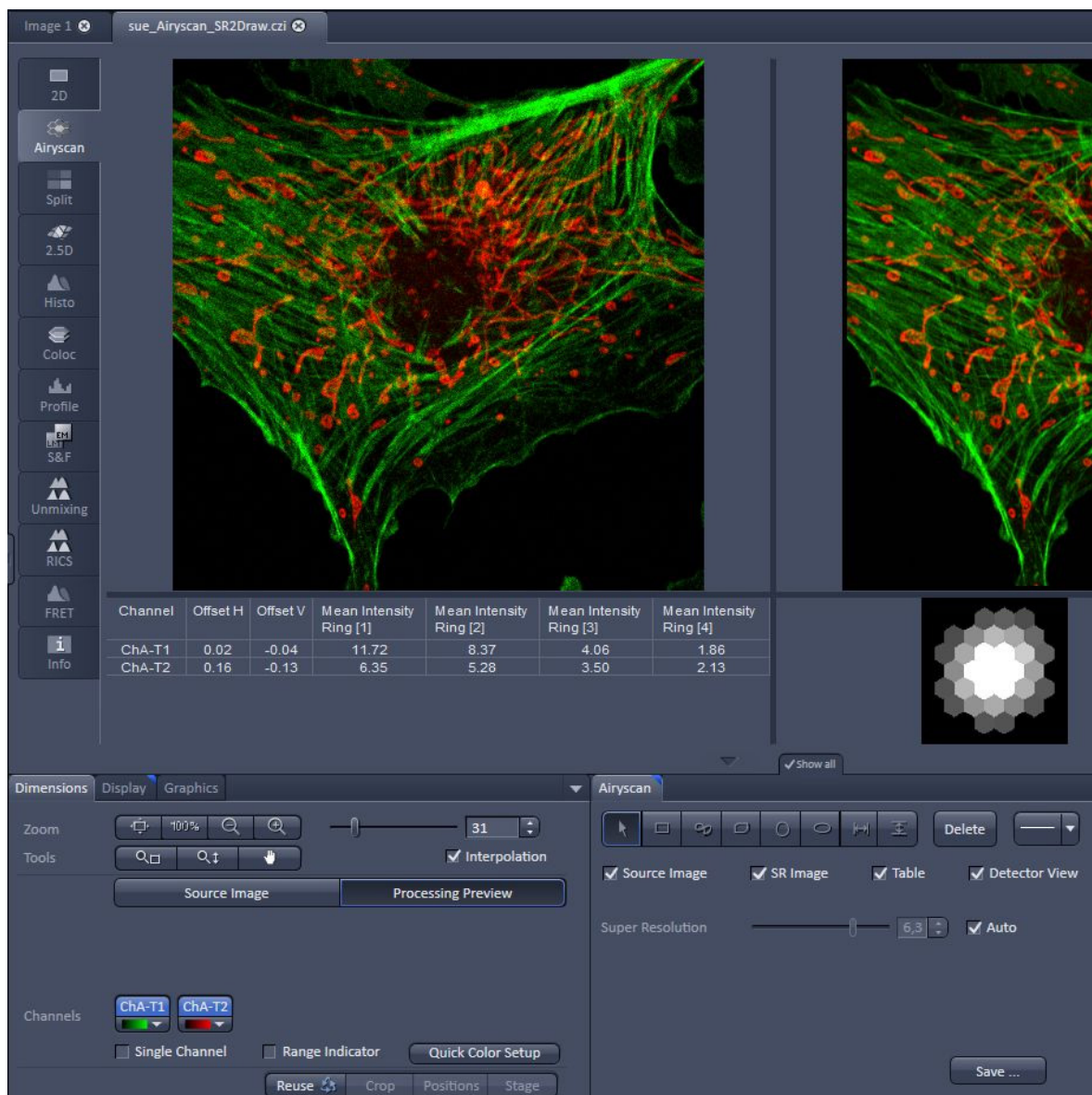


Fig. 616 Airyscan View – Dimensions tab

### 6.5.2 Airyscan – View Option Tab Display

#### Raw data and SR preview

Due to the nature of the Airyscan detection and the signal reassignment to the respective airy orders, the display curves (histogram) of the source image and the processing preview are very different.

To get a balanced view on both images, the display settings are adjusted automatically and can be individually optimized. When using the **Source Image** button (Fig. 617), all adjustments will only be effective for the source image (left).

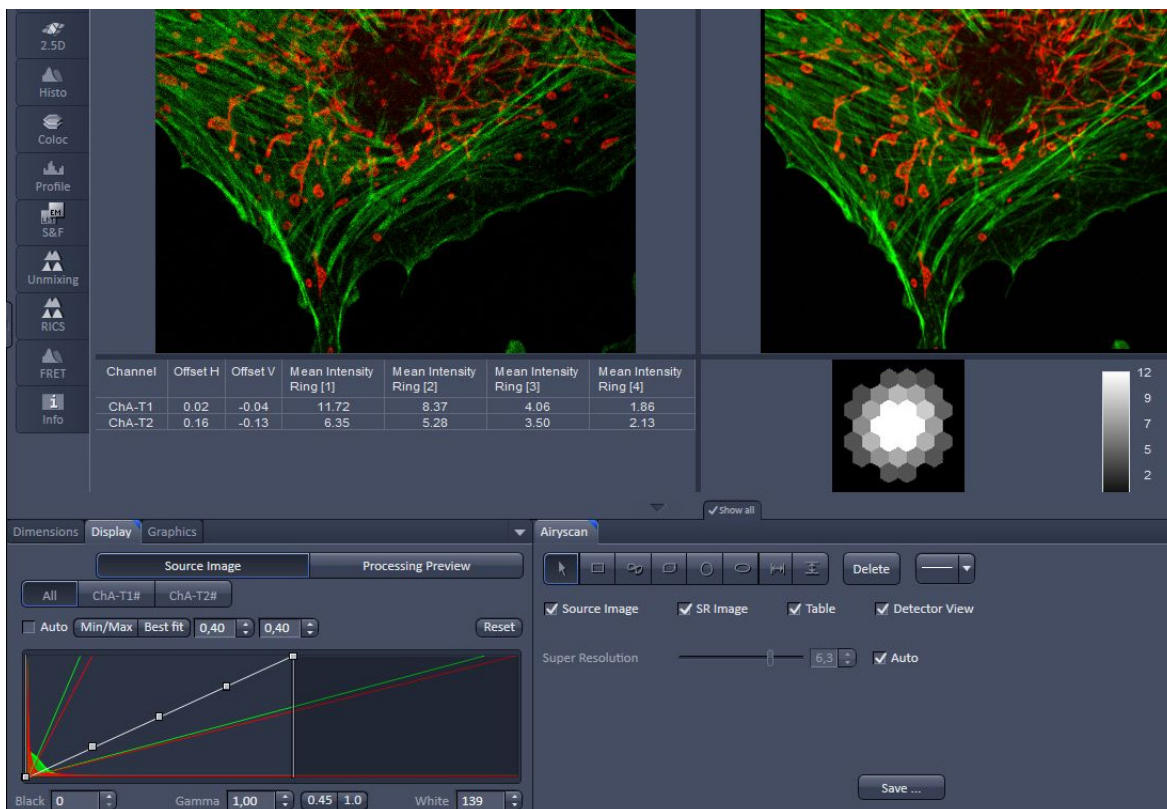


Fig. 617 Airyscan View – Display tab

When using the **Processing preview** button (Fig. 618), all adjustments will only be effective for the processing preview image (right).

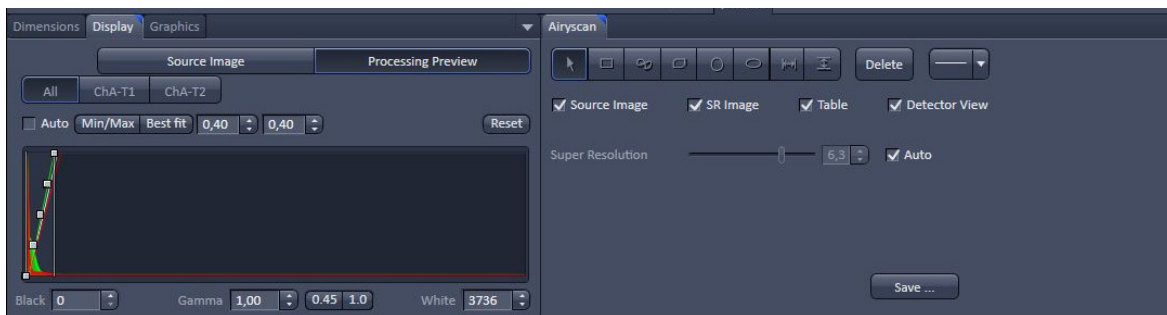


Fig. 618 Airyscan View – Processing preview

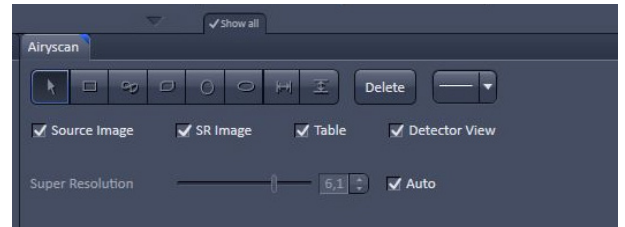
### 6.5.3 Airyscan – View Option Tab Airyscan

#### 2D Processing Image preview

There are several options available for the display of the Airyscan data.

#### Source image

**Source image** (Fig. 619) shows the raw sum data useful for focusing, panning, and setting of laser power and detection gain.

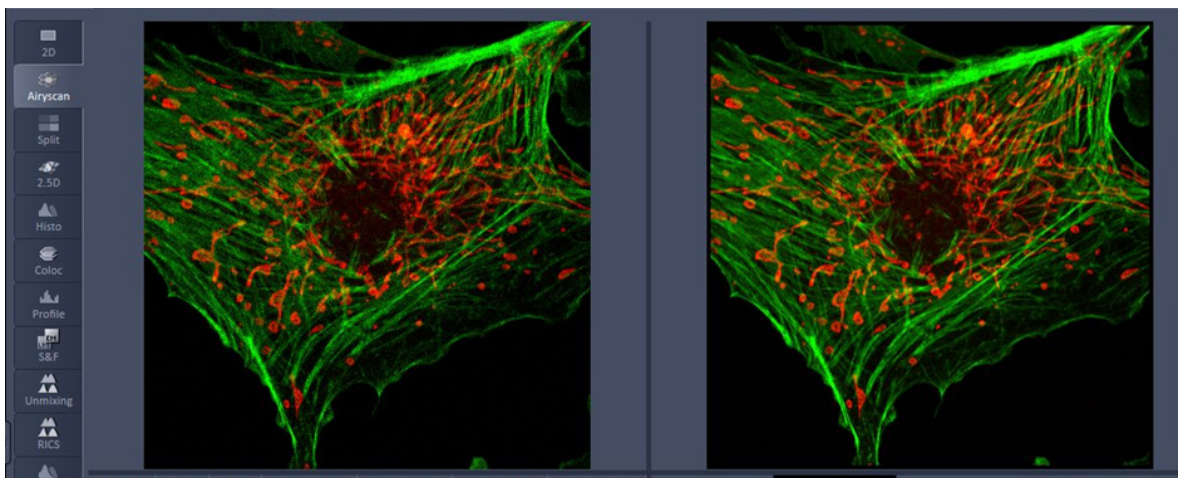


**Fig. 619 Airyscan View – Airyscan tab**

#### SR (VP) image

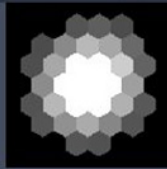
SR (VP) image gives a real time impression of the 2D processing result (Fig. 620). This can be both the SR mode and the VP mode. You can see the improved resolution or the modified sectioning this way.

Deselecting the checkboxes will hide the respective image.




**Fig. 620 2D processing result**

Channel	Offset H	Offset V	Mean Intensity Ring [1]	Mean Intensity Ring [2]	Mean Intensity Ring [3]	Mean Intensity Ring [4]
ChA-T1	0.02	-0.04	11.72	8.37	4.06	1.86
ChA-T2	0.16	-0.13	6.35	5.28	3.50	2.13




**Fig. 621 Intensity of the Airy orders**

In addition, there are some intensity displays available. The table shows the intensity of the Airy orders (Fig. 621).

 Note that in case of inadequate sample quality or acquisition settings (e.g. overexposure) the typical drop of intensities from low to high ring numbers is not available or reversed.

## Detector view

Shows the intensity distribution of the detection elements. This also allows a judgment whether the system is adjusted correctly (see section **Maintain Tab**). The brightest element should be in the center with a drop of the signal towards the periphery. The system will self-adjust during continuous scans or slow time series acquisition.

 Note that this display and adjustment is not available in VP mode. To get optimal adjustment in VP mode, it is recommended to switch to SR mode from time to time and do a continuous scan.

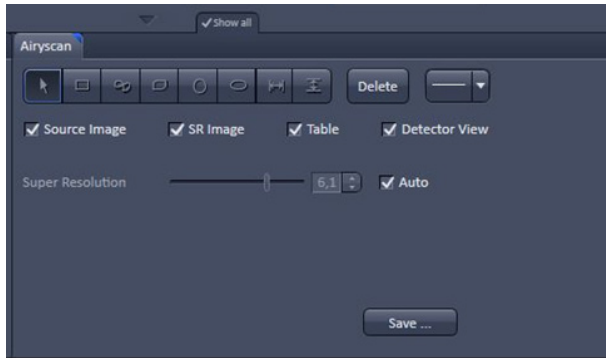


Fig. 622 Airyscan tab, Auto

## Auto

In case the **Auto** checkbox (Fig. 622) is engaged, the processing filter strength will be set automatically.

This will give almost optimal resolution without artefacts even with difficult (e.g. thick) samples.

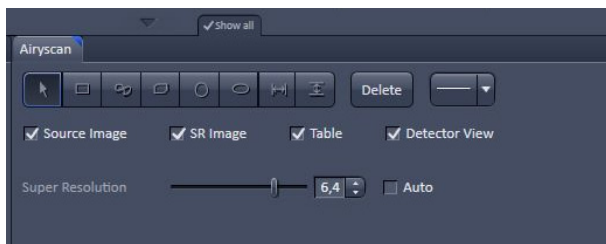


Fig. 623 Airyscan tab, Manual

## Manual (Auto off)

To get the maximum of the resolution increase in SR mode, use the super resolution slider (Fig. 623).

Moving it to the right will increase the processing filter strength and result in higher resolution.

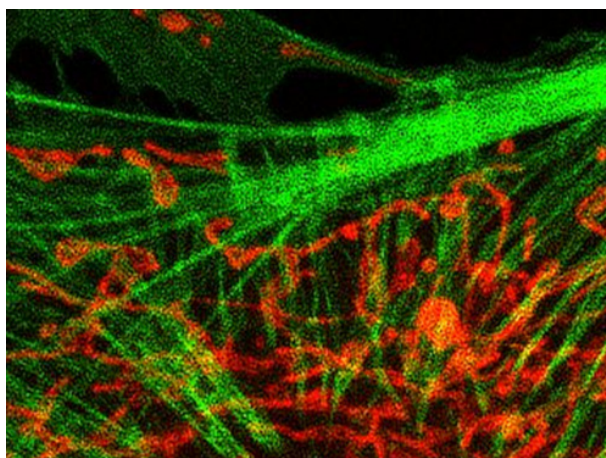
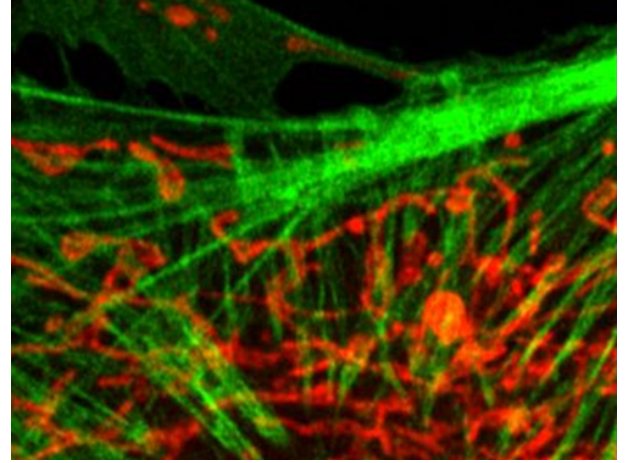


Fig. 624 Dot shaped artefacts

In case the SR processing filter is too strong, dot shaped artefacts will occur (Fig. 624).

Slightly reducing the SR filter strength will result in an optimal result (Fig. 625).

Typically, this position is 0.3 to 0.5 units higher than the Auto default value.



**Fig. 625 Optimal result**

### Processing Algorithm and Wiener filter (processing or filtering strength)

The image in a confocal system is the result of the convolution of the object by the effective PSF in the spatial domain. Noise will add to the image. Because each detector element in Airyscan acts as an independent pinhole, the image formed by each detector element will be a convolution of the object by the effective PSF of each element plus added noise (equation 1). In the frequency domain, the Fourier transform (FT) of the image of each detector element will be the product of the object spectrum with the effective OTF of the respective detector element plus added noise spectrum (equation 2).

By inference, if the image is deconvolved by the effective PSF, one should be able to reconstitute the true object structures. Likewise, if the image spectrum is divided by the effective OTF, one can obtain the object spectrum that will be inversely Fourier transformed (FT-1) to obtain the true object. To reconstitute the object spectrum one will have to weigh the contribution of each detector element to the image and deconvolve the sum of each detector element (equation 3). This is handled conveniently by a linear Wiener deconvolution, which takes noise into account (equation 4).

$$(1) \quad D_i(r) = O(r) \otimes EH_i(r) + N(r)$$

$$(2) \quad D_i(\omega) = O(\omega) \cdot EH_i(\omega) + N(\omega)$$

$$(3) \quad O(\omega) = \frac{\sum_i^n (D_i(\omega) \cdot EH_i^*(\omega))}{w + \sum_i^n |EH_i(\omega)|^2}$$

$$(4) \quad w = \frac{\langle |N(\omega)|^2 \rangle}{\langle |O(\omega)|^2 \rangle}$$

## Parameters

$O(r)$ : object,  $D(r)$ : image,  $N(r)$ : noise,  $EH(r)$ : PSF<sub>eff</sub>,  $O(\omega)$ : object spectrum,  $D(\omega)$ : image spectrum,  $N(\omega)$ : noise spectrum,  $EH(\omega)$ : OTF<sub>eff</sub>,  $i$ : index of detector elements,  $n$ : number of detector elements,  $w$  = Wiener parameter

The linear Wiener filter or Wiener deconvolution is calculated as the relation between the squareroot of the amount of the noise spectrum and the squareroot of the amount of the object spectrum (see parameters in the equation 4 above).

High frequencies comprise both, noise and high resolution. Due to the nature of the detector, the signal (or the amount of object frequencies) is higher in relation to the noise (amount of noise frequencies) even for high frequencies when compared to a standard GaAsP detector. The read out of 32 detector elements does not add a considerable amount of noise to the image, however the signal intensity is higher compared to a standard confocal image detecting not just the central part of the Airy disc but also the first and even part of the second side lobe.

With the Wiener filter, which can be set by moving the processing slider, those frequencies which are otherwise not detectable due to the bad signal to noise ratio can now be emphasized. The filter evens out the amplitudes of the noise frequencies in favor of the signal frequencies. Moving the slider to a higher value, which is concomitant with a decrease of the Wiener filter parameter, increases the resolution in the reconstructed image as the amplitudes of the noise frequencies become smaller. This allows seeing more of the higher object frequencies. However, if the processing value is set too high, that is the value of the Wiener filter parameter is too low, the smoothing of the amplitudes of higher noise frequencies is no longer effective and noise then shows up as artificial structures.

## VP mode

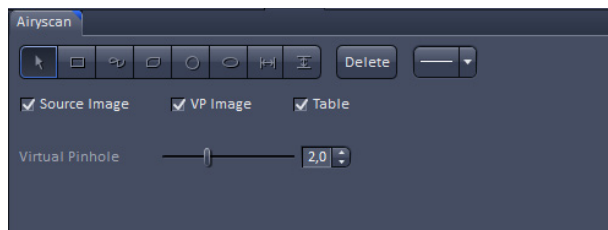


Fig. 626 Airyscan tab, VP mode

In VP mode (Fig. 626), the same slider will switch its function to virtual pinhole adjustment. This allows to adjust the confocal sectioning after acquisition by binning the respective airy rings together.

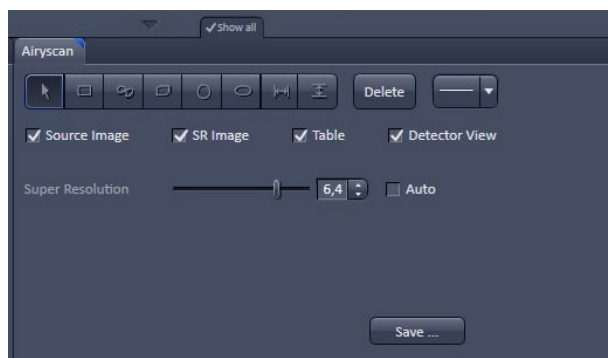


Fig. 627 Airyscan tab, Save

## Save

The results visible in the preview image can directly be saved by using the **Save** button (Fig. 627). Please note that this will only save the currently visible 2D image. Any series data will require an offline processing with the dedicated Airyscan processing tools.



## 6.6 Ortho View

This function allows to

- display a Z-Stack of images in an orthogonal view
- measure distances in three dimensions

The settings of the **Dimensions**, **Display**, **Player** and **Graphics** view options control blocks apply.

In addition to the 4 general View Option control blocks, the view-specific **Ortho View Option** control block is available (Fig. 628).

In the **Ortho** View, section sliders appear in the **Ortho View Option** control block together with orthogonal projections in the image (Fig. 629).

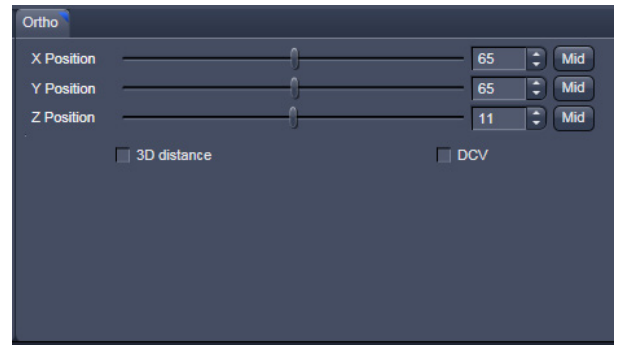


Fig. 628 View Options control block - Ortho

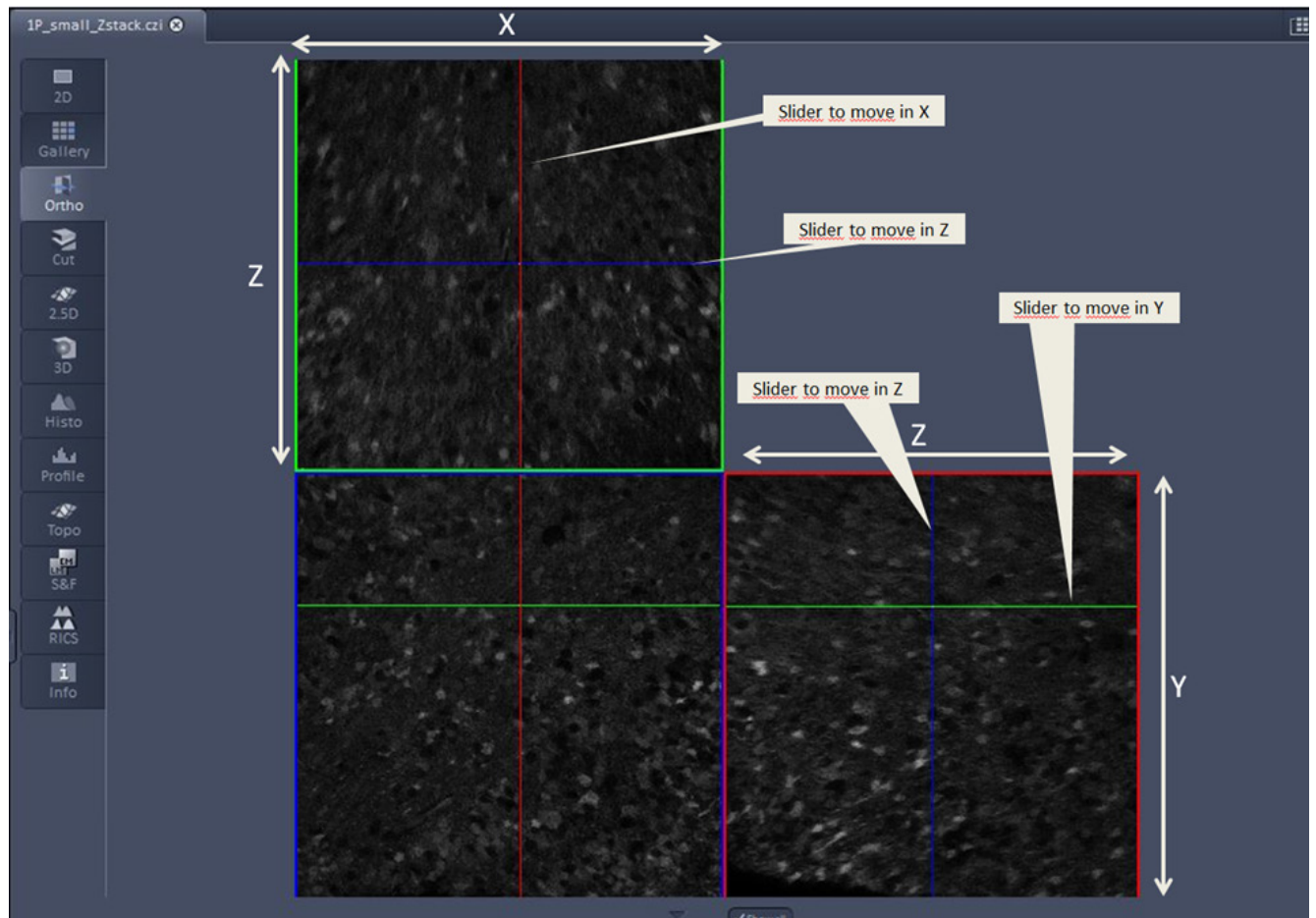


Fig. 629 Image Display - Ortho View

### 6.6.1 Ortho – Select Function


- By changing the parameters X, Y and Z in the **Ortho** View Option control block, the section plane can be positioned at any XYZ coordinate of the Z-Stack.

The position of section planes can be changed in various ways:

- By moving the sliders on the **Ortho** View Option control block.
  - X and Y settings may range from 1 up to the maximum number of pixels scanned (in the example shown: 512).
  - Z settings may range from 1 to a maximum of n, with n standing for the number of slices produced in the stack.
- By directly entering the relevant number value in the X-, Y- or Z-input box and pressing the **Tabulator** or **Enter** key.
- If you move the cursor into the **Image Display** window, it changes into a crossline symbol  $\oplus$ . By positioning this symbol with the mouse you can move the XZ and YZ section planes to any point of intersection with the XY plane. A click with the left mouse button places the intersection to the desired position.
- If you move the crossline symbol  $\oplus$  onto the intersection of the red and green section planes, it changes into the:  $\leftrightarrow$  symbol. If you now press the left mouse button and keep it pressed you can reposition both section planes **simultaneously**.
- If you move the crossline symbol  $\oplus$  onto the green section plane, it changes into the  $\updownarrow$  symbol. If you now press the left mouse button and keep it pressed, you can reposition the (green) XZ section plane.
- You can reposition the (red) YZ plane in the same way using the  $\leftarrow\rightarrow$  symbol.

The result of an orthogonal section is visible at the image margin.

- Section of the XZ plane (green line) through the stack: above the XY image.
- Section of the YZ plane (red line) through the stack: right of the XY image.
- Section of the XY plane (blue, slice plane of the stack): center image.

 If you zoom in one plane, the other planes will be zoomed with the same factor.

### 6.6.2 Ortho – Distance Function

- Activating the  3D distance tick box permits length measurements in 3D space.
- Click on the **Mark** button to set the first XYZ-point for the measurement of the spatial distance.
- Set the second XYZ-point for measurement by moving the X-, Y-, Z-sliders or by moving the green, red and blue lines in the image.
  - The projections of the spatial distance are shown in the image planes by yellow lines (Fig. 630). The actual spatial distance is calculated and shown in  $\mu\text{m}$  next to the **Mark** button.

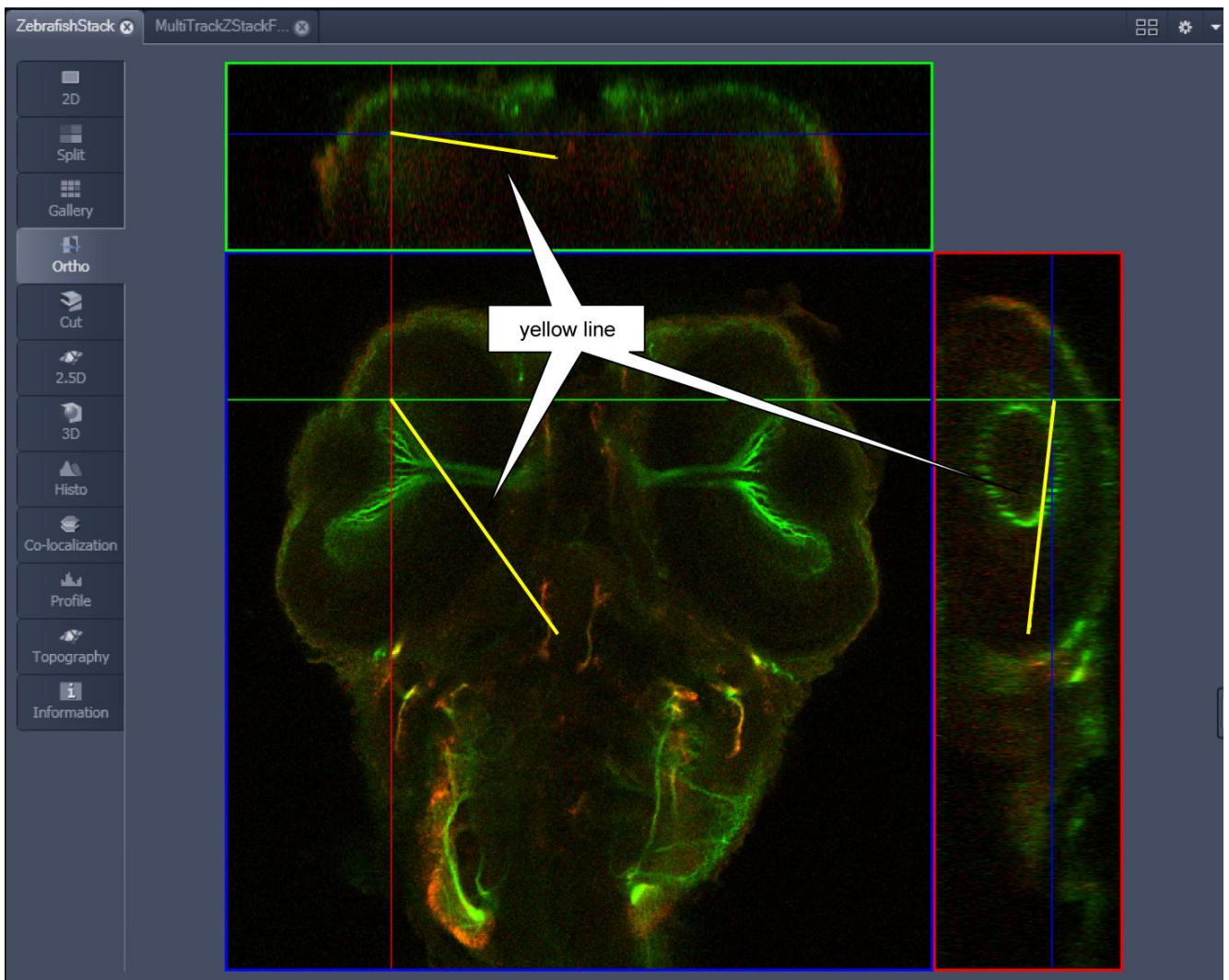


Fig. 630 Image Display – Ortho View - 3D Distance Measurement display



**Fig. 631** Cut View – control block

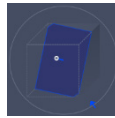
## 6.7 Cut View

This function allows to display a user defined section plane (= cut plane) of a Z-Stack. It automatically improves the image of the section plane by trilinear interpolation.

The settings of the **Dimensions, Display, Player** and **Graphics** View Options control blocks apply.

Any changes done with this toolbar are effective immediately. The content of the overlay plane is temporarily hidden while the toolbar is displayed.

- By varying the parameters **X, Y, Z, Pitch** and **Yaw**, you can position a section plane of any orientation within the stack volume.
- Clicking the **Mid Mid Mid 0 0** buttons restores the original position.



In order to place the Cut View Plane interactively use the interactive graphic in the cut view control tab.

## 6.8 2.5 D View

This function allows to

- display the two-dimensional intensity distribution of an image in an pseudo 3D mode,
- show the intensity values in profile, grid or filled mode,
- show separate distribution for each channel in a multi-channel image.

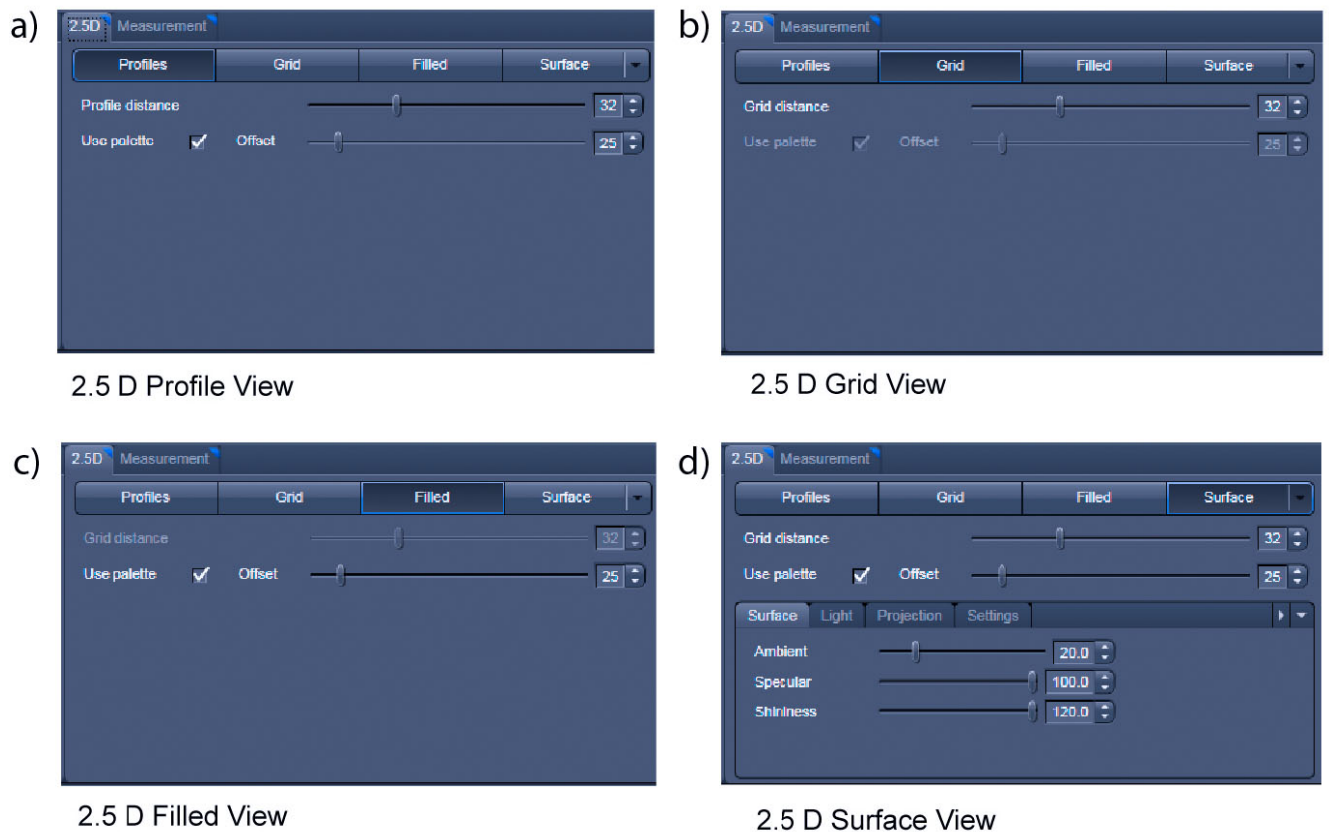
 The **2.5 D** button can also be used online during scanning.

The settings of the **Dimensions** View Options control blocks apply. The settings of **Display, Player** and **Graphics** View Options control blocks do not apply.

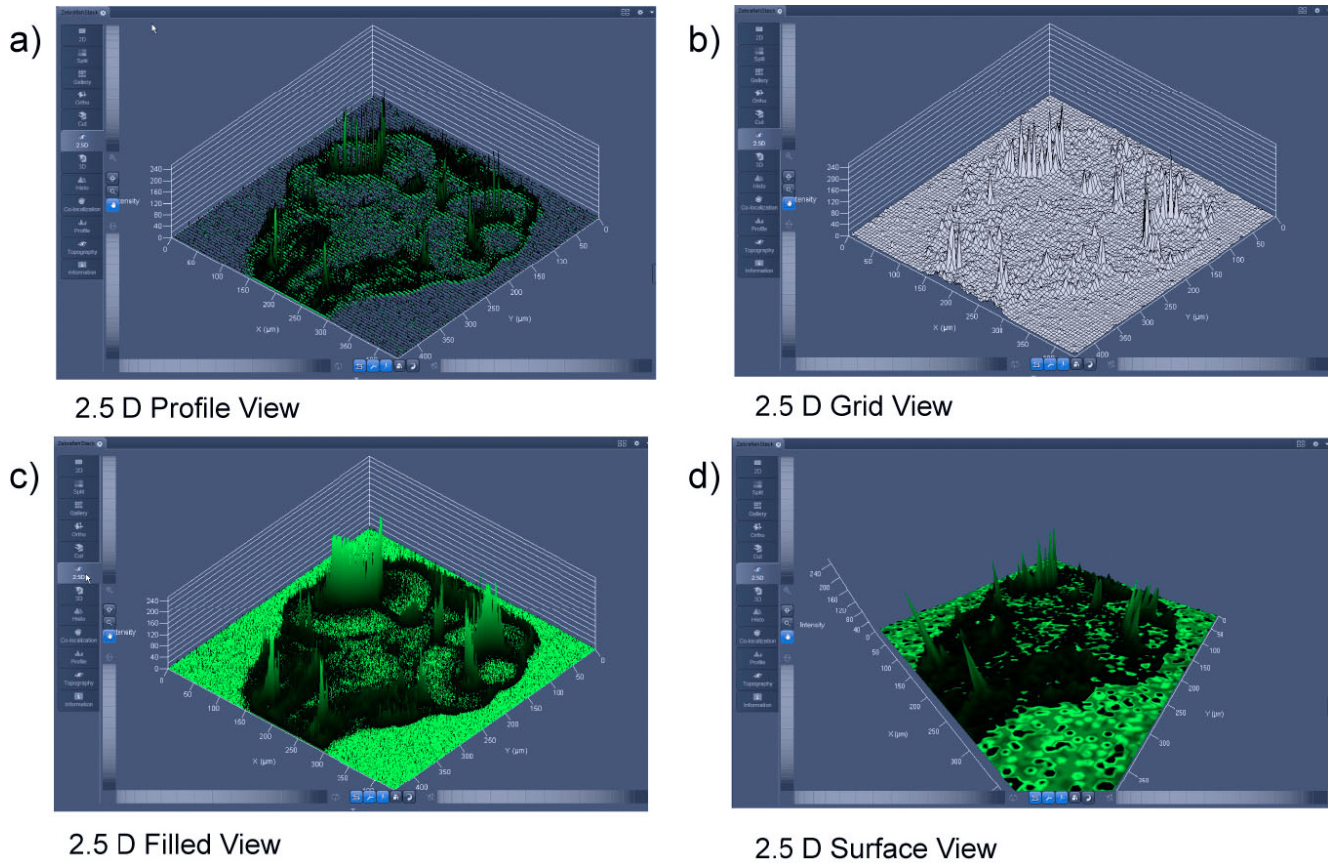
Any changes done with this toolbar are effective immediately. The content of the overlay plane is temporarily hidden while the toolbar is displayed.

The image display in the **2.5 D View Type** is the same as in the **3D View Type**. For a description of the controls in the display window see section **3D Rendering Settings in VisArtplus**.

In brief, the viewing plane of the **Image Display** window can be rotated, tilted either directly with the mouse or by the scroll bars on the right-hand side and the bottom of the **Image Display** window.



**Fig. 632 2.5 D View Option control tabs**



**Fig. 633** 2.5 D Image Display

The 2.5 D view control tab contains the following function elements:


- |                       |   |
|-----------------------|---|
| <b>Profile</b> button | Profile display (vertical polygon display). Setting of the <b>Profile Distance</b> between 1 and 20 using the slider.     |
| <b>Grid</b> button    | Grid display (horizontal grid display). Setting of the <b>Grid Distance</b> between 1 and 20 using the slider.            |
| <b>Filled</b> button  | Color diagram (filled 3D diagram). Selection between the <b>Mono</b> , <b>Rainbow</b> and <b>Six Step</b> color palettes. |

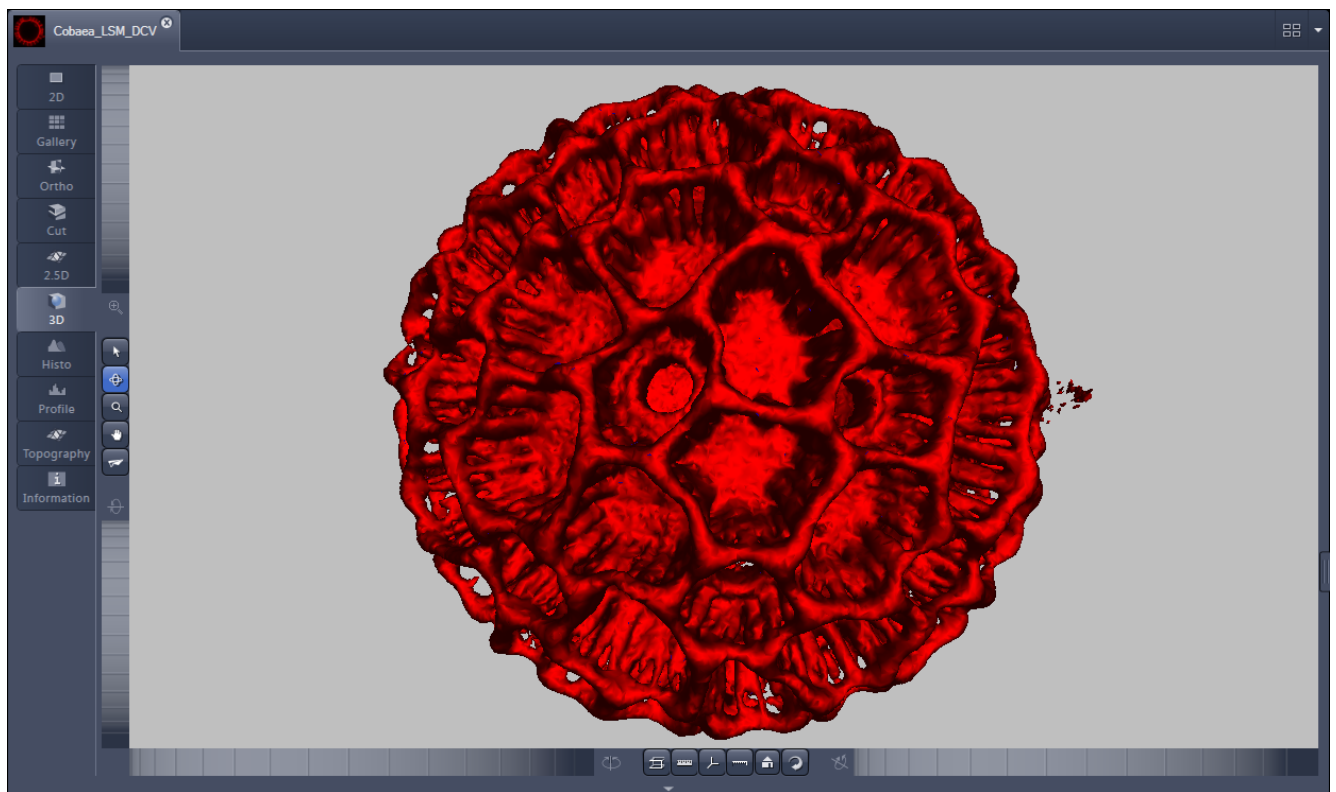
## 6.9 3D View

Use this View tab to display image Z-Stacks in three dimensions. Display and rendering of Z-Stacks with up to eight color channels are supported and the data can be a time lapse series (5D Image Stack). Advanced functions are linked to a license for the ZEN Module 3D VisArt.

The LUT for the channels set in the View option tab **Dimensions** and interpolation settings as well as the parameters set in the View option tab **Display** are applied. All other parameters from the **Player** and **Graphics View Option** tabs are not applied.

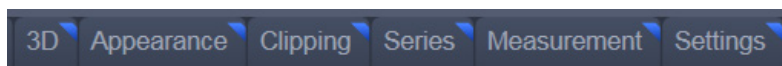
A click on **3D** will display the **3D** View Controls. Any changes done within these controls are effective immediately.

 The **3D** View can also be used online during scanning.

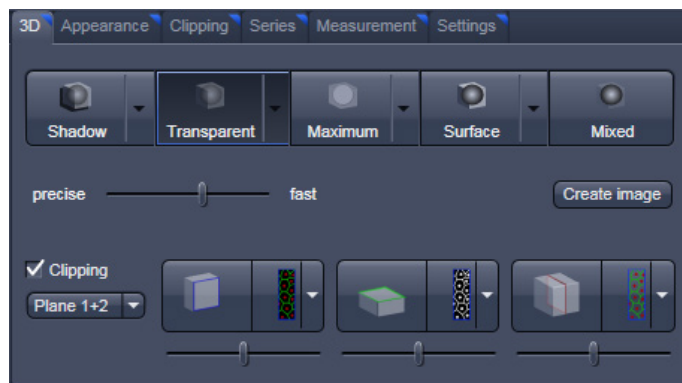


**Fig. 634** Image Display window - 3D display

The 3D View Controls contain the following functional elements:



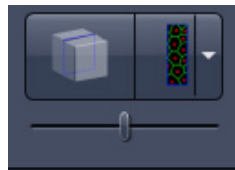
They are displayed when the tab is pressed in the order shown above.


**3D:**

On the **3D** View control panel the different render modes are accessible:

**Shadow, Transparent, Maximum, Surface** and **Mixed**. The rendering quality can be adjusted by using the **precise** — **fast** slider. The **Create image** button **Create image** opens a new image window and produces a 2D image of the currently used render mode. It uses the screen resolution unless it is otherwise defined in the **Settings** tab (see there).

**Clipping**  **Clipping** activates the Clipping Plane functionality. 3 different Clipping Planes are displayed and can be operated individually via 3 Buttons:

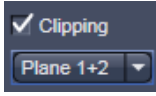


The Cut button toggles between different clipping behaviors of the respective planes. 

On the Clipping Planes different surfaces can be chosen from a pull down list: 

The Position of the clipping planes can be adjusted by the **Position Slider**.

Further functionality is available on the **Clipping Plane View control tab** → see there.

A wedge between 2 Planes can be clipped using the pull down  underneath the activation check box for the clipping functionality.

**Appearance:**

On this view control panel the settings for the respective render mode are available.

**Clipping:**

3D VisArt has the option to cut off certain parts of the 3D information by using so called "clipping planes". All the necessary tools to operate the clipping planes are found on this control panel.



**Series:**

3D Data can be visualized online by simply grabbing and turning the data stack with the mouse. In addition to this interactive way of interacting with the data 3D VisArt is able to perform render series where the dataset is turned around one of the axis, along a freely defined position list or a freely definable start and end point. The resulting series can be saved as movie files for presentations. A preview of the render series is available in the **position list** mode.

**Measurements:**

Measurements of distances, angles and polylines can be measured using the **Measure** panel in 3D VisArt.

**Settings:**

The **Settings** panel contains global settings for the 3D VisArt.

**6.9.1 Shadow Projection**

In the Shadow render mode the structures in the image are illuminated by a virtual light source.

The volume is viewed as if looking through the eyepieces of the microscope and the light source projects a shadow onto a background plane.

This gives the data a reference in space, making visualization much easier. The rendering effect itself consists of a combination of light reflection and opacity (degree of transparency).

The display in this mode is calculated by the main processor (CPU) of the computer (Voxel mode). The different modes can be accessed by clicking on the pull down symbol at the right hand side of the Shadow button (Fig. 636).

- **Front** button: Shadow rendering front view
- **Back** button: Shadow rendering back view
- **Any View** button: Shadow rendering with user defined view

With a click on **Front**, the 3D reconstructed image is displayed in a shadow projection where it is illuminated at a 45° angle from the front left.

A click on the **Back** button creates the same projection with illumination from back left.

Detailed settings for shadow projection can be accessed via the **Appearance** tab.



Fig. 635 3D panel - Shadow button

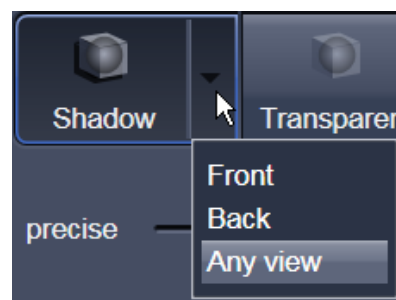
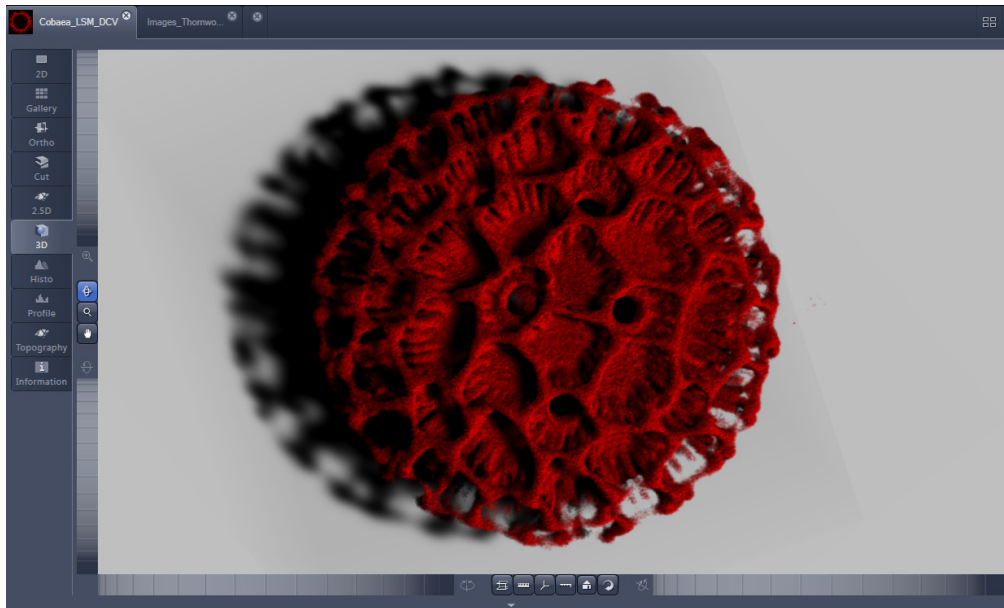


Fig. 636 Shadow pull down menu

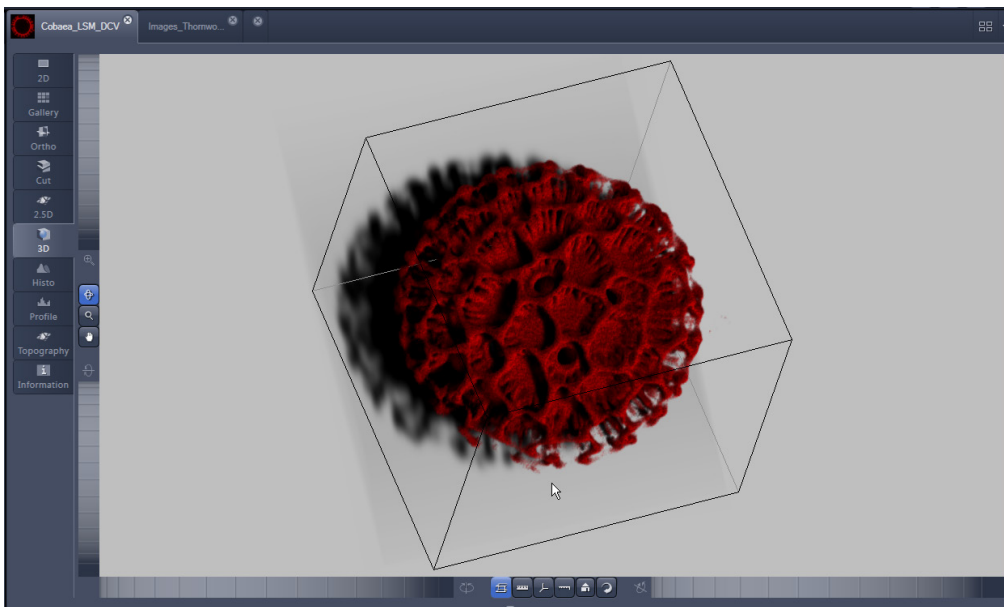


**Fig. 637** Image Display window, 3D display, Shadow projection, Front view

The zoom wheel to the left of the **Image Display** window allows continuous zooming of the 3D reconstructed image.

A click on the Any View button displays the 3D reconstruction image in a shadow projection where the viewing point can be defined. In addition to the zoom setting, the image can be rotated around the three orthogonal axes via the relevant setting wheels.


However, the 3D orientation can also be set directly in the **Image Display** window by clicking, holding and dragging the 3D reconstructed image with the mouse.




**Fig. 638** Image Display window, 3D display, Shadow projection, Any View


The following additional buttons are available in the **Any View** shadow projection mode:




- After activation of the **Frame** button  (below the image), a bounding box is drawn around the 3D reconstructed image.

 Depending on the used mode and hardware configuration, it can take several seconds until the 3D reconstruction is refreshed on the monitor after reorientation.


- A click on the **Coordinate System** button  displays a colored coordinate system in the **Image Display** window, where the X axis is displayed in red color, the Y axis in blue and the Z axis in green.

- A click on the **Scale** button  display an X-, Y- and Z-scale in the **Image Display** window.

- A click on the **Home** button  resets the display parameters to the default values.

A click on the **Any View** button displays the 3D reconstruction image in a shadow projection where the viewing point can be defined. In addition to the zoom setting, the image can be rotated around the three orthogonal axes via the relevant setting wheels.

However, the 3D orientation can also be set directly in the **Image Display** window by clicking, holding and dragging the 3D reconstructed image with the mouse.

- A click on the **Animation** button  activates the animation mode. The object can be pushed by dragging in the **Image Display** window and rotates continuously. Any new push with pressed left mouse button changes the rotation direction and speed of the animation.

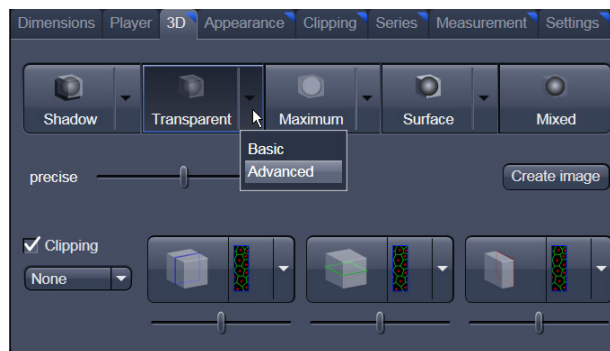


Fig. 639 3D View Control Panel, Transparent

## 6.9.2 Transparency Render Mode

Principle:

In the **Transparent** mode a three-dimensional image with a transparent effect is calculated. At least two two-dimensional texture stacks (computed from two different angles) are used depending on the volume orientation. In contrast to the Shadow mode the scene here is illuminated by diffuse white light from the rear. By changing the available parameters one can mix different channels and reveal relationships between information in those channels. This view is particularly useful for visualizing the three-dimensional relationships between structures within the volume. This mode can be displayed both in CPU based Voxel mode (**Basic**) and also (with the help of a suitable graphics card) with accelerated calculations in so-called OpenGL mode (**Advanced**).

**Basic** Transparency rendering (voxel based) (CPU)

**Advanced** Transparency rendering (voxel based) with textures (GPU)

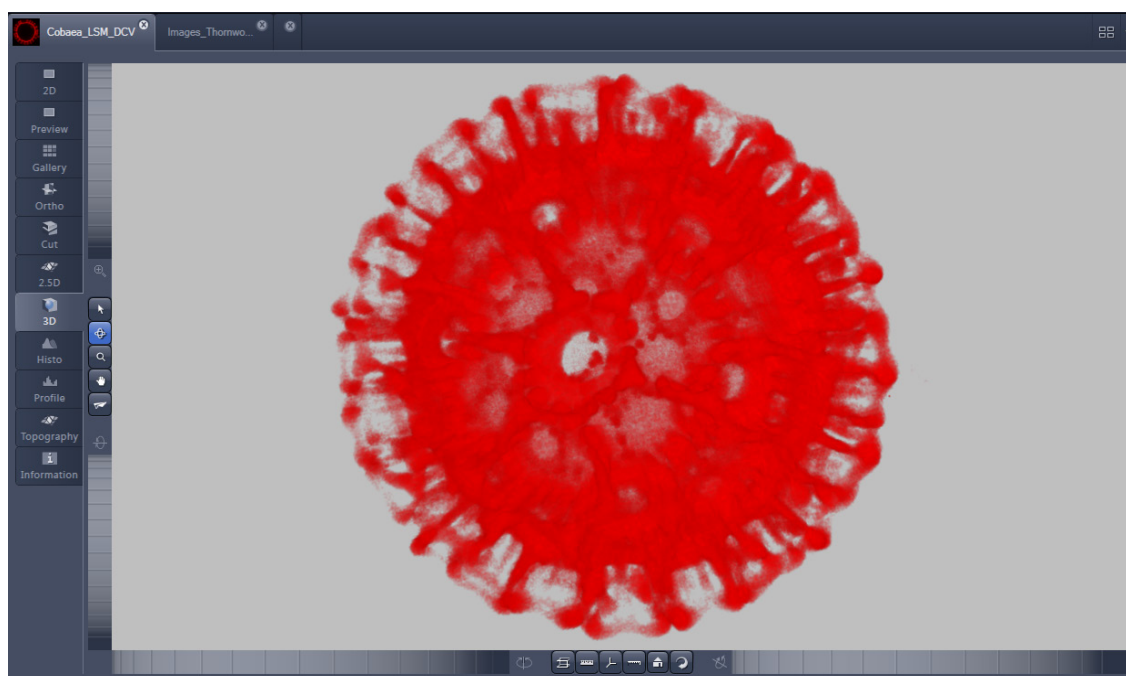

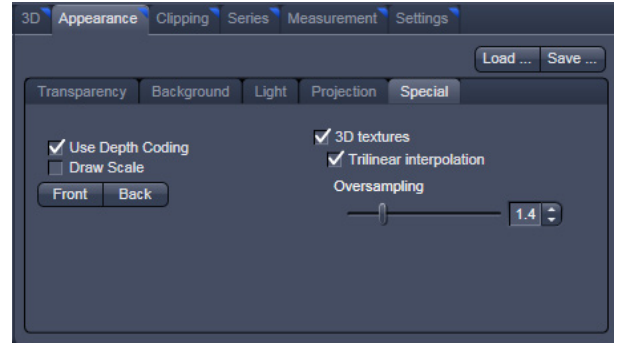


Fig. 640 Image Display window, 3D display, Transparency projection, Advanced

By means of the **Depth Coding** function (Fig. 641), the Z-information contained in a sequence can be colored with the colors of the rainbow, in which case "blue" stands for higher values and "red" stands for lower values.

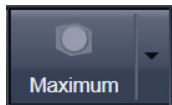
The **3D Textures** option can be used for faster and better rendering of transparency renderings.

 Note that this function is only available in Transparency and Maximum Intensity Render Modes.




**Fig. 641 3D toolbar – Transparent – Depth Coding**

**6.9.3 Maximum Mode**



Clicking on the **Maximum** button switches to **Maximum projection** mode, which calculates a three-dimensional view of the data by only showing pixels of the highest intensity along the projection axis. This view is particularly useful for displaying three-dimensional images in two dimensions, e.g. in publications, and guarantees a maximum possible degree of transparency. The display in this mode can be calculated by the main processor (CPU) of the computer (Maximum basic) or the graphics card (Maximum advanced) in OpenGL mode.

 Note that this is a rendering. If desired 1:1 Maximum Intensity Projections can also be done in the Processing **tab** in Maximum Intensity Projections (see section **Processing – Maximum Intensity Projection**). With these Images exact Intensity Measurements can be performed.

**Maximum Basic**                      Maximum Intensity CPU based

**Maximum Advanced**            Maximum Intensity GPU based

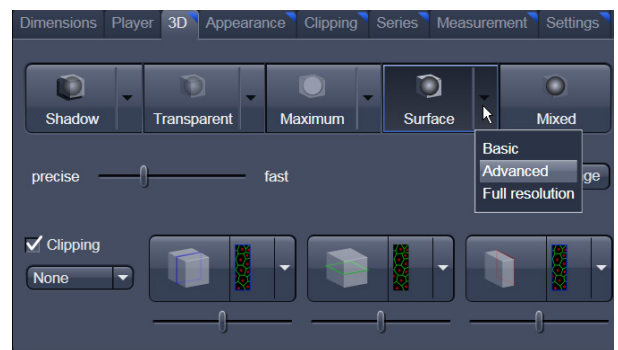
**6.9.4 Surface Render Mode**

In the **Surface** mode (Fig. 642) grey values in the image are computed as solid surfaces (also known as Iso surfaces) instead of soft transparent shades.

This display mode is useful to focus the attention on certain structures (e.g. plant cell walls, nucleoli, intracellular vesicles) while potentially hiding additional structures deeper within.

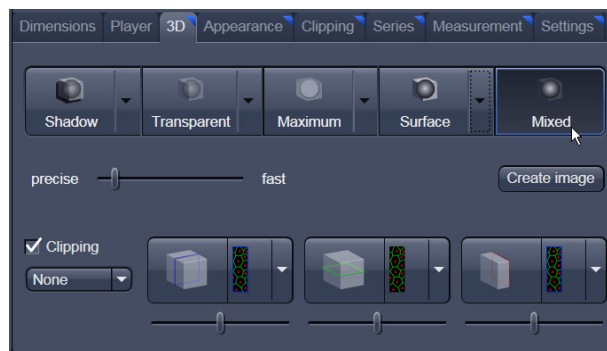
In this mode you also can select between Voxel (CPU) [basic] and OpenGL (graphics card) [advanced] display.

The [full resolution] projection is based on a high precision calculation method for 3D information on the basis of triangles with maximum resolution.



**Fig. 642 3D toolbar – Surface**

<b>Basic</b> button	Surface rendering (voxel based)
<b>Advanced</b> button	Surface rendering (triangle based)
<b>Full Resolution</b> button	High accuracy surface rendering (triangle based)



**Fig. 643** 3D toolbar – Mixed


### 6.9.5 Mixed Render Mode

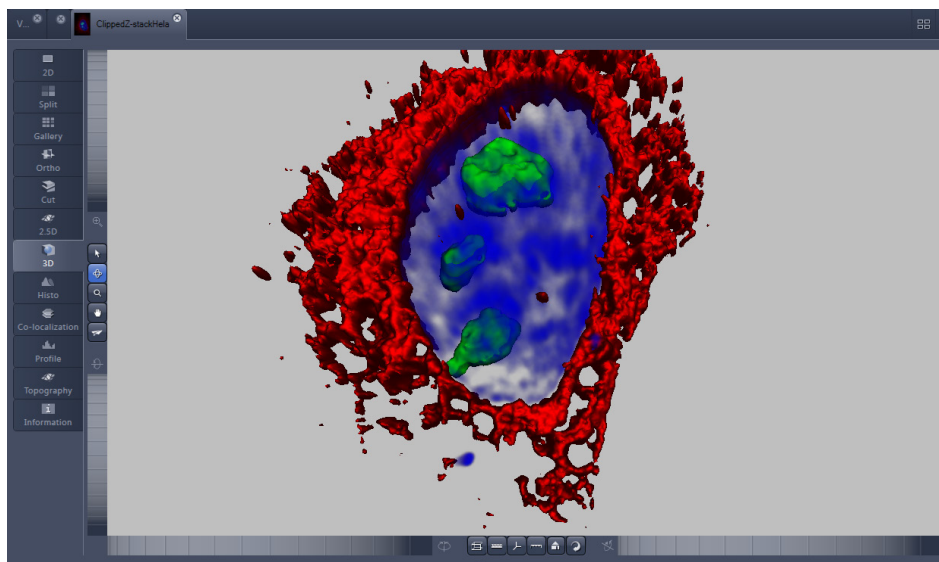
In **Mixed** mode both, transparency and surface mode, can be mixed in one volume display.

Using this mode one can render small structures within cells such as vesicles or speckles (e.g. FISH signals) as surfaces in one channel of a multichannel image while rendering the surrounding cytoplasm from another channel in transparency mode.

This way one can also visualize more complex relationships convincingly.

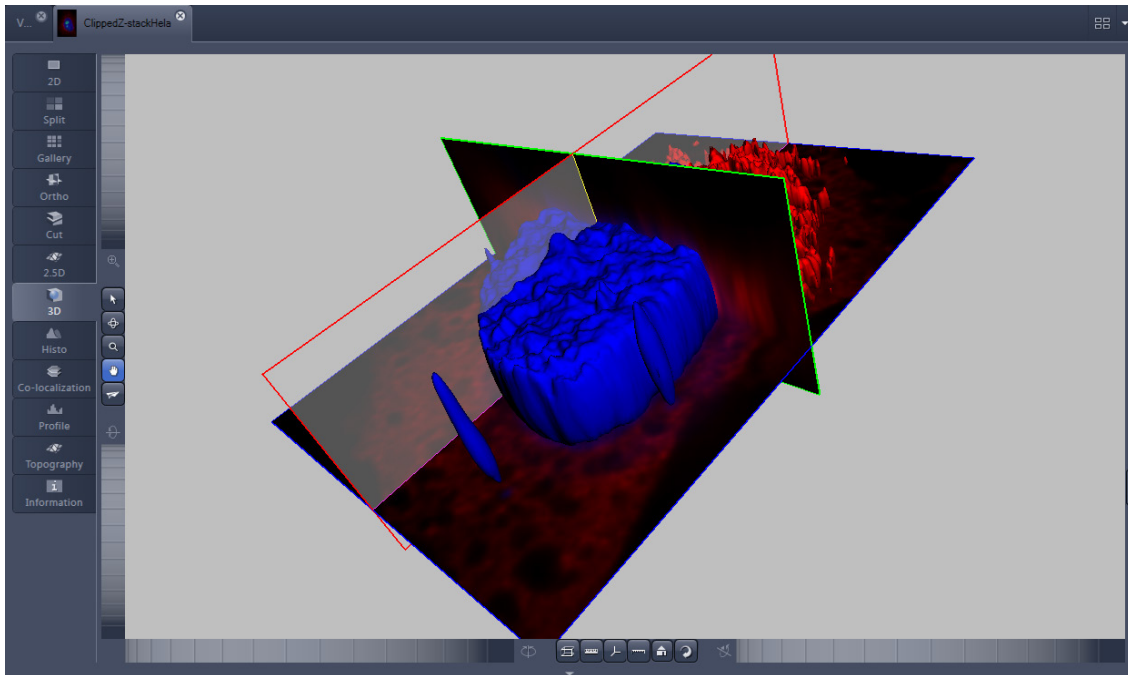
The render mode (**Transparent**, **Surface**, **Surf.+Transp.**) can be chosen per channel.

 The channels can also be switched off individually by de-activating the channels in the **Dimensions** view control panel.



**Fig. 644** Image Display window, 3D display, Mixed projection

### 6.9.6 Clipping Planes



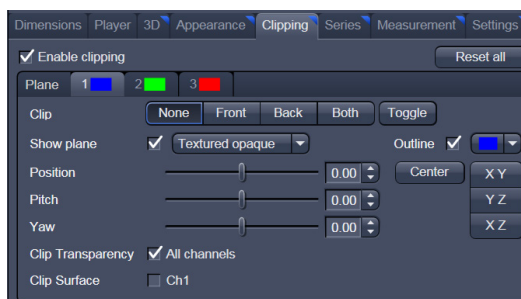
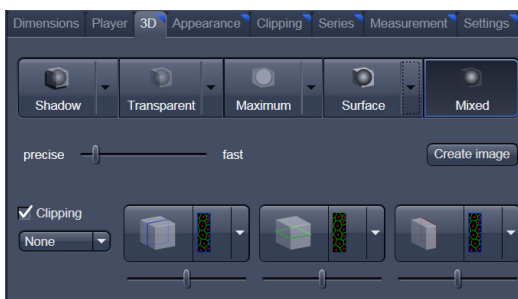
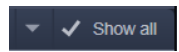
**Fig. 645** Image Display window, 3D display, Clipping planes

3D VisArt can display up to three so called **Clipping planes**. These planes can be used to cut the volume open in order to visualize structures which are within a given volume. Clipping planes make most sense when used in the **Surface** and **Mixed** mode but can also be used with limited functionality with the rendering modes **Maximum** and **Transparency** as well as in the Split mode (see below)

The clipping planes can be accessed via the **3D** tab or the **Clipping** tab. On the 3D tab only the most commonly used functionality is available. The full functionality can be accessed on the **Clipping** tab.



Note that the **Clipping** tab is only available with the **Show all** mode active.

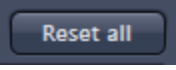


In **Surface** mode clipping planes can be used in a channel specific manner. This means, that in a multichannel image one can selectively cut away portions of the volume in one channel in order to unveil other structures from other channels. This technique is also applicable in **Mixed** mode.

A further possibility is, to use clipping planes in order to display only the grey values of the volume which touch the clipping plane.

All these functions can be used for creating a render series in order to show them and to make spectacular movies for presentations.

There are three clipping planes, which are labeled for ease of use with colored outlines. These outlines do NOT represent the channels. The standard orientations of the planes are **blue**: XY plane, **green**: YZ plane and **red**: XZ plane. This is linked to the default orientation of the volume axis.

Activating the **Clipping** panel displays the clipping planes and displays those with default settings if the image was not opened in the 3D module before.  is setting back the appearance of the planes to the following settings:

- Each plane is placed into the center of the volume and oriented in orthogonal fashion.
- The planes have an opaque surface and colored outlines.
- The clipping functionality of the planes is not activated in this state.

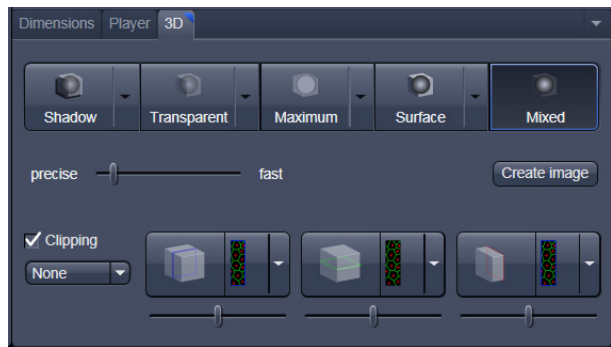



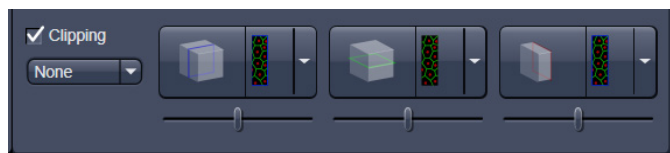
Fig. 646 Toggle buttons

### Controlling the clipping functionality of the 3 planes






The clipping planes are operated by three buttons on the **3D** tab which are color coded in the same way the respective planes are color coded. The buttons are located below the **Render Mode Buttons** and can be activated by ticking the **clipping** tick box.

 Note that full functionality of the clipping planes can be found in the **Clipping View Control** tab!

By toggling these



buttons, the clipping behavior of the planes can be set in the following manner:


- **None**: hides the plane completely 
- **Front**: clips away the data on the front side of the plane 
- **Back**: clips away the data on the back side of the plane 
- **Both**: clips away the data on both sides of the plane 
- **Show Plane** only displays the plane – no clipping 



These adjustments can be made individually for each plane. The clipping planes can be chosen by selecting the respective button.

### Appearance of the clipping planes

By default the clipping planes have an opaque surface and a colored outline. This can be changed by using the dropdown in the **3D View Control** tab. In the **Clipping** View Control tab, this function can be found in a pull down.

 This function is applicable to all 3 clipping planes separately.

Colored:  
white - opaque surface of the plane

**Binary:**  
displays the binary data on the clipping planes


**Textured:**  
Data which are touched by the plane are displayed on the clipping plane as in the render mode **Transparent** but as a two-dimensional projection. This does include the settings (threshold, ramp etc) applying for **Transparent** render mode. Black pixels are transparent.


**Textured fine:**  
Same as above but with 4x times the resolution

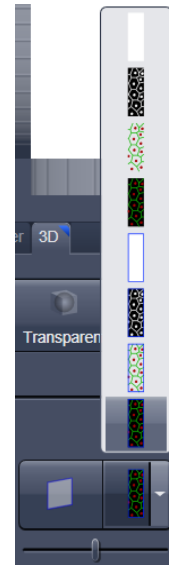
**Transparent:**  
Data which are touched by the plane are displayed on the clipping plane as in the render mode **Transparent** but as a two-dimensional projection. This does not include the settings applying for **Transparent** render mode. Black pixels are transparent.

**Textured opaque:**  
as with **Transparent** (including the settings) but in this case black pixels are non-transparent, rendered volume data in the background do not shine through.

### Interactive positioning of the clipping planes

The clipping planes can be moved interactively with the mouse by activating the  button. If hovering over a plane outline of the plane turns into a different color, the cursor turns into a crosshair indicating that the plane can now be moved. Clicking and dragging then moves the plane. The clipping behavior (e.g. "front") is maintained during the movement.

 These movements can also be "recorded" using the render series function.



**Fig. 647** Clipping planes

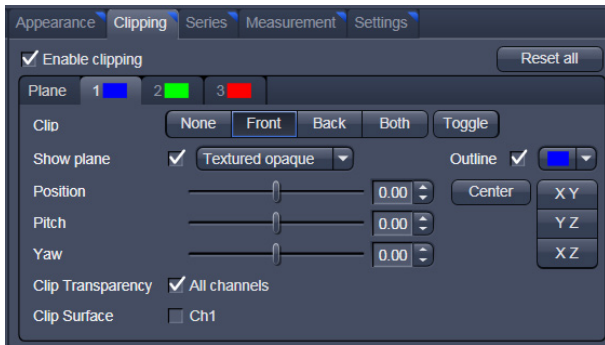
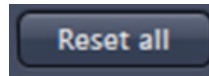


Fig. 648 Clipping planes settings

### Clipping Planes Settings

Activate or deactivate the clipping functionality globally by the check box **Enable clipping**.



displays the three clipping planes in the default mode (opaque surface, colored outlines, clipping planes active, no clipping).

With the **Plane** tabs the planes can be addressed individually and their settings can be adjusted independent from each other.

**Outline** displays or hides the colored outlines. The actual color can be chosen from a color chooser for each plane individually.

**Show Plane** hides or displays the plane.

A plane can cut away information whilst being "invisible".

For distance or angle measurements on a clipping plane the plane has to be displayed and a color has to be chosen for the clipping plane.

The appearance of the plane can be selected from a drop-down menu (see Fig. 647).

**Clip** names a row of toggle buttons switching between different clipping modes as named on the buttons

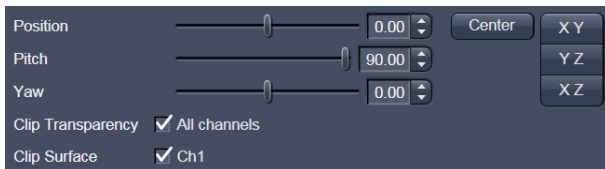



Fig. 649 Sliders Pitch, Yaw and Position


Using the **Pitch**, **Yaw**, and **Position** sliders each plane can be freely orientated in three-dimensional space.


### 6.9.7 Flying Mode

The **Flying** mode is an interactive way to explore three-dimensional data. By pressing the mouse wheel you can fly into and through a dataset. Moving the mouse left / right and up / down controls the flying direction. Pressing the mouse wheel and the right mouse button at the same time allows for flying backwards.

 Once the **Flying** mode is activated, the rotation of the data switches modes: Whereas normally the data turns around an imaginative point in the center of the dataset, in the fly mode the data turns (if moved interactively with the mouse once one stops flying) around an imaginative point

"behind" the operator. Pressing the  button switches back into the normal mode.

If a wheel-mouse is not available, pressing the  button turns the left mouse button into the **Flying** button.


 The **Flying** mode is only available in graphics card accelerated render modes.

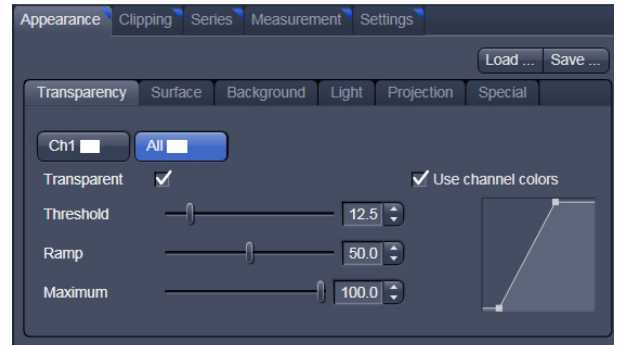
### 6.9.8 3D Rendering Settings in VisArtplus

Depending on the render mode selected the following adjustments can be applied to the datasets:

All settings can be saved and re-applied to other datasets by using the  buttons.

- Threshold specifies a lower threshold as a percentage of the gray values displayed. This decides which data enter the rendered image. If one fluorescence channel contains a homogeneous fluorescence signal with high signal strength, one would set the threshold higher in order to "protect" signals from weaker channels from being quenched.
- Ambient describes a diffuse, non-directed light source, which lets both bright and dark structures appear darker or brighter in an equal fashion (values on a scale between 0 and 100).
- Specular sets a directional brightness (values on a scale between 0 and 100). Influences the differences between dark and bright structures, which are strongest at a value of 0.
- Shininess changes the surface gloss (on a scale between 0 and 100).
- Ramp controls the degree of the transition from completely transparent to completely opaque.
- Maximum influences the degree of opacity.

The settings are combined into a histogram . The x axis corresponds to the gray values and the y axis to the degree of opacity. You can also use the mouse to interact with the histogram curve.



**Fig. 650 3D Rendering window (e.g. Surface Advanced rendering mode)**

- Roughness (for Shadow mode only): You can also influence the roughness used to display the surface of the image structures. This changes the plasticity of the display (relative scale between 0 and 1). This setting quickly can produce artifacts if pixels reach saturation. The degree of roughness should be reduced accordingly.
- Brightness can be controlled via input field or slider bar.
- Distance determines the distance between light source and volume. At a value of 0.1 the light source is close by, shadow effects etc. are minimal. The further away the light source, the more prominent the shadow effects become ("evening shadows are longer").
- Azimuth describes the angle of the light source above the virtual horizon and can be set by entering values directly or by slider (value range: 0° to 90°).
- Elongation describes the horizontal direction of lighting and can be set by entering values directly or by slider (value range: -180° to +180°).

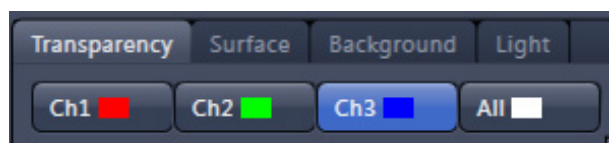



Fig. 651 Channels

- Channels: The settings are entered separately for each channel using sliders or by entering a numerical value in the corresponding input field. To select a channel click on the corresponding button (labeled with the channel color and number).

- **Distance** (for Shadow mode only) sets the distance between the 3D object and the virtual background on a scale from 0.5 to 3.0.
- **Color**: The color of the background can be freely chosen from a table which appears when clicking the color chooser button .

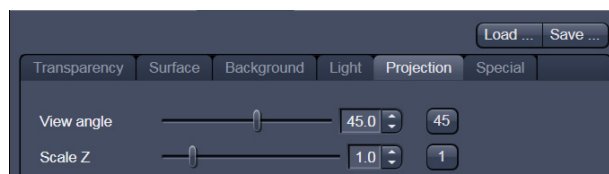


Fig. 652 Viewing angle

- **View angle / Scale Z**: In hardware accelerated modes, you can change the projection angle used to view the scene anywhere between 10° and 80°. Use the slider or enter the **Angle** into the input field. The effect of this on the display perspective is similar as if you were viewing the 3D image through a telephoto or wide-angle lens. The Z-Scale of the dataset can be altered interactively by using the slider. The slider ranges from a factor of 0.1 to a factor of 5.

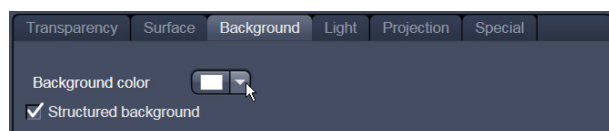


Fig. 653 Background

- **Background**: The background color can be altered by using the pull down menu. For some 3D Objects it can be beneficial to display a **Structured background** for better orientation within the dataset.

### 6.9.9 Series

The **Series** tab (Fig. 654) displays the **Render Series** control panel. This panel allows settings for the axis to be used for rotation of the 3D reconstructed images. This feature is applicable to all render modes available in 3D VisArt.

There are four different modes for producing render series (see Fig. 656).

Depending on the activated mode, directly set the parameters for animation in the **Render Series** window and the position of the 3D image in the **Image Display** window (zoom, rotation axes, rendering parameters).

Click on **Apply** to start the animation

The animation is performed in a separate **Image Display** window, which permits the animation to be saved afterwards.

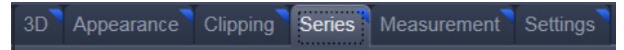


Fig. 654 Series tab



Fig. 655 Render Series window (e.g. Turn around X mode)

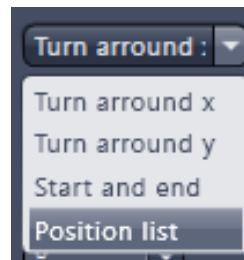


Fig. 656 Render Series modes

#### (1) Turn around X and Turn around Y mode

In this mode, the image is turned around the X-axis or the Y-axis exclusively.

The values for **Number of Views**, **Difference Angle** and **First Angle** can be selected accordingly).

#### (2) Start and End mode

In the **Start and End** mode, the image is reconstructed between a start position and an end position.

The rotation angles for X, Y and Z and the distance (zoom) can be determined using the sliders.

The value for **Total frames** can be varied. The frames are distributed equally between the start and end points (Fig. 657).

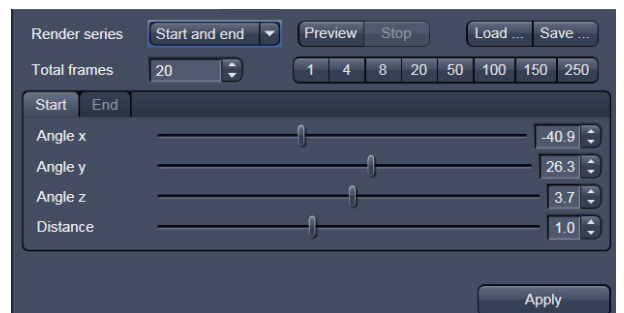
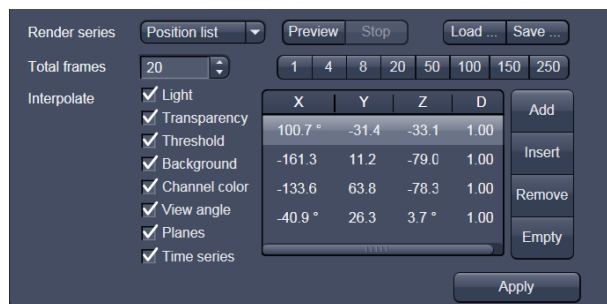


Fig. 657 Start panel in the Render View control block



**Fig. 658** Render Series window - Position List mode

### (3) Position List mode

In the **Position List** mode, the image is reconstructed between any required number of interim positions to be determined individually. Just rotate the reconstructed image with the mouse or do any other adjustment and add this as a "position" in the position list. The module will create a movie using those positions as a guideline. It will interpolate all the parameters ticked in the list.

The rotation angles for X, Y and Z and the zoom can be determined directly in the image.

Every required interim position is included in the list of the **Render Series** window with a click on the **Add** button.

**Remove** permits the contents of the list to be deleted. **Insert** inserts a position above the highlighted list entry.

The value for **Total frames** can be varied. A value of 20 produces a render series with 20 frames in total. Interpolate lists variables that are interpolated during the Render Series.

Pressing the **Preview** button creates a short and low resolution (no interpolation!) preview of the rendering using the positions currently in the list. This serves as a help to quickly review the rendering without actually starting the process (which might be time consuming in cases of long position lists).


Click on the **Apply** button calculates a spline along all the defined positions from the list and starts an animation along this spline track in space.

### 6.9.10 Interactive Measurements

3D VisArt features three tools for interactive measurements in Euclidian space. Measurements can be performed in all graphic-card accelerated modes (**Transparency**, **Surface**, **Maximum** and **Mixed**). The measured tools are shown as shapes in the rendered volume and can be changed there interactively. Measurement values can be exported as a table to the clipboard for downstream processing in other programs.

First a suitable tool has to be chosen. In order for measurements to work, the mouse cursor must "recognize" a structure. In the **Surface** mode this is a uniquely identifiable surface structure, for the transparent modes the tools look for the highest local gray level maximum.

As a sign, that the mouse cursor has "found" a structure, the cursor shape changes from  into .

The found measurement point is drawn as a blue circle .

#### Interactive 3D-Measurement

The measurement dialog contains a toolbar with the available measurement tools.

The **Line** tool measures the length along a line in  $\mu\text{m}$ . First click on a starting point and move the mouse to the desired end point while keeping the left mouse key depressed. The measurement is concluded upon releasing the left mouse key.

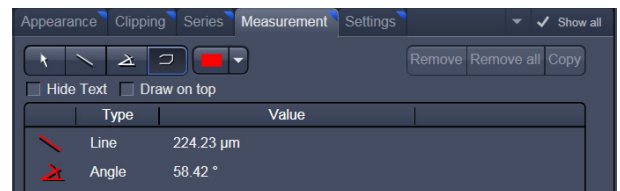


Fig. 659 3D Measurement View control block

The **Angle** measurement tool defines an angle between two connected line segments. First define the starting point by clicking, and then draw the first line segment until you click on the first endpoint. Now draw the second line segment and conclude the measurement by clicking onto the second end point. This measures the angle in degree.

The **Curve** tool measures the total length ( $\mu\text{m}$ ) along a variable multi-segmented polygon line. Please click from point to point and finish the measurement by clicking with the right mouse key.

Measurement values are compiled in a list. In order to delete a measurement, select it in the list and press the **Remove** button. One can also delete all measurements by clicking on **Remove all**.

The measurements can be copied into the clipboard with the **Copy** button.

Measurements are only transiently drawn into the volume and are not stored automatically with the image.

## 6.9.11 Settings

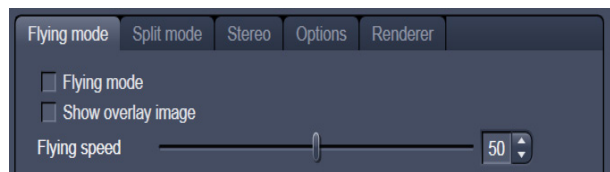


Fig. 660 3D Renderer Settings – Flying mode

### Flying mode

Ticking the tick box **Flying** mode activates the mode, unticking deactivates it.

To show or hide an overview image tick the **Show overlay image** box.

The fly-speed can be adjusted in a range from 1 to 100.

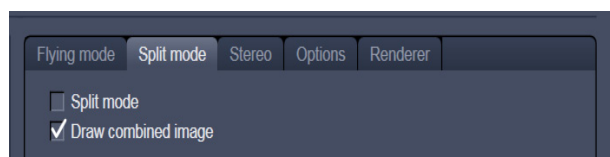


Fig. 661 3D Renderer Settings – Split mode

### Split Mode

Ticking this tick box activates a channel wise 3D split view of the data. This is only available in surface render mode only. An overview image with all channels combined can be shown optionally by ticking **Draw combined image**.

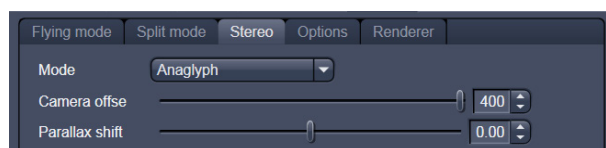


Fig. 662 3D Renderer Settings – Stereo

### Stereo

Two Stereo views can be chosen from this sub-menu:

**Anaglyph** is a view in which the data can be examined in 3D using red/green glasses. The image is built up twice (once each for the red and green colors), resulting in a stereoscopic image.

The stereoscopic effect can only be seen with the aid of red/green 3D goggles. The red lens is to be used for the right eye and the green lens for the left eye.

**Camera offset:** Defines the distance of both cameras from each other (units in meters).

**Parallax shift:** Determines the degree of shift which is necessary to correlate both camera views. The slider should be adjusted to maximize the stereo effect. Please note, that this setting will be different for each observer.



### 6.9.12 Options

**XY Textures only:** Instead of working with three texture stacks per dataset in transparent render mode, the system will only use one texture stack. This will result in faster renderings. Looking at the dataset from aside although will make the individual z-planes visible.

**Inner surface lighting:** If checked, illuminates the inside of a surface rendered volume. If unchecked, the inside is dark. If one views the inside of a volume by flying or zooming into it, the inside illumination is helpful. This option is only available for the **Surface** mode.

**Lit front and back side:** With activated **Inner surface lighting**, this check box colors the inside lighting with a bluish hue. This makes distinguishing inside from outside easier. This option is only available for the **Surface** mode.

**Draw border triangles:** When displaying the data touching the six sides ("borders") of the Z-Stack in 3D, the triangles used to do this are all located in one plane and orientation. This can cause artifacts, therefore the display of those border triangles can be switched off.

**Texture switch angle:** This parameter influences the volume angle, upon which the next set of 2D-Textures will be loaded into the graphics card (value range 1 to 100 degree). Depending on the object orientation, the number of z-slices and the chosen render settings this loading process can be visible and may be disturbing especially when rendering a series for movie export. Changing this angle can postpone or even avoid this switch during a series rendering. This option is only available for **Transparency** and **Maximum** modes.

**Image Rotation with mouse:** Activates a method to rotate the dataset interactively with the mouse. In addition to rotating it freely, when clicking and dragging at the sides of the image window the dragging rotates the data around one axis only. Just like the wheels on the 3D window frame.

**Mouse Sensitivity:** Influences the mouse sensitivity (value range: 1 to 200). Small values make the mouse actions precise but slow, large values less precise but faster.

**Texture Opacity:** With this slider the  $\alpha$ -values of the dataset can be adjusted. The rendering is getting more or less transparent using this setting.

**Reset:** Sets all render settings back to the factory standard settings.

#### Renderer Options:

**Renderer:** OpenGL Software is rendering the 3D data with the CPU; OpenGL Hardware uses the Graphics card to do this. Especially when having trouble with non Zeiss-certified graphics cards it is sometimes useful to switch to a pure CPU based rendering.

**Palette textures:** This feature is an optimization feature not supported by modern graphics cards any more. It used to optimize display of single channel images.

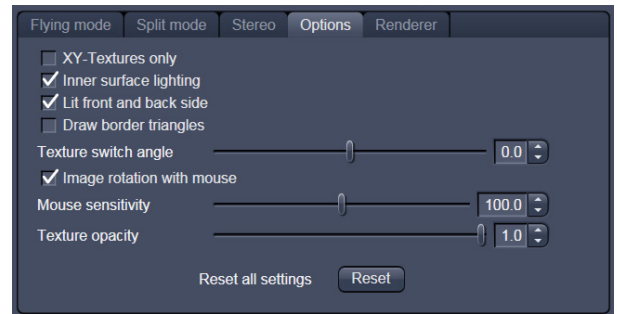


Fig. 663 3D Renderer Settings – Options



Fig. 664 3D OpenGL Renderer settings

**Intensity Alpha textures:** This feature optimizes the usage of the graphic ram with single channel images.

**Display Lists** activates a batch processing of the operations the graphics card is doing. It results in faster rendering.

**Hardware accelerated series rendering:** Un-ticking this feature uses the Computer Processor for render series. In case of trouble with non-certified graphics cards render series can be performed with the CPU without risk. The use of memory of the graphics card can be adjusted in a dialog box.

**Window independent series image size:** Using this feature creates render series (see section **Series**) with the output size indicated in the two input boxes. The maximal resolution is 4096 x 4096 pixels. This feature is available in all Render Modes (CPU and GPU accelerated). This applies also to the "**Create Image**" button on the **3D View Options** tab.

**Allocate Graphics Card RAM:** The amount of Graphics card RAM can be freely defined in the last Item on the **3D | Settings** view control panel. Default sets this value to ~ 80 % of the available RAM of the currently used graphics card.

### 6.9.13 3D View – Basic

Without a license for ZEN Module 3D VisArt the following features are available:

- Shadow view - Front view,
- Transparency render mode - Basic, rotate around x or y render series,
- Maximum brightness projection – Basic Mode only, only rotate around x or y, or start to end movies,
- Surface - Basic Render Mode, rotate around x or y movies,
- Stereo Anaglyph Mode.

## 6.10 Histogram View

The **Histogram View (Histo View)** allows to

- display a histogram (distribution of pixel intensities) of an image or Region of Interest,
- show the histogram values in table form,
- copy table to clipboard or save as text file,
- measure area and mean gray value and standard distribution in an area.

The settings of the **Dimensions, Display, Player** and **Graphics** view options control blocks apply. The additional view-specific **Histo View Option** control block is shown in Fig. 665.

Any changes done with this View Option control block are effective immediately.

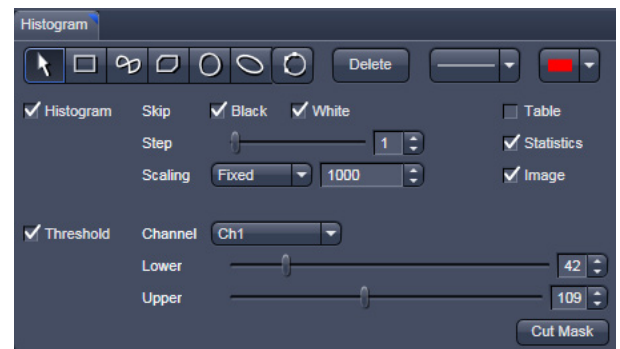


Fig. 665 View Option control block - Histo View

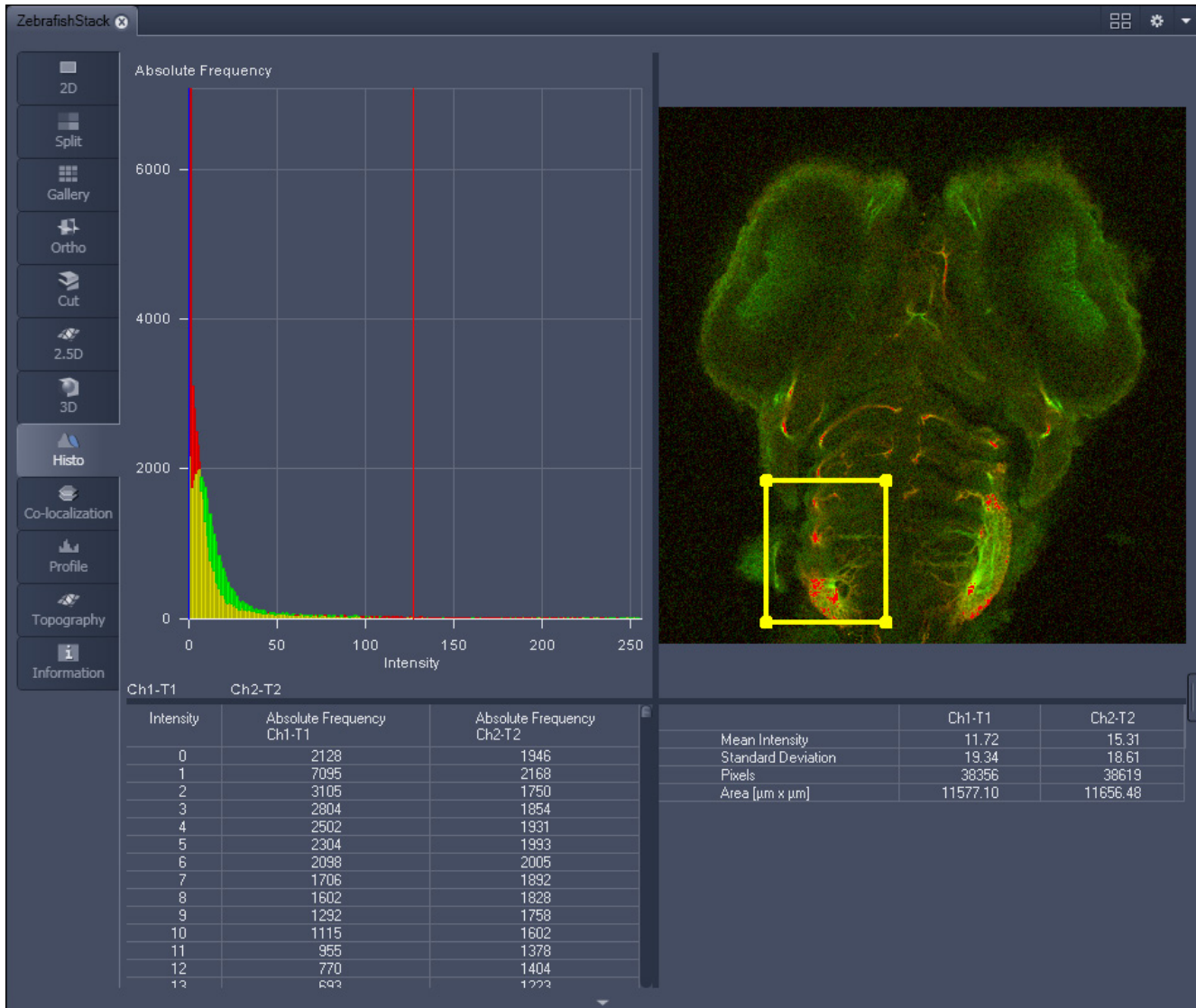


Fig. 666 Image Display, Histogram view

 The **Histo** button can also be used online during scanning.

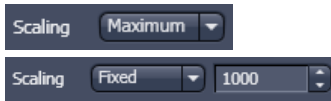
Histogram functions:



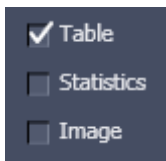
**Skip Black** and **Skip White** tick boxes: Ignore black pixels (gray value 0) and ignore white pixels (gray value 255 or 4096) in the histogram.



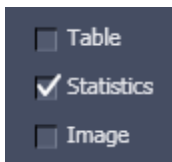
**Step** slider and spin box: Sets the number of intensity steps ("trays") of the histogram display. Step 1 corresponds to 256 intensity steps, Step 64 to 4 intensity steps (for 8 bit images). Reduction is made by averaging.



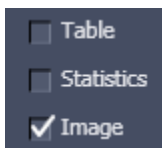
**Scaling** pull down menu: Sets the histogram graph scaling to either dynamic (adjusting to the maximum value) or fixed



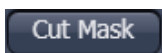
**Show Table** tick box: A table of the intensity values is shown in the **Image Display** window.



**Show Statistics** tick box: Displays statistical parameters (Mean Intensity, Standard Deviation, Number of Pixels and Size of Area) in an additional table. Area measurements of very small areas (<10 pixels) give only approximate values.



**Show Image** tick box: Shows the image in the **Image Display** window with the histogram graph.



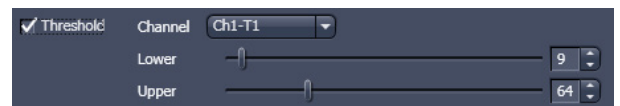
The **Cut Mask** tool creates a new image document which sets every pixel outside ROIs to Zero. Within the ROIs, only the pixels with values between lower and upper threshold are transferred to the new image.



Tables can always be saved or copied to the clipboard by right-mouse clicking on the table display!

Histogram functions and Overlays:

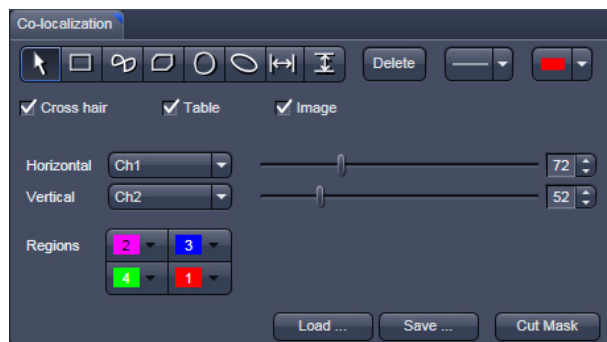
The functionality of the **Graphics View Option** control block fully applies to the **Histo View** Type. If a ROI is marked/selected in the Histo View Image display, only this ROI will be taken into account for the histogram display, the table and the statistics. If there are several ROIs, but none is marked/selected, the histogram display, the table and the statistics analyze all the pixels included in all ROIs.



**Fig. 667 Histo View Option control block - Threshold**

### Histogram Threshold:

When the **Threshold** tick box is selected, the controls to set a lower and upper threshold for the histogram calculation are displayed (Fig. 667). The threshold can be set for each channel (channel selection pull down menu).



**Fig. 668** Colocalization View Option control block

## 6.11 Colocalization View

The **Colocalization** function permits interactive analysis of two channels of an image by computing a scatter diagram (co-localization).

The settings of the **Dimensions**, **Display**, **Player** and **Graphics** view options control blocks apply. The additional view-specific **Colocalization View Option** control block is shown in Fig. 668.

Any changes done with this View Option control block are effective immediately.

The Image Display in the Colocalization View shows 3 panels: the scatter diagram, the data table and the pseudo-colored image display (see Fig. 669 and Fig. 670).

☞ Colocalization is defined by the presence of two or more different molecules at the same location in a specimen. However, in the context of digital imaging, the term colocalization refers to colors emitted by fluorescent molecules detected by the same pixel in the image. It is important to be aware of the fact that colocalization cannot be analyzed for fluorophores with similar emission spectra. Accurate colocalization analysis is only possible if the fluorescence emission spectra are well separated between fluorophores and the correct filter sets (or spectral detection bands) are used for data acquisition. If spectral bleed-through artifacts are present because of spectral overlap between the fluorophore emission spectra, or due to the use of incorrect filter sets, colocalization measurements will be meaningless. To avoid this, the fluorophores must be carefully chosen and matched to the excitation laser lines to obtain the maximum excitation efficiency while still maintaining a useful degree of separation between emission wavelengths. The choice of fluorophores is crucial for colocalization analysis.

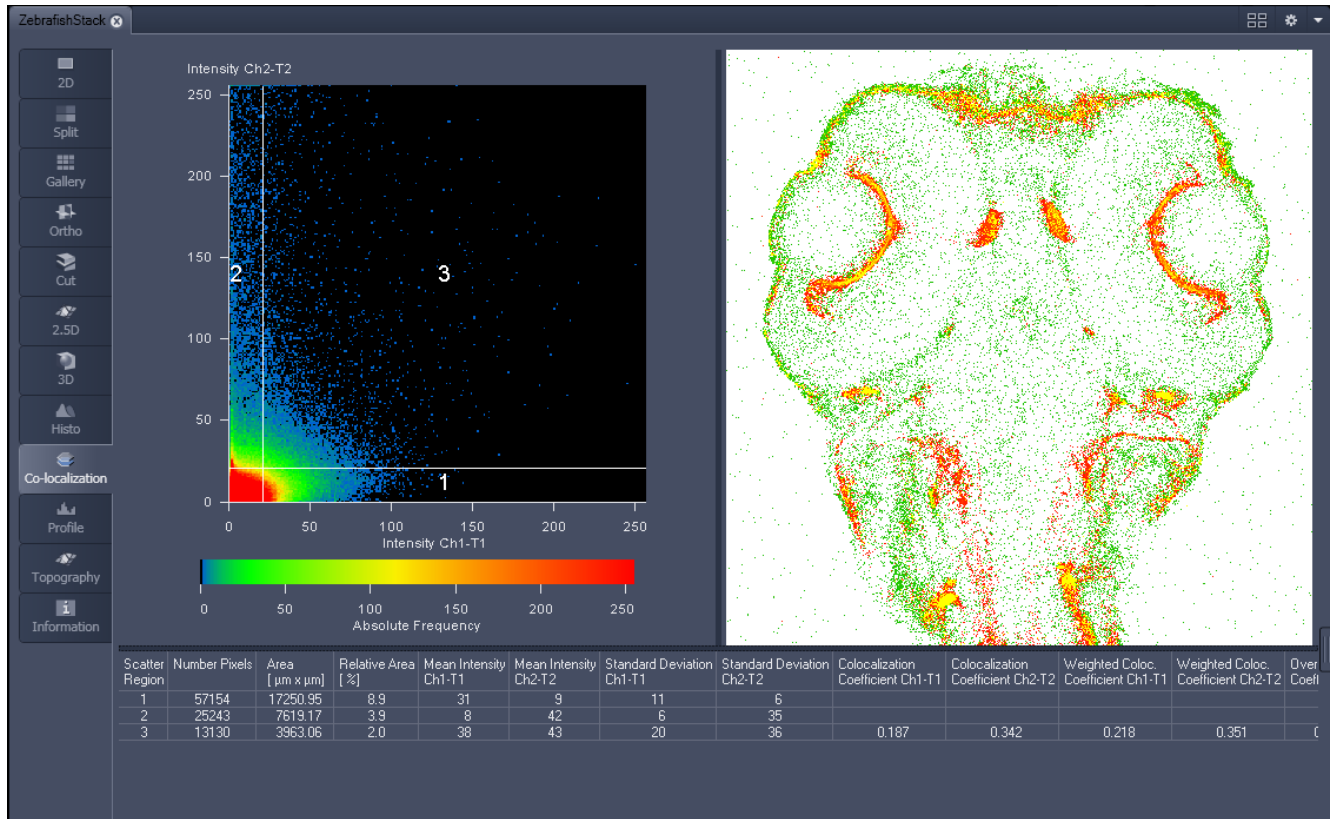


Fig. 669 Image Display, Colocalization view

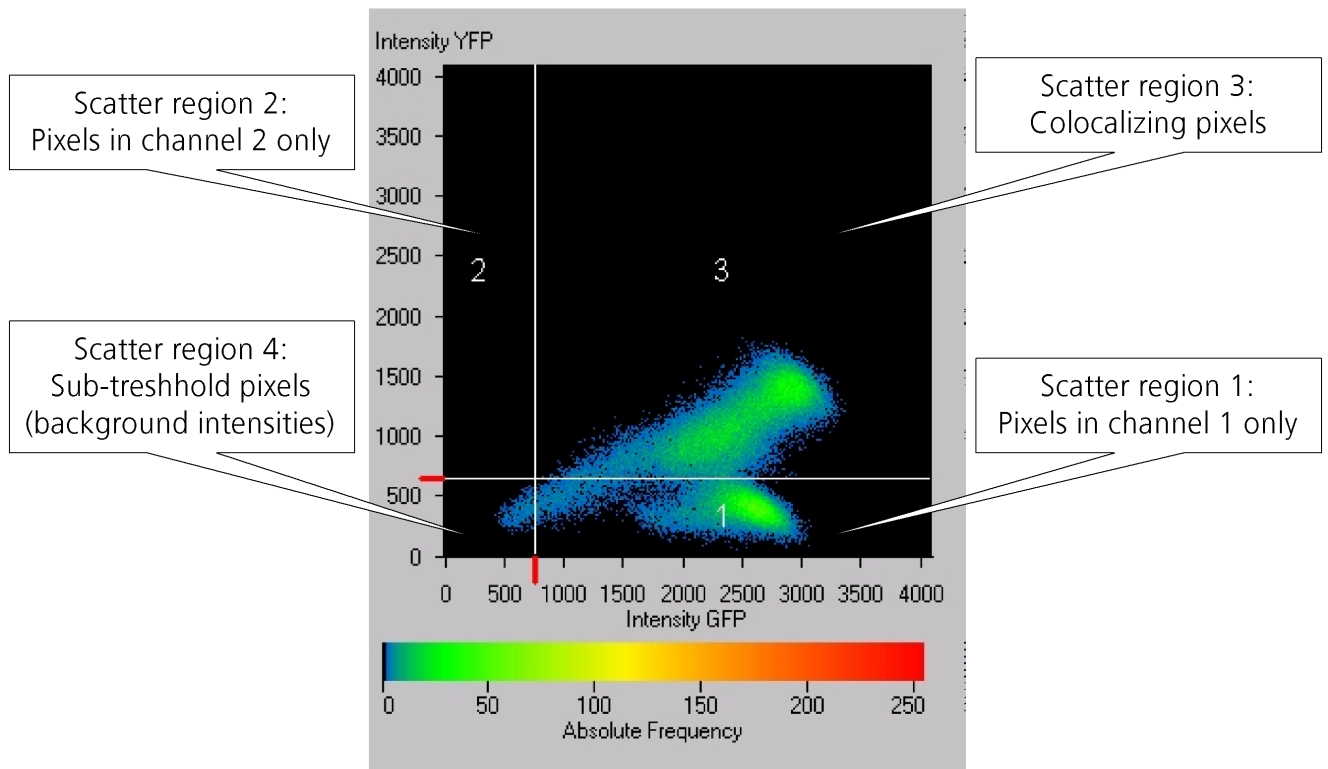




Fig. 670 Scatter diagram and threshold with crosshair

### 6.11.1 How a Scatter Diagram is Generated

All pixels having the same positions in both images are considered a pair. Of every pair of pixels (P1, P2) from the two source images, the intensity level of pixel P1 is interpreted as X coordinate, and that of pixel P2 as Y coordinate of the scatter diagram. The value of the pixel thus addressed is increased by one every time, up to the maximum number of pixels used. This way, each pixel of the scatter diagram is a value that shows how often a particular pair of pixels has occurred.

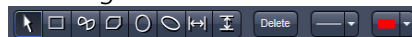
 Differences between the images cause irregular spots in the scatter diagram.

Identical images produce a clean diagonal line running from bottom left to top right, because only pixel pairs (0,0), (1,1), (2,2) with the same intensity can occur. Differences between the images cause an irregular distribution in the scatter diagram.

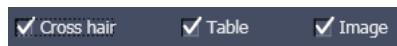
 Scatter diagram, image display and data table are interactively linked and immediately updated when settings are changed.

#### Available Controls:

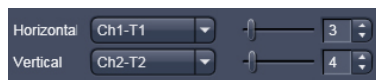
##### Drawing tools



With the drawing tools the colocalization analysis can be restricted to a region of the image. Tools in the Colocalization View Option control block and in the Graphics View Option control block work the same and can be combined.



The Cross hair, Table and Image selection tick boxes: when selected, the respective element is displayed in the Image Display area. If off, the element is hidden.

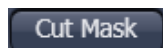


Scaling pull down menu: Sets the histogram graph scaling to either dynamic (adjusting to the maximum value) or fixed




Set the color LUTs for each quadrant in the image display to improve visibility of colocalized pixels.

The Load and Save buttons can be used to save colocalization settings (like color settings for the quadrants and crosshair-positions) to a \*.col file and re-load it when analyzing a different data set. This allows using the same parameter for the colocalization analysis of different images.



The Cut Mask tool creates a new image document which sets every pixel outside Quadrant 3 (not colocalized) to Zero. ROIs don't play a role for this Cut Mask function (as opposed to the Cut Mask in Histo View).

 Tables can always be saved or copied to the clipboard by right-mouse clicking on the table display!



### 6.11.2 Quantitative Colocalization Parameters Shown in the Data Table

- **No. of pixels** in image ROI or scatter region
- **Area / relative area** of image ROI or scatter region
- **Mean intensities / SD** within image ROI or scatter region
- **Colocalization coefficients**
- **Weighted colocalization coefficients**
- **Overlap coefficient** after Manders
- **Correlation coefficients** (R and R<sup>2</sup>)

### 6.11.3 Colocalization Coefficients

$$c_1 = \frac{\text{pixels}_{Ch1,coloc}}{\text{pixels}_{Ch1,total}} \quad c_2 = \frac{\text{pixels}_{Ch2,coloc}}{\text{pixels}_{Ch2,total}}$$

- Relative number of colocalizing pixels in channel 1 or 2, respectively, as compared to the total number of pixels above threshold.
- Value range 0 – 1 (0: no colocalization, 1: all pixels colocalize)
- All pixels above background count irrespective of their intensity.

Weighted colocalization coefficients

$$M_1 = \frac{\sum_i Ch1_{i,coloc}}{\sum_i Ch1_{i,total}} \quad M_2 = \frac{\sum_i Ch2_{i,coloc}}{\sum_i Ch2_{i,total}}$$

- Sum of intensities of colocalizing pixels in channel 1 or 2, respectively, as compared to the overall sum of pixel intensities above threshold and in this channel.
- Value range 0 – 1 (0: no colocalization, 1: all pixels colocalize)
- Bright pixels contribute more than faint pixels

Correlation coefficient, Pearson's correlation coefficient

$$R_p = \frac{\sum_i (Ch1_i - Ch1_{aver}) * (Ch2_i - Ch2_{aver})}{\sqrt{\sum_i (Ch1_i - Ch1_{aver})^2 * \sum_i (Ch2_i - Ch2_{aver})^2}}$$

- Provides information on the intensity distribution within the colocalizing region
- Value range -1 to +1
  - 1,+1: all pixels are found on straight line in the scatter diagram
  - 0: pixels in scattergram distribute in a cloud with no preferential direction

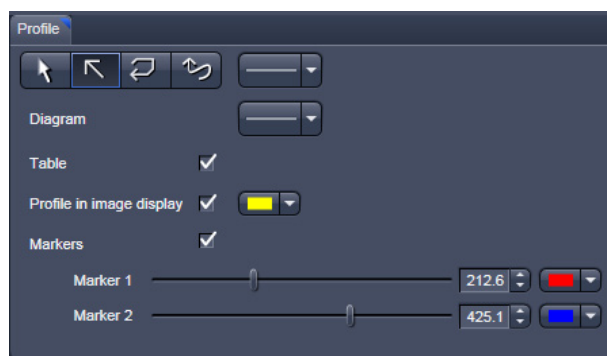
#### 6.11.4 Overlap Coefficient, Overlap Coefficient after Manders

(Manders, Verbeek and Aten, J. Microscopy 169:375-382, 1993)

$$r = \frac{\sum_i Ch1_i * Ch2_i}{\sqrt{\sum_i (Ch1_i)^2 * \sum_i (Ch2_i)^2}}$$

- Another parameter used to quantify colocalization in image pairs
- Insensitive to differences in signal intensities between the two channels, photo-bleaching or amplifier settings

Value range 0 – 1 (0: no colocalization, 1:all pixels colocalize)



**Fig. 671 View Option control block - Profile View**

control block is shown in Fig. 671.

Any changes done with this View Option control block are effective immediately.

The content of the overlay plane is temporarily hidden while the toolbar is displayed.

 The **Profile** View can also be used online during scanning.

- Draw a Profile line in the image display to define a profile. The intensity curves are shown in a separate graph (see Fig. 672).
- In the **Profile** View Option control block you can select the width and type of the profile line. The color setting is taken from the **Graphics** View Option control block.
- You can place two markers on the profile line to measure differences in intensities and distances in the XY plane.
- Tick the **Profile in Image Display** block to see an intensity graph superimposed on the image (see Fig. 673).

#### 6.12 Profile View

This function allows to

- display the intensity distribution of an image along a straight or curved line,
- show the intensity values in table form and copy table to clipboard or save as text file,
- show separate profiles for each channel in a multi-channel image.

The settings of the **Dimensions**, **Display**, **Player** and **Graphics** view options control blocks apply. The additional view-specific **Profile View Option**

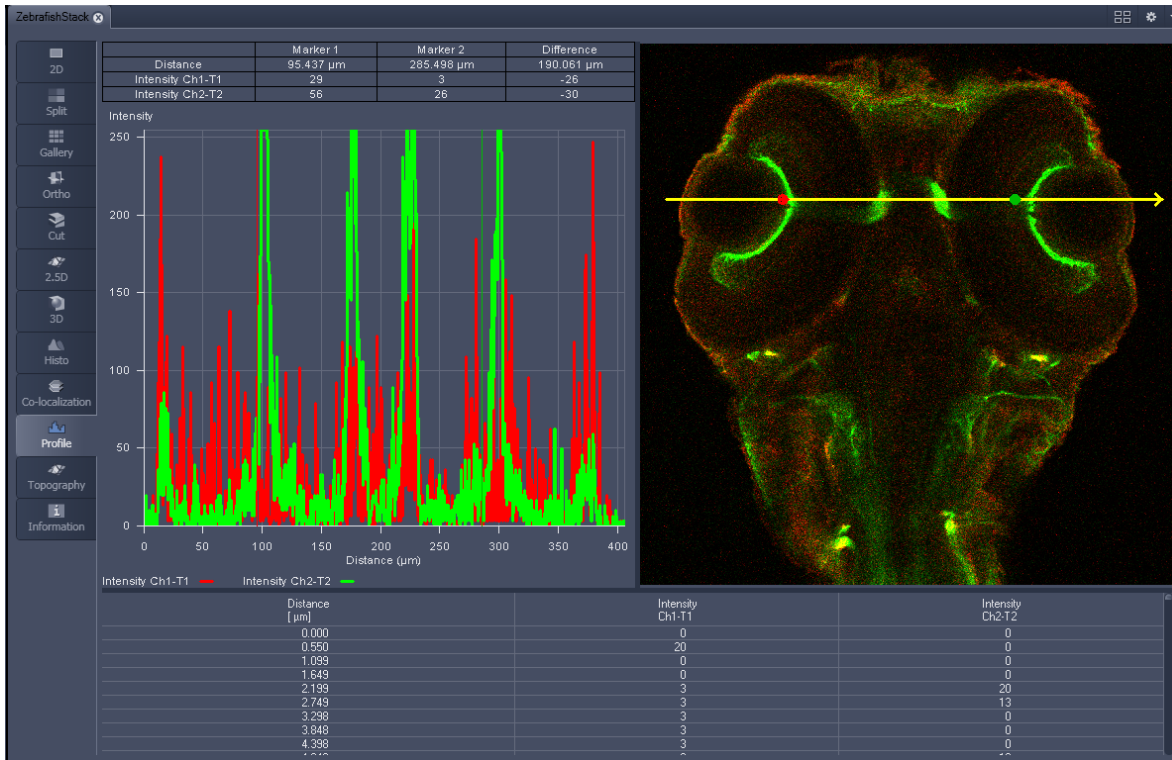


Fig. 672 Image Display - Profile View, Line Profile with markers

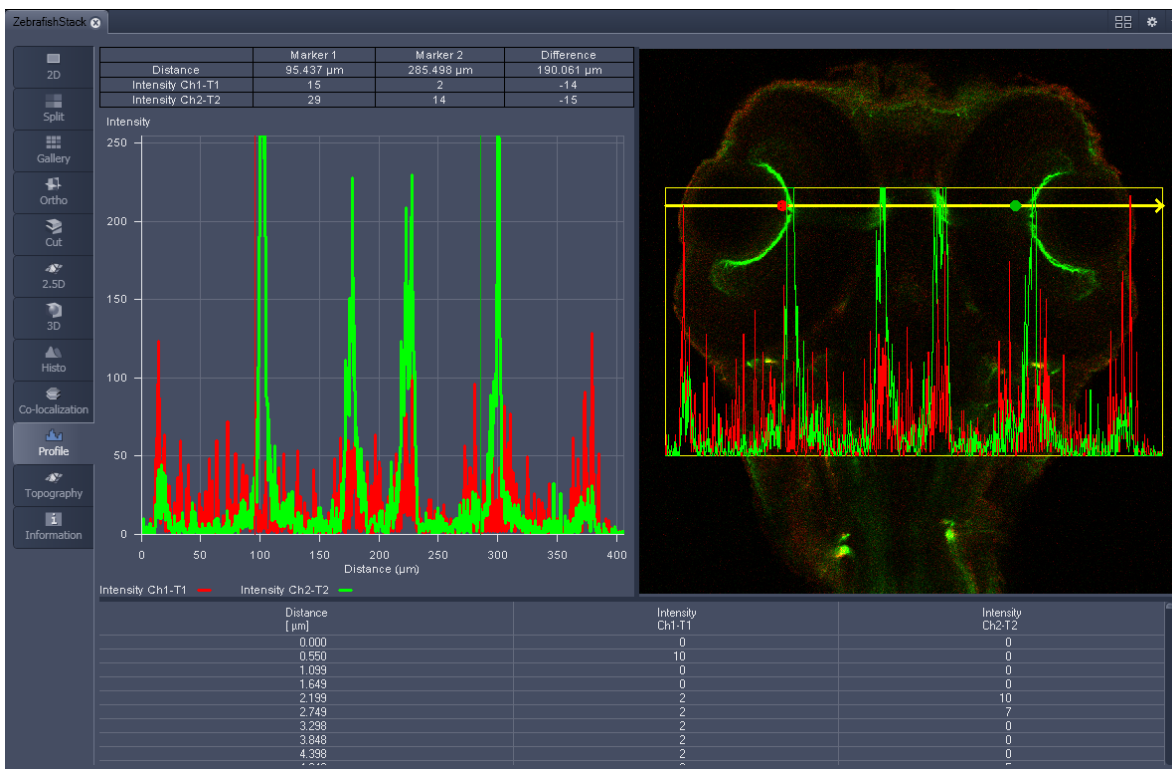


Fig. 673 Image Display - Profile View, Profile displayed in Image

## Control block tools

The **Profile** toolbar contains the following tools:



**Select** button: Activates the mouse button for selection, resizing or movement of the profile line in the **Image Display** window.

Resize: Click on handle and hold down the mouse button, move the handle, release mouse button.

Movement: Click on line and hold down the mouse button, move the entire line, release mouse button.



**Line with arrow** button: (open arrow): Activates the straight profile drawing mode.

Click into the image and hold the mouse button, drag a line in any direction and release the mouse button to end the procedure.



**Open polyline arrow** button: Activates the open polyline drawing mode.

The first click into the image sets the starting point, each additional click adds a further line, right mouse click ends the procedure.



**Line** button: This button allows you to determine the line thickness of the profile line. It has no influence on the way the intensity profile is generated.




**Show Table** button: The profile diagram is displayed as a table at the bottom of the **Image Display** window.



Tables can always be saved or copied to the clipboard by right-mouse clicking on the table display!

### 6.13 Shuttle and Find View

Within the **S&F** control tab of the Shuttle and Find view (Fig. 674) regions of interests as well as points of interest can be defined. The regions and points can be relocated in the live image after moving the stage.

-  Defined regions of interest and points of interest can only be relocated within one imaging session. In case the software was restarted, the positions of the image and of the defined regions and points are no longer valid.

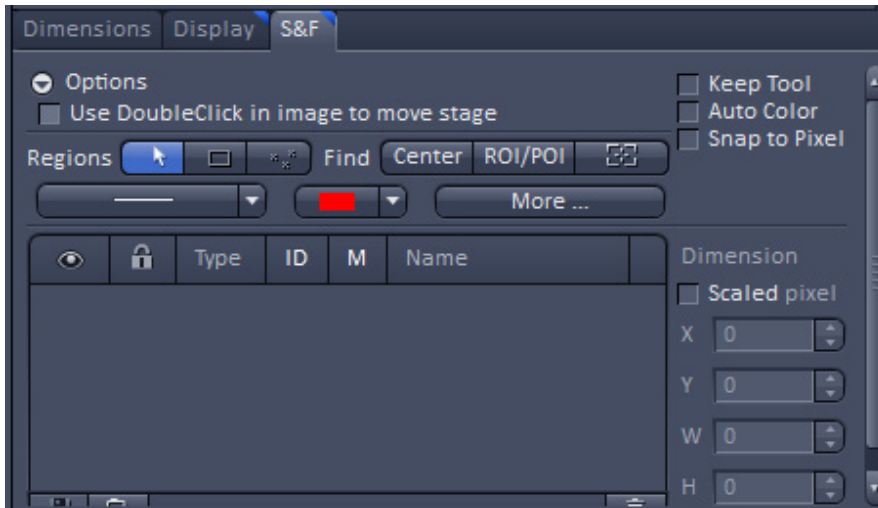


Fig. 674 Shuttle and Find control tab

**Options** provides settings for the general behaviour of the stage.





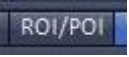

- **Use DoubleClick in image to move stage:** Moves the stage to the position you have double clicked on.

General settings for the graphical elements are set using the following features.

- **Keep Tool:** Keeps the current tool active. That's helpful if you want to draw in more than one ROI/POI.
- **Auto Color:** Uses a new color for each new element which is drawn in.
- **Snap to Pixel:** Draws in graphical elements using the pixel grid.

Within a snapped image multiple regions of interests (ROI) and points of interest (POI) can be defined using graphical elements. These ROIs or POIs can be relocated at the scanning electron microscope.

**Regions and Find functions**



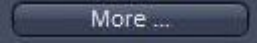
Button	Description
<b>Select</b> 	By clicking on this button you activate the selection mode (button is marked blue) to select the ROIs or POIs in the image area (if drawn in). If you are currently in another mode, you can switch back to the selection mode using this button.
<b>Draw Region of Interest</b> 	By clicking on this button you can draw in a rectangular ROI (Region of Interest).
<b>Draw Point of Interest</b> 	By clicking on this button you can draw in a POI (Point of Interest) / marker point.
<b>Center</b> 	Moves the stage to the center of the loaded image.
<b>ROI/POI</b> 	Moves the stage to the selected ROI / POI.
<b>Show stage position</b> 	Shows the current stage position as a rectangle in the image.

**Dimension panel**

Coordinates and dimensions of the selected graphical element are listed. If the Scaled pixel checkbox is activated, the unit is  $\mu\text{m}$ , otherwise Pixel.

- Parameter X: Shows the horizontal position (x coordinate) of the center of the graphical element.
- Parameter Y: Shows the vertical position (y coordinate) of the center of the graphical element.
- Parameter W: Shows the width of the graphical element.
- Parameter H: Shows the height of the graphical element.

**Editing graphical elements**

Button	Description
<b>Line width</b> 	Dropdown list for choosing the line width.
<b>Line Color</b> 	Dropdown list for choosing the color of the line.
<b>More ...</b> 	Opens a panel for setting annotations into the image.

**Graphical elements list**

<b>List Columns</b>	<b>Description</b>
<b>Eye symbol</b>	Shows or hides the ROI / POI in the image.
<b>Lock symbol</b>	Locks a ROI / POI to prevent changes.
<b>Type</b>	Displays the icon for the tool type (ROI/POI).
<b>ID</b>	Displays the ID for the graphic element. To do this, activate the checkbox at the corresponding list entry.
<b>M</b>	Displays measurement data for a graphic element. To do this, activate the checkbox at the corresponding list entry.
<b>Name</b>	Displays the name of the graphic element. To change the name, double-click in the Name field. Then enter the text of your choice.

**Correlating a live image and a snapped image**

The snapped image and the regions of interest drawn in the image can be relocated after the stage has been moved.

- Open a second container in the view tab
- Click on the **Continuous** button to start continuous scanning.
- Load the previously acquired image and click either on **Center** in the Find tool bar to center the live image or click on the ROI/POI within the Find tool bar to center the activated ROI or POI in the live image.

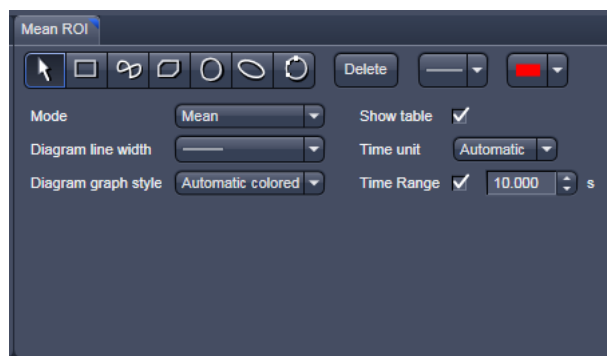


Defined regions of interest and points of interest can only be relocated within one imaging session. In case the software was restarted, the positions of the image and the defined regions and points are no longer valid.

## 6.14 Mean of ROI: Additional View Type for Time Series

The **Mean of ROI** View Type allows to

- display the intensity - time diagram (mean intensity in user defined ROIs over time),
- use frame - time series and frame - Z-Stack - time series as input,
- show the intensity values in table form and copy table to clipboard or save as text file.



**Fig. 675 Mean of ROI View Option control block**

The **Mean of ROI** function permits interactive analysis and monitoring intensity over time.

The settings of the **Dimensions, Display, Player** and **Graphics** View Options control blocks apply. The additional view-specific **Mean of ROI View Option** control block is shown in Fig. 675.

Any changes done with this View Option control block are effective immediately.

The Image Display in the Mean of ROI View shows 3 panels: the intensity-over-time diagram, the data table with the intensity values for each ROI over time and the image display with ROIs in overlay (see Fig. 676 and Fig. 677).

To access the **Mean of ROI** View Type, load or acquire a time series data set and click on the **Mean ROI** View tab.

The mean intensity of one or several regions of interest is displayed over time. Time flags from bleaching experiments or trigger events are marked with little symbols on the time-axis of the graph (see Fig. 676).

The **Mean of ROI** analysis always refers to the currently displayed z-section of a Z-Stack (see **Dimension** View Option control block for which section it is).



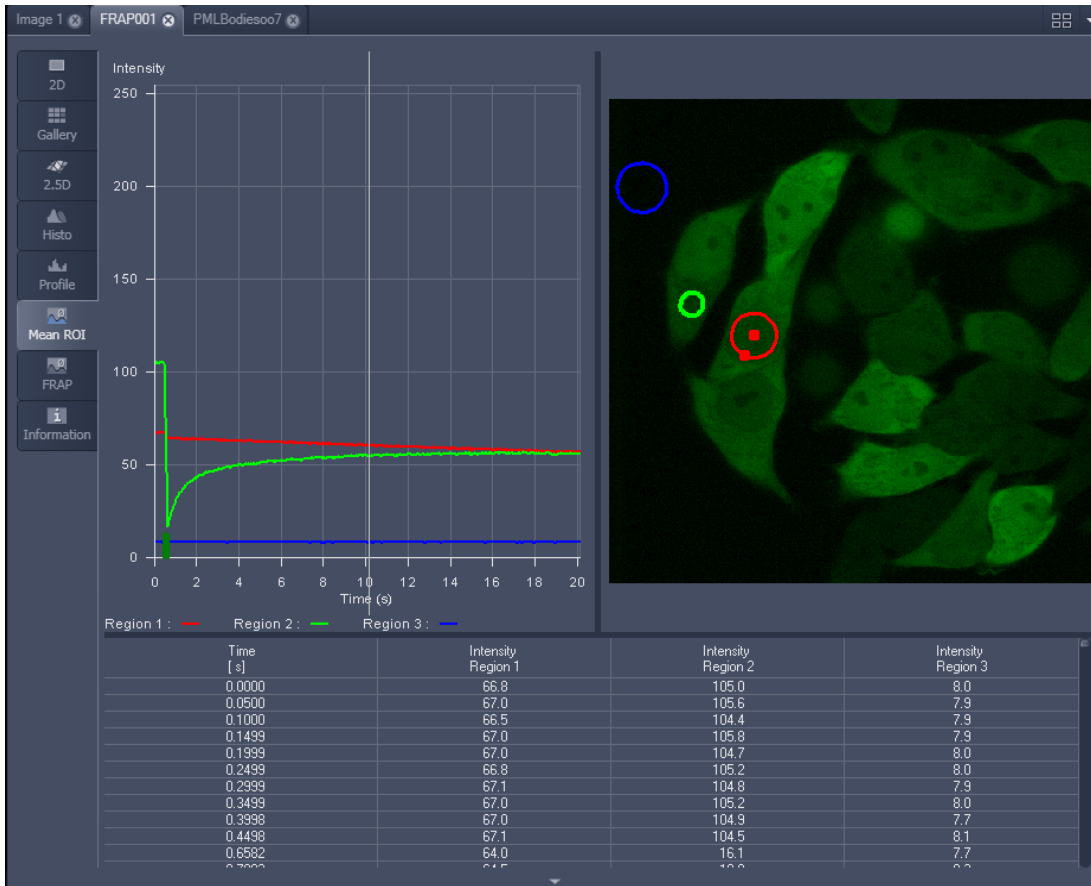


Fig. 676 Image Display window, Mean ROI display for time series in single plane

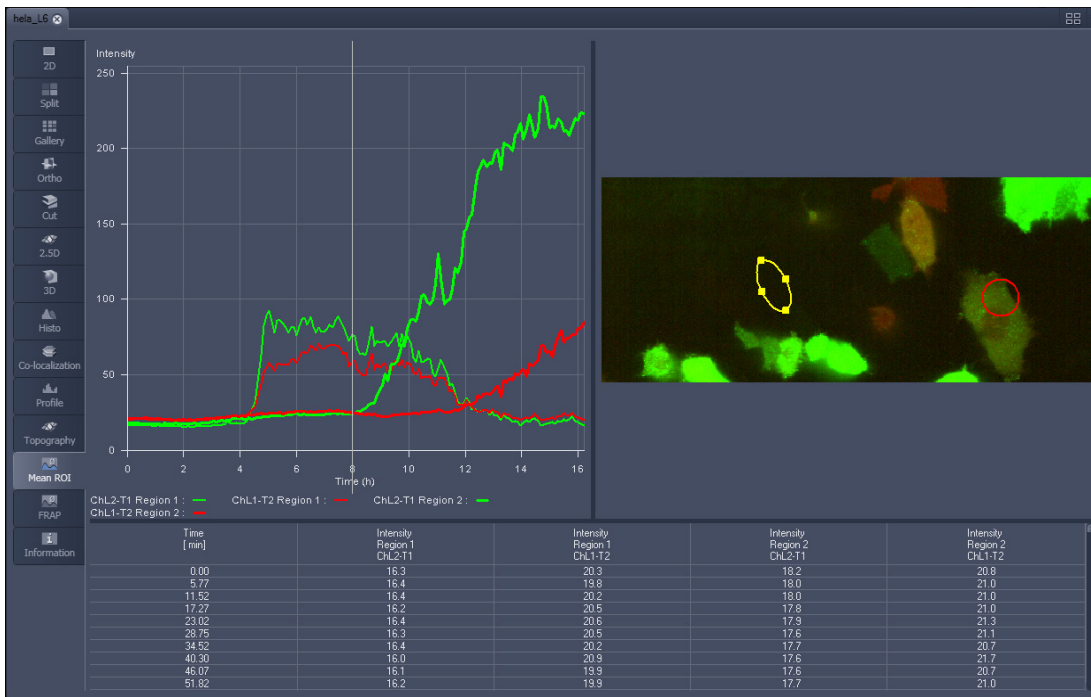





Fig. 677 Image Display window, Mean ROI display for time series of Z-Stack

The **Mean of ROI** view options control block contains the following function elements:

#	Type	X	Y	Width	Height	Lock
1		147	65	51	37	
2		239	176	40	40	
3		376	121	84	113	

**ROIs** can be managed in the Graphics View Option control block.



**Arrow** button: Activation of the mouse button for resizing or movement of the ROI in the **Image Display** window.



**Bezier** button: Activates the Bezier figure drawing mode. The first click sets the starting point, each additional click adds a further line, a double-click on the starting point closes the figure and ends the procedure.



**Circle** button: Activates the circle drawing mode. Clicking and holding down the mouse button sets the center point; drag the diameter and release the mouse button to end the procedure.



**Recycle bin** button: All the ROIs to the image are deleted.



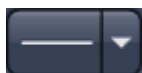
**Rectangle and 3D Rectangle** button: Activates the rectangle drawing mode. Click and hold down the mouse button, drag the rectangle in any direction, release the mouse button to end the procedure.



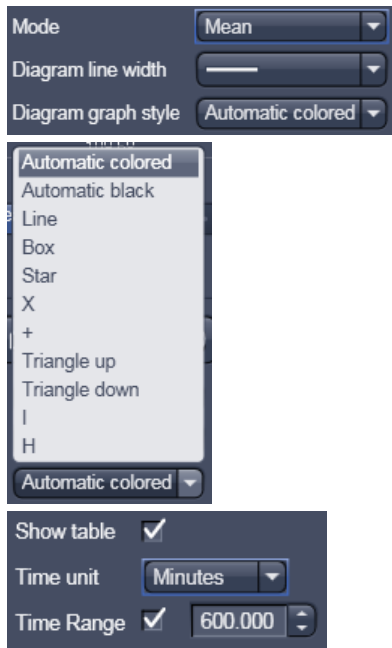
**Ellipse and 3D Elipse** button: Activates the ellipse drawing mode. The first click sets the center point, the displayed line permits the determination of the first dimension, the second click sets the first dimension, the second dimension and the rotation direction can then be determined; the third click sets the second dimension and the direction and ends the procedure.



**Polyline and 3D Polyline** button: Activates polyline drawing mode. The first click sets the starting point, each additional click adds a further line, a double-click on the starting point closes the figure and ends the procedure.



**Line** button: This button allows you to determine the line thickness of the ROI outline.

**Buttons for diagram display options:**

**Mode** pull down: choose between area and mean mode

**Area:** Display of the area of the ROI in the intensity time diagram, depending on the set threshold values. Area measurements of very small areas (< 10 pixels) give only approximate values.

**Mean:** Display of the mean values of the relevant ROI in the intensity time diagram.

**Diagram line width** pull down: sets the line width of the curves in the diagram.

**Diagram graph style** pull down: choose from a set of graph styles

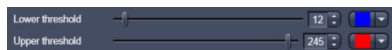
**Show Table** tick box: The table of intensity values is displayed on the bottom of the Image Display window.

**Time unit** pull down: choose between seconds, minutes, hours or Automatic

**Time Range** check box and spin box: reduce the displayed time range to the selected value



**In Area Mode: Ch1 / Ch3 / Ch4** pull down: Selection of the channel to be used.



**In Area Mode: Threshold low and high** slider: The intensity values below /above threshold are not displayed for the **Area** function.

### 6.15 Kinetic / FRAP View: Additional View Type for Time Series

The **FRAP** function permits interactive analysis of bleaching experiments, including

- Correction of FRAP data for bleaching and background,
- Fitting of FRAP data to a mono exponential or double exponential model for intensity.

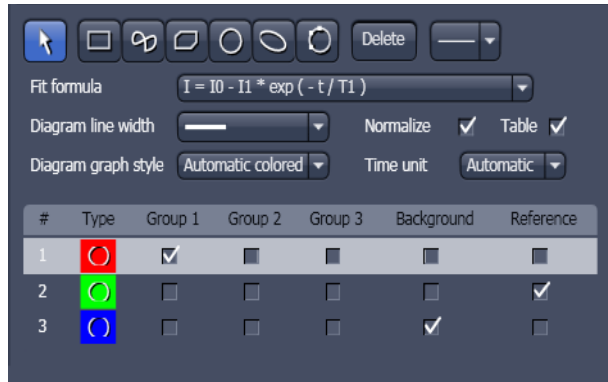


Fig. 678 FRAP View Option control block

The settings of the **Dimensions, Display, Player** and Graphics View Options control blocks apply. The additional view-specific **FRAP View Option** control block is shown in Fig. 678.

Any changes done with this View Option control block are effective immediately.

The Image Display in the **FRAP** View shows 4 panels: the intensity-over-time diagram with the fitted curve, the table with the fit parameters, the intensity value data table and the image display (see Fig. 679, Fig. 681 and Fig. 682).

To access the Kinetic / FRAP analysis view type, load or acquire a time series data set and click on the **FRAP** View tab.

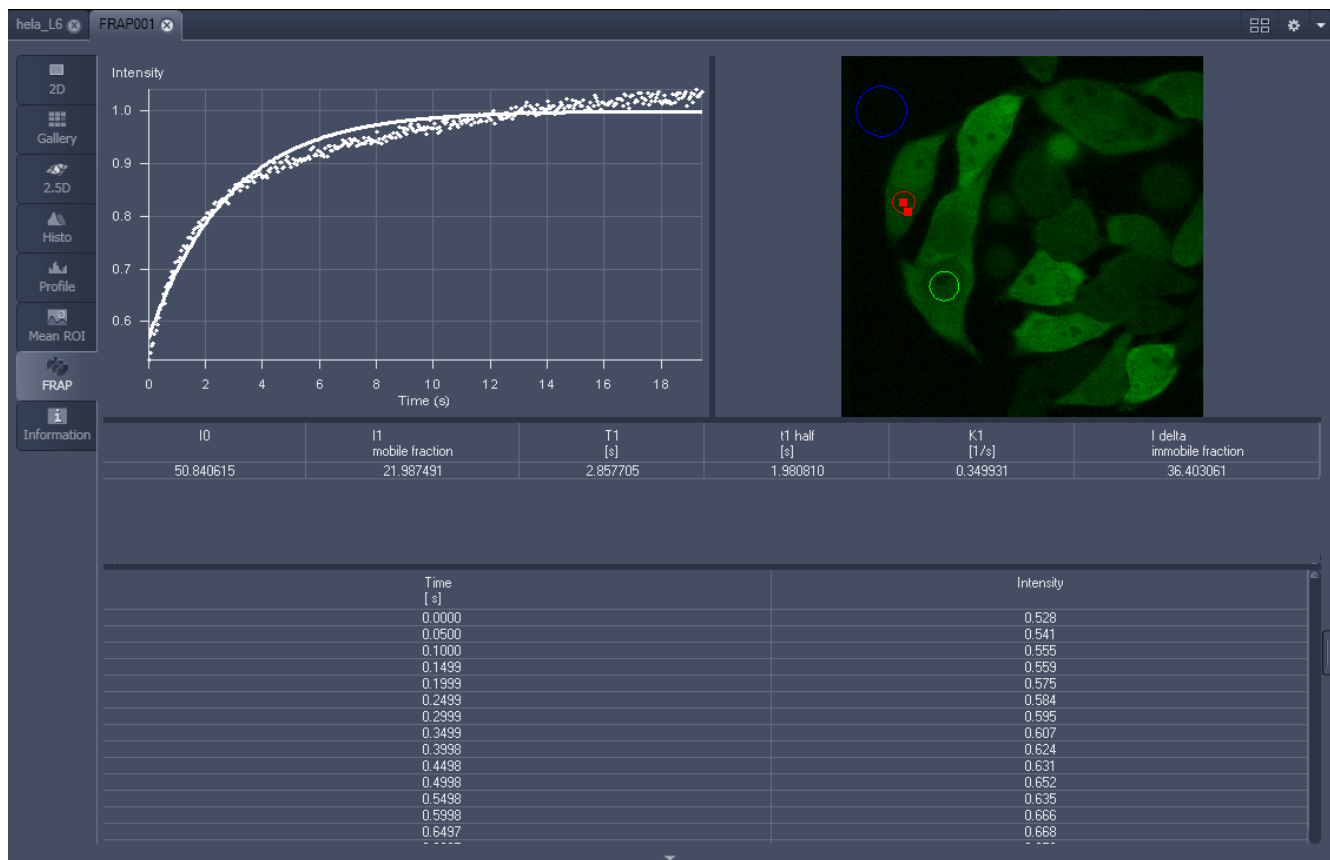


Fig. 679 Image display of a time series in the FRAP View tab

Available tools in the FRAP View:

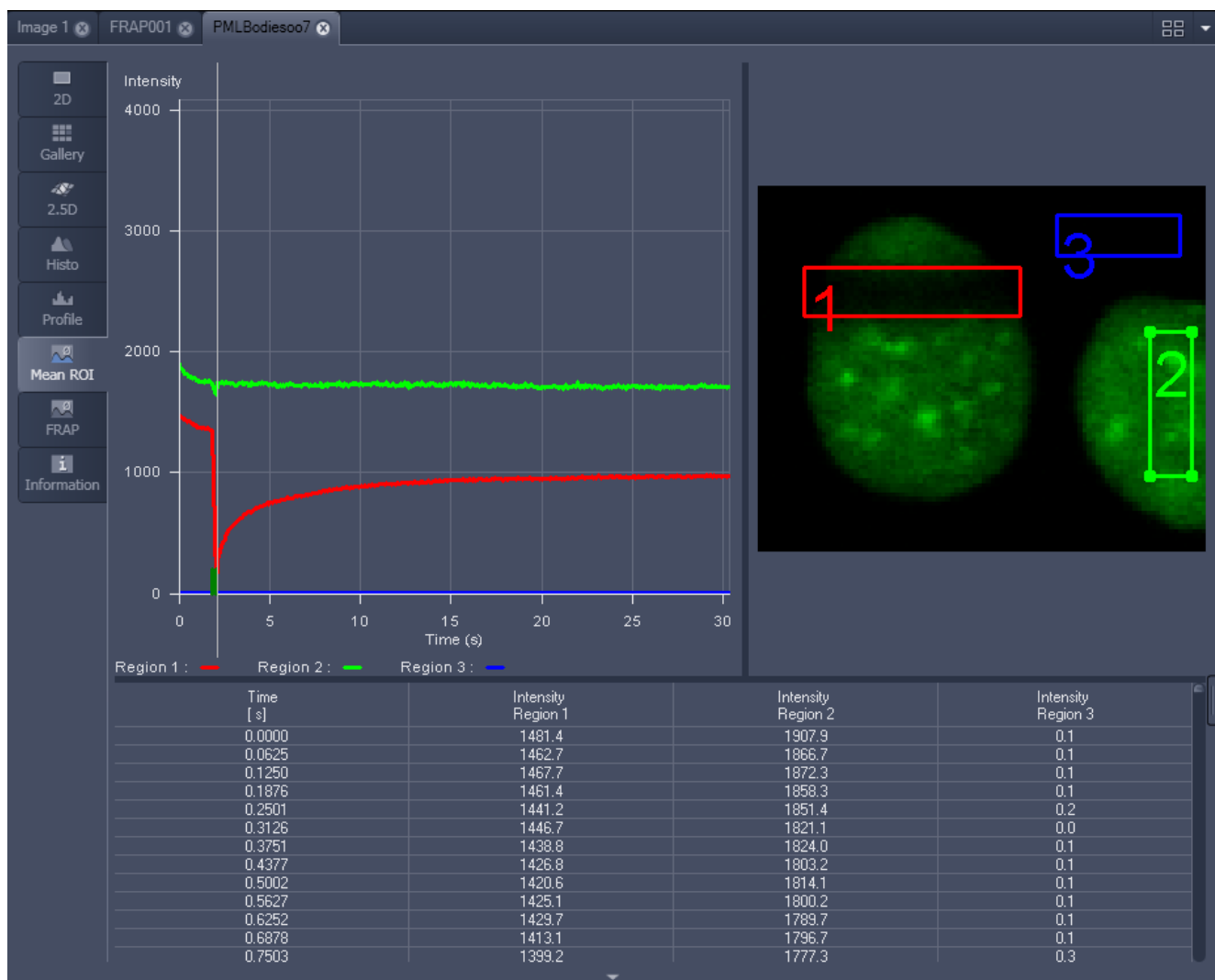
<b>Channels</b>	Select single channels or all channels for analysis in the general <b>Dimensions</b> view options control box.
<b>Kinetic Model / Fit formula</b>	Pull down menu to select the mathematical model (mono or double exponential model) for fitting the data.
<b>Analysis Areas / Regions of Interest (ROIs)</b>	The <b>FRAP</b> View Options control block includes drawing tools that work identically to the graphics view options control block. ROIs from both control blocks can be combined.
<b>Background Region</b>	Check box in the list of ROIs: Mark the region of interest which represents the mean background intensity to be used for data correction.
<b>Reference Region</b>	Check box in the list of ROIs: Choose and mark the ROI which represents the fluorescence intensity of a reference cell that has not been bleached. The mean intensity within that region is used to correct the data at each time point for any bleaching artifact that occurred during the imaging process.
<b>Combine Regions</b> Group 1, 2, 3	Check boxes in the list of ROIs which allow to choose more than one ROI for analysis and to group them according to the experimental set up.

Example: FRAP Performed in a Nucleus Expressing GFP Labeled Proteins

Display of the image series in the **Mean ROI** display mode: The drawing tools are used to define the ROI to be analyzed (ROI 1), the background ROI (ROI 3), and the reference ROI (ROI 2) (see Fig. 680). The reference ROI must be a neighboring cell which has been imaged with the same laser intensity over time identical to the cell, which has been bleached to induce FRAP. Make sure the whole cell or cell compartment of interest is imaged and therefore illuminated.

☞ Use the **time** slider in the **Dimensions** view options control block of the general view options group to display the first image after the bleach event. This makes it easy to choose the ROI for analysis. The analysis region should be slightly smaller than the region that has been bleached. The latter is listed in the Mean of ROIs list in the graphics view options control block.

- Define your ROIs for analysis in the **Mean of ROI** View tab.



**Fig. 680** FRAP data displaying the first bleached image of an images series in the Mean of ROI View Type

- Switch to the **FRAP** View tab.
- Mark the check boxes for background and reference region.
- The intensity values of the ROI to be analyzed will be corrected for background intensity and changes in intensity calculated for the reference region. The correction is done for each time point taking the actual intensity difference in the reference region into account.





The remaining ROI or ROIs are used for analysis when checked active for either group 1, 2 or 3. ROIs assigned to the same group are analyzed added for analysis.

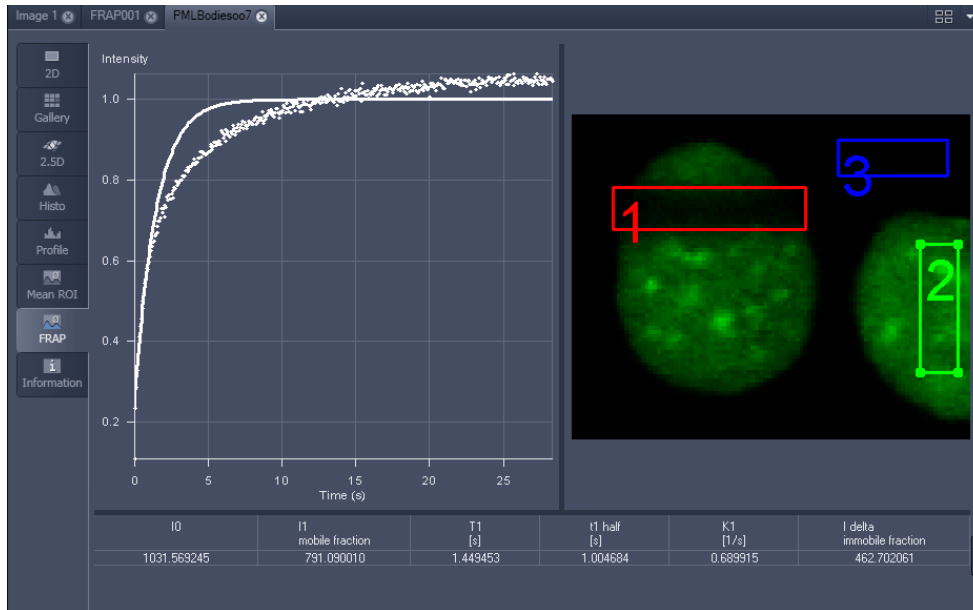
- Chose the **Kinetic Model** in the pull down list.
  - The result of the fit is displayed in the table. The result can be copied to the clipboard (**Copy Results**) or saved as a text file (**Save Results**) (right-mouse click). The following values are calculated and shown:
    - The final signal intensity in the analyzed ROIs following recovery **I0** (of the fitted curve).
    - The amplitude of the fitted curve (which equals the mobile fraction) **I1 mobile fraction**.
    - The fitted parameter **T1** (seconds).
    - The rate constant for the exchange of molecules between the bleached region and the surrounding area **K** (per second).
    - The part of the immobile fraction of the protein **I delta immobile fraction**.

Checking the **Table** tick box opens a further table in the image display area. It shows all intensity values for each channel and ROI analysis group over time. These values are corrected for background intensity and intensity loss of the reference region.

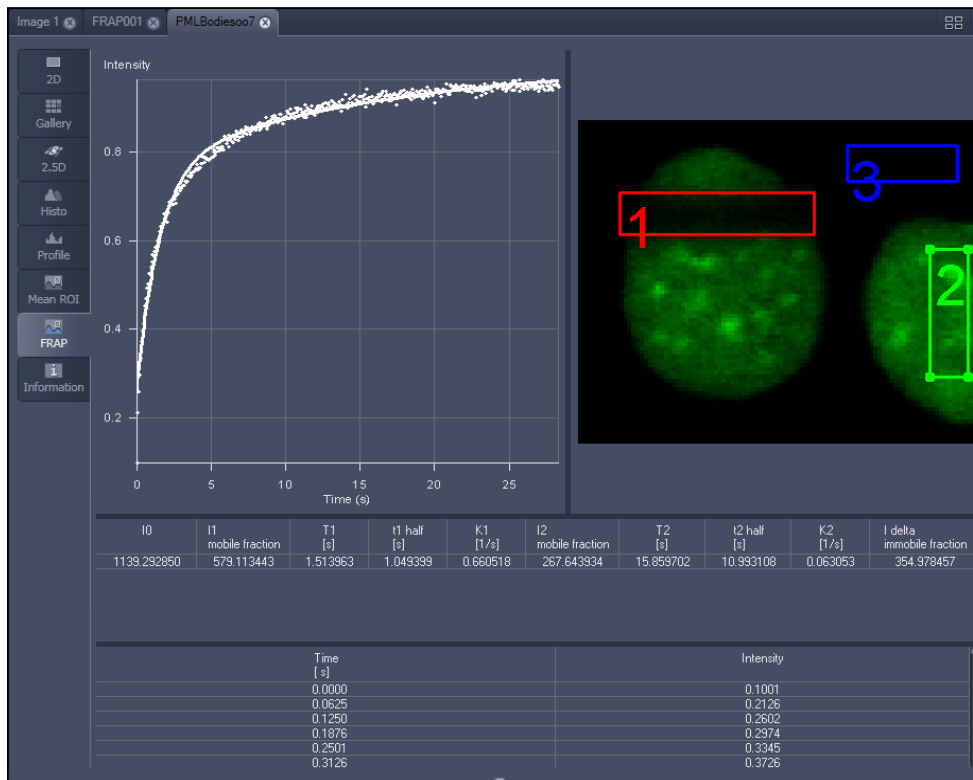
The values can be saved as a text file (**Save Table**) or copied into Excel via right-mouse click (clipboard) (**Copy Table**).

The data can be normalized optionally when marking the check box **Normalize** in the FRAP View Options control block.

-  The calculation of the parameters is based on the same ROIs unless other ROIs or moved ROIs are selected again. The Kinetic Display is always available once the analysis has been performed.
-  The analysis is not stored with the image.
-  Note that this modeling is a very basic approach to your experiment. It offers a first hint on the possible presence of only one or, in case of a bad fit, more than one mobile fractions of the labeled protein within the cell or cell compartment examined. For a more advanced analysis refer to the scientific literature.
-  The half time of the recovery can be calculated using the following formula:  $-t_{\text{half}} = (\ln 0.5) \cdot T1$



**Fig. 681** Image window displaying the analysis of FRAP data using a mono exponential fit




**Fig. 682** Image window displaying the analysis of FRAP data using a double exponential fit



If the analysis is done using the double exponential fit the fitted curve displays the mean of the fitted values for the two different mobile fractions. The table shows the following additional parameters:

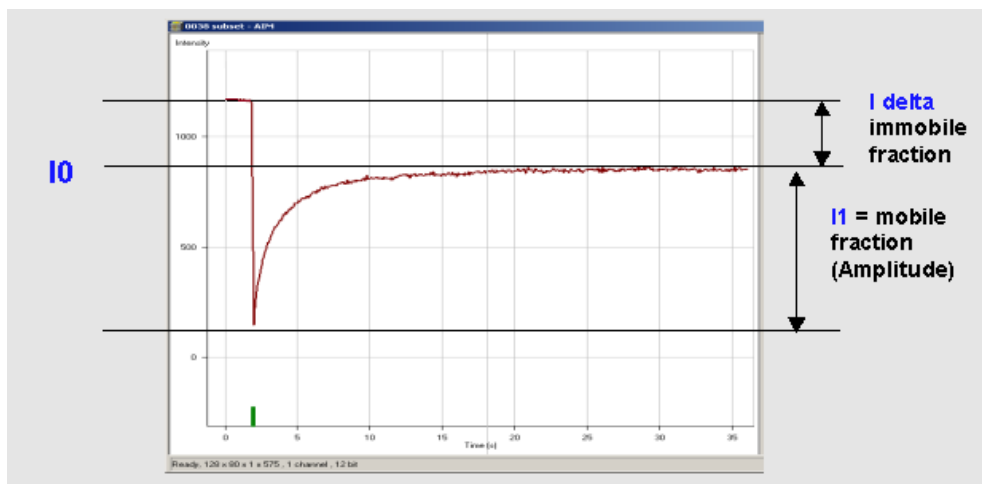
- The amplitude of the two curves, displayed as one (which corresponds to each part of the mobile fractions **I1** and **I2**).
- The fitted parameters **T1** and **T2** (seconds) for each mobile fraction.
- The rate constant for the exchange of molecules between the bleached region and the surrounding area **K1** and **K2** (per second) for each mobile fraction.

 The raw data of the experiment can be exported for further analysis using the Mean ROI display mode and, within this dialog, the table display of the results.

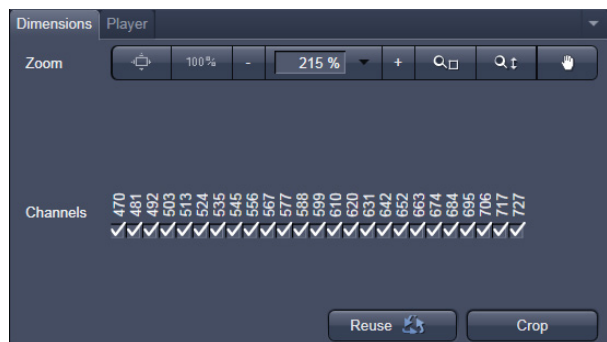
 Note that this modeling is also a very basic approach to your experiment. It offers a first hint on the possible presence of two mobile fractions of the labeled protein within the cell or cell compartment examined.

Please refer to relevant scientific literature or the website of the EAMNET (<http://www.embl.de/eamnet>) for further information on how to set up and perform FRAP experiments. A schematic curve marking the data points that are calculated performing the Kinetic Analysis is shown in Fig. 683. Please note, that the naming of the data points is not consistent with the information on the website.

A more general introduction to FRAP experiments can be found in the "Methods" brochure "Photomanipulation with Laser Scanning Microscopes" by Carl Zeiss Microscopy GmbH (order no. 45-0060 e) and the references cited therein.



**Fig. 683** Schematic FRAP curve with marks at the relevant data points. **I0**, **I1** and **I delta** which are calculated performing the Kinetic Analysis



**Fig. 684** Lambda Coded - specific Dimensions View Option control block

## 6.16 Lambda Coded: Additional View Types for Lambda Mode

The **Lambda Coded** View displays a Lambda Stack in a wavelength-coded color view. A color palette is automatically assigned to the individual images which are then displayed in a merge-type display. As a result, each pixel is represented similarly to a view through the oculars without emission filter (see Fig. 685).

The settings of the **Graphics** View Options control block apply as in 2D view. In the **Display** View Options control block, the channel-specific settings of brightness, contrast and gamma don't apply since there are no channels. The **Dimensions** View Options control block is reduced since the wavelength is not a dimension any more when it is color-coded. The modified view-specific **Dimensions View Option** control block is shown in Fig. 684.

Any changes done with this View Option control block are effective immediately.

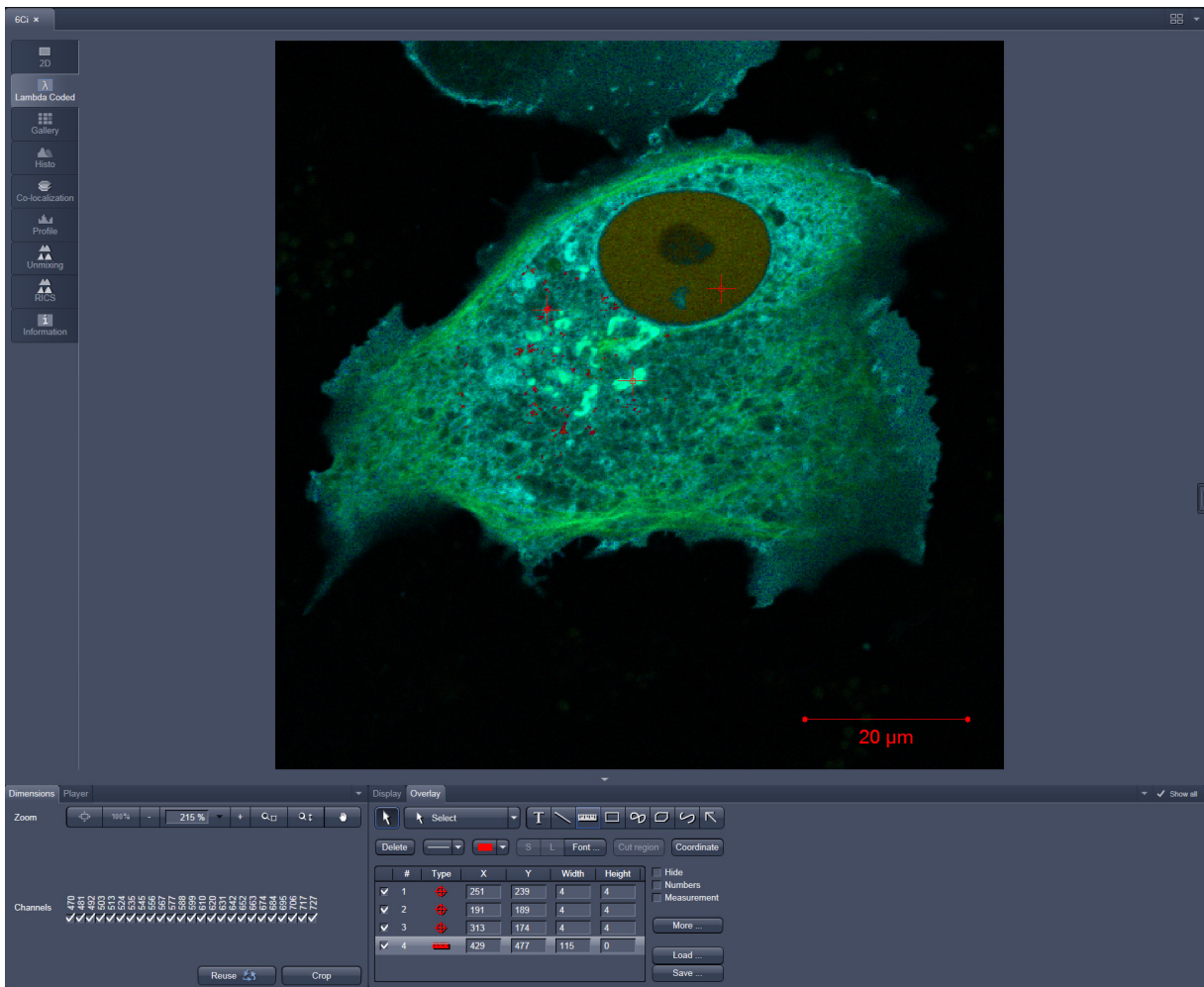
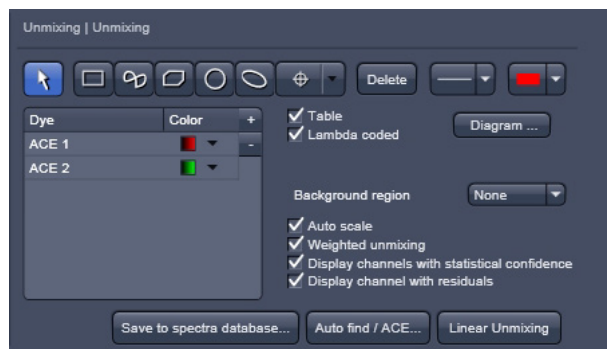
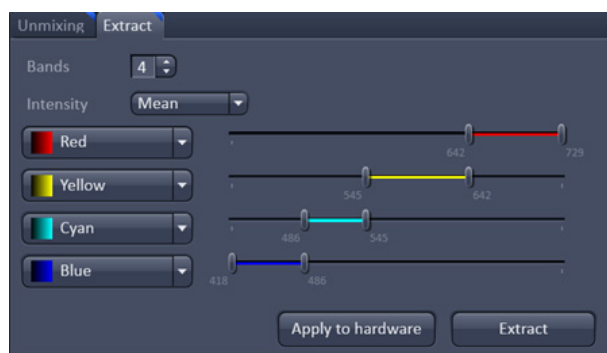


Fig. 685 Dimensions view option control block for Lambda Coded View



**Fig. 686 Unmixing View Option control block**



**Fig. 687 Unmixing - Extract - View Option control block**

## 6.17 Unmixing View

In the **Unmixing View**, Lambda or channel data sets can be analyzed and spectrally unmixed (for more information see as well section **Processing – Linear Unmixing**). In particular it allows to:


- display the spectra corresponding to user-defined ROIs (mean ROI intensity over Lambda),
- use Lambda Stacks and all types of multi-channel images as input (only if the PMTs of the LSM system are calibrated),
- show the intensity values in table form and copy table to clipboard or save as text file,
- generate unmixed multi-channel images.


The available tools and the functionality of the four general View Option control blocks **Dimensions, Display, and Graphics** is the same as in the **Lambda Coded View** (see the previous section on this view type). The two additional view-specific **Unmixing View Option** and **Unmixing Extract View Option** control blocks are shown in Fig. 686 and Fig. 687.

Any changes done with this View Option control blocks are effective immediately.

The Image Display in the **Unmixing View** shows 3 panels: the intensity-over-lambda diagram with the extraction bands (32-channel-LSM 710 and LSM 780 systems only), the table with the intensities in each ROI over lambda, and the image display (see Fig. 688). The spectra from images which are acquired on an LSM 700 are shown as integrated spectra. This reflects the way, how Lambda stacks are acquired with the LSM 700 (see the respective description in the LSM 700 Manual).

To access the Unmixing analysis view type, load or acquire a Lambda stack data set or a multichannel image and click on the **Unmixing** tab.

 The Unmixing View is available (→ displayed) for all Lambda stacks and for all multi-channel images acquired on hardware with calibrated detectors. This includes all LSM 710, LSM 780, LSM 710 NLO, LSM 780 NLO, LSM 7 MP (if NDD detectors calibrated) and LSM 700 systems.

 Detector calibration is a service task. This calibration allows that reference spectra can be acquired at different detector gain settings than the multi-labeled image acquired for unmixing!

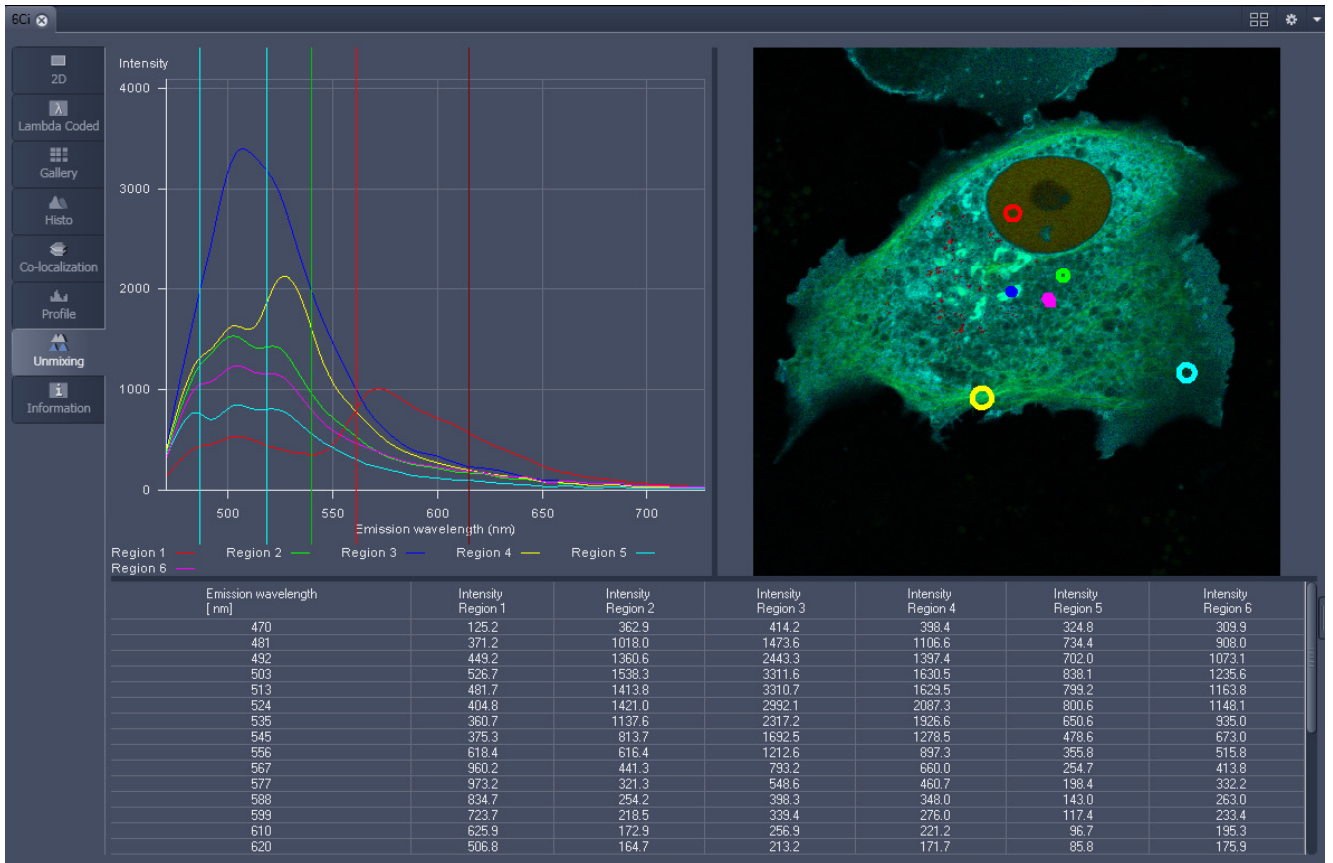
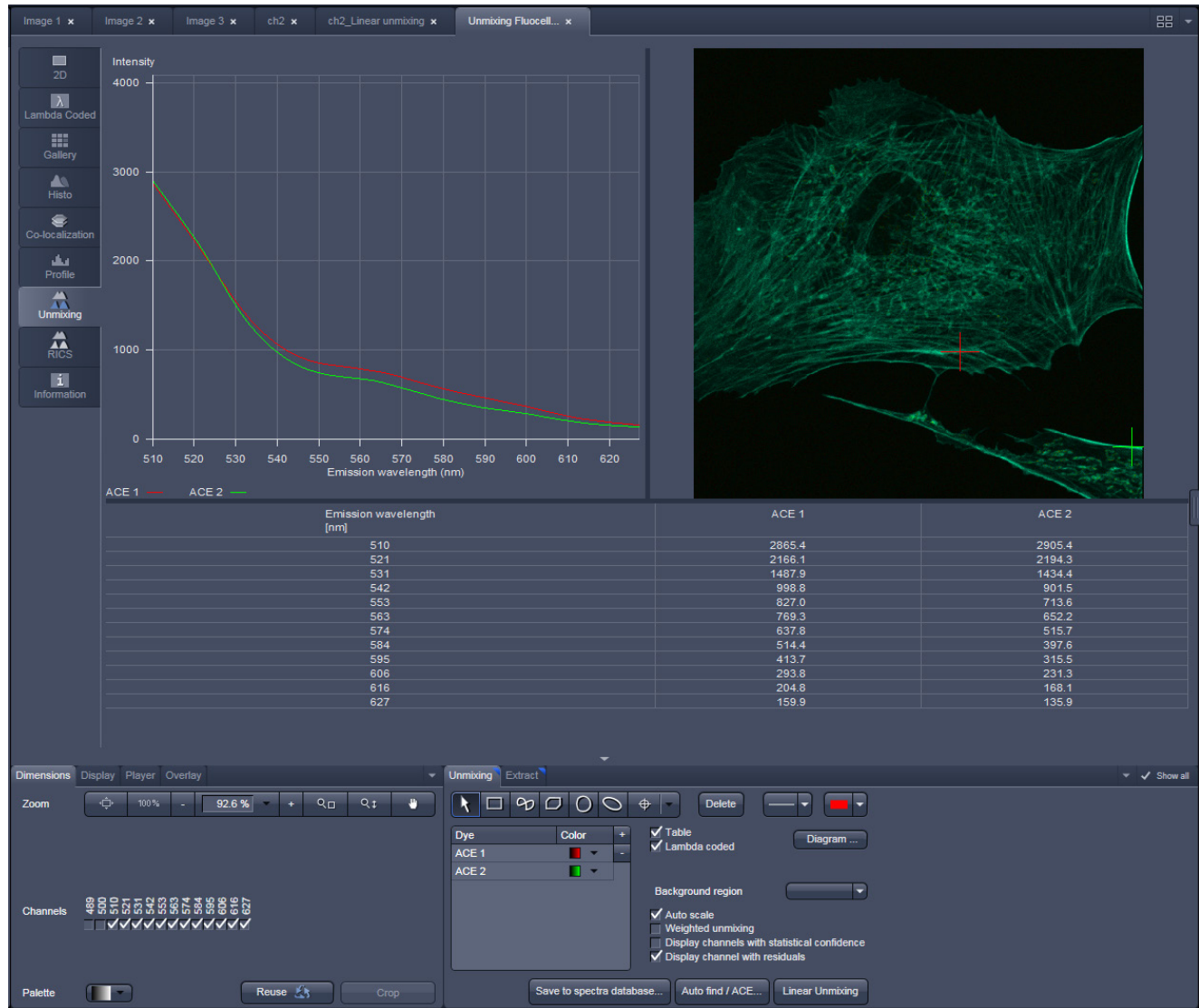


Fig. 688 Unmixing Display of a Lambda stack acquired on an LSM 710 / LSM 780



**Fig. 689** Unmixing Display of a Lambda stack with a spectral dataset acquired on an LSM 700 with a variable secondary dichroic

### Tools in the Unmixing View Options Control Block

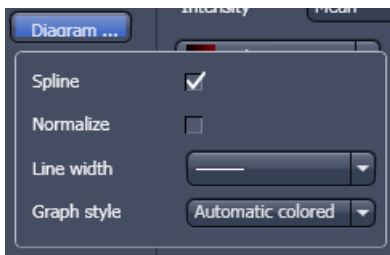
- Tools for display customization and drawing:



**Drawing tools** work the same as in the Graphics View Option control block

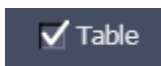


**Check box for image display:** show the image in greyscale or lambda coded (see as well section **Lambda Coded: Additional View Types for Lambda Mode**)



**Dialog for diagram display:**

- Spline on/off
- Normalize the graphs of the spectra to 1
- Set the line width of the spectra in the diagram
- Selection of graph style

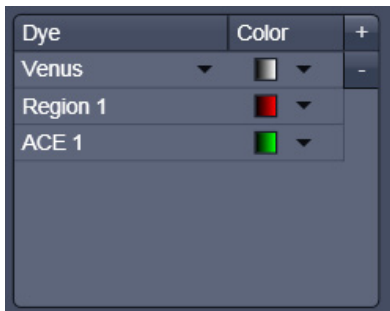


**Show Table** button: The table of intensity values over Lambda is displayed in the Image Display window.



**Tables can always be saved or copied** to the clipboard by right-mouse clicking on the table display!

- Tools for unmixing:



Overview of spectral data selected, that is displayed and can be used for unmixing. Spectra saved in the spectra database can be loaded (here: Venus) by pressing the plus button in the upper right corner which creates a new row. In this row the left black arrowhead opens the spectra database. Manually defined ROIs (Region) and pixel selectey by Automatic Component Extraction (ACE) can be added.



Select ROI for background subtraction



Automatically balances the intensity of unmixed channels to equal levels.



A statistical analysis of the signal-related (Poisson-) noise is performed and weighs the respective contribution to the fitting of the combination of reference spectra to the experimental data (see also section **Processing – Linear Unmixing**).

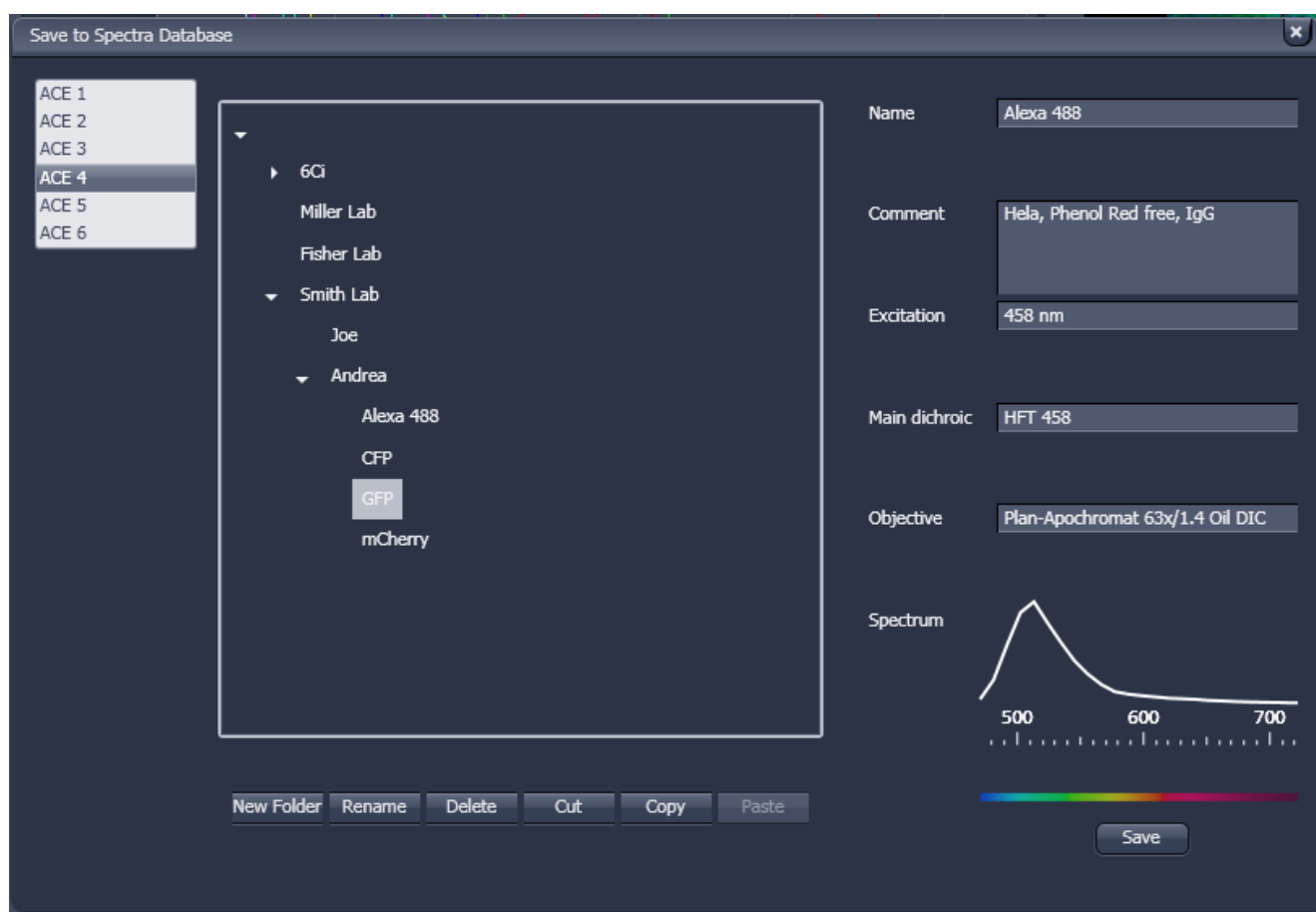
**Display channels with statistical confidence** An additional channel per unmixed component is displayed which shows the relative standard deviation (RSD) in each unmixed component channel (see also section **Processing – Linear Unmixing**).

**Display channel with residuals** A separate channel in the unmixed image that displays the difference between fit and original data in grey values for the channel of the Lambda stack that shows the greatest deviation (see also section **Processing – Linear Unmixing**).

**Save to spectra database...** The values of the intensity Lambda diagram are saved to the spectra database in the ZEN\DyeDatabase directory. Make sure to have displayed only data of single dyes in the intensity Lambda diagram when executing this function. (The database interface is shown in Fig. 690).

**Auto find / ACE...** **Auto Find / ACE ("Automatic Component Extraction")** Automatically searches the image for regions with pure signals (Fluorescence originating from one single dye).

**Linear Unmixing** Performs the unmixing with the selected spectra. Note: Those channels of the Lambda stack which are de-selected in the dimensions control tab are not included in the unmixing calculation.



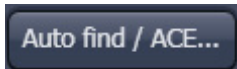
**Fig. 690 Save to Spectra Database: database interface with subfolder structure**



### 6.17.1 Automatic Component Extraction

The use of this function permits the automatic search for the individual reference spectra in a Lambda stack.

- Load or acquire a Lambda stack data set.
- Click on the **Unmixing View** tab.



- Click on the **Auto find / ACE...** button in the Unmixing View Option control tab (Fig. 692).
- Select the number of components in the sample and click **Ok** (Fig. 691). If a subset of existing spectra has been already defined by manual ROIs or by spectra from the spectra database, the number of remaining components is selected for ACE.
- Review the results in graph.
- When obtained spectra appear reasonable, unmix the data set by clicking the **Linear Unmixing** button (Fig. 692).
  - A new and spectrally unmixed multichannel image document is created (as many channels as previously defined components).

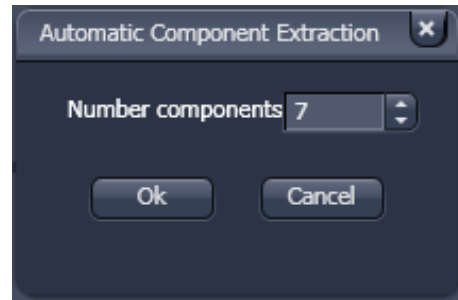


Fig. 691 ACE, number of components selection window

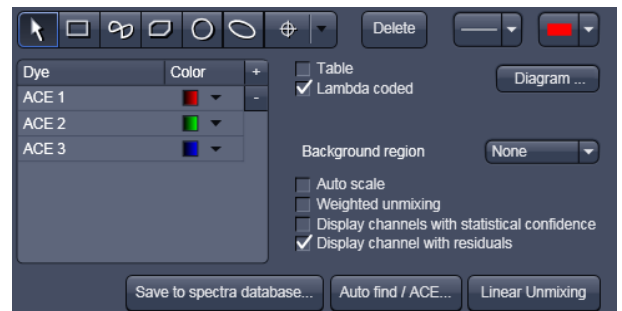


Fig. 692 Automatic Component Extraction function

#### Benefit and limitations of the ACE method:

Little to moderate spatial overlap of emission signals is required to obtain good results.

Because it relies on reference spectra extracted from the multi-channel / Lambda stack image itself, ACE could unmix on wrong assumptions and produce poor data.

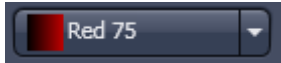
However, it provides a solution for Emission Fingerprinting in those cases where reference spectra are not accessible via single-labeled controls.

If the resulting data is carefully checked for plausibility and quantification of the results is avoided carried out with the appropriate caution, this often is a helpful tool when working with spectrally overlapping dyes.

**Tools in the Unmixing - Extract View Options Control Block:**

These tools (Unmixing – Extract) are only available for Lambda stacks on an LSM 710 and LSM 780 system with 34 channel Quasar detector. Hence, they are not available for LSM 700 or LSM 7 LIVE Hardware (tool tab grayed).

Button:



Slider:



Selection of a wavelength range (use the sliders) that will be assigned to a channel. This assignment can be used for scanning (when **Apply to Hardware** is pressed, see below) and /or for extracting a single or multichannel image from the Lambda stack (when **Extract Channels** is pressed). Clicking on the color box in the channel button opens the color selection list and a LUT can be assigned to this channel.



Add or reduce the number of channels displayed and available for assignment. Up to 8 channels labelled after the assigned LUT are available.

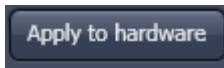


Sum signals from selected detector elements  
Mean signals from selected detector elements  
Autoscaling of output channels (individually)



**channels** button

Generates a new image or multicolor images based on the settings made in the channels. Two or more Lambda channels are binned to form the channels 1 ... 8. The generated image is displayed in a new **Image Display** window and is no longer a Lambda stack.



button

Sets the QUASAR detector parameters to match the previously defined spectral ranges / channels. For the used in binning mode as specified in the settings ChS1, ChS2, ChS3 ... ChS8. See **Single Track** and **Multi Track** in **Config Control** for the effect of the action. The **Lambda stack** setting is not affected by this action.

## 6.18 FRET View


In the **FRET** View type (Fig. 693), FRET data sets can be analyzed:

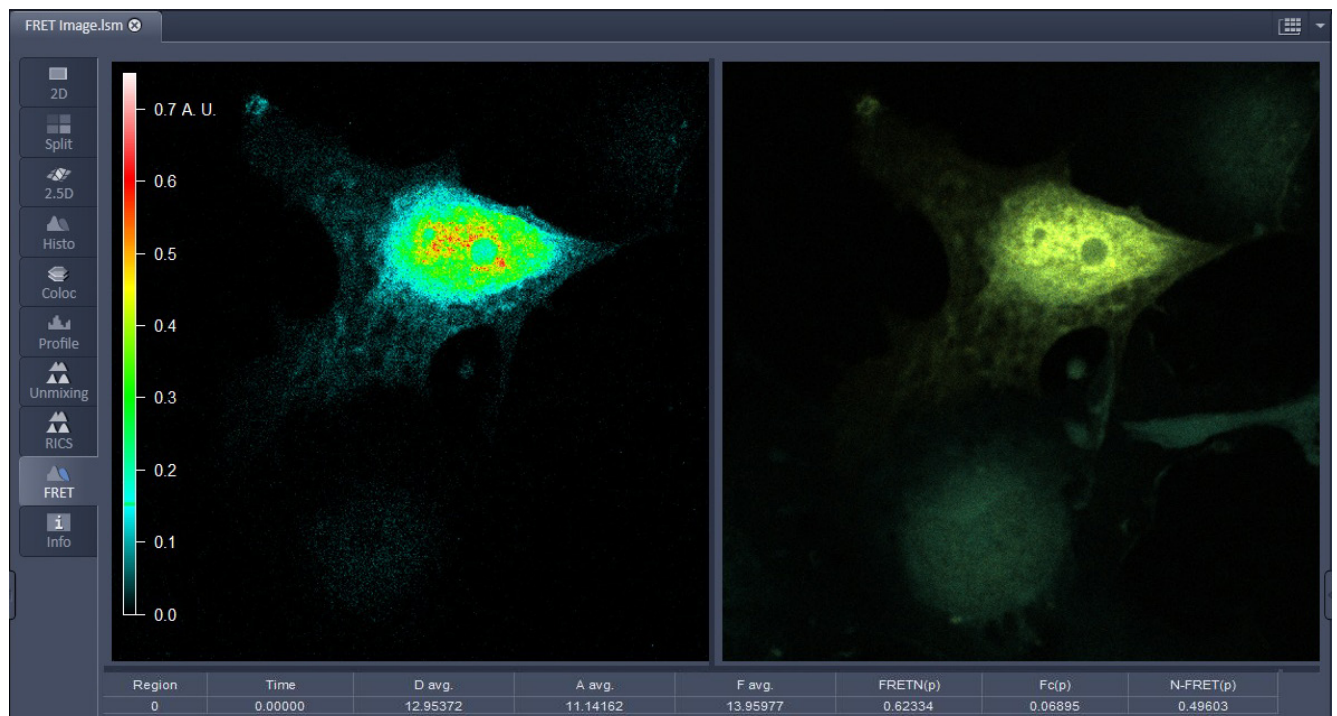
- Data gained performing Acceptor Photobleaching
- Data gained performing Sensitized Emission

The data sets are acquired setting up the imaging procedure manually.

To access the **FRET** View, load or acquire either a multichannel data set (minimum 3 channels) or a time series with bleach event and click on the **FRET** tab.

Depending on the type of data the Image Display in the **FRET** View shows 3 panels after initial analysis: the FRET image, the original data and the table with the analyzed data according to the method chosen.

 **Tables can always be saved or copied** to the clipboard by right-mouse clicking on the table display!



**Fig. 693 FRET Display of Image after Sensitized Emission analysis**

After a Sensitized Emission analysis the table shows the following parameters (Fig. 693):

**Region:** The identification numbers of regions assigned for analysis. Region zero refers to the whole image.

**Time:** When a time series is analyzed the time point is shown here.

**D avg.:** Average intensity of the region in the donor channel. These values are influenced by the chosen settings in the Settings Tab. They may therefore vary from values of the same regions in the Histo tab.

**A avg.:** Average intensity of the region in the acceptor channel. These values are influenced by the chosen settings in the Settings Tab. They may therefore vary from values of the same regions in the Histo tab.

**F avg.:** Average intensity of the region in the FRET channel. These values are influenced by the chosen settings in the Settings Tab. They may therefore vary from values of the same regions in the Histo tab.

**FRETN (p):** Result of analysis using Gordon method. The FRETN value is calculated for each pixel, afterwards the average for the chosen region is determined.

**Fc (p):** Result of analysis using Youvan method. The Fc value is calculated for each pixel, afterwards the average for the chosen region is determined.

**N-FRET (p):** Result of analysis using Xia method. The N-FRET value is calculated for each pixel, afterwards the average for the chosen region is determined.

Region	FRET(p) Eff.%	FRET Eff.%	D Pre	D Post	A Pre	A Post	Delta D	Delta A
0	-5.43673	5.94974	11.88683	12.63880	31.84916	29.66517	0.75198	-2.18671
1	16.39979	24.93387	43.65694	58.15797	93.28593	37.87503	14.50104	-55.41148
3	20.14109	26.91700	51.36111	70.27778	112.33334	43.75000	18.91667	-68.58334

**Fig. 694** Table after Acceptor Photobleaching analysis

After an Acceptor Photobleaching analysis the table displays the following parameters (Fig. 694):

**Region:** The identification number of regions assigned for analysis. Region zero refers to the whole image.

**FRET(p) Eff. %:** FRET efficiency for each pixel is calculated and averaged for all pixels of the region.

**FRET Eff. %:** The averaged intensities of the region are used to calculate an averaged FRET efficiency for this region.  $\Delta D / D \text{ Post} * 100$ .

**D Pre:** Average donor intensity of the region in the pre-bleach image.

**D Post:** Average donor intensity of the region in the post-bleach image.

**A Pre:** Average acceptor intensity of the region in the pre-bleach image.

**A Post:** Average acceptor intensity of the region in the post-bleach image.

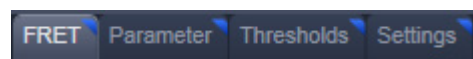
**Delta D:** Change in donor intensity of the region before and after the bleach event.

$\Delta D = D \text{ Post} - D \text{ Pre}$ .

**Delta A:** Change in acceptor intensity of the region before and after the bleach event.

$\Delta A = A \text{ Post} - A \text{ Pre}$ .

Independent of the FRET method, the FRET View Options Control Block offers four tabs:



The available functions within each tab can vary according to the image loaded.

It is assumed that a time series with bleaching represents an experiment with Acceptor Photobleaching and a three channel image represents an experiment performing Sensitized Emission.

### 6.18.1 Tools in the FRET View Options Control Block for Acceptor Photobleaching

#### FRET tab (Fig. 695):

As **Method** for FRET Analysis, **Acceptor Photobleach** is automatically selected in the drop down list.

Within this tab the overlay regions present in the image (defined as bleach, background or control region of the bleach experiment) can be activated (The drawing tools correspond to the drawing tools described in section **Graphics**). Additional regions can be defined for analysis as well.

The checkboxes **Numbers** and **Measure** refer to the overlay regions and annotate the number of the region and its area to the overlay in the image.

**Export** allows the resulting FRET image to be saved as a separate image file.

The regions defined can be set as **Object** (Region of which FRET should be calculated) or **Background** (from which the threshold for the image analysis is deduced from and automatically used for analysis and displayed in the **Threshold tab**).

Regions and the assigned status as Object or Background can be selected or deselected for the individual analysis using the corresponding check box under **Enabled**.

To start analyzing the **Analyze** button must be clicked once. If all further changes shall be effective immediately the **On the fly** checkbox can be checked.

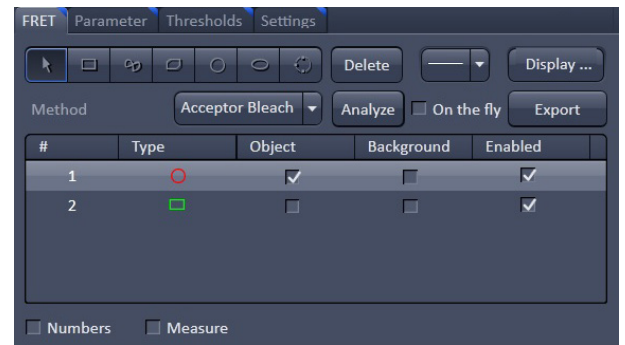


Fig. 695 FRET View Options Control Block, FRET tab

#### Parameter tab (Fig. 696):

Various parameters of the image series can be set in this tab.

The image of the Donor and the Acceptor are assigned to the appropriate channel using the drop down menu next to **Donor ch.:** and **Acceptor ch.:**

The frame of the time series after the bleaching event (**Bleach after frame**) is set using the slider next to it or by editing the field next to the slider. If only one bleach event was performed, this defines the frame before and after the bleaching respectively for analysis.

In case of a bleach experiment with repeated bleaching time points the checkbox **Bleach Repeat** must be checked. This results in activation of the **Donor post-bleach Frame** slider and field. Here the frame can be chosen to provide the data of the donor intensity after bleaching (D post) for analysis.

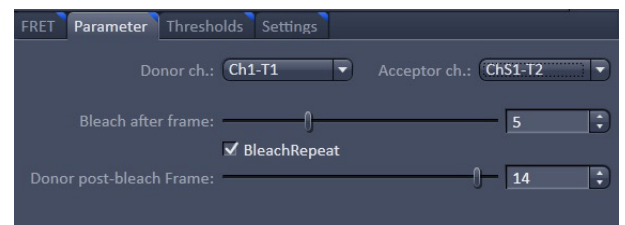
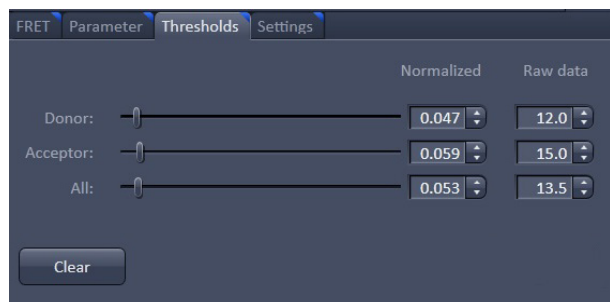


Fig. 696 FRET View Options Control Block, Parameter tab

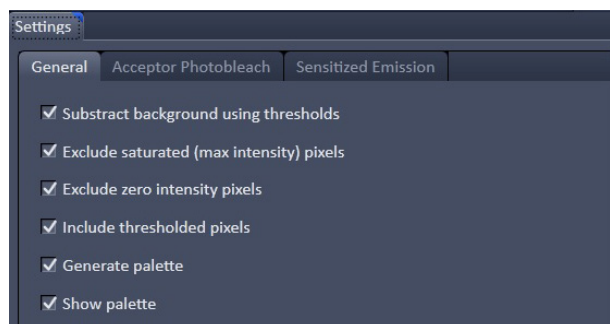


**Fig. 697 FRET View Options Control Block, Threshholds tab**

### Threshholds tab (Fig. 697):

The threshold for the image analysis can be set manually using the slider or editing text box next to **Donor**, **Acceptor** or **All**, where **All** moves both sliders to the same value.

Alternatively, the threshold can be set by defining and enabling a background region in the FRET tab. The values for the thresholds are either displayed as grey value levels (**Raw data**) or **Normalized** to the value 1.



**Fig. 698 FRET View Options Control Block, Settings tab, General**

### Settings tab (Fig. 698):

This tab provides access to the parameters used for the image analysis.

The **General** tab applies to both methods, Acceptor Photobleaching and Sensitized Emission.

If checked the listed options will be taken into account for the analysis of FRET.

**Subtract background using thresholds:** The previously defined grey values of the thresholds (FRET tab, Threshholds tab) are subtracted from each pixel prior to analysis. If not checked, pixel below the defined thresholds will not be displayed in the FRET Image and are not part of the analysis (value and area).

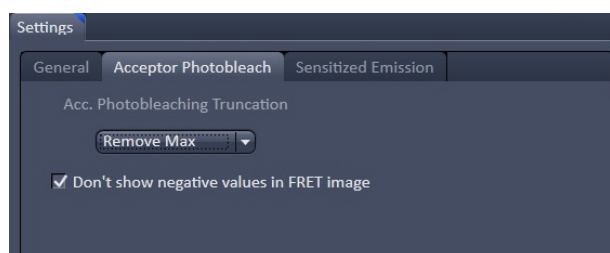
**Exclude saturated (max intensity) pixels:** Pixels that are saturated in at least one channel will not be considered for analysis.

**Exclude zero intensity pixels:** Pixels with zero intensity in any channel are not part of analysis. This checkbox is always checked.

**Include thresholded pixels:** Pixel with the same grey value as the defined thresholds will be part of analysis when checked. This is usually not activated.

**Generate palette:** The palette of the FRET image is displayed color coded when checked.

**Show palette:** This checkbox allows to choose if the palette of the FRET values is displayed within the FRET image or not.



**Fig. 699 FRET View Options Control Block, Settings tab, Acceptor Photobleach**

The **Acceptor Photobleach** tab (Fig. 699) sets additional parameters to analyze the Acceptor Photobleaching experiment such as the choice for **Truncation** (as Remove Max or No Truncation) and the option not to display negative values in the image (**Don't show negative values in the FRET image**).

### 6.18.2 Tools in the FRET View Options Control Block for Sensitized Emission

#### FRET tab (Fig. 700):

Within this tab overlay regions can be defined. (The drawing tools correspond to the drawing tools described in section **Graphics**).

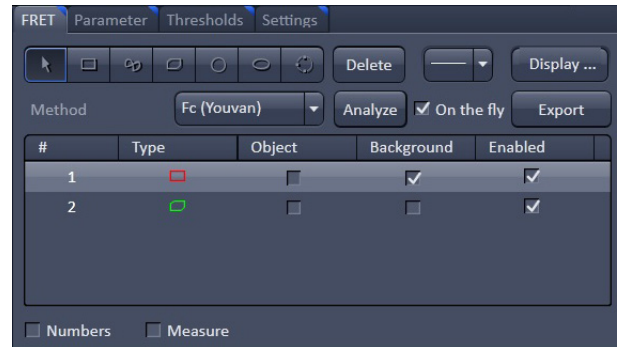
The checkboxes **Numbers** and **Measure** refer to the overlay regions and annotate the number of the region and its area to the overlay in the image.

**Export** allows the resulting FRET image to be saved as a separate image file.

The regions defined can be set as **Object** (Region where FRET should be calculated or the reference coefficient values are determined from) or **Background** (from which the threshold for the image analysis is deduced and automatically used for analysis and displayed in the **Threshold tab**).

Regions and the assigned status as Object or Background can be selected or deselected for the individual analysis using the corresponding check box under **Enabled**.

To start analyzing the **Analyze** button must be clicked once. If all further changes shall be effective immediately the **On the fly** checkbox can be checked.



**Fig. 700 FRET View Options Control Block, FRET tab**

Three different methods for FRET analysis are available in the drop down list:

- **Fc (Youvan),**
- **FRETN (Gordon)** and
- **N-FRET (Xia).**

**Fc** or **Youvan** method:

Youvan et al., Biotechnology et alia 3, 1 (1997)

$$F_c = F_f - D_f(F_d/D_d) - A_f(F_a/A_a)$$

Displays the  $F_c$  image with intensities converted from the FRET index calculated for each pixel using the Youvan method. This method assumes that the signal recorded in the FRET channel is the sum of real FRET signal overlaid by donor crosstalk and acceptor signal induced by direct (donor) excitation. There is no correction for donor and acceptor concentration levels and as a result the FRET values tend to be higher for areas with higher intensities.

**FRETN** or **Gordon** method:

Gordon et al., Biophys J 74, 2702 (1998)

$$FRET_N = FRET_1 / D_{fd} * A_{fa}$$

Displays the FRET image with intensities converted from the FRET index calculated for each pixel using the Gordon method. This method calculates a corrected FRET value and divides by concentration values for donor and acceptor. This method attempts to compensate for variances in fluorochrome concentrations but overdoes it. As a result cells with higher molecular concentrations report lower FRET values.

**N-FRET or Xia method:**

Xia and Liu, *Biophys J* **81**, 2395 (2001)

$$\text{NFRET} = \text{FRET} / \sqrt{(\text{Dfd} * \text{Afa})}$$

Displays an N-FRET image with intensities converted from the FRET index calculated for each pixel using the Xia method. This method is similar to the Gordon method with the difference that for concentration compensation the square root of donor and acceptor concentration is used. The resulting image is properly corrected for variances in the fluorochrome concentration.



**Fig. 701 FRET View Options Control Block, Parameter tab, Last Analysis**

**Parameter tab (Fig. 701):**

Various Parameters of the image can be set in this tab.

Prior to analysis the channels of the image need to be assigned appropriately using the drop down menu next to **Donor ch.:**, **Acceptor ch.:** and **FRET ch.:**

To determine the **Donor coefficient** values by using a sample with only signal of the donor fluorophore, one or more regions in the image are defined and enabled as objects in the FRET tab. Of this region the Donor coefficient values are taken by clicking the **Analyze Donor** button.

The **Donor coefficient** include the Donor signal detected in the FRET channel/Donor signal detected in the Donor channel (**Fd/Dd**) and the Donor Signal detected in the Acceptor channel/Donor signal detected in the FRET channel (**Ad/Fd**). These values are saved for future use as a .fret file by choosing **Donor** in the drop-down list and pressing afterwards the **Save** button.

To obtain the **Acceptor coefficient** values an image of a sample with only acceptor fluorescence is taken and one or more regions are defined as objects and enabled in the FRET tab and the **Analyze Acceptor** button is pressed.

The values for the **Acceptor coefficient** include the Acceptor signal detected in the FRET channel / Acceptor signal detected in the Acceptor channel (**Fa/Aa**), the Acceptor signal detected in the Donor channel / Acceptor signal detected in the Acceptor channel (**Da/Aa**), the Acceptor signal detected in the Donor channel/Acceptor signal detected in the FRET channel (**Da/Fa**). These values are saved for future use as a .fret file by choosing **Acceptor** in the drop-down list and pressing afterwards the **Save** button.

The Gordon factor **G** depends on the fluorophores used and is part of the Gordon and Xia analysis. Please refer to the original publications for further details (Gordon et al., *Biophys J* 74, 2702 (1998), Xia and Liu, *Biophys J* **81**, 2395 (2001)).

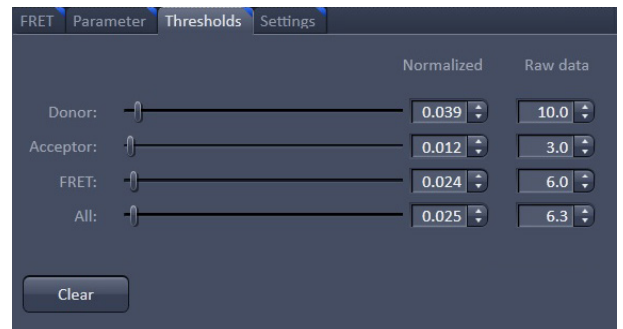
The total **Number of images** is set using the slider or by editing the field next to the slider, to choose how many images of a time series shall be taken into account. Their values will appear in the table below the image.

To load the saved Acceptor and Donor coefficient values for FRET analysis **Donor** or **Acceptor** are chosen in the drop-down list respectively. Afterwards the **Load** button is pressed and the previously saved .fret file chosen.



**Thresholds tab (Fig. 702):**

The threshold for the image analysis can be set manually using the slider or editing text box next to **Donor**, **Acceptor**, **FRET** or **All**, where **All** moves all sliders to the same value. Alternatively, the threshold can be set by defining and enabling a background region in the FRET tab. The values for the thresholds are either displayed as grey value levels (**Raw data**) or **Normalized** to the value 1.



**Fig. 702 FRET View Options Control Block, Thresholds tab**

**Settings tab (Fig. 698 and Fig. 703):**

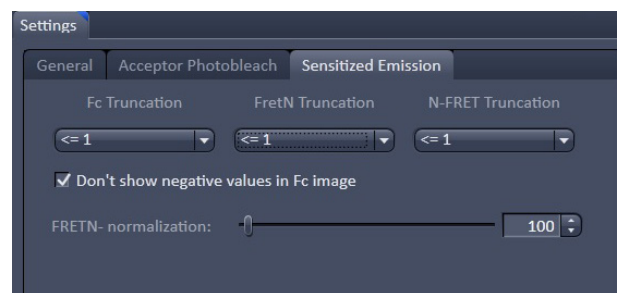
This tab provides access to the definition of the parameters used for the image analysis.

The **General** (Fig. 698) tab applies to both methods, Acceptor Photobleaching and Sensitized Emission.

If checked the listed options will be taken into account for the analysis of FRET.

The **Sensitized Emission** (Fig. 703) tab sets additional Truncation parameters for each method to analyze the Sensitized Emission experiment such as the choice for **No truncation**, **Remove maximum** or the truncation of values above 1 ( $\leq 1$ ), 2 ( $\leq 2$ ) or 3 ( $\leq 3$ ).

For the Fc analysis method, the option **Don't show negative values in the Fc image** can be selected using the check box. With the **FRET-N normalization** slider and text box a multiplication factor for the calculated FRET-N values can be set.



**Fig. 703 FRET View Options Control Block, Settings tab, Sensitized Emission**

## 6.19 Raster Scanning Image Correlation Spectroscopy (RICS)

RICS is an image analysis tool that allows retrieving dynamic information from intensity images or image stacks.

RICS analyses the two dimensional spatial correlation in x and y by shifting the image by spatial lag increments and calculating the self-similarity of the image.

In this way the correlation image is of the same dimensions as the original intensity image, but it allows the retrieval of diffusion coefficients and numbers of molecules by comparing the correlation function to model diffusion functions.

In order that RICS algorithms work, the pixel size should be at least 5 fold smaller than the  $1/e^2$  beam waist of the excitation light.

For example, the beam waist of a C-Apochromat 40x W NA 1.2 objective is 300 nm, so the pixel size should be at least as small as 60 nm. Best results are obtained, if pixel sizes are 10 fold smaller than the beam waist.

Another pre-requisite is the correct scanning speed. This should match the diffusion coefficient of your molecule. As rule of thumbs for molecules diffusing with  $D > 100 \mu\text{m}^2/\text{s}$  a speed of 4  $\mu\text{s}/\text{pixel}$  is adequate.

For molecules diffusing with a  $D = 10 - 100 \mu\text{m}^2/\text{s}$  a speed approximating 8-32  $\mu\text{s}/\text{pixel}$  dwell time will be appropriate.

Especially too high and slow speeds should be avoided. All molecules with extreme low diffusion coefficients ( $D = 0.1 - 10 \mu\text{m}^2/\text{s}$ ) should be sampled at 32-100  $\mu\text{s}/\text{pixel}$  dwelling time.

Deviations from these settings will result in intensity images not appropriate for RICS analysis.

Last not least molecular concentrations should stay between 1 nm to 1  $\mu\text{m}$ . RICS works best with time series of 20-100 images. More than one image is needed to first improve on the statistics, and second to have the possibility to remove immobile and slowly moving structures.

The RICS procedure can therefore be divided by acquisition of a time series, removing slow moving and immobile structures, computing the correlation and then fitting the data to model functions.

### 6.19.1 Access to RICS

If you have taken an image or an image series or have opened an old image or image stack, a click on the **RICS** tab of the **View** tab list will make the RICS functionality available.

The right column of the **Image** window will display the Fit table, the middle image the original intensity image and the left one the computed correlation image using a default LUT (look up table) and a scale bar for the correlation (Fig. 704). Below, the result table is displayed.

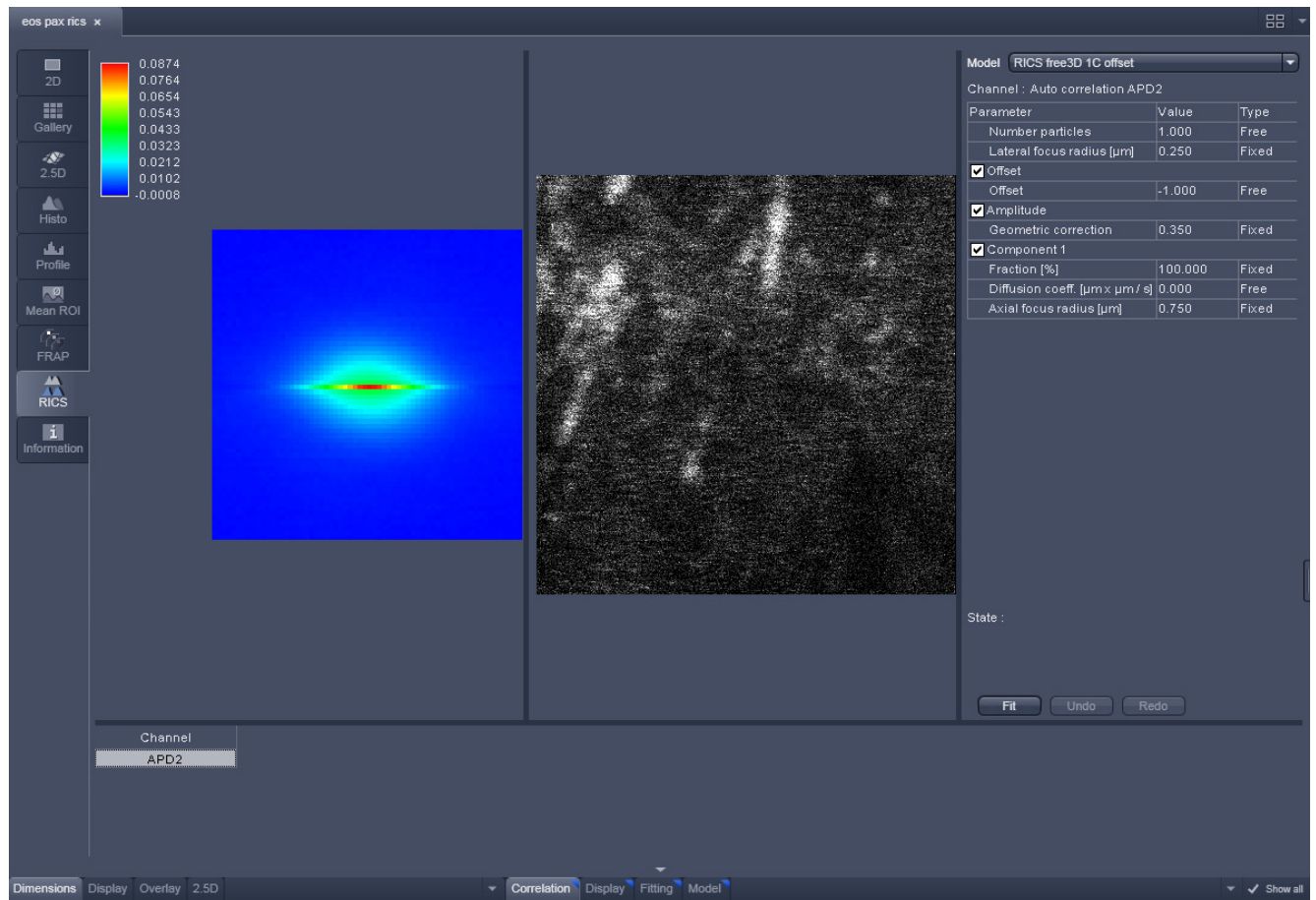


Fig. 704 RICS window with RICS register active

### 6.19.2 Control of View Functionalities

All required settings and manipulation for the RICS analysis can be called up with the View tabs. They divide into **View** for image manipulation, **RICS** for correlation analysis and **2.5D** for display functionalities. The **View** and **2.5D** options are described at respective sites of the manual dealing with image display. Here RICS functionalities are detailed.

### 6.19.3 Correlation Functionalities

Activate **Correlation** under the **RICS** view. The Correlation options will be displayed in the View control window (Fig. 705).

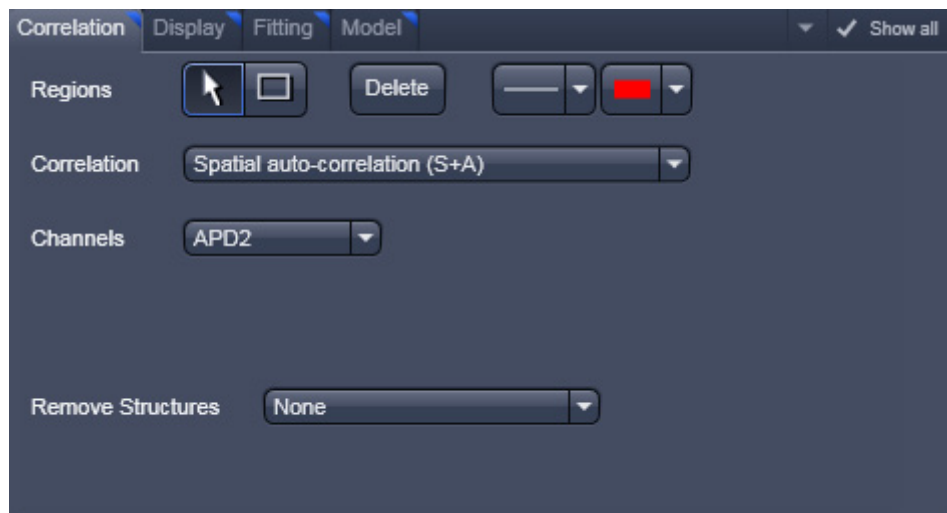


Fig. 705 Correlation control window

**Regions** allow you to draw regions of interest (ROI) within the intensity image. Activate the **Rectangle** button and draw a region within the intensity image by holding down the left mouse button. Any rectangular shaped region can be drawn. The correlation will be newly computed taken into account now only the ROI.

If the **Arrow** button is active, the ROI can be moved around the image by drag and drop. If the **Arrow** button is deselected, a new ROI will be drawn.

For each ROI a correlation image will be computed (Fig. 706). You can view each correlation by selecting the respective row in the **Result** table at the bottom. It is not possible to view two correlation images at the same time.

If a ROI is selected with the Arrow button active, then pressing the **Delete** button will remove the ROI from the intensity image.

With the **Line** button you can select the line width and with the Color rectangle button the color of a selected ROI via drop down menus.

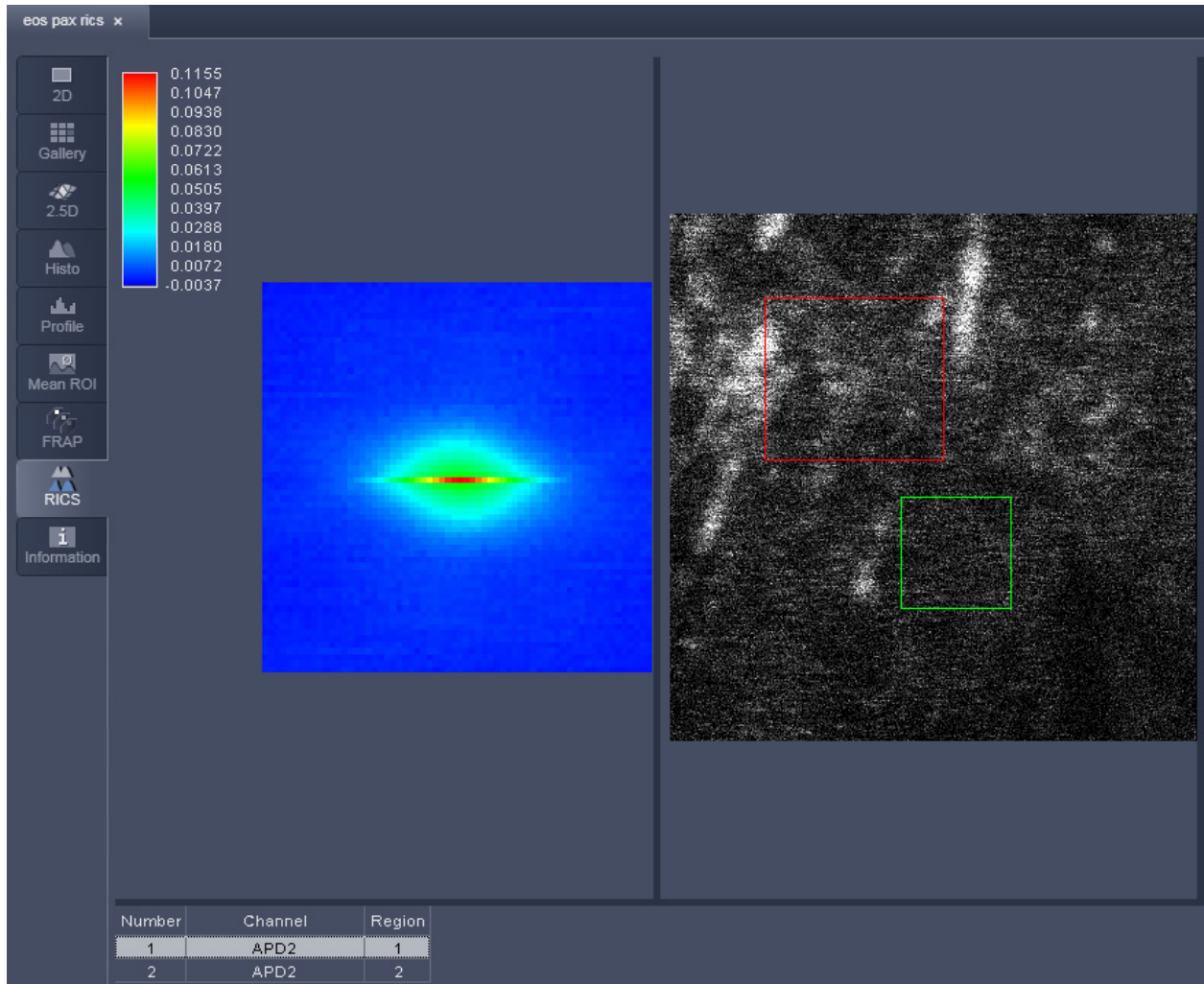


Fig. 706 Image window with two selected regions of interest in the intensity image

**Correlation** allows you to select the type of correlation analysis you want to perform. For a one channel recording the only option is **Spatial auto-correlation (S+A)**. For a two channel recording you can select from the pull down menu between **Spatial auto-correlation (S+A)** and **Spatial cross-correlation (S+C)** (Fig. 707).

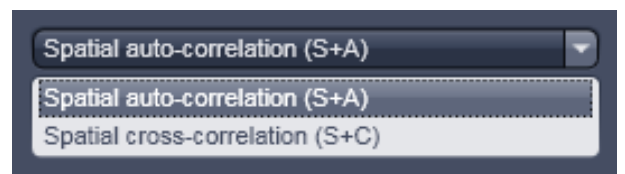


Fig. 707 Correlation pull down menu

**Channels** allow you to select the channel for which a correlation should be performed. For a one channel record auto-correlation setup, only the active channel is available. For a two channel auto-correlation setup you can select the channel by the pull down menu (Fig. 708). The correlation of the active channel will be computed and displayed. Both channels will be displayed in the **Result** table and the correlation of the selected row will be displayed.

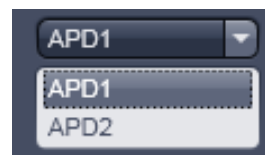
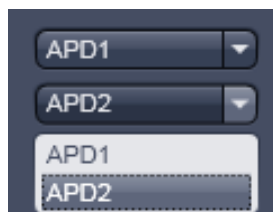


Fig. 708 Channels pull down menu for auto-correlation



**Fig. 709** Channels pull down menu for cross-correlation



**Fig. 710** Remove structures pull down menu



**Fig. 711** Averaging frames enter box

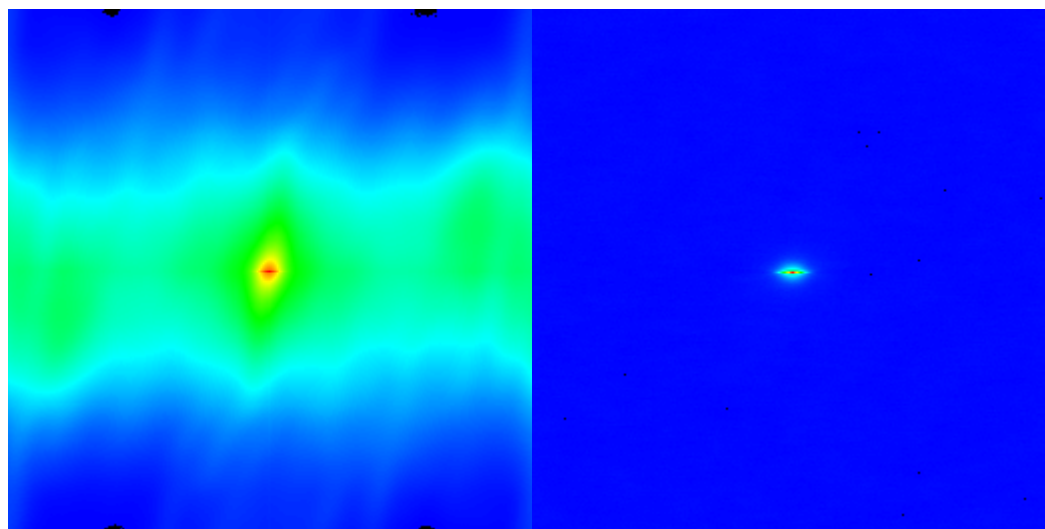
For a two channel cross-correlation setup, two drop-down menus will be displayed (Fig. 709). The upper channel will be the one that will be cross-correlated against the lower channel. In addition, two auto-correlations for each channel will be displayed. All correlations will be displayed in the **Result** table and the correlation image of the selected row will be presented. Note, if both channels are identically selected, the cross-correlation all three correlations will be identical auto-correlations for the double selected channel.

**Remove structures** is needed to remove the contribution of immobile or slowly moving structures from the correlation. You can select what kind of average subtraction you want to perform from the pull down menu (Fig. 710). If **None** is selected, no subtraction will be done.

If **Slowly moving structures** is the choice the **Average frames** enter box will become available (Fig. 711). Choose a moving average frame number that would clean up the correlation from slow moving structures by entering a number in the box, by using the arrows or the slider.

Using 5 frames is a good compromise for nearly all situations. This creates a new stack of  $n-m+1$  frames, where  $n$  = number of frames from original stack and  $m$  = number of moving average frames.

Subtraction of the moving average frames from the original frames starts at  $m/2$  and ends at  $m/2+(n-m+1)$  frames of the original stack. Thus the first and last frames of the original stacks are not used. To avoid negative pixels by this procedure a scalar is added to each subtracted frame that is computed from all pixels of the moving average that was used for subtraction. The result is a correlation image, that is not any more afflicted by slow moving and immobile structures and from which fast dynamic processes can be calculated (Fig. 712).



**Fig. 712** Correlation image before (left) and after (right) removal of slow moving structures

When **Immobile structures (+Stack)** is selected, the average image from the stack (pixel by pixel) is subtracted from every image and a scalar is added to avoid negative pixels. The scalar is computed from the average of all pixels from all frames of the stack. When **Immobile structures (+Plane)** is selected, the average image from the stack (pixel by pixel) is subtracted from every image and a scalar is added to avoid negative pixels. The scalar is computed from the frame to which it is added. Both procedures are equally valid in most of applications.

#### 6.19.4 Display Functionalities

Activate **Display** under the **RICS** view. The Display options will be displayed in the View control window (Fig. 713).

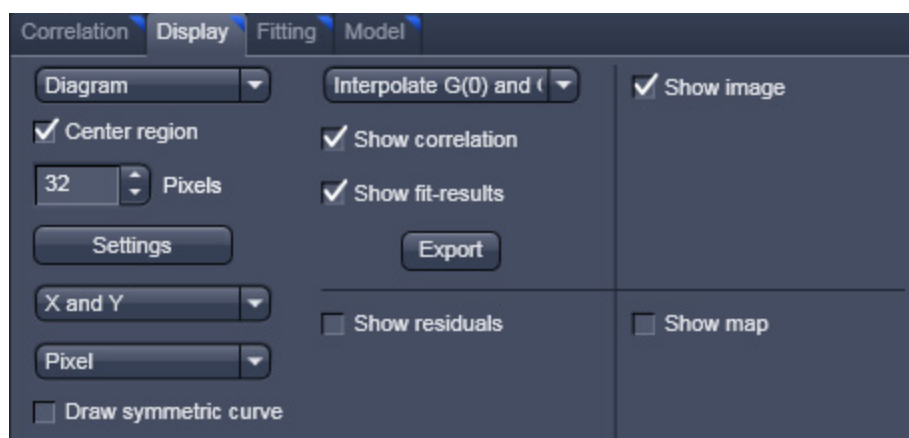


Fig. 713 Display control window

In the **Representation** pull down menu you can choose how the correlation function should be displayed.

Four options are available (Fig. 714):

**Diagram** will display the horizontal and vertical profiles of the correlation function and the fit / residuals if activated;

**Image** will display the correlation and the fit / residuals if activated as two dimensional images;

**Table** will display the coordinates of the horizontal and vertical profiles of the correlation and the fit / residuals if activated that can be copied or saved via a right mouse click from the **Table Export** menu (Fig. 715);

**2.5 D** will display the correlation function and the fit / residuals if activated as pseudo 3D images (Fig. 716).

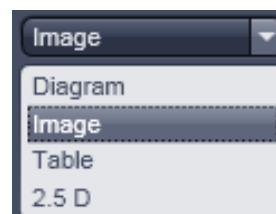


Fig. 714 Representation pull down menu

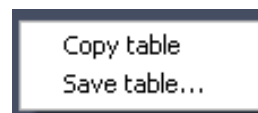


Fig. 715 Table export menu

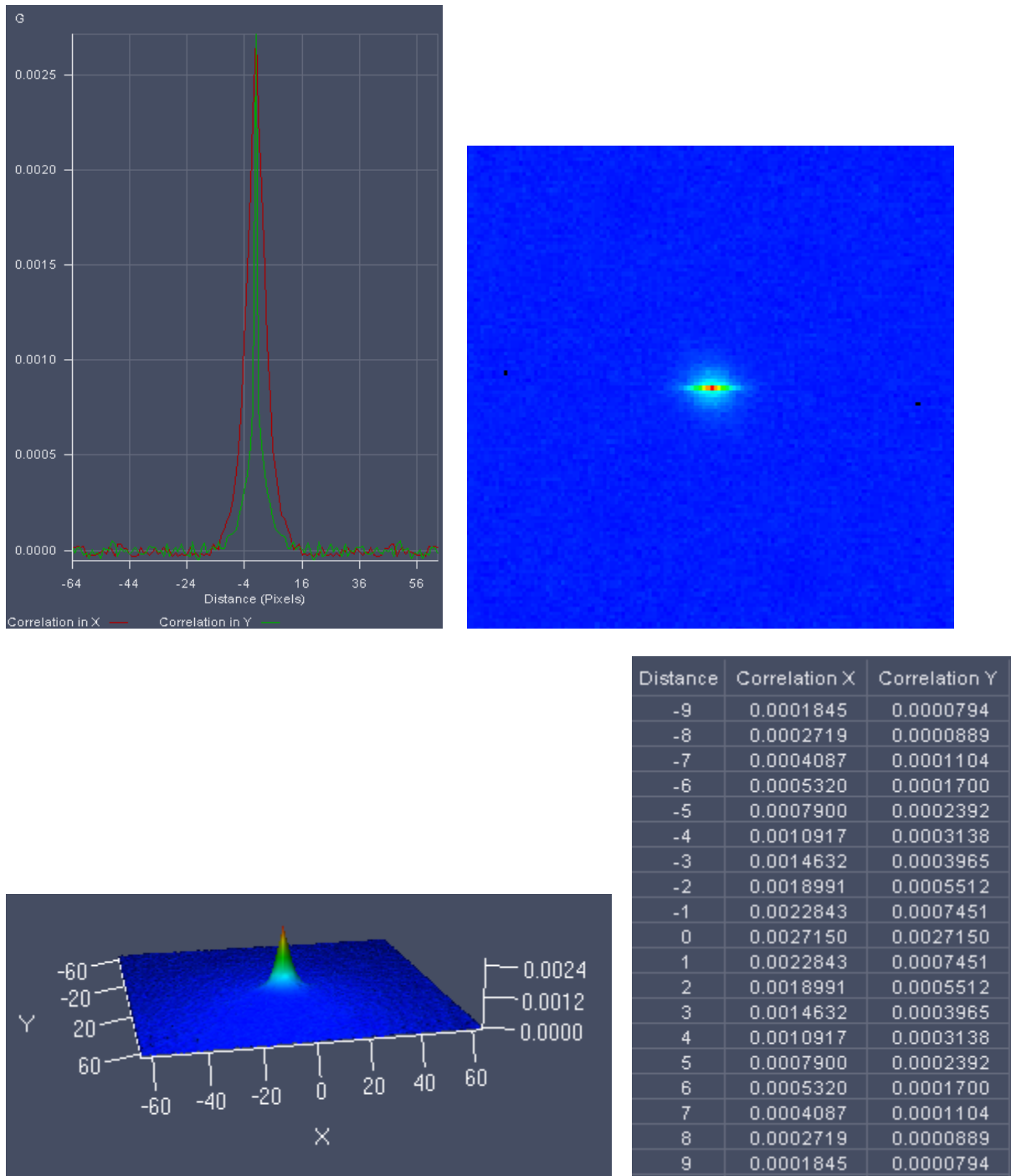


Fig. 716 Correlation displayed clockwise as Diagram, Image, Table and 2.5 D



Fig. 717 Pixel pull down menu

Note, that for different representations different options will become available.

For the **Diagram**, **Table** and **2.5D display**, the **Pixel** pull down menu becomes available (see Fig. 717). Here you can choose to display distances as integer pixels or metrically in  $\mu\text{m}$ .



For the Diagram and Table, the **X and Y** pull down menu and the **Draw symmetric curve** check box will be additionally available. In the **X and Y** pull down menu you can choose if you want to display correlations in both (x and y) or only one (x or y) direction (see Fig. 718 and Fig. 719).

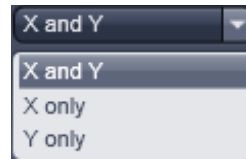


Fig. 718 X and Y pull down menu

If the **Draw symmetric curve** check box is checked (Fig. 719), the correlation will be displayed symmetrically around the zero spatial lag with negative and positive lag values displayed. If the box is unchecked, only the positive lag values will be displayed.



Fig. 719 Draw symmetric curve check box

For the Diagram only the **Settings** popup menu is available (see (Fig. 720),. Here you can assign for the **X and Y Dimensions** individual colors to the **Correlation, Fit results** and **Residuals** diagrams via the corresponding color palette drop down menus. You can also define for each dimension the line width by entering a number in the **Line width display boxes** or using the arrows. By checking the left and right **Auto-Scale check boxes**, the diagrams for Correlation & Fit results as well as the diagram for the Residuals, respectively, will be auto scaled to the lowest and highest value. By de-checking you can enter your own minimum and maximum values into the corresponding **Min.** and **Max. display boxes** by typing or by using the arrows. All values between the minimum and maximum will be scaled accordingly. Values lying outside will not be displayed.

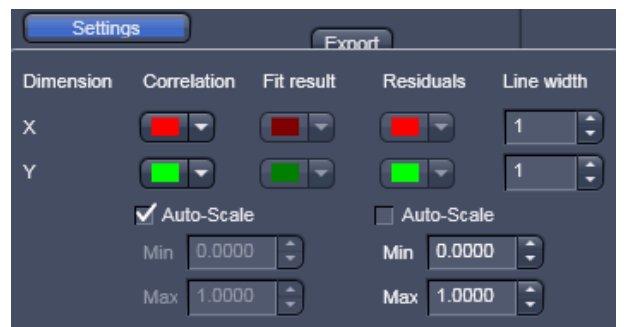


Fig. 720 Settings popup menu

If the **Center region** box is checked the correlation will be centered on the pixel numbers that can be put into the displayed **Pixels** input box. This allows you to display only the relevant part of the correlation and avoid areas of no content.

If the **Draw scaling bar** box is checked, a Scaling will appear for any correlation diagram and deviated diagram (Fit, Residuals, Map). For the intensity image, no scaling bar is available.

If the **Use image palette** box is checked, the look up table (LUT) selected for the intensity image will be taken for the correlation diagram and Maps; the LUT will not apply for Fit and Residuals.

The **Interpolation** drop down menu (Fig. 721) allows you to select, which data points will be interpolated in the correlation function. If **No interpolation** is selected, none of the data points will be interpolated. If **Interpolate G(0)** is selected the zero spatial correlation value will be interpolated. If **Interpolate G(0) and G(1)** is selected the zero spatial correlation and the 1<sup>st</sup> pixel shifted correlation value will be interpolated.

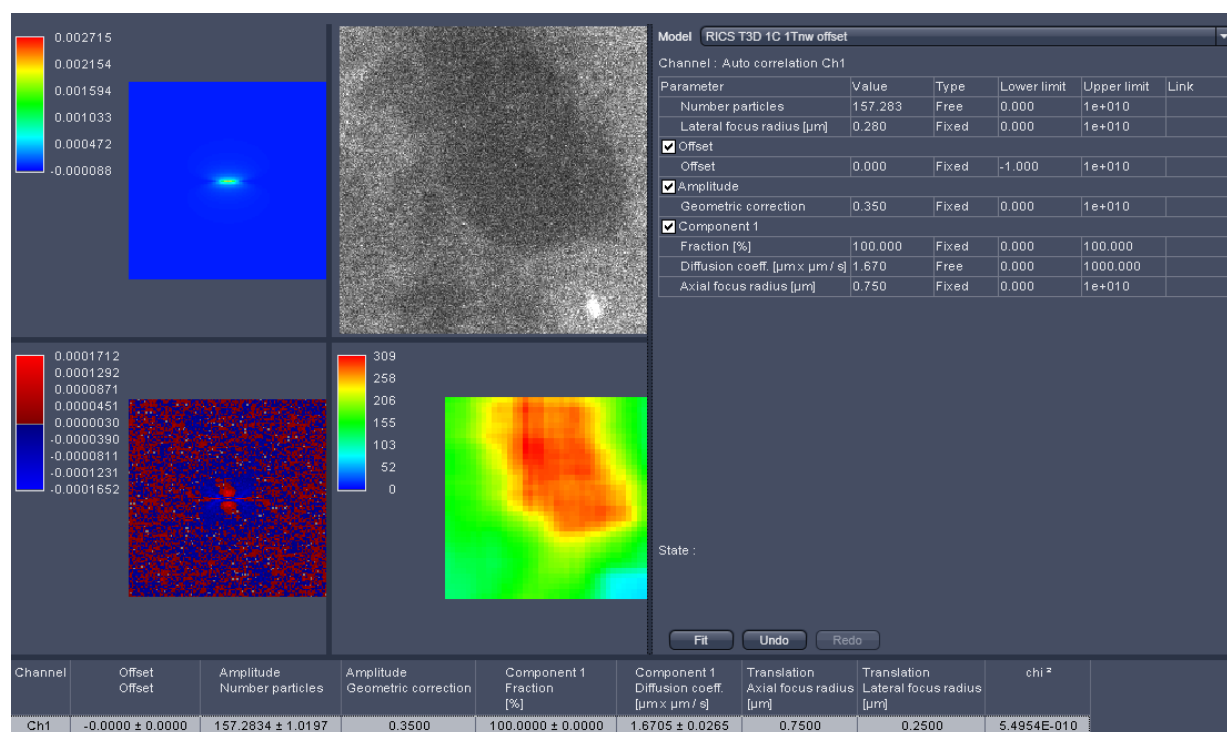


Fig. 721 Interpolation drop down menu

Checking and unchecking the **Show fit-results** box will toggle between the correlation and fit images. Note, if this box is activated, the **Interpolate G(0)** box will disappear. Pressing the export button below the **Show fit-results** box will export the correlation image or fit image, whatever is active as an image in .lsm format.

If **Table**, **Image** or **Diagram** was selected from the **Representation** pull down menu, the 2D image will be exported. If 2.5 D was selected, a pseudo 3D image will be stored. If the Show residuals box is checked, the Residuals will be displayed in a format as selected in the **Representation** pull down menu (Fig. 714). By activating this box the **Hide G(0)** error check box becomes available as well. Check the box in order to omit the zero spatial correlation value to be included in the fit.

Pressing the export button below the **Hide G(0)** box will export the residuals image. If **Table**, **Image** or **Diagram** was selected from the **Representation** pull down menu, the 2D image will be exported. If 2.5 D was selected, a pseudo 3D image will be stored. Activating / Deactivation the **Show image** check box will display or remove the intensity image from the **Center image** window.



**Fig. 722** Center Image window displaying Fit image, Intensity image, Fit table, Residuals Image, Map and Result table (from top left to bottom right)

Note that the **Draw scaling bar**, **Use image palette** and **Hide G(0)** check boxes will only be available in the RICS **Show all** mode. To activate the **Show all** mode activate the RICS **Show all** button on the **View Control** bar.

If the **Show map** box is checked, a map, if being created before, will be displayed and the map options will be visible. In the **Region in Pixels** input box you determine the size of the region in an m x m format to be used for mapping the intensity image. This size should naturally be smaller than the image size, but it is recommended not to fall below 64 x 64 pixels to obtain enough signal-to-noise ratio (SNR).

If you press the **Settings** button, the settings menu will pop up (Fig. 723).

In **Map Selection** you can determine the map type with the **Map type** pull down menu (Fig. 724). You can choose between the **Number particles** and the **Diffusion coeff. ( $\mu\text{m} \times \mu\text{m} / \text{s}$ )** parameter maps, that will display the relative molecule numbers –please note that if average subtraction is performed the information on absolute numbers is lost - and diffusion coefficients of the mapped areas.

You can also display the informative pixels by choosing **Inf.Pix.** This will display a map that indicates, how many pixels contributed meaningfully to the correlation before dropping to zero.

If the **Auto Scale** check box is activated, the maps are scaled automatically between the highest and lowest value. If unchecked you can enter in the **Min** and **Max input boxes** own minimum and maximum values. All values lying between will be accordingly scaled. Note that all values lying outside the minimum and maximum will be displayed as black in the maps. This option is helpful in eliminating extreme outliers.

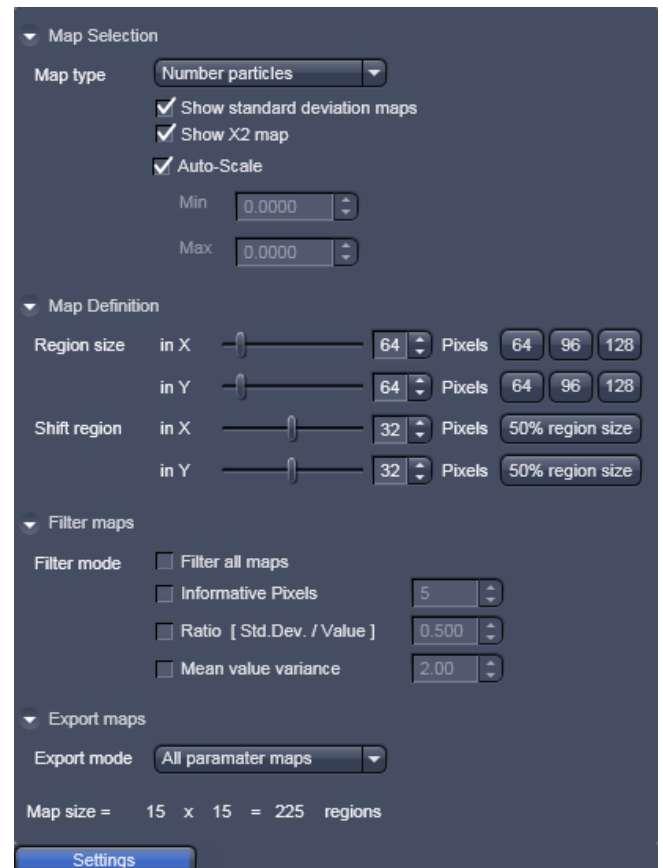


Fig. 723 The Map settings menu

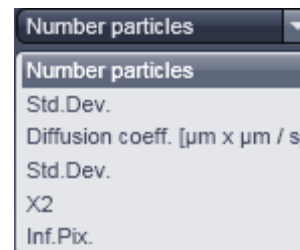


Fig. 724 Map type pull down menu

In the **Show all** mode you have further the option to display the **Std.Dev.** (standard deviation) maps of both parameter maps as well as the  $X^2$  (Chi square) map by checking the **Show standard deviation maps** and **Show X2 map** boxes.

In **Map definition** you can define the region size in an m x n format. Please note, if you don't choose a size as an integer part of the intensity image, some rest areas to the right and bottom of the image will not be taken into account. Region sizes can be put into the **Region sizes in X / Y in Pixels** input boxes by using the slider, arrows or typing. Default values in an m x m format can be obtained by pressing the **64**, **96** or **128** buttons. The step size with which the region will be shifted from data point to data point can be put in the **Shift region in X / Y in Pixels** input boxes by using the slider, arrows or typing. The default value of a shift size half the region size can be obtained by pressing the **50% region size** button.

In **Filter maps** different **Filter modes** can be selected to sort out outlier values. Extreme outliers will affect the scaling of the map so that interesting values can be hidden. By checking the **Filter all maps** box, chosen filters will be applied for all maps. If not selected only the map chosen in the **Map type** pull down menu will be filtered. You can choose between Informative Pixels, ratio and mean / variance filter by checking the respective **Informative Pixels**, **Ratio (Std.Dev./Value)** and **Mean value variance** boxes. Thresholds can be set in each case via the input boxes by typing or using the arrows. Note that filters can be combined.

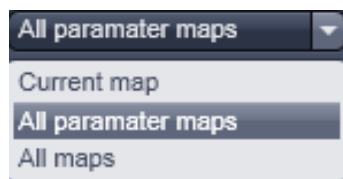


Fig. 725 Export mode pull down menu

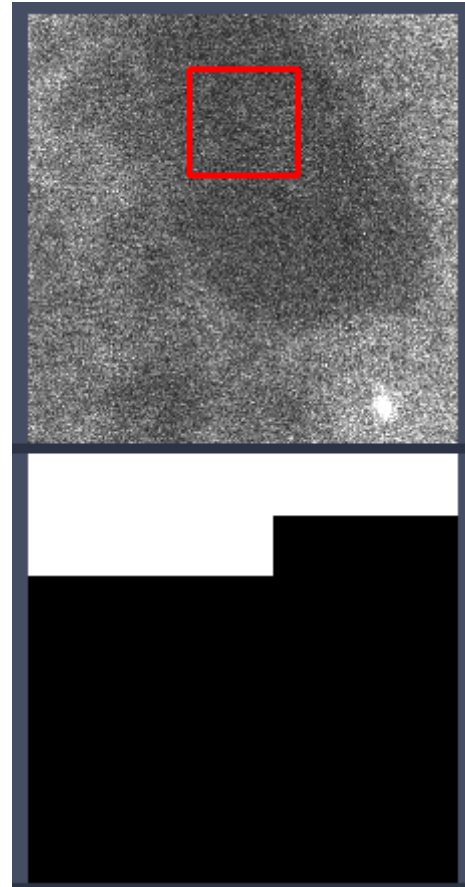
In Export maps one can select which maps should be exported as an .lsm image by selecting between the **Current map**, that is only the map selected in the Map-type pull down menu, **All parameter maps**, that are the **Number particles** and **Diffusion coeffic. ( $\mu\text{m} \times \mu\text{m} / \text{s}$ )** maps, and **All maps**, that are the parameter maps, **Std.Dev.** maps and  $X^2$  maps (Fig. 725).

The map size in terms of region numbers is displayed in the info area of the **Settings** menu.

By pressing **Generate** a map is created with region and shift sizes as determined in the settings. During creation of the new map, an old map will be overwritten. The progress in calculation is displayed in the intensity image by an overlay region and the black map is filled with white regions (Fig. 726).

The **Generate** button will only be active, if the correlation was fit to a model beforehand to ensure the correct one was selected.

Only at the end of the map, the scaling is calculated and the map displayed in the chosen palette. By pointing the pointer to a region in the map, the corresponding site from which this data point was derived will be displayed in the intensity image by the overlay region. By pressing **Export** maps will be saved according to the settings in an .lsm format or the type you choose in the Windows Explorer popup menu.



**Fig. 726** Progress indicator during creating a map in the intensity (upper panel) and map (lower panel) images

### 6.19.5 Fitting Functionalities

Activate **Fitting** under the **RICS** view. The Fit options will be displayed in the View control window (Fig. 727).

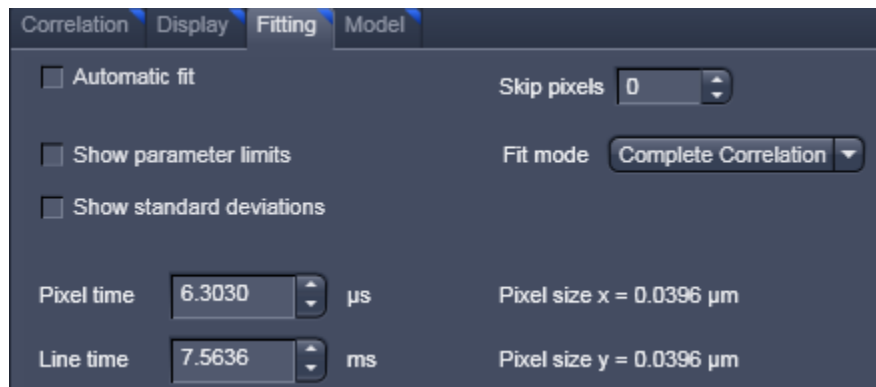


Fig. 727 Fit control window

If the **Automatic fit** check box is selected, a fit will be performed automatically, whenever the correlation input intensity image is changed. For example, if a region of interest is drawn or moved within an intensity image, the fit will automatically be performed according to the default or loaded model. If the check box is deselected, a fit will only be performed when pressing the **Fit** button in the **Fit** table (Fig. 728).

The screenshot shows the 'Fit table' for the model 'RICS T3D 1C 1Tnw offset'. The channel is 'Auto correlation Ch1'. The table lists the following parameters:

Parameter	Value	Type	Lower limit	Upper limit	Link
Number particles	157.283	Free	0.000	1e+010	
Lateral focus radius [ $\mu$ m]	0.280	Fixed	0.000	1e+010	
<input checked="" type="checkbox"/> Offset					
Offset	0.000	Fixed	-1.000	1e+010	
<input checked="" type="checkbox"/> Amplitude					
Geometric correction	0.350	Fixed	0.000	1e+010	
<input checked="" type="checkbox"/> Component 1					
Fraction [%]	100.000	Fixed	0.000	100.000	
Diffusion time [ $\mu$ s]	0.000	Free	0.000	1e+010	
Structural parameter	3.000	Free	0.000	1e+010	

State :

Buttons: Fit, Undo, Redo

Fig. 728 Fit table

You can select a model from the **Model** pull down menu in the **Fit** table. Every stored model will be listed (Fig. 729). Below the **Model** pull down menu the active channel is displayed in the **Channel** display area. The table below lists the terms and parameters of the selected model in the **Parameter** column, its current value in the **Value** column, the type of the parameter in **Type** column that can be set as **Free** (freely floating with initial guess), **Fixed** (no fit) and **Start** (freely floating with start value) from the **Type** pull down menu between (Fig. 730), the lower and upper limits assigned by typing in the desired number to the parameter in the **Lower limit** and **Upper limit** columns and the type of global linkage in the **Link** column, which presently is not activated. Terms in the parameter columns can be activated or deactivated by ticking or un-ticking the respective check boxes.

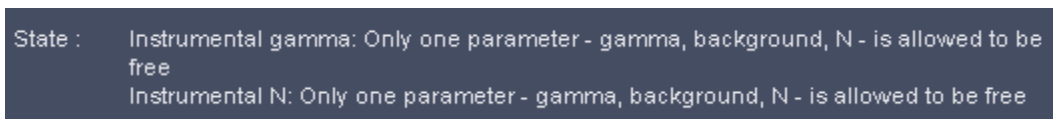


**Fig. 729** The model pull down menu of the Fit table

In the **State** display area any abnormal settings will be displayed. For example, if Number particles and Geometric factor are both set to free, the system will comment that one has to be fixed (Fig. 731).



**Fig. 730** Type pull down menu



**Fig. 731** The State display area with message

To perform a fit press the **Fit** button. The active correlation function will then be fitted according to the settings in the **Fit** table. Pressing the **Undo** button will cancel the commands in the reverse order of their placement. The **Redo** button will become active once the **Undo** button has been pressed once. It allows recalling cancelled commands in the order of their cancellation.

Fit results and statistics will be listed in the **Result** table (Fig. 732). It lists the channel and all parameters (with or without standard deviation according to the settings) that are present in the **Fit** table as well as the  $X^2$  (chi<sup>2</sup>) value of the fit.

Channel	Offset Offset	Amplitude Number particles	Amplitude Geometric correction	Component 1 Fraction [%]	Component 1 Diffusion coeff. [μm x μm / s]	Translation Axial focus radius [μm]	Translation Lateral focus radius [μm]	chi <sup>2</sup>
Ch1	-0.0000 ± 0.0000	157.2834 ± 1.0197	0.3500	100.0000 ± 0.0000	1.6705 ± 0.0265	0.7500	0.2500	5.4954E-010

**Fig. 732** The Result table

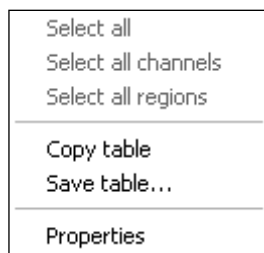


Fig. 733 Result table menu

By clicking with the right mouse button into the **Result** table the table's menu box will pop up (Fig. 733). You have the option to copy the table to the clipboard by selecting **Copy**, or by choosing save to save the data as a text file. Please note that the options **Select all**, **Select all channels** and **Select all regions** is currently not available.

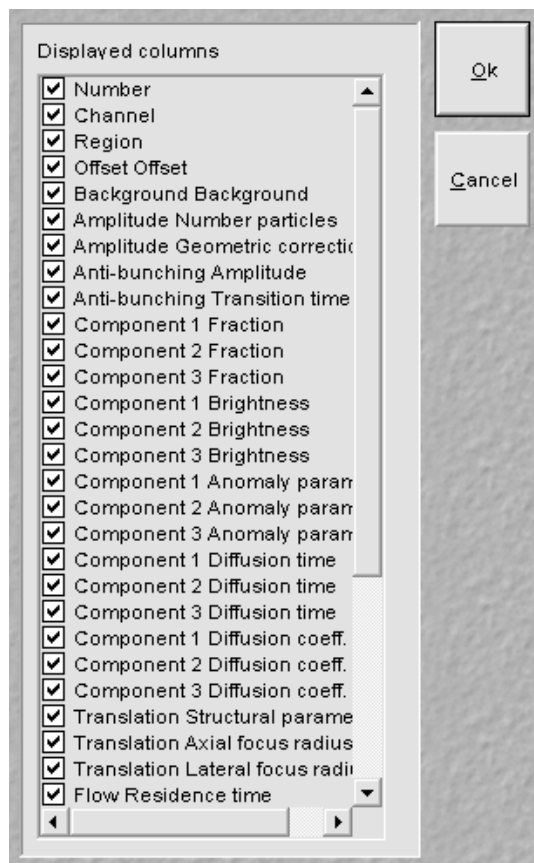


Fig. 734 Properties sub menu

By selecting **Properties** the **Properties** submenu will appear (Fig. 734). The table lists all available parameters. You can select the parameters you want to have displayed in the result table by checking the corresponding boxes.

If the **Show parameter limits** check boxed is ticked, the **Upper limits** and **Lower limits** columns are displayed in the Fit table, otherwise they are not visible. If the **Show standard deviations** check box is ticked, standard deviation for floating parameter values are displayed, otherwise they are suppressed.

Pixel dwelling times in  $\mu\text{s}$  and line times in ms of the scan are displayed in the **Pixel times in  $\mu\text{s}$**  and **Line times in ms** input boxes in the **Show all** mode. They are read from the Meta data of the image and are fixed values for the Fit. If you want to simulate with other numbers, they can be entered in the input boxes via the arrows or typing. Note, if numbers are changed and the image saved under the same name, the real values will be lost. Pixel sizes in  $\mu\text{m}$  are only accessible from the **Information** register.

The **Skip pixels** input box in the **Show all** mode allows setting the numbers of spatial lag pixels that should be omitted for the Fit. The number can be entered by typing or using the arrows.

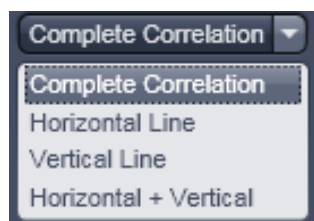


Fig. 735 Fit mode pull down menu

With the **Fit mode** input box, only available in the **Show all** mode, the data set for fitting can be defined (Fig. 735). You can select between fitting the **Complete Correlation**, the **Horizontal Line** only, the **Vertical Line** only, or the combined **Horizontal + Vertical** lines.

In the **Show all** mode, the size of the Pixels in x and y dimensions are shown in the **Pixel size display area**. Note that the sizes cannot be edited.



### 6.19.6 Model Functionalities

Activate **Model** under the **RICS** view. The **Model** options will be displayed in the View control window (Fig. 736).

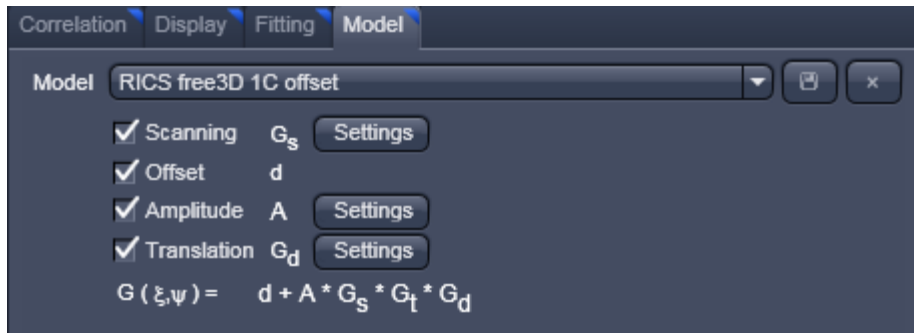


Fig. 736 Fit control window

With the **Model** pull down menu you can select a saved pre-defined model from the list. You can rename a created or changed model by typing in a new name in the display box. If the **Ok** button is pressed, the model will be saved under the new name (Fig. 737). If the model name was not changed, you will be prompted to acknowledge to overwrite the old existing one in the **Save Model Warning** menu (Fig. 738). Press **Yes** to overwrite, **No** to keep the old model.

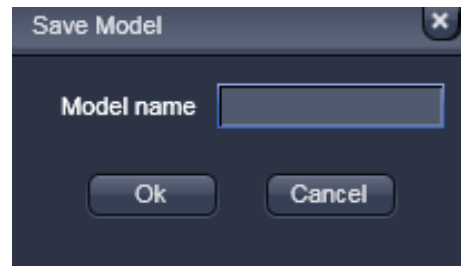


Fig. 737 Model Save menu

Type in a name in the **Model name** display box and press **Ok**, if you want to save the model, or press **Cancel** without saving. You can delete a model by pressing the **Cross** button. You will be prompted to acknowledge the action within the popped up **Delete Model** menu (Fig. 739). Press **Yes** to delete, **No** if the model should be kept.

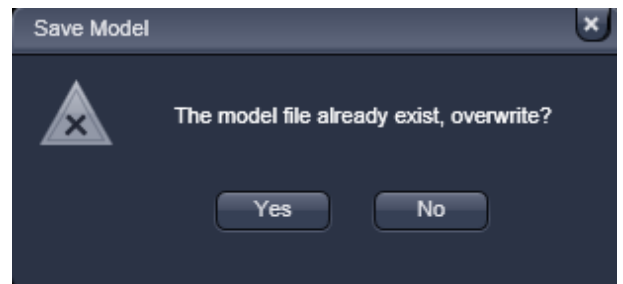


Fig. 738 Save Model Warning menu

Below the Model pull down box the available terms to assemble a model are listed. If you want to take a term into account, check the corresponding box. Four terms are available: **Scanning**  $G_s$ , **Offset**  $d$ , **Amplitude**  $A$  and **Translation**  $G_d$ . The assembled model will be displayed in the spatial correlation  $G(\xi, \psi)$  display area.

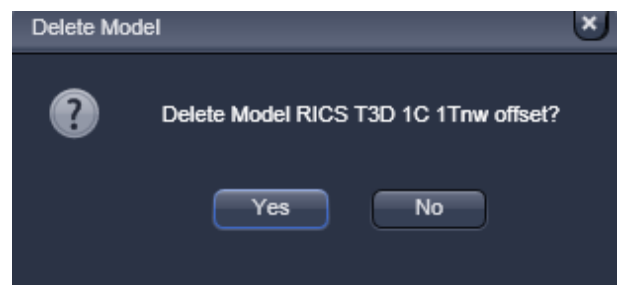


Fig. 739 Delete Model menu

For three of the terms ( $G_s$ ,  $A$  and  $G_d$ ) settings menus are available. To open a settings menu, press the corresponding **Settings** button.

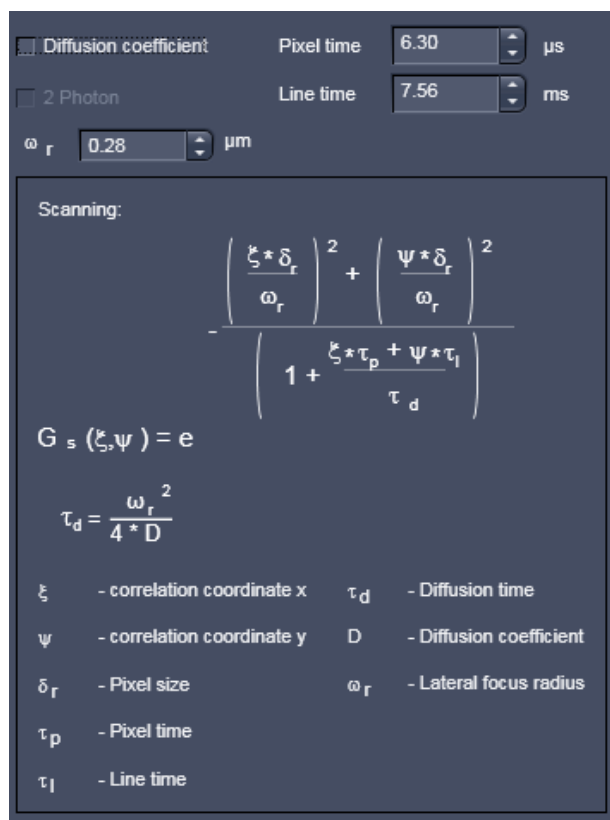


Fig. 740 Settings for the Scanning term

**Scanning  $G_s(\xi, \psi)$**  describes the scanning term of the model function. Scanning is only active in the **Show all** mode. To open the **Scanning** settings press the **Settings** button (Fig. 740).

If the **Diffusion coefficient** check box is ticked, the diffusion coefficient will be fitted, otherwise the diffusion time. In case the box is checked, the **2 Photon** check box will be accessible. If ticked diffusion time scales with  $1/8^{\text{th}}$  of the diffusion coefficient, if un-ticked with  $1/4^{\text{th}}$ . The  $1/e^2$  radius of the laser beam can be entered within the  $\omega_r$  in  $\mu\text{m}$  input box by typing or using the arrows. Pixel dwelling times and line times can be entered in the **Pixel time in  $\mu\text{s}$**  and **Line time in  $\mu\text{s}$**  input boxes. These values are useful for simulations when fixed. They will be overwritten with the correct Meta data from the image, whenever an image is loaded. If these Meta data are not available, values have to be provided. In the **Scanning information** box the formulas for the Scanning term  $G_s(\xi, \psi)$  and the conversion formula between diffusion time  $\tau_d$  and diffusion coefficient  $D$  are displayed as well as a description of the parameter variables.

**Offset  $d$**  describes any scalar added to the correlation function. It will be necessary, if the correlation function does not decay to zero.

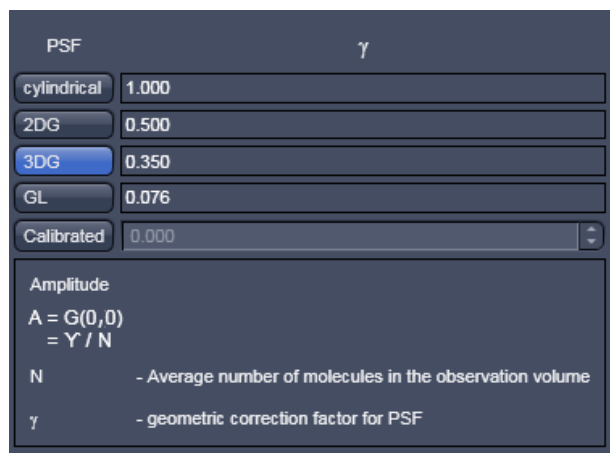


Fig. 741 Settings for the Amplitude term

**Amplitude  $A$**  describes number of particles taking into account the form of the point spread function in relation to the studied structure expressed in the geometric correction factor  $\gamma$ . To open the **Amplitude** settings press the **Settings** button (Fig. 741). You can select a **cylindrical** PSF with  $\gamma=1$ , a two dimensional Gaussian (**2DG**) PSF with  $\gamma=0.5$ , a three dimensional Gaussian (**3DG**) PSF with  $\gamma=0.35$  or a Gaussian-Lorentzian (**GL**) PSF with  $\gamma=0.076$  by pressing the respective button. Alternatively, if **Calibrated** is active, you can enter a calibrated value via the **Calibrated** input box.

In the **Amplitude information** box the formulas for the Amplitude term  $A$  is displayed as well as a description of the parameter variables.

**Translation  $G_d(\xi, \psi)$**  describes the translational diffusion term of the model function. To open the **Translation** settings press the **Settings** button (Fig. 742).

Fractional intensities

Diffusion coefficient  $\omega_r$    $\mu\text{m}$

2 Photon

Components:

Free / anomalous:

Dimension:

Molecular brightness:

$$G_d(\tau) = \sum_{i=1}^3 \frac{\Phi_i}{\left(1 + \left(\frac{\tau}{\tau_{d,i}}\right)^{\alpha_i}\right)^{e_{d1}} * \left(1 + \left(\frac{\tau}{\tau_{d,i}}\right)^{\alpha_i} \frac{1}{S}\right)^{e_{d2}}}$$

$\Phi_i = \frac{f_i * \eta_i^2}{\sum_{i=1}^3 (f_i * \eta_i)^2}$

$C = \frac{N}{L_A * \pi^{3/2} * \omega_r^2 * \omega_z}$       $\tau_{d,i} = \frac{\omega_r^2}{8 * D_i}$

$S = \frac{\omega_z}{\omega_r}$

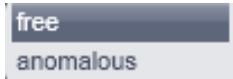
	$e_{d1}$	$e_{d2}$
1D	0.5	0
2D	1	0
3D	1	1

- $i$  - Index of component (1, 2, 3)
- $\Phi_i$  - Fractional intensity
- $f_i$  - Fraction of molecules
- $\eta_i$  - Molecular brightness
- $\tau_{d,i}$  - Diffusional correlation time
- $S$  - Structural parameter
- $\omega_z$  - Axial focus radius
- $\omega_r$  - Lateral focus radius
- $\alpha_i$  - Anomaly parameter
- $N$  - Total number molecules
- $D_i$  - Diffusion coefficient
- $c$  - Concentration

**Fig. 742 Settings for the Translation term**

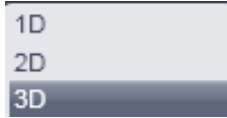
If the **Fractional intensities** box is checked, the **Molecular brightness** input boxes will become available. Enter the absolute or relative molecular brightness of the molecules, which have to be determined beforehand. If unchecked, molecular brightness will not be taken into account and the **Molecular brightness** input box will not be displayed.

If the **Diffusion coefficient** check box is ticked, the diffusion coefficient will be fitted, otherwise the diffusion time. In case the box is checked, the **2 Photon** check box will be accessible. If ticked diffusion time scales with  $1/8^{\text{th}}$  of the diffusion coefficient, if un-ticked with  $1/4^{\text{th}}$ . The  $1/e^2$  radius of the laser beam must be entered within the  $\omega_r$  in  $\mu\text{m}$  input box, which is also displayed only in case the Diffusion coefficient box by typing or using the arrows.



**Fig. 743** Free anomalous pull down menu

**Components** allow selecting **1**, **2** or **3** components by pressing the respective button. **Free / anomalous** allow via pull- down menus to select between free translational or anomalous translational diffusion for each component (Fig. 743).



**Fig. 744** Dimension pull down menu

**Dimension** offers selection via pull down menus of one-, two- or three-dimensional diffusion (Fig. 744).

In the **Translation information** box the formulas for the general translational term  $G_s(\xi, \psi)$  and useful conversion formulas are displayed as well as a description of the parameter variables.

## 6.20 Polarization Imaging

Linear (plane) polarized light, which is light whose wave goes only one direction, exciting a fluorescent molecule with a preferred dipole orientation results in polarized emitted light. It provides a contrast-enhancing method that is especially useful in the study of molecules that are fixed in their orientation or are greatly restricted in their rotational diffusion. Anisotropy is directly related to polarization and is defined as the ratio of the polarized light component intensity to the total light intensity.

In polarization microscopy using the LSM 710 and LSM 780 systems the sample is irradiated with vertical polarized light (in respect to the optical table) from a laser source. The emitted fluorescence is passed sequentially through emission polarizers (analyzers) that are housed in the **Notch filter cascade** and that transmit either the vertical ( $I_{VV}$ ) or horizontal ( $I_{VH}$ ) polarized emitted light onto the Quasar detector (L format fluorescence polarization). Since the vertical component of the emission light is parallel polarized to the vertical polarized excitation light, it is often also referred to as the parallel component ( $I_p, I_{||}$ ). Likewise, the horizontal polarized emission light is also designated as the perpendicular ("senkrecht" in German) component ( $I_s, I_{\perp}$ ). In the Software the "p" and "s" designations are used.

Polarisation **P** and anisotropy **r** are defined as:

$$P = \frac{I_p - I_s}{I_p + I_s} \quad \text{and} \quad r = \frac{I_p - I_s}{I_p + 2 \cdot I_s} \quad \text{with } 0 \leq r \leq 1.$$

Hence they can be interconverted to each other in the following way:

$$P = \frac{3 \cdot r}{2 + r} \quad \text{and} \quad r = \frac{2 \cdot P}{3 + P}.$$

In a completely polarized sample ( $I_s=0$ ) the anisotropy  $r=1$ . In a completely non-polarized sample ( $I_s=I_p$ ) anisotropy  $r=0$ .


The formulas for polarization **P** and anisotropy **r** as given above are strictly true only, if the optical transmission for both emission polarizers are identical. Any differences must be corrected by introducing a correction factor **G** that is multiplied with  $I_p$ . Hence the anisotropy **r** in such a case would be calculated according to:

$$r = \frac{I_p - G \cdot I_s}{I_p + 2 \cdot G \cdot I_s}$$

**G** can be measured using horizontally polarized excitation light and is defined as

$$G = \frac{I_{HV}}{I_{HH}}.$$

However, since in the LSM 710 and LSM 780 systems the polarization of the excitation light can not be changed easily from vertical to horizontal, G has to be determined with an isotropic fluorescent dye solution as the ratio between the mean intensities  $I_p$  and  $I_s$ , e.g. obtained from the histogram view at the image container.

 Please note that the G factor is not the mean intensity of the ratio (**R**) channel, where every pixel is computed separately. It has to be calculated from the ratio of the mean intensities of the  $I_p$  and  $I_s$  images.

As the formulas implies:

Anisotropy **r** is the preferential display as anisotropy of single species will be simply additive. Note that the ZEN Software provides for a formula to display the anisotropy directly in ratio imaging. Images could also be computed in the **Processing** tool's **Calculator**.

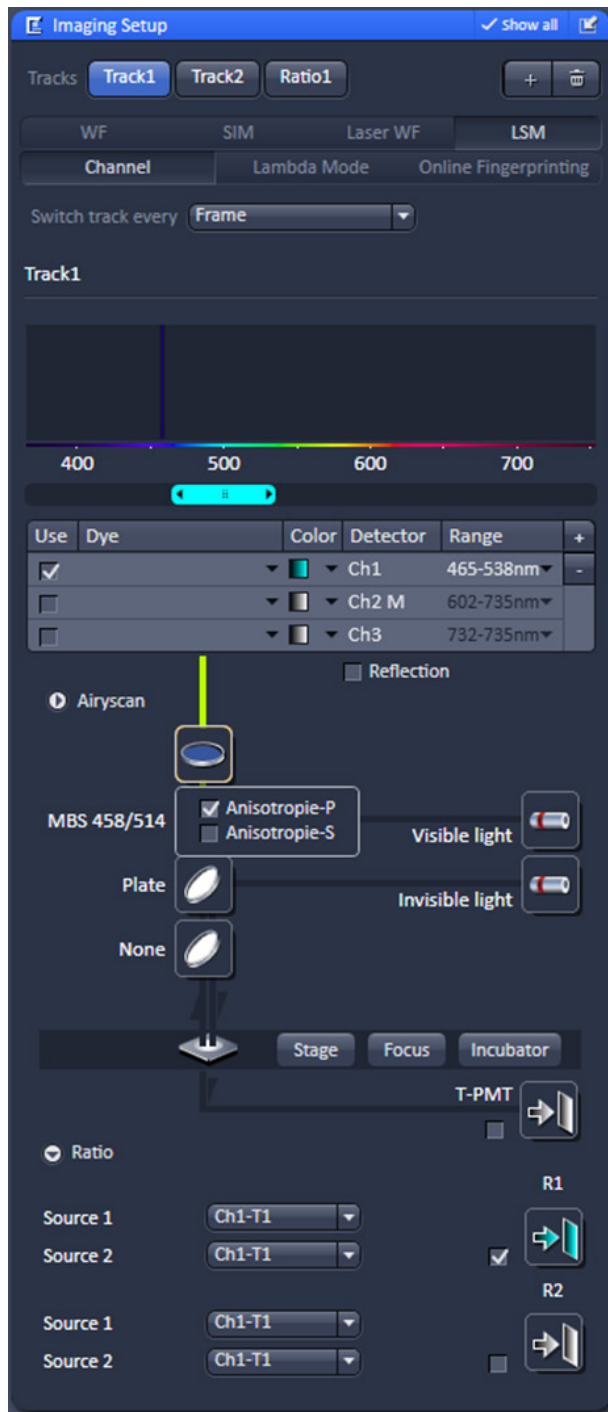


Fig. 745 Imaging Setup with Notch filter control button

### 6.20.1 Imaging Setup for Polarization Imaging

In case emission polarizers (analyzers) are available, you have a **Notch filter cascade** selection button available situated on top of the MBS button (see Fig. 745).

Set up a multitrack configuration using exactly the same settings with the exceptions of the analyzers. To this end press the **Notch filter cascade** button. This opens up the **Polarizer selection box**. Check the polarizer which you want to use with track 1. The options are **P** (for the parallel polarized light transmission) and **S** (for vertical polarized light transmission) (see Fig. 746).

If you want to ratio image, then it is best for convenience to choose **P** for track 1. Check the other polarizer for track 2.

For ratio imaging this would be **S**. For ratio imaging check the **R1 channel box** and assign **Source 1** to the selected channel-T1 and **Source 2** to the selected channel-T2. You can use the single PMTs **Ch1** and **Ch2** or the spectral detector **ChS**.

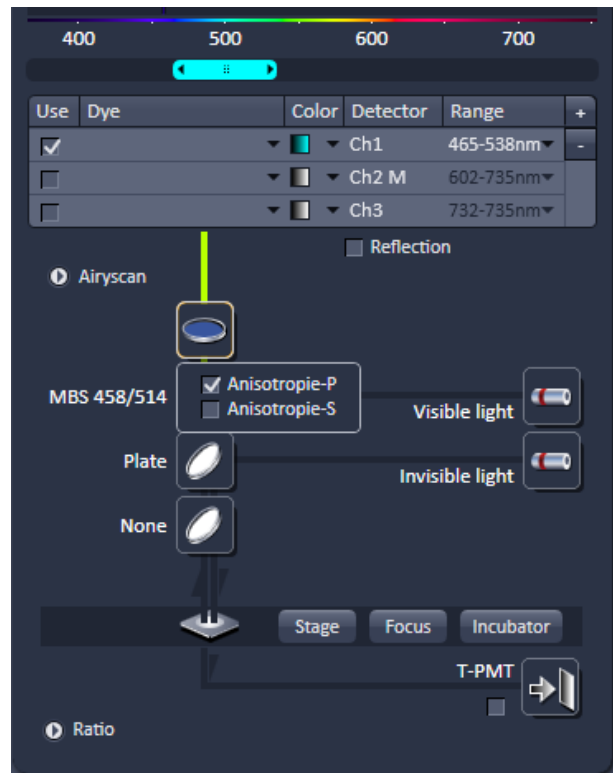


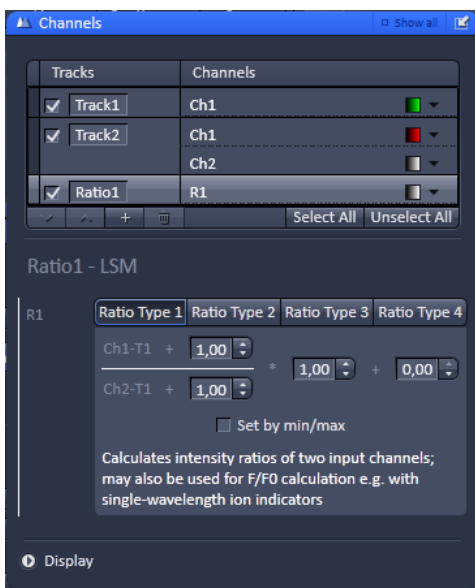
Fig. 746 Imaging Setup with Notch filter cascade option

## 6.20.2 Determination of G-factor

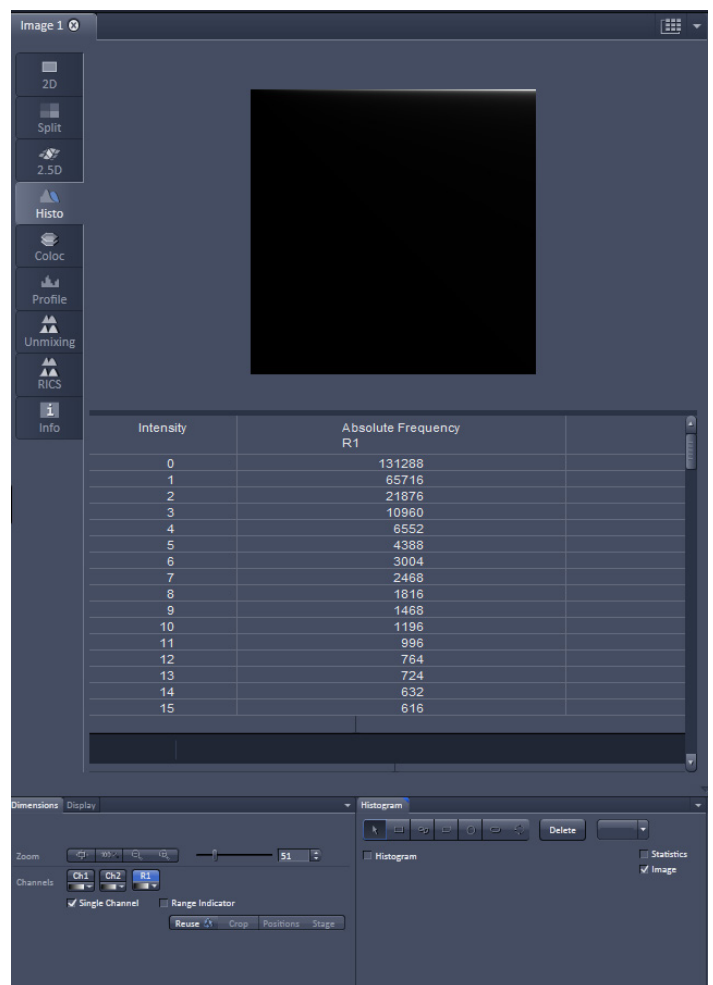
In order to determine the G-factor for the LSM 710 and LSM 780 systems, you need an isotropic medium like a fluorescent dye at a 1 mM concentration, for example fluorescein. Use the multi track configuration with P and S analyzers selected and with a beam path and channel settings appropriate to your dye. Take a single image and activate in the **Channel** tab the **Ratio** track. In the **Ratio** panel select **Ratio Type 1**. Set all editable summands to 0 and all factors to 1 (see Fig. 747).

For an inverted microscope, use for convenience a glass bottom dish and pipette enough solution in to cover the glass well. For an upright stand, squeeze a drop of solution between the glass bottom dish and a cover slip.

If you have chosen **P** in the Notch filter cascade for Track 1 and assigned it to Ch1-T1 and **S** for track 2 assigned to Ch1-T2 then the G factor is the mean intensity value of the R1 channel. For display activate the **Histo** register of the Image and select the R1 channel (see Fig. 748).



**Fig. 747** Channels tool with Ratio Type 1 formula for the Ratio1 channel selected



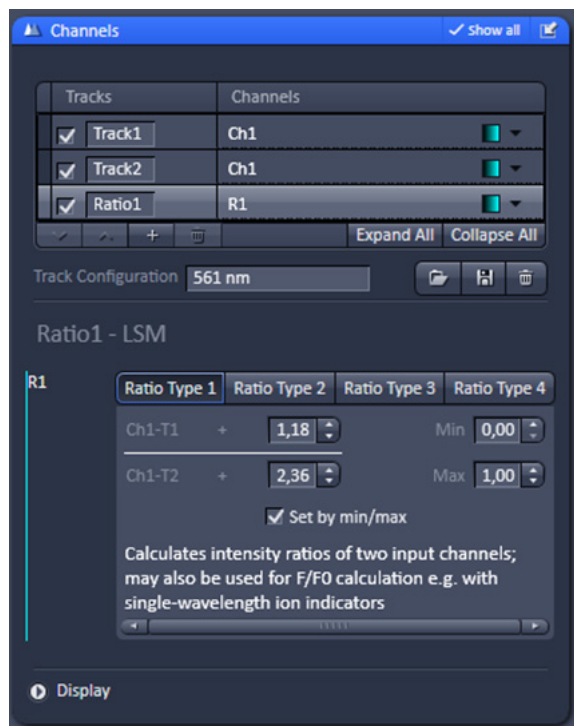
**Fig. 748** Histogram View with Ratio1 channel activated

The G-factor is therefore defined as:

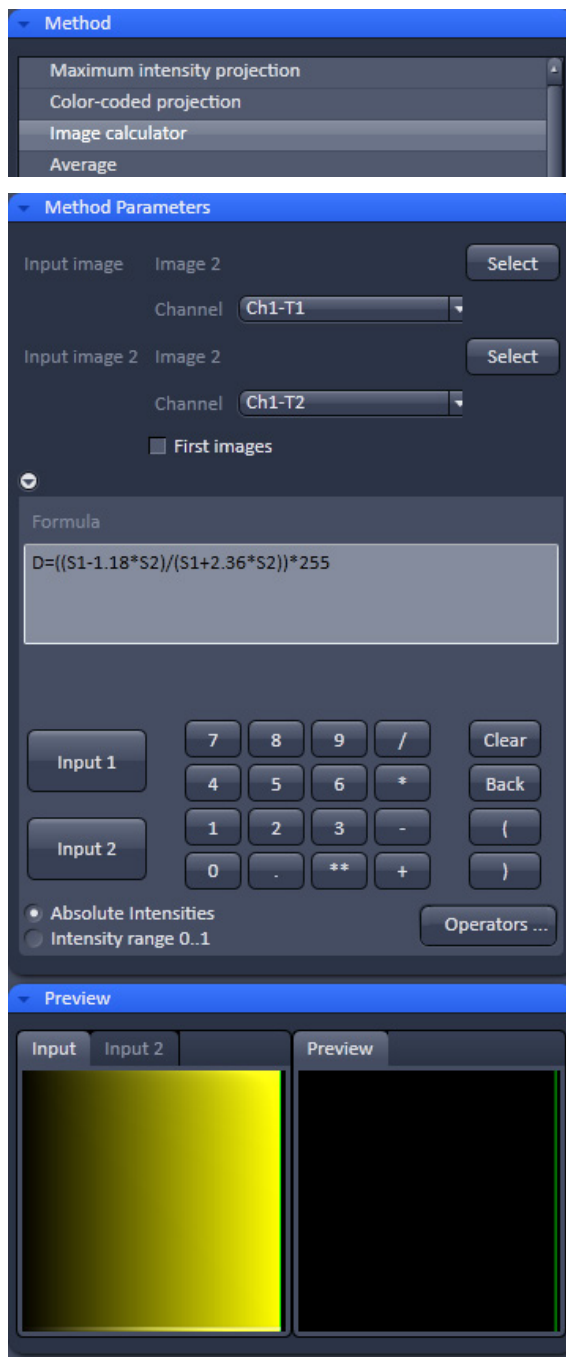
$$G = \frac{Ch1-T1}{Ch1-T2} = \frac{I_P}{I_S}$$

### 6.20.3 Obtaining an Anisotropy Image

Set up a multitrack configuration with alternating analyzers: **P** in track 1, **S** in track 2, leaving all other settings equal (see Fig. 749). Assign track 1 to **Ch1-T1**, track 2 to **Ch1-T2**. Alternatively assign to Ch2-T1 and Ch2-T2 or ChS1-T1 and ChS1-T2, whatever physical channel you want to use.



**Fig. 749** Channels tool with Ratio Type 1 formula selected for the Ratio1 channel using a G factor of 1.18



**Fig. 750** Image calculator with anisotropy formula and a chosen G-factor of 1.18 with absolute intensities selected



---

In the **Ratio1** channel choose the **Ratio Type 3** formula. With Ch1-T1 and Ch1-T2 corresponding to  $I_p$  and  $I_s$  this formula corresponds to the formula for anisotropy  $r$ . For the factors put in the value for the G-factor in the numerator and  $2 \times G$  in the denominator. Scale by Min/Max by checking the **Set by min/max** box and entering **0** in the **Min input box** and **1** in the **Max input box**. With a corresponding look up table like rainbow this will produce a false colored anisotropy image in the Ratio1 channel.

Alternatively you can use the image calculator with source 1 (S1) being the **P** track image (Ch1-T1) and source 2 (S2) the **S** track image (Ch1-T2) with consideration of the G-factor (see Fig. 750).

Proceed as follows. In the **Processing** tab select the **Image calculator** (Fig. 750). Press **Select** and click on the desired input image. In the **Channel** pull down menu of **Input Image Image 1** select **ChX-T1**, where X stand for 1, 2 or S. Accordingly, in the **Channel** pull down menu of **Input Image Image 2** select **ChX-T2**.

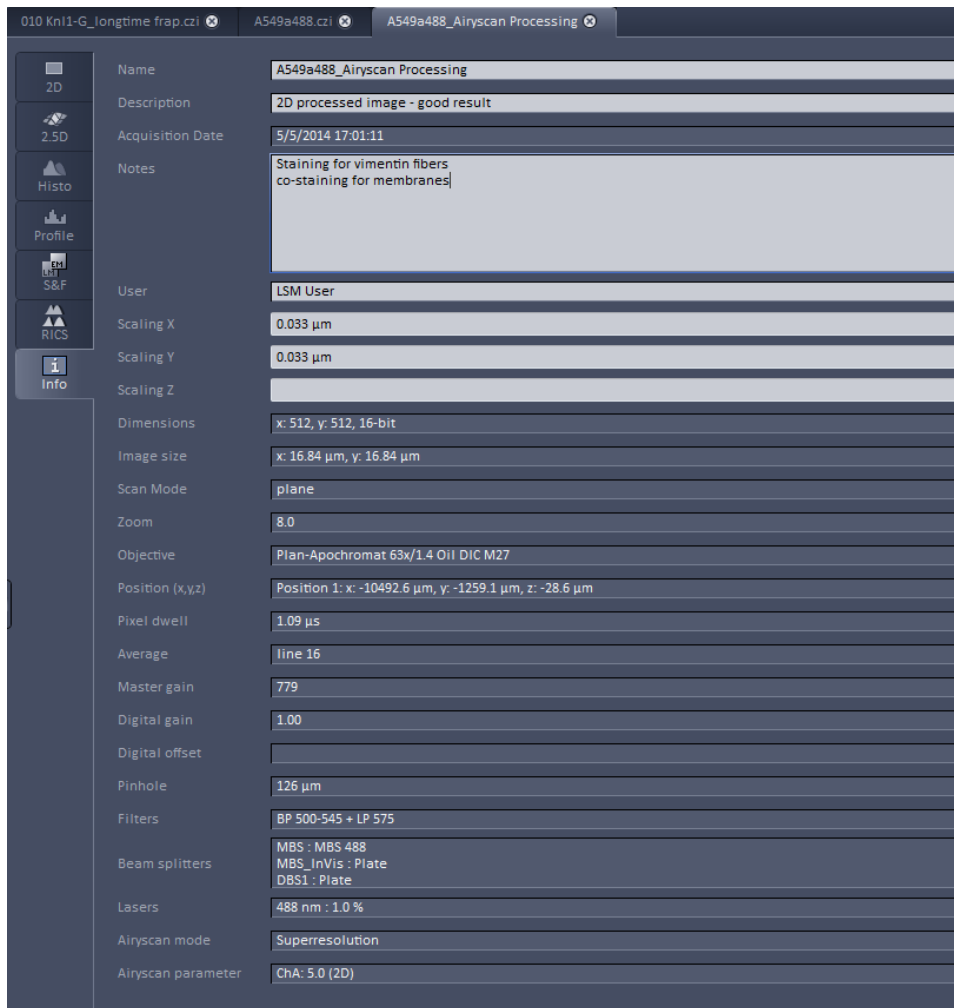
Type in the anisotropy formula considering the G-factor of the system. Choose either Absolute Intensities in case you have to multiply the formula with  $2^n - 1$  to rescale to an n bit image. For example, if the color depth was 8 bit, multiply with  $2^8 - 1 = 256 - 1 = 255$ . Alternatively, choose **Intensity range 0..1**, in which case you do not multiply with an extra factor. Press **Apply** and choose a respective look up table to obtain a false colored anisotropy image.

## 6.21 Information View

The **Information View** is a view type that shows a summary information sheet of all relevant image acquisition parameters. Parts of it can be edited – like, e.g., the Notes field.

The Information View displays:

- File name of the data set
- A brief description of the data set
- A notes field in which the user can note down essential information on the experiment
- The user name of the person who acquired the image
- The pixel scaling in X, Y, Z
- The image dimensions (pixels in x-y-z, channels, bit depth)
- Calibrated image size x-y-z in  $\mu\text{m}$
- The scan mode (e.g. plane, time series)
- Tile scan information
- The zoom factor
- The objective lens
- The position of the individual images in relative values
- The pixel dwell time of the scan
- The average mode used
- The Gain (Master) settings for all channels
- The Digital Gain settings for all channels
- The Digital Offset settings for all channels
- The pinhole sizes
- The filters and beam splitters in the beam path
- The used lasers with the settings of the respective AOTF
- The imaging mode and analysis parameter set for Airyscan



**Fig. 751** Information View of a processed superresolution image

---

## 7 Right Tool Area, Data Management and Storage

### 7.1 General

#### Document Type

Images are stored as files (\*.czi format) in folders just like in any other Windows application.

All information (metadata) will be saved with the .czi file. When exporting .czi files as .lsm files this metadata cannot be completely exported. When exporting .czi files as .lsm files, each z-stack will be saved as an individual .lsm file.

We provide further information about the .czi file format on request. Please contact your ZEISS representative.

In ZEN there are three ways to access your data:

- The File menu
- The ZEN File Browser
- Open Images are accessible in the Right Tool Area

#### ZEN File Browser

The File Browser allows access to image data of variable image formats and permits displaying them in three views:

- Gallery View,
- Table View and
- Form View.

Images can be loaded, copied and deleted within the ZEN File Browser.


The **Reuse** (see section **Dimensions**) function is available in the ZEN Image Browser: Hardware parameters can be loaded without opening the files by clicking the **Reuse** button.

#### Images and Documents

In the Right Tool Area the **Images and Documents** section is displaying the images which are loaded in the system memory. Double clicking brings the image to the front. Files can be saved and deleted/closed on this section.

#### Export

With the **Export** dialog in the **File** menu, the acquired data can be directly exported to various file types.

 In the **Save As** dialog in the **File** menu these formats can also be chosen as file type.

## 7.2 ZEN File Browser

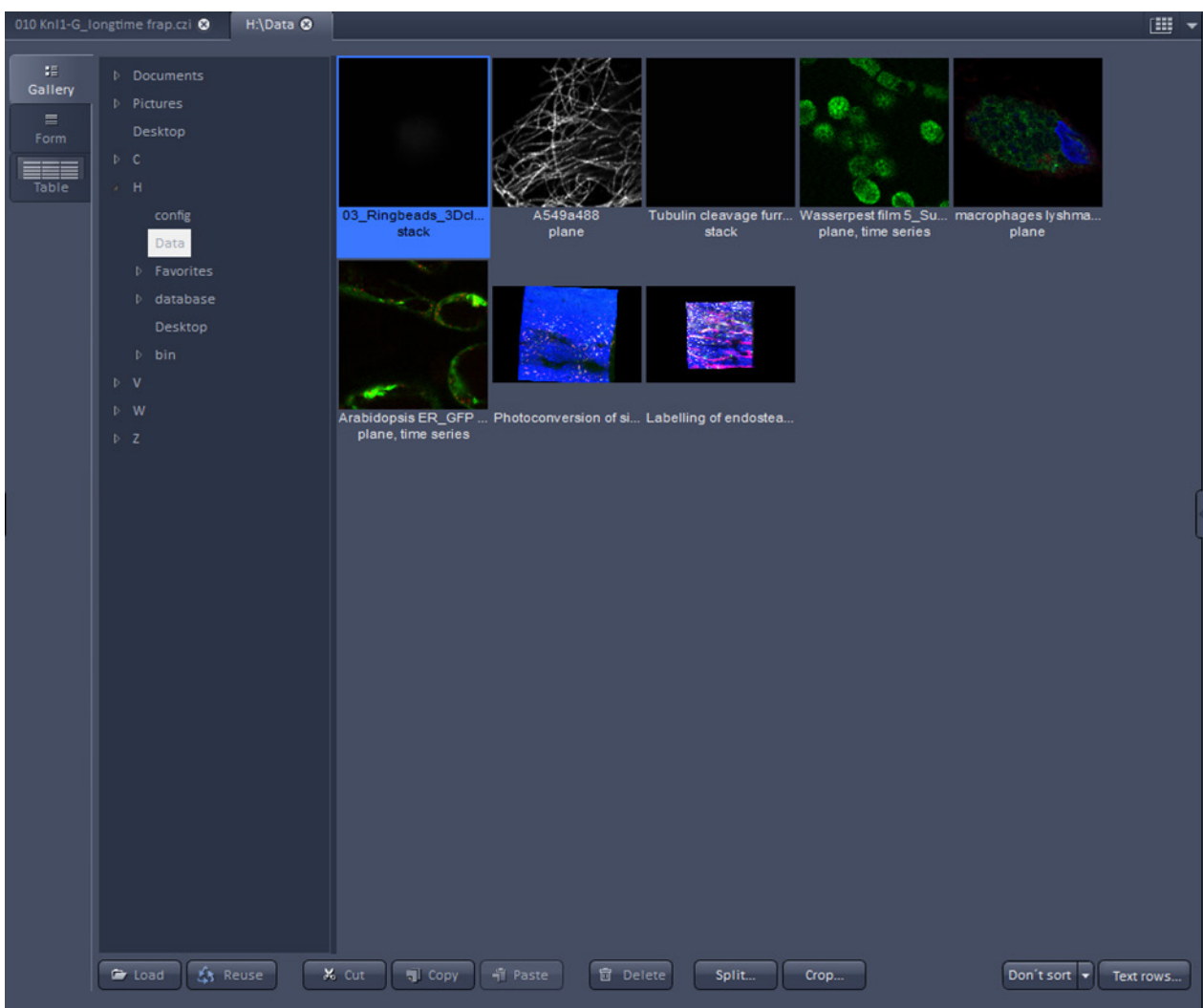
The ZEN File Browser is a versatile tool to access your image data.

- In the menu bar, click on **File** and select the **File Browser ...** item to open the **ZEN File Browser**.

It displays the hard drives and connected network drives available on the computer. Clicking on a folder opens it and lists the image files therein.

The ZEN File Browser can be operated in three views:

- Gallery View,
- Table View and
- Form View.



**Fig. 752** ZEN File Browser

With the use of the button bar underneath the files can be loaded, the settings can be re-used, images can be cut, copied, pasted and deleted.

Pressing the **Reuse** button loads the hardware settings of the .czi image highlighted (blue) in the browser window. You do not have to open the image to apply the Reuse function.

Eventual info messages (Fig. 753) fading in the right hand corner inform about missing hardware if applicable. The message box disappears after ~ 10 seconds.

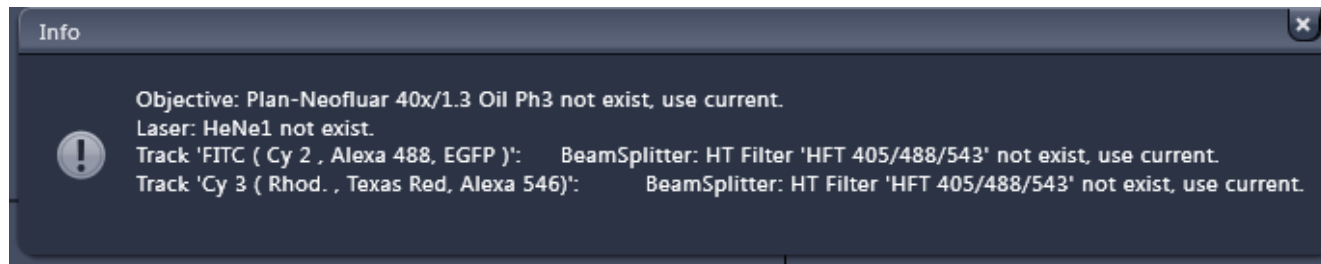


Fig. 753 Info message

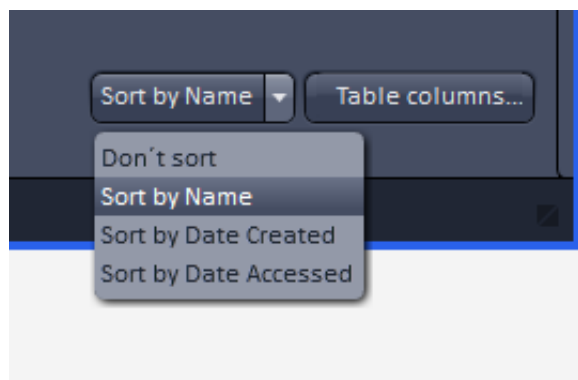


Fig. 754 Sorting drop down menu in the File Browser

The images can be sorted in three different ways, by name, the date the image was created (acquisition date/time) or the date, the images were accessed (Fig. 754).

When in Gallery View mode, images can be split according to their dimensions and stored as separate files. Click **Split...** to open the dialog.

Chose the **Size** of the dimension you want to split up the image.

The check box in the **Separate Files** column activates/deactivates the split process for the individual dimensions (Fig. 755).

Click **Select file name and save...** to save the split up image dimensions as separate .czi or .lsm files.

**Crop...** allows you to save parts of acquired images as new files.

According to the available dimensions it is possible to chose a subset of this dimension with a selectable step size.

For example its possible to save every 2<sup>nd</sup> image of the first 100 images of a time series of 500 images.

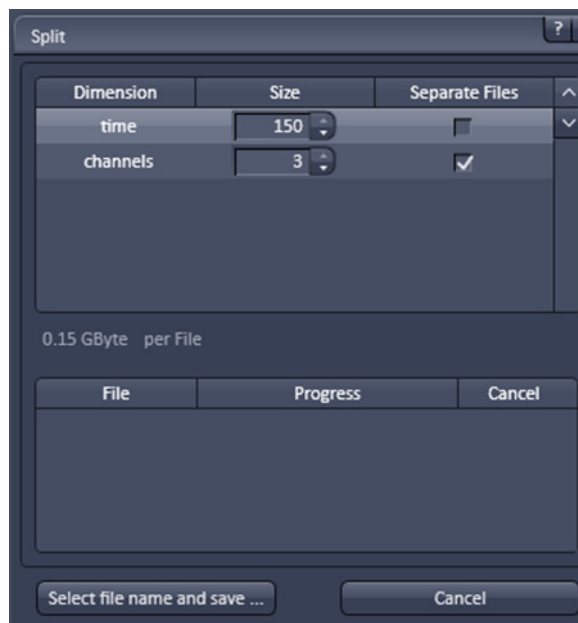
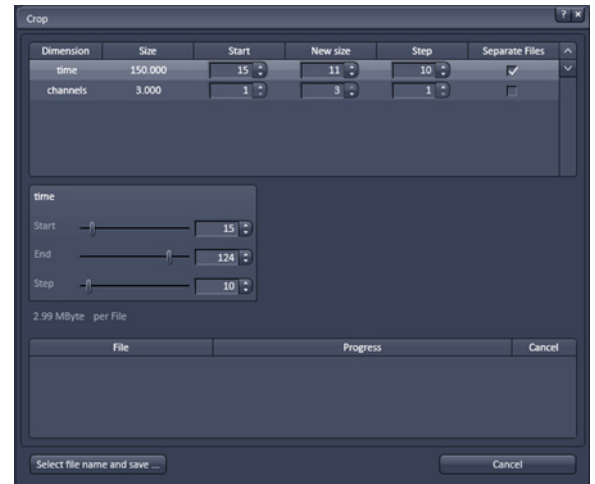


Fig. 755 Split window of the Split function in the File Browser

Within the dialog (Fig. 756) use the editing boxes or the sliders to set the desired values.

The slider box toggles with the highlighted dimension.

Click **Select file name and save...** to save the cropped images as separate .czi or .lsm files.



**Fig. 756** Crop window of the Split function in the File Browser

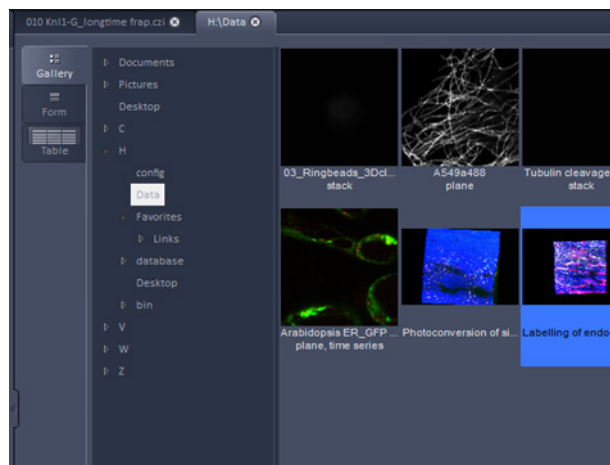


Fig. 757 Gallery view

## 7.2.1 Gallery View of the ZEN File Browser

In the **Gallery View** of the browser the images are displayed as thumbnails. One click selects a single image, press Shift and click to select multiple images. If the CTRL key is pressed, all clicked images are selected.

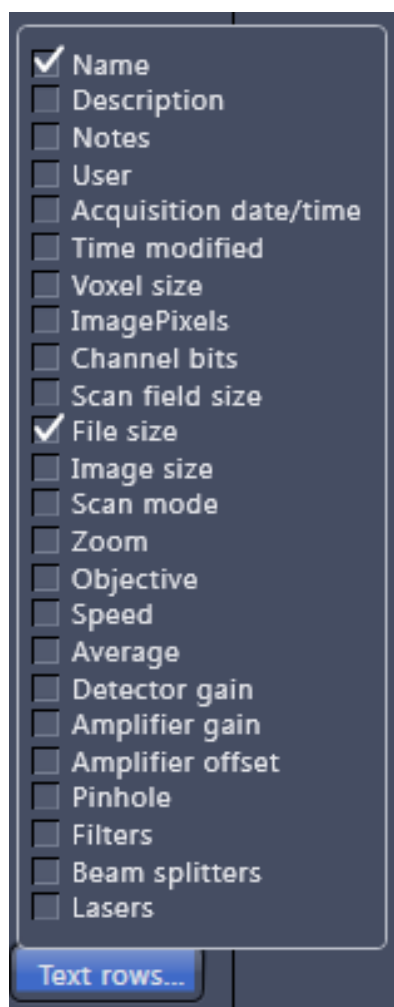


Fig. 758 Image information selection

### Opening Images:

- To open an image, double click on it.
- For opening multiple images at a time, select the desired images and press **Load**.

The information stored in the .czi file format can be displayed underneath the thumbnail. By pressing the **Text rows...** button a choice of information is available (see Fig. 758).

The example below (Fig. 759) shows the use of the display of:

- file name,
- acquisition date,
- file size and
- scan mode.



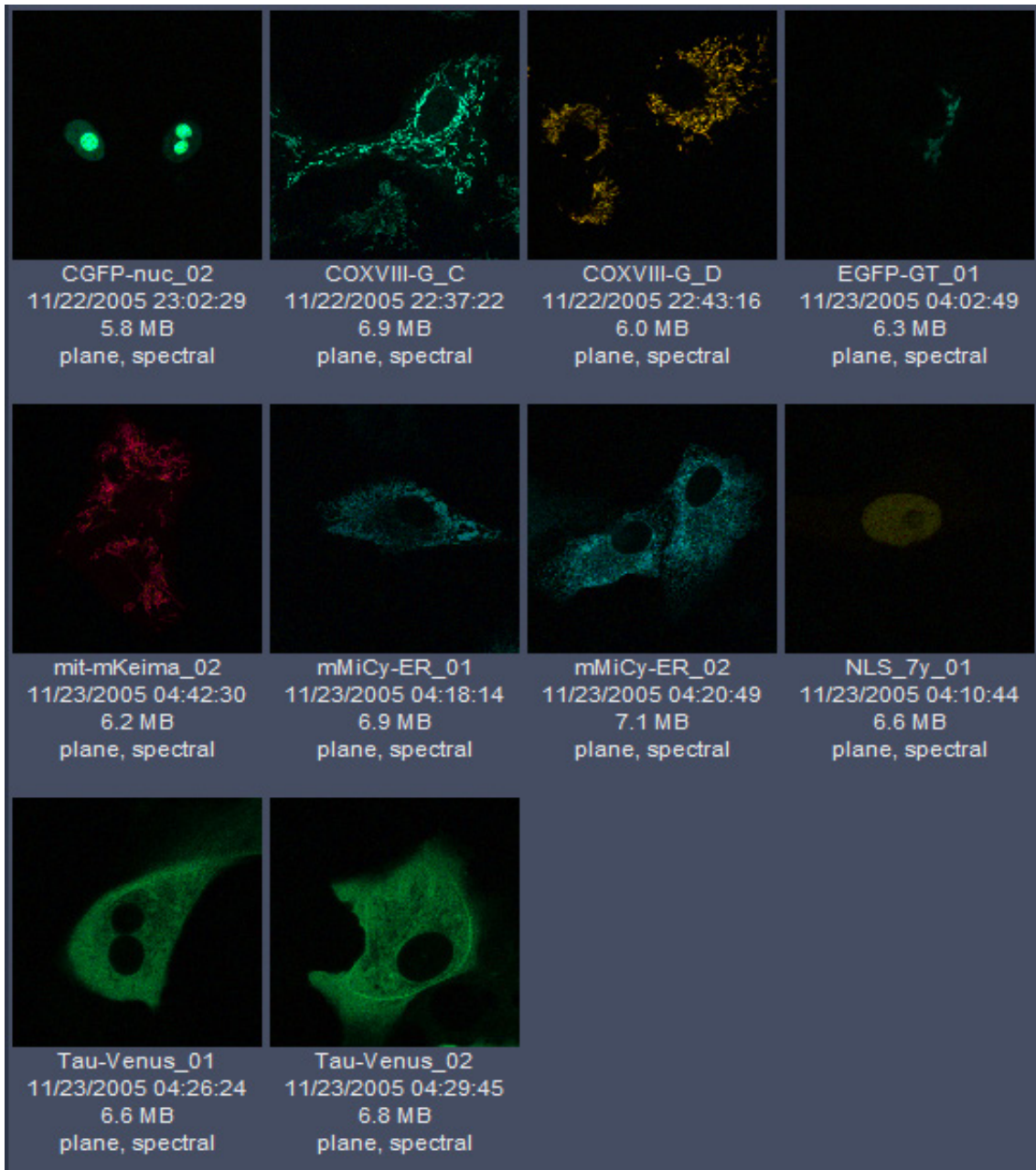



Fig. 759 Images with information

### 7.2.2 Form View of the ZEN File Browser

All images in a given folder can be accessed by using the slider below the Info-Panel or using the stepper on the right side of the slider. The total number of images in a folder is indicated on the right side of the



In the **Form View** of the browser all information available (or entered) in the Info-tab of the image is displayed.

 Note that the upper four fields (Name, Descriptions, Notes and User) are currently not saved. To edit these fields please load the image and edit the form in the info-view of the image. The information in those fields are – however – accessible by copy and paste.

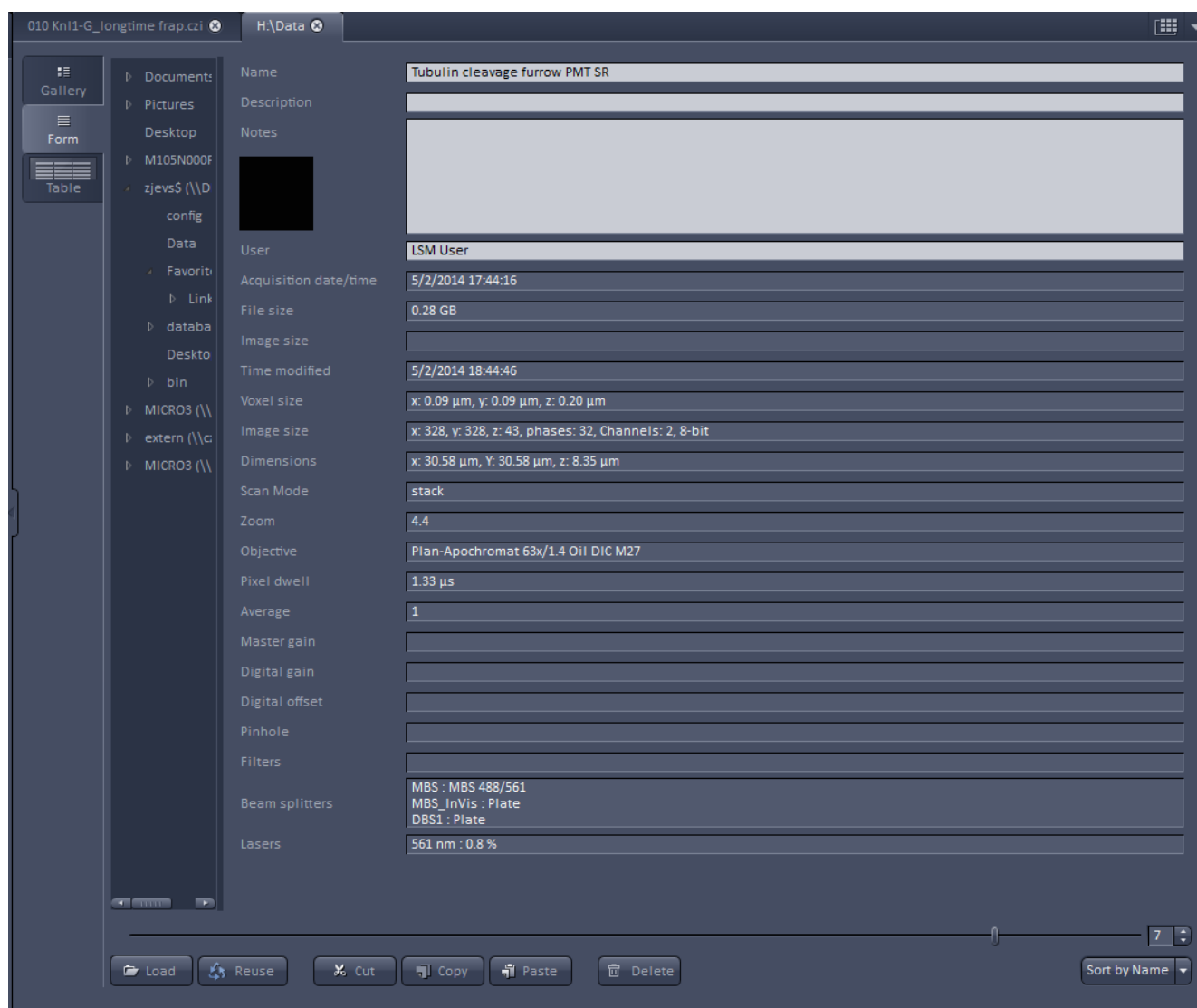


Fig. 760 Form view

### 7.2.3 Table View of the ZEN File Browser

The **Table View** is especially useful in case a lot of files are found in one folder.

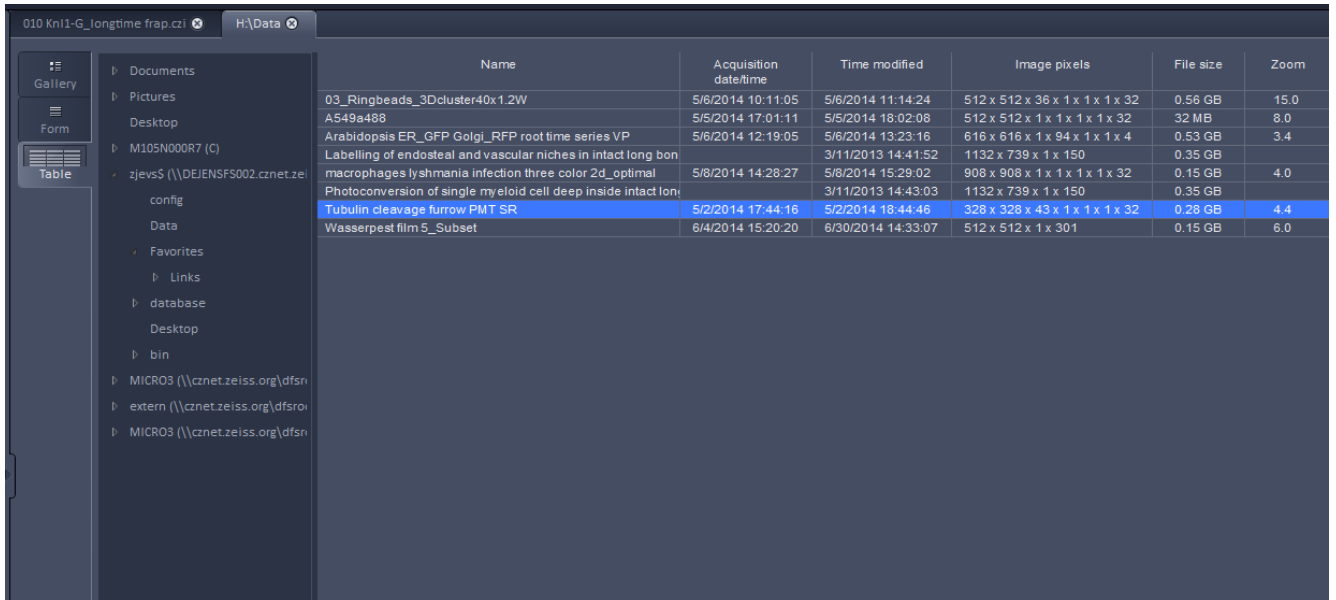


Fig. 761 Table view

The columns displayed in the table are selectable from the Table columns button. The options shown in Fig. 762 are available.

The width of the columns is editable and the order of the columns can be freely shifted by dragging the header of the columns.

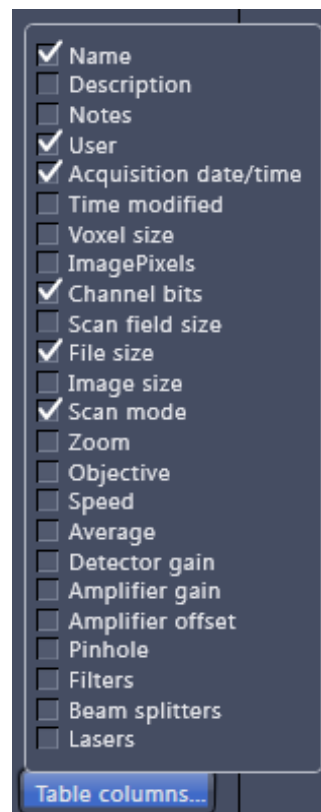


Fig. 762 Table view options

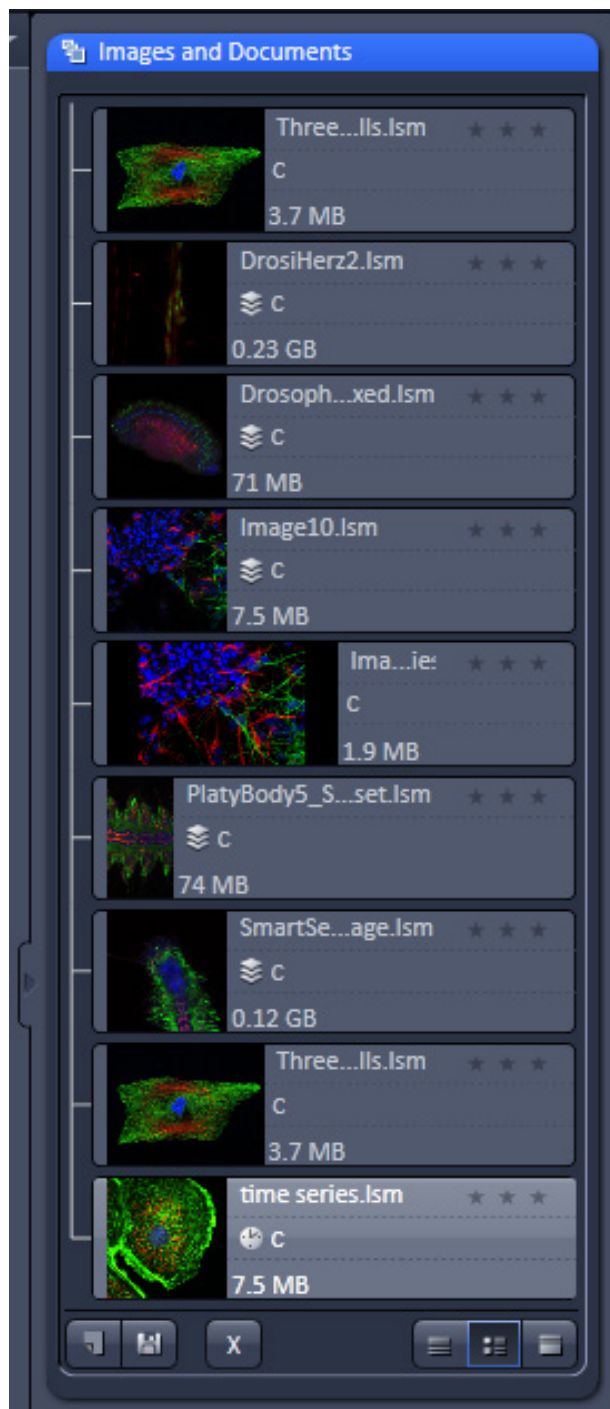











Fig. 763 Images and Documents panel

### 7.3 Images and Documents Panel

The **Images and Documents** panel (Fig. 763) is located in the Right Tool Area of ZEN. It displays all images and data which are open in ZEN. Its purpose is multi-fold:




- All opened images can be brought to the front by double clicking on them which makes the navigation through lots of images easy and fast.
- Basic file handling functions are implemented for fast operation with the acquired images. The images can be saved and closed using the following buttons:
  - 
  - 
  - 
- A new acquisition document can be opened using the  button.
- The  button saves the selected image.
- The  button closes the selected image.

 On already saved images the  button is closing the image, not deleting it. Multiple images can be selected by holding down the CTRL key on the keyboard and clicking on the list entries.

- The whole section can be hidden by clicking on the black triangle at the left side of the  panel.

Once hidden, a click on the right boarder of ZEN lets the **Images and Documents** panel slide back into the application.

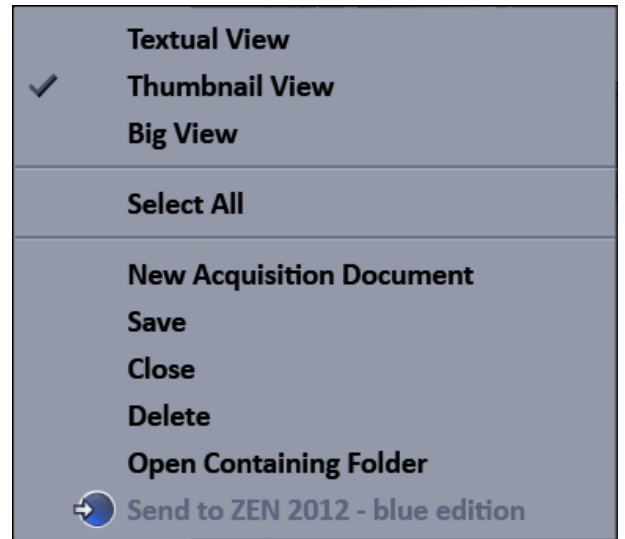
- All files can be displayed in three ways by using the    buttons underneath the section.

-  Textual View
-  Thumbnail View
-  Big View

The default setting is **Thumbnails view** as indicated on the screengrab.





The context menu of the **Images and Documents** section allows the following functions:

- Selecting one of the view options **Textual View**, **Thumbnail View** or **Big View**
- Selecting all opened image files by clicking on **Select All**
- Opening a **New Acquisition Document**
- Saving or closing the selected image files by clicking on **Save** or **Close**
- Clicking **Delete** to delete the selected image file
- Clicking **Open Containing Folder** opens the folder, where the selected image file is saved.
- Clicking **Send to ZEN 2012 – blue edition** sends the currently active document to ZEN blue edition.



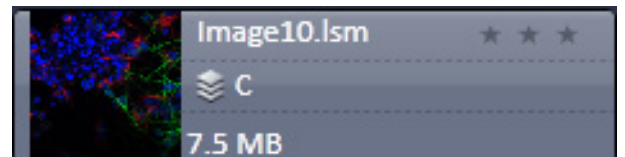
**Fig. 764** Context menu of the Images and Documents section

Regardless of which display type is chosen, the individual images contain the following information:

- File name
- Data type indicated by icons:     like e.g. Stack, Time, Bleach, Lambda or C for multichannel images. These icons are the same as underneath the start button when starting multidimensional experiments (section **Action Buttons**).

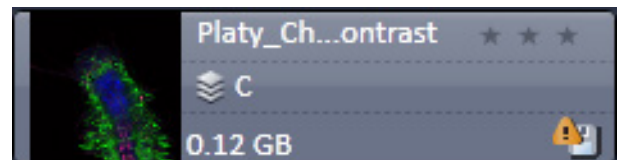
The file size is indicated in MB or GB.

- Example of a 2 Ch. Z-Stack displayed with a small thumbnail in the **Images and Documents** section (Fig. 765).

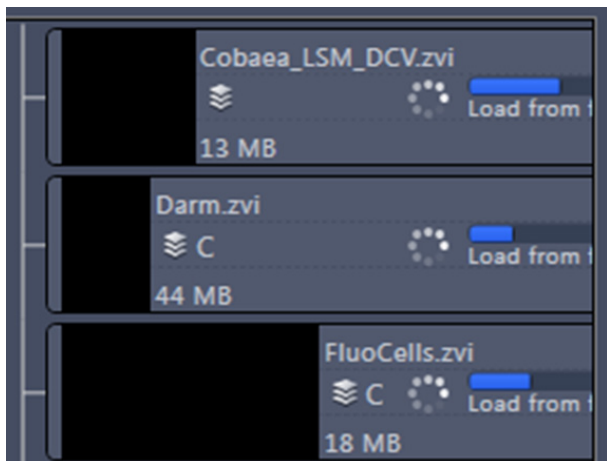


**Fig. 765** 2 Ch. Z-Stack image

- In case the image is not saved or has been processed, a warning symbol is displayed on the right side (Fig. 766).

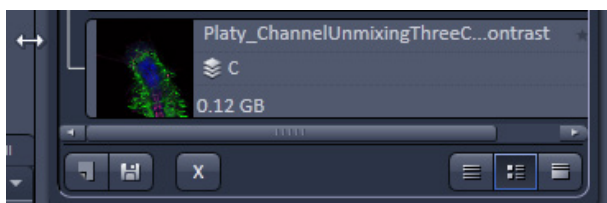


**Fig. 766** Image with warning symbol



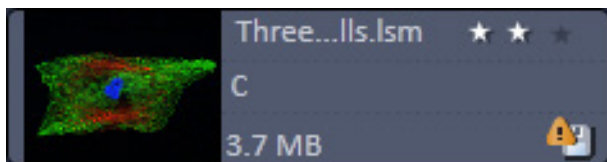
**Fig. 767** Image progress bar

- A progress bar (Fig. 767) is shown for each image facilitating the overview if e.g. many processing function are running at the same time.



**Fig. 768** Enlarging the image view

- In case long filenames are used the whole section can be dragged to the left and thereby enlarged (Fig. 768).




**Fig. 769** Image rating star function

- The stars can be used to rate the pictures. They are activated by clicking on them.

---


## 7.4 Opening of Files via the "Open" Command in the File Menu

- Click on the **File** menu of the menu bar and select **Open** or click on the  icon of the main toolbar.
  - The standard windows open dialog appears.
- Select the desired file and click **Open**.

## 7.5 Save

The **Save** function allows to store an image together with the acquisition parameters (and processing information) to be stored in a .czi file.

Proceed as follows to save an acquired or an edited / processed image:

- Click on the **Save** or **Save As** button in the **File** menu of the menu bar or click on the  icon of the main toolbar.
  - The **Save Image and Parameter As** window appears on the screen.

### Save:

Stores a newly created or changed image. Newly created images must be given a name

### Save As:

Stores a previously stored and called up image under a different name. If images are called up and stored again, the original data and time display will be retained.

- Clicking on either of these Menu Items opens the **Save As** window to create and open an image database.
- Click on the **OK** button in the **Save Image** window.

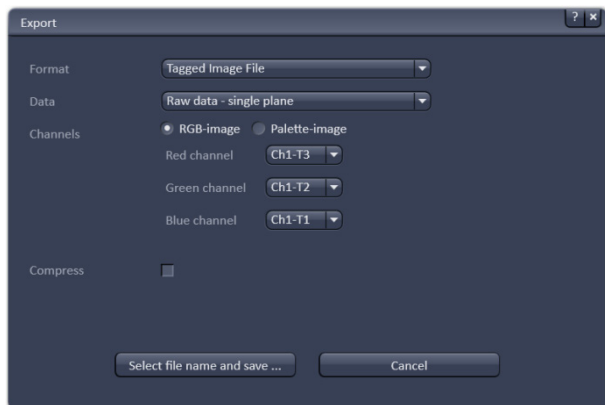


Fig. 770 Export window

## 7.6 Export of Images

The **Export** function allows the export of acquired images and images loaded.

- Select the image to be exported.
- Click on the **Export** menu Item in the **File** menu of the menu bar.
  - This opens the **Export** window (Fig. 770).

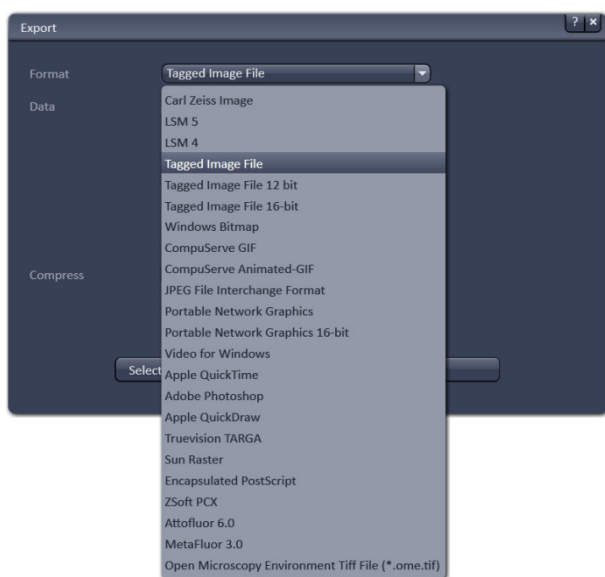


Fig. 771 Format selection

- Under **Format**, select the format to which the image is to be exported to (Fig. 771).

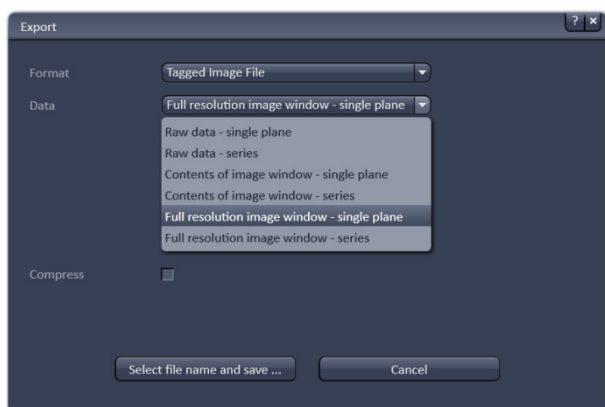


Fig. 772 Data type selection

- Select the data type which the image is to be exported under **Data** (Fig. 772).
- Chose a compression level. For some file formats lossless compression or various other compression levels are available. The degree of losses for the image quality is listed according to the type of compression.
- Click on the **Select file name and save ...** button. The standard Windows File saving dialog appears. Click Save to complete the export process.



When stacks or time series are exported, each frame is stored as an individual image.



**8 Index****2**

2D View ..... 424

**3**

32 channel module light path ..... 183

3D distance measurement..... 445

3D View ..... 449

3D view basic ..... 468

3D VisArtplus

Maximum ..... 455

Mixed ..... 456

Rendering settings ..... 461

Shadow projection ..... 451

Surface ..... 455

Transparency ..... 454

**A**

Acquisition ..... 65, 190

Acquisition mode..... 106

Acquisition mode settings for Airy scan ..... 113

Acquisition parameter

Acquisition mode ..... 101

Channels ..... 115

Focus ..... 126

Focus devices and strategy ..... 127

Regions ..... 138, 151

Shuttle and Find ..... 132

Stage ..... 131

Action buttons ..... 41, 73

Action buttons for FCS..... 249

Activation tab area ..... 253

Adjust ..... 391

Burn in brightness and contrast ..... 391

Channel shift ..... 393

Interpolate brightness and contrast..... 392

Shading correction ..... 394

AF Find focus..... 73

Airyscan ..... 12, 13, 99, 113, 124,

..... 149,173, 297, 408, 437

Airyscan View ..... 437

Airyscanning..... 12

Amplitude ..... 198, 214

Analog display ..... 122

Animation ..... 428

Antibunching ..... 215

Anti-bunching terms..... 201

AOTF dampening..... 417

Aperture control..... 89

Application bar ..... 32

Arrow down button ..... 47

Auto save..... 418

Automatic Component Extraction ..... 499

Automatic dust filter..... 272

Average ..... 108, 110, 304

Averaging selection ..... 103

Axio Examiner control..... 63

**B**

Background ..... 214

Band filter ..... 307

Beam path ..... 178

Big view button..... 49

Black..... 427

Bleaching ..... 150

Blending ..... 380

Brightness ..... 391

Bunching terms ..... 203

**C**

Calibration ..... 317

Camera color adjustment..... 36

Center mode..... 144

Center screen area ..... 45

Channel ..... 116

Channel alignment..... 354

Channel display field ..... 287

Channel settings for Airyscan..... 124

Channel shift..... 393

Channels..... 425

Clipping planes ..... 457

Settings ..... 460

Close button ..... 48

Coincidence ..... 280

Colocalization ..... 472

Color depth selection ..... 103

Color-coded projection..... 301

Configuration..... 66

Confocal imaging..... 10

Constrained iterative ..... 365

Container..... 47

Context menu ..... 44, 46, 47, 275

Continuous..... 74

Contrast..... 391

Control elements, imaging setup ..... 91

Coordinate label..... 432

Copy..... 382

Copy channel ..... 382

Delete image ..... 383

Duplication ..... 382

Subset.....	382, 383	Filter.....	305
Copy channel.....	382	Filter cube selection.....	86
Correction.....	148	Filters.....	407
Correlation.....	195, 224, 319	Find focus.....	73
Correlation function.....	196	First/Last mode.....	142
Correlation G.....	275	Fit.....	192, 281
Correlator.....	224	Fit action buttons.....	289
Count rate.....	225, 254	Fit diagram.....	281
Count rate trace.....	274	Fit table.....	285
Counting format.....	123	Flow.....	220
Crop.....	426	Fluorescence Correlation Spectroscopy.....	11
Cross hair.....	239	Flying mode.....	461
Cross-correlation function		Focus.....	231
Definition.....	197	Focus control.....	88
Current position.....	239	Focus speed.....	406
<b>D</b>		Format selection.....	102
Data.....	413	Formula.....	223
Data files.....	267	Fourier transform.....	346
Deconvolution.....	364	Frame.....	106, 107, 110
Delete image.....	383	FRAP.....	486
Depth coding.....	455	FRET view.....	501
Detrend.....	384	Fusion.....	380
Diffusion terms.....	207	Fusion Subset in X.....	362
Digital gain.....	172	Fusion Subset in Z.....	380
Digital offset.....	172	<b>G</b>	
Discrete fourier transform fusion.....	361	GaAsP detectors.....	121
Dual side fusion.....	361	Gamma.....	427
Dual Side Fusion		Gradient filter.....	307
Fusion Subset in X.....	362	<b>H</b>	
Duplication.....	382	HAL control.....	88
Dust filter.....	226	Hardware control tools.....	50
<b>E</b>		HDR-imaging.....	104, 321
End.....	161	Histogram.....	469
Equation calibration.....	318	<b>I</b>	
Exiting ZEN.....	23	ICS.....	384
Expand slider.....	48	Detrend.....	384
Experiment Designer.....	80	ICS correlation.....	386
Experimental PSF.....	341	Map filter.....	387
Export of images.....	546	NandB Analysis.....	388
Expose mode.....	46	Remove structure.....	385
Exposure.....	73	ICS correlation.....	386
<b>F</b>		Image	
Fast iterative.....	365	Export of an.....	546
FCS correlation diagram.....	268	Saving an.....	545
FCS diagram.....	260	Image calculator.....	302
FCS measurements.....	260	Operators.....	303
FCS options.....	413	Image control area.....	46
FCS tab.....	175	Image information.....	49
File.....	34	Image optimization.....	169

Image tabs .....	46	Look Up Table (LUT) .....	117
Image view controls .....	46	Lowering objective .....	166
Image view tabs .....	46	<b>M</b>	
Images and documents panel .....	542	Main tool tabs .....	41
Imaging configuration .....	42	Main toolbar .....	38
Imaging Setup .....	84	Maintain .....	35, 395, 407, 408
Imaging Setup tool .....	91	Administrator .....	36
Incubation tool .....	64	Objective .....	402
Information .....	292	Pinhole adjustment .....	396, 399
Information on experiment .....	167, 248	Spline .....	35
Intensity based alignment .....	372	Test grid .....	36
Interactive Registration .....	375	Map filter .....	387
Interval time .....	155	Marker .....	157, 159
Ion concentration .....	313	Maximum Fusion .....	362
<b>K</b>		Maximum intensity projection .....	300
Kinetic .....	486	Mean Fusion .....	362
<b>L</b>		Mean of ROI .....	482
Lambda coded .....	492	Measure .....	417
Landmark alignment .....	369	Measurement .....	263
Large thumbnail view .....	47	Median filter .....	305
Laser .....	77, 177, 184	Menu bar .....	32
Laser control .....	90	Menu overview .....	33
Laser lines .....	184	Method tool .....	250
Laser Scanning Microscopy .....	10	Microscope Control tool .....	53, 60
Laser shutter filter wheel .....	418	Model .....	194, 213
Left tool area .....	41, 50	Model equations .....	196, 197
Light path .....	177, 179, 181, 183	Model field .....	287
Lightsheet processing .....	361	Modify series .....	320
Blending .....	380	Moving average .....	304
Deconvolution .....	364	Multichannel unmixing .....	312
Discrete fourier transform fusion .....	361	Multidimensional acquisition .....	75
Dual side fusion .....	361	Auto Save .....	168
Fusion .....	380	Bleaching .....	150
Fusion Subset in X .....	370, 373, 377	Information on experiment .....	167
Fusion Subset in Z .....	380	Positions .....	162
Input settings .....	379	Tile scan .....	152
Intensity based alignment .....	372	Time series .....	155
Interactive Registration .....	375	Z-Stack .....	141
Landmark alignment .....	369	Multidimensional acquisition tools	
Maximum Fusion .....	362	Information on experiment .....	248
Mean Fusion .....	362	Positions .....	238
Multiview processing .....	364	Time series .....	236
Online multiview processing .....	381	Multidimensional image acquisition .....	43
Pre-Registration .....	372	Multiple columns layout .....	43
Registration .....	368, 372	Multiple positions .....	243
Registration options .....	368	Multiple tracks .....	94
Use registration from file .....	375	Multiview processing .....	364
Line .....	106	<b>N</b>	
Linear unmixing .....	308	NandB Analysis .....	388
Live .....	73	Navigation tools	
Locate tab .....	51	Focus .....	231

Sample carrier.....	229	HDR-imaging.....	321
Stage .....	228	ICS.....	384
NDD light path.....	181	Image calculator.....	302
Nearest neighbour.....	364	Ion concentration .....	313
New image document button .....	48	Lightsheet processing .....	361
<b>O</b>		Linear unmixing.....	308
Objective.....	402	Maximum intensity projection .....	300
Objective selection .....	86, 101	Modify series.....	320
Offline calibration.....	315	PALM.....	326
Offset .....	213	Particle tracking.....	339
Offset values .....	166	SIM.....	345
Online multiview processing .....	381	Stitch .....	325
Online ratio.....	316	Structured illumination .....	345
Optical diagram.....	13	Profile.....	476
Options.....	409	Pulse distance histogram .....	277
Options tools		<b>R</b>	
Correlation tab .....	271	Range indicator.....	425
Table tab .....	273	Ratio channels .....	120
Ortho		Ratio imaging .....	90
Distance .....	445	Ratiometric dyes .....	316
Select .....	444	Ratiometric dyes - Calibration .....	317
Overview image .....	154, 167	Ratiometric dyes - Equation calibration .....	318
<b>P</b>		Ratiometric dyes - Online ratio.....	316
PALM.....	326	Raw data formats.....	414
Convert to image.....	327	Reference spectra.....	312
Import PALM molecules .....	328	Reflected-light observation .....	57, 266
PALM.....	330	Registration .....	368, 372
Remove PALM outliers .....	338	Registration options .....	368
Parfocal correction .....	406	Regularized inverse .....	364
Particle tracking.....	339	Reload .....	272
PCH.....	222, 226	Remove structure .....	385
Photon count images.....	121	Reuse .....	272, 426
Photon count imaging.....	121	RICS .....	508
Photon counting histogram .....	277	Right tool area .....	48
Piezo.....	146	Rotation .....	217
Pinhole adjustment.....	186, 396, 399	<b>S</b>	
Polarization imaging.....	527	Sample carrier.....	163, 229, 240
Position list.....	162, 243	Save button .....	48
Positions .....	162, 238	Save status icon .....	49
Pre-Registration.....	372	Saving .....	278
Print.....	290	Saving an image .....	545
Processing.....	293	Scan area.....	105
Adjust .....	391	Scan mode.....	102
Airyscan Processing.....	297	Scatter diagram .....	474
Average.....	304	Sectioning.....	147
Channel alignment .....	354	Separate view controls .....	47
Color-coded projection .....	301	Series.....	463
Copy .....	382	Set Exposure .....	171
Correlation .....	319	Settings .....	466
Experimental PSF .....	341	Setup Imaging with Airyscan detector.....	99
Filter.....	305	Setup tools	

Acquisition.....	190	Time series .....	155, 236
Correlator .....	224	TIRF-Filtered .....	352
Fit.....	192	Titration calibration .....	318
Imaging Setup.....	84	Tool .....	43
Laser.....	177	Tool groups.....	41
Light path .....	177	Tool window.....	42, 43
Shading correction.....	394	Tools.....	42
Shared view controls.....	47	Track .....	116
Sharpen filter.....	306	Translation .....	219
Show all function.....	43	Transmission .....	170
Shutdown .....	18	Transmitted-light observation .....	57, 266
Shutdown procedure .....	23	Triplet .....	216
Shuttle and Find tool .....	132	Turning power off .....	25
Shuttle and Find View .....	479		
Single position.....	242	<b>U</b>	
Single wavelength dyes.....	315	Undock function .....	43
Small thumbnail view.....	47	Unmixing view .....	494
Smart setup.....	42, 68	Use registration form file .....	375
Smooth filter .....	306		
Snap .....	74, 259	<b>V</b>	
Spline.....	35	View control	
Spot .....	106	Dimensions.....	424
Spot, creation of a .....	112	Display .....	427
Stage .....	228	Graphics.....	429
Stage control.....	87	Player .....	428
Start.....	159	View option tab Airyscan.....	439
Start experiment.....	76, 259	View option tab Dimensions .....	437
Starting ZEN .....	20	View option tab Display.....	438
Startup.....	18	View type	
State display box.....	289	2.5 D.....	447
Statistical confidence .....	311	Cut .....	446
Status bar.....	40	Gallery.....	436
Step .....	147	Ortho .....	443
Stitch .....	325	Preview .....	432
Stretched exponential .....	221	Split.....	433
Structured illumination.....	345		
Fourier transform .....	346	<b>W</b>	
Structured illumination .....	347	Weighted unmixing.....	311
TIRF-Filtered .....	352	White.....	427
Subset.....	382, 383	Workspace configuration.....	38
System options .....	409	Workspace zoom .....	32
FCS.....	413		
Hardware.....	411	<b>X</b>	
Image display.....	412	X-Cite control.....	89
Load configurations .....	410	X-Y-Z scan .....	256
Reuse .....	410		
System startup.....	18	<b>Z</b>	
		ZEN File Browser.....	34, 535
<b>T</b>		Form view.....	540
Text view.....	47	Gallery view.....	538
Textual view button .....	48	Table view .....	541
Thumbnail view button .....	48		
Tile scan .....	152		

---

Zoom function .....	275, 284	Z-Stack .....	141
Z-Piezo.....	146	Z-Stack settings for Airyscan .....	149

# CHAPTER 2      MACROS AND VISUAL BASIC

## CONTENTS

		Page
<b>1</b>	<b>VBA Version.....</b>	<b>3</b>
<b>2</b>	<b>Macros .....</b>	<b>3</b>
2.1	Macro Language .....	3
2.2	Macro Control.....	4
2.2.1	Edit Macro Function .....	4
2.2.2	Assign Macro to the Macro list.....	7
2.2.3	Editing and Debugging of Macros.....	8
2.3	Overview of Available Macros .....	9
2.4	Sample Macros.....	10
2.5	ExcitationFingerprinting .....	11
2.6	ConcatenateImages.....	14
<b>3</b>	<b>Visual Macro Editor.....</b>	<b>15</b>
3.1	Open / Close the Visual Macro Editor Window .....	15
3.2	Function Description.....	16
3.3	Editing a Macro.....	23
<b>4</b>	<b>VBA Programming for LSM .....</b>	<b>26</b>
4.1	VBA Programming.....	26
4.2	Programming for LSM: Starting points.....	26
4.3	Object browser.....	27
4.4	COM interface.....	28
4.5	Glossary .....	28
4.6	Programming with the Lsm5Vba interface.....	28
4.7	Programming with the VBA-GUI interface .....	30
4.7.1	Introduction .....	30
4.7.2	Structure of a VBA-GUI command.....	31
4.7.3	Recording a macro .....	31
4.7.4	Selecting and managing image documents.....	32
4.7.5	Technical note.....	32

---

4.8	Example Macros.....	33
4.8.1	Access to images.....	33
4.8.2	Backup recording settings .....	33
4.8.3	Event handling .....	33
4.8.4	Export, Save and Load .....	33
4.8.5	VBA-GUI API .....	34



## 1 VBA Version

Both versions of VBA (Visual Basic for Applications) – version 6.4 (32 bit) and version 7.1 (64 bit) – are available.

Version 6.4 is registered by default to ensure compatibility to existing macros.

By registering version 7.1 the 64 bit processing will be supported. Other DLLs will be registered in this case. Old macros have to be converted to the new format.

The registered VBA version will be shown in the **Help/About** dialog.

## 2 Macros

The macro function permits the recording, running and editing of command sequences and their allocation to buttons in the **Macro** menu. Macros can be set up in two different ways: The Visual Macro Editor or alternatively they can be programmed in Visual Basic directly.

- In the **Menu** bar (see Fig. 1), click on **Macro**.

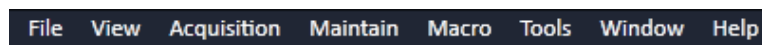


Fig. 1 Menu bar

- This displays the **Macro** menu (see Fig. 2).
- The Macro list is bipartite: **Macro** – editing and recording of macros; assign macros to list
- **Visual Macro Editor** – edit automatic workflows with pre-defined modules

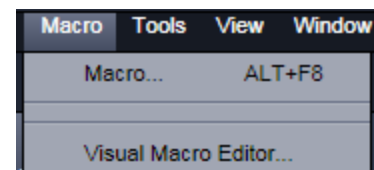


Fig. 2 Macro menu

Selecting **Macro** opens a dialogue for editing and recording Macros based on VBA programming in the **Macro Control** window (see Fig. 3). VBA programming is described in Section 4, page 26.


Using the **Visual Macro Editor** button (optional) allows to create automated work flows using the arrangement of symbols which depict the single steps within a work flow. See **Visual Macro Editor**, page 15 for further details.

### 2.1 Macro Language

"Visual Basic for Applications", called VBA in the following, is used as the Macro language. This language is well known and widely used as Macro language in the "Microsoft Word for Windows" and "Microsoft Excel for Windows" products. Experience with "Microsoft Visual Basic" would also be beneficial for macro-programming ZEN.

An Integrated Development Environment (IDE), the "Microsoft Visual Basic Editor", is available for editing and debugging of macros. The IDE includes an "online help" with a detailed description of the VBA language.

Macros are stored in project files. One project file can include several macros.

 The VBA functionality described in this paragraph refers to VBA as implemented in the ZEISS LSM software 4.2. With the introduction of ZEN, the range of functions is and will be extended, while VBA can still be used with the functions described below. The extension of functionality applies mostly to display and access of image data. If you need assistance or further information please contact your local ZEISS LSM specialist.

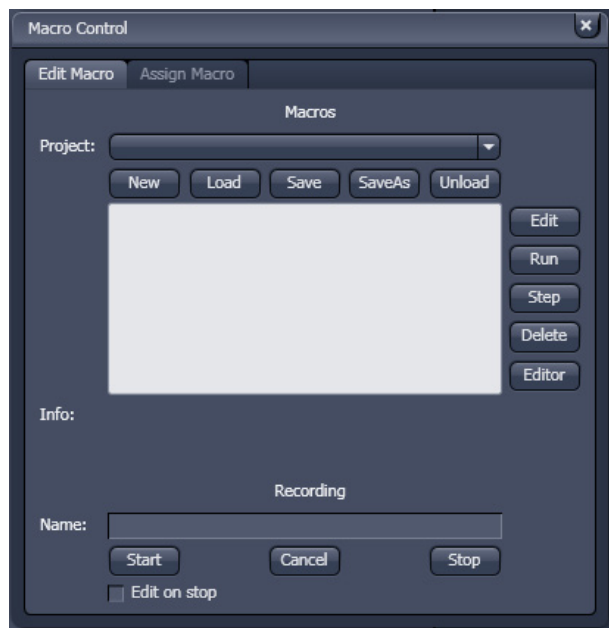


Fig. 3 Macro Control Window

### (1) Macro panel

- New** button: Creates a new project.
- Load** button: Opens an existing project.
- Save** button: Stores the project on the hard disk.
- Save As** button: Stores an existing project under a new name.
- Unload** button: Removes the selected macro from the **Macros** list.
- Edit** button: Allows macros to be edited and debugged. The editor (**Microsoft Visual Basic**) is automatically located at the beginning of the relevant macro.
- Run** button: Runs a macro.
- Step** button: Opens the editor for line-by-line editing / debugging.
- Delete** button: Deletes the selected macro.
- Editor** button: Opens the editor. Displays the processed area of the macro edited last.

## 2.2 Macro Control

To open the Macro Control, choose **Macro** from the **Macro** List in the main **Menu Bar**.

This opens the **Macro Control** window.

### 2.2.1 Edit Macro Function

This function allows you to manage project data. Macros can be recorded, stored, performed, edited and, if required, deleted.

Press the **Edit Macro** tab to switch to the **Macro** and **Recording** panels (see Fig. 3).

Macros are stored and managed in project files (\*.lvb). Before you can record or edit a macro, you have to create a project as follows:

- Press the **New** button to create a project file (see Fig. 4).
  - A new project is created and displayed in the **Project** selection box. The project name is automatically default (LSM followed by a number), but can be edited afterwards.

To activate an existing project, proceed as follows:

- Press the **Load** button.
  - The **Open** window will be opened (see Fig. 5).
- Select the relevant project file (data extension: **\*.lvb**) from the **Macros** list box. Click on the **Open** button.
  - The project file will be opened and the macros contained in it are displayed in the **Project** selection box of the **Macro Control** window. You can use the pull down menu to load any listed Macro.

Recorded macros are stored in main memory first. Before the macros can be assigned to the list in the **Macro** submenu, the project must be stored on the hard disk.

- Press the **Save** button under the project name in the **Macro Control** window and determine the file name in the **Project** selection box, if required (see Fig. 6).

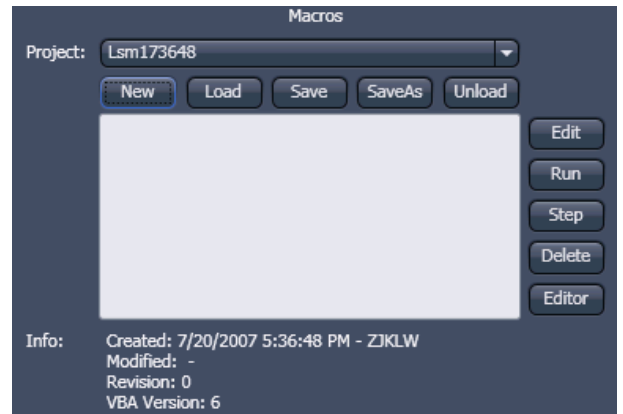


Fig. 4 Macro panel with new Macro assigned

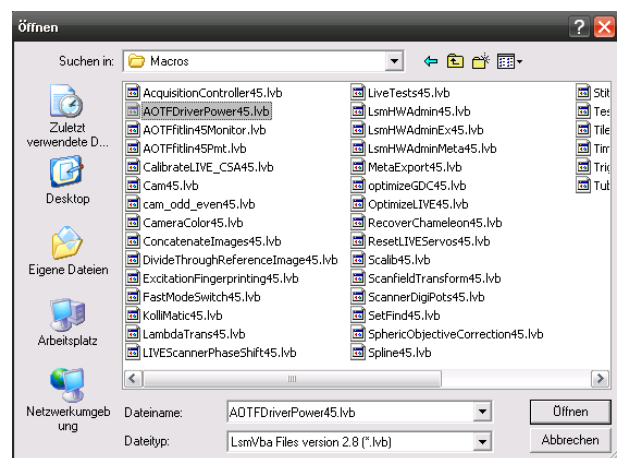


Fig. 5 Open window



Fig. 6 Macro panel with existing Macro assigned

## (2) Recording panel

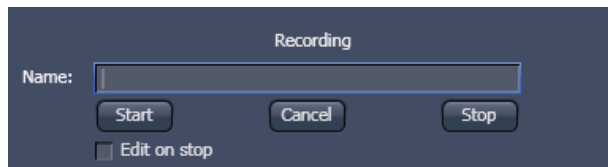
Before recording a command sequence, you can enter the name for the macro to be created in the **Name** input box of the **Recording** panel.

**Start** button: Starts recording.

**Cancel** button: Cancels the recording procedure.

**Stop** button: Stops recording.

**Edit On Stop**: On stopping the recording procedure, the macro editor is automatically opened at the relevant position.



**Fig. 7** Recording section


### Proceed as follows to record a macro:

- Enter a name for the macro to be created under **Name** in the **Recording** panel (see Fig. 7).
- Click on the **Start** button to start recording the macro.

- Then perform the operations to be stored, e.g.:
  - Click on the LSM **Auto Exposure** action button. A find scan will be performed.
  - Click on the LSM **New** action button. A new **Image Display** window will be opened.
  - Click on the LSM **Snap** action button. A scan will be performed.
- Then click on the **Stop** button to end the recording (**Cancel** enables you to cancel recording).
  - If recording was successful, the entered **Name** will then also be available in the **Macros** list box of the **Macro** panel. The new macro is automatically assigned to the current project. It is possible to assign as many macros as required to a project.
- Click on the **Save** button to store the new macro.

### Proceed as follows to run a macro:

- Select the required macro from the **Project** list box of the **Macros** panel.
- Click on the **Run** button to start performing the macro.

 Provided that a macro is linked to a list in the **Macro** section of the **Menu Bar**, you only need to click on its name to perform it.

### Proceed as follows to delete a macro:

- Select the required macro from the **Project** list box of the **Macros** panel.
- Click on the **Delete** button. The macro will be removed from the list.

**Proceed as follows to edit a macro:**

- Select the required macro from the **Project** list box of the **Macros** panel.
- Click on the **Edit** button. The Microsoft Visual Basic editing window will be opened.
- Make the required changes.

**2.2.2 Assign Macro to the Macro list**

This function permits stored macros to be linked to the assigned Macros list in **Macro** of the **Menu Bar**.

- Press the **Assign Macro** tab to switch to the **Assign Macro** panel (see Fig. 8).

**Define Buttons panel**

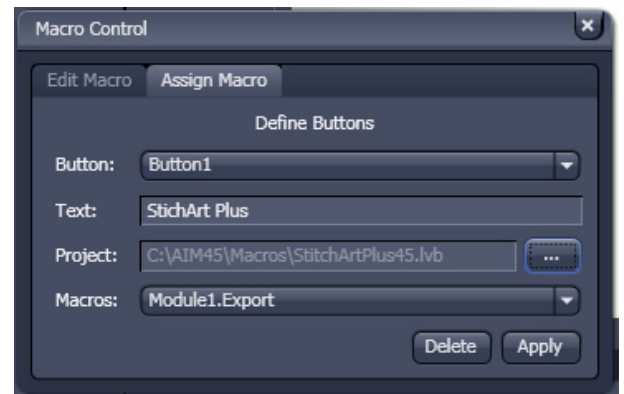
Proceed as follows to link a macro to the **Macro** list:

- Select the button number corresponding to the position in the list from the **Button** selection box.
- Enter the button labelling in the **Text** editing box.
- Select the name of the project file from the **Project** box using the "... " button.
- Select the macro name from the **Macros** box.
- Press the **Apply** button to assign the relevant macro to the specified list position in the **Macro** toolbar.

**Delete a macro from the Macro list**

Proceed as follows to delete a link from the **Macro** list position:

- Select the button number from the **Button** selection box.
- Press the **Delete** button to delete the list entry.












**Fig. 8 Macro Control window – Assign Macro**

### 2.2.3 Editing and Debugging of Macros

The **Edit** in the **Edit Macro** panel button activates IDE (Integrated Development Environment), which allows macros to be edited and debugged. Under the **Help - Microsoft Visual Basics Help** menu item, IDE contains detailed "online" help on its operation and on the VBA macro language. Therefore, only a few hints are provided in the following:

You should activate the required toolbars. We would recommend you to activate the **Debug** toolbar via the **View - Toolbars - Debug** menu item.

The following buttons in the toolbar can help you when debugging macros:

-  Starts running the command lines.
-  Stops running the command lines.
-  Interrupts processing of the command lines (pause).
-  Sets a breakpoint in the line with the text cursor.
-  Processes a command line and steps into subprocedures.
-  Processes a command line and steps over subprocedures.
-  Exits the subprocedure (step out).
-  Displays the value of the marked expression (Watch). If nothing is marked, the value of the variable above the text cursor is displayed.
-  Activates the Watch window in which values of variables and expressions can be displayed. For this, text is marked in the code window and dragged into the Watch window. Variables can be modified in the Watch window.

In the left-hand edge of the code window you will find an arrow beside the current command line. A new current command line can be determined by moving the arrow via the mouse. This makes it possible to skip command lines or to process command lines several times.


## 2.3 Overview of Available Macros

Documentation files (\*.rtf, \*.doc) of advanced macros are located in the macro directory. Additional Macros for Service are listed in a separate folder.

Name	Description
CameraColor60.lvb (also Button in Maintain)	Color balance of Axiocam HRC
ConcatenateImages70.lvb	Enables the combination of all kinds of images irregardless of the size and data depth to be presented in a time series. Imported images can also be included. Type of concatenation (fitted to the smallest frame or ROI, fixed size or fitted to the largest frame) can be defined by the user.
ExcitationFingerprinting60.lvb	Automated generation of excitation lambda stacks for generating excitation spectra which can be used for linear unmixing to separate overlapping dyes. Any detector can be used, also NDDs. Description as guide tour on the installation CD-ROM or DVD.
FileExportZEN	For exporting files into different image formats in batch processing mode. A detailed description is provided in the macro folder as separate pdf file.
GDDReset.lvb	Enables or disables the use of the factory set GDD values. Resets the GDD settings to factory values if other values have been stored over time.
LsmHWAdmin60.lvb (also Button in Maintain)	Direct service hardware access (password protected)
ModifySeriesZEN.lvb	Modifies Z-Stacks and Time Stacks like Rotation of the stacks, being mirrored, Conversion of time stacks into Z-Stacks and vice versa; A more detailed description is available within the macro folder as separate pdf file.
Spline60.lvb	Aligns the actual scanner movement to the graphical line drawn in the image to mark the spline scan.
TileScanRotation60.lvb	A potential tilt of the stage leads to incorrect alignment of tiles. This can be calibrated using a grid sample (or the calibration objective) and the calibration function of the macro. The value is taken over by ZEN for the Tile Scan tool.
RecoverChameleon60.lvb	In case the laser is trying to mode lock for some time and does not get anywhere, the macro helps resetting the laser into mode lock.
TestGrid60.lvb	Projects a test Grid as graphics overlay into the open image document (for Service only).
RecoveryChameleon.lvb	Imitates recovery of chameleon NLO laser in case the laser is falling into CW lasing and does not get to mode lock anymore.

---


Name	Description
SphericObjectiveCorrection60.lvb	Calibrates the spheric component of objective error by automatic acquisition of a Z-Stack on a flat surface and a spherical fit of the topographic data.
TestGrid60.lvb	Projects a testgrid into the image window (password protected).
TileScanRotation60.lvb	Defines rotation angle of scanners during tile scan.

 During installation, default macros will be installed in **ZEN\Macros\**. Self generated Macros can be saved in any folder.  
In case of a new installation, old macros will be stored in **ZEN\Macros\BackupMacros** or **ZEN\Backup\**, to avoid problems with identical names of existing and new macros.

## 2.4 Sample Macros

The ZEN software package includes a set of basic macros free of charge. Many of these can be used as samples for new macro development.

In the following paragraphs you find a short description of some representative and common macros. Please contact your local LSM specialist for more detailed and extensive information.

 Please check the **C:\ZEN\Macros** folder on your system for separate documentation in the more extensive macros in .pdf format.



---

## 2.5 ExcitationFingerprinting

With tunable multiphoton lasers (except OPO devices) it is possible to acquire Excitation Spectra and subsequently use these spectra to perform linear unmixing.

This process is called Excitation Fingerprinting.

To perform this task the software of the system provides the Macro "ExcitationFingerprinting60.lvb" (available in the folder: C:\ZEN\Macros).

### Calibration of the AOM:

A typical Ti:Sa laser does not supply an even power level over the wavelength range. To use such a laser for Excitation fingerprinting it is recommended to calibrate for the average power at the sample plane using a power meter.

The resolution of the power meter should be below 1 mW.

For the calibration one channel must be active otherwise the scan will not start and no laser is available. When ZEN is started one channel is always active per default. If the system was in use, check in the **Imaging Setup** tool if a channel is active.

For the calibration it is not relevant which channel is active.

Activate the laser to be calibrated in the **Channels** tool.

Next, set up the power meter in specimen plane using the combination of objective and main dichroic that will be used for Excitation Fingerprinting. Both, objective and main dichroic, influence the average power at the sample as well and need to be taken into consideration for this step.

Set up the Acquisition mode for Frame scanning with maximum speed and bidirectional scanning at the highest zoom.

This mimics a spot scan and will result in a steady beam coming out of the objective. The read out of the power meter will be much more accurate.

It is not needed to measure absolute powers but relative powers influenced by the AOM settings.

Load and run the **Macro** from the **Macro Control** window.

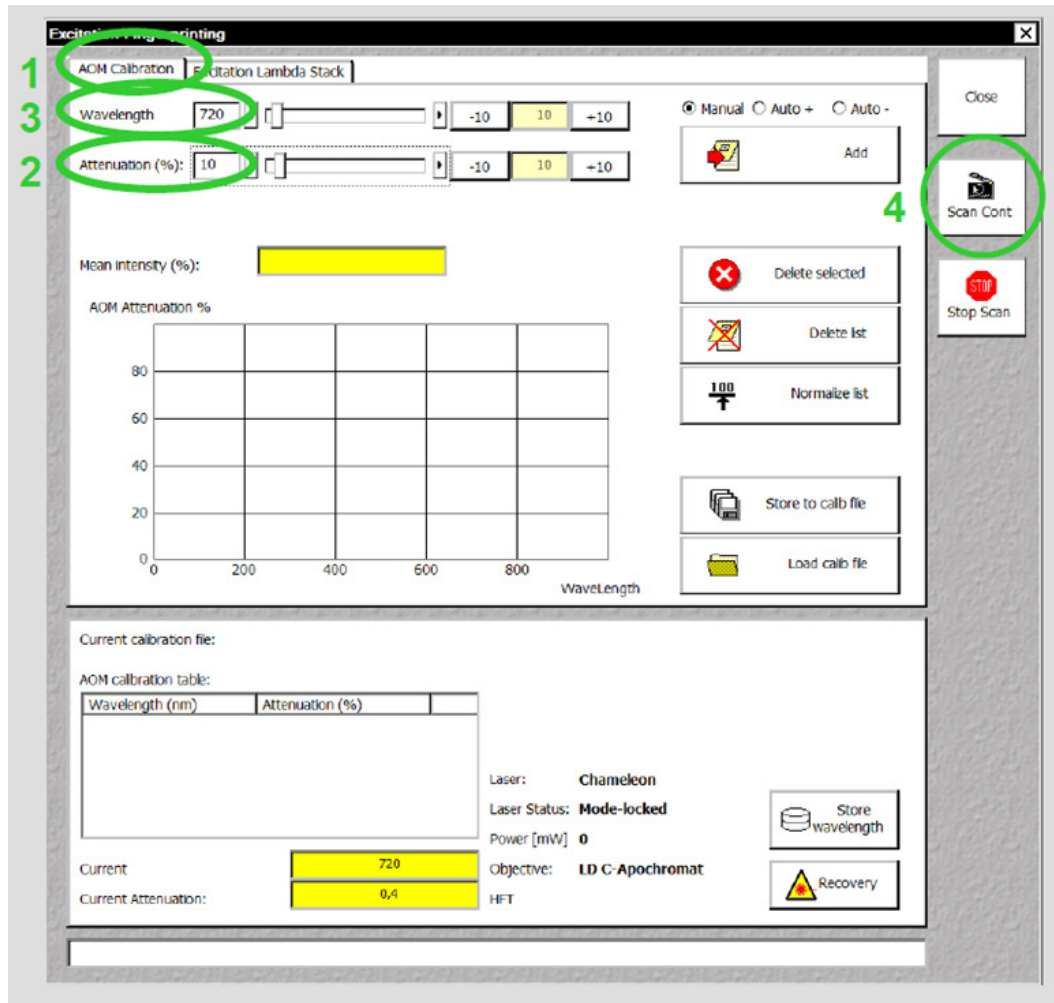


Fig. 9 Macro: Excitation Fingerprinting

- 1) Chose the **AOM Calibration** tab.
- 2) Set AOM Transmission to a value around 10.
- 3) Set the laser to the lowest wavelength possible (ideally this has already been done in the main software).
- 4) Start a Continuous scan.
- 5) Read out the value of the power meter. This value needs to be kept constant during the subsequent steps.
- 6) Activate the **Auto+** option (**Auto-** is chosen when starting with the highest wavelength available).
- 7) By clicking **Add and + 10 Steps** the AOM value will be added to the calibration list and the laser is tuned 10 nm further.
- 8) Now adjust the AOM transmission such that the power read out of the power meter shows the same value as with the previous wavelength.
- 9) Repeat step 2 and 3 until the end of the wavelength range is reached, then stop scanning.

To reuse the calibration for later use normalize the values before storing them as an .aom file in a folder of your choice

The normalized AOM values will provide the right AOM settings starting with the chosen setting at a given wavelength and calculating the relative values for all other wavelengths. Thus it is avoided to reach maximum or minimum AOM settings before the end of the wavelength range.



The step size for setting the AOM and tuning the laser can be edited.

Choosing **Manual** requires performing the tuning of the laser and the setting of the AOM by using the slider or typing in a value.

Single highlighted values in the calibration list or the whole list can be deleted.

Mean intensity (%) refers to the overall image intensity value; the value is displayed as % of the maximum intensity value at chosen data depth (8, 12 or 16 bit).

The lower part of the window shows the values of the currently used calibration file, the laser status, the objective and main dichroic.

The **Store wavelength** button will update the laser wavelength in the main SW.

### Acquisition of an Excitation Lambda Stack:

- 1) Focus the specimen and set the AOM and detector gain to obtain a good image at the chosen wavelength. Switch to Excitation Lambda Stack.
- 2) Load the calibration file required for the used main dichroic and objective.
- 3) Set the wavelength range and step size at which the images should be acquired. (This is independent of the range and step size of the calibration curve.)
- 4) Start the image acquisition.

The Excitation lambda stack is displayed the same way as an emission lambda stack.

When checking the **Show Text** option the wavelength used for excitation of each image is displayed.

The Excitation Fingerprinting or the unmixing of the Excitation lambda stack can be performed in different ways.

It is possible to use already existing Excitation Spectra from previous experiments.

One can also use ACE (Automatic Component Extraction) to define the spectra from the newly acquired stack and use those for unmixing.

The spectra can also be defined manually by using the drawing tools.

The method to work best and is convenient to use depends on the labelling of the specimen.

If the different fluorescent dyes show no or only moderate spatial overlap in the specimen, ACE works well.

If the fluorescent dyes are strongly co-localized, it is recommended to use predefined Excitation Spectra of the individual fluorescent dyes.

## 2.6 Concatenate Images

The macro allows concatenating various types of images into one image document showing the final image as a time series image. It is useful to combine images from Multi Block experiments into one image document showing the time series of one Block only. In this case the time stamps of the image are consecutive relating to the image acquisition time of the first image of the Block.

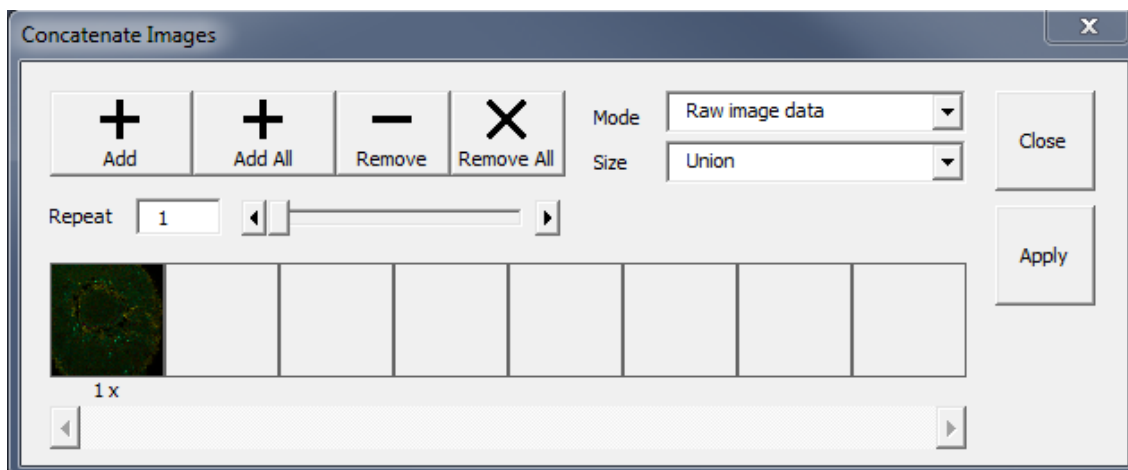


Fig. 10 Concatenate Images Macro

Use Raw image date **Mode** and **Size** Union for concatenating the images as raw data in a subsequent manner. **Add** opens up a small window showing all open image documents.


Chose the ones to be concatenated and click **Ok** to confirm the selection. **Apply** generates the final image document. Individual (highlighted) images or all can be removed clicking the corresponding buttons.

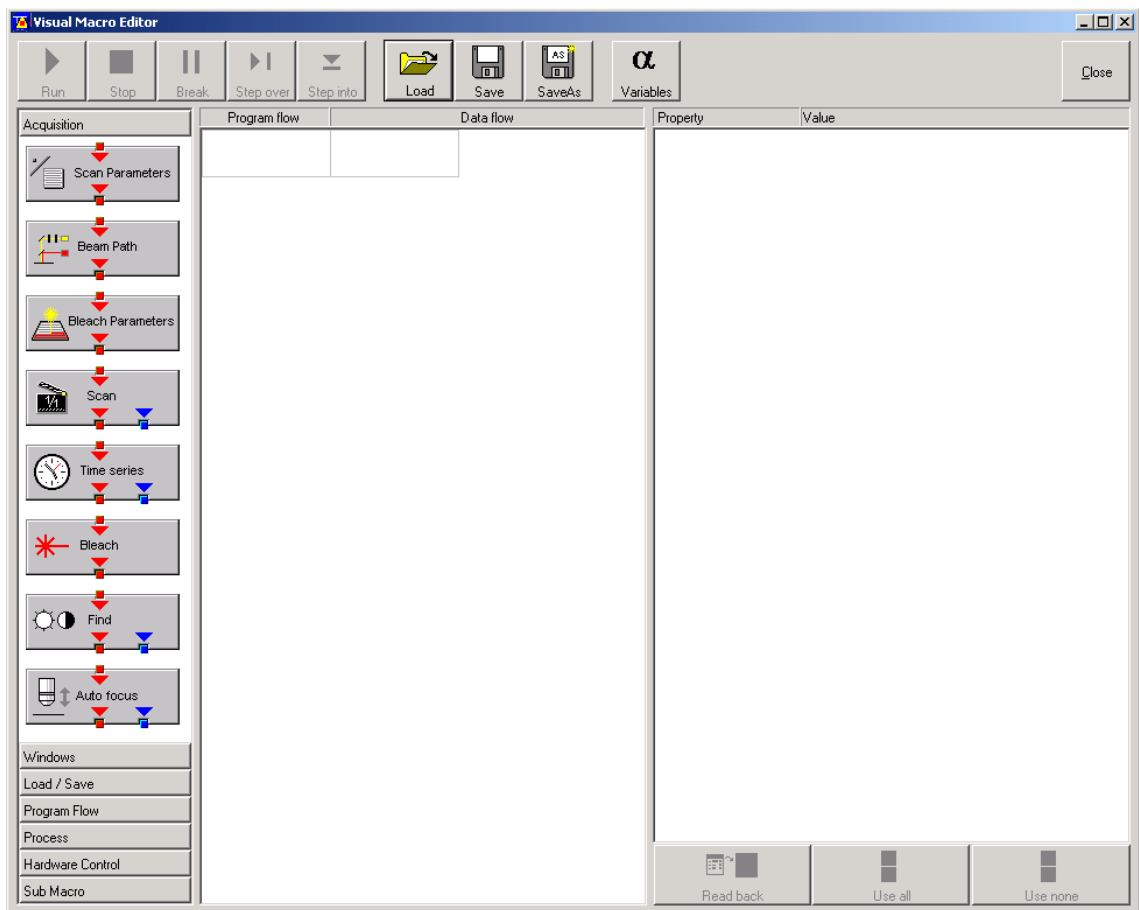
### 3 Visual Macro Editor

The Visual Macro Editor is an optional software module which allows the user to program a variety of scanning procedures, image calculations or image processing routines as well as the combination of these functions.

#### 3.1 Open / Close the Visual Macro Editor Window

- Choose the **Visual Macro Editor** from the **Macro** menu in the Main Menu Bar.

- Click on the  button in the upper right side of the window to quit.



**Fig. 11 Visual Macro Editor window**

---

## 3.2 Function Description

### Toolbar buttons

<b>Run</b>	Starts the macro starting with the first block in the program flow column.
<b>Stop</b>	Stops the macro at any time.
<b>Break</b>	Interrupts the macro. Clicking the button again will resume the actual program flow of the Macro.
<b>Step over</b>	Runs a sub-macro and stops at the first action block in the main macro.
<b>Step into</b>	Stops at the first action block in a sub-macro.
<b>Load / Save / Save as</b>	Use <b>Load</b> to open an existing macro and <b>Save</b> to store the macro. <b>SaveAs</b> allows storing the same macro under a different name.
<b>Variables</b>	By clicking the button the list of defined variables is displayed. New ones can be added by typing in name and value in the next free line. Variables are assigned to macros. For each new macro a new list of variables has to be generated.

The editor uses predefined action blocks. The action blocks for setting up the work flow of the macro are categorized according to their properties. The following categories are displayed on the left-hand side of the **Visual Macro Editor** control window.

- Acquisition
  - Windows
  - Load/Save
  - Program Flow
  - Process
  - Hardware Control
  - Sub Macro
- Click on one of the category selection buttons will display the available action blocks.  
The action blocks can be positioned according to their function either in the **Program Flow** column or the **Data Flow** column. The color of the connection arrows of the action block defines the possibility to position the block in the program flow column or the data flow column(s).

- Click at the action block with the left mouse button (hold down the mouse button) and drag the mouse cursor into the flow column. Release the mouse button.
  - Action blocks for the program flow show red connection arrows ▼ as well as blue output arrows ▼ to connect to the data flow.
  - Action blocks for the data flow show blue connection arrows ▼ or green output arrows ▼ to connect back to the program flow.



It is not possible to drag an action block for program flow into the data flow or an action block for data flow into the program flow.  
Action blocks can be removed using the **Delete** key of the keyboard.



A block is highlighted by clicking onto the block icon. To highlight more than one block drag the cursor over the block icons to be marked. A click on the right mouse button also allows using the functions **cut**, **copy**, **paste**, and **delete** to modify a macro.



Without using the **Image Display** action block in the data flow column, the result of the scan will not be displayed (see also description of **Scan** and **Time Series** action blocks).

The work flow is generated by connecting the action blocks using the mouse cursor.

- Click onto an output arrow with the left mouse button (hold down the mouse button) and drag the mouse cursor away.
  - A connecting line appears.
- Drag the line to the input arrow of another action block. Only arrows of the same color can be connected.

According to the action blocks a set of properties is listed which can be assigned with free or predefined values. These values can also be variables. A set of defined properties is assigned to one block only. If this block is used more than once the properties can be set differently.

Clicking the **Read Back** button will take over the current settings from the LSM main program for the displayed properties list.

- Mark the check boxes next to the parameters individually or, click **Use all** or **Use none** to check or uncheck all parameters with one click.
- For changing value click into the **Value** column.

It is possible to define variables. A variable has a (property) name and a mathematical value. The **Assignment** action block can be used to assign a new value to a variable when inserted into the program flow using mathematical algorithms. The new value is then used for any subsequent calculation in the program flow where the variable is part of the calculation.

- Click the **Variable** button on the toolbar to display the variable list. Click once more to display the parameter list again.
- New variables can be added by typing in name and value in the next free line.

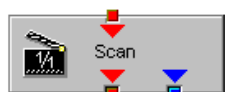
## Acquisition Action Blocks



Loads a Beam Path Configuration from the Configuration list or uses the current one that is set up in the main program. Use the pull down menu in the **Property/Value** list to select the Configuration that should be used for imaging. Changing between Single Track and Multi Track allows choosing between the different Configuration lists. Multi Track also lists tracks that are used for Emission Fingerprinting or Online Fingerprinting. Depending on the type of track different settings can be loaded optionally. If they are not loaded and the parameters list of the Scan Parameter block does not offer them as being editable, for example detector gain and offset, default values will be used. Read back will use the actual parameters of the main program.



The list of properties lists all parameters that can be adjusted for the scan procedure. The value for each parameter can be typed in individually. Clicking the **Read Back** button will take over all current settings from the main software. The check boxes next to the parameters can be marked individually or, clicking **Use all** or **Use none** they can be all checked or unchecked with one click. Only the parameters with a mark in the check box will be taken into account and adjusted when the Scan Parameter block is set in the program flow column. This allows changing only some of the parameters, for example the zoom, at a certain position within the program flow as for each block the check boxes can be set.



This block performs the scanning of the sample according to the settings chosen with Beam Path and Scan Parameters. It can be linked to the Data flow column. If no connection to the data flow is made (for example: Display Image) the result of the scan will not be displayed.



The parameters for bleaching the sample can be loaded from the list of bleach settings. Bleach settings are assembled and stored in the Bleach control window of the main software.



This block performs the bleaching of the sample according to the bleach settings that have been defined in the Bleach Parameters block.



The list of properties lists all parameters that can be adjusted for the acquisition of the time series. The value for each parameter can be typed in individually. Clicking the **Read Back** button will take over all current settings from the main software. The check boxes next to the parameters can be marked individually or, clicking **Use all** or **Use none** they can be all checked or unchecked with one click. Only the parameters with a mark in the check box will be taken into account and adjusted when the Time series block is used in the program flow column. This allows changing only some of the parameters at a certain position within the program flow, for example the trigger used, as for each Time series action block the check boxes can be set individually. Activating the Bleach parameter will bleach the sample according to the settings in the Bleach Parameters action block during the time series. The Time series action block can be connected to the data flow column.





This block performs the **Find** function according to the main software.



This action block sets the Z-position according to the focusing procedure set with the parameters available. The image generated displays the image or image series acquired to set the focus position. The following properties are available to define the auto focus function:

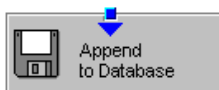
- Mode/Precise: Uses fast XYZ-scan(s); the scan parameters can be defined via Scan Parameters Action Block
- Mode/Fast: Uses fast XZ-scan(s)
- Method/Intensity: auto focus mode which searches for maximum intensity.
- Method/Contrast: auto focus mode which searches for maximum contrast.
- Range ( $\mu\text{m}$ ): The system will perform the auto focus search within that range.
- Offset ( $\mu\text{m}$ ): Defines the distance between the focus plane set by the auto focus function (e.g. coverslip reflex) and the focal plane for imaging.
- Assign position to: Chose a variable to which the new position of the focus plane set by the auto focus function (e.g. coverslip reflex) should be assigned.
- Assign offset to: Chose a variable to which the offset value should be assigned.

### Windows Action Blocks



This block has to be used if the actually scanned image(s) should be displayed. For each Image Display block a new image window is opened. If not saved, the image will be overwritten when the program flow is passing by again.

### Load / Save / Action Blocks



The image(s) are stored to an image database. The database taken is either the last one, that was open or the current open one. Clicking Read back updates the database to be used for storing the image(s). In addition some other parameters can be set according to the list of properties displayed.



Within the program flow already existing images can be loaded.

The database taken is either the last one, that was open or the current open one. Clicking Read back updates the database to be used to load the image(s) from. The images can be loaded by Index or by the name of the image.

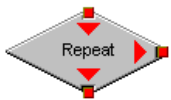


It is possible to export images choosing a certain file format from the pull down list that appears when highlighting the line File Format in the properties list. Specific parameters are assigned to each file format which can be set for the image export.

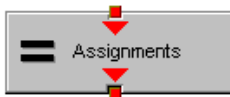


Images can be imported within the program flow. The image to be loaded can be selected by typing in the file path. The import of single images or an image series is possible. The images to be imported as series must have the same name and must be numbered in ascending order.

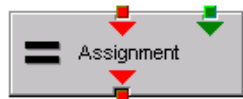
### Program Flow Action Blocks



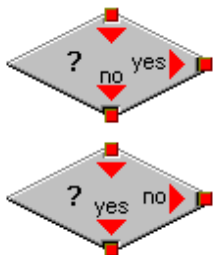
If any action(s) should be repeated a defined number of times, the Repeat block should be set into the loop of the program flow. The number of repeats is set in the properties list. The repeat is only performed using the connection of the right arrow. After finishing the repeats, the program flow connected to the arrow pointing down is performed.



Using this block in the program flow allows assigning new values to a selected variable using mathematical calculations which can be typed into the value line. All predefined variables can also be used for calculations. By passing this block the variable will be transiently changed and the new value can for example be used to assign different numbers to the image name or to increase the time delay during a time series acquisition.



This block assigns a new value to a variable which has to be selected from the drop down list. The value assigned results from a calculation taken from the statistics action block (see below).



The two blocks are used as decision makers. Depending on the value of a predefined variable, the program flow can be directed to one of the two possible directions. The expression of the variable's value which should be used to decide on the program flow is set in the properties list individually for each used decision making block. It takes the actual transient value of the variable into account.

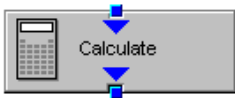


This block introduces a delay in the program flow. The delay time is started when the block is reached within the program flow.

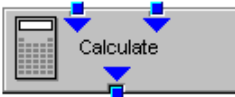


The block allows to assign a potential error message with a textbox and to decide on the Error where to direct the program flow. If no textbox is assigned the program flow will just continue according to the presence of an error message. Choosing a textbox requires the input of the user to continue with the program flow.

**Process Action Blocks**



This block allows to do image calculation using the pixel intensities of the image. The operators for the formulas that can be used are described in the Ratio Dialogue within the Process Menu. The formulas set up in the Image calculation window can be copied and pasted into the properties list of the Visual Macro Editor.



For calculations using two different sources the Calculate block with two possible inputs is used. The calculation starts when both inputs have arrived. Within program loops the next calculation will start when the inputs have arrived again in the same sequence as the first time. The operators for the formulas that can be used are described in the Ratio Dialogue within the Process Menu. The formulas set up in the Image calculation window can be copied and pasted into the properties list of the Visual Macro Editor.



The input image will be copied to a new image format that can be defined by changing the values of the listed properties.



Using this block enables to copy one image into another with the coordinates and settings put into the properties list. The destination image is connected to the left input; the source image is connected to the right input.



The subsequently arriving images will be concatenated according to the coordinate setting and treated as one image. A subsequent image display will be updated each time a new image arrives.



The second concatenate action block allows concatenating images from two different acquisition blocks.



The block uses an input image (left input) and chooses a region within that image according to a mask (right input) that has been defined in the Mask action block (see below). Within that mask region of a selected channel, one of the following result values can be selected which is then assigned to the chosen variable in the corresponding assignment action block:

- Mean intensity: Equals mean intensity within mask region
- Standard deviation: Equals standard deviation of intensity distribution within mask region
- Number Pixels: Number of pixels that constitute the mask region
- Area ( $\mu\text{m} \times \mu\text{m}$ ): Area of mask region
- Minimum: Minimum intensity value found within mask region
- Maximum: Maximum intensity value found within mask region



This action block defines a mask (image region with defined properties) derived from an image window. The image can be a newly acquired or imported image. The properties of the mask based on the image data can be selected according to the following properties:

- Scan regions(s): The mask is based on the scan region(s) defined in the **ScanControl**.
- Bleach region(s): The mask is based on bleached region(s) defined in the **BleachControl**.
- Image overlay: The mask is based on image overlay regions.
- ROI list entry: The mask is based on ROIs listed in Edit ROI control window.
- Interactive overlay: The mask is defined using overlay regions which are defined while the macro is executed.
- Interactive histogram: The mask is defined via histogram settings (min/max) interactively defined while the macro is executed. This works in conjunction with ROI selection (interactive or stored) as described above.
- Region index: Index of ROI (i.e. ROI number) if for example multiple bleach regions are active.
- Channel: Image channel which is used to derive the mask parameters from. This works in conjunction with interactive settings or loaded images.
- Intensity range: Defines the intensity range which is applied for mask definition.
- Lower threshold: Defines lower intensity threshold which is applied for mask definition. This threshold can be an absolute number or a floating point.
- Upper threshold: Defines upper intensity threshold which is applied for mask definition. This threshold can be an absolute number or a floating point.

### Hardware Control Action Blocks



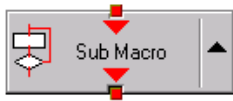
If a motorized stage is available the movement of the stage can be set up as part of the program flow. The stage can be moved to an absolute position which can also be taken from the actual stage position using the Read back function or typed in individually. Using a relative position will use the current stage position as relating position. The values have to be typed in.


It is also possible to choose the position from the **Mark and Find** position list which must have been set up in the stage control menu to be available.



The movement of the focus can be set up as part of the program flow. The focus can be moved to an absolute position which can also be taken from the actual focus position using the Read back function or typed in individually. Using a relative position will use the current focus position as relating position. The values have to be typed in. For large travel ranges which exceed half of the objectives working distance a warning can be displayed.

**Sub Macro Actions Blocks**



This block allows setting a sub macro within a main macro. The sup macro is opened by clicking onto the arrow in the block icon and closed clicking the  top right of the program flow column. The number of program flow in- and outputs as well as the number of program flow in- and outputs (= number of available connection arrows indicated on the block icon) can be defined for each sub macro. Multiple connections are therefore possible. The maximum of inputs and outputs for each flow is ten.

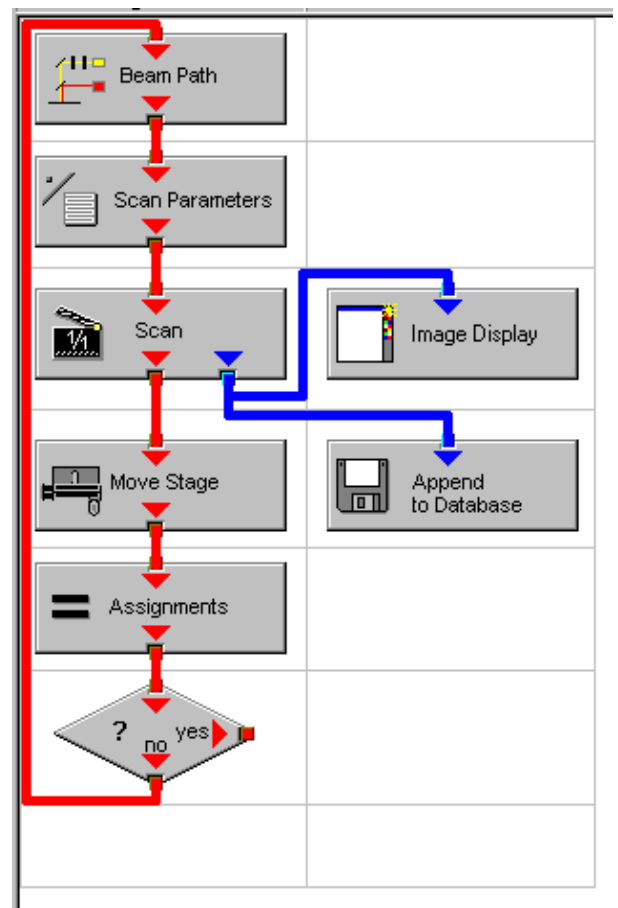


Using this block allows integrating macros or macro procedures programmed with visual basic into a VME macro. The number of data flow inputs and outputs can be set to a maximum number of ten. The name of the macro indicates the name within the VME macro. The file name refers to the path and name of the VBA macro to be loaded into the VME macro. If no procedure available within the VBA macro is selected the whole VBA macro will be executed.

**3.3 Editing a Macro**

Following Example shows a macro which acquires five subsequent images and moves the stage 10 microns in X and Y following each image. The images are stored and numbered in ascending order.

- Arrange and connect the action blocks (see Fig. 12).



**Fig. 12 Arrangement of action blocks**

Property	Value
Index	1

Fig. 13 Assignment of the variable

- Assign the value 1 to a variable named Index (see Fig. 13).

Property	Value
Configuration Type	Single Track
Configuration	488 FITC
Load Speed	No
Load Bits per Sample	No
Load Pinhole Diameter	No
Load Gain and Offset	No

Fig. 14 Property list of the Beam Path action block

- Click the single action blocks and assign the values to the listed properties (beam path and scan parameters can be chosen according to the sample).
- See Fig. 14 / Fig. 15.

Use	Property	Value
<input checked="" type="checkbox"/>	LSM Pixels X	512
<input checked="" type="checkbox"/>	LSM Pixels Y	512
<input checked="" type="checkbox"/>	LSM Step Y	1
<input checked="" type="checkbox"/>	LSM Zoom	1.600000
<input checked="" type="checkbox"/>	LSM Rotation [°]	45.000000
<input checked="" type="checkbox"/>	LSM Offset X [µm]	0.000000
<input checked="" type="checkbox"/>	LSM Offset Y [µm]	0.000000
<input checked="" type="checkbox"/>	LSM Pixel Period [µs]	2.560000
<input checked="" type="checkbox"/>	Camera Mode	Mono 1300 x 1030
<input checked="" type="checkbox"/>	Camera Pixels X	1300
<input checked="" type="checkbox"/>	Camera Pixels Y	1030
<input checked="" type="checkbox"/>	Camera Offset X [Pixels]	0.000000
<input checked="" type="checkbox"/>	Camera Offset Y [Pixels]	0.000000
<input checked="" type="checkbox"/>	Pixels Z	1
<input checked="" type="checkbox"/>	Scaling Z [µm]	1.000000
<input checked="" type="checkbox"/>	Offset Z [µm]	0.000000
<input checked="" type="checkbox"/>	Bits per Sample	8 bit

Fig. 15 Property list of the Scan Parameter action block

Property	Value
Database	D:\Projekte\Release 3.5 RT\SW\Scripting\test 2.mdb
Name	"Cell culture" + Index
Description	
Notes	
Compress	Yes

Fig. 16 Property list of the Append to Database action block

- The database of the images will be appended to be automatically displayed when highlighting the **Append to Database** action block. The last one used will be taken. To update this, open the desired database and use the **Read back** function. Type in a name for the images with or without quotation marks. All images will get the same name then. For numbering the images use quotation marks for the name and add the variable Index, which has been assigned with the value 1. This value or the transiently changed value of the variable will be added to the name of the image (see Fig. 16).

- The movement of the stage is defined highlighting the **Move stage** action block, choosing the Mode Relative Position in the Property list and typing in the value 10 for X and Y which then will move the stage 10 microns into X and Y direction starting with the current stage position on passing that action block.
- Now the first complete scan has been performed and the image is stored. For the next cycle the variable Index has to get another value to make sure the numbering of the images works. Using the **Assignments** action block, the Variable Index is chosen and the value assigned is **Index + 1**. Such the variable will get the transient value 2 for the next cycle, the value 3 for the over next cycle and so on.
- The number of repeats can be defined using a Decision block and using the value of the variable as base for the decision. By defining that if the Expression of the variable is larger than 5 and not connecting the output arrow marked with "yes" to any other block, the macro will stop after the acquisition of five images. Alternatively one can use at this part of the program flow the Repeat block and define the number of repeats to be performed, which would be 5 in this case (The first scan is already counted!).

Property	Value
Mode	Relative Position
Distance X [µm]	10
Distance Y [µm]	10

**Fig. 17** Property list of the Move stage action block

Property	Value
Index	Index + 1

**Fig. 18** Property list of the Assignments action block

Property	Value
Expression	Index > 5

**Fig. 19** Property list of the Decision action block

## 4 VBA Programming for LSM

### 4.1 VBA Programming

Visual Basic for Applications (VBA) is a widely-spread programming language, and lots of sources for an introduction to the language can be found on the web. Therefore, we do not give a general introduction into VBA programming here. From here on, we assume that the user is familiar with basic VBA programming.

If you have not had experience with VBA programming before, please consider to work through an introduction first before starting with VBA for ZEN.

### 4.2 Programming for LSM: Starting points

The ZEN software (black edition) offers two starting points for programming in VBA. In technical language, these are two Application Programming Interfaces (APIs). They are called the Lsm5Vba API and the VBA-GUI API. Here, they are shortly summarized; a detailed description follows in the next two chapters.

The **Lsm5Vba** API offers a low-level, hardware-near access to the ZEN system. It is the older of the two APIs and has been used with ZEN macros for many years. Because of this, some of its functionality has changed its behavior or is not working correctly any more. To keep VBA macros compatible, we have not removed this functionality, so old macros still run, but their behavior may have changed. On the other hand, the Lsm5Vba API offers points of access to low-level system functionality, which makes it a very mighty tool for those who require a very specialized system usage.

The **VBA-GUI** API offers a high-level programming experience, very similar to using the graphical user interface (GUI). It was introduced with the release of ZEN 2011, and its structure changes slightly with each release to keep up with GUI changes. This API is the right choice for those who mostly want to automate routine workflows in a macro. In ZEN 2011 and later, the macro recorder produces code with commands from this API.

It is important to note that both APIs can be used in one macro. Thus, the user can rely on the high-level API whenever possible and switch to the low-level API when needed.



### 4.3 Object browser

To search the structure of an API object, use the object browser from the VBA editor. To explore an object from your VBA code, position the cursor in the object and press "F2".

For the Lsm5Vba API, many classes and methods offer a short help-string explaining their meaning. The object browser can not only be used to explore the ZEN APIs, but also for all other VBA functionality.

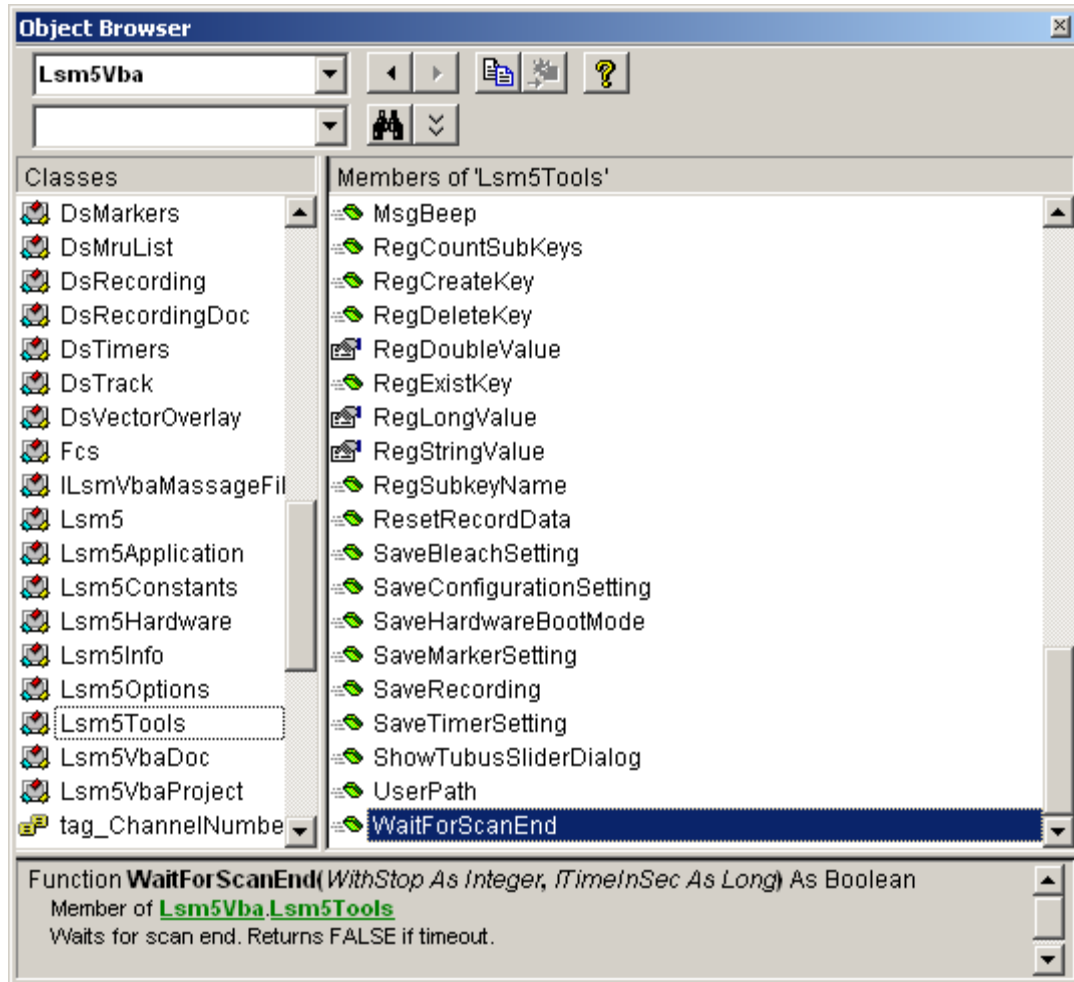


Fig. 20 Object Browser window

## 4.4 COM interface

The full range of ZEN VBA commands is also available via COM, by connecting a client program to a running ZEN system. There are two COM-automation objects available, for the Lsm5Vba interface and for the VBA-GUI interface. The COM object Lsm5Vba is called "Lsm5Vba.Application", and the one for the VBA-GUI interface is called "Zeiss.Micro.AIM.ApplicationInterface".

For example to connect a MATLAB session to ZEN, start ZEN first, start MATLAB, and then type

```
>> ZENVBA = actxGetRunningServer('Lsm5Vba.Application')
>> ZEN = actxGetRunningServer('Zeiss.Micro.AIM.ApplicationInterface.ApplicationInterface')
```

To start a scan, two commands are now available

```
>> ZENVBA.Lsm5.StartScan
>> ZEN.GUI.Acquisition.Snap.Execute
```

## 4.5 Glossary

- VBA: Visual Basic for Applications is an integrated programming environment that comes embedded into ZEN. It allows to automate routine operations by recording macros, and to write application programs that can use most features of the ZEN software.
- Macro: A program written in the VBA environment is usually called a macro.
- GUI: Graphical User Interface

## 4.6 Programming with the Lsm5Vba interface

### 4.6.1 Lsm5Vba API structure

Use the object browser and the intellisense feature in the VBA editor to explore the Lsm5Vba API. Also, some example macros are provided at the end of this chapter.

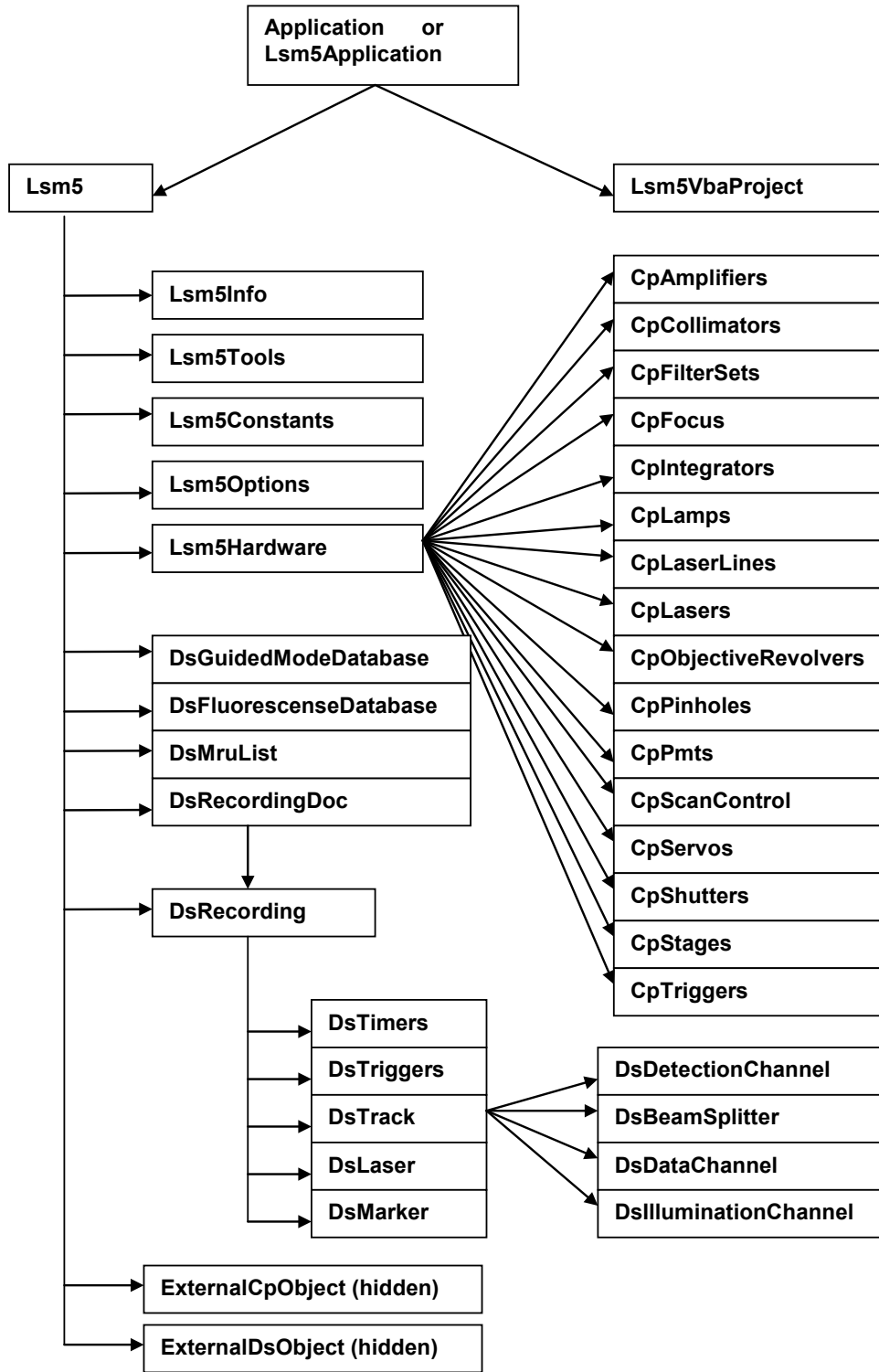


Fig. 21 Object structure

## 4.7 Programming with the VBA-GUI interface

### 4.7.1 Introduction

The ZEN VBA-GUI interface allows you to program ZEN with the same comfort and ease as using the mouse to control the GUI. All capabilities of the ZEN system are accessible via an intuitive syntax.

The main idea behind the ZEN VBA-GUI interface is to make ZEN commands available in the same way as they are in the GUI. The image shows how this principle works: To set the acquisition frame size, one has to

1. Select the **Acquisition** tab
2. Go to the **Acquisition** mode box
3. Set **Frame Size X** and **Y**

In the VBA-GUI interface, this translates to "Acquisition.AcquisitionMode.FrameSizeX" and "FrameSizeY".

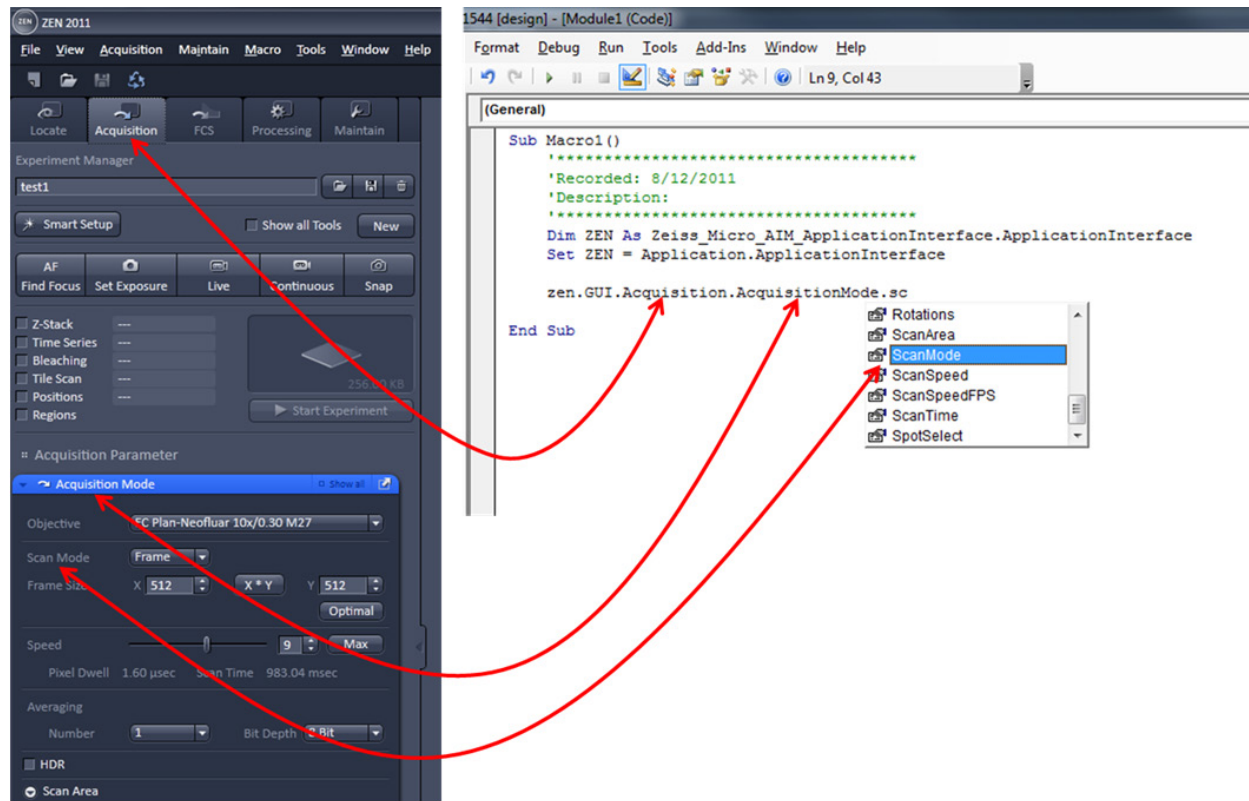


Fig. 22 ZEN VBA-GUI Interface

The easiest way to access the VBA-GUI interface is to start with a recorded macro. This contains a "ZEN" object, which has a "GUI" property. "ZEN.GUI" is the entry point to the VBA-GUI interface.

---

### 4.7.2 Structure of a VBA-GUI command

There are three different kinds of actions that can be performed in the ZEN GUI: Setting a value (either a number or a string, e.g. the frame size or configuration name), selecting from a list of options (e.g. the scan mode), and executing a command (e.g. Snap). To reflect this, different kinds of commands are available in the VBA-GUI interface.

All commands have a (Boolean, read-only) "IsEnabled" property that can be used to check whether the command is supported by the current system configuration. Also, commands have a (Boolean, read/write) "AsyncMode" property, that determines whether this command is executed asynchronously (i.e. program flow continues without waiting for the command to finish) or synchronously. The default is synchronous execution.

A command corresponding to a value in the GUI offers a "Value" property, which can be used to read or write the corresponding value. For numeric values, the command also offers (read-only) "Minimum" and "Maximum" properties.

A command corresponding to a range of options (i.e. a combo bvgbox or drop-down box) offers a selection using the "ByIndex" or the "ByName" properties. A list of available options (as name strings) can be queried from the "Items" property, and these name strings can be used in the "ByName" property.

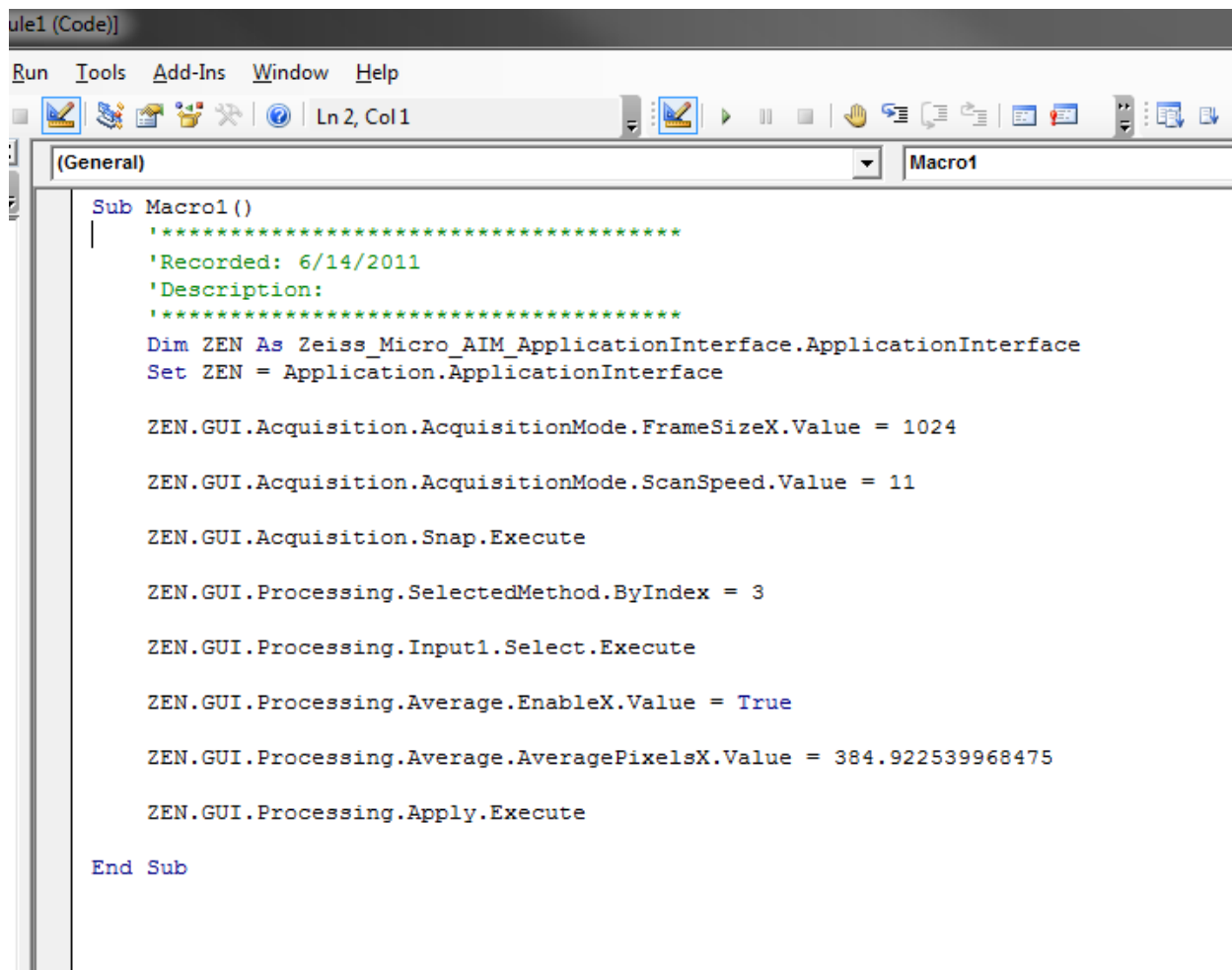
A command corresponding to a button (e.g. Snap) offers two methods: "CanExecute" can be used to check whether the command can currently be executed, and "Execute" causes the specified action to happen.

### 4.7.3 Recording a macro

When recording a macro, each click in the GUI is translated into a macro command in the editor. The image below shows an example in which the following steps are recorded:

- Set the frame size in X to 1024
- Set the scan speed to 11 (values are rounded)
- Take a Snap
- Select the processing function "Average"
- Select the currently active image as Input1
- Enable averaging in X-direction
- Set the averaging window in X-direction to a value of 385
- Start the processing function

The recorded macro can then be edited and executed just like a hand-written VBA program.



```
Sub Macro1 ()
'*****
'Recorded: 6/14/2011
'Description:
'*****
Dim ZEN As Zeiss_Micro_AIM_ApplicationInterface.ApplicationInterface
Set ZEN = Application.ApplicationInterface

ZEN.GUI.Acquisition.AcquisitionMode.FrameSizeX.Value = 1024

ZEN.GUI.Acquisition.AcquisitionMode.ScanSpeed.Value = 11

ZEN.GUI.Acquisition.Snap.Execute

ZEN.GUI.Processing.SelectedMethod.ByIndex = 3

ZEN.GUI.Processing.Input1.Select.Execute

ZEN.GUI.Processing.Average.EnableX.Value = True

ZEN.GUI.Processing.Average.AveragePixelsX.Value = 384.922539968475

ZEN.GUI.Processing.Apply.Execute

End Sub
```

Fig. 23 ZEN VBA-GUI Interface - Editor

#### 4.7.4 Selecting and managing image documents

Image document handling in the VBA-GUI interface happens via the "GUI.Document" command. From the list of open documents, images can be selected by index and by name, they can be closed and their acquisition parameters can be re-used. Also, a DsRecordingDoc pointer to the image object can be obtained directly from here.

#### 4.7.5 Technical note

The ZEN VBA-GUI interface is a new component for the 2011 release of ZEN (black edition only). It is not backwards compatible with earlier releases of ZEN, which means that macros using this interface cannot run on earlier ZEN systems. However, macros using the conventional ZEN VBA commands can still be written and run on ZEN 2011. Thus, as long as no command in your macro begins with "ZEN.GUI", it is compatible to earlier releases.

Additionally, the VBA commands for ZEN black edition (including the VBA-GUI interface) are not compatible to ZEN blue edition.

## 4.8 Example Macros

This library of example macros is designed as a starting point for your own programming ventures. They are deliberately kept simple for quick understanding and hand-on. We recommend that you create copies of the macros and then edit them to see how ZEN reacts to your commands.

You can find the macros in ZEN\Macros\Examples\Macros.

### 4.8.1 Access to images

This macro demonstrates how to access the pixel values of an existing image.

[C:\ZEN\Macros\Examples\Macros\access\_to\_images.lvb]

### 4.8.2 Backup recording settings

This macro demonstrates how to backup the acquisition settings and then later change the settings back to the original ones.

[C:\ZEN\Macros\Example\Macros\backup\_recording.lvb]

### 4.8.3 Event handling

Events can be used to react to actions by the user or by the hardware. Typically, events in ZEN are either

- Mouse events
- Scan state events
- Hardware events

This macro shows how to react to mouse events in a VBA macro.

[C:\ZEN\Macros\Example\Macros\CaptureMouseEvents.lvb]

### 4.8.4 Export, Save and Load

This example demonstrates how to export an image (as TIFF), save it (in the CZI format), and load it (from CZI and TIFF). It can be easily adopted to other file formats.

[C:\ZEN\Macros\Example\Macros\Export\_Save\_and\_Load.lvb]

#### **4.8.5 VBA-GUI API**

We have not created example macros for the VBA-GUI API, because these can easily be generated by the macro recorder functionality. Activate macro recording and then execute the actions that you want to automate. Then edit the script to suit your needs.

Note: If you are afraid of working with an online-system, you can also record and edit macros in the ZEN Demo mode.



---

# CHAPTER 3                      ADDITIONAL SOFTWARE TOOLS

## CONTENTS

	Page
<b>1            Stand Select.....</b>	<b>2</b>
<b>2            SystemMaintenance Tool .....</b>	<b>3</b>
2.1          Calibration Objective .....	3
2.2          Starting the Maintenance Tool .....	4
2.3          General Operation of the Maintenance Tool.....	5
<b>3            ZEN Configuration Tool .....</b>	<b>7</b>

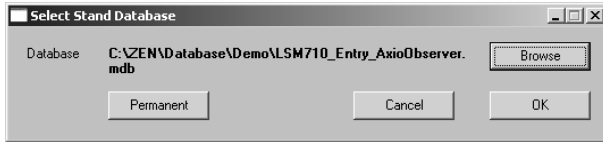


Fig. 1 Select Stand Database window

- The **Select Stand Database** window appears on the screen. The currently used database is displayed in the **Database** box.

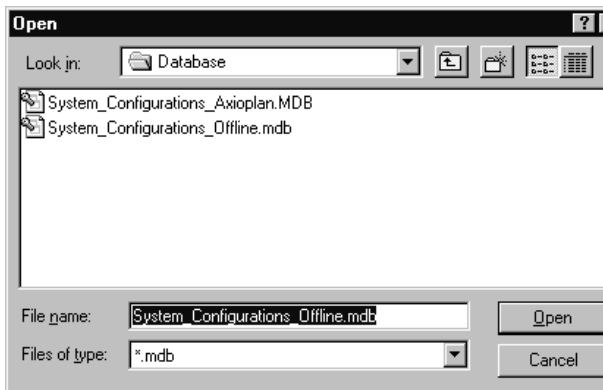


Fig. 2 Open window

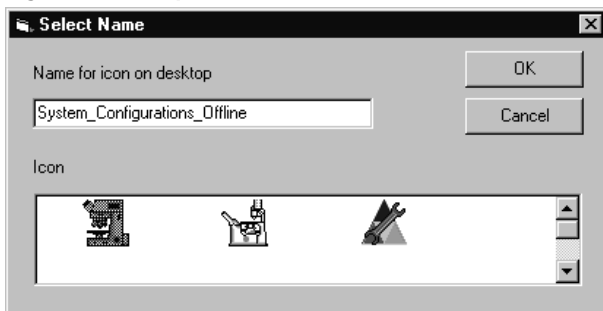


Fig. 3 Select Name window

## 1 Stand Select

The **Stand Select** tool permits a new or updated database to be assigned to the ZEN software program.

- Close the ZEN software program and double-click on the **Stand Select** icon on the desktop.
- Click on the **Browse** button to choose a different database.
  - The **Open** window appears on the screen.
- Click on the name of the database (file extension: **\*.mdb**) and then the **Open** button.
  - The **Open** window is closed and the name of the new database appears in the **Database** box.
- Click on the **Permanent** button. The **Select Name** window appears.
- Select the relevant stand icon from the **Icon** list box and click on **OK**. The **Select Name** window is closed and the desktop icon is updated.
- Then click on the **OK** button in the **Select Stand Database** window to accept the new settings and to close the window. (Clicking on **Cancel** will cancel the procedure.)
  - After the next restart of the ZEN software, the new database will be automatically loaded.

## 2 SystemMaintenance Tool

With a calibration objective and correct system configuration, the SystemMaintenance tool allows convenient self-adjustment of LSM.

The optical beampath, relative pinhole position and scanner adjustment can be set and checked automatically with this tool. In systems that combine different imaging devices (e.g. ELYRA), the SystemMaintenance tool calibrates only the LSM scan head.

### 2.1 Calibration Objective

Observe the following notes:

- The calibration objective is not suitable for multiphoton excitation; there is a risk of bubble formation in the substrate.
- Using the HAL, the IR protection filter must be used, and the intensity of the HAL should only briefly be set to more than 70 %.
- With strong heat there is a risk of deformation of the substrate in the calibration objective.
- The lateral screws need to be tightened carefully without applying too much force.
- The calibration objective needs to be entered in the system database as "APO Calibration LSM" with SAP no. 420639-9000-700. It needs to be entered at ZEN \ Maintain \ Objectives and at the TFT display.
- Calibration objectives with other samples than shown in Fig. 4 shall not be used. The cap with the calibration sample can be obtained separately under SAP-No. 420639-9900-700.

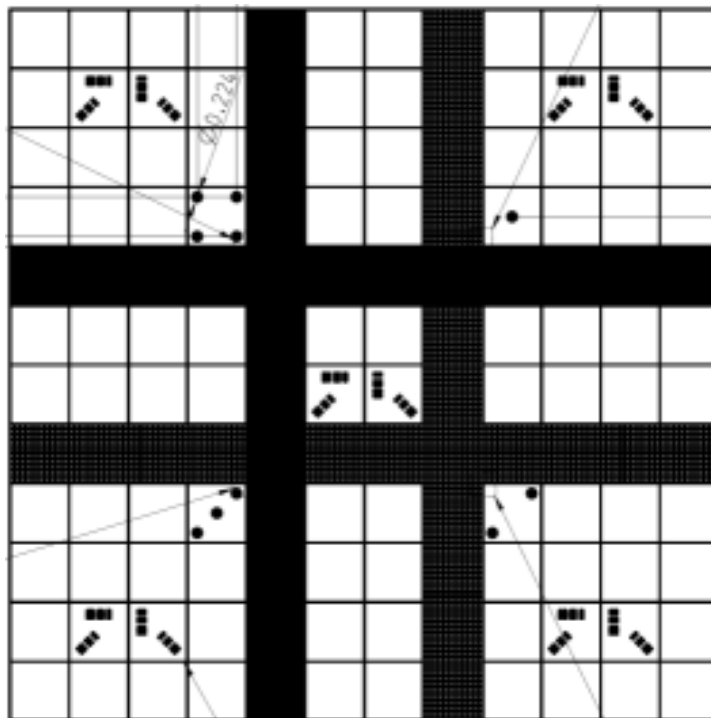


Fig. 4 Calibration objective

## 2.2 Starting the Maintenance Tool

Before starting the Maintenance Tool, the system hardware must be fully activated.

To do this, open ZEN and check the following settings: Correct entry of all existing lenses; the calibration objective needs to be entered as **APO Calibration LSM**.

- Correct entry of all existing lenses; the calibration objective needs to be entered as **APO Calibration LSM**.
- For LSM systems with a 405 nm laser, an approximate collimator position should be saved for the calibration objective.
- The focus plane needs to be approximately correct
- All light sources (Hal, LED's, lasers) need to be activated
- If all these settings are correct, close ZEN and then start the SystemMaintenance Tool by clicking the desktop icon (Fig. 5).

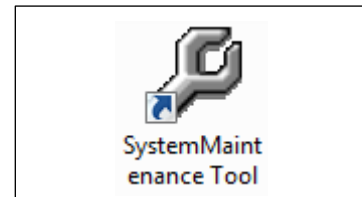


Fig. 5 Desktop icon of the Maintenance Tool

During the system initialization phase, the SystemMaintenance Tool will display the boot status (Fig. 6).

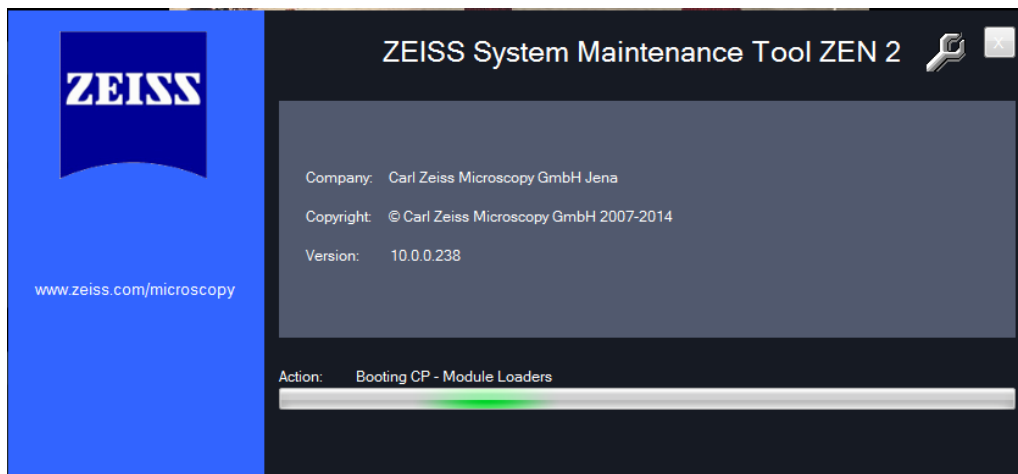


Fig. 6 Boot status of the Maintenance Tool

- After start, choose **Log in... Customer** (type-in any name).

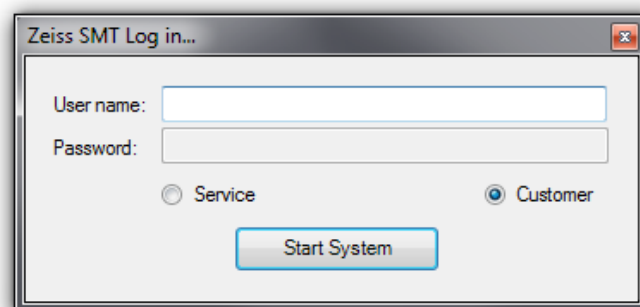
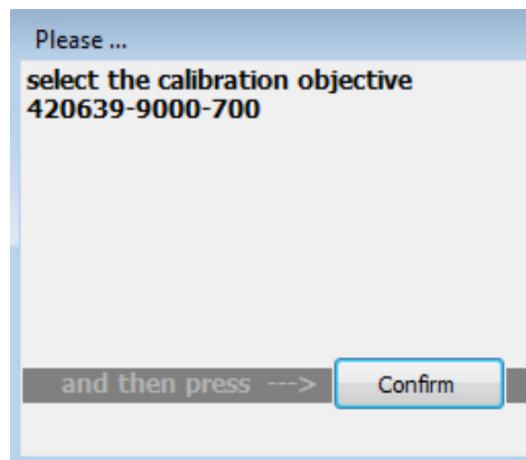


Fig. 7 Log in window

The Maintenance Tool can only be used, if the calibration objective is entered as **APO Calibration LSM**. If this is not the case, a message will remind the user to select the calibration objective.



**Fig. 8** Selection of the calibration objective

## 2.3 General Operation of the Maintenance Tool

The desired task can be chosen from the list and started with the start button.

### Tasks available for LSM

- Sharpness Test
- Scan Field Test
- Scanner Calibration
- Pinhole to MBS Calibration

In case a task requires any manual adjustments, the Maintenance Tool guides users to all adjustment steps.

After the completion of a task, the result is displayed with a traffic light type green/yellow/red indicator.

- If green is indicated, the task has been fully accepted.
- If yellow is indicated, repeat the task and try to optimize the settings (e.g. check focus, KÖHLER illumination, halogen lamps, lasers (no standby) etc.
- If red is indicated, repeat the test one more time; if it still fails, contact your local LSM service engineer.

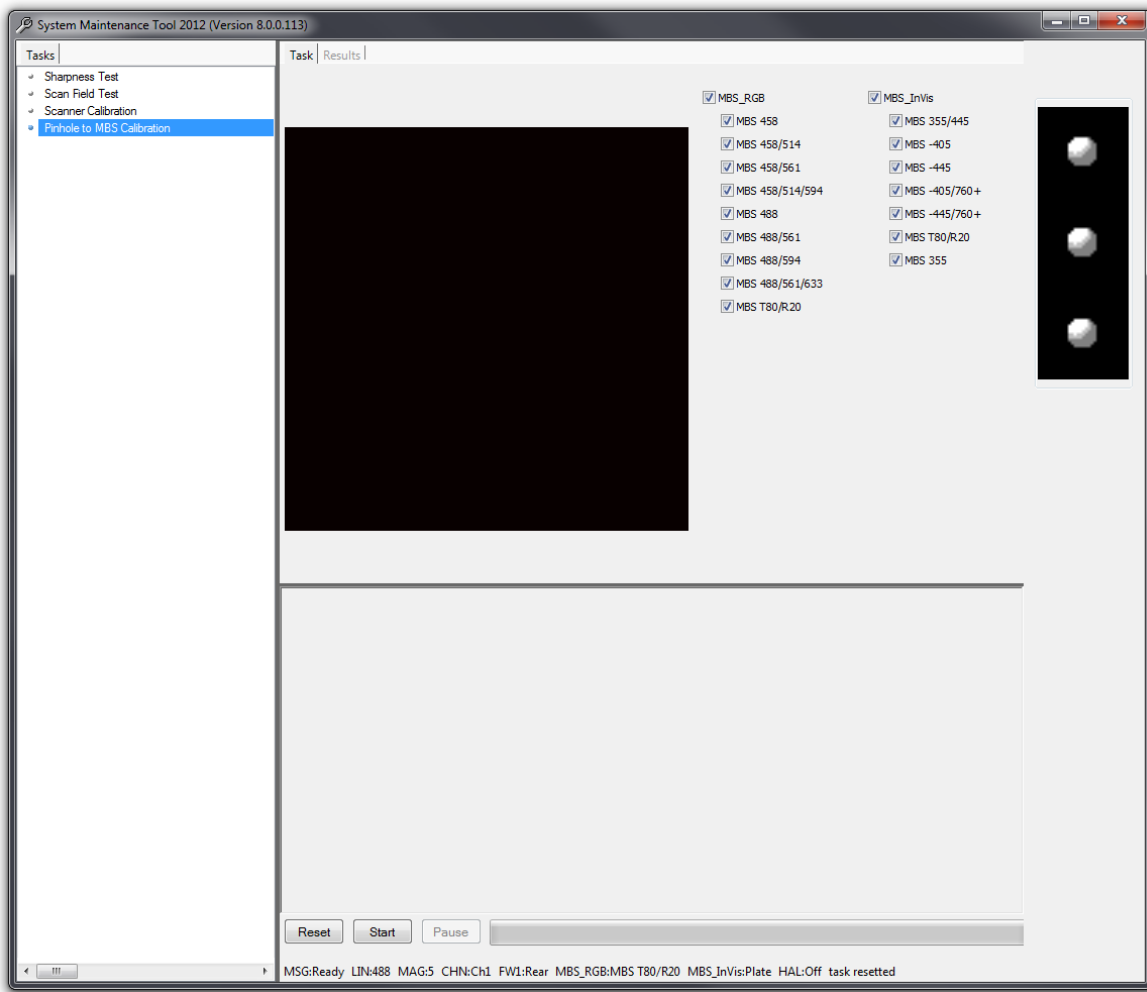


Fig. 9 Maintenance Tool main window

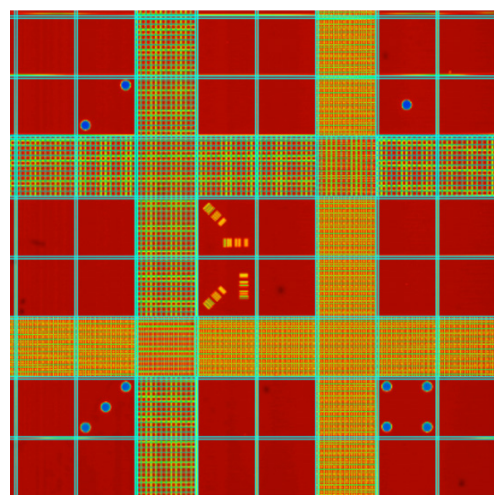
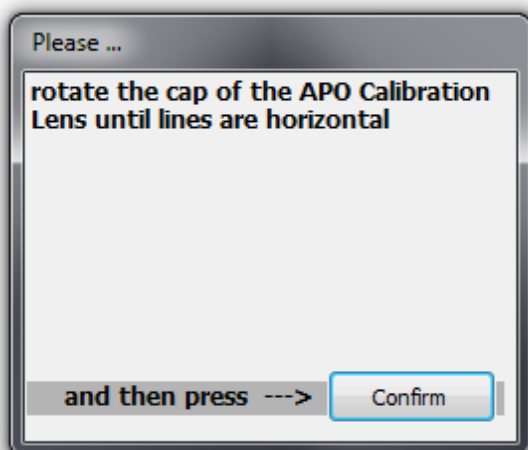


Fig. 10 The Maintenance Tool guides users through required adjustment steps

### 3 ZEN Configuration Tool



The configuration tool provides access to the database of a system. Be aware that wrong entries can lead to a malfunction of the system. Always keep a backup of the original database. The database of the system is stored in C:/ZEN/database. Always make a copy of the database before you start to configure it.

Do not change any main settings or your system will not work anymore.

The following procedure describes how to define a new filter for external detectors like NDD or BiG.2. Once defined within the configuration tool (Fig. 11), these filters will also be accessible via ZEN.

- Open the tool; it will refer to the last database used which should be the systems database.
- Make sure you have a copy of this database.

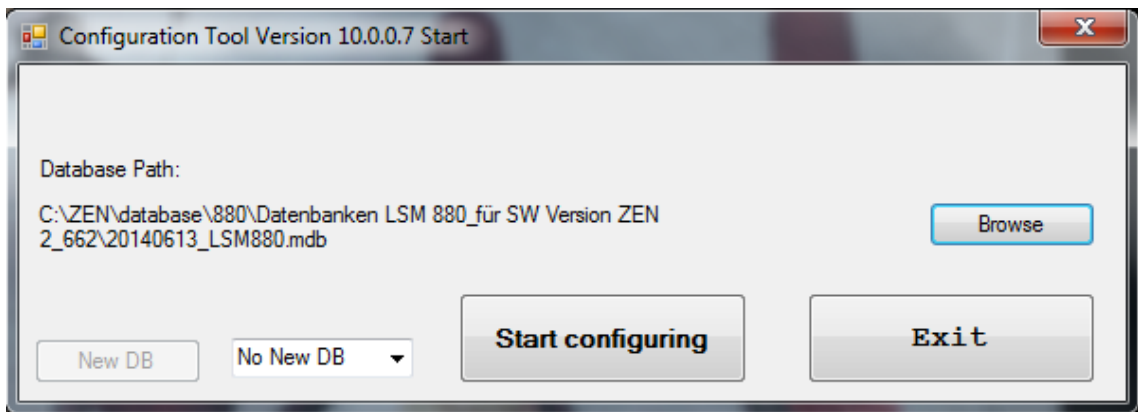


Fig. 11 Configuration Tool for LSM

- In case this is not the right database click **Browse** and choose the database to be configured.
- Click **Start configuring**.

- Within the appearing window (Fig. 12) choose the tabs **Scan Head, LSM 880, Filter**.

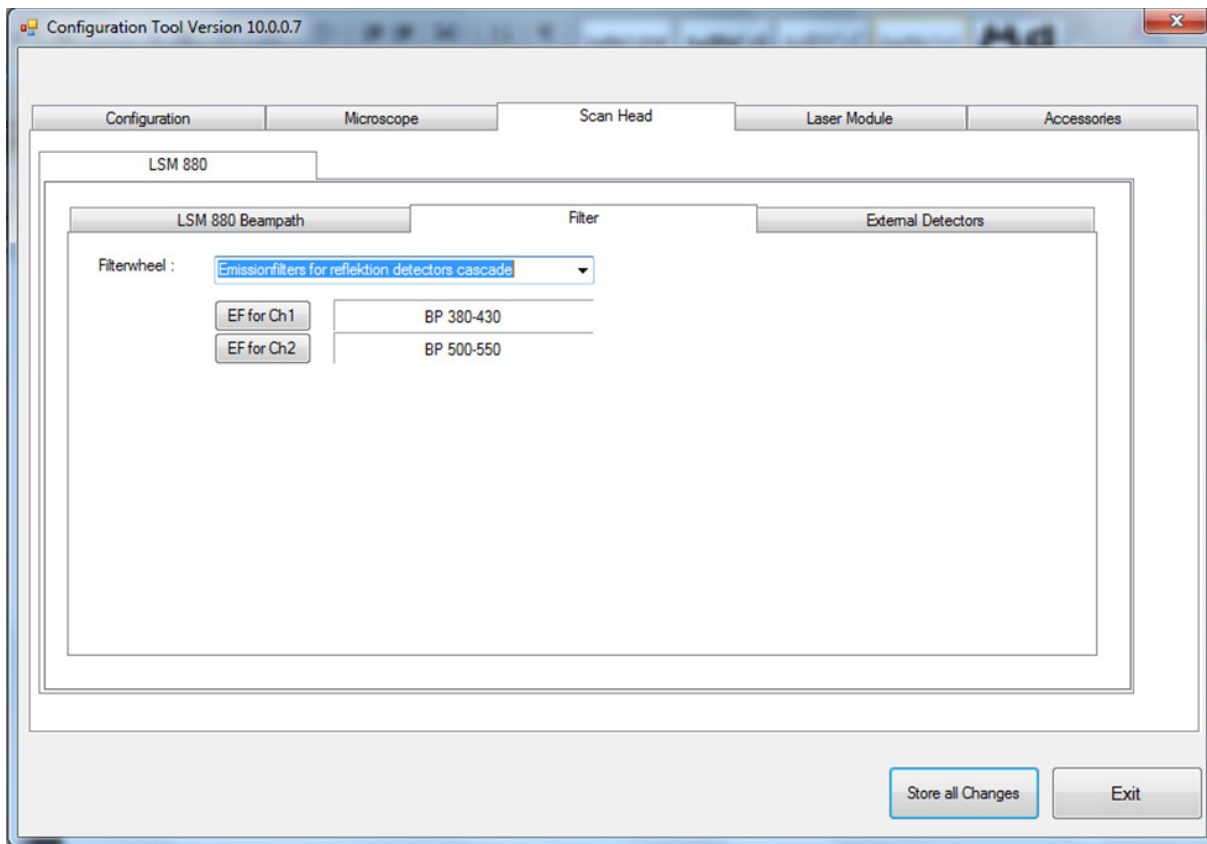


Fig. 12 Configuration Tool with tabs selected for access to filter settings

- Do not change any existing filters or filters from filterwheels inside the scan head. This leads to malfunctions of the system!
- From the drop down list next to **Filterwheel:** choose the device you want to define a new filter for.

This is either "Emissionfilters for DC-Out detectors" (BiG.2 on DCout port), "Emissionfilters for reflection detectors cascade" (any detector used on NDD port for reflection) or "Emissionfilters for transmission detectors cascade" (any detector used on NDD port for transmission) (Fig. 13).

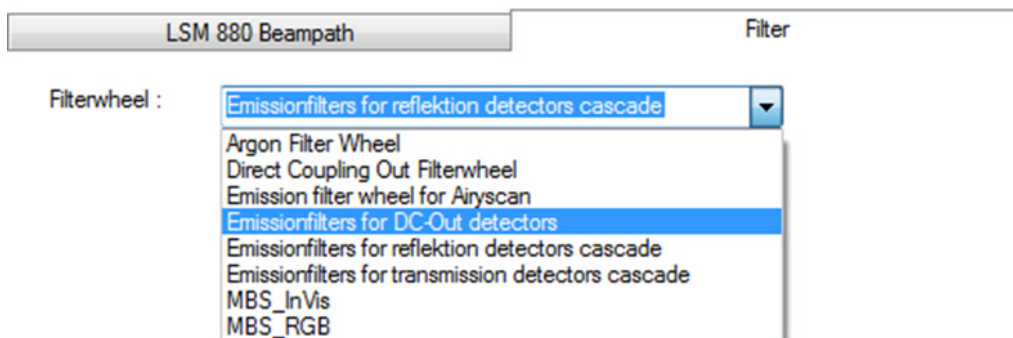
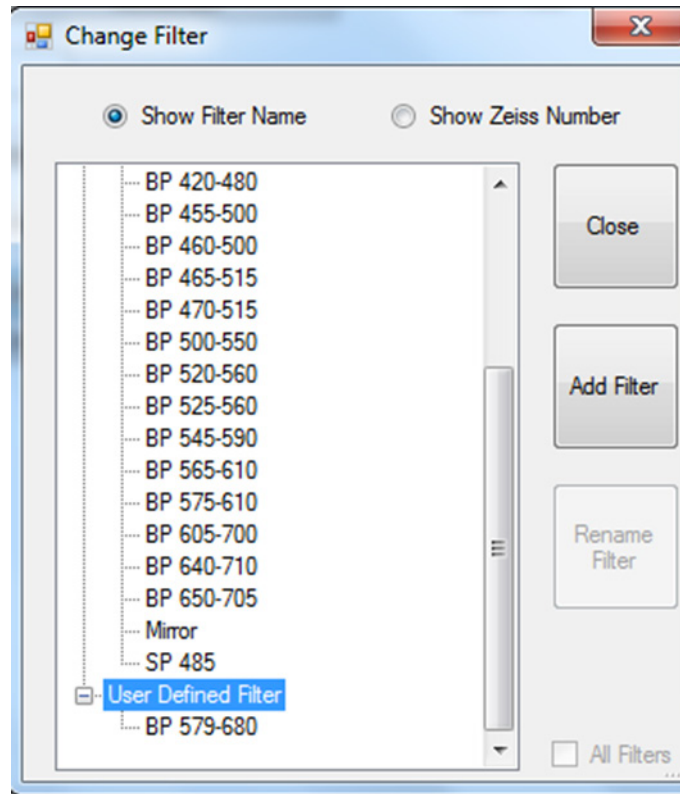


Fig. 13 Options of external detectors for which a new filter might be defined



After selecting the "Filterwheel", the current filters are indicated each with a button next to it referring to the detection channel it is effective for (Fig. 12).

- Clicking this button opens the **Change Filter** window with a list of favourite, potential and user defined filters (Fig. 14).



**Fig. 14** List of Favourite, Potential and User Defined Filters

- To define a new filter, highlight the list point "User Defined Filter".
- The **Add** button becomes active and upon clicking **Add** the **Add new emission Filter** window opens (Fig. 15).

Producer: unknown producer  Non Zeiss

Kind of new filter: Band pass

Filename: BP 579-680

Filter ID/Zeiss Number: 0000

Transmission range(s): 579-680

Average Transmission: 90 per cent

Please insert the average or minimum value in per cent for the transmission within the transmission range.  
For Example: 70 per cent

Apply Close

Fig. 15 Add new emission filter window

- Indicate the new filter as **Non Zeiss** and fill in the form to provide all necessary information to the system so it can use the information for image acquisition and processing.

The form on how to fill in the information is displayed as example in the lower part of the window when editing a special entry.

- Confirm the entry with **Apply** and then close the **Change Filter** window.
- Store all changes to the database before exiting the Configuration tool.

# CHAPTER 4                      ANNEX

## CONTENTS

	Page
<b>1            Software and Hardware Options.....</b>	<b>2</b>
1.1        Software .....	2
1.2        Hardware .....	4
<b>2            Courses on "How to Operate the System in an Optimized Way".....</b>	<b>5</b>
<b>3            Beam Path Configuration Guide for Fluorescence Microscopy .....</b>	<b>5</b>
3.1        Optical Elements in the Configuration Control Window .....	5
3.1.1      Main Dichroic Beam Splitter (MBS) .....	5
3.2        Setup of Tracks Using Single Detectors (Channel Mode).....	6
3.3        Beam Path Configuration for Multi Photon Excitation .....	8
3.4        Acquisition Conditions for RICS.....	8
<b>4            Recommendations for Excitation Laser Lines and Emission Filters of Dyes .....</b>	<b>9</b>
<b>5            How to Access Data Acquired with Airyscan Using Other Software .....</b>	<b>10</b>
<b>6            Piezo Focusing Device.....</b>	<b>11</b>
<b>7            Specification of Trigger-Interface .....</b>	<b>13</b>
<b>8            Level-adjustable Sample Holder with Insert for Piezo Stage (ELYRA).....</b>	<b>18</b>
8.1        Stage Leveling Using X-Cite or Laser in Fluorescence.....	18
8.2        Stage Leveling Using X-Cite in Reflection.....	19
<b>9            Level-adjustable Sample Holder for LSM .....</b>	<b>21</b>
9.1        Stage Leveling Using LSM in Reflection Mode and Focus Drive .....	21
9.2        Stage Leveling Using LSM in Reflection Mode and Z-Piezo .....	22
<b>10          Liquid cooling system of the LSM.....</b>	<b>24</b>
<b>11          Detector overload protection.....</b>	<b>24</b>

## 1 Software and Hardware Options

This section describes optional software and hardware configurations. Depending on your configuration, the content of dialogue and function may differ.

### 1.1 Software

The following software packages for ZEN 2 are available:

- Software "ZEN Module Physiology"
- Software "ZEN Module Visual Basic Macro, VBA"
- Software "ZEN Module Shuttle & Find"
- Software "ZEN Module Experiment Designer"
- Software "ZEN Module 3D VisArt"
- Software "ZEN Module 3D Deconvolution, DCV" (Available in ZEN 2 (blue edition))
- Software "ZEN Module Tiles & Positions"
- Software "ZEN Module FRAP Efficiency Analysis"
- Software "ZEN Module FRET"
- Software "ZEN Module Visual Macro Editor, VME"
- Software "ZEN Module Image Correlation Spectroscopy RICS"

If your configuration does not include the "ZEN Module Physiology", the following functions are not available:

- **Ion Concentration** analysis in **Processing**

If your configuration does not include the "ZEN Module FRAP Efficiency Analysis", the following functions are not available:

- FRAP view type.

If your configuration does not include the "ZEN Module FRET", the following functions are not available:

- **FRET** view type

If your configuration does not include the "ZEN Module Visual Macro Editor, VM", the following functions are not available:

- **VME** button in the **Macro** menu

If your configuration does not include the "ZEN Module Shuttle & Find", the following functions are not available:

- **Shuttle & Find** tool

If your configuration does not include the "ZEN Module Visual Basic Macro, VBA", the following functions are not available:

- **New, Save** and **Save as** buttons in the **Macro Control** window
- **Edit, Step, Delete, Editor** buttons in the **Macro Control** window

If your configuration does not include the "ZEN Module Experiment Designer", the following function is not available:

- **Experiment Designer** tool

If your configuration does not include the "ZEN Module 3D VisArt", the following functions are only available in a basic, stripped down version.

- **3D** view type in the **Image Display** document

If your configuration does not include the "ZEN Module 3D Deconvolution, DCV", the following function is not available in ZEN 2012)

- **DCV** button in **Processing**

If your configuration does not include the "ZEN Module Tiles & Positions", the following function is not available:

- **Stitch** function in **Processing**

If your configuration does not include the "ZEN Module Image Correlation Spectroscopy RICS", the following function is not available:

- **Correlation** function in **Processing**

## 1.2 Hardware

Depending on whether the following hardware components are available or not, the content of the screens may differ:

- Piezo objective focusing device / Z-Piezo stage
- X-Y scanning stage (different types available)
- Axio Observer.Z1 / Axio Imager.Z2 / Axio Examiner.Z1
- Depending on the configuration the scan head equipment may differ in filters, beam splitters and the number of photomultiplier
- Transmitted-light PMT
- Non Descanned Detectors (NDD)

If your configuration does not include the Piezo objective focusing device or the Z-Piezo stage, the following functions are not available:

- **Use Piezo** in the **Z Stack** tool in the left tool area

If your configuration does not include an X-Y scanning stage, the following functions are not available:

- **Stage** tool, **Positions** tool and **Tile Scan** tool in the left tool area

Depending on the used microscope stand: Axio Imager.Z2, Axio Imager.M2, Axio Examiner or Axio Observer.Z1, the following dialogue and available functions may differ:

- Context and accessibility of the **Locate** tab.

If your configuration does not include BiG.2, Airyscan, transmitted light PMT and/or NDD, the following functions may differ:

- Context and accessibility of the **Imaging Setup** tool

If your configuration does not include an AxioCam, the following functions are not available:

- **WF** in the **Imaging Setup** tool, **Channels** tool

---

## 2 Courses on "How to Operate the System in an Optimized Way"

ZEISS is offering training courses on how to operate the system in an optimized way.

- Courses are held in our application center in Jena, Germany.
- Courses are held in English or German language, respectively.

Check out:

**[www.zeiss.de/lsm](http://www.zeiss.de/lsm)**

for the latest dates and ask your Zeiss representative for a quotation on courses.

## 3 Beam Path Configuration Guide for Fluorescence Microscopy

### 3.1 Optical Elements in the Configuration Control Window

All wavelength values are given in Nanometer [nm].

#### 3.1.1 Main Dichroic Beam Splitter (MBS)

- A **MBS XXX/YYY** deflects the indicated laser lines onto the specimen and allows the emitted fluorescent light to pass through.  
Example: MBS 458/514, MBS 488/543/633
- A **MBS XXX+** is a special type of a main dichroic used for IR multiphoton excitation. The **MBS 690+** for example, deflects laser light with a wavelength longer as 690 nm onto the specimen and allows fluorescent emission light in the visible range below 660 nm to pass through.  
Example: **MBS 690+**
- A **MBS XXX/YYY+** is a combination of a MBS XXX and MBS YYY+ used for simultaneous IR multiphoton and single photon excitation.  
Example: MBS 405/710+.

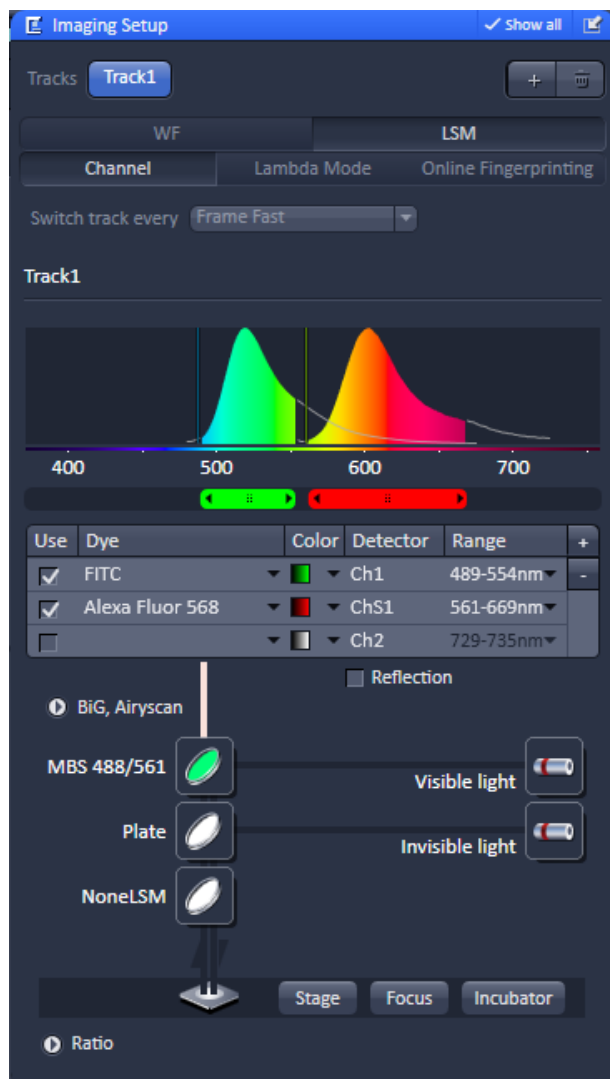


Fig. 1 Imaging Setup tool

### 3.2 Setup of Tracks Using Single Detectors (Channel Mode)

#### a) One track only – simultaneous acquisition of channels

- Switch on the suitable lasers for excitation of the dyes in the specimen in the **Laser** tool. Example: for FITC and AlexaFluor 568 use 488 and **561 nm** for excitation.
- Activate the appropriate laser lines in the **Laser panel** by checking the box of the laser line and set the transmission for each active line using the slider next to the indicated laser wavelength. Example: Select 488 to 0.5% and 561 to 2 %
- Select a main dichroic beamsplitter (MBS) which deflects the selected laser lines to the specimen. Example: MBS 488/561
- Select the proper emission bands in front of the channels and activate channels. Example: select 589 - 554 nm in front of Ch1 and 561 - 669 nm in front of ChS1 (or Ch2).

The active detection bands may not include any of the active laser lines however this will not interfere with imaging.

#### Additional hints:

- Do not forget to turn on the corresponding lasers and detectors.

- Assign appropriate colors to these activated channels. Example: Ch1 - green (for Alexa 488/FITC emission, Ch2 (or ChS1) - red (for CY3 Alexa Fluor 568 emission)

#### b) Multiple tracks – sequential acquisition of channels

Multi-tracking is the method of choice for multi-fluorescence imaging. It allows avoiding artifacts from emission crosstalk that can occur in simultaneous excitation and detection of multiple dyes. To sequentially acquire multiple channels, laser lines are switched very fast and channels are recorded quasi-simultaneously.

The configuration of multiple tracks follows the same rules described above for a single track. The main difference is that each track is configured to excite and detected only one fluorescent dye to prevent cross talk (or two dyes with non-overlapping emission spectra).

- Create a track for Alexa FITC.



- Add a new track by clicking the **+** button next to Tracks in the **Imaging Setup** tool.
- Create a second track for AF 568.
- By selecting the dyes from the pull-down menu, you can see the emission spectra to set the matching detection bands.

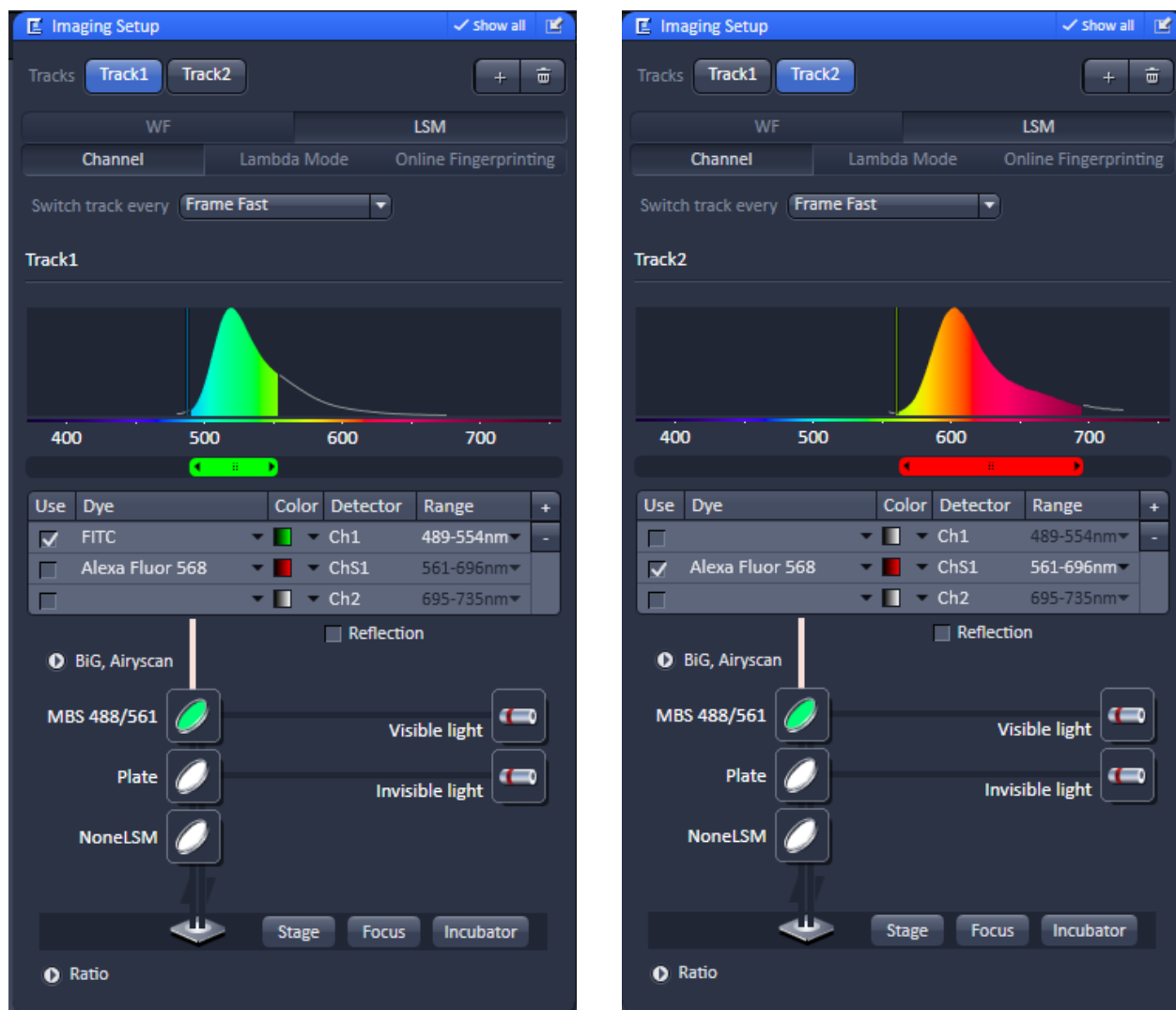


Fig. 2 Imaging Setup tool showing the alternating tracks

### Line and Frame Mode of Multitracking

- Settings can be used for **Line** or **Frame** wise multi-tracking acquisition.
- In Line mode the lines are scanned in turns for all tracks with the corresponding laser lines turned on exclusively. Preferred for living samples with moving objects. Acquisition time can be reduced using bidirectional scan mode.
- In Frame mode, the whole frames are scanned in turns for all tracks with the corresponding laser lines turned on exclusively. This mode can be advantageous for dyes that tend to bleach and need time to recover.
- There are parameters that can be changed quickly in a line wise acquisition: Digital Gain, Digital Offset, Laser Line Attenuation,
- Any other changes of track settings of the selected tracks, e. g. different emission filters, dichroic filters or Detector Gain (Master Gain) settings, need a bit more time to be changed and therefore can be changed only when **Frame** mode is used.
- There is a fast Frame mode, which requires identical settings of these parameters.

### 3.3 Beam Path Configuration for Multi Photon Excitation

- The beam path configuration for multi photon excitation follows the same rules as described for a single and multi-track configuration (see above)
- Use a MBS 690+ or MBS 760+ as main dichroic beam splitter to deflect the IR excitation light (690 or 760-1050 nm) onto the specimen.
- On the detection side, use an additional band pass filter in front of the NDD to prevent a bleed through of IR excitation light to the detector.

### 3.4 Acquisition Conditions for RICS

For RICS the pixel size should be at least 5 times smaller than the PSF of the objective, so appropriate zooms have to be employed.

For the C-Apo 40x objective with a beam radial extension of approximately 0.25  $\mu\text{m}$  zoom factors of 10-20 will guarantee a sufficient size ratio. In addition, scanning speed should not be too high or slow.

As a rule of thumb for solution studies speeds 7-8, for measurements in cytosol and nucleus of 5-6 and for membrane studies of 3-4 will be appropriate.

Expression levels should not be too high. A maximum of 1  $\mu\text{M}$  concentration can be tolerated.

## 4 Recommendations for Excitation Laser Lines and Emission Filters of Dyes

Dye	Laser line/MBS	Emission bands
DAPI	405	> 385/420, max. at 461
EBFP	405	> 385/420, max. at 447
Hoechst	405	> 385/420, max. at 440
Fluoro-Gold	405 or 458	> 420/475, max. at 536
ECFP	405 or 458	> 420/475, max. at 501
Lucifer Yellow	458	> 475, max. at 536
EGFP	477 or 488	> 505, max. at 507/516
FM 1-43™	477 or 488	> 505, max. at 598
Alexa Fluor 488™	488	> 505, max. at 520
Calcium Green	488	> 505, max. at 531
Cy2™	488	> 505, max. at 508
DiO (DiOC18(3))	488	> 505, max. at 508
Fluo-3	488	> 505, max. at 520
Fluorescein (FITC)	488	> 505, max. at 520
Cy3™	514/532	> 530, max. at 566
EYFP	488 or 514/532	> 530, max. at 535
Oregon Green	514/532	> 530, max. at 535
SYTOX Green	514/532	> 530, max. at 536
FM 4-46	514 or 532/543	> 560, max. at 640
Alexa Fluor 546™	532/543	> 560, max. at 572
Calcium Orange	532/543	> 560, max. at 575
Dil (DiI18(3))	532/543	> 560, max. at 565
DsRed	532/543 or 561	> 560, max. at 583
Tetramethylrhodamine (TRITC)	532/543 or 561	> 560, max. at 576
Rhodamine B	532/543	> 560/585, max. at 625
Texas Red™	561 or 594	> 570/600, max. at 620
Alexa Fluor 633™	633/635	> 650, max. at 654
Cy5™	633/635	> 650, max. at 666

## 5 How to Access Data Acquired with Airyscan Using Other Software

There are different ways to access the Airyscan raw pixel data:

- via ZEN black VBA macro interface
- CZI files
- Export to TIFF

### 1) ZEN black VBA macro interface

You can use the "AimImage" object to access the raw pixel data. Use dimension H to discriminate between the raw data channels.

In addition you need to read parameters from the IAiryScanParameters interface (available at AimImage).

Please find the documentation for the VBA macro interface in the user manual.

### 2) CZI files

The raw pixel data is contained in the CZI file in dimension H. If you can read CZI files you can directly access the Airyscan raw data channels. They have 32 entries in the H dimension.

The documentation of the CZI file format can be requested via Zeiss web page:

[http://www.zeiss.com/microscopy/en\\_de/products/microscope-software/zen-2012/czi.html](http://www.zeiss.com/microscopy/en_de/products/microscope-software/zen-2012/czi.html)

Additional Metadata is available in the "IAimImageTrackParameters" interface. Metadata, saved in the czi file, can be read using standard text editor. Scroll over the binary data of the file and find the ASCII metadata. More detailed information on the META data can be provided on request. Please contact your local ZEISS representative.

### 3) Export to TIFF/BMP/etc.

Export the image via the Export function to TIFF or another image format.

During that process the Metadata information is lost. You need to read the Metadata information from the CZI or ZEN (via macro) and store it in order to process the data correctly.

## 6 Piezo Focusing Device

A Z-Piezo allows Z-stacks to be acquired considerably quicker compared to the focus drive of the microscope stand.

The speed advantage depends on the total travel range in Z and the speed of the acquisition of the individual image of a Z-stack.

The available travel range of a Z-Piezo device is much smaller compared to the Z drive of the microscope.

A Piezo device allows performing smaller steps in Z with a higher absolute precision for the individual steps.

A Piezo device is recommended for 3D measurements of objects and for 3D superresolution imaging (Airyscan).

### Piezo Objective Focusing Device

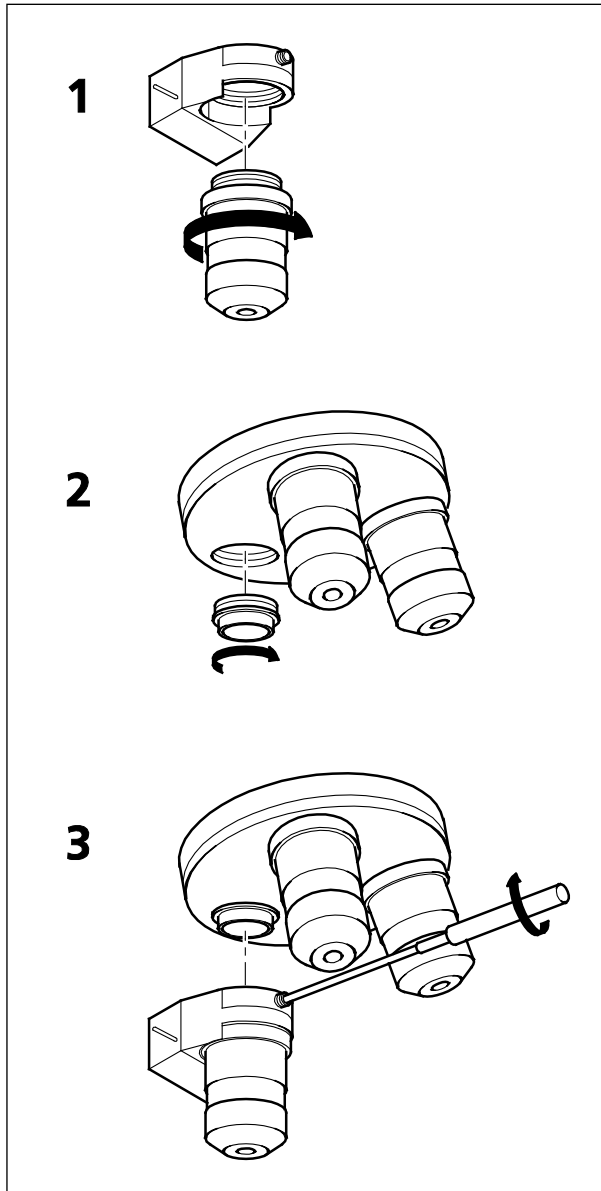
For Axio Imager.Z2, Axio Imager.M2 and Axio Observer.Z1

Range:  $\geq 200 \mu\text{m}$

Minimum step size: 15 nm

Speed:

		<b>Piezo objective focusing device</b>
<b>Slices</b>	<b>Step size [<math>\mu\text{m}</math>]</b>	<b>xz-lines / s</b>
20	0.5	460



**Fig. 3** Installation of the Piezo Objective Focusing Device

Objectives:

- M27

Installation:

- Screw in your microscope objective into Piezo Objective Focusing Device (see Fig. 3/1).
- Screw the thread-ring into your microscope (see Fig. 3/2).
- Easy clamp the Piezo Objective Focusing Device on the thread-ring (see Fig. 3/3).

---

## 7 Specification of Trigger-Interface

The LSM provide two ways to control external devices or be controlled via external devices.

### Synchronization signals:

This interface is provided directly by the electronics of the system and cannot be influenced via the user interface. These signals are always present according to their specification. By connecting to the user interface connector these signals can be used to control external devices or synchronize external devices, like for example pulse generators, with the LSM. The detailed specification of these signals is described below.

The signal itself is identical to the signal of the pixelclock but is only set for one pixel.

### Trigger signals:

The second interface is accessible via the software user interface in the tools **Time Series** and **Bleaching** and can be used to accept or provide signals for the following actions:

- Change interval of time series acquisition
- Set a marker within the time series acquisition
- Start Time Series
- End Time Series (and resume Time series when starting again with TriggerIN)
- Start Bleach event

Each signal itself is identical in length to the signal of the pixelclock but is only set for the time of one pixel.

### Hardware Interface:

- User Port Adapter on the back of the Real Time Electronics in the System Electronic Rack
- Connector 2x **15-point** high density D-Type plug, 1x coax with outer shield (Triax Lemo S. A. Serie 00, EPL.00.650NLN)

### Number of accessible interface signals:

- 4 x signal IN (asynchronous; able to generate an interrupt)
- 8 x signal OUT (synchronous)  
The label synchronous refers to the data stream PCIe2LVDS.  
The label asynchronous refers to the data stream PCIe2LVDS.
- 1x pixel clock

**Connectors:**

Pixelclock = Coax: Triax Lemo S. A. Serie 00, EPL.00.650NLN

Pin	Signal name	Description
Signal	PCLK_Out	PixelClock Output
Signal shield	GND	Digital ground
Outer shield	Shield	Chassis ground

The pixel clock is exactly symmetrical to the pixel. For example if the pixel rate is 10 kHz the high-level and the low level both have a time of 50 microseconds. The width of the TTL pulse therefore is  $1 / (2 \times \text{pixel rate})$ .

**15-point high density D-Type plug: Plug "A"**

Pin	Signal name	Description	Software interface
1	SyncOUT0 synch output	Synchronous output	Trigger 1 out
2	SyncOUT1	Synchronous output	Trigger 2 out
3	SyncOUT2	Synchronous output	Trigger 3 out
4	SyncOUT3	Synchronous output	Trigger 4 out
5	GND	Digital ground	-
6	AsyncOUT0 asynch output	Asynchronous output	-
7	AsyncOUT1	Asynchronous output	-
8	AsyncOUT2	Asynchronous output	-
9	+5 V	Va	-
10	GND	Digital ground	-
11	AsyncIN0 input	input	Trigger 1 in
12	AsyncIN1	input	Trigger 2 in
13	AsyncIN2	input	Trigger 3 in
14	AsyncIN3	input	Trigger 4 in
15	Connector detector*	Input / Connector detector	-



**15-point high density D-Type plug: Plug "B"**

Pin	Signal name	Description	Hardware output only
1	SyncOUT4 ** (stack)	Synchronous output	Sync. signal: Stack out
2	SyncOUT5 out Grabbing	Synchronous output	Sync. signal: Grabbing
3	SyncOUT outline **	Synchronous output	Sync. signal: Line out
4	SyncOUT outframe **	Synchronous output	Sync. signal: Frame out
5	GND	Digital ground	-
6	SyncOUT6	Synchronous output	-
7	SyncOUT7	Synchronous output	-
8	AsyncOUT6	Asynchronous output	-
9	+5 V	Asynchronous output	-
10	GND	Va	-
11	AsyncIN4 input	Digital ground	-
12	AsyncIN5	Asynchronous input	-
13	AsyncIN6	Asynchronous input	-
14	AsyncIN7	Asynchronous input	-
15	Connector detector*	Input / Connector detector	-

\*) If the pin is connected to ground, the software recognizes that at least one connector is connected to the UserPort2.

\*\*) The position of the two switches on the UserPortAdapter inside the RT-PC must switch thrown towards enclosure = default position.

**Timing of the synchronization signals Stack out, Line out and Frame out**

These signals are directly generated by the hardware and cannot be influenced by the software. They are also not seen by the user software and cannot be used to generate any markers within the image acquisition. They are highly precise tools to control external hardware. The signals are precise to the pixel and depending on the chosen pixel time the time between the signal and the start of the image acquisition varies.

The Line, Frame and Stack OUT signal is each set 16 pixels before the first image pixel of each line.

The signal itself is identical to the signal of the pixelclock but is only set for one pixel.

The Grabbing signal OUT is set to high-level with the start of data grabbing and set to low-level with the stop of data grabbing for each line.



The Stack OUT signal is provided at the beginning of each Z-Stack if the Z-Stack is acquired with a Z-Piezo device (Z-Piezo stage frame or objective Piezo device)

**Type/Voltage Range:**

- TTL signal level 3.3 V, CMOS low power consumption
- 5.0 V tolerant input/output for interfacing with 5 V logic

**Load:**

Output: < 50 mA (internal serial 68 ohm resistor)

Input: 4.7 kOhm input impedance (internal 4.7 kOhm pullup to 3.3 V)

**Trigger pulse description:**

Signal output:

- Low level < 0.4 V, high level > 2.4 V (I = 10 mA)
- Slew rate 10 ns/V
- Reaction time trigger OUT 8 msec typical

Signal input:

- Low level <0.5 ... 0.8 V, high level >2.0 ... 5.5 V
- Falling edge force interrupt
- Pulse width to detect signal > 50 ns
- Reaction time trigger IN 16 msec typical

**Caution:**

- Never apply more than 5 V or negative voltages to avoid any damage.
- In and outputs are not galvanically decoupled.
- Therefore proper measures for galvanic decoupling of external devices have to be taken (opto-coupler etc.).

### User interface box for synchronization and trigger signals (optional)

The interface box provides connections to the trigger IN and OUT functions accessible in the software user interface, the synchronization signals and the pixel clock. External devices can be connected to the LSM via standard BNC cables that are plugged into the user interface box. The box itself is delivered with the necessary cables to be connected to the user interface on the realtime electronics.

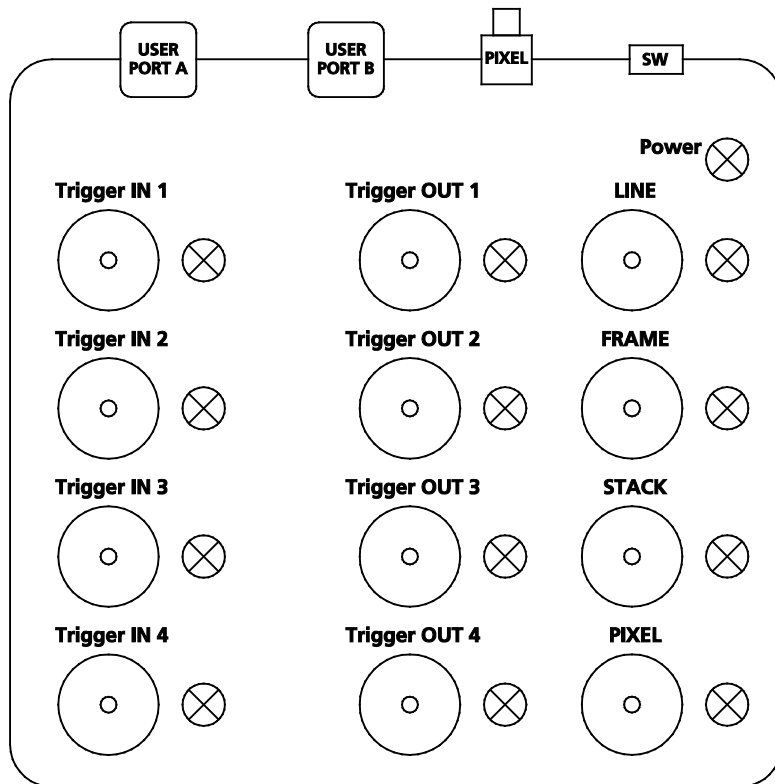


Fig. 4 Panel of the User Interface box

#### Trigger pulse description:

The pulses are identical to the pulses described for the user interface on the realtime electronics.

The LED lights signal the functionality of the individual plugs. The LED lights can be switched on or off with the switch **SW**. A LED blinks if a signal changes with a frequency of more than 2 Hz.

For a positive signal shorter than 500 ms, the LED is on for 500 ms. For a negative signal shorter than 500 ms, the signal is switched off for 500 ms.

The LED follows the level of the signals if these are longer than 500 ms. The LEDs react on pulses which are longer than 30 ns and have a frequency of less than 30 MHz.

## 8 Level-adjustable Sample Holder with Insert for Piezo Stage (ELYRA)



Caution! The adjustment screws and other part of adjustable sample holders may collide with parts of the microscope, e.g. the condenser unit. When moving a motorized stage, avoid any collisions. Do not install inserts while the stage is moving. Be careful when switching the condenser front lens.

### 8.1 Stage Leveling Using X-Cite or Laser in Fluorescence

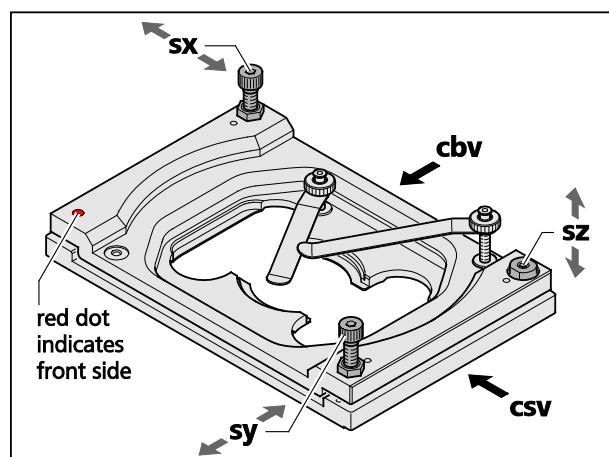


Fig. 5 Adjustable sample holder – schematic view

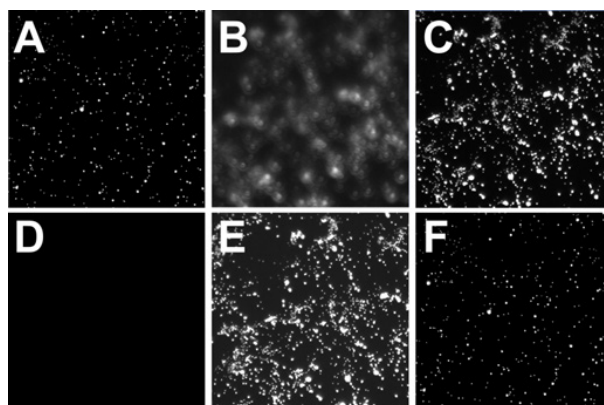


Fig. 6 Focus control in epi-fluorescence

1. Take a fluorescent sample like embedded beads and mount centrally over the objective. (Note: you can also use your own fluorescent sample). Use WF illumination with the X-Cite or laser light and focus manually onto the sample using the stand's focus drive (Fig. 6/A).
2. Set stage to zero by pressing the **Set Zero** button in the **Stage** tool. Set focus to zero by pressing the **Manual** button in the **Focus** tool.
3. Adjust leveling in X in the following way:
  - a) Enter in the **Stage** tool in the **Step [μm]** input box "1000". Press the upper or lower pointing arrow of the **X** input box, whatever is required to step 1000 μm to the right X direction.
  - b) If the sample is out of focus (Fig. 6/B) refocus manually by using the stand's focus drive (Fig. 6/C); otherwise no further leveling is necessary. Record the relative change in the focus position by reading the value in the **Z-Position** input box of the **Focus** tool. If the focus is off more than 10 μm it is recommended to do a pre-adjustment. To this end adjust the edges of the clefts viewed from the right side (Fig. 5/csv) and back side (Fig. 5/cbv) to be parallel using screws **sy** and **sx**, respectively (Fig. 5). The cleft's width should be approximately 2 mm as preset by the factory, but can be adjusted with screw **sz** if needed.
  - c) Multiply that value with **55** and manually set the focus onto this value using the stand's focus drive (Fig. 6/D). (Note: The factor **55** is only accurate, if the sample was positioned in the center.)
  - d) Use the back left screw (Fig. 5/sx) of the sample holder to readjust the focus (Fig. 6/E). Turn clockwise if the focus position was positive, counter clockwise if it was negative. (Note that one turn corresponds to approximately 125 μm).

- e) Press the lower pointing arrow of the **X** input box of the **Stage** tool to return to the initial position. If the image is in focus (Fig. 6/F) X leveling is complete; otherwise repeat steps 3a) - e) iteratively. If applicable, the multiplication factor of 3c) can be adjusted.
4. Adjust leveling in Y in the following way:
- Enter in the **Stage** tool in the **Step [μm]** input box "1000". Press the upper or lower pointing arrow of the **Y** input box, whatever is required to step 1000 μm upwards in the Y direction (Fig. 6/A).
  - If the sample is out of focus (Fig. 6/B) refocus manually by using the stand's focus drive (Fig. 6/C); otherwise no further leveling is necessary. Record the relative change in the focus position by reading the value in the **Z-Position** input box of the Focus tool.
  - Multiply that value with **40** and manually set the focus onto this value using the stand's focus drive (Fig. 6/D). (Note: The factor **40** is only accurate, if the sample was positioned in the center.)
  - Use the front right screw (Fig. 5/sy) of the sample holder to readjust the focus (Fig. 6/E). Turn clockwise if the focus position was positive, counter clockwise if it was negative. (Note that one turn corresponds to approximately 125 μm).
  - Press the lower pointing arrow of the **Y** input box of the **Stage** tool to return to the initial position. If the image is in focus (Fig. 6/F) Y leveling is complete; otherwise repeat steps 4a) - e) iteratively. If applicable, the multiplication factor of 4c) can be adjusted.

## 8.2 Stage Leveling Using X-Cite in Reflection

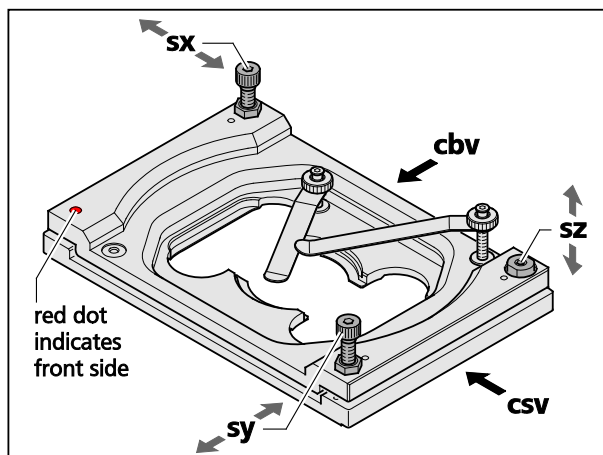


Fig. 7 Adjustable sample holder – schematic view

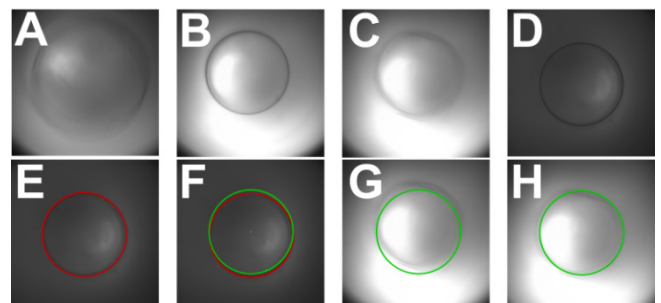


Fig. 8 Focus control in reflection

- Assemble a fluorescent sample you want to level with sample bottom downwards into the sample holder. The sample site should be clean and free of any immersion oil. Position the sample such that the objective lens is in the middle of the sample. Use WF illumination with the X-Cite at 12 % and filter for excitation with the 561 nm line (optimal would be a small band pass to avoid too much light). Swing nosepiece to empty position (make sure no cover is in the empty position) and use preferentially Andor SIM camera, albeit the Andor PALM camera would also work. Take Optovar 1.0 and set EM gain to zero.

2. Draw fiber plug of X-Cite completely out from the X-Cite casing. Start acquisition. The image will be dark since fiber was pulled out. Put fiber back and slowly move in until you will see a coarsely adjusted image to have sufficiently reduced light levels you can work with (Fig. 8/A). (Note: with the fiber all in, the lamp is simply too bright leading to oversaturation of the camera). If the illumination is far from being centric, the sample is already strongly tilted and it is recommended to do a pre-adjustment. To this end adjust the edges of the clefts viewed from the right side (Fig. 7/csv) and back side (Fig. 7/cbv) to be parallel using screws **sy** and **sx**, respectively (Fig. 7). The cleft's width should be approximately 2 mm as preset by the factory, but can be adjusted with screw **sz** if needed.
3. Now pull (or push) fiber on the ELYRA site until the dark ring, which is already faintly visible in its contours, appears focused (Fig. 8/B). Dependent on the sample the focus could look worse, especially when the reflecting planes are wavy or you get reflection from different planes (Fig. 8/C).
4. Move in 10x objective and focus the already visible ring with the z-drive of the stand. The ring appears now well focused as long as the sample is not completely unsuitable (Fig. 8/D).
5. Mark the Ring with a ROI from the **Graphics** tool (3 point-circles will work best) (Fig. 8/E).
6. Mirror the circle on the center of the image. (Note: If the circle is already centered in the middle that step is not required; deviations <20 pixel SIM camera or 10 pixel Palm camera are no problem and can be tolerated). To mirror the coordinates of the ROI **X, Y** (visible in the **Graphics** tab), calculate the new values as follows:  $X' = X_{max} - X$  &  $Y' = Y_{max} - Y$  with  $X_{max}$  and  $Y_{max}$  representing the number of pixels of the camera in X and Y-direction. E.g. if the coordinates X and Y would have been 502 and 512, respectively, the new coordinates X' and Y' would be calculated using the SIM camera to  $1004 - 502 = 502$  and  $1002 - 512 = 490$ .
7. Draw a new circle with the same diameter in the original image with the new coordinates (Fig. 8/F). The old circle is not necessary anymore and can be switched off or deleted (Fig. 8/G).
8. Turn nosepiece back to free position. Then level stage by turning the screws of the sample holder (Fig. 7/sx & sy) until the more or less focused circle of the fiber overlaps with the ROI-circle (Fig. 8/H).

## 9 Level-adjustable Sample Holder for LSM



Caution! Adjustable stage insert screws may intersect with parts of the microscope, e.g. the condenser unit. When moving a motorized stage, avoid any collisions. Do not install inserts while the stage is moving. Be careful when switching the condenser front lens.

### 9.1 Stage Leveling Using LSM in Reflection Mode and Focus Drive

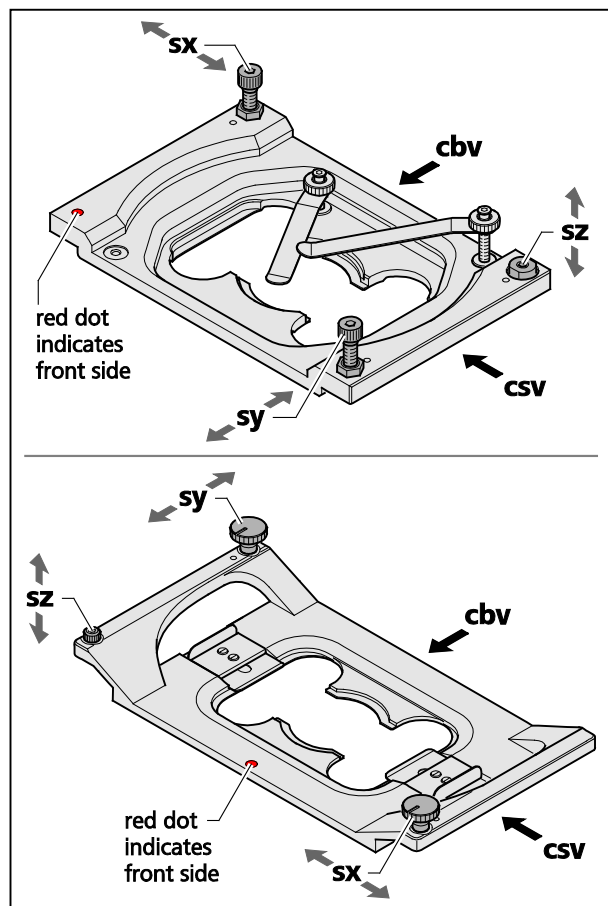


Fig. 9 Adjustable sample holder – schematic view

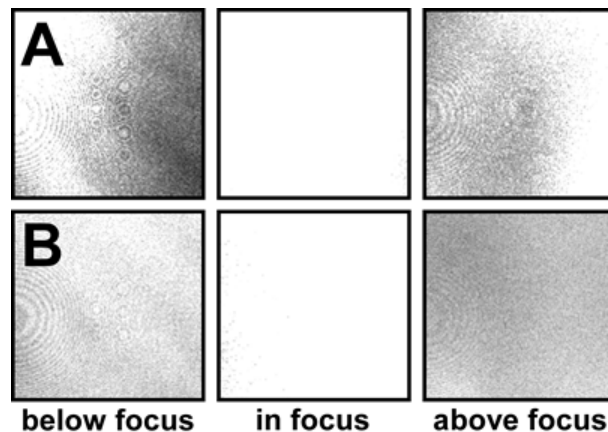


Fig. 10 Focus control with focus drive. Course of reflection on tilted (A) and even (B) coverslip when moving focus upwards (left to right)

0. Adjust the edges of the clefts viewed from the right side (Fig. 9/**csv**) and back side (Fig. 9/**cbv**) to be parallel by using screws **sy** and **sx**, respectively (Fig. 9). The cleft's width should be approximately 2 mm as preset by the factory, but can be adjusted with screw **sz** if needed.
1. First locate the area of interest of your sample. It is important to level the sample in the same region as the actual measurements, as the coverslip may be bent or tilted at other locations.
2. Prepare a LSM reflection image with the pinhole diameter to 1 AU.

3. Start a reflection scan at zoom 1.0x and focus on the border between coverslip and sample, which can be identified by the brightest reflection. A high pixel resolution is not important (use e.g. the 256x256 image format). The border will appear as a very bright uniform signal when focusing. Adjust the detector gain and laser power (the laser power likely will be below 1 %). The maximum intensity should be between 1,000 and 3,000 when using a 12Bit data depth. If very thin samples are used, be cautious to get the reflection of the sample-coverslip border and not e.g. the sample-slide border.
4. Activate the Z-Stack acquisition checkbox. Switch to center mode and set up a Z-Stack with about 80 slices and an interval of 0.2  $\mu\text{m}$ . Click on the 'Center' button and the start the Z-Stack. Alternatively focus continuously up and down manually using the focus drive without using a Z-Stack in Continuous mode.
5. Check for the tilt of the coverslip border. If the picture gets uniformly brighter and darker when focusing through the coverslip border, the stage is leveled. Any tilt will appear as a brightness gradient or even a bright zone or line that wanders through the slices (Fig. 10).
6. Adjust the adjustment screws of the sample holder. Turn screw **sx** for the tilt along the **x**-axis and screw **sy** for the tilt along the **y**-axis until you observe visually an even reflection image (Fig. 9). You might need to re-adjust the z-range when turning the screws. Screw **sz** will only have to be adjusted in case the range of screws **sx** and **sy** is not sufficient.
7. If you use a defined z-scan repeat steps 4. through 6. until you achieve a good result. If you focus manually, turn screws until reflection looks even (Fig. 10/B).

## 9.2 Stage Leveling Using LSM in Reflection Mode and Z-Piezo

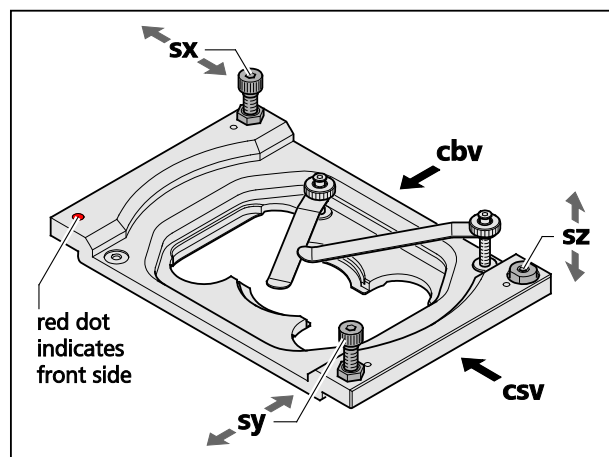


Fig. 11 Adjustable sample holder – schematic view

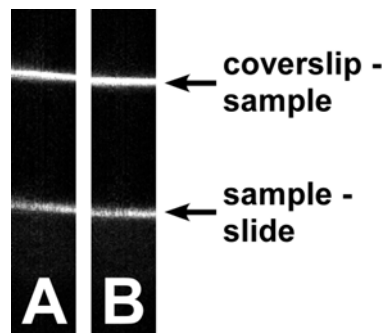


Fig. 12 Focus control with z-Piezo. Reflections on tilted (A) and even (B) coverslip

0. Adjust the edges of the clefts viewed from the right side (Fig. 11/**csv**) and back side (Fig. 11, **cbv**) to be parallel by using screws **sy** and **sx**, respectively (Fig. 11). The cleft's width should be approximately 2 mm as preset by the factory, but can be adjusted with screw **sz** if needed.
1. First locate the area of interest of your sample. It is important to level the sample in the same region as the actual measurements, as the coverslip may be bent or tilted at other locations.
2. Prepare a LSM reflection image with the pinhole diameter to 1 AU.



- 
3. Start a reflection line z scan at zoom 1.0x and focus on the border between coverslip and sample, which can be identified by the brightest reflection line. A high pixel resolution is not important (use e.g. the 256x1line format). Adjust the detector gain and laser power (the laser power likely will be below 1%). The maximum intensity should be between 1,000 and 3,000 when using a 12Bit data depth. If very thin samples are used, be cautious to get the reflection of the sample-coverslip border and not e.g. the sample-slide border.
  4. Activate the Z-Stack acquisition checkbox. Switch to center mode and set up a Z-Stack with about 80 slices and an interval of 0.2 $\mu$ m. Activate z-Piezo. Click on the 'Center' button and start the Z-Stack with a long time series. Use Corr X, Corr Y and Corr Z to remove jitter as much as possible.
  5. Check for the tilt of the coverslip. If the reflection line is horizontal the coverslip is not tilted in the x direction (Fig. 12/A). Any tilt will appear as a sloping line (Fig. 12/B). We recommend choosing a z/x ratio of 10 to make the tilt more evident in the image.
  6. Adjust the adjustment screw **sx** of the sample holder until the reflection line is horizontal (Fig. 11). You might need to re-adjust the z-range when turning the screw.
  7. Rotate image clockwise by 90 degrees. Adjust the adjustment screw **sy** of the sample holder until the line reflection is horizontal. You might need to re-adjust the z-range when turning the screw. Screw **sz** will only have to be adjusted in case the range of screws **sx** and **sy** is not sufficient.

## 10 Liquid cooling system of the LSM

The temperature of the scanners within the LSM scan head is controlled with a liquid cooling system. The liquid cooling system is also used to dissipate the heat generated by the electronics and the additional Peltier cooling of the detectors (GaAsP PMT detectors as well one of the side multi-alkali PMTs).

The liquid used for the device can be ordered via ZEISS service.

The system is equipped with an optic and acoustic warning if it does not function as needed. The following error code, which is also indicated on the unit itself, applies:

**Green LED** flashing or constant: System is working

**Red LED flashing once:** Cooling liquid is too warm. Check the temperature in the room. It should be at 22 °C plus/minus 3 °C. If it is more than 30 °C the cooling system cannot work.

**Red LED flashing twice:** Cooling liquid level is too low. Add liquid to the system.

**Red LED flashing three times:** Cooling fan is failing. Call service for maintenance.

**Red LED flashing four times:** No cooling liquid is in the system. Fill the system with liquid.

A corresponding acoustic signal is provided along with the optic signal.

It is recommended to exchange the liquid every two years. Refilling frequency is dependent on room conditions and adding liquid might be necessary more often.

In case the temperature within the scan head rises above 50 °C at any measuring point, the system will show a warning and shut itself down. Check the liquid cooling system before restarting the system.

## 11 Detector overload protection

Strong light impact over longer time periods can lead to temporary higher dark noise of a PMT (GaAsP or Multi-alkali) detector or even damage the detector. All detectors of the LSM are protected against high light doses. If too much light hits the detector the voltage is down-regulated. The time of down-regulation is dependent on the amount and duration of the light over dose. A down-regulation is indicated within the image as a white pixel – typically some portion within the scanned line following a bright object.

In case the light dose is much too high, the detector is shut down automatically and stays shut down. A warning is indicated in the status bar when this occurs. Reduce laser power and/or gain before starting the next image scan.

## CHAPTER 5

# MULTIPHOTON LASER SCANNING MICROSCOPY WITH LSM FAMILY SYSTEMS

## CONTENTS


	Page
<b>1</b>	<b>NLO (Non Linear Optics) Laser for LSM ..... 2</b>
1.1	Laser Control tool..... 3
1.2	Imaging Setup and Channels tool ..... 4
1.3	Motorized Periscope ..... 5
1.3.1	Instructions for beam adjustment using the motorized periscope ..... 6
1.4	Pinhole and Collimator Settings ..... 11
<b>2</b>	<b>Non Descanned Detection (NDD) ..... 12</b>
2.1	Thickness of optical slices using multiphoton excitation and non descanned detection ..... 12
2.2	Mounting and Dismounting of NDD modules from the NDD port..... 13
2.3	Electronic Connection of NDD modules..... 13
2.4	Filter for non descanned detectors (NDDs)..... 16
2.5	Changing the Filter Modules BiG.2..... 22

## 1 NLO (Non Linear Optics) Laser for LSM

The LSM scanning module is operated with a Titanium-Sapphire-Laser and optionally in combination with an optical parametric oscillator (OPO) to perform Multiphoton Microscopy. Depending on the type of laser the following operation procedures apply:

- The operation of software controlled lasers (Chameleon laser from Coherent or Mai Tai laser from Spectra Physics) is integrated into the LSM software.
  - Both lasers should be kept in Standby mode for daily or weekly operation. The cooling of the laser must not be shut down during stand by. Only in case of more than two weeks without operation the laser should be shut down completely. This has to be performed according to the operation manual for the laser provided by the manufacturer. The shut down and the start procedure can take up to one hour.
  - Specific for the operation of Chameleon lasers (Coherent; for further details please refer to the operators manual of the laser):

The key on the front panel of the laser power supply is used for switching between Standby mode and Operation mode. The Chameleon laser has to be in Operation mode and **On** (see sections 1.1 and 1.2) to be able to pump the OPO.

-  The laser has to be in Operation mode in order to control it with the LSM software.
  - Specific for the operation of Mai Tai lasers (Spectra Physics; for further details please refer to the operators manual of the laser):

The laser is put to **Operation** mode or Stand by mode using the LSM software. Therefore no further operation of the laser via the laser power supply and electronics unit is needed. The key on the front panel of the laser power supply can also be used to put the system from Standby to ON. It is also an interlock key. When the key is removed the system cannot be operated. The key needs to be in ON position to be able to control the laser with the software. The power switch on the laser electronics has to be kept **On** for leaving the laser in Standby.

## 1.1 Laser Control tool

The **Laser Control** tool shows the NLO laser as an additional laser of the system.

### Operation of the Chameleon (Coherent), OPO and Mai Tai (Spectra Physics) laser

- Click **On** to activate the laser for the software. The laser is put from Standby to Operation mode (MaiTai lasers from Spectra Physics) and the power ramps up. Chameleon lasers from Coherent have to be switched from Standby to Operation mode via the interlock key on the laser electronics. This takes a few minutes until the laser is ready. The system now has access to the laser and reads out the actual status of the laser. Switching a Chameleon laser to **On** in the **Laser** tool opens the shutter inside the laser and only then it can pump an OPO (if available). For the highlighted laser the arrow drop down menu provides information of the laser status. The laser has to be mode locked for operation and for pumping the OPO.
- If the laser is equipped with a pre-compensation unit (prechirp unit) like the versions: Chameleon Vision or Mai Tai DeepSee, a slider and edit box show up in the **Laser Properties** panel allowing to set the GDD value to a different position. The system is delivered with a preset calibration curve for the GDD values. If that does not represent the optimal values for the specific laser the values can be changed and stored. The values will then be set to the newly defined value for the corresponding wavelength.

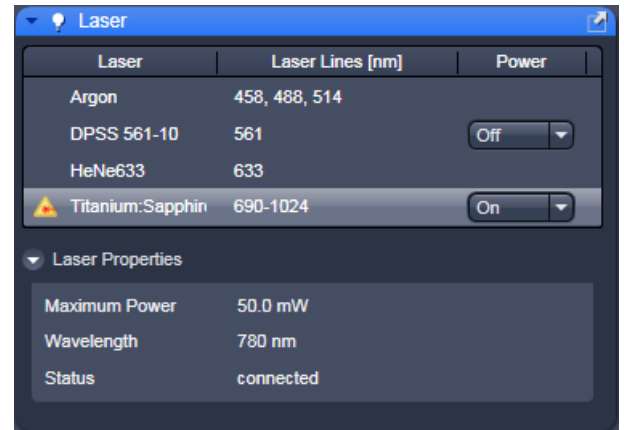


Fig. 1 Laser control tool

### Control of laser optimization

Chameleon lasers perform a constant optimization of the laser power output in relation to the wavelength setting.

This can lead to slight but maybe visible intensity fluctuations in the image especially following changes in wavelength.

To avoid having this affecting the image quality ZEN can control this process in conjunction with image acquisition.

To enable this procedure, activate the **Control Laser Optimization** function in the **System Options** tool/**Hardware** tab (Fig. 2).

The optimization procedure will then not take place if an image is acquired but either before or after the acquisition.

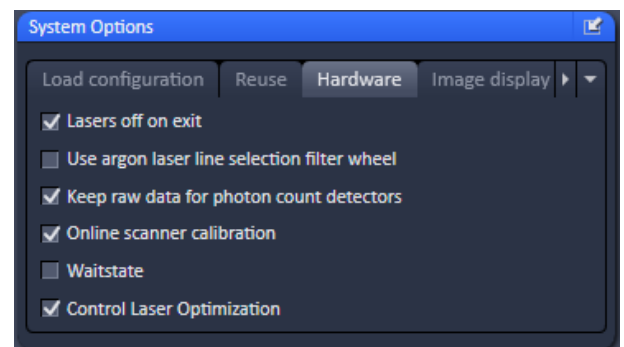



Fig. 2 System Options tool

## 1.2 Imaging Setup and Channels tool

- Setting the wavelength of the laser/OPO
  - The wavelength of the laser and OPO can be set in the **Imaging Setup** tool in the pop up window of the laser icon or in the **Channels** tool. Enter the desired wavelength for the laser and the OPO in the input box. The OPO can only be pumped at certain laser wavelengths typically between 780 and 850 nm. This is dependent on the type of laser used for pumping the OPO. Refer to the manual of the OPO for further information. The software shows the status of the laser and the OPO in the **Laser** control tool (see section 1.1)
  - The laser intensity (transmission through an Acousto-Optical Modulator, AOM) is controlled in the laser control pop up from the **Imaging Setup** tool or in the **Channels** tool. The intensity of the OPO is controlled via a manual neutral density filter. Changing the intensity is possible via a slider in the **Imaging Setup** tool or the **Channels** tool.
-  Note: With the ND filter as attenuator it is not possible to perform a line or frame fast Multitrack or to bleach arbitrary ROIs other than rectangular regions.

Application of the NLO laser requires special main dichroic beam splitters to be activated in the **Imaging Setup** tool.

NLO-excited signals can be detected in every channel. However, it is important to efficiently block NIR (near infrared) excitation stray light from the detector.

The following filters are designed for detection of NLO-excited fluorescence signals:

- **MBS 690+**: main dichroic beam splitter reflecting NIR excitation at 690 nm and above, transmitting shorter wavelengths
- **MBS 750+**: main dichroic beam splitter reflecting NIR excitation at 750 nm and above, transmitting shorter wavelengths
- **MBS -405/760+**: main dichroic beam splitter reflecting NIR excitation longer than 760 nm, transmitting shorter wavelengths and reflecting 405 nm excitation for simultaneous detection of signals from NIR and 405 excited fluorochromes.

### 1.3 Motorized Periscope

- Systems with OPO or two lasers coupled into one scan head are equipped with a motorized periscope. The interface for controlling the motorized mirrors within the periscope is in the **Maintain** tab/**System Options** tool. Scroll to the Motorized Periscope tab in the tool (Fig. 3). A pair of mirrors is related to each one of the lasers or to the OPO. Input addresses the mirror at the entry of the periscope. Output addresses the mirror at the exit of the periscope next to the scan head. For each mirror two axis can be controlled via the arrows in the corresponding line. Corrections should only be done in small steps and should only be necessary for controlling the overlay of the two beams if beams are to be used for the excitation of the same area simultaneously or sequentially. If the beam is lost by operating the arrows it might be necessary to get a service engineer for completely realigning the beam.
- Optionally the periscope can be equipped with photosensitive diodes (auto-alignment function) providing the function of resetting the beam to the preset positions. The optimal position for the overlay of the two beams is set by the service engineer at installation. In the **Channels** tool a button is present (**Align active Beams**, Fig. 4). Clicking the button will move the mirrors such that the active beam(s) is/are again at this predefined position.

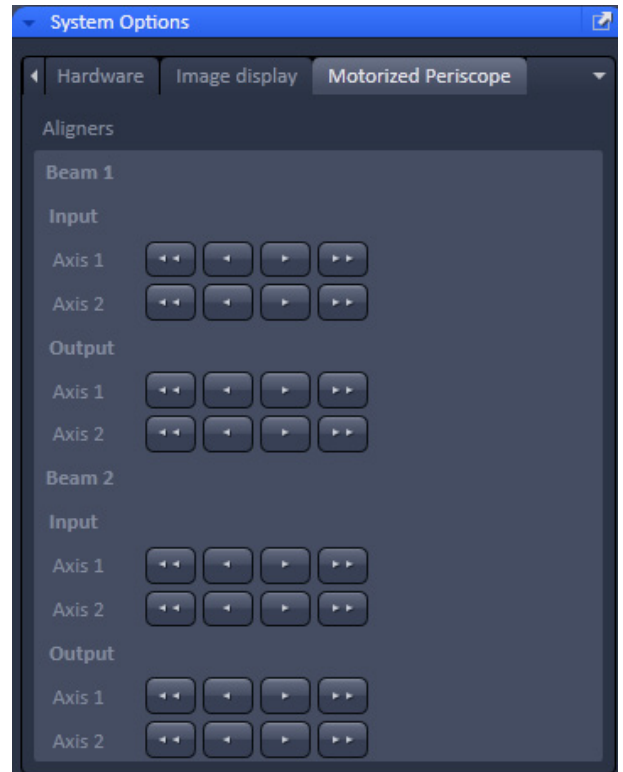


Fig. 3 Motorized Persicope panel

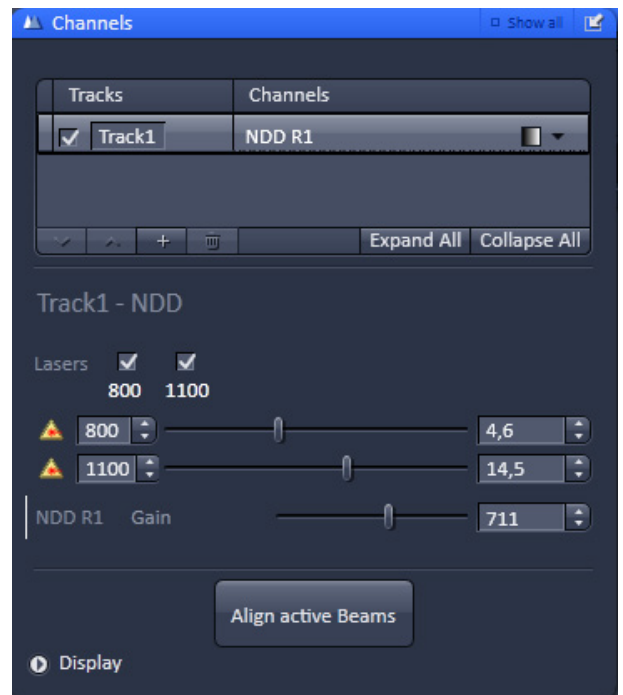


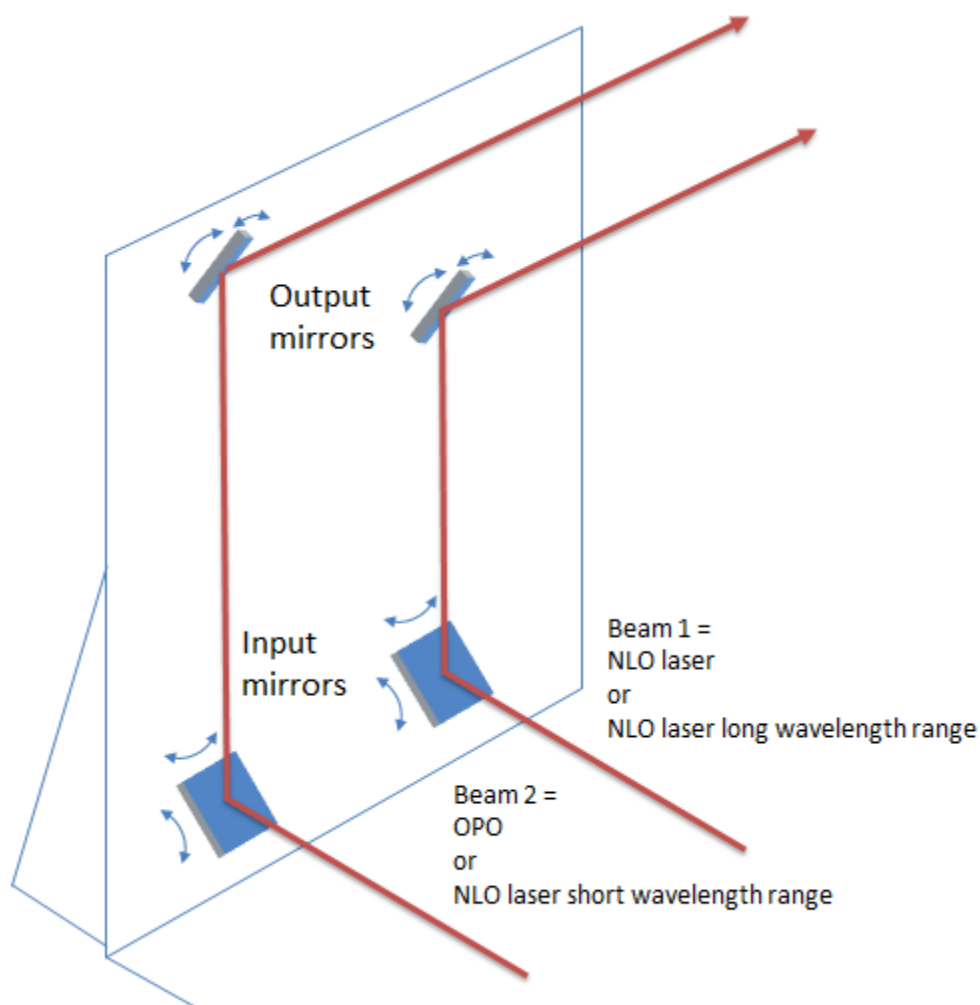
Fig. 4 Channels tool with laser and OPO activated showing the Align active Beams button

### 1.3.1 Instructions for beam adjustment using the motorized periscope

Your system is equipped with a periscope that provides motorised mirrors for the guidance of two beams of light of either two NLO lasers or one NLO laser and one OPO.

For each beam of light there are two mirrors, one mirror at the entry position of the beam into the periscope, called "input mirror" and one mirror at the exit position of the periscope towards the scan head called "output mirror". Each mirror can be moved in two axes corresponding to the vertical and horizontal dimension. These mirrors allow optimizing the position of the acquired image and the optimization of the illumination profile of this image.

It might be necessary to optimize the image position and/or illumination due to deviations of the laser beam pointing especially after tuning the laser and/or OPO.



The SW interface to operate the mirrors is located in the **System Options** tool under the **Maintain** tab. Scroll to the **Motorized Periscope** panel to have the dialogue available. Disconnect the Tool from its position to have the dialogue visible also when working in the Acquisition Tab.

**Important:** Make sure you always have a clearly visible image (Live or Continuous scan) created by the beam that you are going to adjust using the Motorized Periscope Panel. Buttons with two arrows do make a large movement of the mirror along this axis and this might lead to a loss of the beam/ the image if not operated carefully.



### Motorized Periscope Panel

This panel provides the interface to control the motorized mirrors in the periscope

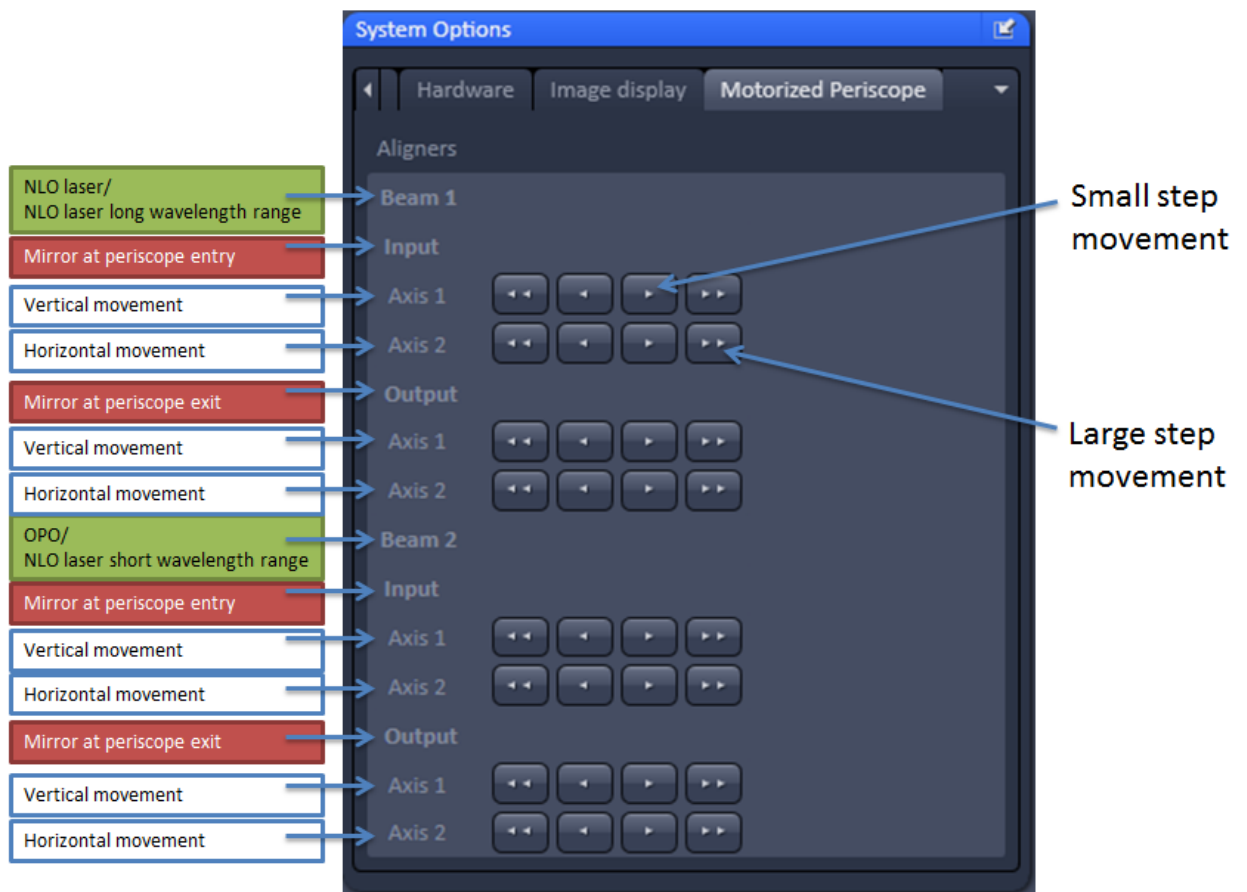
Beam 1 and Beam 2 represent the two input beams according to the following constellation:

Laser system	Beam 1	Beam 2
NLO laser + OPO	NLO laser	OPO
NLO laser + NLO laser	NLO laser long wavelength range	NLO laser short wavelength range

Input and Output correspond to the position of the mirror inside the periscope as described above.

Each axis of each mirror can be controlled independently. For each axis four buttons are available, two for each direction. Axis 1 represents the vertical movement of the beam in the two directions. Axis 2 represents the horizontal movement of the beam in the two directions.

Buttons with **one arrow** cause a **small step movement** of the mirror along the corresponding axis. Buttons with **two arrows** cause a **large step movement** of the mirror along the corresponding axis.

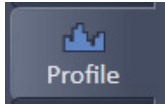


---

The following procedures describe how to adjust positioning and illumination for the acquired images using the ZEN software.

### 1.3.1.1 Correction of the illumination profile

The illumination profile indicates whether there is an angular offset of the beam when scanning the sample. A representation of the illumination profile is depicted when using the profile view tab.



The profile line drawn across the image shows the distribution of the image intensity over the field of view. The image intensity should be centred in both the horizontal and vertical dimension, respectively.

#### **The illumination can be centred using the output mirrors only.**

- The vertical position of the intensity profile plateau is adjusted by clicking on the buttons representing Axis 1.
- The horizontal position of the intensity profile plateau is adjusted by clicking on the buttons representing Axis 2.

### 1.3.1.2 Correction of image position

If a sample is excited using two NLO lasers or an NLO laser and OPO, the corresponding two images may have a slight offset with respect to each other. This indicates a lateral shift of one of the beams. The easiest method to correct for this shift is to align one of the beams while the other one is kept fixed. This is done under observation of the images acquired in Continuous or Live scanning mode.

1. Use a sample with small distinct objects like beads, that can be excited with both wavelengths applied.
2. Set up a frame wise multitrack where the first track produces the image with one beam, and the second track produces the image with the other beam.
3. Use the same detector without an emission filter in place as to collect all the fluorescence of the sample.
4. Use different colours for the images of the two tracks to be able to distinguish the two images.

For example if the NLO laser / Beam 1 shall be aligned with the OPO beam/ Beam 2, then Beam 1 can be adjusted according to the following procedure (see next pages):

**Horizontal shift of the image generated with Beam1 (NLO laser) to the right**

(To shift the image horizontally to the left, just use the reverse direction buttons):

1. Click on the right "fine movement" button of Beam1/Output/Axis2 repeatedly until an image shift and illumination change is visible (image gets darker).
2. Now click on the right "fine movement" button of Beam1/Input/Axis2 repeatedly until the image is bright again.  
 -> The image generated by the NLO laser now has shifted a small distance to the right.
3. Repeat steps 1 & 2 until the images of both beams are aligned horizontally.

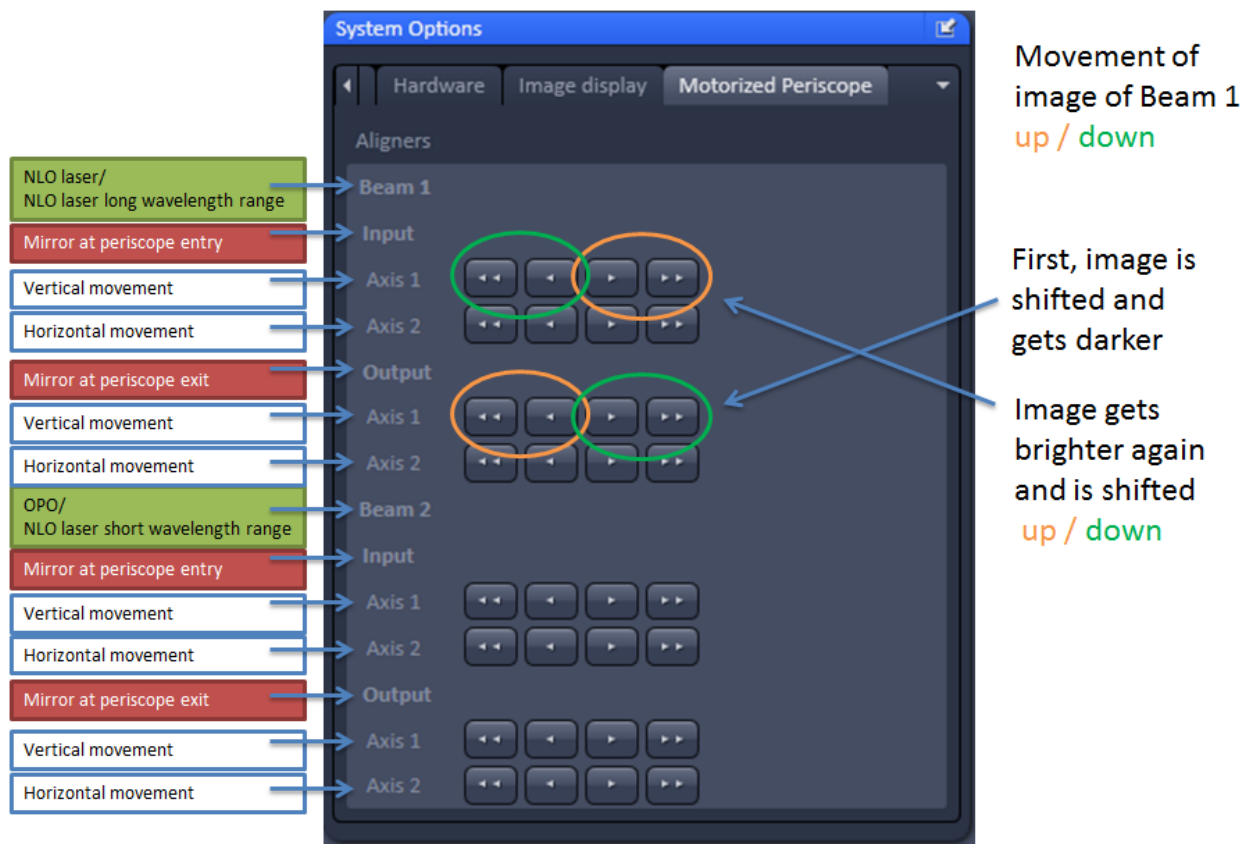
If the offset is quite large, use the coarse buttons (not more than one click at once).


### Vertical shift of the image generated with Beam1 (NLO laser) downwards

(To shift the image upwards, just use the reverse direction buttons):

1. Click the **right** "fine movement" button of Beam1/Output/Axis1 repeatedly until an image shift and illumination change is visible (image gets darker).
2. Now press the **left** "fine movement" button of Beam1/Input/Axis1 repeatedly until the image is brighter again. The image generated with the NLO laser is now shifted a bit downwards.
3. Repeat steps 1 & 2 until the images of both beams are aligned vertically.

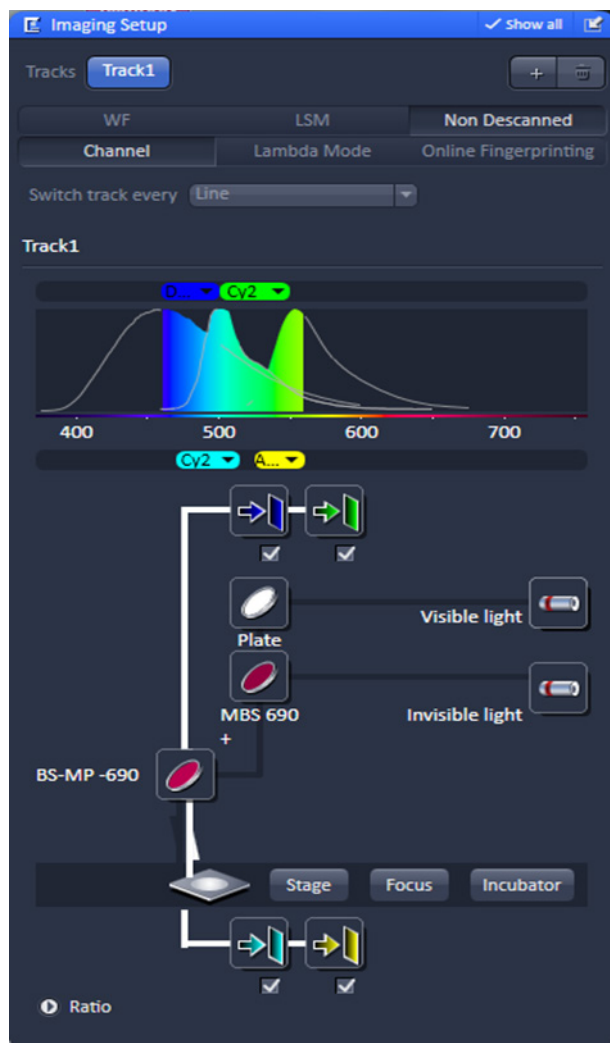
If the offset is quite large, use the coarse buttons (not more than one click at once).



 **After correction of the alignment, it may be necessary to again correct the illumination profile.**

## 1.4 Pinhole and Collimator Settings

- The pinhole can be fully opened for maximum detection efficiency due to the intrinsic optical sectioning capabilities of the NLO effect (see **Channels tool**).
- In the **Adjust Pinhole & Collimator** tool, the **NLO** collimator can be used to align the overlap of the excitation planes within the object for VIS as well as NLO excitation light.
- Select the NLO collimator in the **Collimator** panel. It is best to use a fine structured object like beads which are excited with visible lasers and the NLO laser.
- Focus on the bead and acquire an image with the visible laser, for example 488 nm excitation. Keep the image and open a new image document in a separate image container.
- Then switch to the NLO laser and start a continuous scan.
- Activate the Profile View tab.
- Move the position of the collimator (detaching the tool window so it is visible) such that the intensity of the bead is at its maximum and matches the image of the bead taken with the visible laser.
- Now the excitation planes are matched between the visible and the NLO laser.



**Fig. 5** Light Path tool with NDD detectors (2 in reflection, 2 in transmission) on Axio Examiner

## 2 Non Descanned Detection (NDD)

The use of Non-Descanned Detectors with the LSM 880 NLO is only useful in combination with the NLO laser.

The Non-Descanned Detection modules can be used on the reflected or transmitted-light beam path (transmission NDDs not available for Axio Imager) or simultaneously on both beam paths. This means that up to 10 NDD channels (depending on the microscope used) can be configured. If NDD channels have been assigned to the transmitted-light beam path on Axio Observer, no transmission PMT can be implemented.

In Non-Descanned Detection, the radiation emitted by the specimen is directly guided onto the relevant detector without passing the scanner mirror again.

Non-Descanned Detection is set and configured in the **Imaging Setup** tool by choosing the **Non-Descanned** tab next to the **LSM** tab. This tab is only available when NDD detectors are connected.

- Click on the **Non-Descanned** tab to change to Non-Descanned Detection.
- After checking a box next to a channel the corresponding detection window is indicated in the bar in the upper part of the window. Within each bar an arrow opens a drop down window which allows choosing the fluorescent dye to be imaged. Its emission profile is then indicated in the spectral display.

### 2.1 Thickness of optical slices using multiphoton excitation and non descanned detection

In the **Channels** tool the thickness of the optical slices is indicated dependent on the excitation wavelength of the NLO laser. This slice thickness (FWHM) is calculated according the following formula:

$$2x\sqrt{\ln 2} \times \frac{0.532\lambda}{\sqrt{2}} \times \left[ \frac{1}{n - \sqrt{n^2 - NA^2}} \right]$$

It does not take into account system specific influences on the excitation PSF. This formula is not applied whenever an internal detector with a pinhole is used even if the pinhole is completely open.

## 2.2 Mounting and Dismounting of NDD modules from the NDD port

To take off a NDD module from its port or from the NDD module before loosen the screws (Fig. 6/1 und 2) on the port connection. There are two screws at each connection port to fix the modules to the port or to each other. The ports are electronic connections, be careful when removing or mounting the modules. Each unoccupied port must be covered by the blind plate; otherwise the system is not safe and does not work.

Make sure not to use two modules of the same type on one LSM system. This leads to errors in the system and one of the modules will not be recognized. If a two channel module is extended with additional modules, the NDDs must be supported using the provided support posts which have to be fixed to the table.

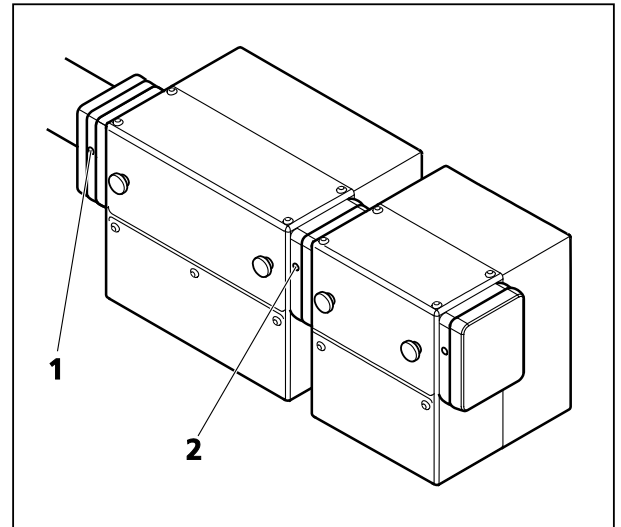


Fig. 6 Mounting and dismounting NDD modules

## 2.3 Electronic Connection of NDD modules

The electrical connection of transmitted and reflected light NDD modules needs to be done to two different LVDS connectors.

On the realtime electronics unit, there are 4 LVDS ports, A-D (Fig. 7).

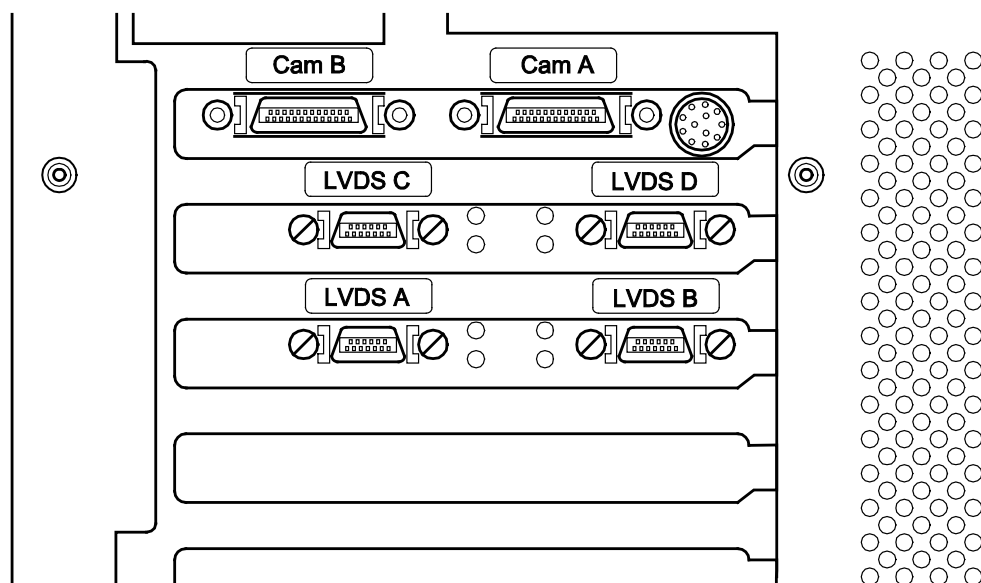
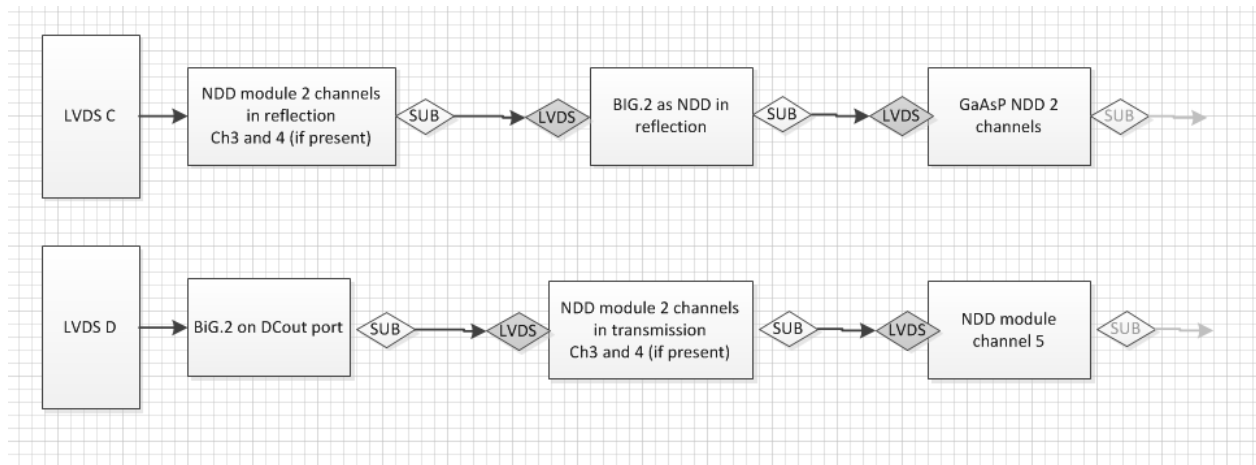


Fig. 7 LVDS connectors on the back of the realtime electronics unit.

The NDD detectors need to be connected to the systems in the following way:

LSM 880 NLO	
LVDS A	(LSM 880 detection)
LVDS B	T-PMT (via LSM 880 scanner)
LVDS C	<b>Reflected light NDDs</b> (followed by <b>NDD module channel 5</b> , followed by <b>GaAsP NDD 2 channels</b> )
LVDS D	BiG.2 on DCout port followed by <b>Transmitted light NDDs</b> (followed by <b>NDD module channel 5</b> )

If NDDs are present at a LSM system some of the hardware components are connected via sub-LVDS to the realtime electronics as listed above. The NDD channels 3 and 4 only have to be connected to the 2 channel NDD module but don't need a connection to the realtime electronics.

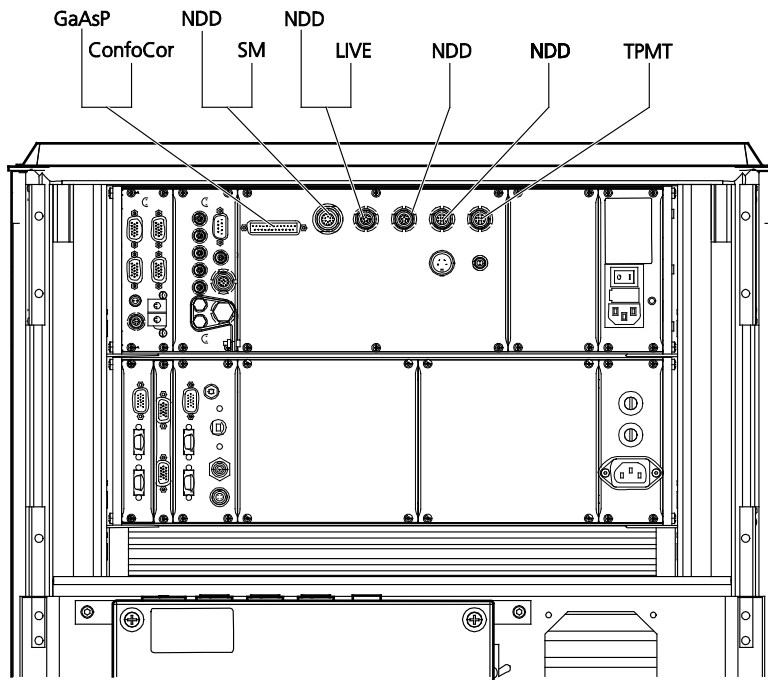


**Fig. 8** Diagram illustrating the connection of non descanned detectors via LVDS to the realtime electronics.

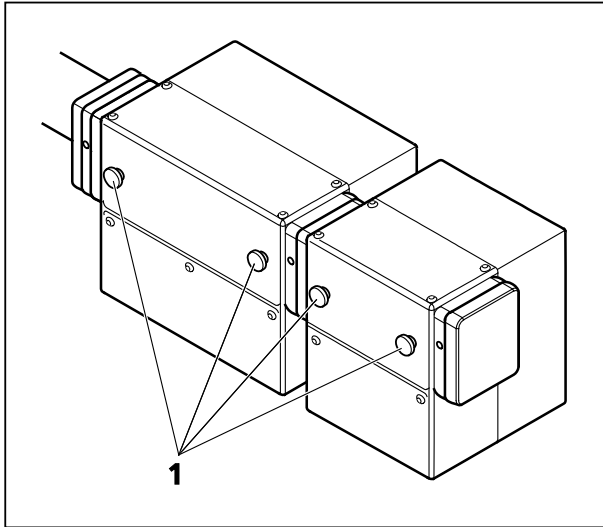
If one block/module is not present the subsequent module takes its place. BiG.2 as NDD can take the place of the NDD module channel 5 or vice versa. Only two BiG.2 detectors of different type can be connected to one LSM system. There can be additional subsequent modules in the chain. If a BiG.2 is moved from the NDD position to the DCout port (or vice versa) it should be placed in the LVDS chain as shown in this diagram.



In addition the power connections have to be made in the following way to the plugs on the back of the electronics rack:



**Fig. 9** Power connections of NDD detectors and the scan modules on the electronics rack of the LSM NLO.



**Fig. 10** Thumbscrews of the P&C sliders

## 2.4 Filter for non descanned detectors (NDDs)

To make the best use of NDDs it is necessary to achieve optimal blocking of the excitation laser light. This is done in the same way for all LSM systems with NDDs independent of the microscope used.

The first NDD module, which is attached to the NDD port, is either a two channel module (Fig. 10/1) or a BiG.2 module. Inside those modules right at the opening towards the microscope is a small clamping that holds a blocking filter (1442-160 or 1442-161; order# Feb. 08). Both filters are short pass filters which block the IR light of the multiphoton laser with an optical density (OD) of at least 7. If none of these filters is installed, the image quality will not be sufficient as too much laser light will get to the detectors. Always make sure one of these filters is in place.

To install them, open the metallic grey lid of the NDD module turning the thumbscrews (Fig. 10/1). Once the lid is removed the clamping is accessible. Slid in the filter, which is attached to a small holder, into the clamping with the little screw on the side of the holder situated on the left side of the holder when facing towards the microscope.

All emission filters offered for the NDD modules have an additional IR blocking capacity of OD 5. Other filters without these characteristics may lead to inferior image quality.

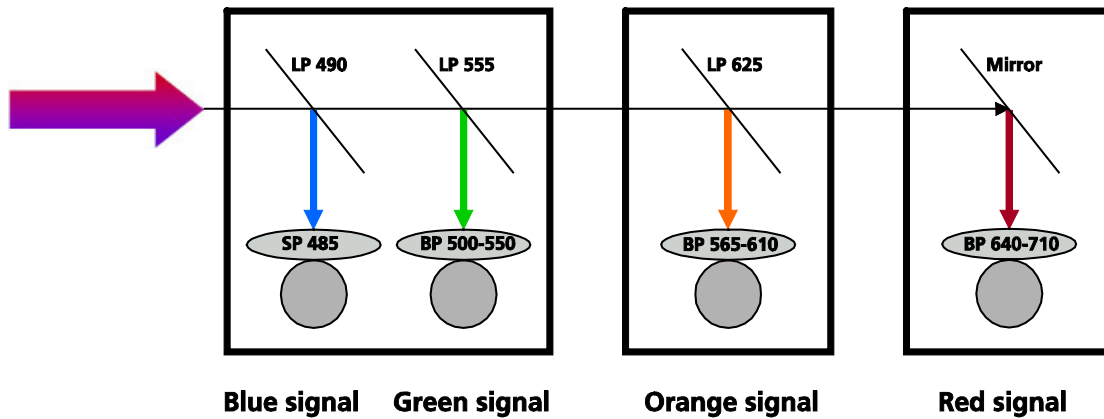
All secondary dichroic filters for the NDDs Push&Click filter cubes are long pass filters. They split the emitted fluorescence according to the indicated wavelength into the longer and shorter spectral range. In this respect the dichroic filters are specified in the spectral range of 380 to 800 nm.

The Emission filters are mounted into Push&Click filter cubes which are clamped into the slider of the NDD modules. NDD modules with two channels hold two Push&Click filter cubes. NDD modules with one channel hold one Push&Click filter cube. The NDD module to be used for the end of the cascade does not have a slider for a Push&Click filter cube.

- To change the cubes simply take out the sliders which hold the cubes by unscrewing them from the rest of the module using the thumbscrews (Fig. 10/1).
- The filter cubes can now be mounted onto the slider by sliding the side noses of the cubes under the corresponding spring latches. The orientation of the dichroic filters and emission filters is indicated on the slider.

The arrangement of the filters inside the NDD modules depends on the orientation of the modules on the microscope.

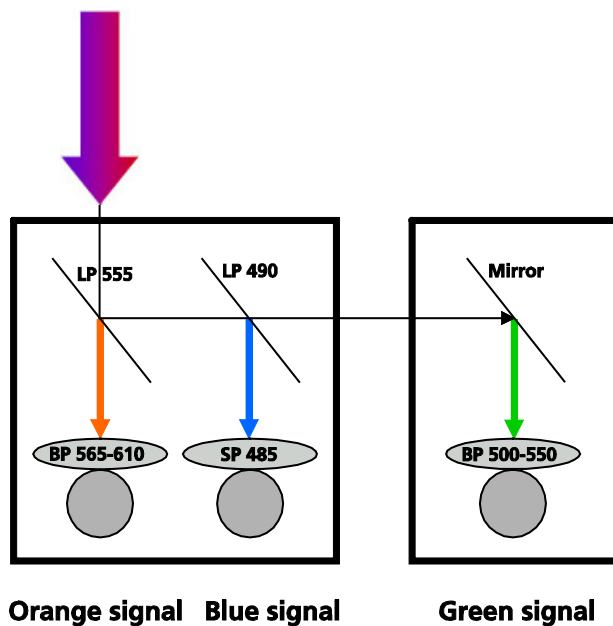
For LSM NLO systems on **Axio Observer** the NDDs are attached to the side port (up to 5 channels are possible) or the transmission port (maximum of two channels is possible). All dichroic filters offered by ZEISS for this modules, are long pass dichroic filters. Therefore the blue part of the spectrum is detected with the first NDD whereas the red part is guided further on to the following NDDs (Fig. 11).



**Fig. 11** Example for a filter equipment of a four channel NDD set up on Axio Observer starting with an NDD module type C or D

For LSM NLO systems on **Axio Imager** (NDDs are only available for reflection) and **Axio Examiner** a total of 5 detectors can be mounted onto the ports starting with a two channel module of type A or B.

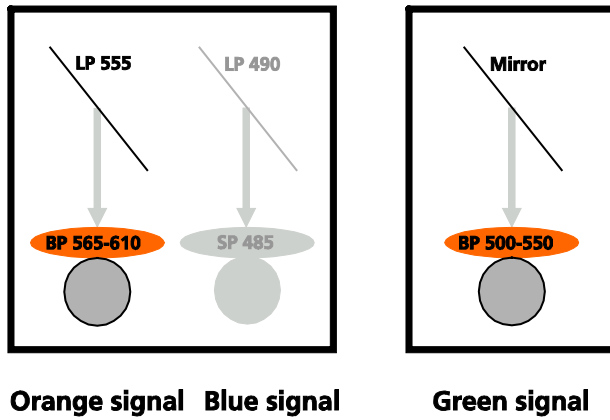
The filter arrangement could be as described in Fig. 12. As the dichroic filters are also long pass filters channel 1 always needs to see the red part of the spectrum followed by the blue part of the spectrum within the required detection range. If more than 4 channels are required in reflection, a fiber coupled illumination system (X-Cite 120 or HXP 120) instead of a standard HBO lamp is required.



**Fig. 12** Potential filter equipment for a three channel NDD set up on Axio Examiner starting with an NDD module type A or B

Adding NDD channel 3, 4 or 5 to an existing set up does require rearranging and swapping of individual filters within and between single P&C cubes for the systems with Axio Examiner or Axio Imager.

For example, to add a fourth channel to the cascade shown in Fig. 13 with a filter combination to additionally detect an emission signal in the far red range the filters have to be rearrange the following way:

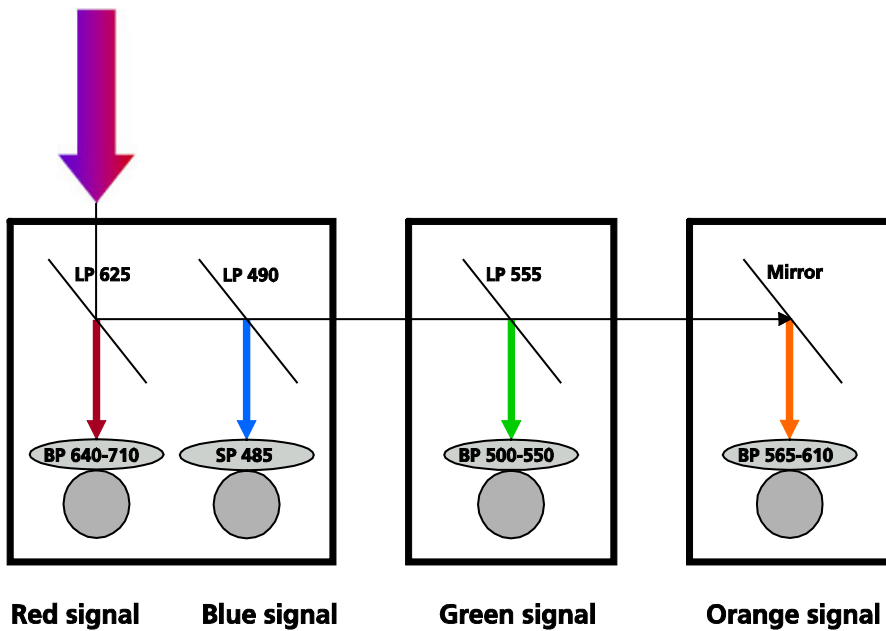


**Fig. 13** Emission filters that need to be interchanged when upgrading a three channel to a four channel system using the standard filter set.

The emission filters in the filter cube for the green channel in front of channel three is interchanged with the emission filter of the filter cube for the orange signal which sits in front of channel one.

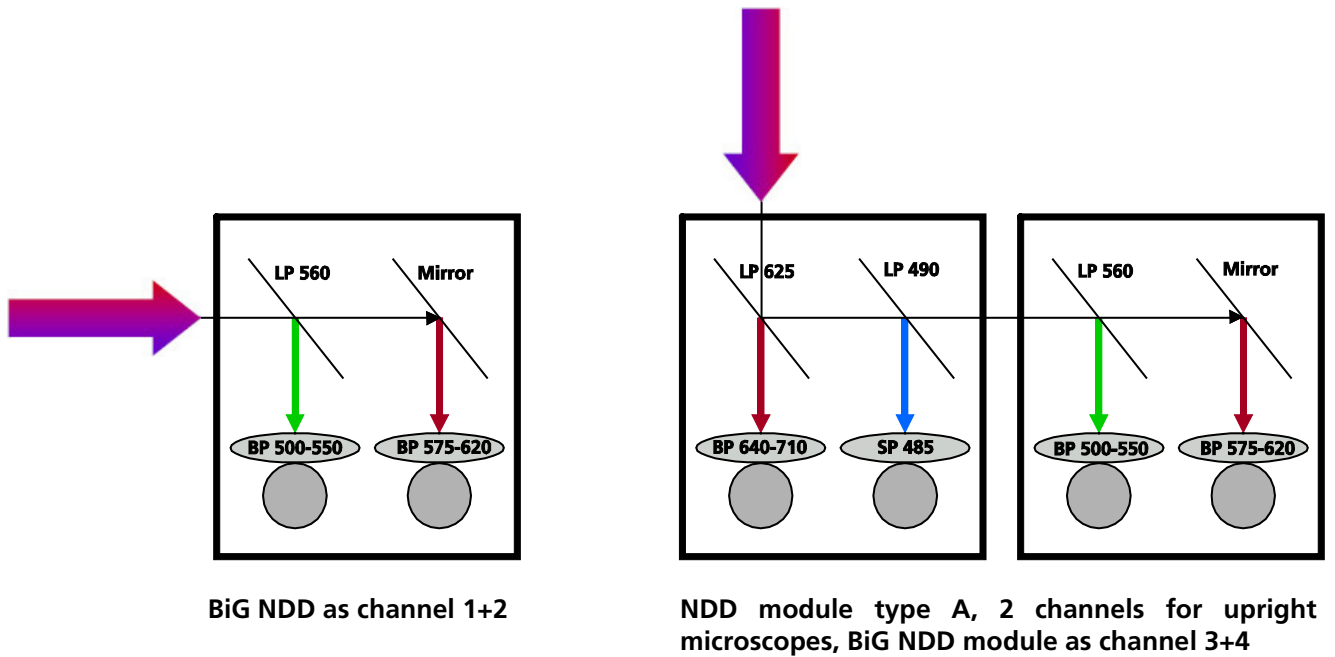
The cube with the mirror (now detecting the orange signal) is then placed in the new additional NDD module.

The filter cube with the emission filter for the green signal is then placed in front of channel three. The new additional filter cube for the red signal is placed into the two-channel NDD module in front of channel one. The result is shown in the following figure:

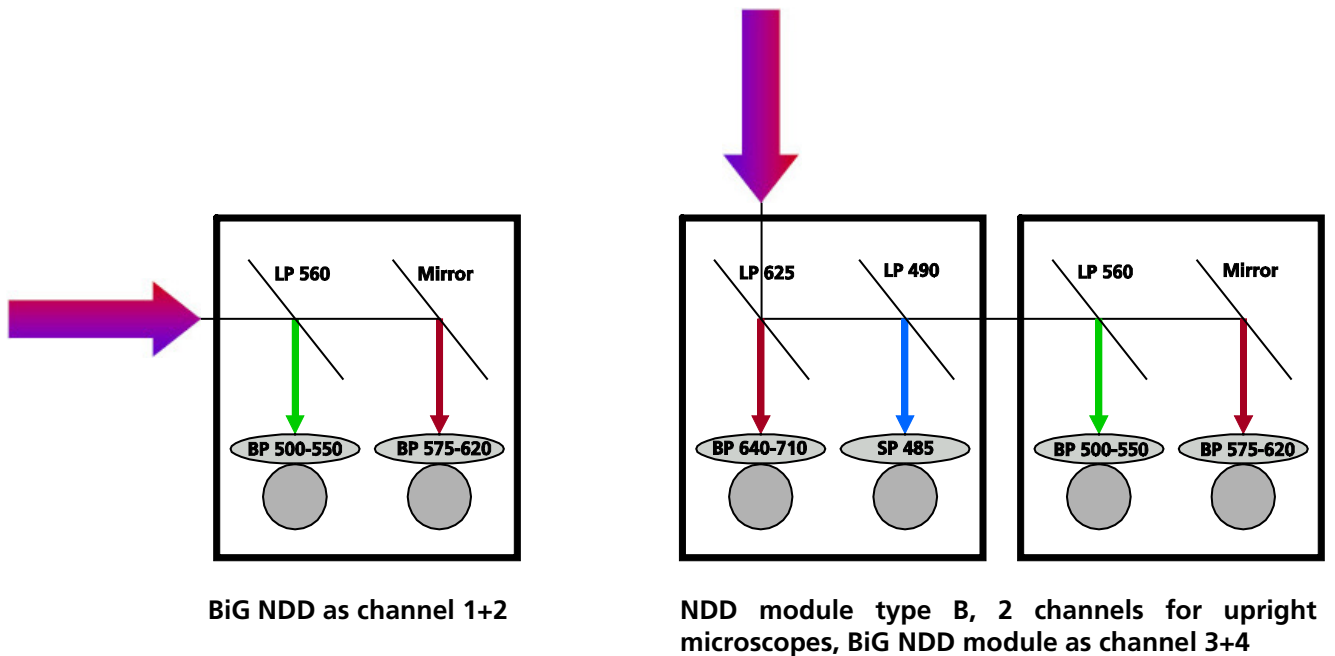


**Fig. 14** Potential filter equipment for a four channel NDD set up on Axio Examiner starting with an NDD module type A or B

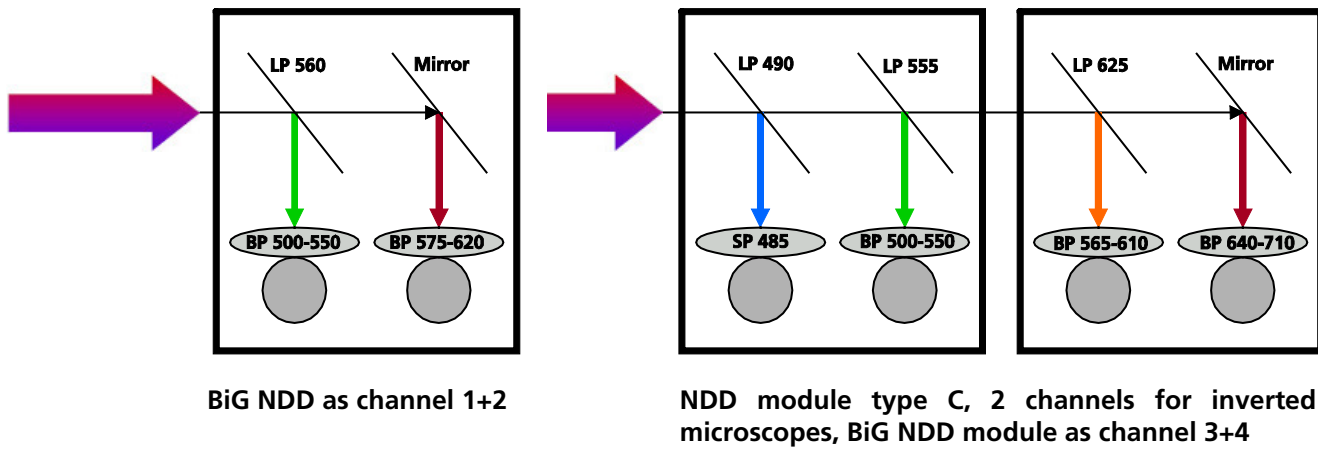
**For Axio Examiner and Axio Imager:  
BiG.2 with GaAsP at Reflected Light NDD Port**



**For Axio Examiner:  
BiG.2 with GaAsP at Transmitted Light NDD Port**

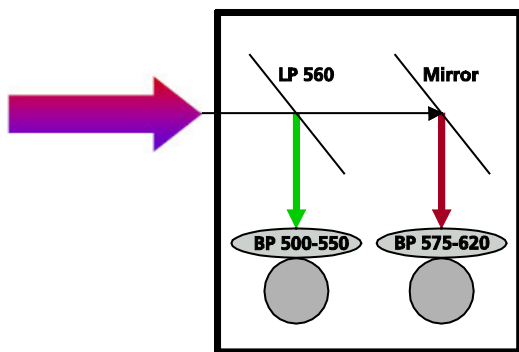


**For Axio Observer:  
BiG.2 with GaAsP at Reflected Light NDD Port**



**BiG.2 with GaAsP at Transmitted Light NDD Port**

External detection module BiG DC/transmitted light



**BiG NDD as channel 1+2;  
no additional NDD modules can be attached**

Once the NDD modules are connected and the filters are placed in front of the detectors, use the **Filters** tool in the **Maintain** tab to indicate the filters to the software. See section **5.5 Maintain Tab** in CHAPTER 1: SYSTEM OPERATION.

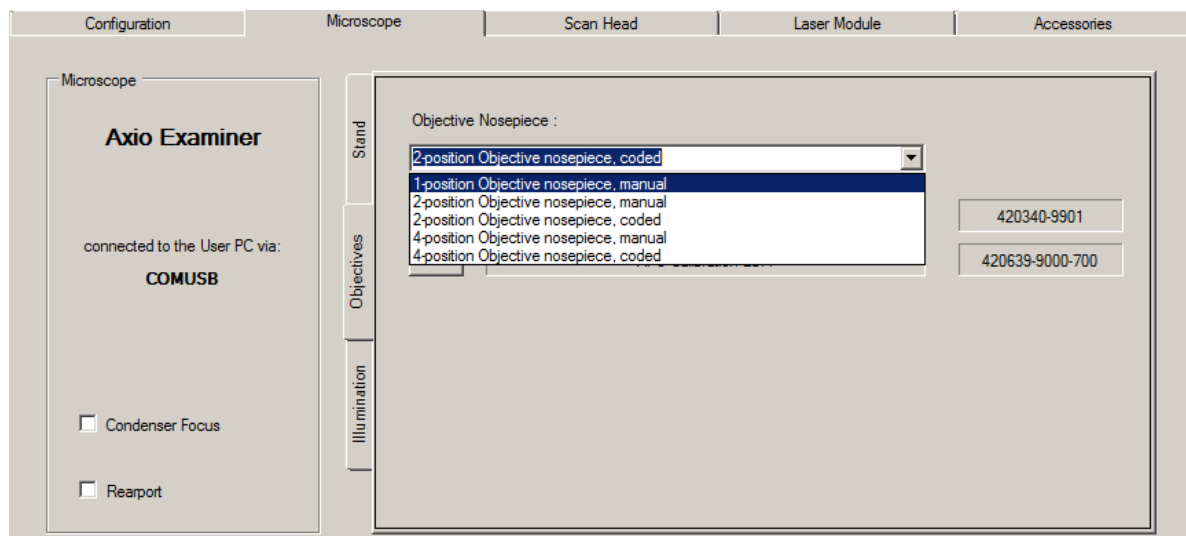
**GaAsP NDD 2 channels for Axio Examiner**

This detector module is located in a special objective holder. It replaces a standard objective holder on the Axio Examiner. It holds one objective. Standard objectives need to be used together with the optical adapter provided.

For attaching the holder to the microscope, see the safety instructions. Make sure the detector is then connected to the realtime electronics and the power supply as described in section 2.3 of this chapter.

To indicate the detector to the software use the configuration tool in the following way:

Open the tab for the Microscope and choose the tab Objectives. In the top most drop-down list choose the 1 position Objective nosepiece manual (Fig. 15).

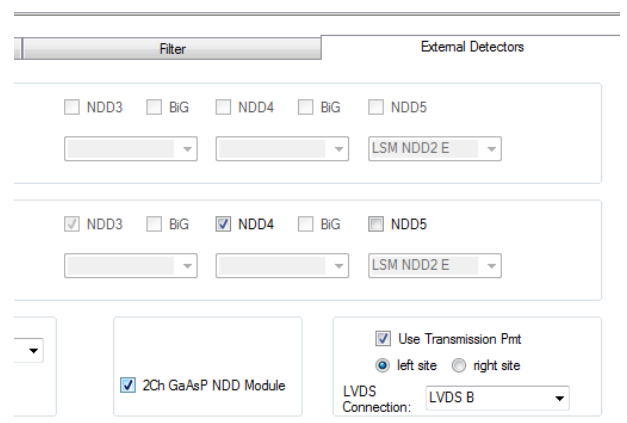


**Fig. 15 Configuration tool with Microscope and Objectives tab active for choosing the objective nosepiece representing also the GaAsP NDD 2 channels**

In addition indicate the presence of the GaAsP NDD 2 channels in the Scan Head/ External Detectors tab (Fig. 16).

The GaAsP NDD 2 channels provides two highly sensitive GaAsP detectors which are located inside the objective holder.

It is a very light sensitive detector which is protected against too much light by automatic down-regulation of the voltage or even the shut-down of the voltage. An additional hardware shutter closes if the detector is not used for image acquisition. See further instructions on handling the detector in the Safety instructions.



**Fig. 16 Configuration tool with External Detectors tab active for activating the GaAsP NDD 2 channels**

## 2.5 Changing the Filter Modules BiG.2

You can remove and replace filter modules by push and click.

 When opening the filter insert, the safety control will switch off the laser light.

To exchange the filter module of the BiG.2 proceed as follows:

- Loosen the two knurled screws (Fig. 17/2).
- Remove the filter insert (Fig. 17/3) of the BiG.2 (Fig. 17/1) and put it down.

How to uninstall a module:

- Disengage the filter module (Fig. 18/4) from the upper spring elements (Fig. 18/2) of the filter insert (Fig. 18/5) by tilting it forward, then lift it off the lower spring elements (Fig. 18/1) and remove the module.

How to install a module:

- Insert the filter module (Fig. 18/4) with the aid of its mounting elements on its left and right (Fig. 18/3) into the lower spring clips (Fig. 18/1) on the filter insert.
- Press the filter module against the upper spring clips (Fig. 18/2) until it engages firmly.
- After exchanging the filter module, replace the filter insert (Fig. 17/3) into the BiG.2 (Fig. 17/1).
- Fasten the two knurled screws (Fig. 17/2).

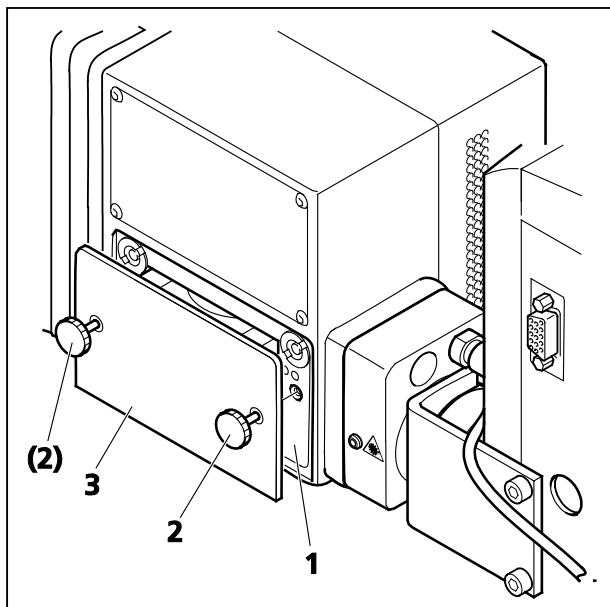


Fig. 17 Filter insert of the BiG.2

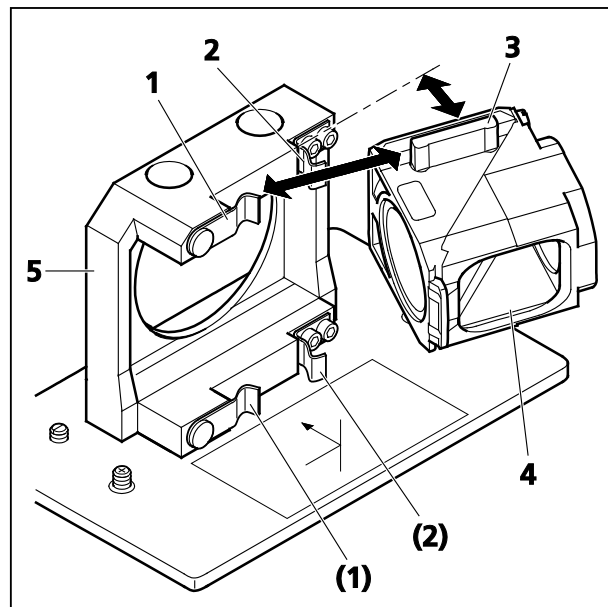


Fig. 18 Changing the filter module

Once the NDD modules are connected and the filters are placed in front of the detectors, use the **Filters** tool in the **Maintain** tab to indicate the filters to the software. See section **5.5 Maintain Tab** in CHAPTER 1: SYSTEM OPERATION. The shorter emission wavelength is registered by channel 1 (BiG Ch1) and the longer wavelength is registered by channel 2 (BiG Ch2).



Carl Zeiss

# Confocal Laser Scanning Microscopy

$$\text{Resolution} = \frac{0.64 \cdot \lambda}{(n - \sqrt{n^2 - \text{NA}^2})}$$



We make it visible.

# **Confocal Laser Scanning Microscopy**

Stefan Wilhelm

	Page
<b>Introduction</b>	<b>4</b>

## PART 1 **Optical Image Formation**

Part 1 deals with the purely optical conditions in a confocal LSM and the influence of the pin-hole on image formation. From this, ideal values for resolution and optical slice thickness are derived.

<b>Point Spread Function</b>	<b>8</b>
<b>Resolution and Confocality</b>	<b>10</b>
Resolution	<b>11</b>
Geometric optic confocality	<b>13</b>
Wave-optical confocality	<b>14</b>
Overview	<b>17</b>

## PART 2 **Signal Processing**

Part 2 limits the idealized view, looking at the digitizing process and the noise introduced by the light as well as by the optoelectronic components of the system.

<b>Sampling and Digitization</b>	<b>18</b>
Types of A/D conversion	<b>19</b>
Nyquist theorem	<b>20</b>
Pixel size	<b>21</b>
<b>Noise</b>	<b>22</b>
Resolution and shot noise – resolution probability	<b>23</b>
Possibilities to improve SNR	<b>25</b>
<b>Glossary</b>	<b>27</b>

## PART 3 **Details**

Part 3 deals with special aspects of Part 1 and 2 from a more physical perspective.

<b>Pupil Illumination</b>	<b>I</b>
<b>Optical Coordinates</b>	<b>II</b>
<b>Fluorescence</b>	<b>III</b>
<b>Sources of Noise</b>	<b>V</b>

## Literature

In recent years, the confocal Laser Scanning Microscope (LSM) has become widely established as a research instrument.

The present brochure aims at giving a scientifically sound survey of the special nature of image formation in a confocal LSM.

# Introduction

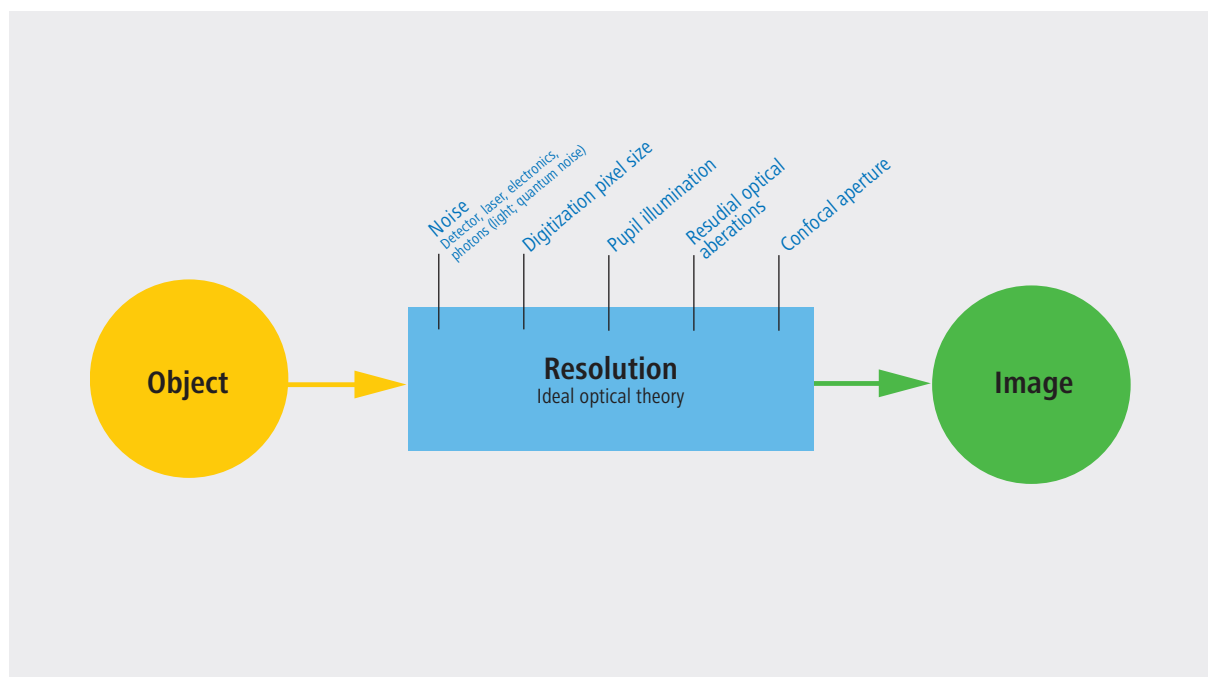
Following a description of the fundamental differences between a conventional and a confocal microscope, this monograph will set out the special features of the confocal LSM and the capabilities resulting from them. The conditions in fluorescence applications will be given priority treatment throughout.

## Image generation

The complete generation of the two-dimensional object information from the focal plane (object plane) of a confocal LSM essentially comprises three process steps:

1. Line-by-line scanning of the specimen with a focused laser beam deflected in the X and Y directions by means of two galvanometric scanners.
2. Detection of the fluorescence emitted by the scanned specimen details, by means of a photomultiplier tube (PMT).
3. Digitization of the object information contained in the electrical signal provided by the PMT (for presentation, the image data are displayed, pixel by pixel, from a digital matrix memory to a monitor screen).

*Fig. 1 The quality of the image generated in a confocal LSM is not only influenced by the optics (as in a conventional microscope), but also, e.g., by the confocal aperture (pinhole) and by the digitization of the object information (pixel size). Another important factor is noise (laser noise, or the shot noise of the fluorescent light). To minimize noise, signal-processing as well as optoelectronic and electronic devices need to be optimized.*



## Scanning process

In a conventional light microscope, object-to-image transformation takes place simultaneously and parallel for all object points. By contrast, the specimen in a confocal LSM is irradiated in a pointwise fashion, i.e. serially, and the physical interaction between the laser light and the specimen detail irradiated (e.g. fluorescence) is measured point by point. To obtain information about the entire specimen, it is necessary to guide the laser beam across the specimen, or to move the specimen relative to the laser beam, a process known as scanning. Accordingly, confocal systems are also known as point-probing scanners.

To obtain images of microscopic resolution from a confocal LSM, a computer and dedicated software are indispensable. The descriptions below exclusively cover the point scanner principle as implemented, for example, in laser scanning microscopes from Carl Zeiss. Configurations in which several object points are irradiated simultaneously are not considered.

## Confocal beam path

The decisive design feature of a confocal LSM compared with a conventional microscope is the confocal aperture (usually called pinhole) arranged in a plane conjugate to the intermediate image plane and, thus, to the object plane of the microscope. As a result, the detector (PMT) can only detect light that has passed the pinhole. The pinhole diameter is variable; ideally, it is infinitely small, and thus the detector looks at a point (point detection).

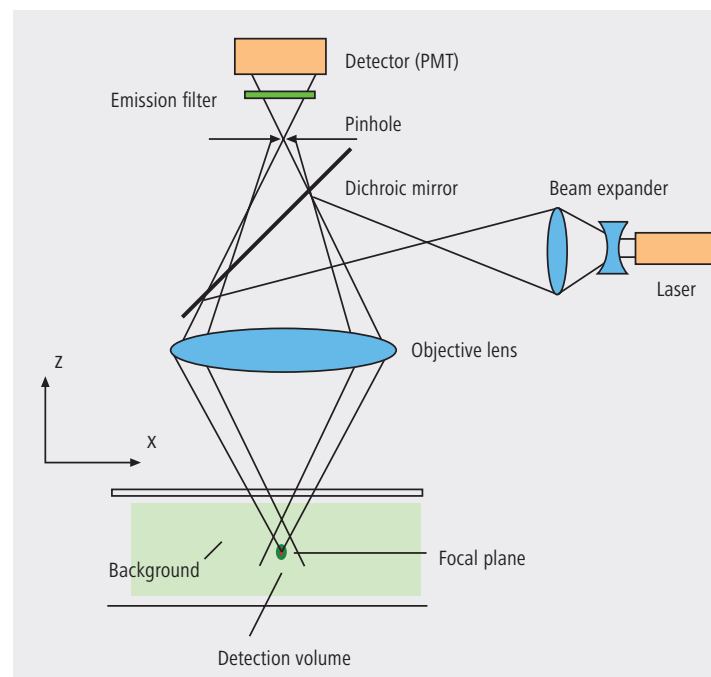
As the laser beam is focused to a diffraction-limited spot, which illuminates only a point of the object at a time, the point illuminated and the point observed (i.e. image and object points) are situated in conjugate planes, i.e. they are focused onto each other. The result is what is called a confocal beam path (see figure 2).

## Pinhole

Depending on the diameter of the pinhole, light coming from object points outside the focal plane is more or less obstructed and thus excluded from detection. As the corresponding object areas are invisible in the image, the confocal microscope can be understood as an inherently depth-discriminating optical system.

By varying the pinhole diameter, the degree of confocality can be adapted to practical requirements. With the aperture fully open, the image is nonconfocal. As an added advantage, the pinhole suppresses stray light, which further improves image contrast.

*Fig. 2 Beam path in a confocal LSM. A microscope objective lens is used to focus a laser beam onto the specimen, where it excites fluorescence, for example. The fluorescent radiation is collected by the objective and efficiently directed onto the detector via a dichroic beamsplitter. The interesting wavelength range of the fluorescence spectrum is selected by an emission filter, which also acts as a barrier, blocking the excitation laser line. The pinhole is arranged in front of the detector, on a plane conjugate to the focal plane of the objective lens. Light coming from planes above or below the focal plane is out of focus when it hits the pinhole, so most of it cannot pass the pinhole and therefore does not contribute to forming the image.*



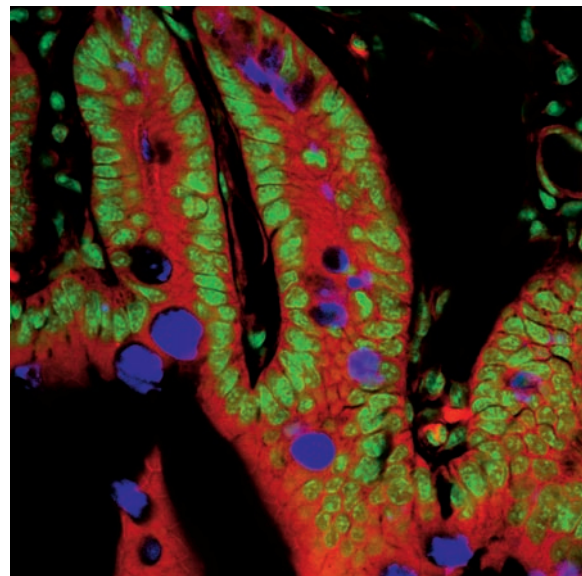
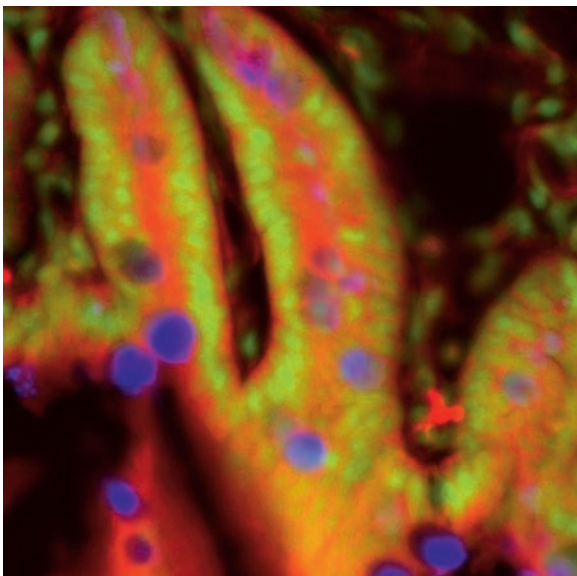
## Optical slices

With a confocal LSM and its variable pinhole it is therefore possible to exclusively image a thin optical slice out of a thick specimen (typically, up to 100  $\mu\text{m}$ ), a method known as optical sectioning. Under suitable conditions, the thickness (Z dimension) of such a slice may be less than 500 nm. The fundamental advantage of the confocal LSM over a conventional microscope is obvious: In conventional fluorescence microscopy, the image of a thick biological specimen will only be in focus if its Z dimension is not greater than the wave-optical depth of focus specified for the respective objective lens.

Unless this condition is satisfied, the in-focus image information from the object plane of interest is mixed with out-of-focus image information from planes outside the focal plane. This reduces image contrast and increases the share of stray light detected. If multiple fluorescences are observed, there will in addition be a color mix of the image information obtained from the channels involved (figure 3, left).

Hence it follows that a confocal LSM can be used to advantage especially where thick fluorescent specimens (such as biological cells in tissue) have to be examined. The possibility of optical sectioning eliminates the drawbacks attached to the observation of such specimens by conventional fluorescence microscopy. With multicolor fluorescence, the various channels are furthermore satisfactorily separated and can be recorded simultaneously.

Figure 3 (right) demonstrates this capability of a confocal Laser Scanning Microscope.



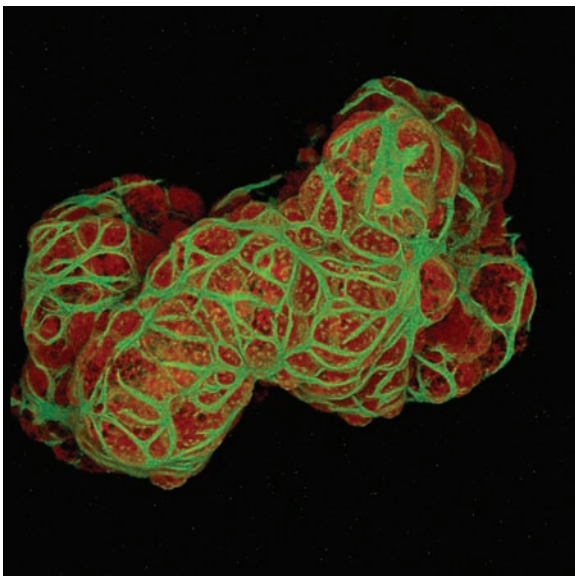
*Fig. 3 Non-confocal (left) and confocal (right) image of a triple-labeled cell aggregate (mouse intestine section). In the non-confocal image, specimen planes outside the focal plane degrade the information of interest from the focal plane, and differently stained specimen details appear in mixed color. In the confocal image (right), specimen details blurred in non-confocal imaging become distinctly visible, and the image throughout is greatly improved in contrast.*



### 3<sup>rd</sup> dimension

In addition to the possibility to observe a single plane (or slice) of a thick specimen in good contrast, optical sectioning allows a great number of slices to be cut and recorded at different Z-planes of the specimen, with the specimen being moved along the optical axis by controlled increments. The result is a 3D data set, which provides information about the spatial structure of the object. The quality and accuracy of this information depend on the thickness of the slice and on the spacing between successive slices (optimum scanning rate in Z direction = 0.5x the slice thickness). By computation, various aspects of the object can be generated from the 3D data set (3D reconstruction, sections of any spatial orientation, stereo pairs etc.). Figure 4 shows a 3D reconstruction computed from a 3D data set.

Fig. 4 3D projection reconstructed from 108 optical slices of a three-dimensional data set of epithelium cells of a lacrimal gland. Actin filaments of myoepithelial cells marked with BODIPY-FL phalloidin (green), cytoplasm and nuclei of acinar cells with ethidium homodimer-1 (red).



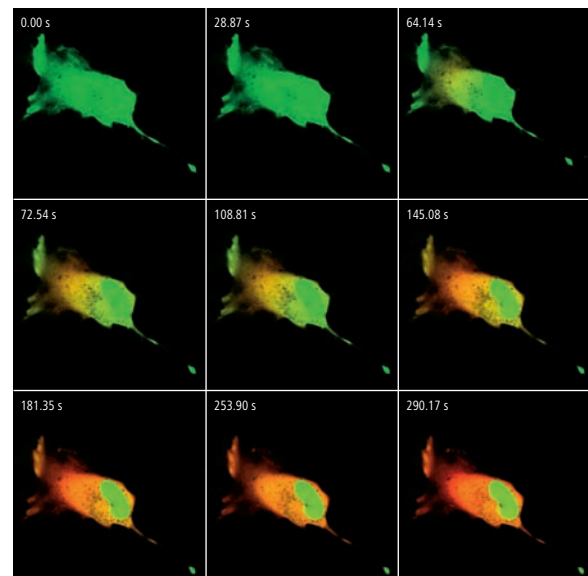
### Time series

A further field of importance is the investigation of living specimens that show dynamic changes even in the range of microseconds. Here, the acquisition of time-resolved confocal image series (known as time series) provides a possibility of visualizing and quantifying the changes (figure 5).

### Spectral Imaging

The detection of spectral information becomes necessary when overlapping emission signals of multiple marked specimen are to be separated. By means of a special Multichannel PMT it is possible to record the spectral information of the fluorescent signal. Together with advanced computation methods one can separate signals which almost overlap completely and only differ in their spectral signature. The method behind is called "linear unmixing" and allows, for example, several fluorescent proteins to be distinguished.

Fig. 5 Gallery of a time series experiment with Kaede-transfected cells. By repeated activation of the Kaede marker (green-to-red color change) in a small cell region, the entire green fluorescence is converted step by step into the red fluorescence.



# Point Spread Function

In order to understand the optical performance characteristics of a confocal LSM in detail, it is necessary to have a closer look at the fundamental optical phenomena resulting from the geometry of the confocal beam path. As mentioned before, what is most essential about a confocal LSM is that both illumination and observation (detection) are limited to a point.

Not even an optical system of diffraction-limited design can image a truly point-like object as a point. The image of an ideal point object will always be somewhat blurred, or “spread” corresponding to the imaging properties of the optical system. The image of a point can be described in quantitative terms by the point spread function (PSF), which maps the intensity distribution in the image space. Where the three-dimensional imaging properties of a confocal LSM are concerned, it is necessary to consider the 3D-PSF.

In the ideal, diffraction-limited case (no optical aberrations, and homogeneous illumination at all lens cross sections – see Part 3 “Pupil Illumination”), the 3D-PSF is of comet-like, rotationally symmetrical shape.

For illustration, Figure 6 shows two-dimensional sections (XZ and XY) through an ideal 3D-PSF.

From the illustration it is evident that the central maximum of the 3D-PSF, in which 86.5% of the total energy available in the pupil of the objective lens are concentrated, can be described as an ellipsoid of rotation. For considerations of resolution and optical slice thickness it is useful to define the half-maximum area of the ellipsoid, i.e. the well-defined area in which the intensity of the 3D PSF in axial and lateral direction has dropped to half of the central maximum.

Any reference to the PSF in the following discussion exclusively refers to the half-maximum area.

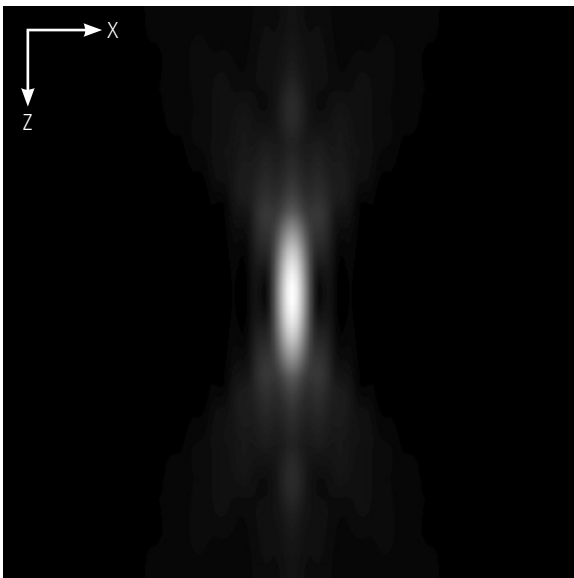
As said before the confocal LSM system as a whole generates two point images: one by projecting a point light source into the object space, the other by projecting a point detail of the object into the image space.

The total PSF ( $PSF_{tot}$ ) of a confocal microscope behind the pinhole is composed of the PSFs of the illuminating beam path ( $PSF_{ill}$ ; point illumination) and the detection beam path ( $PSF_{det}$ ; point detection). Mathematically, this relationship can be described as follows:

$$PSF_{tot}(x,y,z) = PSF_{ill}(x,y,z) \cdot PSF_{det}(x,y,z) \quad (1)$$

$PSF_{ill}$  corresponds to the light distribution of the laser spot that scans the object. Its size is mainly a function of the laser wavelength and the numerical aperture of the microscope objective lens. It is also influenced by diffraction at the objective lens pupil (as a function of pupil illumination, see details) and the aberrations of all optical components integrated in the system. [Note: In general, these aberrations are low, having been minimized during system design]. Moreover,  $PSF_{ill}$  may get deformed if the laser focus enters thick and light-scattering specimens, especially if the refractive indices of immersion liquid and mounting medium are not matched and/or if the laser focus is at a great depth below the specimen surface (see Hell, S., et al., [7]).

*Fig. 6a Section through the 3D-PSF in Z direction as generated by a diffraction limited objective lens – left, and in XY-direction – right (computed; dimensionless representation); the central, elliptical maximum is distinctly visible.*



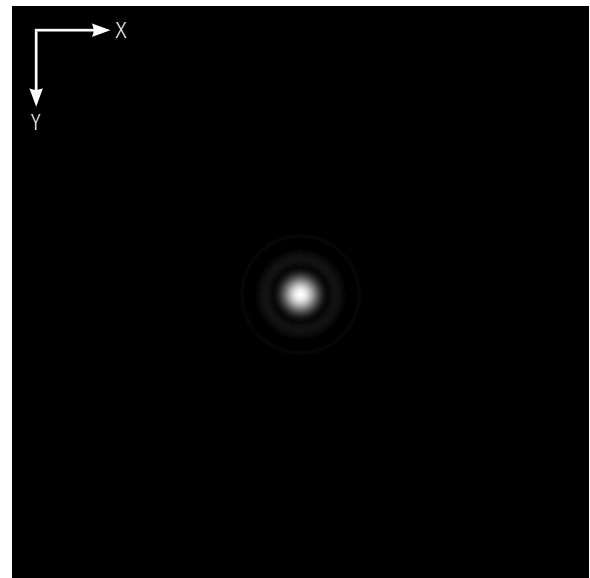
$PSF_{det}$  is also influenced by all these factors and, additionally, by the pinhole size. For reasons of beam path efficiency (see Part 2), the pinhole is never truly a point of infinitely small size and thus  $PSF_{det}$  is never smaller in dimension than  $PSF_{ill}$ . It is evident that the imaging properties of a confocal LSM are determined by the interaction between  $PSF_{ill}$  and  $PSF_{det}$ . As a consequence of the interaction process, it can be written:  $PSF_{tot} \leq PSF_{ill}$ .

With the pinhole diameter being variable, the effects obtained with small and big pinhole diameters must be expected to differ. In the following sections, various system states are treated in quantitative terms.

From the explanations made so far, it can also be derived that the optical slice is not a sharply delimited body. It does not start abruptly at a certain Z position, nor does it end abruptly at another. Because of the intensity distribution along the optical axis, there is a continuous transition from object information suppressed and such made visible.

Accordingly, the out-of-focus object information actually suppressed by the pinhole also depends on the correct setting of the image processing parameters (PMT high voltage, contrast setting). Signal overdrive or excessive offset should be avoided.

*Fig. 6b The central maximum in this illustration is called Airy disk and is contained in the 3D-PSF as the greatest core diameter in lateral direction.*



# Resolution and Confocality

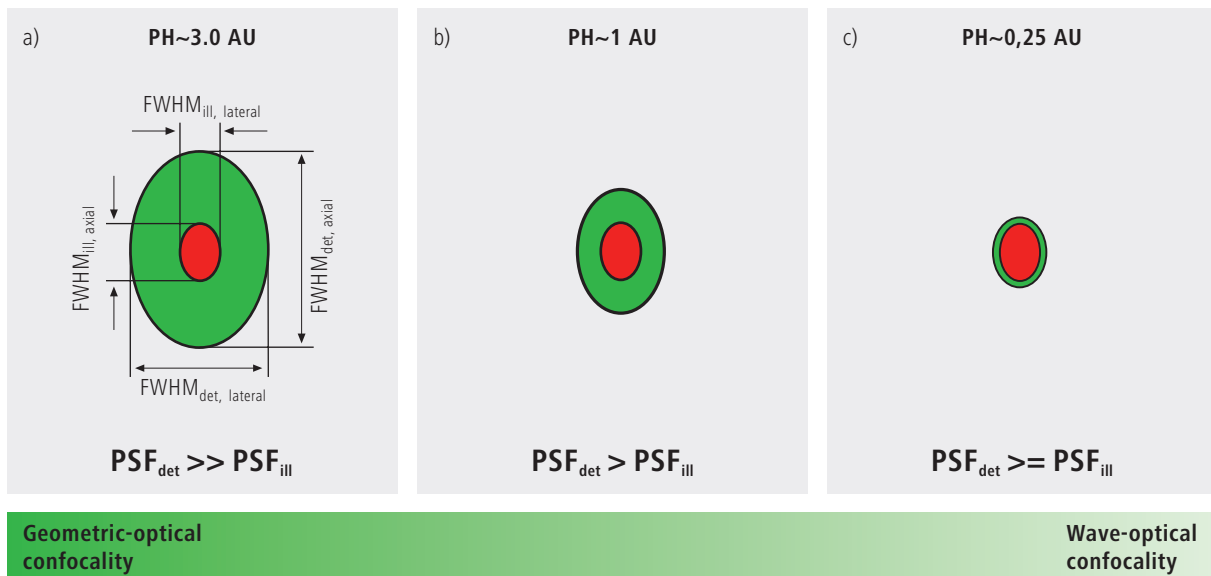
Wherever quantitative data on the resolving power and depth discrimination of a confocal LSM are specified, it is necessary to distinguish clearly whether the objects they refer to are point-like or extended, and whether they are reflective or fluorescent. These differences involve distinctly varying imaging properties. Fine structures in real biological specimens are mainly of a filiform or point-like fluorescent type, so that the explanations below are limited to point-like fluorescent objects. The statements made for this case are well applicable to practical assignments. As already mentioned, the pinhole diameter plays a decisive role in resolution and depth discrimination. With a pinhole diameter greater than 1 AU (AU = Airy unit – see *Details "Optical Coordinates"*), the depth discriminating properties under consideration are essentially based on the law of geometric optics (geometric-optical confocality).

The smaller the pinhole diameter, the more  $PSF_{det}$  approaches the order of magnitude of  $PSF_{ill}$ . In the limit case ( $PH < 0.25$  AU), both PSFs are approximately equal in size, and wave-optical image formation laws clearly dominate (wave-optical confocality).

Figure 7 illustrates these concepts. It is a schematic representation of the half-intensity areas of  $PSF_{ill}$  and  $PSF_{det}$  at selected pinhole diameters.

Depending on the pinhole diameter, the data and computation methods for resolution and depth discrimination will differ. A comparison with image formation in conventional microscopes is interesting as well. The following sections deal with this in detail.

Fig. 7 Geometric-optical (a) and wave-optical confocality (c) [XZ view]. The pinhole diameter decreases from (a) to (c). Accordingly,  $PSF_{det}$  (green) shrinks until it approaches the order of magnitude of  $PSF_{ill}$  (red).



## Resolution

Resolution, in case of large pinhole diameters ( $PH > 1AU$ ), is meant to express the separate visibility, both laterally and axially, of points during the scanning process. Imagine an object consisting of individual points: all points spaced closer than the extension of  $PSF_{ill}$  are blurred (spread), i.e. they are not resolved.

Quantitatively, resolution results from the axial and lateral extension of the scanning laser spot, or the elliptical half-intensity area of  $PSF_{ill}$ . On the assumption of homogeneous pupil illumination, the following equations apply:

Axial:

$$FWHM_{ill,axial} = \frac{0.88 \cdot \lambda_{exc}}{(n - \sqrt{n^2 - NA^2})} \quad (2)$$

$n$  = refractive index of immersion liquid  
 $NA$  = numerical aperture of the objective  
 $\lambda_{exc}$  = wavelength of the excitation light

If  $NA < 0.5$ , equation (2) can be approximated by:

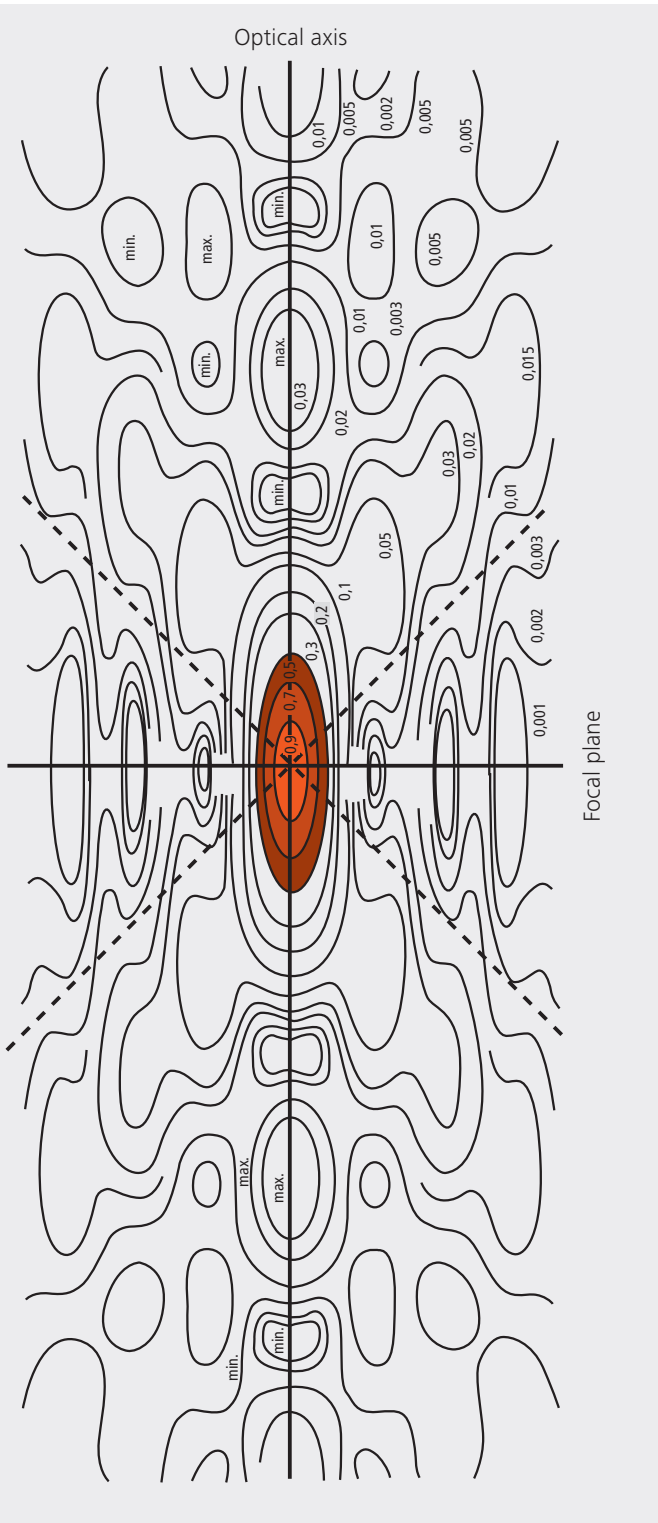
$$\approx \frac{1.77 \cdot n \cdot \lambda_{exc}}{NA^2} \quad (2a)$$

Lateral:

$$FWHM_{ill,lateral} = 0.51 \frac{\lambda_{exc}}{NA} \quad (3)$$

At first glance, equations (2a) and (3) are not different from those known for conventional imaging (see Beyer, H., [1]). It is striking, however, that the resolving power in the confocal microscope depends only on the wavelength of the illuminating light, rather than exclusively on the emission wavelength as in the conventional case.

Compared to the conventional fluorescence microscope, confocal fluorescence with large pinhole diameters leads to a gain in resolution by the factor  $(\lambda_{em}/\lambda_{exc})$  via the Stokes shift.



Let the statements made on the PSF so far be further illustrated by the figure on the left. It shows a section through the resulting diffraction pattern surrounding the focus on the illumination side ( $PSF_{ill}$ ).

The lines include areas of equal brightness (isophote presentation). The center has a normalized intensity of 1. The real relationships result by rotation of the section about the vertical ( $Z$ ) axis. Symmetry exists relative to the focal plane as well as to the optical axis. Local intensity maxima and minima are conspicuous. The dashed lines mark the range covered by the aperture angle of the microscope objective used.

For the considerations in this chapter, only the area marked in red color, i.e. the area at half maximum, is of interest.

*Fig. 8 Isophote diagram of the intensity distribution around the illumination-side focus ( $PSF_{ill}$ ). The intensity at the focus is normalized as 1. (Born & Wolf, Principles of Optics, 6th edition 1988, Pergamon Press)*

### Geometric optical confocality

Optical slice thickness (depth discrimination) and stray light suppression (contrast improvement) are basic properties of a confocal LSM, even if the pinhole diameter is not an ideal point (i.e. not infinitely small). In this case, both depth discrimination and stray light suppression are determined exclusively by  $PSF_{det}$ . This alone brings an improvement in the separate visibility of object details over the conventional microscope.

Hence, the diameter of the corresponding half-intensity area and thus the optical slice thickness is given by:

$$FWHM_{det,axial} = \sqrt{\left(\frac{0.88 \cdot \lambda_{em}}{n \cdot \sqrt{n^2 - NA^2}}\right)^2 + \left(\frac{\sqrt{2} \cdot n \cdot PH}{NA}\right)^2} \quad (4)$$

$\lambda_{em}$  = emission wavelength  
 $PH$  = object-side pinhole diameter [ $\mu m$ ]  
 $n$  = refractive index of immersion liquid  
 $NA$  = numerical aperture of the objective

Equation (4) shows that the optical slice thickness comprises a geometric-optical and a wave-optical term. The wave-optical term (first term under the root) is of constant value for a given objective and a given emission wavelength. The geometric-optical term (second term under the root) is dominant; for a given objective lens it is influenced exclusively by the pinhole diameter.

Likewise, in the case of geometric-optical confocality, there is a linear relationship between depth discrimination and pinhole diameter. As the pinhole diameter is constricted, depth discrimination improves (i.e. the optical slice thickness decreases). A graphical representation of equation (4) is illustrated in figure 9. The graph shows the geometric-optical term alone (blue line) and the curve resulting from eq. 4 (red line). The difference between the two curves is a consequence of the waveoptical term.

Above a pinhole diameter of 1 AU, the influence of diffraction effects is nearly constant and equation (4) is a good approximation to describe the depth discrimination. The interaction between  $PSF_{ill}$  and  $PSF_{det}$  becomes manifest only with pinhole diameters smaller than 1 AU.

Let it be emphasized that in case of geometric optical confocality the diameters of the half-intensity area of  $PSF_{det}$  allow no statement about the separate visibility of object details in axial and lateral direction.

In the region of the optical section ( $FWHM_{det,axial}$ ), object details are resolved (imaged separately) only unless they are spaced not closer than described by equations (2) / (2a) / (3).

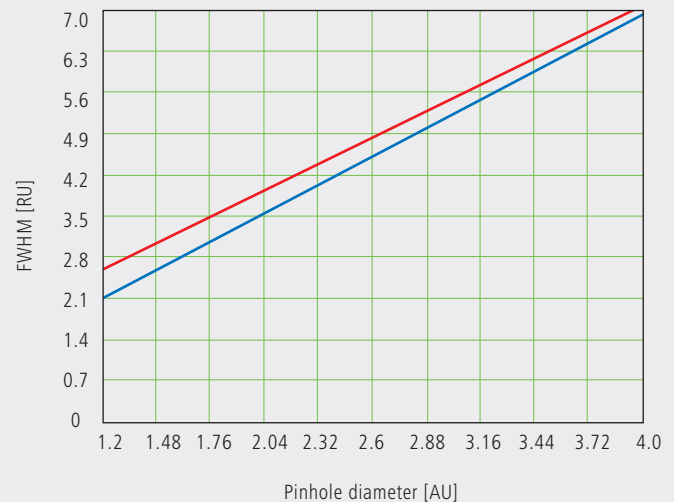


Fig.9 Optical slice thickness as a function of the pinhole diameter (red line). Parameters:  $NA = 0.6$ ;  $n = 1$ ;  $\lambda = 520$  nm. The X axis is dimensioned in Airy units, the Y axis (slice thickness) in Rayleigh units (see also: Details "Optical Coordinates"). In addition, the geometric-optical term in equation 4 is shown separately (blue line).

## Wave-optical confocality

If the pinhole is closed down to a diameter of  $<0.25$  AU (virtually “infinitely small”), the character of the image changes. Additional diffraction effects at the pinhole have to be taken into account, and  $PSF_{det}$  (optical slice thickness) shrinks to the order of magnitude of  $PSF_{ill}$  (Z resolution) (see also figure 7c).

In order to achieve simple formulae for the range of smallest pinhole diameters, it is practical to regard the limit of  $PH = 0$  at first, even though it is of no practical use. In this case,  $PSF_{det}$  and  $PSF_{ill}$  are identical. The total PSF can be written as:

$$PSF_{tot}(x,y,z) = (PSF_{ill}(x,y,z))^2 \quad (5)$$

In fluorescence applications it is furthermore necessary to consider both the excitation wavelength  $\lambda_{exc}$  and the emission wavelength  $\lambda_{em}$ . This is done by specifying a mean wavelength<sup>1</sup>:

$$\bar{\lambda} \approx \sqrt{2} \frac{\lambda_{em} \cdot \lambda_{exc}}{\sqrt{\lambda_{exc}^2 + \lambda_{em}^2}} \quad (6)$$

Thus, equations (2) and (3) for the widths of the axial and lateral half-intensity areas are transformed into:

Axial:

$$FWHM_{tot,axial} = \frac{0.64 \cdot \bar{\lambda}}{(n - \sqrt{n^2 - NA^2})} \quad (7)$$

If  $NA < 0.5$ , equation (2) can be approximated by:

$$\approx \frac{1.28 \cdot n \cdot \bar{\lambda}}{NA^2} \quad (7a)$$

Lateral:

$$FWHM_{tot,lateral} = 0.37 \frac{\bar{\lambda}}{NA} \quad (8)$$

### Note:

**With the object being a mirror, the factor in equation 7 is 0.45 (instead of 0.64), and 0.88 (instead of 1.28) in equation 7a. For a fluorescent plane of finite thickness, a factor of 0.7 can be used in equation 7. This underlines that apart from the parameters (NA,  $\bar{\lambda}$ , n) influencing the optical slice thickness, the type of specimen also affects the measurement result.**

<sup>1</sup> For rough estimates, the expression  $\bar{\lambda} \approx \sqrt{\lambda_{em} \cdot \lambda_{exc}}$  suffices.

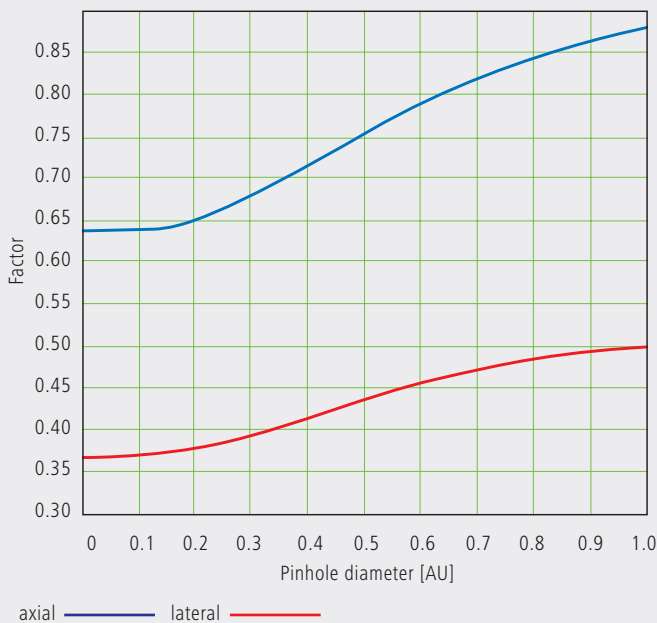


From equations (7) and (7a) it is evident that depth resolution varies linearly with the refractive index  $n$  of the immersion liquid and with the square of the inverse value of the numerical aperture of the objective lens  $\{NA = n \cdot \sin(\alpha)\}$ . To achieve high depth discrimination, it is important, above all, to use objective lenses with the highest possible numerical aperture.

As an  $NA > 1$  can only be obtained with an immersion liquid, confocal fluorescence microscopy is usually performed with immersion objectives (see also figure 11).

A comparison of the results stated before shows that axial and lateral resolution in the limit case of  $PH=0$  can be improved by a factor of 1.4. Furthermore it should be noted that, because of the wave-optical relationships discussed, the optical performance of a confocal LSM cannot be enhanced infinitely. Equations (7) and (8) supply the minimum possible slice thickness and the best possible resolution, respectively.

Fig. 10 Theoretical factors for equations (7) and (8), with pinhole diameters between 0 and 1 AU.



From the applications point of view, the case of strictly wave-optical confocality ( $PH=0$ ) is irrelevant (see also Part 2). By merely changing the factors in equations (7) and (8) it is possible, though, to transfer the equations derived for  $PH=0$  to the pinhole diameter range up to 1 AU, to a good approximation. The factors applicable to particular pinhole diameters can be taken from figure 10.

It must also be noted that with  $PH < 1AU$ , a distinction between optical slice thickness and resolution can no longer be made. The thickness of the optical slice at the same time specifies the resolution properties of the system. That is why in the literature the term of depth resolution is frequently used as a synonym for depth discrimination or optical slice thickness. However, this is only correct for pinhole diameters smaller than 1 AU.

To conclude the observations about resolution and depth discrimination (or depth resolution), the table on page 17 provides an overview of the formulary relationships developed in Part 1. In addition, figure 11a (page 16) shows the overall curve of optical slice thickness for a microscope objective of  $NA = 1.3$  and  $n = 1.52$  ( $\bar{\lambda} = 496$  nm).

In figure 11 (b–d), equation (7) is plotted for different objects and varied parameters ( $NA$ ,  $\bar{\lambda}$ ,  $n$ ).

Optical slice  
(NA = 1.3; n = 1.52;  
 $\lambda = 496 \text{ nm}$ )

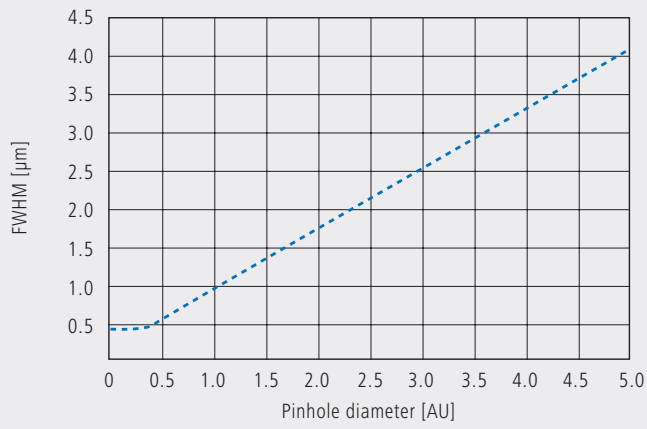
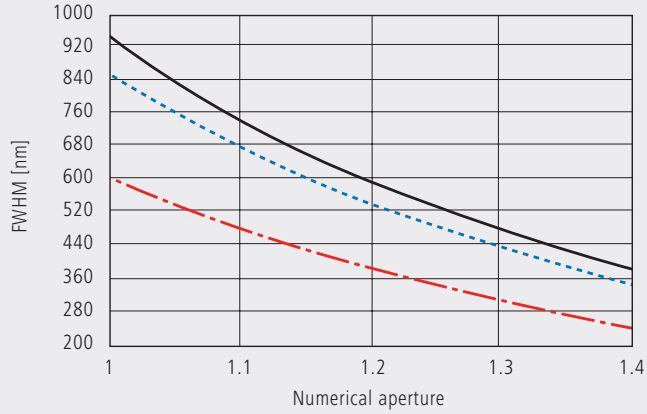


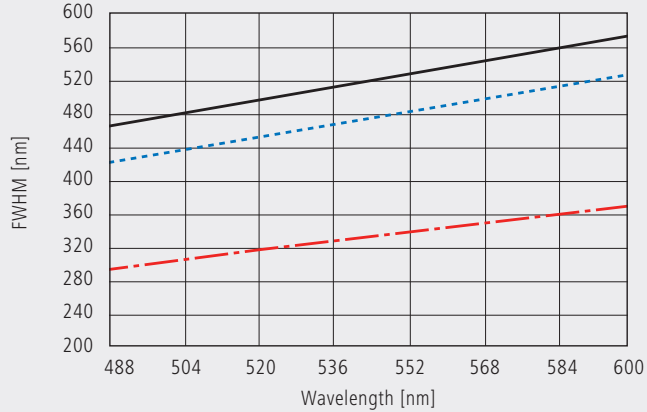
Fig. 11  
a) Variation of  
pinhole diameter

Depth resolution  
(PH = 0; n = 1.52;  
 $\lambda = 496 \text{ nm}$ )



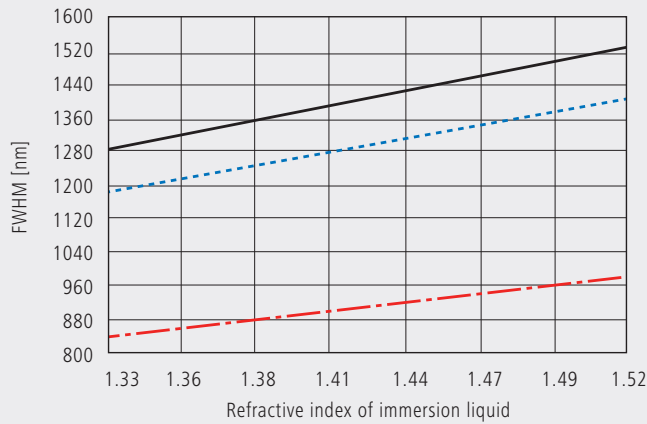
b) Variation of  
numerical aperture

Depth resolution  
(PH = 0; NA = 1.3; n = 1.52)



c) Variation of  
wavelength ( $\lambda$ )

Depth resolution  
(PH = 0; NA = 0.8;  
 $\lambda = 496 \text{ nm}$ )



d) Variation of  
refractive index

— fluorescent plane  
- - - fluorescent point  
- · - · reflecting plane (mirror)

# Overview

Conventional microscopy	Confocal microscopy $1 \text{ AU} < \text{PH} < \infty$	Confocal microscopy $\text{PH} < 0.25 \text{ AU}$
<p>1. Optical slice thickness <b>not definable</b>            With a conventional microscope, unlike in confocal microscopy, sharply defined images of “thick” biological specimens can only be obtained if their Z dimension is not greater than the wave-optical depth of field specified for the objective used. Depending on specimen thickness, object information from the focal plane is mixed with blurred information from out-of-focus object zones. Optical sectioning is not possible; consequently, no formula for optical slice thickness can be given.</p>	<p>1. Optical slice thickness<sup>1)</sup></p> $\sqrt{\left(\frac{0.88 \cdot \lambda_{em}}{n \cdot \sqrt{n^2 - NA^2}}\right)^2 + \left(\frac{\sqrt{2} \cdot n \cdot \text{PH}}{NA}\right)^2}$ <p>Corresponds to the FWHM of the intensity distribution behind the pinhole (PSF<sub>det</sub>). The FWHM results from the emission-side diffraction pattern and the geometric-optical effect of the pinhole. Here, PH is the variable object-side pinhole diameter in <math>\mu\text{m}</math>.</p>	<p>1. Optical slice thickness</p> $\frac{0.64 \cdot \bar{\lambda}}{(n \cdot \sqrt{n^2 - NA^2})}$ <p>The term results as the FWHM of the total PSF – the pinhole acts according to wave optics. <math>\bar{\lambda}</math> stands for a mean wavelength – see text for the exact definition. The factor 0.64 applies only to a fluorescent point object.</p>
<p>2. Axial resolution (wave-optical depth of field)</p> $\frac{n \cdot \lambda_{em}}{NA^2}$ <p>Corresponds to the width of the emission-side diffraction pattern at 80% of the maximum intensity, referred to the object plane. In the literature, the wave-optical depth of field in a conventional microscope is sometimes termed depth resolution. However, a clear distinction should be made between the terms resolution and depth of field.</p>	<p>2. Axial resolution</p> $\frac{0.88 \cdot \lambda_{exc}}{(n \cdot \sqrt{n^2 - NA^2})}$ <p>FWHM of PSF<sub>ill</sub> (intensity distribution at the focus of the microscope objective) in Z direction.            No influence by the pinhole.</p>	<p>2. Axial resolution</p> $\frac{0.64 \cdot \bar{\lambda}}{(n \cdot \sqrt{n^2 - NA^2})}$ <p>FWHM of total PSF in Z direction            As optical slice thickness and resolution are identical in this case, depth resolution is often used as a synonym.</p>
<p>3. For comparison: FWHM of PSF in the intermediate image (Z direction) – referred to the object plane.</p> $\frac{1.77 \cdot n \cdot \lambda_{em}}{NA^2}$	<p>3. Approximation to 2. for <math>NA &lt; 0.5</math></p> $\frac{1.77 \cdot n \cdot \lambda_{exc}}{NA^2}$	<p>3. Approximation to 2. for <math>NA &lt; 0.5</math></p> $\frac{1.28 \cdot n \cdot \bar{\lambda}}{NA^2}$
<p>4. Lateral resolution</p> $\frac{0.51 \cdot \lambda_{em}}{NA}$ <p>FWHM of the diffraction pattern in the intermediate image – referred to the object plane) in XY direction.</p>	<p>4. Lateral resolution</p> $\frac{0.51 \cdot \lambda_{exc}}{NA}$ <p>FWHM of PSF<sub>ill</sub> (intensity distribution at the focus of the microscope objective) in XY direction plus contrast-enhancing effect of the pinhole because of stray light suppression.</p>	<p>4. Lateral resolution</p> $\frac{0.37 \cdot \bar{\lambda}}{NA}$ <p>FWHM of total PSF in XY direction plus contrast-enhancing effect of the pinhole because of stray light suppression.</p>

All data in the table refer to quantities in the object space and apply to a fluorescent point object.

1)  $\text{PH} < \infty$  is meant to express a pinhole diameter of  $\approx 4\text{--}5 \text{ AU}$ .

# Sampling and Digitization

After the optical phenomena have been discussed in Part 1, Part 2 takes a closer look at how the digitizing process and system-inherent sources of noise limit the performance of the system .

As stated in Part 1, a confocal LSM scans the specimen surface point by point. This means that an image of the total specimen is not formed simultaneously, with all points imaged in parallel (as, for example, in a CCD camera), but consecutively as a series of point images. The resolution obtainable depends on the number of points probed in a feature to be resolved.

Confocal microscopy, especially in the fluorescence mode, is affected by noise of light. In many applications, the number of light quanta (photons) contributing to image formation is extremely small. This is due to the efficiency of the system as a whole and the influencing factors involved, such as quantum yield, bleaching and saturation of fluorochromes, the transmittance of optical elements etc. (see Details "Fluorescence"). An additional factor of influence is the energy loss connected with the reduction of the pinhole diameter. In the following passages, the influences of scanning and noise on resolution are illustrated by practical examples and with the help of a two-point object. This is meant to be an object consisting of two self-luminous points spaced at 0.5 AU (see Details "Optical Coordinates"). The diffraction patterns generated of the two points are superimposed in the image space, with the maximum of one pattern coinciding with the first minimum of the other. The separate visibility of the points (resolution) depends on the existence of a dip between the two maxima (see figure 13, page 20).

The object information gained by the scanning process is, in most cases, detected by a photomultiplier tube (PMT), which registers the spatial changes of object properties  $I(x)$  as a temporal intensity fluctuation  $I(t)$ . Spatial and temporal coordinates are related to each other by the speed of the scanning process ( $x=t \cdot v_{\text{scan}}$ ). The cathode of the PMT converts optical information (photon) into electrical information (photoelectron), which is intensified in the following dynode cascade. The resulting continuous electric signal is periodically sampled by a subsequent analog-to-digital (A/D) converter and thus transformed into a discrete, equidistant succession of measured data (pixels) (figure 12).

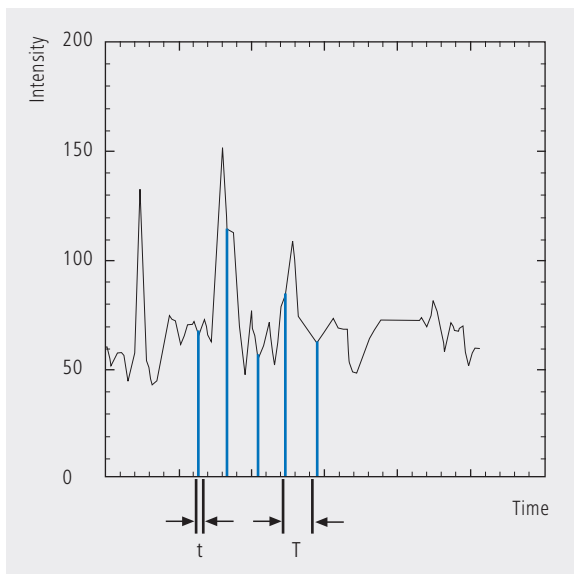
### Types of A/D conversion

The quality of the image scanned depends on the type of A/D conversion which is employed. Two types can be distinguished:

- Sampling: The time ( $t$ ) for signal detection (measurement) is small compared to the time ( $T$ ) per cycle (pixel time) (see figure 12).
- Integration: The signal detection time has the same order of magnitude as the pixel time.

Integration is equivalent to an averaging of intensities over a certain percentage of the pixel time known as pixel dwell time. To avoid signal distortion (and thus to prevent a loss of resolution), the integration time must be shorter than the pixel time. The highest resolution is attained with point sampling (the sampling time is infinitesimally short, so that a maximum density of sampling points can be obtained). By signal integration, a greater share of the light emitted by the specimen contributes to the image signal. Where signals are weak (e.g. fluorescence), this is a decisive advantage over point sampling with regard to the signal-to-noise ratio (SNR). Therefore, Carl Zeiss confocal LSM systems operate in the integration mode. The absolute integration time can be modified by varying the scanning speed, which also means a change of the pixel time.

Fig. 12 Pointwise sampling of a continuous signal  
 $T$  = spacing of two consecutive sampling points  
 $t$  = time of signal detection ( $t \ll T$ )



## Nyquist theorem

It is known from Part 1 that the information content of the signal is limited by the resolving power of the microscope optics. A realistic estimate for the resolving power is the full width at half maximum intensity (FWHM<sub>lat</sub>) of a point image (see equation 3).

To avoid a loss of information during the scanning process, it is necessary to stick to the Nyquist theorem. The optimal pixel spacing in scanning a periodic signal, as defined by the Nyquist theorem, is half the period of the feature spacing to be resolved, or two pixels per resolvable structure detail. Together with the resolving power defined above, this results in a maximum pixel spacing of  $d_{\text{pix}} = 0.5 \times \text{FWHM}_{\text{lat}}$ . With a two-point object (see explanation on page 18), the pixel spacing needed to separate the two Airy discs in the digitized image is 0.25 AU (figure 13).

If the number of sampling points per feature size is smaller than that given by the Nyquist theorem (undersampling), part of the information will be lost. This is evident in Figure 14c especially by the unresolved fine features.

A greater number of sampling points per feature size (oversampling) means a greater number of readings without a gain in information; simultaneously, the time per pixel becomes shorter. Thus, the volume of data to be processed is inflated, and the noise of the measurement signal increases (see page 22).

Under unfavorable conditions, also artefacts may result out of the digitization process (aliasing). As a rule, this is the case if the feature spacing in the specimen is equal, or nearly equal, to the pixel spacing.

Fig. 13 The graph illustrates the scanning of a two-point object with the minimum number of sampling points needed to avoid a loss of resolution (spacing of sampling points 0.25 AU).

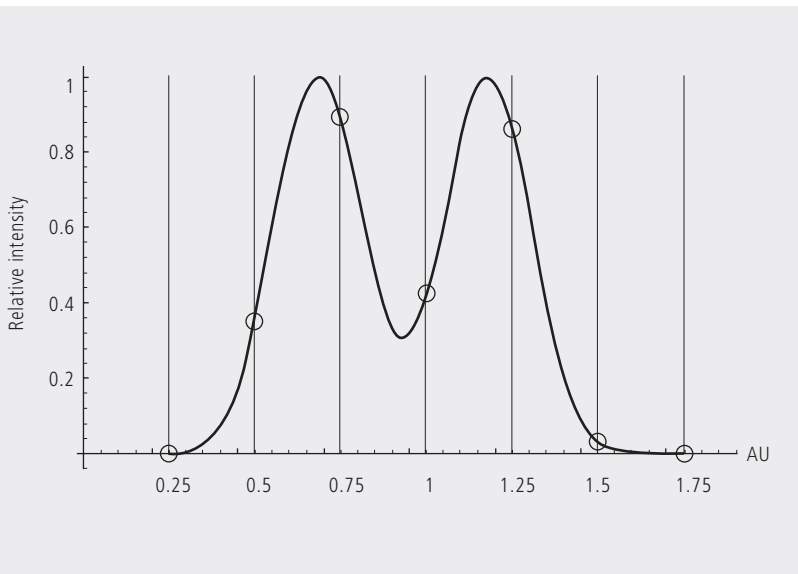
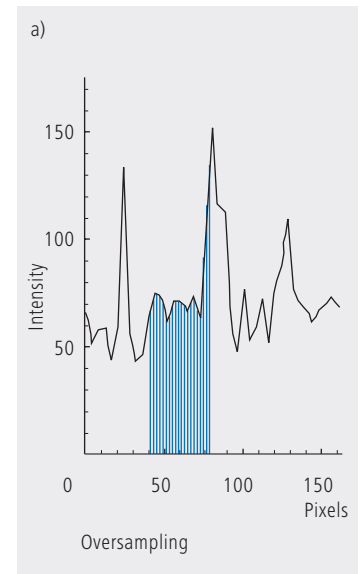


Fig. 14 Oversampling, correct sampling and undersampling of a continuous signal.



## Pixel size

A quantity of decisive importance in this connection is the maximum scanning angle set via the scanning zoom. By varying the scanning angle, it is possible to directly influence the edge length of the scanned field in the intermediate image plane (or object plane), and thus the pixel size (at a given number of pixels per line). The smaller the scanning angle, the smaller is the edge length of the scanned field, and the smaller is the pixel (see the example below). In this way, the user of a ZEISS confocal LSM can control the sampling rate (pixel size). For setting the suitable scanning zoom for correct Nyquist sampling, the pixel size  $d_{pix}$  in the object plane is important.

For a ZEISS confocal LSM, there is a simple formula, based on the edge length of the scanned field in the intermediate image:

$$d_{pix} = \frac{\text{system constant}}{\text{number of pixels} \cdot \text{zoomfactor} \cdot \text{magnification}_{obj}}$$

**Number of pixels**    number of pixels per line  
**Zoom factor (Z)**    scanning zoom set in the software  
 (Example: Zoom factor 2 reduces the edge length of the scanned field by a factor of 2)  
**Magnification<sub>obj</sub>**    objective magnification

### System constant

LSM 510, LSM 5 PASCAL	8.94 mm
LSM 700	6.36 mm
LSM 710 with Axio Observer	10.08 mm (rearport) 9.31 mm (sideport)
LSM 710 with Axio Imager	10.08 mm (rearport) 9.31 mm (tube)
LSM 710 with Axio Examiner	6.85 mm

The minimum scanning zoom needed to fulfill the Nyquist theorem can therefore be calculated as follows:

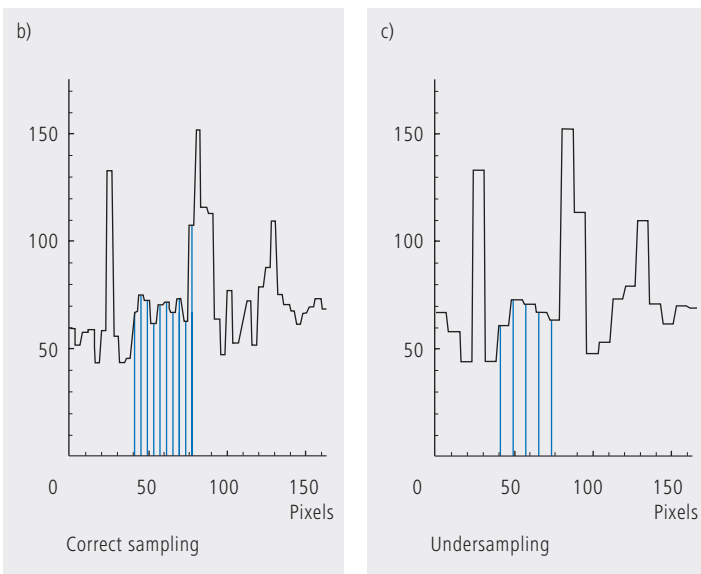
$$Z \geq \frac{3.92 \cdot NA \cdot \text{system constant}}{\text{number of pixels} \cdot \text{magnification}_{obj} \cdot \lambda_{exc}}$$

$NA$  = numerical aperture of objective  
 $\lambda_{exc}$  = excitation wavelength

As an example, with the LSM 710 / Axio Observer (sideport), a 40x objective lens ( $NA=1.2$ ), a wavelength of 488nm and 512 pixels per scanline, the full resolving power (correct sampling) is achieved with a scanning zoom of 4.38; the corresponding pixelsize then is 103.8nm. With lower factors of the scanning zoom the pixel size itself will be the limiting factor for resolution (pixel resolution). Higher factors will cause oversampling. Hence, the zoom factor influences not only the total magnification but also the resolution properties of the system.

With the more recent LSM systems from Carl Zeiss, the number of sampling points can also be influenced by an increase in the number of pixels per scan line.

(With the LSM 710 and LSM 780 the number of pixels (X/Y) per image can be freely selected between 4 x 1 and 6144 x 6144).



# Noise

The main types of noise important in a confocal LSM system are detector noise (dark noise, secondary emission noise), laser noise, and shot noise of the light (see Details “Sources of Noise”). As a rule, these sources of noise are of a statistical nature. Periodic noise rarely occurs, and if it does, it tends to correlate with defective devices or mechanical vibration in the setup; therefore it has been left out of consideration here.

As said before the number of photons hitting the PMT depends not only on the intensity of the fluorescence signal (see Details “Fluorescence”), but also on the diameter of the pinhole. The graph in figure 15 show the intensity distribution of a two-point object resulting behind the pinhole, in normalized (left) and non-normalized form (right). The pinhole diameter was varied between 2 AU and 0.05 AU. At a diameter of 1 AU the pinhole just equals the size of the Airy disk, so that there is only a slight loss in intensity. The gain in lateral resolution, is minimum in this case.

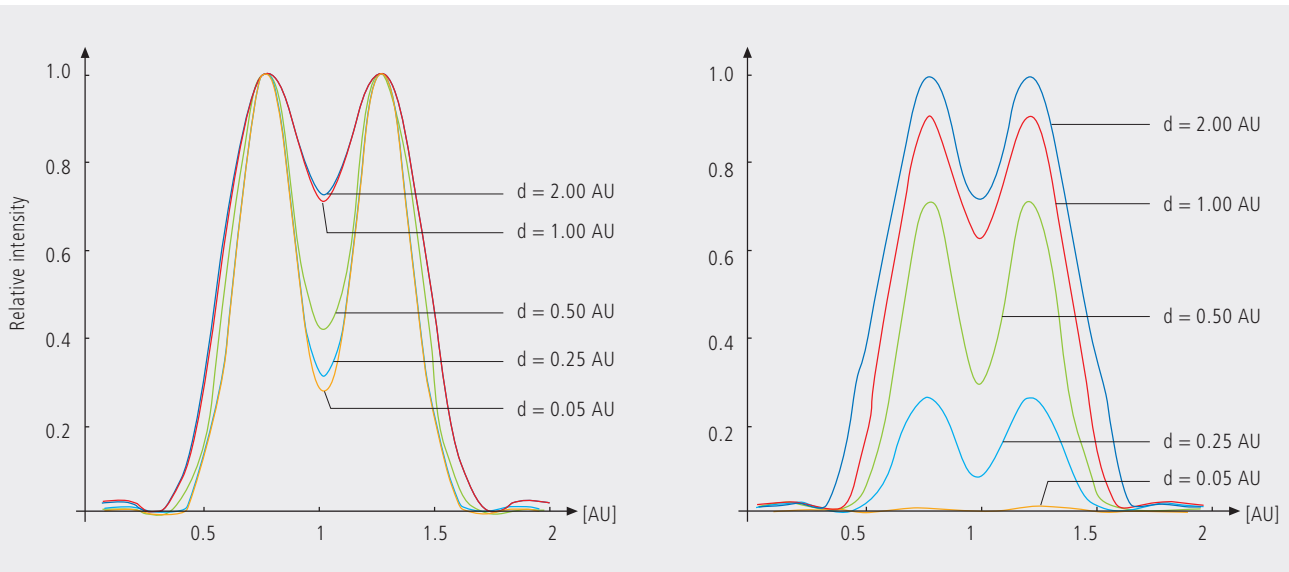
With a pinhole diameter  $<1$  AU, resolution improves (better point separation thanks to a deeper dip), which is penalized by a drastic loss in energy.

Moreover, it should be considered that it depends on the signal level which noise source dominates. With high-amplitude signals (number of detected photons  $>10.000$ ), laser noise is the dominating effect, whereas the quality of low signals (number of detected photons  $<1000$ ) is limited by the shot noise of the light.

Therefore, laser noise tends to be the decisive noise factor in observations in the reflection mode, while shot noise dominates in the fluorescence mode. With recent PMT models (e.g., from Hamamatsu), detector dark noise is extremely low, same as secondary emission noise, and both can be neglected in most practical applications (see Details “Sources of Noise”).

Therefore, the explanations below are focused on the influence of shot noise on lateral resolution.

*Fig. 15 As shown in Part 1, small pinhole diameters lead to improved resolution (smaller FWHM, deeper dip – see normalized graph on the left). The graph on the right shows, however, that constricting the pinhole is connected with a drastic reduction in signal level. The drop in intensity is significant from PH  $<1$  AU to PH = 0.05.*





### Resolution and shot noise – resolution probability

If the number of photons detected ( $N$ ) is below 1000, fluorescence emission should be treated as a stochastic rather than a continuous process; it is necessary, via the shot noise, to take the quantum nature of light into account (the light flux is regarded as a photon flux, with a photon having the energy  $E = h \cdot \nu$ ). Resolution becomes contingent on random events (the random incidence of photons on the detector), and the gain in resolution obtainable by pinhole constriction is determined by the given noise level. Figure 16 will help to understand the quantum nature of light.

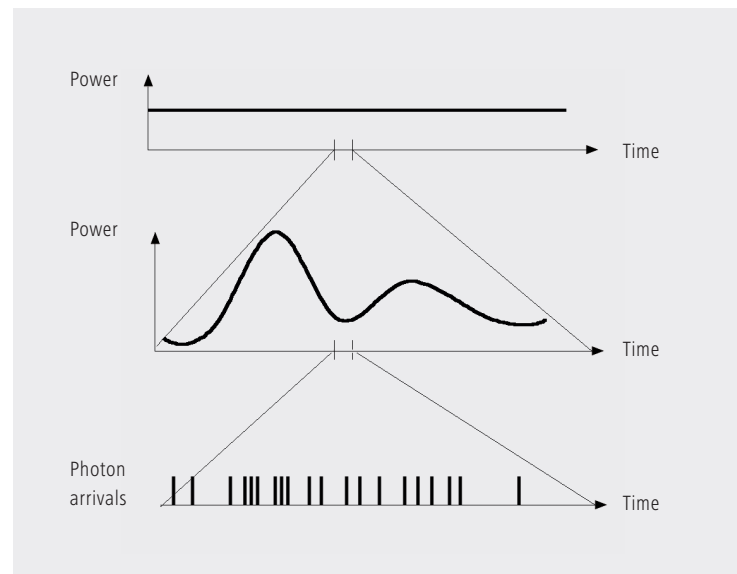
As a possible consequence of the shot noise of the detected light, it may happen, for example, that noise patterns that change because of photon statistics, degrade normally resolvable object details in such a way that they are not resolved every time in repeated measurements. On the other hand, objects just outside optical resolvability may appear resolved because of noise patterns modulated on them. Resolution of the “correct” object structure is the more probable the less noise is involved, i.e. the more photons contribute to the formation of the image.

Therefore, it makes sense to talk of resolution probability rather than of resolution. Consider a model which combines the purely optical understanding of image formation in the confocal microscope (PSF) with the influences of shot noise of the detected light and the scanning and digitization of the object. The essential criterion is the discernability of object details.

Fig. 16 The quantum nature of light can be made visible in two ways:  
 • by reducing the intensity down to the order of single photons and  
 • by shortening the observation time at constant intensity, illustrated in the graph below: The individual photons of the light flux can be resolved in their irregular (statistical) succession.

Figure 17 (page 24) shows the dependence of the resolution probability on signal level and pinhole diameter by the example of a two-point object and for different numbers of photoelectrons per point object. [As the image of a point object is covered by a raster of pixels, a normalization based on pixels does not appear sensible.]

Thus, a number of 100 photoelectrons/point object means that the point object emits as many photons within the sampling time as to result in 100 photoelectrons behind the light-sensitive detector target (PMT cathode). The number of photoelectrons obtained from a point object in this case is about twice the number of photoelectrons at the maximum pixel (pixel at the center of the Airy disk). With photoelectrons as a unit, the model is independent of the sensitivity and noise of the detector and of detection techniques (absolute integration time / point sampling / signal averaging). The only quantity looked at is the number of detected photons.



A resolution probability of 90% is considered necessary for resolving the two point images. Accordingly, the two-point object defined above can only be resolved if each point produces at least about 25 photoelectrons. With pinhole diameters smaller than 0.25 AU, the drastic increase in shot noise (decreasing intensity of the detected light) will in any case lead to a manifest drop in resolution probability, down to the level of indeterminateness ( $\leq 50\%$  probability) at PH = 0.

As another consequence of shot noise, the curve maximum shifts toward greater pinhole diameters as the number of photoelectrons drops.

The general slight reduction of resolution probability towards greater pinhole diameters is caused by the decreasing effectiveness of the pinhole (with regard to suppression of out-of-focus object regions, see Part 1).

The pinhole diameter selected in practice will therefore always be a trade-off between two quality parameters: noise (SNR as a function of the intensity of the detected light) and resolution (or depth discrimination). The pinhole always needs a certain minimum aperture to allow a minimum of radiation (depending on the intensity of fluorescence) to pass to the detector.

Where fluorescence intensities are low, it may be sensible to accept less than optimum depth discrimination so as to obtain a higher signal level (higher intensity of detected light = less noise, better SNR). For most fluorescent applications a pinhole diameter of about 1 AU has turned out to be the best compromise.

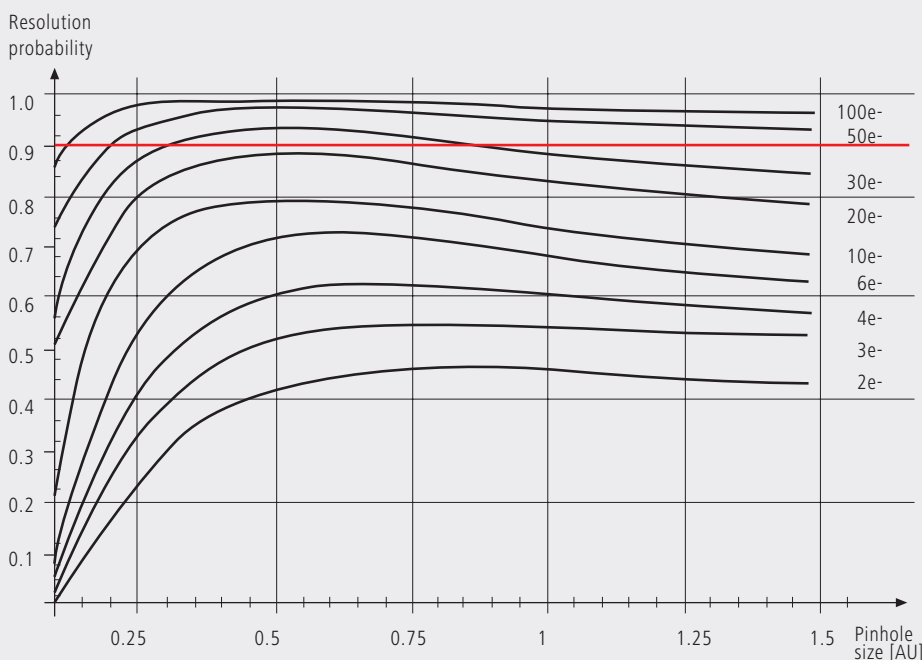


Fig. 17 The graph shows the computed resolution probability of two self-luminous points (fluorescence objects) spaced at 1/2 AU, as a function of pinhole size and for various photoelectron counts per point object (e-). The image raster conforms to the Nyquist theorem (critical raster spacing = 0.25 AU); the rasterized image is subjected to interpolation. The photoelectron count per point object is approximately twice that per pixel (referred to the pixel at the center of the Airy disk). Each curve has been fitted to a fixed number of discrete values, with each value computed from 200 experiments.

The resolution probability is the quotient between successful experiments (resolved) and the total number of experiments. A resolution probability of 70% means that 7 out of 10 experiments lead to resolved structures. A probability > 90% is imperative for lending certainty to the assumption that the features are resolved. If we assume a point-like fluorescence object containing 8 FITC fluorescence molecules (fluorochrome concentration of about 1 nMol) a laser power of 100  $\mu$ W in the pupil and an objective NA of 1.2 ( $n = 1.33$ ), the result is about 45 photoelectrons / point object on the detection side.

### Possibilities to improve SNR

Pinhole diameters providing a resolution probability below 90% may still yield useful images if one uses a longer pixel time or employs the signal averaging function. In the former case, additional photons are collected at each pixel; in the latter case, each line of the image, or the image as a whole, is scanned repeatedly, with the intensities being accumulated or averaged. The influence of shot noise on image quality decreases as the number of photons detected increases. As fluorescence images in a confocal LSM tend to be shot-noise-limited, the increase in image quality by the methods described is obvious.

Furthermore, detector noise, same as laser noise at high signal levels, is reduced. The figures on the right show the influence of pixel time (figure 18) and the influence of the number of signal acquisitions (figure 19) on SNR in [dB]. The linearity apparent in the semilogarithmic plot applies to shot-noise-limited signals only. (As a rule, signals are shot-noise-limited if the PMT high voltage needed for signal amplification is greater than 500 V).

A doubling of pixel time, same as a doubling of the number of signal acquisitions, improves SNR by a factor of about  $\sqrt{2}$  (3 dB). The advantage of the averaging method is the lower laser load on the specimen, as the exposure time per

pixel remains constant. Photon statistics are improved by the addition of photons from several scanning runs ( $\text{SNR} = \sqrt{n \cdot N}$ ;  $N = \text{constant}$ ,  $n = \text{number of scans averaged}$ ). By comparison, a longer pixel time directly improves the photon statistics by a greater number  $N$  of photons detected per pixel ( $\text{SNR} = \sqrt{N}$ ,  $N = \text{variable}$ ), but there is a greater probability of photobleaching or saturation effects of the fluorophores (see also details "Fluorescence").

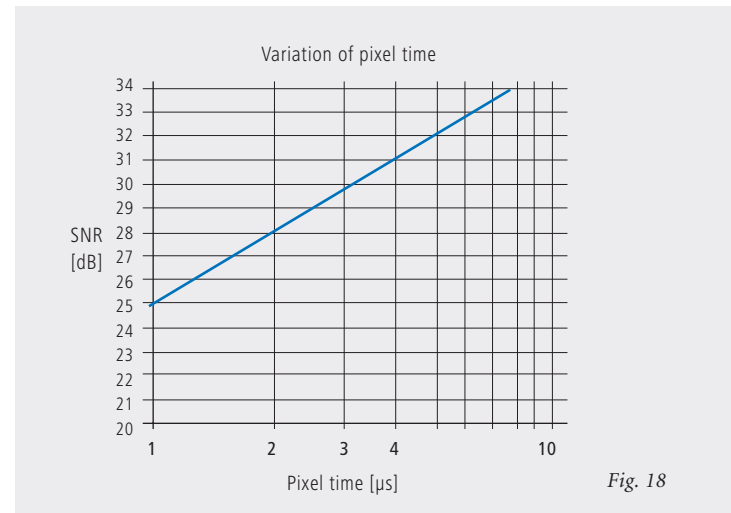


Fig. 18

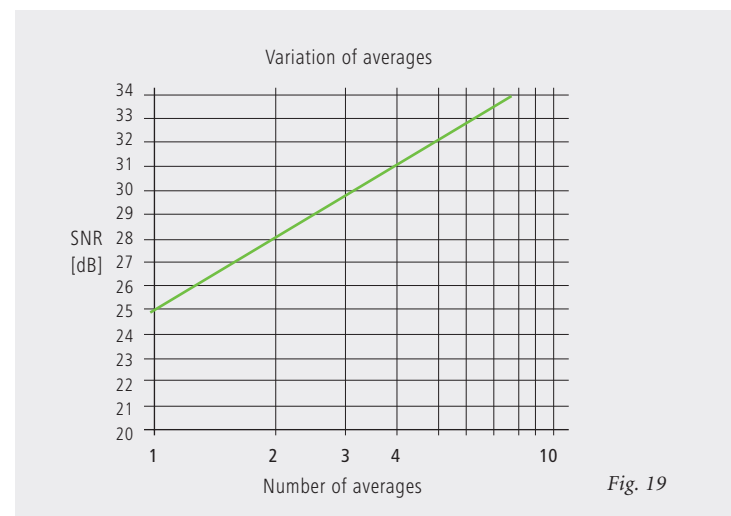
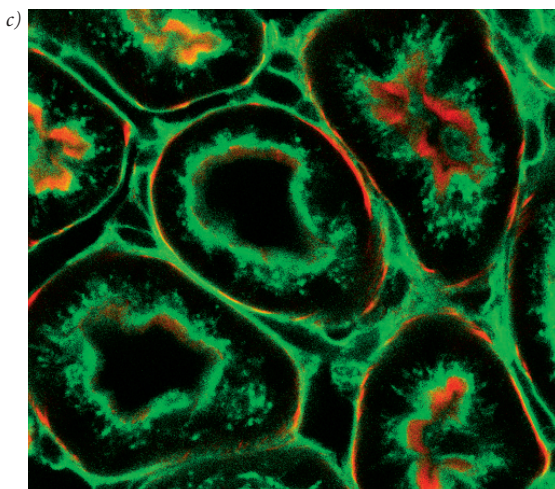
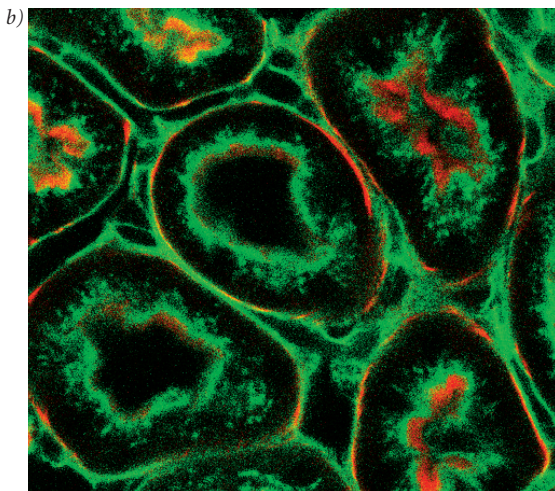
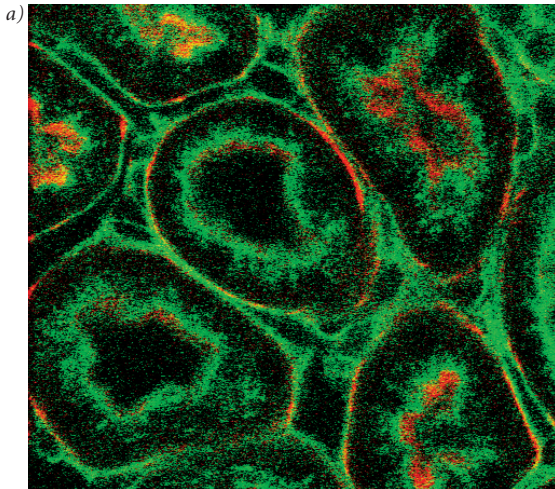


Fig. 19

Figures 18 and 19 Improvement of the signal-to-noise ratio. In figure 18 (top), pixel time is varied, while the number of signal acquisitions (scans averaged) is constant. In figure 19 (bottom), pixel time is constant, while the number of signal acquisitions is varied. The ordinate indicates SNR in [dB], the abscissa the free parameter (pixel time, scans averaged).



The pictures on the left demonstrate the influence of pixel time and averaging on SNR; object details can be made out much better if the pixel time increases or averaging is employed.

Another sizeable factor influencing the SNR of an image is the efficiency of the detection beam path. This can be directly influenced by the user through the selection of appropriate filters and dichroic beamsplitters. The SNR of a FITC fluorescence image, for example, can be improved by a factor of about 2 (6dB) if the element separating the excitation and emission beam paths is not a neutral 80/20 beamsplitter<sup>1</sup> but a dichroic beamsplitter optimized for the particular fluorescence.

The difficult problem of quantifying the interaction between resolution and noise in a confocal LSM is solved by way of the concept of resolution probability; i.e. the unrestricted validity of the findings described in Part 1 is always dependent on a sufficient number of photons reaching the detector.

Therefore, most applications of confocal fluorescence microscopy tend to demand pinhole diameters greater than 0.25 AU; a diameter of 1 AU is a typical setting.

*Fig. 20 Three confocal images of the same fluorescence specimen (mouse kidney section, glomeruli labeled with Alexa488 in green and actin labelled with Alexa 564 phalloidin in red).*

*All images were recorded with the same parameters, except pixel time and average. The respective pixel times were 0.8  $\mu$ s in a), 6.4  $\mu$ s (no averaging) in b), and 6.4  $\mu$ s plus 4 times line-wise averaging in c).*

<sup>1</sup> An 80/20 beamsplitter reflects 20% of the laser light onto the specimen and transmits 80% of the emitted fluorescence to the detector.

# Glossary

<b><math>\alpha</math></b>	Aperture angle of a microscope objective
<b>AU</b>	Airy unit (diameter of Airy disc)
<b>dpix</b>	Pixel size in the object plane
<b>FWHM</b>	Full width at half maximum of an intensity distribution (e.g. optical slice)
<b>n</b>	Refractive index of an immersion liquid
<b>NA</b>	Numerical aperture of a microscope objective
<b>PH</b>	Pinhole; diaphragm of variable size arranged in the beam path to achieve optical sections
<b>PMT</b>	Photomultiplier tube (detector used in LSM)
<b>PSF</b>	Point spread function
<b>RU</b>	Rayleigh unit
<b>SNR</b>	Signal-to-noise ratio



To give some further insight into Laser Scanning Microscopy, the following pages treat several aspects of particular importance for practical work with a Laser Scanning Microscope.

Pupil Illumination

Optical Coordinates

Fluorescence

Sources of Noise

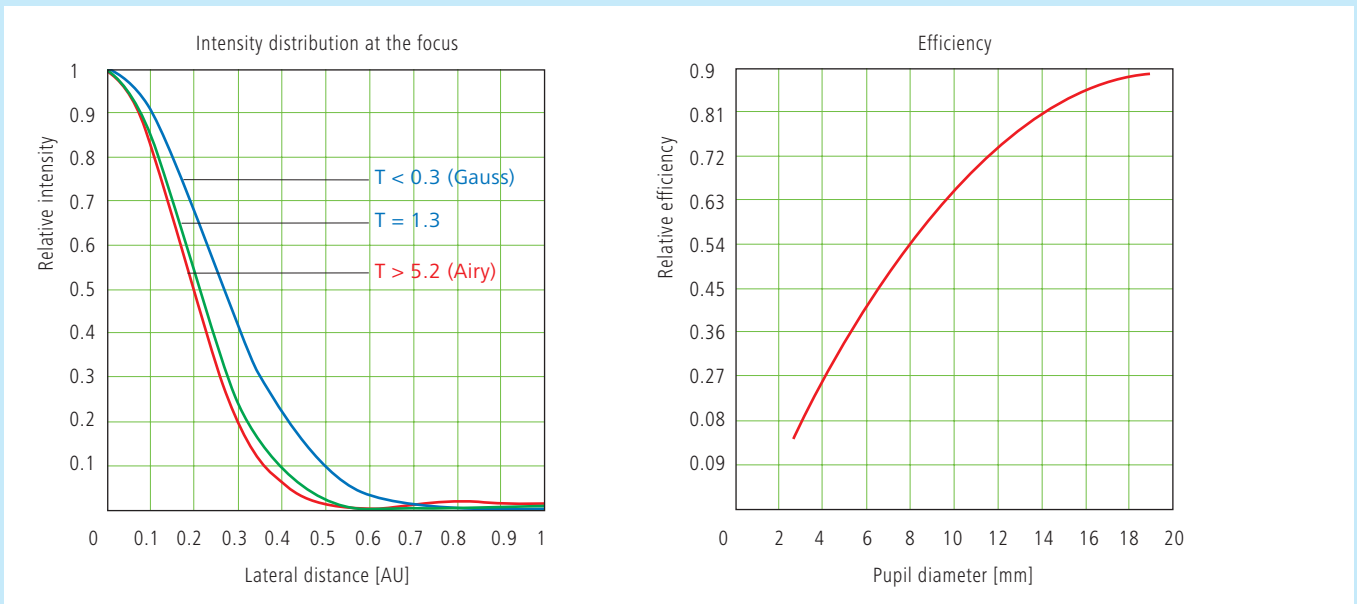
# Pupil Illumination

All descriptions in this monograph suggest a confocal LSM with a ray geometry providing homogeneous illumination at all lens cross sections. It is known that the intensity distribution generated in the focus of the objective lens, is the Fourier transform of the intensity distribution in the objective's pupil plane (backfocal plane). Hence it follows, that a homogeneous distribution in the pupil plane results in a focal distribution following the Airy function (also known as Airy disk) [In Carl Zeiss microscope objectives, the pupil diameter is implemented by a physical aperture close to the mounting surface of the lens].

The Airy distribution is characterized by a smaller width at half maximum and thus by a higher resolving power than a Gaussian distribution. Fig. A left shows the normalized intensity distribution at the focal plane as a function of different truncation factor's T (T is the ratio of the laser beam diameter ( $1/e^2$ ) and the pupil diameter of the objective lens). The red curve results at a homogeneous pupil illumination with  $T > 5.2$ , while the blue one is obtained at a Gaussian pupil illumination with  $T \leq 0.5$ ; the green curve corresponds

to a truncation factor  $T=1.3$ . The lateral coordinate is normalized in Airy units (AU). From  $T=3$ , the Airy character is predominating to a degree that a further increase in the truncation factor no longer produces a gain in resolution. Because of the symmetry of the point image in case of diffraction-limited imaging, the graph only shows the intensity curve in the +X direction. Furthermore any truncation of the illuminating beam cross-section at the pupil plane causes a certain energy loss and thus a decrease in efficiency. Figure A (right) shows the percentage efficiency as a function of pupil diameter in millimeter, with constant laser beam expansion. The smaller the pupil diameter, the higher the T-factor, and the higher the energy loss (i.e. the smaller the efficiency). Example: If the objective lens utilizes 50% of the illuminating energy supplied, this means about 8% resolution loss compared to the ideal Airy distribution. Reducing the resolution loss to 5% is penalized by a loss of 70% of the illuminating energy. In practice, the aim is to reach an optimal approximation to a homogeneous pupil illumination with a reasonable loss in efficiency.

Fig. A



The truncation factor T is defined as the ratio of laser beam diameter ( $1/e^2$ ) and pupil diameter of the objective lens used:

$$T = \frac{d_{laser}}{d_{pupille}} \quad \text{the resulting efficiency is defined as} \quad \eta = 1 - e^{-\frac{2}{T^2}}$$

The full width at half maximum of the intensity distribution at the focal plane is defined as:

$$FWHM = 0.71 \cdot \frac{\lambda}{NA} \cdot \omega \quad \text{with} \quad \omega = \sqrt{0.51 + 0.14 \cdot \ln\left(\frac{1}{1-n}\right)}$$

With  $T < 0.6$ , the Gaussian character, and with  $T > 1$  the Airy character predominates the resulting intensity distribution.



## Optical Coordinates

In order to enable a representation of lateral and axial quantities independent of the objective lens used, let us introduce optical coordinates oriented to microscopic imaging.

Given the imaging conditions in a confocal microscope, it suggests itself to express all lateral sizes as multiples of the Airy disk diameter. Accordingly, the Airy unit (AU) is defined as:

$$1AU = \frac{1.22 \cdot \bar{\lambda}}{NA}$$

$NA$  = numerical aperture of the objective  
 $\bar{\lambda}$  = mean wavelength  
 with  $NA = 1.3$  and  $\bar{\lambda} = 496 \text{ nm}$   $\rightarrow 1AU = 0.465 \mu\text{m}$

The AU is primarily used for normalizing the pinhole diameter.

Thus, when converting a given pinhole diameter into AUs, we need to consider the system's total magnification; which means that the Airy disk is projected onto the plane of the pinhole (or vice versa).

Analogously, a sensible way of normalization in the axial direction is in terms of multiples of the wave-optical depth of field. Proceeding from the Rayleigh criterion, the following expression is known as Rayleigh unit (RU):

$$1RU = \frac{n \cdot \bar{\lambda}}{NA^2}$$

$n$  = refractive index of immersion liquid  
 with  $NA = 1.3$ ,  $\bar{\lambda} = 496 \text{ nm}$  and  $n = 1.52$   $\rightarrow 1RU = 0.446 \mu\text{m}$

The RU is used primarily for a generally valid representation of the optical slice thickness in a confocal LSM.

# Fluorescence

Fluorescence is one of the most important contrasting methods in biological confocal microscopy.

Cellular structures can be specifically labeled with dyes (fluorescent dyes = fluorochromes or fluorophores) in various ways. Let the mechanisms involved in confocal fluorescence microscopy be explained by taking fluorescein as an example of a fluorochrome. Fluorescein has its absorption maximum at 490 nm. It is common to equip a confocal LSM with an argon laser with an output of 15–20 mW at the 488 nm line. Let the system be adjusted to provide a laser power of 500  $\mu$ W in the pupil of the microscope objective. Let us assume that the microscope objective has the ideal transmittance of 100%.

With a C-Apochromat 63x/1.2W, the power density at the focus, referred to the diameter of the Airy disk, then is  $2.58 \cdot 10^5$  W/cm<sup>2</sup>. This corresponds to an excitation photon flux of  $6.34 \cdot 10^{23}$  photons/cm<sup>2</sup> sec. In conventional fluorescence microscopy, with the same objective, comparable lighting power (xenon lamp with 2 mW at 488 nm) and a visual field diameter of 20 mm, the excitation photon flux is only  $2.48 \cdot 10^{18}$  photons/cm<sup>2</sup> sec, i.e. lower by about five powers of ten.

This is understandable by the fact that the laser beam in a confocal LSM is focused into the specimen, whereas the specimen in a conventional microscope is illuminated by parallel light.

The point of main interest, however, is the fluorescence (F) emitted.

The emission from a single molecule (F) depends on the molecular cross-section ( $\sigma$ ), the fluorescence quantum yield (Qe) and the excitation photon flux (I) as follows:

$$F = \sigma \cdot Qe \cdot I \text{ [photons/sec]}$$

In principle, the number of photons emitted increases with the intensity of excitation. However, the limiting parameter is the maximum emission rate of the fluorochrome molecule, i.e. the number of photons emittable per unit of time. The maximum emission rate is determined by the lifetime (= radiation time) of the excited state. For fluorescein this is about 4.4 nsec (subject to variation according to the ambient conditions). On average, the maximum emission rate of fluorescein is  $2.27 \cdot 10^8$  photons/sec. This corresponds to an excitation photon flux of  $1.26 \cdot 10^{24}$  photons/cm<sup>2</sup> sec. At rates greater than  $1.26 \cdot 10^{24}$  photons/cm<sup>2</sup> sec, the fluorescein molecule becomes saturated. An increase in the excitation photon flux will then no longer cause an increase in the emission rate; the number of photons absorbed remains constant. In our example, this case occurs if the laser power in the pupil is increased from 500  $\mu$ W to roughly 1mW. Figure B (top) shows the relationship between the excitation photon flux and the laser power in the pupil of the stated objective for a wavelength of 488 nm. Figure B (bottom) illustrates the excited-state saturation of fluorescein molecules. The number of photons absorbed is approximately proportional to the number of photons emitted (logarithmic scaling).

The table below lists the characteristics of some important fluorochromes:

	Absorpt. max.(nm)	$\sigma/10^{-16}$	Qe	$\sigma^*Q/10^{-16}$
Rhodamine	554	3.25	0.78	0.91
Fluorescein	490	2.55	0.71	1.81
Texas Red	596	3.3	0.51	1.68
Cy 3.18	550	4.97	0.14	0.69
Cy 5.18	650	7.66	0.18	1.37

Source:  
Handbook of Biological Confocal Microscopy, p. 268/Waggoner  
In the example chosen,  
 $F = 1.15 \cdot 10^8$  photons/sec or 115 photons/ $\mu$ sec

What has been said so far is valid only as long as the molecule is not affected by photobleaching. In an oxygen-rich environment, fluorescein bleaches with a quantum efficiency of about  $2.7 \cdot 10^{-5}$ . Therefore, a fluorescence molecule can, on average, be excited  $n = 26.000$  times ( $n = Q/Q_b$ ) before it disintegrates.

With  $t = \frac{n}{F_{\max}}$ , and referred to the maximum emission rate, this corresponds to a lifetime of the fluorescein molecule of about  $115 \mu\text{s}$ .

It becomes obvious that an increase in excitation power can bring about only a very limited gain in the emission rate. While the power provided by the laser is useful for FRAP (fluorescence recovery after photobleaching) experiments, it is definitely too high for normal fluorescence applications. Therefore it is highly important that the excitation power can be controlled to fine increments in the low-intensity range.

A rise in the emission rate through an increased fluorophore concentration is not sensible either, except within certain limits. As soon as a certain molecule packing density is exceeded, other effects (e.g. quenching) drastically reduce the quantum yield despite higher dye concentration.

Another problem to be considered is the system's detection sensitivity. As the fluorescence radiated by the molecule goes to every spatial direction with the same probability, about 80% of the photons will not be captured by the objective aperture ( $NA = 1.2$ ).

With the reflectance and transmittance properties of the subsequent optical elements and the quantum efficiency of the PMT taken into account, less than 10% of the photons emitted are detected and converted into photoelectrons (photoelectron = detected photon).

In case of fluorescein ( $NA=1.2$ ,  $100 \mu\text{W}$  excitation power,  $\lambda = 488 \text{ nm}$ ), a photon flux of  $F \sim 23$  photons/ $\mu\text{sec}$  results. In combination with a sampling time of  $4 \mu\text{sec}/\text{pixel}$  this means 3–4 photoelectrons/molecule and pixel.

In practice, however, the object observed will be a labeled cell. As a rule, the cell volume is distinctly greater than the volume of the sampling point. What is really interesting, therefore, is the number of dye molecules contained in the sampling volume at a particular dye concentration. In the following considerations, diffusion processes of fluorophore molecules are neglected. The computed numbers of photoelectrons are based on the parameters listed above.

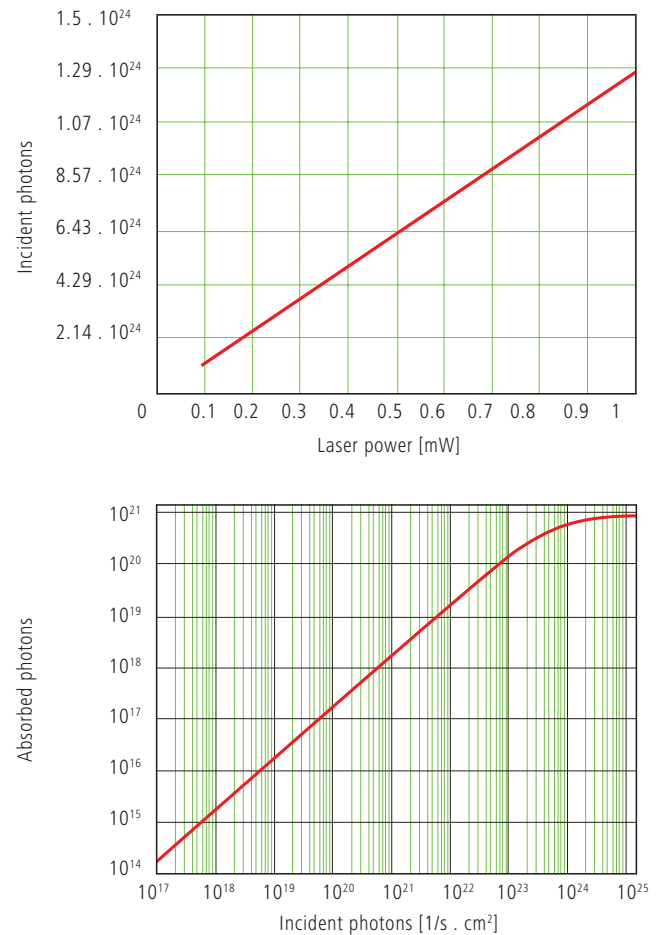


Fig. B Excitation photon flux at different laser powers (top) and excited-state saturation behavior (absorbed photons) of fluorescein molecules (bottom).

With  $\lambda = 488 \text{ nm}$  and  $NA = 1.2$  the sampling volume can be calculated to be  $V = 12.7 \cdot 10^{-18} \text{ l}$ . Assuming a dye concentration of  $0.01 \mu\text{Mol/l}$ , the sampling volume contains about 80 dye molecules. This corresponds to a number of about 260 photoelectrons/pixel. With the concentration reduced to  $1 \text{ nMol/l}$ , the number of dye molecules drops to 8 and the number of photoelectrons to 26/pixel.

Finally it can be said that the number of photons to be expected in many applications of confocal fluorescence microscopy is rather small ( $<1000$ ). If measures are taken to increase the number of photons, dye-specific properties such as photobleaching have to be taken into account.

# Sources of Noise

Sources of noise effective in the LSM exist everywhere in the signal chain – from the laser unit right up to A/D conversion. Essentially, four sources of noise can be distinguished:

## Laser noise q

Laser noise is caused by random fluctuations in the filling of excited states in the laser medium. Laser noise is proportional to the signal amplitude N and therefore significant where a great number of photons (N<10000) are detected.

## Shot noise (Poisson noise)

Shot noise is caused by the quantum nature of light. Photons with the energy  $h \cdot \nu$  hit the sensor at randomly distributed time intervals. The effective random distribution is known as Poisson distribution. Hence,

$$SNR = \Delta N_{Poisson} = \sqrt{N}$$

where N = number of photons detected per pixel time (= photoelectrons = electrons released from the PMT cathode by incident photons). With low photoelectron numbers (N < 1000), the number N of photons incident on the sensor can only be determined with a certainty of  $\pm\sqrt{N}$ .

N can be computed as

$$N = \frac{\text{photons}}{QE(\lambda) \cdot \text{pixel time}}$$

where  $QE(\lambda)$  = quantum yield of the sensor at wavelength  $\lambda$ ; 1 photon =  $h \cdot c / \lambda$ ; c = light velocity; h = Planck's constant

## Secondary emission noise

Secondary emission noise is caused by the random variation of photoelectron multiplication at the dynodes of a PMT. The amplitude of secondary emission noise is a factor between 1.1 and 1.25, depending on the dynode system and the high voltage applied (gain).

Generally, the higher the PMT voltage, the lower the secondary emission noise; a higher voltage across the dynodes improves the collecting efficiency and reduces the statistical behavior of multiplication.

## Dark noise

Dark noise is due to the generation of thermal dark electrons  $N_d$ , irrespective of whether the sensor is irradiated.  $N_d$  statistically fluctuates about  $\sqrt{N_d}$ . Dark noise is specified for a PMT voltage of 1000 V; with lower voltages it progressively loses significance.

Dark noise can be reduced by cooling the sensor. However, the reduction is significant only if  $N \leq N_d$ , e.g. in object-free areas of a fluorescence specimen. In addition, the dark noise must be the dominating noise source in order that cooling of the detector effects a signal improvement; in most applications, this will not be the case.

Additional sources of noise to be considered are amplifier noise in sensor diodes and readout noise in CCD sensors. In the present context, these are left out of consideration. The mean square deviation  $\Delta N$  from the average (N+N<sub>d</sub>) of the photoelectrons and dark electrons registered, is

$$\Delta N = se \cdot \sqrt{(N+N_d)(1+q^2)}$$

so that the total signal-to-noise ratio can be given as

$$SNR = \sqrt{\frac{N^2}{se^2 (N+N_d) (1+q^2)}}$$

where

N = number of photoelectrons per pixel time (sampling time)

se = multiplication noise factor of secondary emission

q = peak-to-peak noise factor of the laser

$N_d$  = number of dark electrons in the pixel or sampling time

Example:

For N = 1000,  $N_d = 100$ , se = 1.2, and q = 0.05

$$SNR = \sqrt{\frac{1000^2}{1.2^2 (1000+100) (1+0.05^2)}} = 25.1$$

# Literature

- 1. Beyer, H.,**  
*Handbuch der Mikroskopie, 2nd Edition,*  
VEB Verlag Technik Berlin, (1985)
- 2. Born & Wolf,**  
*Principles of Optics,*  
6th edition 1988, Pergamon Press
- 3. Brismar, H., Trepte, O., Ulfhake, B.:**  
*Spectra and Fluorescence Lifetimes of Lissamine, Rhodamine etc.....: Influences of Some Environmental Factors Recorded with a Confocal Laser Scanning Microscope, The Journal of Histochemistry and Cytochemistry, Vol. 43,* pp. 699-707, (7/1995)
- 4. Cox, G.,**  
*Optical Imaging Techniques in Cell Biology,*  
CRC Press (2007)
- 5. Keller, H.E.,**  
*Objective Lens for Confocal Microscopy,*  
*Handbook of Biological Confocal Microscopy,*  
pp. 111-125, Plenum Press, 2nd Edition (1995)
- 6. Gröbler, B.,**  
*Untersuchungen zur Bildübertragung in ab-tastenden Mikroskopen unter besonderer Berücksichtigung der 3D-Abbildung, PhD thesis,*  
University of Potsdam, (1995)
- 7. Hell, S., et al.,**  
*Aberrations in confocal fluorescence microscopy induced by mismatches in refractive index,*  
*Journal of Microscopy, Vol. 169,* pp. 391-405 (3/1993)
- 8. Hibbs, A. H.,**  
*Confocal Microscopy for Biologists, Kluwer Academic / Plenum Publishers (2004)*
- 9. Nitschke, R., Wilhelm, S., et al.,**  
*A modified confocal laser scanning microscope allows fast ultraviolet ratio imaging of intracellular Ca<sup>2+</sup> activity using Fura 2, Euro. J. Physiology, Vol. 433:* pp. 653-663, (1997)
- 10. Oldenbourg, R. et al.,**  
*Image sharpness and contrast transfer in coherent confocal microscopy, Journal of Microscopy Vol. 172,* pp. 31-39, (10/1993)
- 11. Pawley, J.,**  
*Handbook of Biological Confocal Microscopy,*  
Springer, 3rd Edition (2006)
- 12. Stelzer, E.H.K.,**  
*The intermediate optical system of laser scanning confocal microscopes; Handbook of Biological Confocal Microscopy, pp. 207-220. Springer, 3rd Edition (2006)*
- 13. Stelzer, E.H.K., et. al.,**  
*Nondestructive sectioning of fixed and living specimens using a confocal scanning laser fluorescence microscope: Microtomoscopy; SPIE, Vol. 809,* pp. 130-136, (1987)
- 14. Tanke, H.J., van Oostveldt, P., et al.,**  
*A parameter for the distribution of fluorophores in cells derived from measurements of inner filter effect and reabsorption phenomenon, Cytometry Vol. 2,* pp. 359-369 (6/1982)
- 15. Tsien, R.Y., Waggoner, A.,**  
*Fluorophores for Confocal Microscopy,*  
*Handbook of Biological Confocal Microscopy,*  
pp. 338-352. Springer, 3rd Edition (2006)
- 16. Webb, R.H., Dorey, C.K.,**  
*The Pixelated Image, Handbook of Biological Confocal Microscopy, pp. 55-66, Plenum Press, 2nd Edition (1995)*
- 17. Wilson, T., Carlini, A.R.,**  
*Three dimensional imaging in confocal imaging systems with finite sized detectors; Journal of Microscopy, Vol. 149,* pp. 51-66, (1/1988)
- 18. Wilson, T., Carlini, A.R.,**  
*Size of detector in confocal imaging systems; Optical Letters Vol. 12,* pp. 227-229, (4/1987)
- 19. Wilson, T., Sheppard, C.J.R.,**  
*Theory and Practice of Scanning Optical Microscopy,*  
Academic Press, 2nd Edition (1985)
- 20. Yuste, R., Konnerth, a.,**  
*Imaging in Neuroscience and Development,*  
CSHL Press (2005)

We gratefully acknowledge the assistance of Bernhard Gröbler,  
Hartmut Heinz and all other staff members who contributed  
to this brochure.

Carl Zeiss Microscopy GmbH  
07740 Jena, Germany

BioSciences | Jena Location  
Phone: +49 3641 64 3400  
Telefax: +49 3641 64 3144  
E-Mail: [micro@zeiss.de](mailto:micro@zeiss.de)

[www.zeiss.de/lsm](http://www.zeiss.de/lsm)

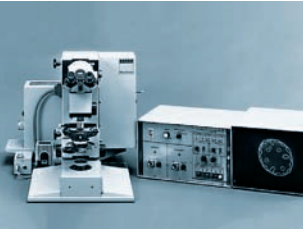
Information subject to change.  
Printed on environmentally friendly paper  
bleached without chlorine.  
60-1-0030/e – printed 11.10  
ISBN: 978-3-940885-02-9







## Highlights of Laser Scanning Microscopy



### **1982**

The first Laser Scanning Microscope from Carl Zeiss. The prototype of the LSM 44 series is now on display in the Deutsches Museum in Munich.



### **1988**

The LSM 10 – a confocal system with two fluorescence channels.



### **1991**

The LSM 310 combines confocal laser scanning microscopy with state-of-the-art computer technology.

### **1992**

The LSM 410 is the first inverted microscope of the LSM family.



### **1997**

The LSM 510 – the first system of the LSM 5 family and a major breakthrough in confocal imaging and analysis.

### **1998**

The LSM 510 NLO is ready for multiphoton microscopy.



### **1999**

The LSM 5 PASCAL – the personal confocal microscope.

### **2000**

The LSM is combined with the ConfoCor 2 Fluorescence Correlation Spectroscopy.

### **2001**

The LSM 510 META – featuring multispectral analysis.

### **2004**

The LSM 5 LIVE for ultrafast acquisition.

### **2008**

The LSM 710 and LSM 700 – the new generation of sensitivity and flexibility.

This monograph comprehensively deals with the quality parameters of resolution, depth discrimination, noise and digitization, as well as their mutual interaction.

The set of equations presented allows in-depth theoretical investigations into the feasibility of carrying out intended experiments with a confocal LSM.



We make it visible.

FWTHMa