

All optical wavelength converter based on fiber cross-phase modulation and fiber Bragg grating

Pavel Honzatko^{a,*}

^a*Institute of Photonics and Electronics, Academy of Sciences of the Czech Republic, v.v.i.,
Chaberska 57, 182 51 Prague 8*

Abstract

I present new method of phase modulation to amplitude modulation conversion (PM/AM conversion) that utilizes integrating capabilities of fiber Bragg grating (FBG). I found that the wavelength converter based on fiber cross-phase modulation (XPM) and new method of PM/AM conversion have an order of magnitude higher conversion efficiency than the wavelength converter based on sideband filtration method and up to 6 dB higher conversion efficiency than the converter based on the nonlinear optical loop mirror. Numerical analysis and experimental results are provided for bit rates up to 40 Gb/s.

Keywords: Wavelength conversion, fiber cross phase modulation, fiber Bragg grating.

PACS: 42.79Nv, 42.65.Pc

1. Introduction

All-optical wavelength converter is one of principal building blocks in high-capacity wavelength division multiplexed networks allowing processing in optical layer. Long-haul transmission at high bit rates above 40 Gb/s requires utilization of return-to-zero (RZ) or differential phase-shift-keying (DPSK) modulation format. Wavelength conversion of RZ signal based on cross-phase modulation (XPM) in an optical fiber followed by an optical filter has been reported at 40 Gb/s [?] and later at 160 Gb/s [?]. XPM modulation acquired in Raman amplifier allows to achieve a higher modulation index while distortions due to self-phase modulation (SPM) are kept low [? ?]. Other wavelength converters based on Kerr nonlinearity of optical fiber include nonlinear optical loop mirror [? ?], nonlinear polarization rotation [?], and four wave mixing (FWM) [?].

Stability and compactness issues imposed by using long nonlinear fibers were relieved by using short lengths of special Bismuth-based highly nonlinear fibers. Wavelength conversion of RZ pulses was demonstrated with these fibers in a

*Corresponding author

Email address: honzatko@ufe.cz (Pavel Honzatko)

converter based on nonlinear polarization rotation [?], and FWM [?]. Record nonlinearity tapered chalcogenide glass fiber was used to further reduce the fiber length in wavelength converter based on XPM [?].

Wavelength converter based on mixed cross-gain (XGM) and cross-phase modulation in a semiconductor optical amplifier (SOA) with subsequent filtering and inversion in a differential interferometer was demonstrated up to 320 GHz [?]. Other schemes based on nonlinearities of SOA exploit nonlinear polarization rotation [?], FWM [?], or mixed cross-phase/polarization/gain-modulation in a differential scheme of Sagnac interferometer [?], Mach-Zehnder interferometer [? ?], and differential interferometer [?].

Recently I proposed a new scheme of PM/AM conversion suitable for use in wavelength converters based on fiber XPM for RZ modulation format [?]. The scheme have an order of magnitude higher conversion efficiency then the sideband filtration method and up to 6 dB higher conversion efficiency then the nonlinear optical loop mirror. Here I present numerical analysis of the performance together with the experimental results of conversion at repetition rates up to 40 Gb/s obtained in the wavelength converter with short highly nonlinear fiber. The principle of PM/AM conversion in FBG and numerical analysis are presented in section 2. Experimental results are presented in section 3.

2. Theory

The scheme of the wavelength converter is shown in Fig. 1. The data pulses

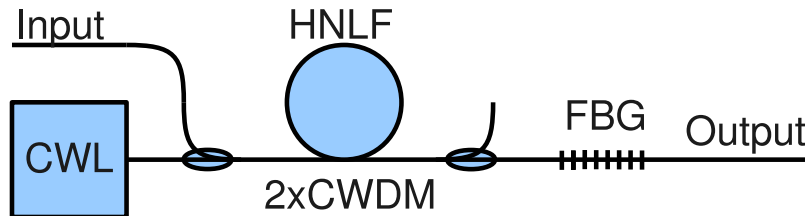

Figure 1: A wavelength converter based on fiber Bragg grating. CWL - CW laser, HNLF - highly nonlinear fiber, FBG - Fiber Bragg grating.

and CW are coupled into the highly nonlinear fiber (HNLF) using the wavelength selective directional coupler (CWDM). The CW is phase modulated through the cross phase modulation (XPM) in the HNLF. The data pulses are blocked by another wavelength selective coupler and the phase modulation acquired by the CW is converted into the amplitude modulation in the fiber Bragg grating (FBG).

When the monochromatic signal is tuned to the vicinity of the Bragg resonance and propagates along the FBG, the backward wave builds up at the

expense of the forward wave. The backward wave effectively averages perturbations of the field because it is formed by coherent superposition of many small reflections at different points along the grating. When the input wave is phase modulated and its phase deviates by π , instead of being depleted during the propagation along the grating it is amplified at the expense of the energy stored in the backward wave. In this way PM is converted to AM. Utilising the coupled mode equations, it can be shown that for sufficiently strong grating the amplitude of converted pulse approaches twice the value of the input CW asymptotically. In this way, the converted pulse can have almost four times higher peak power than the power of CW. The perturbation of the backward wave leads to appearance of small and wide trailing pulse.

Let the input data pulses have a Gaussian shape

$$E_D(t) = E_{D0} \exp[-2 \ln(2)t^2/T_D^2] \exp(-i\omega_D t), \quad (1)$$

where E_{D0} is the data pulse amplitude, T_D is the pulse full width at half maximum, and ω_D is the angular frequency of data pulses. This pulse is sent into a HNLF together with a continuous wave at different frequency. Due to the cross phase modulation, the data pulse shape will be imprinted in the phase of CW field at the output of HNLF,

$$E_X(t) = \exp\{-im \exp[-4 \ln(2)t^2/T_D^2] - i\omega_X t\}, \quad (2)$$

where ω_X is the angular frequency of CW, $m = 2\gamma_2 L_{\text{eff}} P_D$ is the modulation index, γ_2 is the nonlinear coefficient of the fiber, $P_D = |E_{D0}|^2$ is the data pulse peak power,

$$L_{\text{eff}} = \frac{1 - \exp(-\alpha L)}{\alpha}, \quad (3)$$

is the effective length of the fiber, and α is the fiber loss coefficient. Here we omitted plethora of effects that occur in nonlinear dispersive fibers like dispersion and self-phase modulation (SPM) of data pulses, walk-off, parametric processes, PM/AM conversion as a result of XPM and dispersion, modulation instability (MI), and Stimulated Brillouin scattering (SBS). This is justified as long as we work in the regime where the dispersive length of pulses is long compared to the length of the fiber, their peak power is not excessively high, the CW power is sufficiently low so that parametric processes, MI and SBS are unimportant and CW is sufficiently detuned from the input pulses. These conditions are met in our experiment.

To facilitate comparison with the experiment we will keep the data pulse width $T_D = 2.5$ ps and XPM modulation index $m = \pi$ throughout the simulations.

The converted signal is found from the spectrum of the XPM signal and the complex transmission function $\mathcal{H}(\omega)$ of the FBG as

$$E_C(t) = \mathcal{F}^{-1}\{\mathcal{H}(\omega)\mathcal{F}[E_X(t)]\} \quad (4)$$

where $\mathcal{F}[\bullet]$ and $\mathcal{F}^{-1}[\bullet]$ denotes Fourier transform and its inverse.

The complex transmission function of the uniform FBG can be written as [?]]

$$\mathcal{H}(\omega) = \frac{\gamma(\omega) \exp(-i\pi L/\Lambda)}{\gamma(\omega) \cosh(\gamma(\omega)L) - i\sigma(\omega) \sinh(\gamma(\omega)L)}, \quad (5)$$

where L is the FBG length,

$$\gamma(\omega) = \sqrt{|\kappa|^2 - \sigma(\omega)^2},$$

κ is the coupling coefficient, $\sigma(\omega) = n_{01}(\omega)\omega/c - \pi/\Lambda$ is the local detuning, Λ is the FBG period and $n_{01}(\omega)$ is the effective refractive index of the fundamental mode.

The FBG is supposed to be written in conventional SMF28 fiber and the effective refractive index of the fundamental mode used in the numerical simulations is taken from [?]]

$$n_{01} = 1.46409528 - 0.00829634\lambda - 0.00184767\lambda^2, \quad (6)$$

where the wavelength λ should be substituted in μm . The grating period $\Lambda = 534.6$ nm provides Bragg resonance at 1547 nm. The coupling strength is related to the resonance transmission T_0 expressed in dB as

$$\kappa L = \text{arccosh}(10^{-T_0/20}). \quad (7)$$

The uniform grating used in the experiment had a transmission dip depth of 24.5 dBm and bandwidth of 0.13 nm that correspond to the coupling strength of $\kappa L = 3.5$, and number of grating periods 30800, respectively.

First we study the wavelength conversion of a solitary Gaussian pulse. Using the presented model we obtain the converted pulse that is presented in Fig. 2. The pulse has a peak power $P_{\text{pk}} = 3.2P_X$, where P_X is the power of continuous wave. The pulse propagation time through the FBG is 80.4 ps. A small magnitude trailing pulse appears as a result of perturbation of the backward wave in the grating. As can be seen in Fig. 2, the conversion efficiency can be further improved and the trailing peak suppressed when the CW laser has a negative frequency offset with respect to the Bragg resonance. This offset leads to lower background suppression, however. There is a trade-off between the trailing pulse magnitude and the background suppression.

The resonant mode perturbation have to decay before the arrival of the next pulse. In opposite case, the perturbation would accumulate in the grating preventing proper function of the converter. I therefore investigated the response of the converter to the long sequence of consecutive pulses. I found that our grating should work almost perfectly for repetition rates up to 40 Gb/s. The result of conversion of 16 consecutive “ones” is shown in Fig. 3. For this repetition rate the field of the resonant mode almost relaxes to its steady state before the arrival of the next pulse and only a small transient effect at the beginning of the long sequence can be observed.

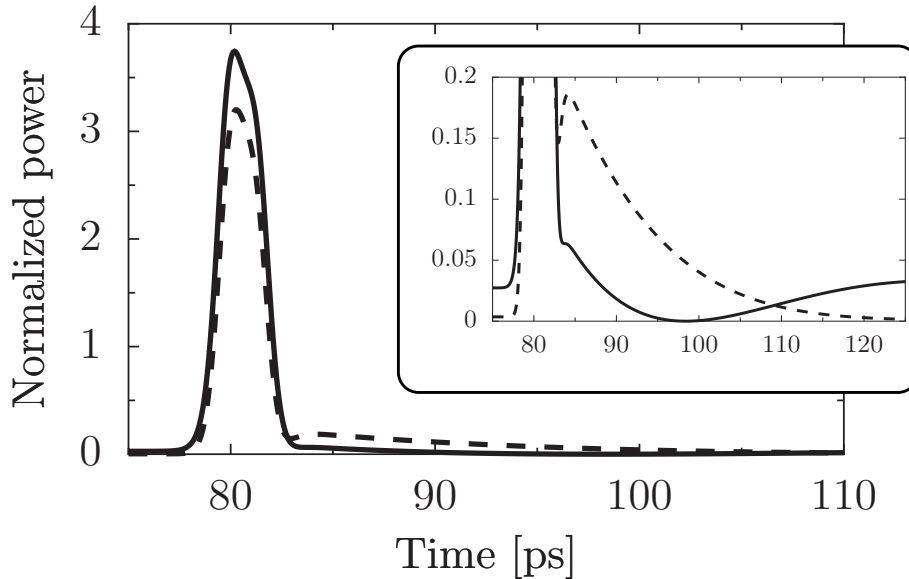

Figure 2: Pulse converted by the FBG when the CW is tuned to the resonance (dash) and when it has an offset of -6 GHz (solid). An inset shows detail for small power levels.

3. Experiment

The experimental setup is shown in Fig. 4. As a source of RZ pulses I used the mode-locked laser (*u2t*) generating a periodic train of pulses with a repetition rate of 10 GHz, a wavelength of 1563 nm, and a pulse-width of 1.5 ps. These pulses were preamplified, filtered, and modulated with Mach-Zehnder intensity modulator MOD driven from the pseudorandom bit sequence generator PRBS (up to $2^{31} - 1$, Centellax), that was synchronized to the mode-locked laser signal via receiver RX (Bookham) and clock recovery unit CRU (Centellax). Pulses from the data source were eventually multiplexed to 20 Gb/s or 40 Gb/s in optical multiplexer (OMUX, *u2t*), and then amplified by booster amplifier BA and coupled into the highly nonlinear fiber HNLF (OFS) using the reflecting port of a coarse wavelength division multiplexer (CWDM) centered at 1551 nm (Opneti). The HNLF with a length $L = 50$ m, a zero dispersion wavelength of 1506nm and a nonlinear coefficient $\gamma = 11 \text{ W}^{-1}\text{km}^{-1}$ was used in the experiment. At the output of the NZ-DSF, the RZ pulses and CW were separated by another CWDM. The average power of amplified and filtered pulses was 19.1 dBm and their duration at the input of the HNLF was 2.5 ps FWHM. The energy of pulses was estimated to be 8.1 pJ at 10 Gb/s and their peak power to be 2.9 W that corresponds approximately to a nonlinear phase shift of π . Light of a CW laser was amplified to 12 dBm and coupled into the HNLF using the pass port of the CWDM. Polarization controllers (PC3-PC4) were used to obtain the best magnitude of converted pulses. The converted RZ pulses were detected by fast receiver for 40 Gb/s (*u2t*) and analyzed by the data commu-

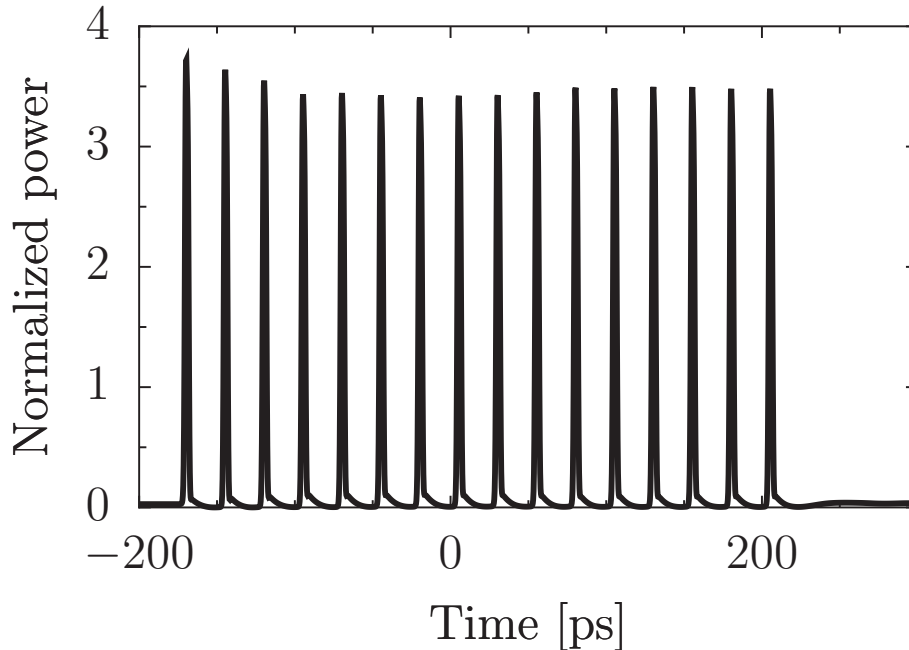

Figure 3: Conversion of a long sequence of consecutive pulses. A frequency offset of -6 GHz was used.

nication analyzer (DCA8100, Agilent). The eye diagram of input pulses and of converted pulses for 10 Gb/s data stream can be seen in Fig. 5. It can be seen that an excellent quality of converted signal can be attained. Some jitter that can be observed on the detected pulses is caused by group delay variations and probably would be removed if the synchronization signal for DCA was derived from the output signal. The pulse duration of the converted pulses was estimated to be 4 ps based on the autocorrelation measurement and the data from home-made optical sampling oscilloscope

I also performed an experiment with format conversion at 20 Gb/s. The signal from our RZ-pulses source was multiplexed to 20 Gb/s in an optical time domain multiplexer (OMUX) preserving the PRBS 2^7-1 . The average power of RZ pulses was kept at 19.1 dBm, so the pulse energy was reduced to 4.1 pJ and the peak nonlinear phase shift reduced to $\pi/2$. Nevertheless, clear eye diagram was obtained at this repetition rate demonstrating scalability of the device toward the higher bit-rates (Fig. 6). When the input RZ pulses were further multiplexed to 40 Gb/s, the eye diagram of converted pulses was almost closed (Fig. 7). It was a combined result of the jitter imposed by the synchronization scheme used in the experiment, insufficient peak power of input RZ pulses, that was further reduced by a factor of two, and possibly by the transient effects in the FBG itself.

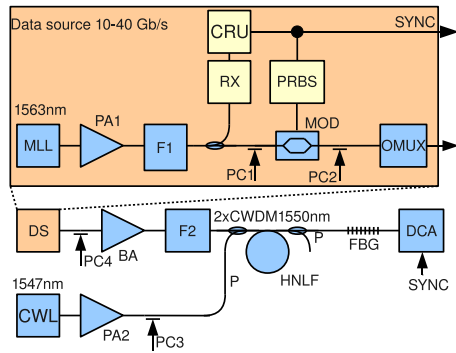

Figure 4: An experimental setup. DS-data source, MLL-modelocked laser, PA-preamplifiers, BA-booster amplifier, MOD-modulator, OMUX-optical time domain multiplexer, F-filters, PC-polarization controllers, CWL-CW laser, DCA-data communication analyzer, RX-receiver, CRU-clock recovery unit.

4. Conclusion

I presented new method of wavelength conversion. The converter is based on fiber XPM with subsequent conversion of PM into AM in the fiber Bragg

grating. The interference between the Bragg grating resonant mode and forward wave is exploited for conversion of PM into AM. Because an energy accumulated in the resonant mode is utilized, the converter has up to 6 dB better conversion efficiency than a converter based on nonlinear optical loop mirror and an order of magnitude better conversion efficiency than the wavelength converter based on sideband filtration. Numerical analysis and experimental results are provided for bit rates up to 40 Gb/s.

Acknowledgments

This project was supported by the program “Information society” of the Czech Academy of Sciences (1ET300670502).

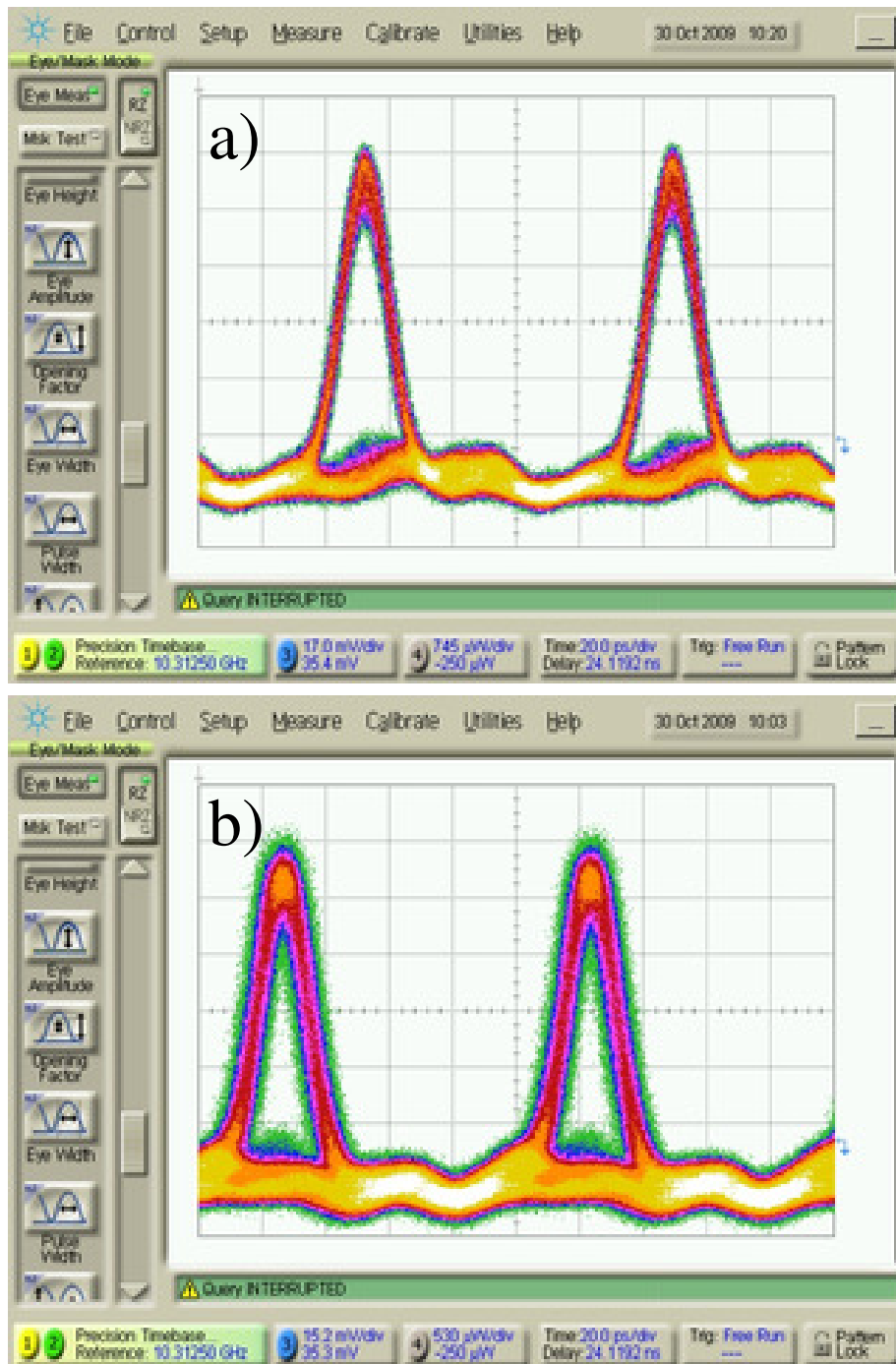

Figure 5: Eye diagrams of (a) input and (b) converted pulses at 10 Gb/s.

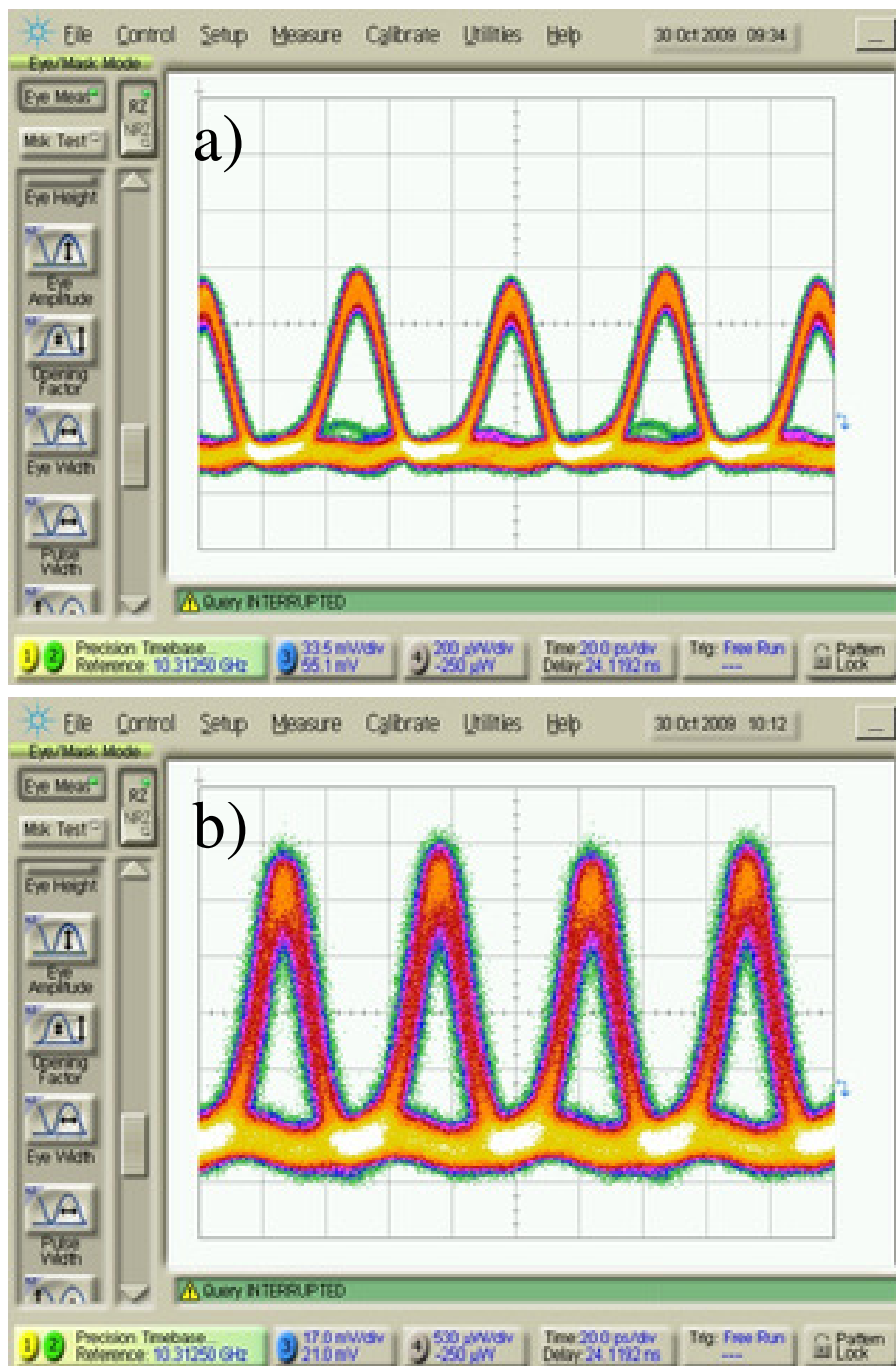

Figure 6: Eye diagrams of (a) input and (b) converted pulses at 20 Gb/s.

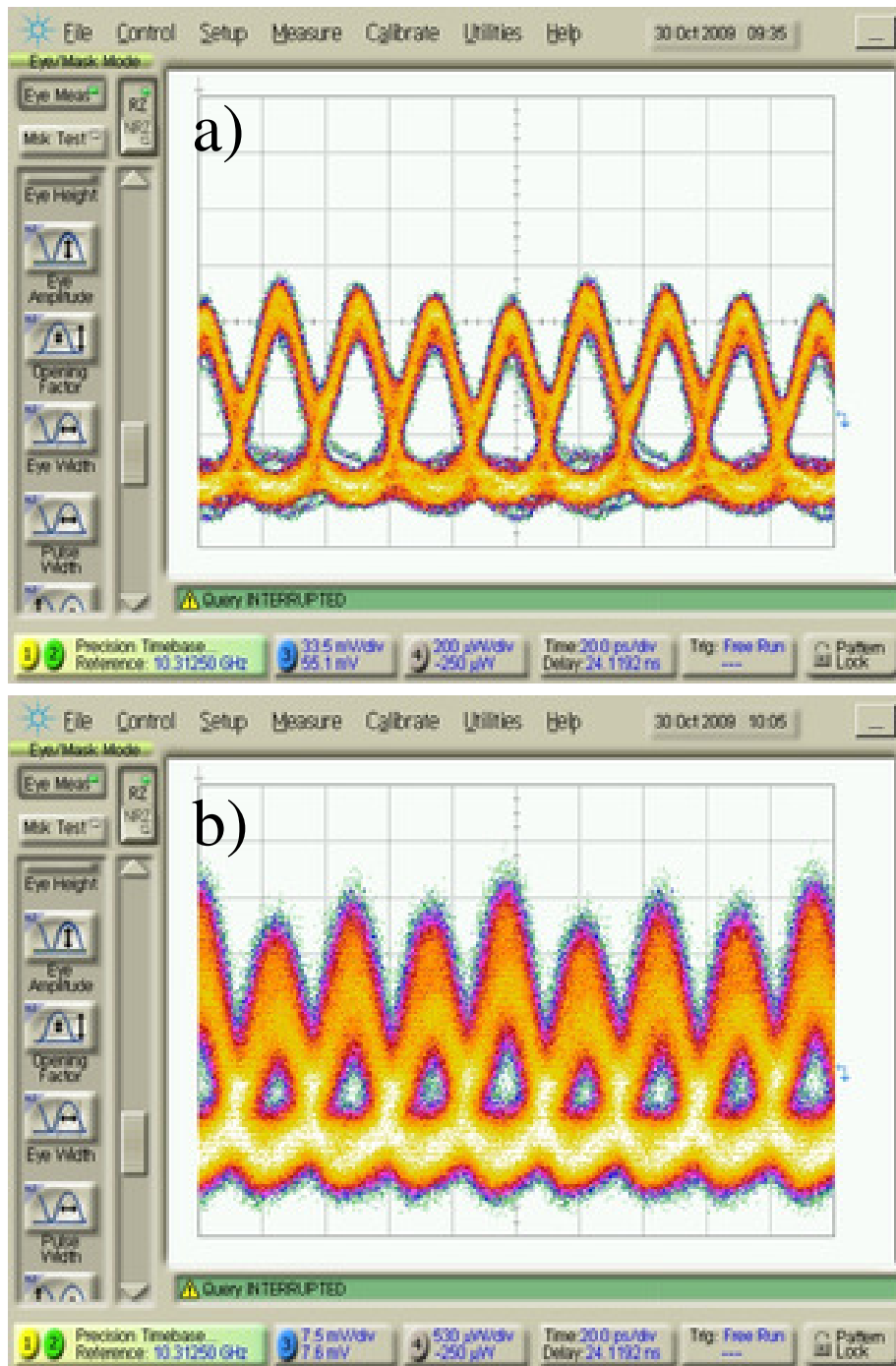

Figure 7: Eye diagrams of (a) input and (b) converted pulses at 40 Gb/s.