

# ANNUAL REPORT

ON ACTIVITY AND ECONOMIC MANAGEMENT 2020

**J. Heyrovský Institute of Physical Chemistry**

J. Heyrovský Institute of Physical Chemistry (JHIPC)  
of the Czech Academy of Sciences (CAS), public research institution (p.r.i.)

Identification Number: 61388955

Address: Dolejškova 2155/3, 182 23 Praha 8

Discussed by the Supervisory Board on 14 June 2021

Approved by the Institute Board on 24 June 2021

In Prague on 28 June 2021



## Index

I. Information on bodies of the public research institution and on their activity .....	4
A) Initial members of the bodies of the institute .....	4
The director of the institution .....	4
The Institute Board .....	4
Supervisory Board.....	5
B) Changes in the bodies of the institute.....	5
C) Information on activity of the bodies:.....	5
The director of the institute.....	5
The institute board.....	6
Supervisory Board.....	8
II. Information on changes in the founding deed .....	10
III. Assessment of the main activity.....	10
III. 1. The most important results.....	11
Department of Theoretical Chemistry (1).....	11
Department of Spectroscopy (2).....	12
Department of Biophysical Chemistry (3) .....	13
Department of Structure and Dynamics in Catalysis (4).....	14
Department of Molecular Electrochemistry and Catalysis (5).....	15
Department of Computational Chemistry (6).....	16
Department of Electrochemical materials (7).....	17
Department of Electrochemistry in Nanoscale (8) .....	18
Department of Chemistry of Ions in Gaseous Phase (9).....	19
Department of Low-dimensional Systems (10) .....	20
Department of Dynamics of Molecules and Clusters (11) .....	21
Department of Nanocatalysis (12).....	22
Scientometric achievements: .....	23
III. 2 Important projects.....	27
Selected research projects.....	27
Selected strategic projects.....	28
III. 3. Significant awards .....	31
III. 4. Promotion and popularization.....	32
III. 5. Scientific and pedagogical collaboration of JHIPC with universities .....	35
III. 6. Collaboration of the JHIPC with other institutions and with the business sector ...	37
The results of cooperation with the business and other organisations obtained in a project .....	37

Results of collaboration with other organisations and businesses obtained based on contracts.....	39
Patents and utility models.....	40
Information on the employees of the JHIPC who held positions in the governing bodies of major international scientific organisations .....	41
III. 7. International scientific collaboration.....	41
Projects funded by the European Commission under the HORIZON 2020 program .....	42
International projects that were carried out in the framework of international scientific cooperation outside the EU framework programs.....	43
III. 8. Conferences and foreign guests.....	43
Significant national scientific events organised or co-organised by JHIPC.....	43
IV. Assessment of additional and other activity: economics department .....	44
V. Information on the inspection performed by the Ministry of Finance, identified deficiencies and measures to eliminate them .....	44
VI. Financial information about facts that are relevant to the assessment of the economic position of the institution and may affect its development.....	44
VII. Expected development of JHIPC activities.....	44
VIII. Activities in the field of environmental protection.....	45
IX. Activities in the field of labour relations.....	45
X. Provision of information under Act No. 106/1999 Coll., On Free Access to information .....	47

## I. Information on bodies of the public research institution and on their activity

### A) Initial members of the bodies of the institute

#### The director of the institution

Prof. Martin Hof, Dr. rer. nat. DSc.  
appointed effective from 1 May 2017

#### The Institute Board

Elected on: 23 January 2017; members:  
**Chairman:** prof. RNDr. Patrik Španěl, Dr. rer. nat.  
**Vice-chairman:** prof. RNDr. Ladislav Kavan, CSc., DSc.

**Internal members (JHIPC)** prof. Martin Hof, Dr. rer. nat. DSc.  
Mgr. Michal Horáček, Ph. D.  
doc. Mgr. Jiří Pittner, Dr. rer. nat., DSc.  
prof. RNDr. Zdeněk Samec, DrSc.  
Mgr. Jiří Dědeček, CSc., DSc.  
RNDr. Martin Ferus, Ph.D.  
Mgr. Magdaléna Hromadová, Ph. D.  
doc. RNDr. Ing. Martin Kalbáč, Ph. D.

**External members:** prof. RNDr. Jiří Barek, CSc.  
Faculty of Science, Charles University in Prague

prof. Dr. Ing. Karel Bouzek  
Faculty of Chemical Technology,  
University of Chemistry and Technology, Prague

prof. Mgr. Pavel Jungwirth, CSc., DSc.  
Institute of Organic Chemistry and Biochemistry  
of the CAS

prof. Dr. RNDr. Pavel Matějka  
Faculty of Chemical Technology,  
University of Chemistry and Technology, Prague

prof. RNDr. Eva Tesařová, CSc.  
Faculty of Science, Charles University in Prague

### Supervisory Board

<b>Chairman:</b>	Ing. Petr Bobák, CSc., Institute of Animal Physiology and Genetics of the CAS
<b>Vice-chairman:</b>	Mgr. Otakar Frank, Ph.D. J. Heyrovský Institute of Physical Chemistry of the CAS
<b>Members:</b>	Ing. Jana Bludská, CSc., Institute of Inorganic Chemistry of the CAS  prof. Ing. Jiří Homola, CSc., DSc. Institute of Photonics and Electronics of the CAS  prof. Mgr. Iva Matolínová, Dr. Faculty of Mathematics and Physics, Charles University in Prague

### B) Changes in the bodies of the institute

In 2020, Mgr. Otakar Frank, Ph.D. replaced RNDr. Jan Hrušák, CSc. in his position of vice-chairman and board member Ing. Zbyněk Černý, CSc. was replaced by Ing. Jana Bludská, CSc. effective from 20 January 2021.

### C) Information on activity of the bodies:

#### The director of the institute

Main management activities of the director:

- a) Organization of meetings of the director's board, which took place a total of 15 times in 2020. The conclusions of the meetings are published on the internal website of JHIPC.
- b) Submission of the draft budget for 2020 to the supervisory board for comments and the institute board for approval.
- c) Submission of the Annual Report on Activities and Economic Management for 2019 to the supervisory board for an opinion and to the institute board for approval after the auditor's verification of the closing financial statement.
- d) Submission of proposals for the Otto Wichterle Award, the Josef Hlavka Award and the Česká Hlava Award,
- e) Submission of proposals for actions requiring the prior consent of the Supervisory Board to this board for approval.

- f) Preparation and conclusion of an amendment to the Collective Agreement with the Trade Union Organization concerning the principles and budget for drawing from the social fund in 2020.
- g) Recruitment of new staff on the basis of open competition and decision on extension or reassignment of staff of the JHIPC on the basis of performance evaluation.
- h) Appointment of members of commissions, including the Commission for Heyrovský Open Access Funding.
- i) Setting up new processes to increase the effectiveness of the JHIPC management.
- j) Facilitating operational measures in connection with the COVID-19 pandemic, when, despite epidemiological measures, the operation of the JHIPC was maintained, including laboratory research, and the risk of infection was reduced by working from home in cases that made it possible.

### **International Advisory Board acts as an advisory body to the director; its members are:**

- prof. Dr. Ulrike Diebold, Vienna University of Technology, Austria
- prof. Timo Jacob, Ulm University, Germany
- prof. Philipp Kukura, University of Oxford, United Kingdom
- prof. Peter Rapta, Slovak University of Technology in Bratislava, Slovakia
- prof. Dr. Joachim Heberle, Free University of Berlin, Germany
- prof. Dr. Jeroen Anton van Bokhoven, ETH Zürich, Switzerland
- prof. Dr. Leticia Gonzales, Universitat Wien, Austria

### **The institute board**

In 2020, meetings of the institute board took place a total of 19 times, of which 17 meetings took place in the form of voting by mail (per rollam).

#### **11<sup>th</sup> meeting of the institute board (23 March 2020)**

- The institute board approved the minutes and resolutions of the 10<sup>th</sup> meeting of the institute board (of 25 November 2019).
- The institute board approved the minutes and resolutions of the voting by mail of 11 December 2019, 20 December 2019, 9 January 2020, 24 February 2020, 2 March 2020.
- The institute board agrees with the budget of JHIPC for the year 2020 in the presented wording.
- The institute board supported the submission of a total of 57 projects to The Czech Science Foundation (GACR).
- The institute board agrees with the Budget for Drawing on the Social Fund for 2020 and the Amendment to the Collective Agreement concluded on 28 February 2018 "Rules for

Drawing on the Social Fund of the J. Heyrovsky Institute of Physical Chemistry of the Czech Academy of Sciences, p.r.i. for 2020 as submitted.

### **12<sup>th</sup> meeting of the institute board (7 September 2020)**

- The institute board approved the minutes and resolutions of the 11<sup>th</sup> meeting of the institute board (of 23 March 2020). The meeting was held as a videoconference.
- The institute board approved the minutes and resolutions of the voting by mail of 27 March 2020, 24 April 2020, 29 May 2020, 24 June 2020, 30 June 2020, 9 July 2020, 15 July 2020, 27 August 2020 and 2 September 2020.
- The institute board asked Chairman P. Španěl to prepare a detailed draft of the Election Rules of the JHIPC, including potential variants for discussion and approval at the next meeting in collaboration with other board members via email.
- The institute board discussed the document HR Award Interim Assessment prepared by the steering committee before being sent to the European Commission.
- The institute board recommended the application for membership of JHIPC in the Association of Research Organizations (AVO) after consultation with prof. Lazar of the CAS.
- The institute board requests the director to submit a draft amendment to the Organisational Rules for discussion by mail and subsequent approval as soon as possible.

### **The institute board approved the following resolutions by mail:**

- The institute board supported the submission of a total of 18 grant project proposals.
- The institute board agrees with the conclusion of the submitted Cooperation Agreement between JHIPC and Leibniz Institute of Surface Engineering (IOM).
- The institute board agrees with the nomination of RNDr. Alan Liška, Ph.D., Ing. Kinga Mlekodaj, Ph.D. and Mgr. Štěpánka Nováková Lachmanová, Ph.D. for the Otto Wichterle Award.
- The institute board recommends nominating prof. David Smith Ph.D., DSc., DSc.hc, FInstP, FRS. for the award of the Jaroslav Heyrovsky Honorary Medal for Merit in Chemical Sciences.
- The institute board Rada recommends submitting an application for support from the Programme to support prospective human resources – Wage support of postdocs in the institutes of the CAS for the following candidates: Ing. Jana Pastvová, Ph.D., Dr. Homa Saeidfirouzeh, Ph.D., Mgr. Vojtěch Hrdlička, Ph.D.
- The institute board recommends associate membership of the J. Heyrovsky Institute of Physical Chemistry of the CAS in the TRANSFERA.CZ association.
- The institute board notes the submitted Annual Report on Activities and Management for 2019, including the attached report of the independent auditor, and agrees with its wording.
- The institute board agrees to the conclusion of a Joint Declaration on Cooperation between the Research Infrastructure Nanomaterials and Nanotechnologies for Environmental Protection and a Sustainable Future (NanoEnviCz) and the Materials Growth and Measurement Laboratory (MGML).



## INFORMATION ON BODIES OF THE PUBLIC RESEARCH INSTITUTION AND ON THEIR ACTIVITY

- The institute board approves the presented medium-term outlook of the JHIPC budget for the years 2020-2023.
- The institute board recommends submitting an application for support from the Program to Support the International Cooperation of Early Stage Researchers for the candidate Mgr. Radek Žouželka, Ph.D.
- The institute board approves the submitted updated Organisational Rules.
- The institute board approves the submitted Electoral Rules of JHIPC, the document Interim Assessment in the submitted wording and agrees with the conclusion of the "Memorandum of Understanding" between JHIPC and TESLA BLATNÁ in the submitted wording.
- The institute board supported the submission of a total of 13 grant project proposals.
- The institute board Rada approves "Annex No. 1 - Tariff Margins and Bonuses for Management" of the Internal Wage Regulation of the JHIPC in the submitted wording.
- The institute board agrees with the wording of the document Status of the Rudolf Brdička Medal.

### Supervisory Board

In 2020, a meeting of the Supervisory Board of the J. Heyrovský Institute of Physical Chemistry of the CAS, p.r.i. took place on 9 June 2020. Eight meetings by mail took place due to 16 March 2020, 12 April 2020, 15 May 2020, 9 October 2020, 27 October 2020, 13 November 2020, 10 December 2020 (two meetings).

All members of the supervisory board and the institute board signed an affidavit stating that they were not aware that they or their family members were involved in juridical persons with whom the accounting unit, the J. Heyrovský Institute of Physical Chemistry of the CAS, p.r.i., concluded business contracts or other contractual relationships in 2020.

### Meeting of the supervisory board on 9 June 2020

- The supervisory board approved the Report on the Activities of the Supervisory Board for 2019 and confirmed the vote, which took place in 2019 by mail (No 45-50).
- The supervisory board discussed and took note of the Annual Report of JHIPC for the year 2019.
- The supervisory board took note of the information provided by M. Kalbáč and I. Friedjung on the preparation of the Auditor's Report by 18 June 2020.
- The supervisory board recommended, based on the comments of Mr. J. Homola, the distribution of the economic result into funds.
- The supervisory board discussed and took note of the Appendix to the Financial Statements, the Balance Sheet and the Profit and Loss Statement.
- The supervisory board proposes to draw up a medium-term outlook for the JHIPC budget for 2021/2022.
- The supervisory board noted the information presented on the JHIPC management and investments and discussed the JHIPC's Draft Budget for 2020.

## INFORMATION ON BODIES OF THE PUBLIC RESEARCH INSTITUTION AND ON THEIR ACTIVITY

- The supervisory board appoints Ing. L. Ježek as the auditor for the financial statements for the year 2020 according to the Audit Agreement.
- The supervisory board approved the extension of the building on the premises of the JHIPC.
- The supervisory board approved the extension of the building on the premises of the JHIPC.
- The supervisory board approves the Evaluation of the Managerial Abilities of the Director of the JHIPC according to the submitted proposal.

### **The supervisory board approved the following resolution by mail:**

1) The supervisory board agrees with the Agreement on the Lease of Non-residential Premises with the Institute of Physics of the CAS, p.r.i.

The approval took place by mail No. 51 on 16 March 2020.

2) The supervisory board agrees with Appendix No. 1 pursuant to Article XIII. article 2 to the contract of 1 March 2018 registration no. 2018/003 On the Lease of Non-residential Premises (Catering) between the JHIPC, p.r.i. and M Catering, s.r.o. (with comments by Prof. J. Homola).

The approval took place by mail No. 52 on 12 April 2020.

3) The supervisory board agrees with the Request for Prior Written Consent to the Acquisition of the Expensive Device Nanoindentor Hysitron TI 980.

The approval took place by mail No. 53 on 15 May 2020.

4) The supervisory board agrees with the Addendum to the Agreement on the Lease of Space for business with the company IVR FS s.r.o. (ID 242 77 169), main office: U Slovanky 1388/5, Libeň, 182 00 Prague 8, represented by: Mgr. Ondřej Vojtěch, MBA company executive and Ing. Pavel Fohler

The approval took place by mail No. 54 on 9 October 2020.

5) The supervisory board agrees with the new Rules of Procedure of the JHIPC of the CAS.

The approval took place by mail No. 55 on 27 October 2020.

6) The supervisory board agrees with Appendix No. 2 pursuant to Article XIII. article 2 to the contract of 1 March 2018 registration no. 2018/003 On the Lease of Non-residential Premises (Catering) between the JHIPC, p.r.i. and M Catering, s.r.o. (with comments by Prof. J. Homola).

The approval took place by mail No. 56 on 13 November 2020.

7) The supervisory board agrees with the Proposal of the Preliminary Intention to establish a spin-off of JHIPC.

The approval took place by mail No. 57 on 10 December 2020.

8) The supervisory agrees with the Agreement on the Lease of Space used for business with the company Advanced Materials – JTJ s. r. o.

The approval took place by mail No. 58 on 10 December 2020.

## II. Information on changes in the founding deed

No changes were made to the founding deed in 2020.

## III. Assessment of the main activity

In accordance with the valid founding deed, the JHIPC carries out scientific research in the field of **physical chemistry, electrochemistry, analytical chemistry and chemical physics** and seeks the possibility of using its research results.

According to the valid founding deed, as amended by the amendment of 22 June 2010, the main activity of the JHIPC is scientific research in physical chemistry, electrochemistry, analytical chemistry and chemical physics, especially research on the structure of substances and their properties, research on elementary processes of chemical reactions and processes, research of chemical and physicochemical processes in homogeneous phase and at phase interface, preparation and development of chemical compounds, materials and technologies, development of special physical and physicochemical methods and equipment and development of computer programs for quantum chemical and other theoretical calculations in the fields of the JHIPC activity and for control of experiments and processing of results of the JHIPC. Through its activities, the JHIPC contributes to increasing the level of knowledge and education and to the use of the results of scientific research in practice. JHIPC acquires, processes and disseminates scientific information, publishes scientific publications (monographs, journals, proceedings, etc.), provides scientific opinions, expert opinions and recommendations, and performs consulting and advisory activities. In cooperation with universities, it carries out PhD programs and educates researchers. It organises lectures, seminars and internships for students. Within the scope of its activities, JHIPC develops international cooperation, including the organisation of joint research with foreign partners, the recruitment and posting of interns, the exchange of scientific knowledge and the preparation of joint publications. JHIPC organises domestic and international scientific meetings, conferences, seminars and lectures and provides research infrastructure, including providing accommodation for its employees and guests and providing catering in the cafeteria in the CAS premises "Mazanka" for employees of the Academy of Sciences of the Czech Republic. JHIPC carries out projects independently and in cooperation with universities and other scientific and expert institutions.

In 2020, the JHIPC continued its theoretical and experimental research in selected areas of chemical physics, electrochemistry, catalysis and related fields. Research activities take place in 12 departments and one scientific research centre.

The JHIPC actively supports collaboration at the international level: currently, there are 89 foreign scientists in the JHIPC, and the total number of scientists is 224.

### III. 1. The most important results

The research plan and the grants supported by the GACR achieved important results that are described in this section according to the departments.

#### Department of Theoretical Chemistry (1)

##### Massively parallel implementation of the DMRG method

We have developed the new implementation of the quantum chemical version of the DMRG method with the unique feature of high scalability. The DMRG method is a well-established computational method suitable especially for strongly correlated molecules, such as transition metal complexes or polycyclic aromatic hydrocarbons. Our parallel implementation allows exploiting the newest supercomputers for the electronic structure calculations of these species, thus, to perform them much more efficiently.

Collaborating entity: Pacific Northwest National Laboratory (USA), Wigner Research Centre for Physics (Hungary)

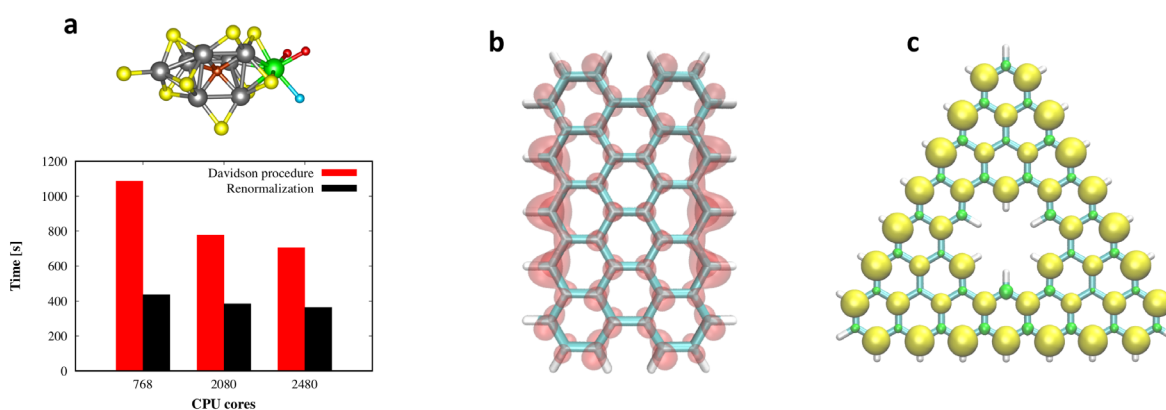

**Scaling of the massively parallel DMRG implementation and its application on polycyclic aromatic hydrocarbons.** (a) Scaling of the most CPU-demanding parts of the DMRG calculation of the FeMoco cluster [CAS(113,76), bond dimension  $M = 6000$ ]. (b)  $N$  Singlet state unpaired electron density of peripentacene calculated by means of our DMRG implementation (published in DOI: 10.1021/acs.jpcllett.0c02518). (c) Ground state ( $S=3$ ) spin density distribution of the [7]Triangulene quantum ring calculated by means of our DMRG implementation (published in DOI: 10.1021/acs.nanolett.0c04627).

Brabec J, Brandejs J, Kowalski K, Xantheas S, Legeza O, Veis L. Massively parallel quantum chemical density matrix renormalisation group method. *J Comput Chem.* 2021;42(8):545-551. <https://doi.org/10.1002/jcc.26476>

### Department of Spectroscopy (2)

#### Elemental composition, mineralogy and orbital parameters of the Porangaba meteorite

We have published a comprehensive analysis of the Porangaba meteorite and calculations of the path and parent body in the Solar System. This meteorite became the 32<sup>nd</sup> meteorite for which the path is known, while a complete analysis of mineralogy and the element composition is carried out. Our complete analysis of the sample was also complemented by a comprehensive comparison of the results of several analytical techniques used to measure the representation of individual elements in the meteorite, as well as the predictive spectrum expected during atmospheric entry.

Collaborating entity: Astronomical Observatory Valašské Meziříčí

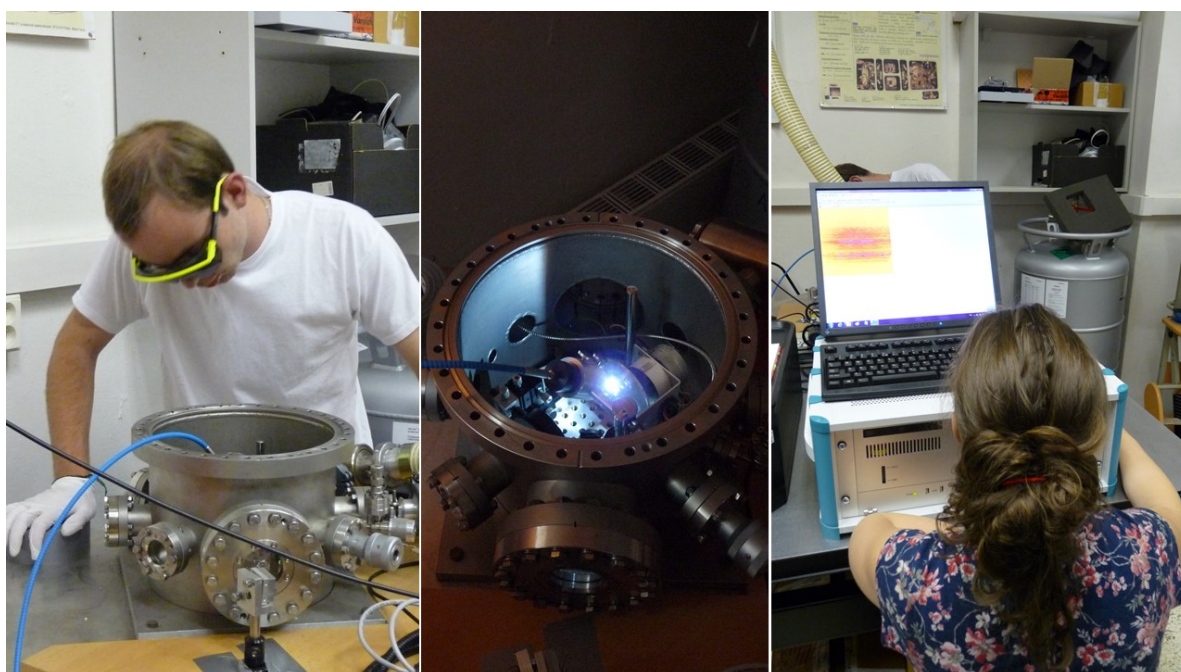

***Elemental analysis of the Porangaba meteorite using laser ablation.***  
*From the left: fixing the sample in the ablation chamber, ablation using UV excimer laser, recording of high-resolution spectra by an eschelle spectrometer.*

Ferus M, Petera L, Koukal J, Lena L, Drtinova B, Haloda J, Matysek D, Pastorek A, Laitl V, Poltronieri RC, Domingues MW, Goncalves G, et al. Elemental composition, mineralogy and orbital parameters of the Porangaba meteorite. *Icarus*. 2020;341. 113670 [doi.org/10.1016/j.icarus.2020.113670](https://doi.org/10.1016/j.icarus.2020.113670)

### Department of Biophysical Chemistry (3)

#### A Functional Assay to Correlate Protein Oligomerization States with Membrane Pore Formation

Self-assembly of molecules into functional protein complexes is essential for proper functioning of many biological processes. The newly developed statistical method makes it possible to detect individual protein complexes, quantify their composition and determine whether they are functional, i.e. biologically active, or non-functional, and therefore biologically irrelevant.

Collaborating entity: Heidelberg University Biochemistry Center, Im Neuenheimer Feld 328, 69 120 Heidelberg, Germany



**Functional assay to correlate protein oligomerisation states with membrane pore formation.** A new fluorescence method developed in our laboratory makes it possible to monitor in-membrane aggregation of proteins in real time and to identify the moment when trans-membrane pores permeabilising the membrane are opened.

Šachl, R.; Čujová, S.; Singh, V.; Riegerová, P.; Kapusta, P.; Müller, H.-M.; Steringer, J. P.; Hof, M.; Nickel, W. Functional Assay to Correlate Protein Oligomerization States with Membrane Pore Formation. *Anal Chem.* 2020;92(22):14861-14866.

[doi.org/10.1021/acs.analchem.0c03276](https://doi.org/10.1021/acs.analchem.0c03276)

**Department of Structure and Dynamics in Catalysis (4)****Beta zeolite catalysts for important environmental and industrial processes**

Significant step ahead in the understanding reactivity of the group of beta zeolite catalysts for alkylation and hydroisomerisation processes (Appl. Catal. A, General 591 (2020) 117379) and for the oxidation of volatile organic compounds (ACS Catal. 10, (2020) 3984) was achieved. The team used the acquired knowledge in applied research to accomplish the development of the industrial production of beta zeolite catalyst for an environmentally friendly hydroisomerisation process for the production of gasoline.

Collaborating entities: Euro Support Manufacturing Czechia, s.r.o. and Chemoprojekt, a.s.

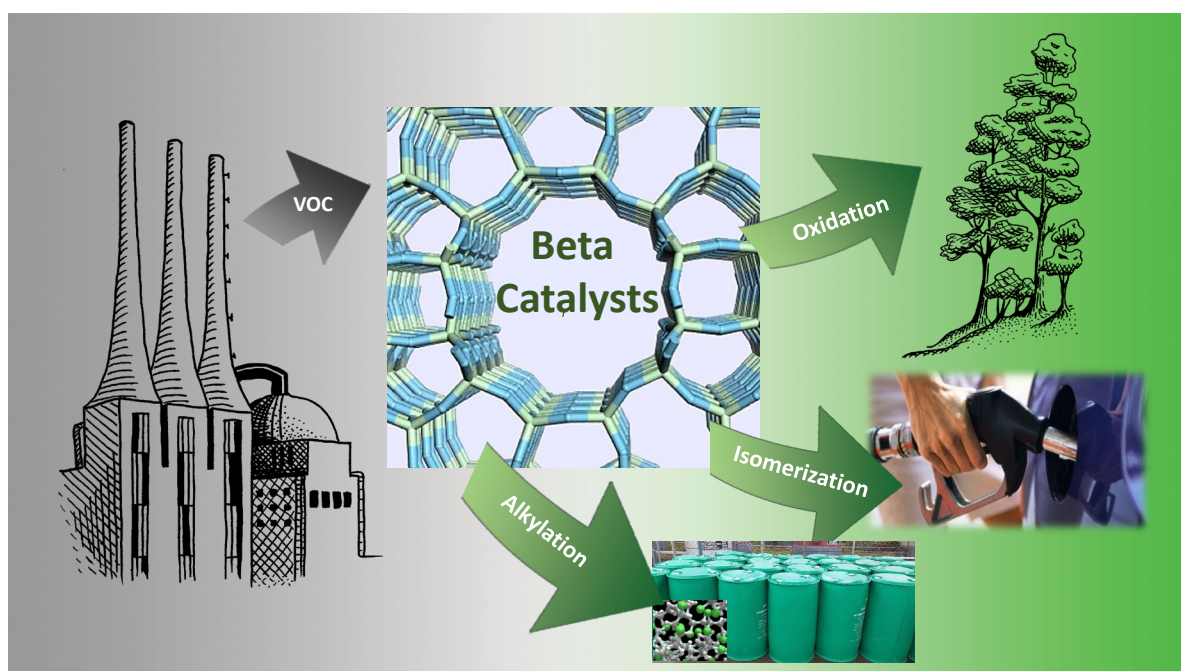

**Illustration of the beta zeolite catalysts.** The developed catalytic systems enable new solutions of the current serious environmental and technological problems for the elimination of emissions of volatile organic compounds and the isomerisation and alkylation reactions of alkanes and aromatics.

Sazama P, Moravkova J, Sklenak S, Vondrov A, Tabor E, Sadovska G, Pilar R. Effect of the Nuclearity and Coordination of Cu and Fe Sites in beta Zeolites on the Oxidation of Hydrocarbons. *Acs Catalysis*. 2020;10(7):3984-4002.

<https://doi.org/10.1021/acscatal.9b05431>

## Department of Molecular Electrochemistry and Catalysis (5)

## New catalytic system for hydrodehalogenation of aliphatic organohalides

The original catalytic system based on transition metal in combination with hydrosilane  $\text{Et}_3\text{SiH}$  and catalytic amount of  $\text{B}(\text{C}_6\text{F}_5)_3$ , discovered and described in our laboratory, has proved suitable for use in hydrodehalogenation of aliphatic organohalides. Compared to the dehalogenation procedures reported in the literature, we were able to perform defluorination of trifluorotoluene (used as a model substrate) with readily available and stable titanocene dichloride and other commercially available titanium complexes under mild conditions. The main advantage of our system is a high degree of selectivity (i.e. suppression of Friedel-Crafts by-products) for aromatic substrates, not yet observed in published catalytic systems.

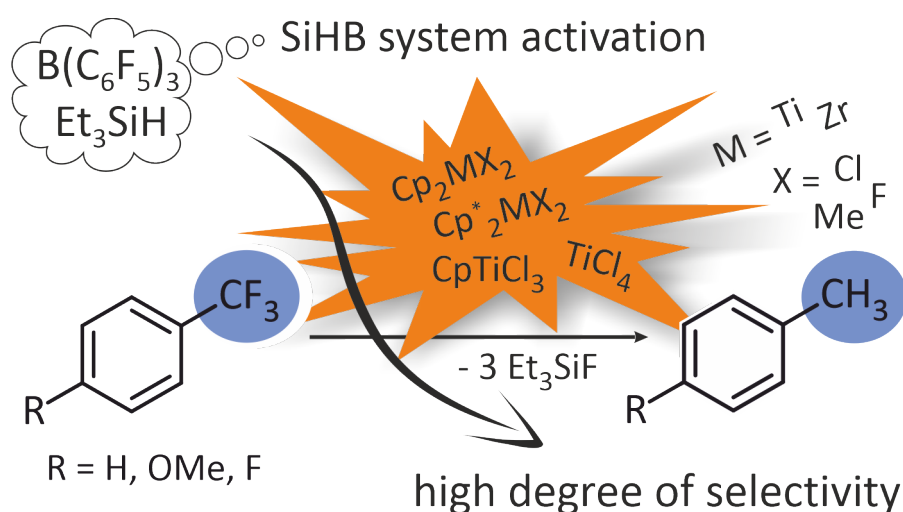

**Catalytic hydrodehalogenation by SiHB-metal system.** Activation of the SiHB-metal-based catalytic system leads to hydrodehalogenation of organohalides with a high degree of selectivity.

Dunlop D, Pinkas J, Horáček M, Žilková N, Lamač M Hydrodehalogenation of organohalides by  $\text{Et}_3\text{SiH}$  catalysed by group 4 metal complexes and  $\text{B}(\text{C}_6\text{F}_5)_3$ . *Dalton Transactions*. 2020;49(9):2771-2775. <https://doi.org/10.1039/d0dt00360c>



## Department of Computational Chemistry (6)

## Understanding and predicting post H-atom abstraction selectivity through reactive mode composition factor analysis

We developed a methodology for analysis of kinetic energy distribution within vibrational and reactive modes and applied to post H-atom abstraction selectivity: hydroxylation of the substrate vs. radical dissociation using a set of biomimetic reactions. We showed that kinetic energy distribution within the reactive mode associated with the substrate C-H bond activation via H-atom abstraction is the key factor governing the post H-atom abstraction selectivity.

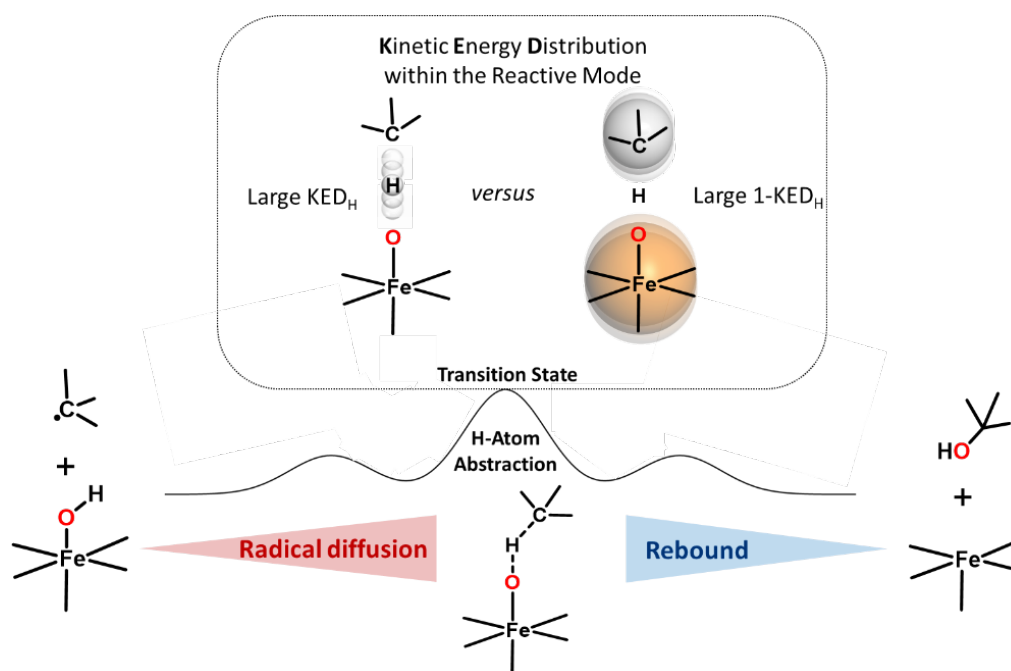

**Reaction selectivity governed by kinetic energy distribution with the reactive mode.** One of strategies to control the post H-atom abstraction selectivity toward OH rebound or dissociation within bimolecular systems in solution is by tuning the character of the H-atom abstraction reactive mode.

Maldonado-Dominguez M, Srnc M. Understanding and Predicting Post H-Atom Abstraction Selectivity through Reactive Mode Composition Factor Analysis. *J Am Chem Soc.* 2020;142(8):3947-3958

<https://doi.org/10.1021/jacs.9b12800>

## Department of Electrochemical materials (7)

### Preparation of defined interfaces of two-dimensional materials

The lack of a defined interface is one of the most important factors limiting the application of two-dimensional materials. We have therefore prepared and studied interfaces of semiconducting ( $\text{MoS}_2$ ) and semimetallic (graphene) 2D materials with both metallic and insulating substrates, for prospective applications in energy conversion or light sensing.

Collaborating entities: University of Manchester, Cornell University, Belfast University, FORTH/ICE-HT Patras, Accurion, Faculty of Mathematics and Physics, Charles University in Prague, Institute of Physics of the CAS.

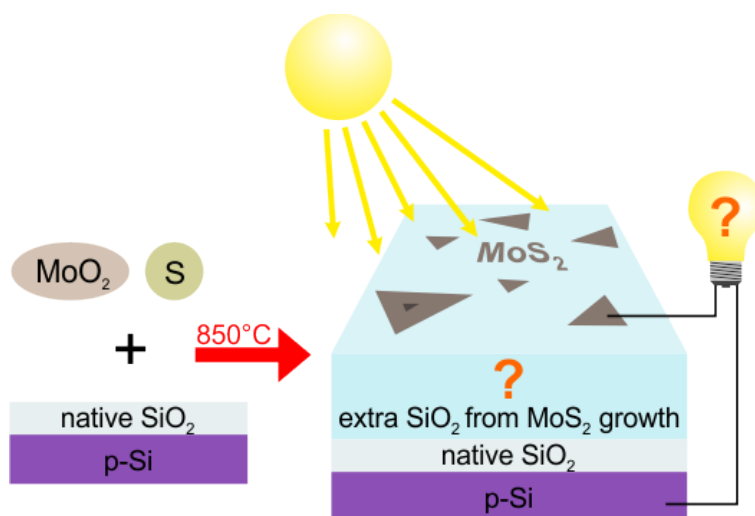

**Solar energy from monolayer  $\text{MoS}_2$ ?** Optoelectronic properties of monolayer semiconducting  $\text{MoS}_2$  seem to predestine this material for solar energy harvesting. However, for a successful large-scale application it is essential to solve the riddle of its large-area growth, especially concerning the unwanted growth of insulating oxidic interlayer.

Velický M, Rodriguez A, Bouša M, Krayev AV, Vondráček M, Honolka J, Ahmadi M, Donnelly GE, Huang FM, Abruña HD, Novoselov KS, Frank O. Strain and Charge Doping Fingerprints of the Strong Interaction between Monolayer  $\text{MoS}_2$  and Gold. *J Phys Chem Lett.* 2020;11(15):6112-6118

<https://doi.org/10.1021/acs.jpcllett.0c01287>

## Department of Electrochemistry in Nanoscale (8)

### Electron Storage System Based on a Two-Way Inversion of Redox Potentials

Molecular-level multielectron handling is a worthwhile approach to solar energy harvesting. We demonstrated a new "structronics" strategy which uses chemical bonds as electron reservoirs for energy storage. Through this concept, we showed for molecules with two closely spaced redox centres on a rigid scaffold that a covalent bond can be repeatedly formed and broken electrochemically with excellent chemical reversibility. These molecules displayed both anodic and cathodic potential inversion.

Collaborating entity: Université de Paris, France

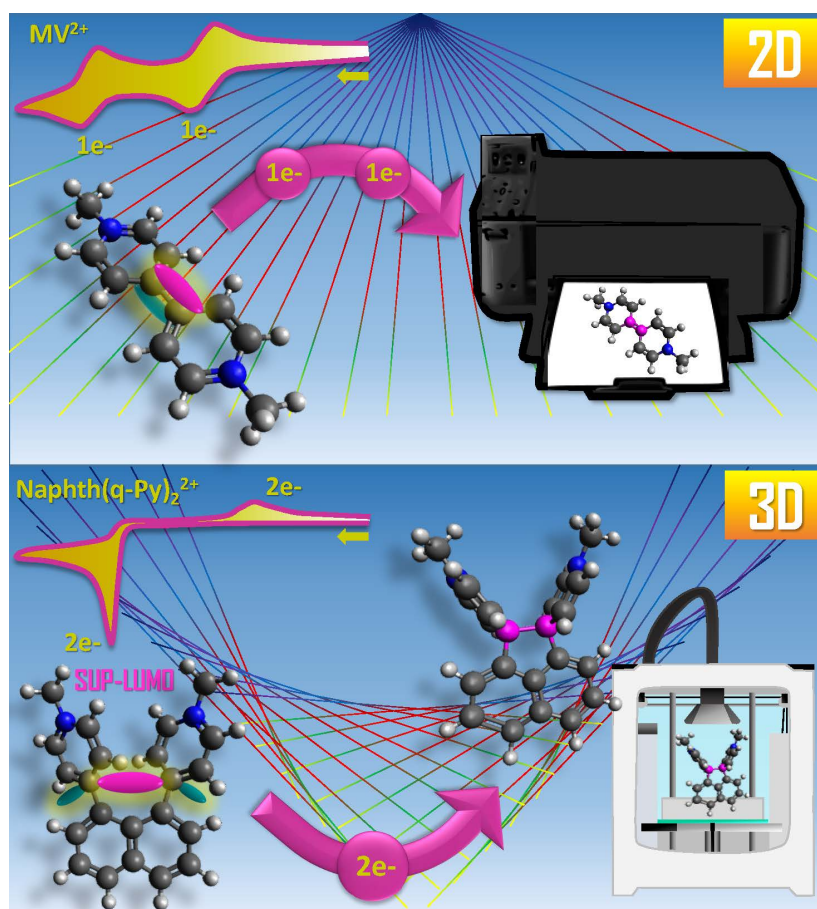

**Relationship between molecular structure and the electron storage mode.** Two types of molecular structures with different mode of the electron storage and possible reuse. Appropriate 3D geometry enables transfer of two electrons in one step.

Gosset A, Wilbraham L, Nováková Lachmanova Š, Sokolová R, Dupeyre G, Tuyères F, Ochsenbein P, Perruchot C, de Rouville HPJ, Randriamahazaka H, Pospíšil L, Ciofini I, Hromadová M, Lainé PP. Electron Storage System Based on a Two-Way Inversion of Redox Potentials. *J Am Chem Soc.* 2020;142(11):5162-5176

<https://doi.org/10.1021/jacs.9b12762>

## Department of Chemistry of Ions in Gaseous Phase (9)

Chemical ionisation of glyoxal and formaldehyde with  $\text{H}_3\text{O}^+$  ions using SIFT-MS under variable system humidity

Organic molecules present in the Earth's atmosphere can be oxidised or photo-oxidised into highly reactive dialdehyde glyoxal ( $\text{C}_2\text{H}_2\text{O}_2$ ), contributing to aerosol formation in the atmosphere. Glyoxal also plays a role in biological processes, and it is an intermediate product in the photocatalytic reduction of carbon dioxide to methane. The new SIFT-MS method of analysis allows quantification of glyoxal in humid air whilst drawing attention to ion overlaps with formaldehyde products.

Collaborating entity: Institut für Ionenphysik und Angewandte Physik, Leopold-Franzens-Universität Innsbruck, Innsbruck 6020, Austria

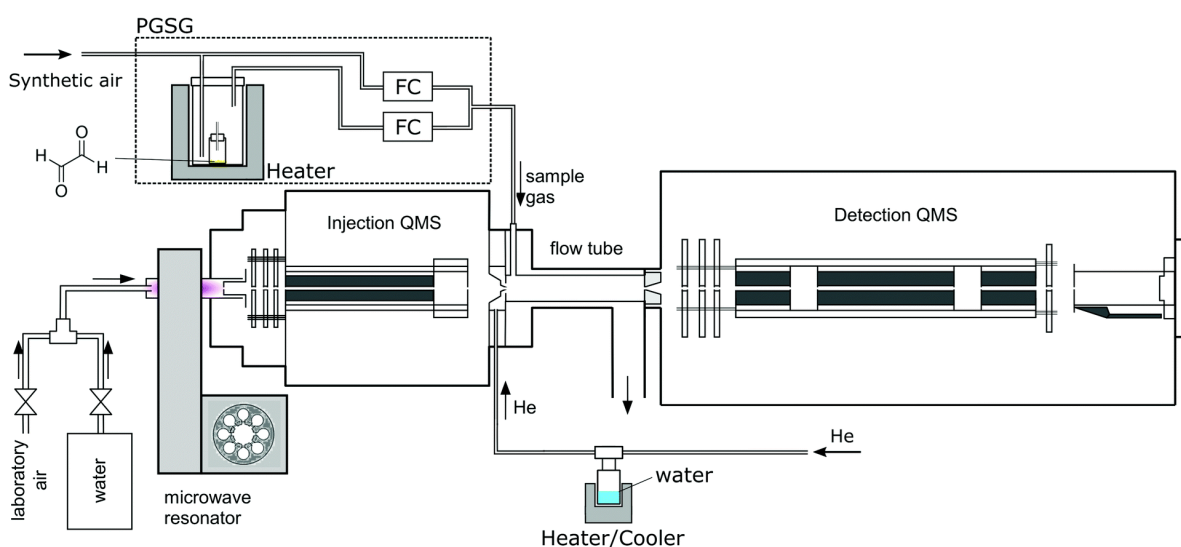

**A Scheme of the experimental setup including a precision gas standard generator PGSG and a selected ion flow tube mass spektrometry SIFT-MS instrument.** 2 mg of glyoxal crystals were placed into a 2 ml glass vial closed by a septum penetrated by a 5 cm long capillary (I.D. 0.25 mm), in a diffusion tube configuration. A precision gas standard generator (PGSG; 491M, Kin-Tek) was used at 50 °C to release glyoxal vapour and dilute it with synthetic air to reach the concentration of 15 ppmv, which was then introduced into the flow tube.

Lacko M, Piel F, Mauracher A, Španěl P. Chemical ionisation of glyoxal and formaldehyde with  $\text{H}_3\text{O}^+$  ions using SIFT-MS under variable system humidity. *Phys Chem Chem Phys*. 2020;22(18):10170-10178. <https://doi.org/10.1039/d0cp00297f>

**Department of Low-dimensional Systems (10)****Anomalous Freezing of Low-Dimensional Water Confined in Graphene Nanowrinkles**

We developed a technique, which enables capturing of the water molecules below an atomically thin graphene membrane structured into a net of regular wrinkles. We employed cryogenic Raman spectroscopy to monitor the phase changes of the confined water as a function of the temperature. Experimental findings were supported with molecular dynamics. Results show that surface premelting of the ice in our system starts at  $\sim 200$  K and the melting process is complete at  $\sim 240$  K.

Collaborating entity: Faculty of Mathematics and Physics, Charles University in Prague

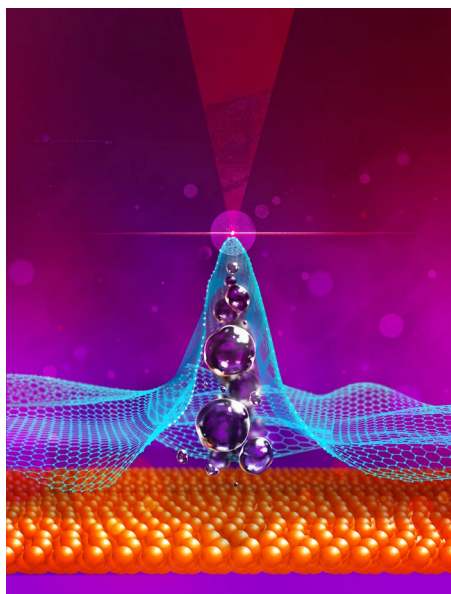

***Idealised representation of water enclosed in a nanowrinkle.*** The ice in this system begins to melt at 200 K and melts completely at 240 K.

Verhagen T, Klimeš J, Pacáková B, Kalbáč M, Vejpravová J. Anomalous Freezing of Low-Dimensional Water Confined in Graphene Nanowrinkles. *Acs Nano*. 2020;14(11):15587-15594. <https://doi.org/10.1021/acsnano.0c03161>

**Biocompatible silicalite film on the surface of TiAlV alloy**

A silicalite-1 film (SF) deposited on Ti-6Al-4V alloy was investigated before and after calcination at 500 °C as a promising anticorrosive coating for metallic implants. The SFs were characterised by X-ray photoelectron spectroscopy (XPS), by Fourier transform infrared spectroscopy (FTIR), by scanning electron microscopy (SEM) and water contact angle measurements (WCA). An increased cytocompatibility was proved for calcinated samples using *in vitro* experiment.

Collaborating entity: Institute of Physiology of the CAS

Nemcakova I, Jirka I, Doubkova M, Bacakova L. Heat treatment dependent cytotoxicity of silicalite-1 films deposited on Ti-6Al-4V alloy evaluated by bone-derived cells. *Scientific Reports*. 2020;10(1). <https://doi.org/10.1038/s41598-020-66228-x>

**Department of Dynamics of Molecules and Clusters (11)****Oxidation Enhances Aerosol Nucleation: Measurement of Kinetic Pickup Probability of Organic Molecules on Hydrated Acid Clusters**

Aerosols play an important role in atmospheric chemistry, global warming, they affect human health etc. Aerosol particle formation starts with uptake of gas phase molecules onto small clusters. Hydrated acids and volatile organic compounds play an important role in the new particle formation. We have developed a new experimental method to measure the pickup probability for molecules on clusters, which is a key parameter in atmospheric aerosol modelling.

Collaborating entity: J. Lengyel (former PhD student at the JHIPC), Lehrstuhl für Physikalische Chemie, Technische Universität München, Lichtenbergstrasse, 4, 85748, Garching, Germany

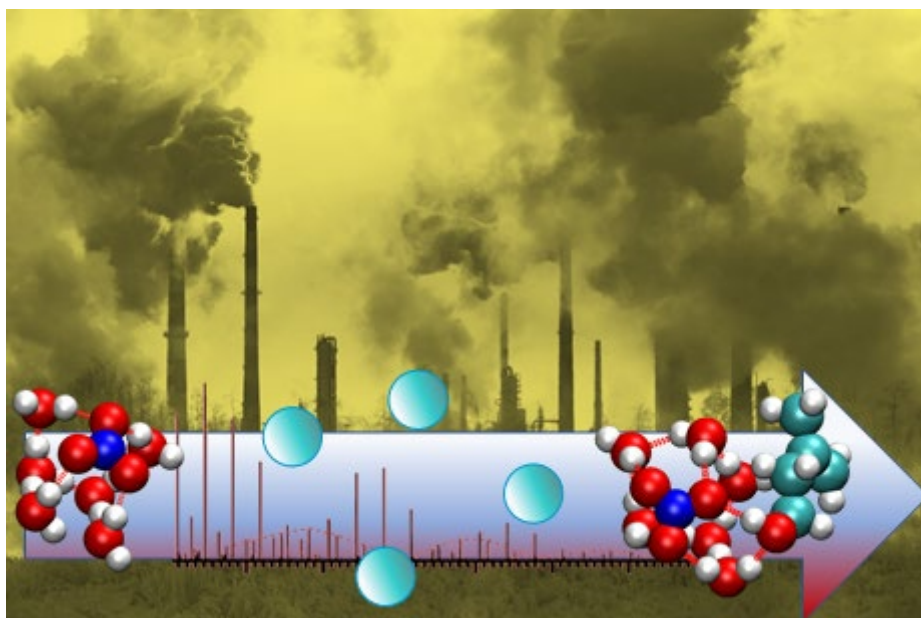

***Pickup of molecules on clusters is the initial step in the aerosol particle formation in the atmosphere.*** An aerosol particle formation in the atmosphere starts with the uptake of molecules on small clusters. Our experiments with clusters in molecular beams determined the pickup probability for organic compounds on hydrated nitric acid clusters.

Lengyel J, Pysanenko A, Fárníková K, Pluhařová E, Fárník M. Oxidation Enhances Aerosol Nucleation: Measurement of Kinetic Pickup Probability of Organic Molecules on Hydrated Acid Clusters. *J Phys Chem Lett.* 2020;11(6):2101-2105. <https://doi.org/10.1021/acs.jpcllett.0c00207>

## Department of Nanocatalysis (12)

## Advanced oxygen evolving catalysts based on mixed pyrochlores

We have developed novel class of oxygen evolving catalysts supporting energetically sustainable water electrolysis. These materials are based on cubic pyrochlores featuring Ru and Ir co-existing in the structure. These materials are cheaper than the current state of the art catalysts, can be used in acid environment and surpass the benchmark IrO<sub>2</sub> catalysts in terms of activity and stability. The combination of these qualities makes them prospective enablers of renewable hydrogen implementation.

Collaborating entity: PSI Villigen, University Copenhagen

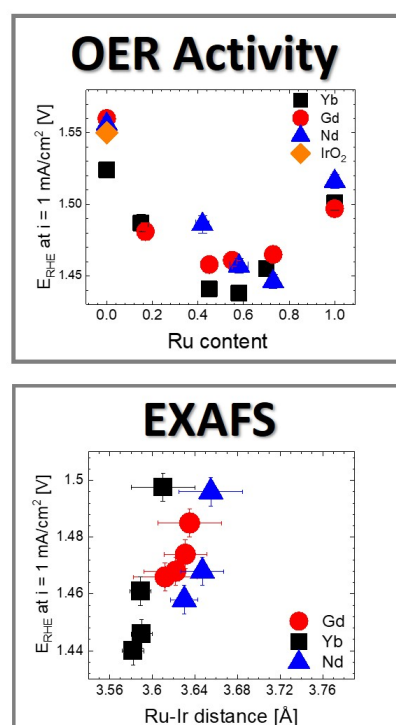
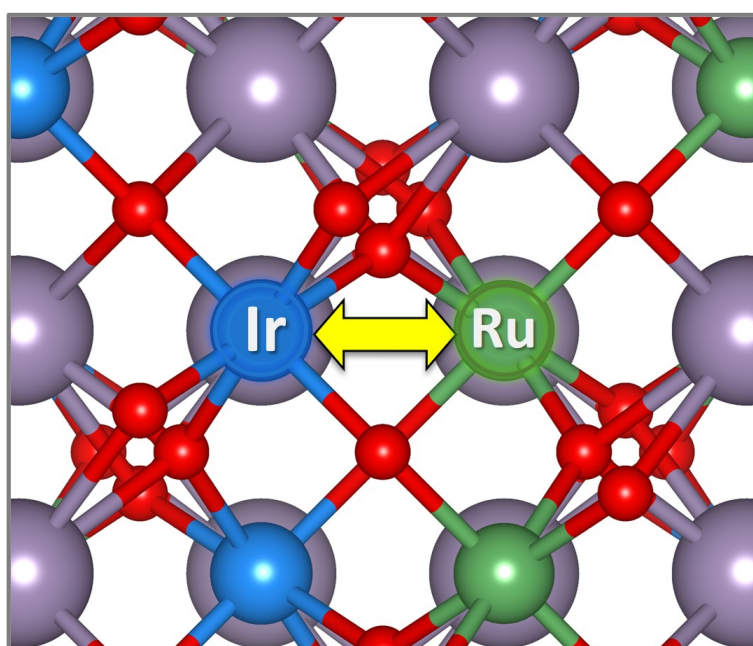

**Ru-Ir distance as OER descriptor and its actual relationship to the actual catalysts activity for mixed pyrochlores.** This figure illustrates the relative position of Ru and Ir in the pyrochlore structure (left) and its relation to intrinsic activity of these materials in acid media oxygen evolution (bottom right). The top right panel shows the dependence of the OER activity on the content of Ru.

Pittkowski RK, Abbott DF, Nebel R, Divanis S, Fabbri E, Castelli IE, Schmidt TJ, Rossmeisl J, Krttil P. Synergistic effects in oxygen evolution activity of mixed iridium-ruthenium pyrochlores. *Electrochim Acta*. 2021;366. <https://doi.org/10.1016/j.electacta.2020.137327>

**Scientometric achievements:**

The results of science and research achieved by the staff of JHIPC in 2020 were published in 182 articles in international impact journals, 2 monographs and 1 chapter in a book, and are listed in the ASEP database:

[https://asep.lib.cas.cz/arl-cav/cs/vysledky/?sort=DKI\\_AUP\\_TITLE&iset=2](https://asep.lib.cas.cz/arl-cav/cs/vysledky/?sort=DKI_AUP_TITLE&iset=2)

These works have been cited more than 465 times as of the date of this report. Chronologically selected publications are regularly published on the institute's website in the section 'News - Important publications':

<https://www.jh-inst.cas.cz/publications/publications-2020-web-of-science>

**Electrochimica Acta**, 2020, 361: 137059

Self-perturbation of the salt partition at the water/1,2-dichloroethane interface

Antonín Trojánek, Zdeněk Samec, Vladimír Mareček

DOI: 10.1016/j.electacta.2020.137059

**Analytical Chemistry**, 2020, 92: 14861–14866

Functional Assay to Correlate Protein Oligomerization States with Membrane Pore Formation

Radek Šachl, Sabína Čujová, Vandana Singh, Petra Riegerová, Peter Kapusta, Hans-Michael Müller, Julia P. Steringer, Martin Hof, and Walter Nickel

DOI: 10.1021/acs.analchem.0c03276

**ACS Nano**, 2020, 14: 15587–15594

Anomalous Freezing of Low-Dimensional Water Confined in Graphene Nanowrinkles

Tim Verhagen, Jiri Klimes, Barbara Pacakova, Martin Kalbac, and Jana Vejpravova

DOI: 10.1021/acsnano.0c03161

**Talanta**, 2020, 221: 121594

Differential pulse voltammetric determination of homovanillic acid as a tumor biomarker in human urine after hollow fiber-based liquid-phase microextraction

Vojtěch Hrdlička, Jiří Barek, Tomáš Navrátil

DOI: 10.1016/j.talanta.2020.121594

**Electrochimica Acta**, 2020, 354: 136623

Determination of heavy metal poisoning antidote 2,3-dimercapto-1-propanesulfonic acid using silver solid amalgam electrode

Vojtěch Hrdlička, Marta Choińska, Beatriz Ruiz Redondo, Jiří Barek, Tomáš Navrátil

DOI: 10.1016/j.electacta.2020.136623

**Advanced Optical Materials**, 2020, 8: 2070075

Rippled Nanostack Phototransistor: Rippled Metallic- Nanowire/ Graphene/ Semiconductor Nanostack for a Gate-Tunable Ultrahigh-Performance Stretchable Phototransistor

DOI: 10.1002/adom.202070075



**Icarus**, 2020, 354: 114057

Experimental study of the reaction of O<sup>-</sup> ions with CO<sub>2</sub> molecules with different ternary gases at temperatures relevant to the Martian ionosphere

Illia Zyma, Ján Žabka, Miroslav Polášek, Thuy Dung Tran, Patrik Španěl, David Smith  
DOI: 10.1016/j.icarus.2020.114057

**Electrochimica Acta**, 2020, 360: 136984

The development of a fully integrated 3D printed electrochemical platform and its application to investigate the chemical reaction between carbon dioxide and hydrazine

João Giorgini Escobar, Eva Vaněčková, Štěpánka Nováková Lachmanová, Federico Vivaldi, Jan Heyda, Jiří Kubišta, Violetta Shestivska, Patrik Španěl, Karolina Schwarzová-Pecková, Jiří Rathouský, Táňa Sebechlebská, Viliam Kolivoška  
DOI: 10.1016/j.electacta.2020.136984

**Inorganic Chemistry**, 2020, 59: 8707–8715

Gautam D. Strocio, Martin Srnec, and Ryan G. Hadt

Multireference Ground and Excited State Electronic Structures of Free- versus Iron Porphyrin-Carbenes

DOI: 10.1021/acs.inorgchem.0c00249

**The Journal of Physical Chemistry Letters**, 2020, 11: 6112–6118

Strain and Charge Doping Fingerprints of the Strong Interaction between Monolayer MoS<sub>2</sub> and Gold

Matěj Velický, Alvaro Rodriguez, Milan Bouša, Andrey V. Krayev, Martin Vondráček, Jan Honolka, Mahdi Ahmadi, Gavin E. Donnelly, Fumin Huang, Héctor D. Abruña, Kostya S. Novoselov, and Otakar Frank

DOI: 10.1021/acs.jpcllett.0c01287

**Physical Chemistry Chemical Physics**, 2020, 22: 16345–16352

Ion chemistry of phthalates in selected ion flow tube mass spectrometry: isomeric effects and secondary reactions with water vapour

Michal Lacko, Bartosz Michalczuk, Štefan Matejíčík, Patrik Španěl  
DOI: 10.1039/D0CP00538J

**Langmuir**, 2020, 36: 7200–7209

Nanobubble-Assisted Nanopatterning Reveals the Existence of Liquid Quasi-Two-Dimensional Foams Pinned to a Water-Immersed Surface

Hana Tarábková, Pavel Janda

DOI: 10.1021/acs.langmuir.0c00331

**Journal of the American Chemical Society**, 2020, 142: 10412–10423

Proton–Electron Transfer to the Active Site Is Essential for the Reaction Mechanism of Soluble  $\Delta^9$ -Desaturase

Daniel Bím, Jakub Chalupský, Martin Culka, Edward I. Solomon, Lubomír Rulíšek, Martin Srnec

DOI: 10.1021/jacs.0c01786

**Science Advances**, 2020, 6: eaaz9776

Dioxygen dissociation over man-made system at room temperature to form the active  $\alpha$ -oxygen for methane oxidation

Edyta Tabor, Jiri Dedeczek, Kinga Mlekodaj, Zdenek Sobalik, Prokopis C. Andrikopoulos and Stepan Sklenak

DOI: 10.1126/sciadv.aaz9776

**Physical Review Letters**, 2020, 124: 203401

Mode-Specific Vibrational Autodetachment Following Excitation of Electronic Resonances by Electrons and Photons

Cate S. Anstöter, Golda Mensa-Bonsu, Pamir Nag, Miloš Ranković, Ragesh Kumar T. P., Anton N. Boichenko, Anastasia V. Bochenkova, Juraj Fedor, and Jan R. R. Verlet

DOI: 10.1103/PhysRevLett.124.203401

**Journal of Chemical Theory and Computation**, 2020, 16: 3028–3040

Near-Linear Scaling in DMRG-Based Tailored Coupled Clusters: An Implementation of DLPNO-TCCSD and DLPNO-TCCSD(T)

Jakub Lang, Andrej Antalík, Libor Veis, Jan Brandejs, Jiří Brabec, Örs Legeza, Jiří Pittner

DOI: 10.1021/acs.jctc.0c00065

**The Journal of Physical Chemistry Letters**, 2020, 11: 2101–2105

Oxidation Enhances Aerosol Nucleation: Measurement of Kinetic Pickup Probability of Organic Molecules on Hydrated Acid Clusters

Jozef Lengyel, Andriy Pysanenko, Karolína Fárníková, Eva Pluhařová, Michal Fárník

DOI: 10.1021/acs.jpcllett.0c00207

**Journal of Electroanalytical Chemistry**, 2020, 864: 114066

Catalytic properties of variously immobilised mushroom tyrosinase: A kinetic study for future development of biomimetic amperometric biosensors

Milan Sýs, Michaela Obluková, Viliam Kolivoška, Romana Sokolová, Lucie Korecká, Tomáš Mkysek

DOI: 10.1016/j.jelechem.2020.114066

**Electrochimica Acta**, 2020, 340: 135975

S- and N-doped graphene-based catalysts for the oxygen evolution reaction

L.M.Rivera-Gavidia, M.Luis-Sunga, M.Bousa, V.Vales, M.Kalbac, M.C.Arévalo, E.Pastor, G.García

DOI: 10.1016/j.electacta.2020.135975

**Journal of the American Chemical Society**, 2020, 142: 5162–5176

Electron Storage System Based on a Two-Way Inversion of Redox Potentials

Alexis Gosset, Liam Wilbraham, Štěpánka Nováková Lachmanová, Romana Sokolová, Grégory Dupeyre, Fabien Tuyères, Philippe Ochsenbein, Christian Perruchot, Henri-Pierre Jacquot de Rouville, Hyacinthe Randriamahazaka, Lubomír Pospíšil, Ilaria Ciofini, Magdaléna Hromadová, Philippe P. Lainé

DOI: 10.1021/jacs.9b12762

**Journal of the American Chemical Society**, 2020, 142: 3947–3958

Understanding and Predicting Post H-atom Abstraction Selectivity through Reactive Mode  
Composition Factor Analysis

Mauricio Maldonado-Domínguez, and Martin Srnec

DOI: 10.1021/jacs.9b12800

### III. 2. Important projects

In 2020, JHIPC participated in 11 research projects with the support of foreign funders and 91 research projects financially supported by several different domestic funders, in which the researchers from the JHIPC acted as principal investigators / co-investigators or project partners.

#### RESEARCH PROJECTS FINANCIALLY SUPPORTED BY SEVERAL DIFFERENT DOMESTIC FUNDERS

FUNDER	NUMBER OF PROJECT
Czech Science Foundation	42
Ministry of Education, Youth and Sports	29
Czech Academy of Sciences	10
Technology Agency of the Czech Republic	6
Ministry of Industry and Trade	3
Ministry of the Interior	1
Other	1
Foreign	11

#### Selected research projects

**Concert of lipids, ions, and proteins in cell membrane dynamics and function** (GACR, EXPRO), principal investigator: Martin Hof, partner institution: Institute of Organic Chemistry and Biochemistry, CAS.

The aim of the project is to present a new perspective on the closely intertwined interplay between lipids, ions and proteins, which significantly affects membrane processes such as cell signalling and membrane transport. (2019-2023)

**Modernisation and improvement of a large research infrastructure Nanomaterials and Nanotechnologies for Environment Protection and Sustainable Future** (Ministry of Education, Youth and Sports, Pro-NanoEnviCz II), principal investigator: Martin Kalbáč, partner institutions: Technical University of Liberec and E. Purkyně University in Ústí nad Labem. The project is directly linked to the existing research infrastructure NanoEnviCz and complements it in the area of critically lacking instruments and expertise. (2020-2022)

### **Architectronics of Two-dimensional crystals via synergy of chiral electro-chemical and opto-electronic concepts on Å-scale.**

(GACR, EXPRO), principal investigator: Martin Kalbáč, partner institutions: Technical University of Liberec and E. Purkyně University in Ústí nad Labem. The aim of the project is to achieve electrochemical and chiral manipulation of excitons / superradiance on platforms based on ultrapure 2D gratings and chiral entities, i.e. with the coexistence of geometric and Berry phases of induced chirality. (2020-2024)

### **Use of a catalyst for the production of methanol from methane, wherein the catalyst comprises a zeolite having vapors in the skeleton based on the total number of all aluminum atoms in the zeolite, and a transition metal cation.**

Team: Jiří Dědeček, Zdeněk Sobalík, Edyta Tabor, Štěpán Sklenak, Kinga Mlekodaj. A catalyst with binuclear transition metal centers that is capable of selectively oxidising methane to methanol and other liquid products at low temperatures and without the use of an effluent to release the products.

**Utilisation:** Negotiations on intellectual property protection and commercialisation take place.

## **Selected strategic projects**

**AV21 Strategy** is a project of the Academy of Sciences of the Czech Republic, which was established in 2015, whose motto is "Top research in the public interest". This project is implemented mainly through coordinated research programs of mutually cooperating institutes of the CAS and other organisations. Research takes place in long-term interdisciplinary programs that focus on solving current problems and challenges and emphasise the practical application of results in economically and socially important areas. At the same time, the AV21 strategy retains the determinative role of basic research, which conditions the development of all scientific disciplines.

J. Heyrovský Institute of Physical Chemistry is involved in programs:

### **Nanostructured materials for energy conversion**

[www.avcr.cz/cs/strategie/vyzkumne-programy/prehled-programu/3.-ucinna-premena-a-skladovani-energie/index.html](http://www.avcr.cz/cs/strategie/vyzkumne-programy/prehled-programu/3.-ucinna-premena-a-skladovani-energie/index.html)

### **Nanostructured materials for catalysis and environmental protection**

[www.avcr.cz/en/strategy/research-programmes/programmes-of-strategy-av21/10.-molecules-and-materials-for-life/](http://www.avcr.cz/en/strategy/research-programmes/programmes-of-strategy-av21/10.-molecules-and-materials-for-life/)

**ERA chair**, (acronym **J. Heyrovský chair**), project leader: J. Hrušák, international project of Horizon 2020 programme, funder: European Commission.

The J. Heyrovský chair is appointed to Dr Stefan Vajda since January 2019. The department of nanocatalysis was also established in January 2019. In 2020, two vacuum apparatuses for depositing subnanometer and nanometer clusters were installed and put into operation, as well as the first of five apparatuses for testing the catalytic activity of the cluster (imported from the USA). At the same time, studies of chemically prepared catalysts have been successfully launched, for example in dehydrogenation reactions or in the conversion of CO<sub>2</sub> into useful chemicals. Members of the department published about ten scientific articles during this period and participated in the education of high school students in the form of internships in the laboratories of the department.

**Capacity development of JHIPC**, project leader: M. Kalbáč, project leader: M. Kalbáč, Funder: Ministry of Education, Youth and Sports, programme RKV I.

**Capacity development of JHIPC II**, project leader: M. Kalbáč, Funder: Ministry of Education, Youth and Sports programme RKV I., programme RKV II.

More than ten years ago, the European Commission issued recommendations in the European Charter for Researchers and in the Code of Conduct for the Recruitment of Researchers (C&C, 2005/251/ES) and specified a set of principles for improving the research system. The implementation of C&C principles in research institutions is supported by the **Human Resources Strategy for Researchers (HRS4R)**. At the beginning of 2019, the JHIPC officially joined the research organisations that received the **HR Excellence in Research** award. The HR Award is a motivating factor for aligning human resources policy with international standards. At the end of 2020, we revised the Action Plan and sent it for assessment to the EC evaluator, who will evaluate the current progress in individual activities. If the ongoing activities are not sufficiently developed and implemented, the EC evaluator will alert us to the possible loss of the HR Award in the next three years, when we will defend it, and we will be visited by three independent EC evaluators. The HR Award is not only a sign of quality but also a permanent commitment to creating favourable conditions for employees of the JHIPC. Project Capacity development of JHIPC (since 2018) supports the implementation of some activities of the Action Plan. We obtained the follow-up Capacity development of JHIPC II that started in 2020.

In 2020, we dealt with several important activities:

- We have launched a new unified researcher recruitment process that complies with OTM-R principles (Open, Transparent and Merit-based Recruitment). The institute staff was acquainted with this recruitment procedure, and the training was recorded and stored on the internal website.
- The organisational structure of the institute was changed in order to increase the efficiency of work and cooperation between support departments and scientific departments.
- We have created a more modern concept of safety and health training at work, fire protection, computer safety and first aid.
- We founded the Technology Transfer Office, which helps scientists in matters of intellectual property and technology transfer. We have updated and reissued methodologies and strategies for intellectual property and technology transfer. Each scientific department has appointed its own contact person (technology scout), whose

role is to mediate between the scientists in the department and the employee of the TTO to identify possible results suitable for protection.

- We have launched a new intranet system for recording scientific results - the publication part. The identification of the intellectual property results that are suitable to be protected is in the process.
- Employees of the JHIPC had the opportunity to participate in different training, e.g., soft management skills, knowledge in the field of intellectual property and technology transfer, popularisation of science, basics of scientific work in English or continuing education for members of the section for the economy department.
- An important part of our strategy is publishing documents in Czech and English and creating a bilingual environment.

More information can be found at this link:

[www.jh-inst.cas.cz/cs/zakladni-stranka/strategie-lidskych-zdroju-pro-vyzkumne-pracovniky-hrs4r-2](http://www.jh-inst.cas.cz/cs/zakladni-stranka/strategie-lidskych-zdroju-pro-vyzkumne-pracovniky-hrs4r-2)

JHIPC provides facilities for the office of Jan Hrušák, President of the European Strategic Forum for Research Infrastructures (ESFRI). JHIPC is also the recipient of the StR ESFRI 2 project (H2020 Grant agreement ID: 823711).

In 2020, ESFRI engaged in a wider debate on the future shape of the European Research Area (ERA) at EU level. ESFRI embodied its vision of the role of research infrastructures as one of the ERA's priorities in a strategic document called "[ESFRI White Paper 2020: Making Science Happen – A New Ambition for Research Infrastructures in the European Research Area](#)". In May 2020, ESFRI President Jan Hrušák presented this strategy document at the international conference "European Research Infrastructures for a Smarter Future" organised by ESFRI under the auspices of the Croatian Presidency of the Council of the EU. In 2020, ESFRI continued to prepare an update of the Roadmap for Research Infrastructures, to be issued in December 2021. Furthermore, ESFRI strengthened the dialogue with the platform EOSC (European open science cloud), e.g., a workshop was organised on the transfer of expertise between research infrastructures and other EOSC actors. In response to the global pandemic and as an ESFRI's contribution to the ERAvsCORONA Action Plan, a dedicated website ([www.esfri.eu/covid19](http://www.esfri.eu/covid19)) has been set up to gather all relevant information on the services of almost 100 research infrastructures at European and national level in the fight against Covid 19. In 2020, ESFRI President Jan Hrušák spoke in 2020 as an invited speaker at several dozen conferences and workshops.

The activities of the President of ESFRI not only represent a prestigious representation for the Czech Republic, but also help to shape and steer Czech research, development and innovation policy in Europe. The support team of the chairman of ESFRI at JHIPC participates in the drafting of documents for negotiations on all aspects of ESFRI and EOSC. It participates in developing Czech positions and projecting European Union policies into the Czech Republic agenda in area of research (e.g. Structural Funds). These activities are carried out in coordination with Technological Centre of CAS and the Ministry of Education, Youth and Sports.

### III. 3. Significant awards

The following scientists and students were awarded in 2020 for the results of their research activities:

**RNDr. Martin Srnec, Ph.D.** - The Award of the Learned Society of the Czech Republic in the category "junior researcher" for significant scientific contribution, for Modeling of enzymatic reactions using computational methods of quantum chemistry; specialisation in a class of enzymes having a transition metal ion in the catalytic center (e.g. iron, manganese, copper and others). Awarded by the Learned Society of the Czech Republic.

**Mgr. Jiří Dědeček, CSc., DSc., Mgr. Edyta Tabor, Ph.D., RNDr. Štěpán Sklenák, Ph.D.** - The Česká hlava PROJEKT Award (Czech Mind PROJECT), Invence (Invention) prize was awarded for the creation and description of the structure and reactivity of new, unique types of reaction cationic centers of transition metals in a zeolite matrix and their use in the oxidation of methane to methanol. Awarded by the Česká hlava initiative (Czech Mind).

**Patricia Kinga Mlekodaj, Ph.D., RNDr., Mgr., Alan Liška, Ph.D.** - The Otto Wichterle Award to selected, exceptionally high-quality and promising researchers of the CAS, who contribute excellent results to the development of scientific knowledge. Awarded by the chairwoman of the CAS prof. Eva Zažímalová.

**RNDr. Martin Srnec, Ph.D., Carlos Mauricio Maldonado Domínguez, Ph.D., Ing. Daniel Bím, Ph.D., doc. Mgr. Lubomír Rulíšek, CSc., DSc.** - The Werner von Siemens Award in the category "The most significant result of fundamental research". The awarded study describes the discovery of a new factor for hydrogen atom transfer, which will enable, for example, the development of more efficient catalysts; awarded by Siemens.

**Mgr. Lukáš Petera** - The Werner von Siemens Award for Best Diploma Thesis entitled 'Consequences of heavy bombardment for chemical and prebiotic evolution on early Mars and Earth'. The thesis summarises and interprets the results of laboratory experiments dealing with the consequences of the effects of asteroids on the evolution of young planets just before the possible emergence of life and it was supervised by RNDr. Martin Ferus, Ph.D.; awarded by Siemens.

**prof. RNDr. Patrik Španěl, Dr. rer. nat., Mgr. Anatolii Spesyvyi, Ph.D.** and prof. David Smith - The Vladimír Hanuš Award for the best published work in the field of mass spectrometry. The work describes electrostatic switching and selection of reaction ions for mass spectrometric analysis of air and breath in a current drift tube. Awarded by Spectroscopic Society of Jan Marek Marci.

**Mgr. Sofiia Tvorynska** - The Metrohm Award for the best publication of a young chemist (under 35) in the field of electroanalytical chemistry. Awarded by Metrohm, Czech Republic and The Czech Chemical Society for the scientific article entitled "Amperometric biosensor based on enzymatic reactor for choline determination in flow systems".

**RNDr., Mgr. Alan Liška, Ph.D.** - The Metrohm Award for the best publication of a young chemist (under 35) in the field of electroanalytical chemistry. Awarded by Metrohm, Czech Republic and The Czech Chemical Society for the scientific article entitled "The cone-tetranitrocax[4]arene tetra radical tetra anion as an electro-chemically generated ligand for heavier alkali metal cations".

For the archive of all awards follow the link:

[web.jh-inst.cas.cz/cs/prizes](http://web.jh-inst.cas.cz/cs/prizes)



### III. 4. Promotion and popularization

The cooperation of JHIPC with the different media in various forms to promote the results of the activities of scientists takes place throughout the year. JHIPC cooperates with the the Division of Media Communication of the CAS in the field of media coverage of research results and promotion of science to the target group, which is primarily the general public.

During 2020, the research activities of the JHIPC scientists were regularly presented to the public through popularisation articles in the daily press, magazines, internet servers and in the form of interviews on radio and television. Dozens of articles, interviews and reports were published in the media in this way. A selection of the most important media outlets is publicly available on the JHIPC's website:

[web.jh-inst.cas.cz/media](http://web.jh-inst.cas.cz/media)

In the course of 2020, the JHIPC also issued a total of 11 press releases, covering research results and significant events directly related to the JHIPC. All press releases in full and with subsequent responses in the media are regularly published on the website of JHIPC:

[web.jh-inst.cas.cz/cs/press-releases](http://web.jh-inst.cas.cz/cs/press-releases)

In the course of 2020, profiles of our institute were created on the social networks Twitter and LinkedIn, through which we also inform the general and professional public about the activities and research results of our scientists.

We also focused on communicating current events within the JHIPC. In addition to the regularly updated information TV panel in the JHIPC's lobby, we introduced a regular monthly Newsletter since November 2020, which we send to all employees of the JHIPC by email, in order to improve employees' awareness of current events. The newsletter provides all employees with up-to-date information on important events, awards, important publications or vacancies within the JHIPC.

#### **Popularisation of results of research and development through programs for those interested in natural sciences:**

The EDU educational laboratory and classroom could only operate in a limited mode (for smaller groups of students) with its programs for primary and secondary school pupils, during January and February and from June to September. Most of the events reserved by schools for 2020 (99 events) had to be canceled and postponed indefinitely. Only 38 small events took place in person (e.g. chemistry clubs and some visits of smaller groups of students, internships in laboratories, two weekly summer schools and a course for teachers). These events were attended in total by 1,160 participants.

During the year, there were also individual internships and internships for gifted high school students (36 students), so their program was largely fulfilled.

In mid-March (after closure of full-time teaching at schools), PEXED JHIPC team (Popularization EXperimental EDUcation) decided to cooperate with the server [Věda na doma](#) (Science at Home) - i.e. switch to virtual programs, shoot videos from laboratories and prepare photo tutorials with worksheets for some of the tasks, specifically of the course "S chemikem v kuchyni" (With a chemist in the kitchen).

On 18 March, videos (6 tasks, each lasting about 30 minutes) were shot with us by the team of OAT Studio of the CAS in the EDU laboratory, and gradually, until June, it was broadcast on the CAS server Věda na doma (Science at Home, [www.avcr.cz/cs/pro-verejnost/veda-na-doma/pokusy](http://www.avcr.cz/cs/pro-verejnost/veda-na-doma/pokusy)), where they are archived. They are also archived on the Youtube channel of the CAS.

The scientific results are promoted regularly by:

- web application of the long-term educational project of the JHIPC Tři nástroje (Three tools):

[www.3nastroje.cz](http://www.3nastroje.cz)

- the JHIPC website:

[www.heyrovsky.cz](http://www.heyrovsky.cz)

A detailed schedule of the 2020 programs entitled **Věda na zkoušku 2020** (Testing Science) is archived on the website of the project Tři nástroje.

### **An overview of the most important popularisation and education programs and events in 2020:**

Even this year, at a time when the restrictions associated with Covid 19 allowed, some researchers at JHIPC participated in the education of students and teachers with their lectures, laboratory practices and other activities in various programs educating students and teachers.

Examples are courses organised by the project Otevřená věda AV ČR 2020 (Open Science of the CAS) for teachers (August, Jindříš at Jindřichův Hradec, chemistry courses); lectures for participants of the summer workshop for chemists Běstvina; lectures at the FyBiCH summer school organised by Contipro Dolní Dobrouč; lectures at the summer school of the University of Chemistry and Technology, Prague organised in August every year for high school students and teachers; participation in the teaching of chemistry and physics in the projects Šablony SŠ (High School Templates) in various schools (in the module "expert from practice", e.g. Masaryk Secondary School of Chemistry, Prague 1 and Bishop Grammar School, Žďár nad Sázavou).

The PEXED team regularly organised chemistry classes through two groups once a month in the premises of its EDU centre with a laboratory and a seminar room. A total of 25 students (age 8 to 14 years) got acquainted with chemistry and physics in experimental tasks. The program was supported by a grant from the Ministry of Education, Youth and Sports in the "Program pro nadané" (Program for the Gifted, No. 0004/7/NAD/2020).

From March to the end of 2020, the JHIPC PEXED team participated in the activities offered by the server Věda na doma (Science at Home) of the CAS with many new virtual programs:

6 instructional videos, 7 photo tutorials for experiments of the course S chemikem v kuchyni (With a chemist in the kitchen), a series of twenty chemical experiments for the little ones, an audio of a children story about chemistry was recorded, etc. Our programs had a high audience, as evidenced by the numbers as of 31 December, 2020: viewership of 7.8 thousand users. At the Facebook page of the CAS, the viewership was 29.7 thousand users.

22 high school students from 15 schools from all over the Czech Republic visited the traditional August event **NANOškola 2020** (NANOschool, August 17-21, 2020), which was supported for the fifth time by the Ministry of Education, Youth and Sports project in the

## ASSESSMENT OF THE MAIN ACTIVITY

Support program for gifted high school and elementary school students (project 0003/7/NAD/2020).

15 high school students completed year-round internships in the project [Otevřená věda AV ČR 2020](#) Otevřená věda AV ČR 2020 (Open Science of the CAS) at JHIPC under supervision of 17 instructors. This activity was supported by the project of Ministry of Education, Youth and Sports 0038/7/NAD/2020 in the program Support for gifted high school and middle school students. As part of this project, a one-week August course in chemical experiments called *Dusík v Boru* (Nitrogen in Bor) took place, which was attended by 8 high school students.

For the annual [Týden vědy a techniky TVT 2020](#) (Science and Technology Week festival), the researchers of the JHIPC prepared a program consisting of virtual tours of laboratories in the form of short videos (see the *Tři nástroje*, Three Tools website), a program for elementary and middle school students and children who had the opportunity to watch experiment videos (6 videos shot in the laboratory in March 2020, each lasting about 30 minutes) and then try out the experiments at home according to the photo instructions (see the *Tři nástroje*, Three Tools website). Attendance of these programs was 725 virtual visits and 2,178 views of our TVT pages from 1 December to 12 December.

In 2020, the JHIPC organised two exhibitions only: exhibition of paintings and photographs "Jiří Mocek and Ivan Král- Krajinou tajemnou " (Trough Mysterious Landscape, January-February 2020) and "Věda a umění/Umění a věda "(Science and Art/Art and Science) presenting photographs by Svatopluk Civiš and paintings by Aleš Lamr, Jaroslav Vožniak and Karel Valter (September October 2020).

The website [www.3nastroje.cz](http://www.3nastroje.cz), which presents all the educational and popularisation activities of JHIPC scientists online achieved recording 5,200 visits and 14,950 views in 2020.



*Exhibitions in the lobby of the JHIPC, called Gallery 4P, are still an opportunity for meetings between science and art, although the number of exhibitions this year has been dramatically reduced by the presence of coronavirus all around us.*

### III. 5. Scientific and pedagogical collaboration of JHIPC with universities

In 2020, the JHIPC participated in the training of **53 PhD students** (in full-time and part-time forms of study; of this number, 5 defended their dissertation during 2020). **20 university students** were trained by researchers from JHIPC as part of their bachelor's and master's theses.

Unfortunately, due to the limitations associated with Covid 19, an annual Student Seminar could not be held to present the results of their dissertations. It did not seem beneficial to organise the seminar online, and therefore this option was not supported.

Thirty researchers participated in the **teaching of bachelor's, master's and PhD students** at ten universities, and during the summer/winter semester, a total of 429/460 hours in 38/17 semester cycles of lectures, seminars and practice exercises.

In 2020, 15 scientists were members of subject area boards of the doctoral study programmes (scientific advisory boards of PhD study). Fifteen scientists were members of examining committees for state bachelor, master and PhD exams, and for dissertation defence in the field of physical chemistry at several universities and colleges (Faculty of Science and Faculty of Mathematics and Physics, Charles University in Prague; Czech Technical University in Prague; University of Chemistry and Technology, Prague; University of Pardubice; Masaryk University in Brno; Palacký University Olomouc and University of South Bohemia in České Budějovice).

In 2020, the JHIPC again successfully collaborated in **21 grant projects** with different universities. The employees of JHIPC were principal investigators or project participants.

Another educational and, at the same time, popularisation activity is educating **high school youth** and working with talented high school students who are interested in studying natural sciences (lectures, excursions, workshops and internships). This activity has been carried out beyond everyday research activities since 2005.

Forty-three one-hour lectures on various topics in the field of physical chemistry were given to high school students in 2020. Students who completed high school internships at the JHIPC defended their work in various competitions, such as SOČ (High-School Expert Activity) or Amavet (Association for Youth, Science and Technology). The students submitted their work also as seminar papers and final exam papers (21 works in total). 2 female students advanced to the national round of SOČ competition.



**Educational programs:** *The offer and attendance of our chemical programs (from the shows for kindergartens, through workshops and groups for primary and middle school students to all-day programs with lectures, workshops and internships in laboratories for high school students throughout*

## ASSESSMENT OF THE MAIN ACTIVITY

the school year) was impacted by school closures due to Covid-19. Thus, for most of the school year, the planned programs could not be held in person. Thanks to a slight relaxation, the annual summer school NANO2020 and a chemistry course "Dusík v Boru" (Nitrogen in Bor, a town in the NW Bohemia, also Czech for boron) could take place (Figures 1 and 2). Chemistry groups for gifted children continued in the restricted conditions (number of pupils less than 10 and strict adherence to hygienic measures) for part of the year (Fig. 3).



### III. 6. Collaboration of the JHIPC with other institutions and with the business sector

In July 2020, the **JHIPC Technology Transfer Office (TTO)** was established based on the SM-31 Directive - Establishment of the Technology Transfer Office and the Board for the Commercialisation. This activity is related to the implementation of the project Capacity Development of JHIPC, for research and development II supported by the Operational Program Research, Development, Education. The main task of the TTO is the protection of the intellectual property of the JHIPC and its commercialisation.

During 2020, the TTO focused on creating a technology transfer strategy and the necessary structures within JHIPC. The result was not only the approval of the new directive SM-31, but also the update of the existing directive SM-09 - Management of intellectual property and protection and enforcement of industrial property rights.

The following strategic documents were developed and approved: Strategy for the Development of Cross-Sector Cooperation, Management of Intellectual Property and for the Transfer of Knowledge from Research to Practice and Methodology for Active Search of Research Results with High Commercialisation Potential.

During the year, many seminars and workshops were held for the staff of JHIPC with a focus on the protection of intellectual property and technology transfer.

At the end of 2020, the TTO resolved two license agreements with Betosan, s.r.o. and Eaton Elektronika, s.r.o., which were concluded and fulfilled only at the beginning of 2021.

In addition to licensing, the establishment of spin-off companies appears to be an important form of commercialisation, which is why we have prepared a "Proposal of a substantive plan for the establishment of spin-off JHIPC", which was submitted to the Supervisory Board of the JHIPC for approval.

This year, the JHIPC also became a new member of the TRANSFERA.CZ association, which brings together many important technology transfer organisations in the Czech Republic.

#### The results of cooperation with the business and other organisations obtained in a project

In 2020, the JHIPC collaborated with the business sector on seven projects.

##### **Functional prototype of a highly active zeolitic water isomerisation catalyst for the water isomerisation of C5 and C6 alkanes (TH03020814-V007)**

**Program:** Development of high-performance alkylation and isomerisation catalysts

**Result:** A prototype of a highly active zeolitic extruded hydroisomerisation catalyst for the hydroisomerisation of C5 and C6 alkanes produced by a developed technological process and developed extrusion processes.

The resulting form of the catalyst guarantees shape and chemical stability under conditions of temperature fluctuation. The result involves the production of a catalyst with proven activity under the industrial conditions of a test reactor.

**Application:** Euro Support will integrate the developed catalyst into its product portfolio. The application of the results of the solution will be coordinated by the management of Chemoprojekt, a.s., which will implement the results of the project and facilitate the implementation of the catalyst into the technological process.

**Funder:** Technology Agency of the Czech Republic

**Partner organisation:** Euro Support Manufacturing Czechia, s.r.o. (ESM) Chemoprojekt, a.s. (ChP)

### **Functional prototype of a catalyst for alkylation of benzene with ethylene. (TH03020814-V008)**

**Program:** Development of high-performance alkylation and isomerisation catalysts

**Result:** Functional prototype of an extruded zeolitic catalyst with high activity for alkylation of benzene with ethylene produced by a developed technological process and developed extrusion processes. The resulting form of the catalyst ensures dimensional stability under conditions of temperature fluctuations and the difficulty of using the catalyst in a liquid medium. The resulting form of the catalyst guarantees shape and chemical stability under conditions of temperature fluctuation. The resulting form of the catalyst guarantees shape and chemical stability under conditions of temperature fluctuation.

**Application:** The result of the solution will be offered through the specialists of the Chemoprojekt, as for the implementation of new ethylbenzene productions and separately as an innovative replacement for existing technologies.

**Funder:** Technology Agency of the Czech Republic

**Partner organisation:** Euro Support Manufacturing Czechia, s.r.o. (ESM) Chemoprojekt, a.s. (ChP)

### **LiNi<sub>1/3</sub>Mn<sub>1/3</sub>Co<sub>1/3</sub>O<sub>2</sub> with morphology optimised for the new 3D Li battery concept**

**Program:** Research and design of 48V lithium batteries for the automotive industry/TRIO program

**Result:** Publication in a scientific journal with IF

**Application:** Int. J. Energy Res. 2020, 44 (11), 9082-9092.

**Funder:** Ministry of Industry and Trade of the Czech Republic

**Partner organization:** HE3DA, s.r.o.

### **Basic 4V building block of a 48V lithium battery**

**Program:** Research and design of 48V lithium batteries for the automotive industry/TRIO program

**Result:** Functional sample

**Application:** Technical parameters: 4 volt battery cell with a capacity of 80-100 Wh forming the basic building block of a 48V lithium battery. Economic parameters: Increasing competitiveness in the international market producing batteries for the automotive industry.

**Funder:** Ministry of Industry and Trade of the Czech Republic

**Partner organization:** HE3DA, s.r.o.

### Prototype 48V/1.2 kWh starter battery

**Program:** Research and design of 48V lithium batteries for the automotive industry/TRIO program

**Result:** Prototype for further research

**Application:** Increasing competitiveness in the international market for batteries for the automotive industry

**Funder:** Ministry of Industry and Trade of the Czech Republic

**Partner organization:** HE3DA, s.r.o.

### Innovative photocatalytic concretes and concrete screeds

**Program:** Photoactive nanocomposite systems for improvement of the environment

**Result:** 1) Production process of photocatalytically active cement screed (proven technology) 2) Production process of photocatalytically active powder admixture for concrete (proven technology) 3) Photocatalytically active surface cement screed (utility model) 4. Photocatalytically active powder admixture for concrete (utility model)

**Application:** Betosan, s. r. o., the partner organisation of the joint project FV20234, plans the production and future application of the developed materials in the construction industry.

**Funder:** Ministry of Industry and Trade of the Czech Republic

**Partner organisation:** Betosan, s. r. o.

### Innovative nanocomposite coatings with photocatalytic self-cleaning and disinfection function

**Program:** Photoactive nanocomposite systems for improvement of the environment

**Result:** Colloidal system based on nanoparticles of titanium dioxide and silica for photocatalytic self-cleaning and disinfection surface treatment of historic buildings and other monuments.

**Application:** BAL Teluria, s. r. o., the partner organisation of the joint project TH04030090, plans application of developed materials for preventive surface treatment of historic buildings and other monuments.

**Funder:** Technology Agency of the Czech Republic

**Partner organization:** BAL Teluria, s. r. o.

### Results of collaboration with other organisations and businesses obtained based on contracts

In 2020, the JHIPC continued to fulfill the obligations of 4 contracts for work (domestic and foreign business and other entities). As part of the performance of these contracts, results were achieved, mostly submitted as technical reports.



### **Analysis of relationships between structure and activity of catalysts for MeOH transformation**

**Client:** RANIDO, s.r.o.

**Abstract:** Characterisation of the structure of ZSM 5 catalysts and testing of their properties (acidity) and activity (conversion and selectivity) in the transformation of MeOH to hydrocarbons.

**Application:** Application in the development of catalysts for the MTG process.

### **Evaluation of nanomorphology of the surface of the corrosion layer of Zr alloy samples by AFM**

**Client:** UJP PRAHA a.s.

**Abstract:** Evaluation of nanomorphology of the surface of the corrosion layer of Zr alloy samples by AFM.

**Application:** During assessing the corrosive effects of the environment corresponding to the VVER reactor on nanomorphological changes in the surface of Zr alloy tubes for nuclear fuel storage.

### **Improving the stability of the lipid layer of the tear film through the joint action of two drug molecules: a biophysical view**

**Client:** Santen SAS, France

**Abstract:** Using computer modeling, we explained the mechanism of stability of the lipid layer of the tear film through the joint action of two drug molecules.

**Application:** Assistance in the design and development of ophthalmic drugs.

## **Patents and utility models**

In 2020, 1 international patent and 2 utility models were granted.

### **International patent**

#### **Process for the preparation of inorganic nanofibers, in particular for use as heterogeneous catalysts and inorganic nanofibers**

The solution provides a process for the preparation of inorganic nanofibers, especially suitable for use as nanofiber heterogeneous catalysts containing a metal selected from the group consisting of Ag, Al, Ba, Ce, Cd, Co, Cr, Cu, Fe, Ge, Gd, La, Mo, Ni, Pb, Pd, Pt, Rh, Si, Sn, Sr, Ti, V, W, Y, Zn and Zr. The solution further provides inorganic nanofibers that contain metal oxides in the form of crystals and crystallites with the size of nanometer units organised in the form of mesoporous nanofibers with a thickness ranging from 20 to 800 nm and a length of 1  $\mu\text{m}$  to a continuous fiber length.

**Date of grant of the patent:** 29 October 2020

**Originators:** Petr Sazama, Galina Sádovská, Jaroslava Morávková, Aneta Krausová, Jan Buk, Zdeněk Sobalík

**Application:** In preparation.

### Utility model

#### Photocatalytically active surface cement screed

The utility model relates to the composition of a photocatalytically active cement screed for concrete, in which the screed guarantees their self-cleaning and disinfecting properties.

**Date of grant:** 10 March 2020

**Originators:** Pavel Dohnálek, Václav Pumpr, Ing. Jiří Dohnálek, Jan Šubrt, Michaela Jakubičková, Mgr. Martin Pustzaim, Jaromír Jirkovský, Hana Bíbová, Lenka Hykrdová, Eva Plížingrová, Monika Motlochová, Jaroslav Kupčík, Tereza Sázavská

**Application:** Betosan, s. r. o., the partner organisation of the joint project FV20234, plans the production and future application of the developed materials in the construction industry.

### Utility model

#### Photocatalytically active powder admixture for concrete

The utility model relates to the composition of a powder admixture in concrete: the admixture provides a photocatalytic self-cleaning and disinfection function.

**Date of grant:** 10 March 2020

**Originators:** Pavel Dohnálek, Václav Pumpr, Ing. Jiří Dohnálek, Jan Šubrt, Michaela Jakubičková, Mgr. Martin Pustzaim, Jaromír Jirkovský, Hana Bíbová, Lenka Hykrdová, Eva Plížingrová, Monika Motlochová, Jaroslav Kupčík, Tereza Sázavská

**Application:** Betosan, s. r. o., the partner organisation of the joint project FV20234, plans the production and future application of the developed materials in the construction industry.

### Information on the employees of the JHIPC who held positions in the governing bodies of major international scientific organisations

**RNDr. Jan Hrušák, CSc.** Name of the organisation: European Strategy Forum for Research Infrastructures (ESFRI), position: Chairman, term of office: 2019-2021

**Mgr. Magdaléna Hromadová, PhD.** Name of the organisation: International Society of Electrochemistry, position: officer of Division 6 (Molecular Electrochemistry). Term of office: 2019-2020

**doc. Ing. Petr Krtil, CSc.** Name of the organisation: International Society of Electrochemistry, position: executive secretary. Term of office: 2019-2023

### III. 7. International scientific collaboration

Within the framework of international cooperation, the JHIPC solved a total of 9 projects financed by the European Commission within the Horizon 2020 program. Furthermore, the JHIPC participated in 13 international projects, within the framework of international

scientific cooperation outside the EU framework programs and outside the projects of the Structural Funds.

### **Projects funded by the European Commission under the HORIZON 2020 program**

**Ion-Molecule Processes for Analytical Chemistry Technologies**, (acronym IMPACT), coordinator: University of Birmingham, investigator: prof. RNDr. Patrik Španěl, Dr. rer. nat. The project was launched in 2016 and continues until 2020.

**Trans-Spin NanoArchitectures: from birth to functionalities in magnetic field** (acronym TSuNAMI), coordinator: Charles University in Prague, investigator: doc. RNDr. Ing. Kalbáč Martin, Ph. D. The project was launched in 2017 and continues until 2022.

**Electrochemical Conversion of Renewable Electricity into Fuels and Chemicals** (acronym ELCOREL), coordinator: J. Heyrovský Institute of Physical Chemistry (Czech Republic), investigator: doc. Ing. Petr Krtil, CSc. The project was launched in 2017 and continues until 2021.

**ERA chair at J. Heyrovsky Institute of Physical Chemistry AS CR-The institutional approach towards ERA**, (acronym Heyrovsky Chair), coordinator: J. Heyrovský Institute of Physical Chemistry (Czech Republic). The project leader is RNDr. Jan Hrušák, CSc. The project includes an international advisory board. The project was launched in 2018 and continues until 2023.

**Transformative Chemistry for Sustainable Energy Future** (acronym Energy-X), coordinator: The Technical University of Denmark, investigator: doc. Ing. Petr Krtil, Ph.D. The project was launched in 2019 and continues until 2020.

**Proton Transport and Proton-Coupled Transport** (acronym PROTON), coordinator: Peter Pohl, investigator: prof. Martin Hof, Dr. rer.nat, DSc. The project was launched in 2019 and continues until 2023.

**Solar Energy for Circular Economy** (acronym SUNRISE), coordinator: University of Leiden, investigator: prof. RNDr. Antonín Vlček, CSc. The project was launched in 2019 and continues until 2020.

**Support to Reinforce the European Strategy Forum on Research Infrastructures** (acronym StR-Esfri2), coordinator: United Kingdom Research and Innovation, project participant: RNDr. Jan Hrušák, CSc. The project was launched in 2017 and continues until 2022.

**Irradiation driven nanofabrication: computational modelling versus experiment** (acronym RADON), coordinator: MBN Research Center, Germany, investigator: Mgr. Juraj Fedor, Ph.D. The project was launched in 2020 and continues until 2022.

## ASSESSMENT OF THE MAIN ACTIVITY

### International projects that were carried out in the framework of international scientific cooperation outside the EU framework programs

#### OVERVIEW OF INTERNATIONAL PROJECTS THAT ARE CARRIED OUT IN THE FRAMEWORK OF INTERNATIONAL SCIENTIFIC COLLABORATION

Funder	N. of Projects
INTER-EXCELLENCE (MEYS) sub-programme INTER-ACTION	1
INTER-EXCELLENCE (MEYS) sub-programme INTER-COST	3
Program Mobility (MEYS)	5
International Cooperation Program – Visegrad Group (MEYS)	1
International mobility of research (MEYS- Operational Program Research, Development and Education)	9

### III. 8. Conferences and foreign guests

Due to the global Covid 19 pandemic, the declaration of a state of emergency and the national safety regulations, it was not possible to carry out professional social activities.

#### Significant national scientific events organised or co-organised by JHIPC

##### **3rd Annual workshop of Ph.D. students in catalysis**

28 January 2020, venue: JHIPC, number of participants: 30

##### **72. sjezd chemiků (72nd Congress of Chemists)**

6 - 9 September 2020, venue: Prague Congress Center (outdoor areas), number of participants: 330

##### **Na hranici Země a vesmíru (At the border of Earth and Space)**

13 - 14 October 2020, venue: Hvězdárna a radioklub lázeňského města Karlovy Vary o.p.s. (Observatory and Radioclub of Spa City of Carlsbad), number of participants: 10 (max. permitted number according to epidemiological measures)

### IV. Assessment of additional and other activity: economics department

In addition to its main activity, in 2020 the JHIPC leased non-residential space in the building of cafeteria and in the main building e.g. to technology companies, a catering company and two other institutes of the CAS. JHIPC provided accommodation for its employees and foreign guests if needed.

It was possible to reduce the rent to 1/2 of the originally agreed price of the M-CATERING due to emergency measures to protect the population from further spread of COVID 19 caused by the new coronavirus SARS CoV 2 (Act No. 94/2021 Coll., On emergency measures in the event of an epidemic of COVID 19 and amending some related laws), which have a significant impact outside other to the economic activity of the tenant (restriction of the activity of catering establishments). However, this reduction will not be covered by the subsidy from the CAS.

### V. Information on the inspection performed by the Ministry of Finance, identified deficiencies and measures to eliminate them

In 2020, the Ministry of Finance inspected the project "For NanoEnviCz". Based on the performed audit of the project for the period April - September/2019, it was verified that all audited certified expenditures of this project are eligible. Only deficiencies in internal regulations concerning the internal control system pursuant to Act No. 320/2001 Coll. on financial control were detected. Findings and recommendations have been incorporated into internal guidelines.

### VI. Financial information about facts that are relevant to the assessment of the economic position of the institution and may affect its development

In 2020, no events occurred that would affect the economic position of the JHIPC to any significant extent. The financial results made it possible to meet the planned formation of a reserve for the repair of the real estate in Michle, Prague.

### VII. Expected development of JHIPC activities

In 2020-2022, the JHIPC will develop scientific and research activities in the field of physical chemistry and relevant other fields based on a strategy approved by the institute board. The main component of the activity will be the formulation of research and development projects and their implementation on the basis of targeted funding in the form of grant projects.

The ERA chairs project **Heyrovský Chair** is especially important. This project helps elevate scientific institutions among the best in the world. The JHIPC is only the second scientific center in the Czech Republic that achieved this prestigious funding. In total, the JHIPC obtained almost 2.5 million euros (over 60 million CZK), which was used, among other things, to acquire a world-renowned scientist based on an international tender. The position was appointed to prof. Štefan Vajda from Argonne National Laboratory and Institute for Molecular Engineering of the University of Chicago. In 2020, the team of the Nanocatalysis Department will expand full-scale experimental research.

## OTHER MANDATORY INFORMATION

The strategy also includes expanding the participation of the JHIPC in EU projects and supporting young researchers in developing their scientific careers. The JHIPC received the prestigious HR Award, fully entitled "HR Excellence in Research Award", awarded by the European Commission for excellence in the care of human resources in the scientific environment. Obtaining the HR Award is not only a sign of quality, but also a lasting commitment to continued development and the creation of favorable conditions for employees. Therefore, an action plan has been developed describing in a binding manner the concrete steps to bring the procedures in line with the "European Charter for Researchers" and the "Code of Conduct for the Recruitment of New Staff". After two years, a mid-term evaluation will be carried out, and then the JHIPC will be evaluated every three years.

In 2020, the administrative support of scientific work was improved in the form of process management, especially in the areas of grant support (creation of a new grant group as the basis of the future grant department), recruitment (OTM-R), intellectual property protection, open access to information, transfer technologies and their licensing.

The objectives of the **strategy for international cooperation in research and development** are formulated primarily as:

**Creation of a consolidated interinstitutional network** enabling international cooperation, including scientific education, and the sharing of best practices in the field of scientific management, based on an analysis of existing cooperation at the level of the JHIPC and its departments

**Adopting a participatory approach** to develop the concept of the European Research and Innovation Area. Coordination with international partners in formulating, presenting and promoting opinions, both on policy development and on specific program actions.

**Close cooperation with international partners** while sharing a unique scientific **infrastructure**, equipment and related services. Part of this goal is to fully expand the capacity of the JHIPC as a partner for international cooperation.

**In the field of promoting diversity and equal opportunities**, an audit will be carried out, and a Gender Equality Plan will be created on its basis.

**Get talented students** and researchers at an early stage and together with international partners to provide high-quality training in sophisticated scientific techniques in the wider field of physical chemistry. The medium-term goal is to intensify scientific cooperation with foreign universities aimed at awarding a "jointly awarded doctorate".

## VIII. Activities in the field of environmental protection

JHIPC participates in research projects related to environmental protection, both in basic research of environmentally important physical chemistry and in applied research in cooperation with industry.

JHIPC carries out regular disposal of waste generated in connection with research activities, especially chemicals and depreciated office equipment using the services of specialised companies, in cooperation with the city district office. The JHIPC also sorts the waste produced, namely glass, paper, plastics, batteries and accumulators.

## IX. Activities in the field of labour relations

An overview of the number of employees and the distribution of personnel costs are given in the Notes to the Financial Statements. The number of employees as on 31 December 2020 was 329, the

## OTHER MANDATORY INFORMATION

average recalculated number for 2020 was 242. The classification of the JHIPC's employees into the categories of professionals and researchers based on the updated internal salary regulations and career rules of the CAS is built upon the evaluation of scientific work by heads of departments and evaluation commissions based on specific criteria.

### NUMBER OF EMPLOYEES 31 December 2020

TOTAL NUMBER OF EMPLOYEES	329
AVERAGE RECALCULATED NUMBER OF EMPLOYEES	242
NUMBER OF EMPLOYEES (scientific positions)	224
PhD STUDENTS	53
N. OF FOREIGN SCIENTISTS (scientific positions)	89 (27 %)
N. OF WOMEN (scientific positions)	80

### Age-sex pyramid (male / female)

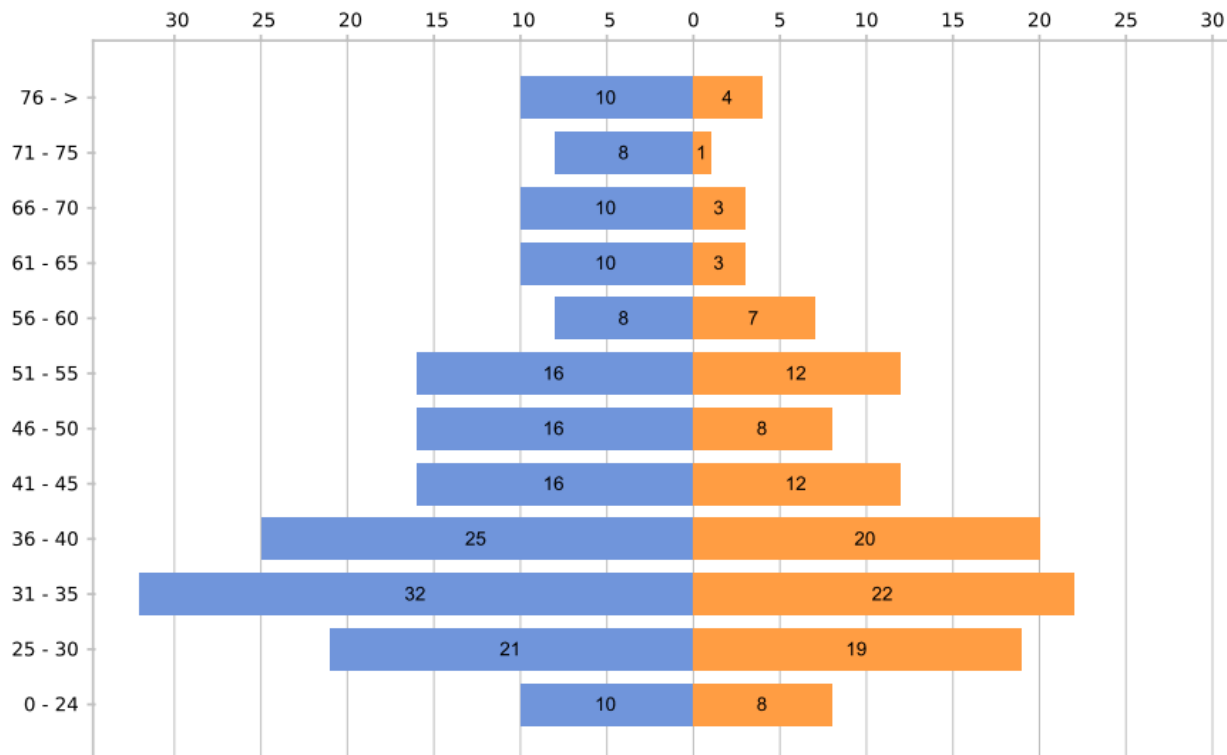

## OTHER MANDATORY INFORMATION

During 2020, 329 employees of the JHIPC (average recalculated number 241.91) were paid CZK 115,997,384 in salaries and CZK 20,706,698 in the form of bonuses. The average gross monthly wage was CZK 47,092, including personal evaluation, wage compensation and bonuses.

### **X. Provision of information under Act No. 106/1999 Coll., On Free Access to information**

In 2020, no request for information was submitted under Act No. 106/1999 Coll., On Free Access to information.

**Stamp**

**signature of the director of the JHIPC**



This document was created with support of the project Rozvoj kapacit ÚFCH JH, v.v.i. pro výzkum a vývoj (reg. No. CZ.02.2.69/0.0/0.0/ 16\_028/0006251) financed by the Ministry of Education, Youth and Sports and the European Structural and Investment Funds in the Operational Program Research, development and education.



EVROPSKÁ UNIE  
Evropské strukturální a investiční fondy  
Operační program Výzkum, vývoj a vzdělávání



