

ISI
CAS

Institute of Scientific
Instruments
The Czech Academy
of Sciences

MISSION

Development of new diagnostic methods, novel instrumentation principles and advanced technologies operating in the range from the macroscopic to the quantum regimes, enabling significant progress in the understanding of inanimate and living nature and the practical applications thereof.

PRINCIPAL ACTIVITIES

- Multidisciplinary research and advanced engineering combining the fields of magnetic resonance spectroscopy and tomography, electron microscopy and microanalysis, laser based spectroscopy, imaging, manipulation, and nanometrology, acquisition and processing of biosignals and large data, cryogenics, electron and laser beam technologies
- Dissemination of scientific results in respected journals, proceedings etc.
- Training of young researchers in multidisciplinary world-class research
- Involvement of university students in ISI scientific activities and provision of doctoral study programmes in cooperation with universities
- Raising the level of knowledge and education via popularization activities focused on the public and students of all levels, promoting science and technology through direct research projects with high and basic schools
- Technology transfer of applicable results to industry, education and health
- Promoting international cooperation within the scope of ISI activities
- Organization of scientific meetings, conferences and seminars at national and international level
- Providing critical infrastructure for research

Institute of Scientific Instruments
of the CAS, v.v.i.

Královopolská 147, 612 64 Brno
Czech Republic

Phone: +420 541 514 111

E-mail: institute@isibrno.cz

www.isibrno.cz

VAT number: CZ68081731

Data Box ID: 8c4nph

MAIN CONTACT PERSONS

Director: prof. Josef Lazar

Phone: +420 541 514 204

E-mail: director@isibrno.cz

Deputy Director for Research:

prof. Pavel Zemánek

Phone: +420 541 514 202

E-mail: Pavel.Zemanek@isibrno.cz

Deputy Director for Executive Affairs:

Dr. Bohdan Růžička, MBA

Phone: +420 734 313 043

E-mail: Bohdan.Ruzicka@isibrno.cz



Main entrance of ISI CAS.

STATISTICS 2022

Financial resources (in thousands of CZK)

■ **Resources for expensive equipment and construction: 32 050**

■ **Operating resources: 254 360**

- from The Czech Academy of Sciences: 121 789
- from Czech projects: 121 545
- from international projects: 11 026

■ **Revenue from contractual research: 16 154**

Number of employees (full-time equivalent FTE)

■ **Total: 207**

- Number of researchers and research assistants: 84 FTE
- Number of PhD students: 37 FTE
- Administrative and technical support: 86

Number of outputs

■ **Number of papers in scientific journals with impact factor: 63**

■ **Number of filed patents or utility models: 3**

RECENT AWARDS

- 2022** Pavel Jurák & AIMT team – winner EHRA 2022 Technology and Innovation with Ventricular Dyssynchrony Imaging – VDI monitor, cardiac pacing procedure optimization by ultra-high-frequency ECG
- 2021** Šárka Mikmeková won the prestigious prize of “The Lumina quaeruntur premium”
- 2021** Scientific group AIMT (F. Plešinger) won 3x the first prize in the international competition PhysioNet/CinC Challenge for AI algorithm analyzing cardiac rhythm (P. Nejedlý et al.)
- 2021** Vojtěch Svak received prestigious award of “Talent Foundation of Josef, Marie and Zdenka Hlávkas” for the talented young researcher
- 2020** Ilona Müllerová won the Milada Paulová Award for electrical engineering
- 2020** Pavel Zemánek won the Academic Award – Praemium Academiae, the most important and prestigious scientific award in the Czech Republic.
- 2020** Tomáš Králík, Jiří Frolec, Pavel Hanzelka, Věra Musilová, Aleš Srnka and Josef Jelínek won The Best Paper of 2019 Award. The award was given by 3 main editors of Cryogenics journal and Elsevier publishing house.
- 2019** Ilona Müllerová was awarded The František Křižík Honorary Medal for Merit in the Technical Sciences and for the Implementation of Results of Scientific Research
- 2019** Radovan Smíšek was awarded The Josef Hlávka Award
- 2018** Radovan Smíšek won in the competition “Left Bundle Branch Block Initiative” organized by International Soc. for Computerized Electrocardiology
- 2017** Josef Halánek was awarded The František Křižík Honorary Medal for Merit in the Technical Sciences and for the Implementation of Results of Scientific Research
- 2017** ISI, FNUSA-ICRC and University of Rochester team led by Filip Plešinger was awarded the Clinical Needs Translational Award
- 2017** Tomáš Pikálek and his supervisor Zdeněk Buchta were awarded the Werner von Siemens Award 2016 for “The best diploma thesis”
- 2017** Radim Skoupý was awarded the Thermo Fisher – Czechoslovak Microscopy Society Fellowship for young researchers
- 2016** The team of Vilém Neděla was awarded the Wabunshisyo Award by the Japanese Society of Microscopy

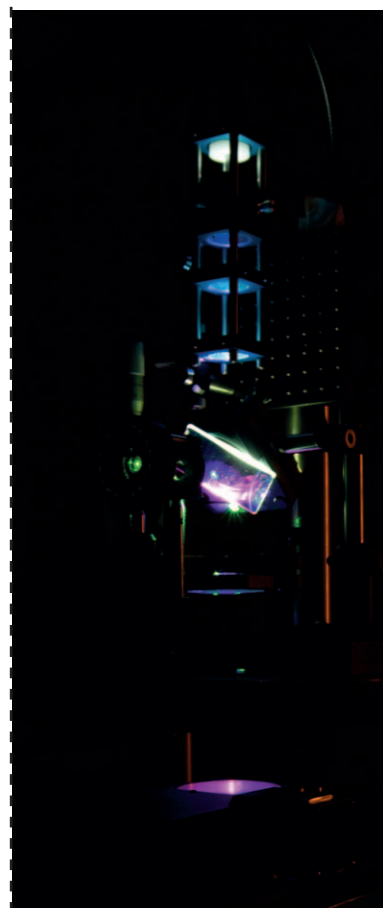

Experimental realization of an optical tractor beam.

E-beam writer: data preparation testing pattern.

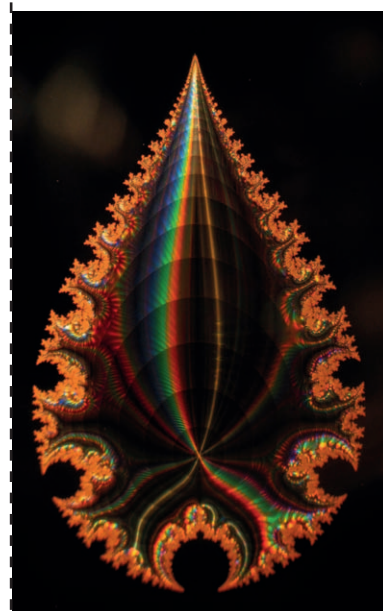

CURRENTLY RUNNING LARGE PROJECTS

- 2021–2025** *D*Eep brain photonic tools for cELL-type sPEcific taRgeting of neural diseases. H. Uhlířová, supported by H2020
- 2021–2024** TSCAC Two-species composite atomic clocks. O. Číp, supported by EURAMET
- 2021–2023** Technology of production and scanning of a machine-readable element of the highest level of security. M. Horáček, supported by the Ministry of Industry and Trade of the Czech Republic (MIC), European Regional Development Fund (ERDF)
- 2021–2023** Non-Oberbeck-Boussinesq effects in turbulent convection in cryogenic helium at high Rayleigh numbers. M. Macek, international project supported by the Czech Science Foundation
- 2020–2022** Clock Network Services – Design Study. O. Číp, supported by H2020
- 2020–2022** Technology for advanced optics and its industrial application. M. Šerý, supported by MIC
- 2020–2022** National Infrastructure for Biological and Medical Imaging. Z. Starčuk, supported by the Ministry of Education Youth and Sports of the Czech Republic (MEYS)
- 2019–2022** IINSPIRE-MED Integrating Magnetic Resonance Spectroscopy and Multimodal Imaging for Research and Education in MEDicine. Z. Starčuk, supported by H2020-ITN
- 2019–2022** Artificial Intelligence in Autonomous ECG Classification for On-line Telemedicine Platform. F. Plešinger, supported by the National Centres of Competence program of the Technology Agency of the Czech Republic (TACR)
- 2019–2022** Super-Pixels: Redefining the way we sense the world. S. Simpson, supported by H2020-FET Open
- 2019–2022** 18SIB06 TiFOON - Advanced time/frequency comparison and dissemination through optical telecommunication networks. O. Číp, supported by EURAMET
- 2019–2022** High-tech cooling sample holder with integrated detection of electrons and control software for optimization of the thermodynamic conditions in the ESEM specimen chamber. V. Neděla, supported by MIC
- 2019–2022** Interdisciplinary Collaboration in Metrology with Cold Quantum Objects and Fibre Networks. O. Číp, supported by MEYS, ERDF

Experimental arrangement of an ion trap for calcium ions oriented to the development of ultrastable laser optical frequency standard.

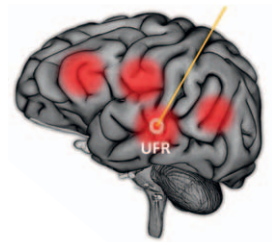
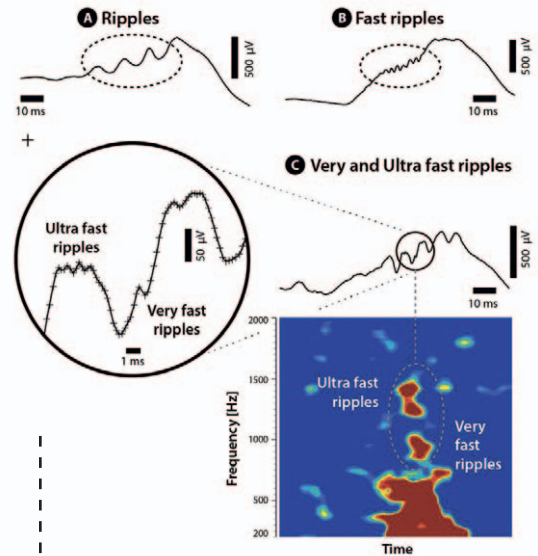
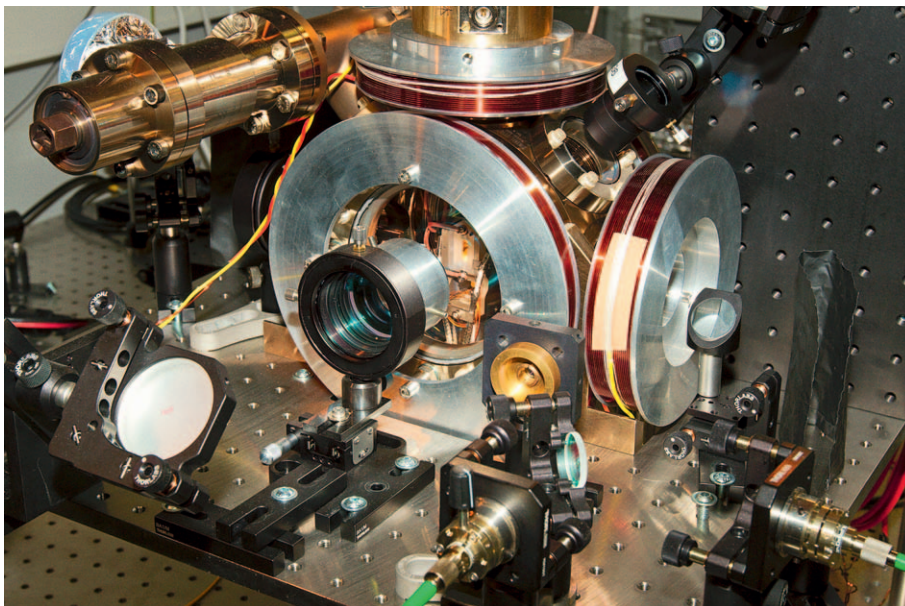

Ultra-fast ripples (UFR) in the epileptic brain show oscillation above 1000 Hz. UFRs occur only in the pathological region that is the origin of an epileptic seizure

Formation of brine “fingers” during slow evaporation of water from a frost flower. The individual fingers bending and flapping around are highlighted in circles. Imaged with the Environmental Scanning Electron Microscope (ESEM) AQUASEM II.

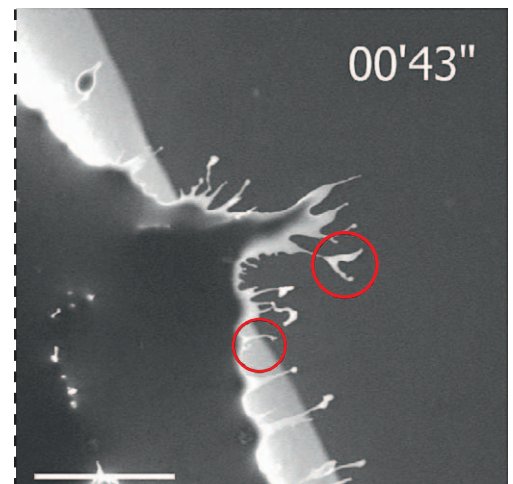

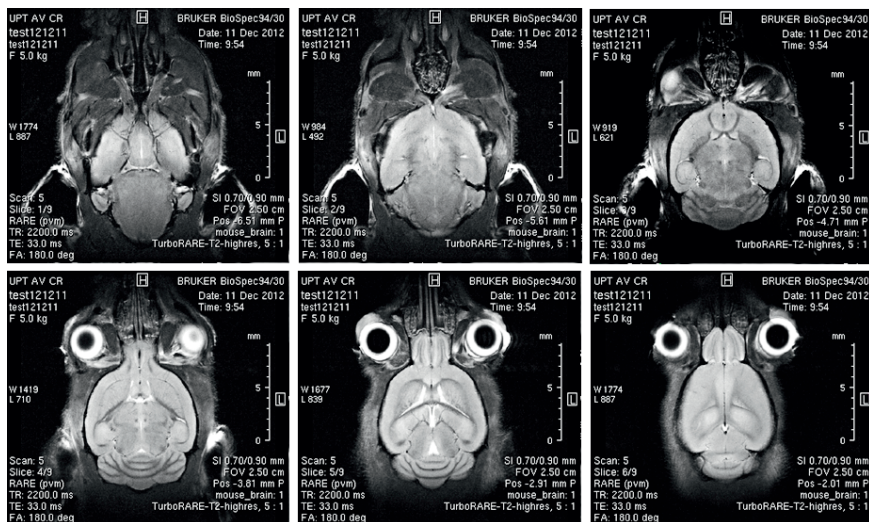

Anatomical image of a mouse brain obtained by magnetic resonance imaging.

2018–2022 Centre of Electron and Photonic Optics. I. Müllerová, supported by the National Centres of Competence program of the Technology Agency of the Czech Republic (TACR)

2017–2022 Holographic Endoscopy for *in vivo* Applications. T. Čižmár, supported by MEYS, ERDF

RECENT IMPORTANT ACHIEVEMENTS

- 2022** US Patent 11,517,243 B2 - UHF-ECG electrocardiographic method (P. Jurák et al., ISI Brno and partners)
- 2022** First observation of thermal waves and heat transfer efficiency enhancement in harmonically modulated thermal convection in a turbulent fluid layer (P. Urban)
- 2022** Diffractive beam splitter with large number of orders with high precision of angular distribution for high-power lasers application (V. Kolařík)
- 2021** Novel three-dimensional imaging of macroscopic objects using holographic endoscope based on multimode optical fiber (T. Čižmár)
- 2021** Demonstration of a novel microscopic method combining environmental scanning electron microscopy with total internal reflection fluorescence microscopy (V. Neděla)
- 2020** Discovering novel titania and carbon-based nanostructured materials that can catalyze electrochemical reduction reactions – US patent application (E. Materna Mikmeková)
- 2020** VDI (Ventricular Dyssynchrony Imaging) technology for cardiac pacing optimization, The Czech Business Project of 2020, Ministry of Industry and Trade (P. Jurák)
- 2020** Demonstration of the ability of Raman optical tweezers to detect bacteriophages attacking a host bacterial cell virtually in real time (O. Samek)
- 2019** The use of alternative polymer graphite for the production of STM probes as a replacement for tungsten and platinum-iridium (A. Knápek)
- 2019** Demonstration of strong effect of superconducting transition in radiating thin layers of niobium nitride on heat transport by electromagnetic near field (V. Musilová)
- 2019** Publication of an unique database of thermal emissivities and absorptivities covering various materials and wide range of cryogenic temperatures
- 2019** Handheld detector of atrial fibrillation (F. Plešinger)
- 2019** Localization of epileptic areas in deep brain structures (P. Jurák)
- 2019** Demonstration of coherent anti-Stokes Raman spectroscopy through multimode optical fibers for fiber-based chemical imaging (T. Čižmár)

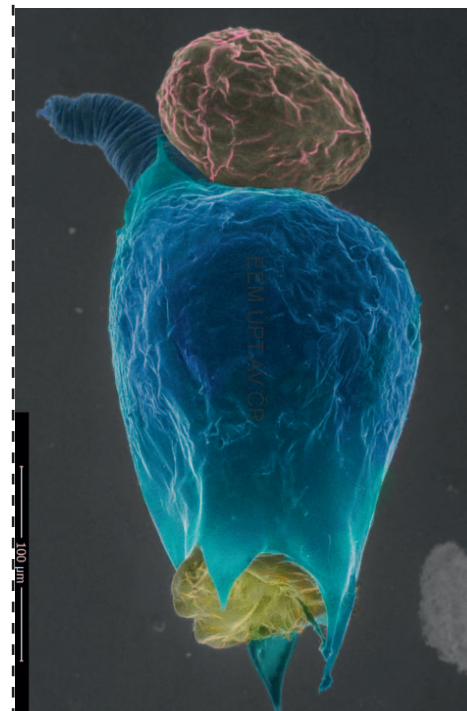

The world's first image of planktonic microorganism *Brachionus calyciflorus* recorded using low-temperature method for ESEM and a new ionisation detector of secondary electrons. The image was colored additionally.

Structure of a mesoporous silica-based nanocomposite carrying catalytic gold nanoparticles, imaged by means of our method using low-energy electrons (top) and with a standard scanning electron microscope (bottom).

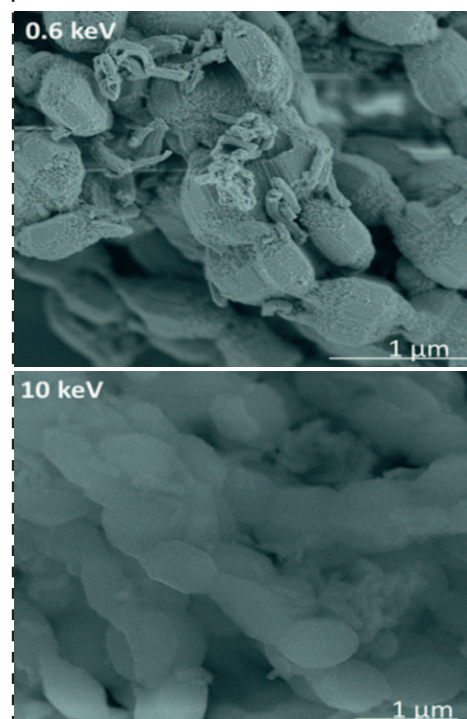

- 2019** Localization of nanodiamonds inside cells (V. Krzyžánek)
- 2018** Demonstration of non-classicity of light emitted from a large number of atoms that were laser-cooled to the absolute zero as a key step towards scalable secure quantum communications (O. Číp)
- 2018** Three-dimensional holographic optical manipulation through a high-numerical-aperture soft-glass multimode fiber (T. Čížmár)
- 2018** A comprehensive methodology covering automatic patient identification for cardiac resynchronization therapy (P. Jurák)
- 2018** Demonstration of mechanical effect of optical spin force on a vacuum levitating microobject (O. Brzobohatý)
- 2017** Demonstration of ultra-high frequency oscillations in the brain helping precise localization of the epileptic foci (P. Jurák)
- 2017** Demonstration of a novel method of transport of many microobjects by two-dimensional optical „ratchet“ (P. Zemánek)
- 2017** Proof that the „frost flowers“ do not contribute to the damage to Earth’s ozone layer by the formation of aerosols (V. Neděla)
- 2017** Demonstration of a fast and precise methodology that employs machine learning algorithms to identify 277 bacterial *Staphylococcus* strains by means of Raman microspectroscopy (O. Samek)
- 2017** Developed technology for manufacturing diffractive optical variable imaging device (DOVID) based on phyllotactic spiral arrangements (V. Kolařík)
- 2017** Experimental verification of the theoretical model for heat transfer by the near field affected by the superconducting transition (A. Srnka)

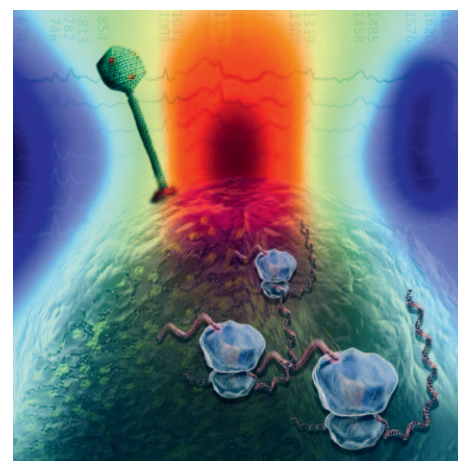

Schematic illustration of a bacteriophage attacking a bacterial cell and the real-time monitoring of the process of infection by Raman tweezers.

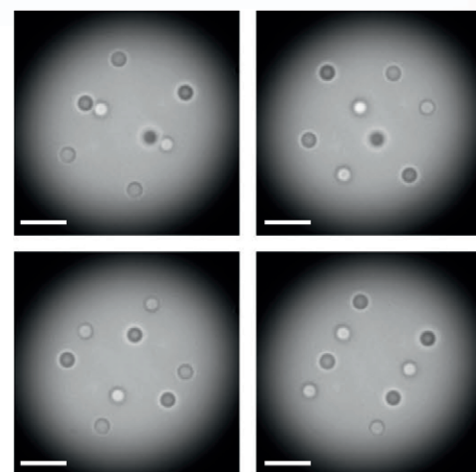
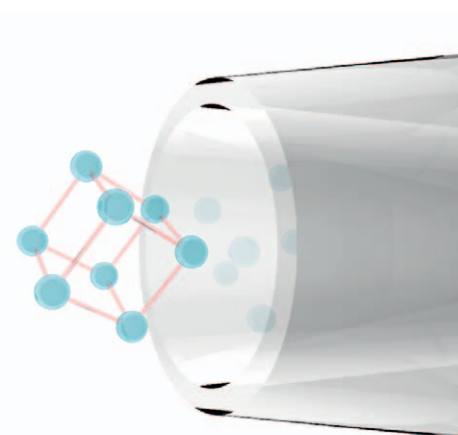

Schematic view of eight microparticles optically trapped near the tip of an optical fiber (top). Eight particles as shown above forming a rotating 3D cube (bottom). Scale bar 10 micrometers.

RECENT HIGH-IMPACT PUBLICATIONS

- P. Urban, P. Hanzelka, T. Králík, V. Musilová, L. Skrbek: *Thermal Waves and Heat Transfer Efficiency Enhancement in Harmonically Modulated Turbulent Thermal Convection*. *Physical Review Letters* **128**, 134502 (2022)
- V. Schanilec, O. Brunn, M. Horacek, S. Kratky, P. Meluzin, T. Sikola, B. Canals, N. Rougemaille: *Approaching the Topological Low-Energy Physics of the F Model in a Two-Dimensional Magnetic Lattice*. *Physical Review Letter* **129**, 027202, 2022
- M.M. Allaham, R.G. Forbes, A. Knápek, D. Sobola, D. Burda, P. Sedlak, M.S. Mousa: *Interpretation of field emission current–voltage data: Background theory and detailed simulation testing of a user-friendly webtool*. *Materials Today Communications* **31**, 103654, 2022
- D. Stellinga, D. B. Phillips, S. P. Mekhail, A. Selyem, S. Turtaev, T. Čížmár, M. J. Padgett: *Time-of-flight 3D imaging through multimode optical fibers*. *Science* **374**, 1395–1399, 2021
- S. Li, S.A.R. Horsley, T. Tyc, T. Čížmár, D.B. Phillips: *Memory effect assisted imaging through multimode optical fibres*. *Nature Communications* **12**, 3751, 2021
- V. Svak, J. Flajšmanová, L. Chvátal, M. Šiler, A. Jonáš, J. Ježek, S. H. Simpson, P. Zemánek, O. Brzobohatý: *Stochastic dynamics of optically bound matter levitated in vacuum*. *Optica* **8**, 220–229, 2021
- A. Cifuentes, T. Pikálek, P. Ondráčková, R. Amezcua-Correa, J. E. Antonio-Lopez, T. Čížmár, J. Trägårdh: *Polarization-resolved second-harmonic generation imaging through a multimode fiber*. *Optica* **8**, 1065–1074, 2021
- A. Jonáš, Z. Pilát, J. Ježek, S. Bernatová, P. Jedlička, M. Aas, A. Kiraz, P. Zemánek: *Optically transportable optofluidic microlasers with liquid crystal cavities tuned by the electric field*. *ACS Applied Materials & Interfaces* **13**, 50657–50667, 2021
- K. Curila, P. Jurák, M. Jastrzebski, F. Prinzen, P. Waldauf, J. Halánek, K. Vernooy, R. Smíšek, J. Karch, F. Plesinger, P. Moskal, M. Susánková, L. Znojilová, L. Heckman, I. Viscor, V. Vondra, P. Leinveber, P. Osmančík: *Left bundle branch pacing compared to left ventricular septal myocardial pacing increases interventricular dyssynchrony but accelerates left ventricular lateral wall depolarization*. *Heart Rhythm* **18**(8), 1281–1289, 2021

- Y. Arita, S.H. Simpson, P. Zemánek, K. Dholakia: *Coherent oscillations of a levitated birefringent microsphere in vacuum driven by nonconservative rotation-translation coupling*. *Science Advances* **6**, eaaz9858, 2020
- L. Peter-Derex, P. Klimeš, V. Latreille, S. Bouhadoun, F. Dubeau, B. Fauscher: *Sleep disruption in epilepsy: Ictal and interictal epileptic activity matter*. *Annals of Neurology* **88**, 907–920, 2020
- T. Zhang, J. Low, J. Yu, A. M. Tyryshkin, E. Mikmeková, T. A. Asefa: *Blinking mesoporous TiO(2-x) composed of nanosized anatase with unusually long-lived trapped charge carriers*. *Angewandte Chemie* **59**, 15000–15007, 2020
- P. Zemánek, G. Volpe, A. Jonáš, O. Brzobohatý: *Perspective on light-induced transport of particles: from optical forces to phoretic motion*. *Advances in Optics and Photonics* **11**, 577–678, 2019
- K. J. Abrams, F. Mika, S. Krátký, Z. Pokorná, I. Konvalina et al.: *Making sense of complex carbon and metal/carbon systems by secondary electron hyperspectral imaging*. *Advanced Science* **6**, 1900719, 2019
- M. G. Donato, O. Brzobohatý, S. H. Simpson, A. Irrera, A. A. Leonardi, M. J. Lo Faro, V. Svak, O. M. Maragò, P. Zemánek: *Optical trapping, optical binding, and rotational dynamics of silicon nanowires in counter-propagating beams*. *Nano Letters* **19**, 342–352, 2019
- P. Nejedlý, J. Cimbálník, P. Klimeš, F. Plešinger, J. Halánek, V. Křemen, I. Viščor et al.: *Intracerebral EEG artifact identification using convolutional neural networks*. *Neuroinformatics* **17**, 225–234, 2019
- T. Obšil, A. Lešundák, M. T. Pham, G. Araneda, M. Čížek, O. Číp, R. Filip, L. Slodička: *Multipath interference from large trapped ion chains*. *New Journal of Physics* **21**, 093039, 2019
- E. Dražanová, J. Rudá-Kučerová, L. Krátká, T. Štark, M. Kuchař, M. Maryška, F. Drago, S. Starčuk jr., V. Mical: *Different effects of prenatal MAM vs. perinatal THC exposure on regional cerebral blood perfusion detected by Arterial Spin Labelling MRI in rats*. *Scientific Reports* **9**, 6062, 2019
- L. Vetráková, V. Neděla, J. Runštuk, D. Heger: *The morphology of ice and liquid brine in an environmental scanning electron microscope: a study of the freezing methods*. *Cryosphere* **13**, 2385–2405, 2019
- A. Knápek, D. Sobola, D. Burda, A. Daňhel, M. Mousa, V. Kolařík: *Polymer graphite pencil lead as a cheap alternative for classic conductive SPM probes*. *Nanomaterials* **9**, 1756, 2019
- I. Leite, S. Turtaev, X. Jiang, M. Šiler, A. Cuschieri, P. Russell, T. Čizmar: *Three-dimensional holographic optical manipulation through a high-numerical-aperture soft-glass multimode fibre*. *Nature Photonics* **12**, 33–39, 2018
- V. Svak, O. Brzobohatý, M. Šiler, P. Jákl, J. Kaňka, P. Zemánek, S. H. Simpson: *Transverse spin forces and non-equilibrium particle dynamics in a circularly polarized vacuum optical trap*. *Nature Communications* **9**, 5453, 2018
- S. Turtaev, I. Leite, T. Altwegg-Boussac, J. Pakan, N. Rochefort, T. Čizmar: *High-fidelity multimode fibre-based endoscopy for deep brain in vivo imaging*. *Light: Science & Applications* **7**, 92, 2018
- J. Damková, L. Chvátal, J. Ježek, J. Oulehla, O. Brzobohatý, P. Zemánek: *Enhancement of the 'tractor-beam' pulling force on an optically bound structure*. *Light: Science & Applications* **7**, 17135, 2018
- D. Boonzajer Flaes, J. Stopka, S. Turtaev, J. De Boer, T. Tyc, T. Čizmar: *Robustness of light-transport processes to bending deformations in graded-index multimode waveguides*. *Physical Review Letters* **120**, 233901, 2018
- M. Šiler, L. Ornigotti, O. Brzobohatý, P. Jákl, A. Ryabov, V. Holubec, P. Zemánek, R. Filip: *Diffusing up the hill: Dynamics and equipartition in highly unstable systems*. *Physical Review Letters* **121**, 230601, 2018
- P. Obšil, L. Lachman, M.-T. Pham, A. Lešundák, V. Hucl, M. Čížek, J. Hrabina, O. Číp, L. Slodička, R. Filip: *Nonclassical light from large ensembles of trapped ions*. *Physical Review Letters* **120**, 253602, 2018

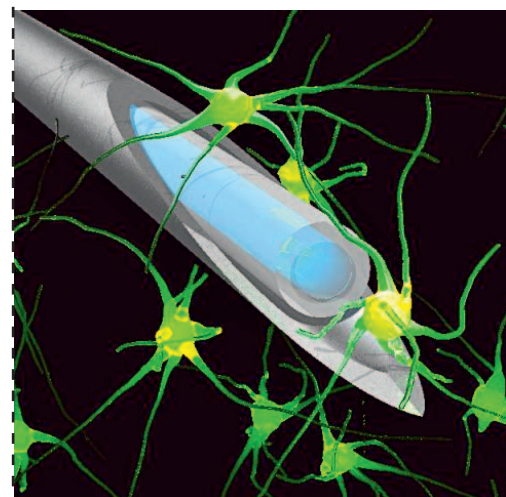

An artist's impression of endoscopic imaging of neurons in the brain using an optical fiber inserted in a hypodermic needle.

ISI-built apparatus for measurement of thermal conductivity of insulating materials for cryogenics under different mechanical loads

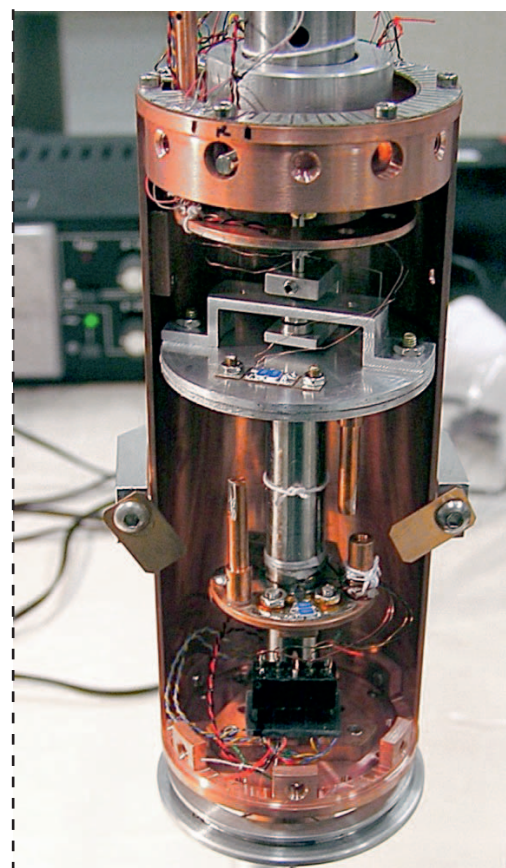

RECENT PATENTS AND UTILITY MODELS

- A. Knápek, L. Dupák, M. Matějka: *Field emission microscope for probe tip analysis*. ISI CAS, v.v.i., 2022. Utility model number: 36068
- M. Horáček, J. Sadílek, M. Matějka, A. Knápek, S. Krátký, P. Meluzín, J. Kopal: *Planar optical element*. ISI CAS, v.v.i., 2022. Utility model number: 36445
- J. Hrabina, M. Jelínek, B. Mikel, M. Holá, O. Číp, J. Lazar: *Optical frequency reference unit for linear absorption spectroscopy containing a hollow-core microstructured optical fibre*. ISI CAS, v.v.i., 2019. Utility model number: 33481
- P. Jurák, P. Andrla, et al.: *Device for surface mapping of electrical potential caused by cardiac activity with a set of electrodes for placement in orthogonal coordinates*. ISI CAS, v.v.i. & partners, 2019. Utility model number: 33326
- E. Mikmeková, L. Frank, I. Müllerová, J. Sýkora, P. Klein, et al.: *Electron microscope sample holder*. ISI CAS, v.v.i., 2019. Utility model number: 33509
- L. Mrňa, P. Jedlička, H. Šebestová, P. Horník: *Devices for monitoring continuous laser beam welding and devices for continuous laser beam welding*. ISI CAS, v.v.i., 2019. Utility model number: 33227

MASTERED TECHNOLOGIES

- Electrochemical formation of sharp tips and electrical characterization of field emission cathodes (A. Knápek)
- Grayscale e-beam lithography for diffractive optical elements application. (V. Kolařík)
- Ventricular Dyssynchrony Imaging (P. Jurák)
- Deposition of optical thin films by electron beam evaporation (P. Pokorný)
- Deposition of systems of thin films for extreme ultraviolet and RTG optical components by magnetron sputtering (T. Fořt)
- Manufacturing of nanostructures by electron beam writing and reactive ion etching (V. Kolařík, M. Šerý)
- Soft-lithography for microfluidic chips (J. Ježek)
- Two-photon polymerization (P. Ják)
- Liquefaction of helium (A. Srnka)
- Electron-beam welding of parts from different metals (M. Zobač)
- Laser-beam cutting and welding (L. Mrňa)
- Electron microscopy and microanalysis (F. Míka)
- Production of cuvettes filled with ultrapure gases for precise spectroscopy and metrology (J. Lazar)
- Magnetic resonance tomographic imaging (Z. Starčuk)
- High-voltage electronics (M. Zobač)
- Emissivity, absorptivity or thermal conductivity measurements in the range from 10 K to 300 K on materials for cryogenic and space applications (A. Srnka)
- Optical micromanipulation with various types of microobjects and microorganisms (O. Brzobohatý, O. Samek)
- Contactless characterization of living microorganisms by Raman microspectroscopy (O. Samek)
- Optical imaging and spectroscopy through multimode optical fibers (T. Čížmár)
- On-demand design and construction of scientific instruments or their parts

HISTORY OF ISI

- 2009** Establishment of the Applied Laboratories of ISI (ALISI)
- 2007** ISI transformed to the Public Research Body (v.v.i.)

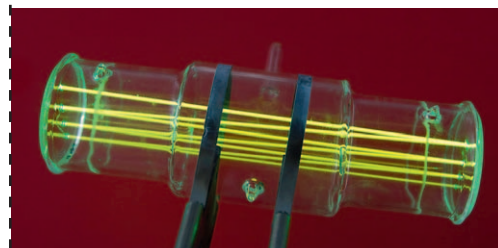

An absorption cell filled with iodine gas, equipped with internal mirrors, designed for applications in ultraprecise nanometrology. Yellow fluorescent paths visualize multiple passages of a laser beam.

Entrance to the Applied Laboratories of ISI (ALISI).



- 1993** Academy of Sciences of the Czech Republic established as the Czech successor of the former Czechoslovak Academy of Sciences
- 1961–1990** Armin Delong served as the director of ISI
- 1960** Laboratory of Electron Optics and Laboratory of Industrial Electronics joined ISI in its new building
- 1957** Development Workshop of the Czechoslovak Academy of Sciences (DWCAS) renamed the Institute of Scientific Instruments (ISI)
- 1953** Establishment of DWCAS

REMARKABLE ACHIEVEMENTS IN THE PAST

- 2013** Experimental demonstration of an optical tractor beam and its applications in optical sorting and binding
- 2012** Identification of the local crystallographic orientation from the reflectance of very slow electrons
- 2012** Novel methodology and instrumentation for contactless calibration of gauge blocks
- 2011** Experimental determination of heat transfer efficiency in natural turbulent convection at high Rayleigh numbers in cold helium gas
- 2009** Novel sample nanopositioning system for nanometrologic AFM using interferometric measurement in all six degrees of freedom (axial motions and angle deviations)
- 2009** Original approach for the calculation of aberration coefficients using the results of accurate electron ray tracing
- 2008** Novel laser nanocomparator for the calibration of length sensors, in cooperation with the Mesing company and the Czech Metrology Institute
- 2007** Prototype of an original electron-beam welding machine for Focus GmbH
- 2005** The world's first concept of an optical conveyor belt was presented and demonstrated, in cooperation with University of St. Andrews (UK)
- 2004** Development of a new experimental apparatus for the measurement of low-temperature radiative properties of materials used in cryogenics
- 2004** Development of various nanocomposite coatings used as hard solid lubricants, in cooperation with Masaryk University, Aarhus University Denmark, University of West Bohemia in Pilsen, Czech Technical University in Prague, Brno University of Technology, Euroconsult and the Institute of Electrical Engineering of the Slovak Academy of Sciences
- 2004** New ESEM AQUASEM II
- 2004** New method of length measurement with sub-nanometer resolution using an optical cavity
- 2000** New type of scanning electron microscope using very slow electrons
- 1990** The first Czechoslovak ESEM, AQUASEM I
- 1987** The first Czechoslovak ultra-low loss cryostat for nuclear magnetic resonance (NMR) magnets
- 1987** Original setup of iodine-stabilized HeNe laser for metrological purposes
- 1985** The first electron beam lithograph in the Eastern Block developed at ISI and commercialized by the TESLA company
- 1978** The first Czechoslovak Fourier NMR spectrometer
- 1976** Scanning electron microscope with a cold-field emission gun
- 1972** The first Czechoslovak superconducting magnet for NMR
- 1971** Gold medal at the International Brno Fair for laser interferometric system LA3000 developed at ISI and produced by the Metra Blansko company
- 1966** NMR spectrometers commercially produced by the TESLA company
- 1965** The first Czechoslovak ruby laser
- 1963** The first Czechoslovak HeNe laser
- 1960** The first Czechoslovak NMR spectrometer (30 MHz)
- 1959** Transmission electron microscope (TEM) with resolution below 1 nm
- 1958** Gold medal at the Brussels World's Fair EXPO58 for the table-top TEM
- 1954** The world's first table-top TEM developed at the Laboratory of Electron Optics (LEO)
- 1951** Tesla BS 241 – the first Czechoslovak commercial TEM developed at LEO and TESLA company
- 1950** The first Czechoslovak TEM developed at LEO

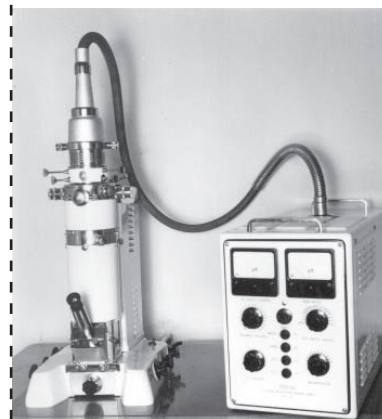

The first table-top transmission electron microscope developed at the predecessor of ISI in 1954 and produced by TESLA Brno.

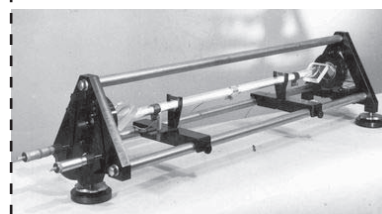

The first HeNe laser built in Czechoslovakia, operating at the wavelength of 633 nm.

*ISI in 60 years and 4 seasons
Diffractive optically variable image device based on a patented approach taking advantage of spiral cross grating arrangements (quasiperiodic phyllotaxy model). The single device is captured at four different lighting conditions demonstrating its outstanding potential of image variability.*



THEMATIC RESEARCH FOCUS

Research area

- Electron and ion optics
- Electron optical design and simulations
- Design of detection systems in electron and ion optical instruments
- Simulations of ion and electron sources

Excellence

- Electron and ion optical simulation of nonstandard systems and aberration corrected systems

Mission

- Development of new computations methods in electron and ion optical systems
- Simulation and design of nonstandard electron and ion optical systems

**Institute of Scientific Instruments
 of the CAS v.v.i.**

The Czech Academy of Sciences
 Královopolská 147, 612 64 Brno,
 Czech Republic
 www.isibrno.cz

Head: Dr. Tomáš Radlička
Phone: +420 541 514 294
E-mail: TomasRadlicka@isibrno.cz

3D field of a stigmator

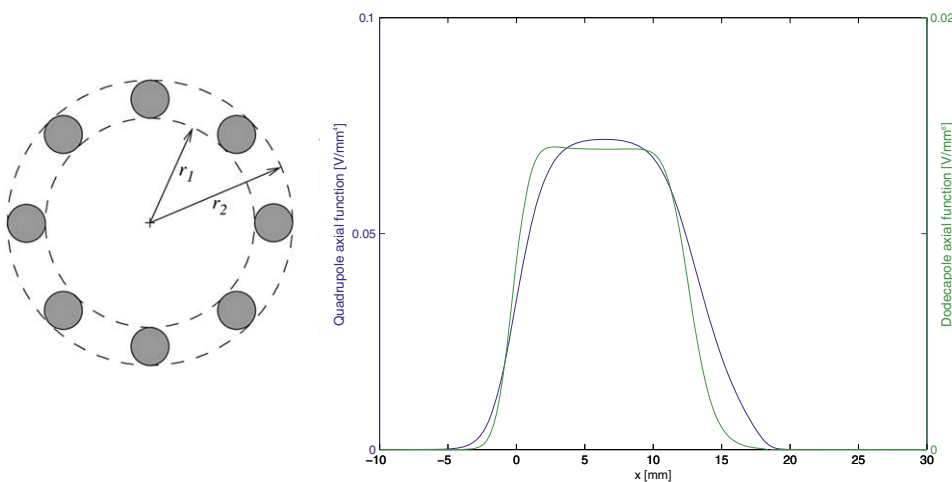

Slice: Electric potential (V) Isosurface: Electric potential (V)
 Slice: Electric potential (V)

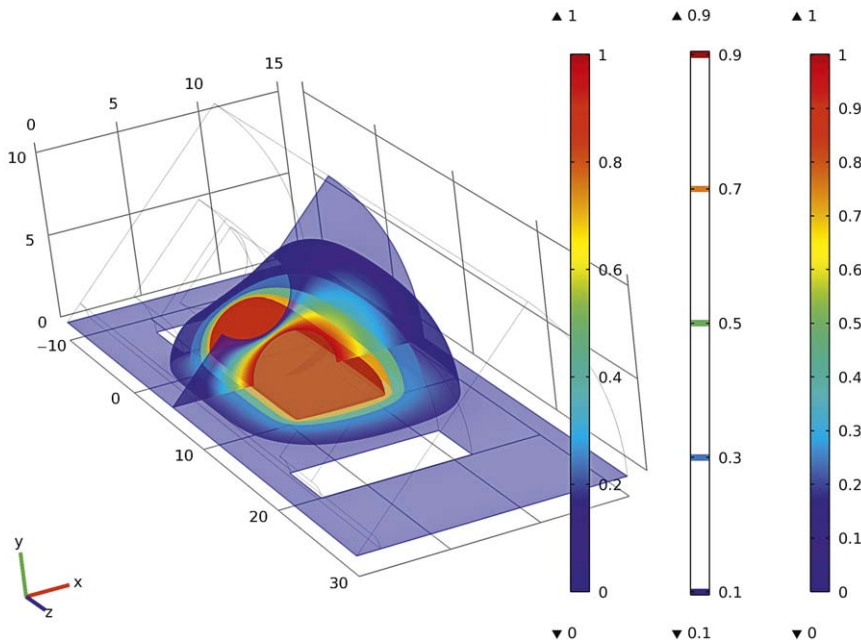

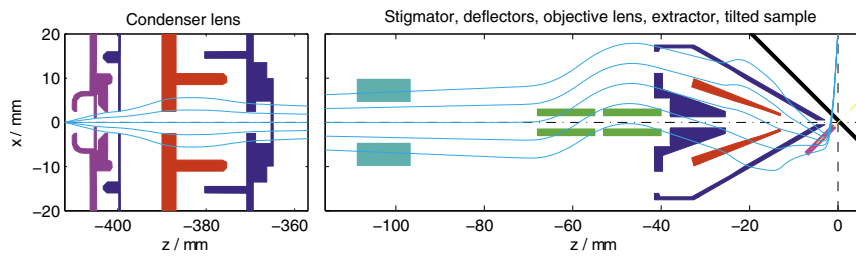

UP-TO-DATE ACTIVITIES

Research orientation

- Calculations of high order aberrations by regression or by differential algebraic method
- Current density profiles with and without diffraction
- Space charge and stochastic Coulomb interactions
- Simulation of interaction of electron with gas molecules

Main capabilities

Basic research

- Exploring the resolution limits of electron and ion optical systems due to aberrations, Coulomb interaction and diffraction
- Simulations of the electron and ion source properties
- Analysis and correction of parasitic aberrations in general optical columns including aberration-corrected systems

Applied research

- Design of electron and ion optical instruments
- Development of software for simulation of non-standard electron and ion optical systems

Sub-fields of group activities

- Electron optics and electron microscopy
- Ion mass spectroscopy and electron spectroscopy (ToF, energy-dispersive)
- Signal electron and X-ray detector optimisation

KEY RESEARCH EQUIPMENT

List of devices

Software for simulation of electron and ion optical systems that has been developed at ISI.

ACHIEVEMENTS

■ Simulation of nonstandard electron and ion optical systems (electron mirror, extraction optics of Time of Flight detectors, Wien Filter with permanent magnets, general 3D optical systems), correctors and misalignment aberrations

- M. Oral, T. Radlička, B. Lencová: "Effect of sample tilt on Photo Emission Electron Microscopy resolution", *Ultramicroscopy* **119**, 45–50, 2012
- M. Oral, B. Lencová: "Correction of sample tilt in FIB instruments", *Nucl Instrum Meth A*. **645**, 130–135, 2011

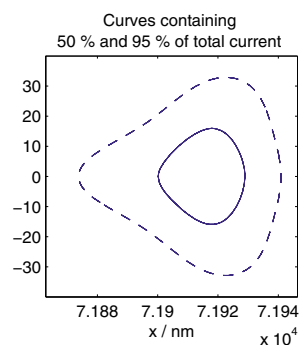
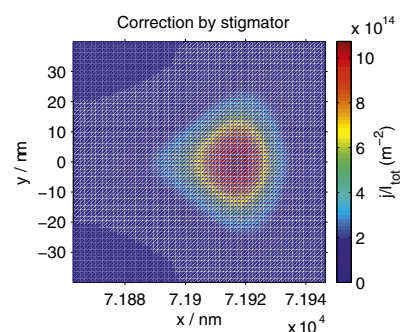
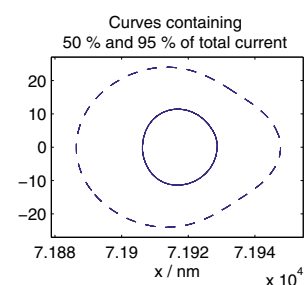
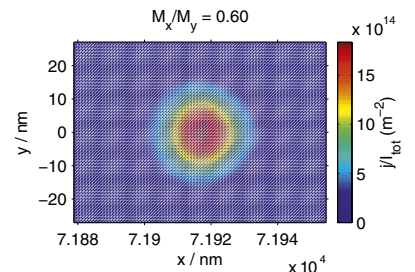
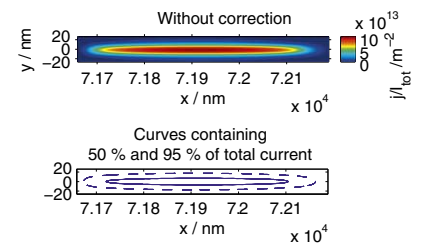

Corrections of sample tilt SIMS

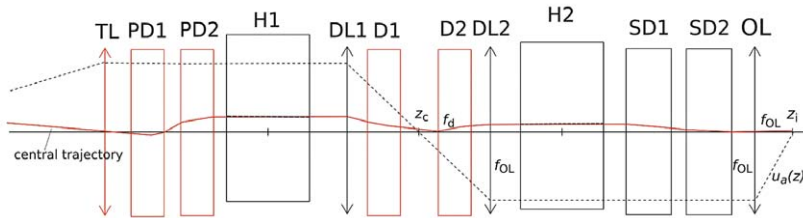

Doublet lenses ellipticity: $1\mu\text{m}$, $(0.57+0.48i)\mu\text{m}$

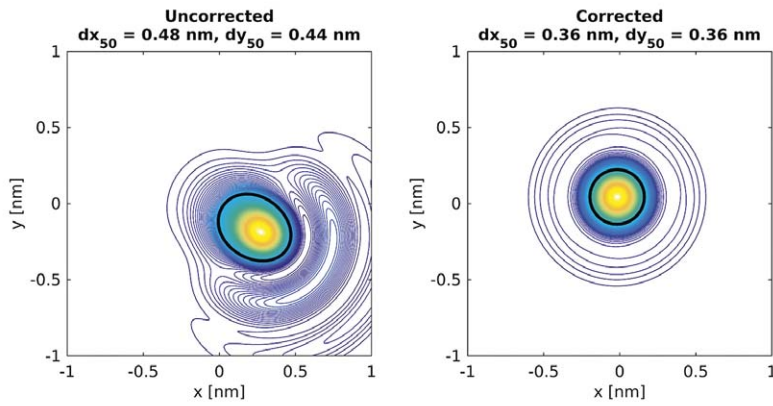

Exploring the resolution limits of low-energy SEM and corrected Transmission SEM including design of correctors and parasitic aberration analysis.

- T. Radlička: "Wave Optical Calculation of Probe Size in Low Energy Scanning Electron Microscope", *Microscopy and Microanalysis* **21**, S4, 212–217, 2015

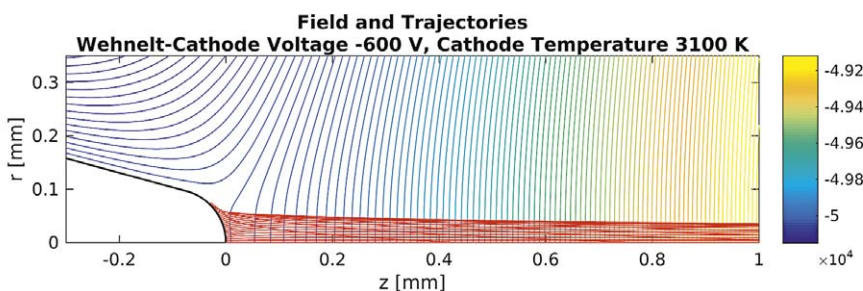
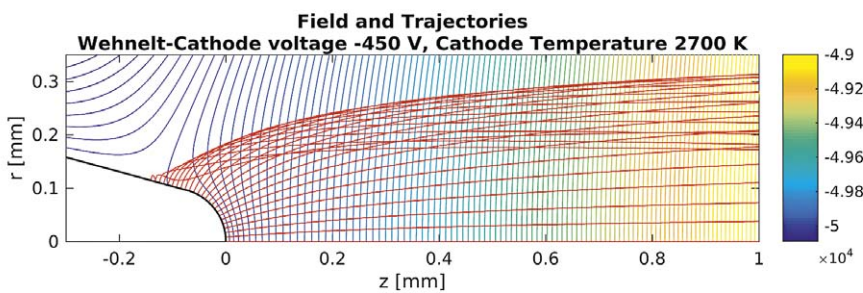
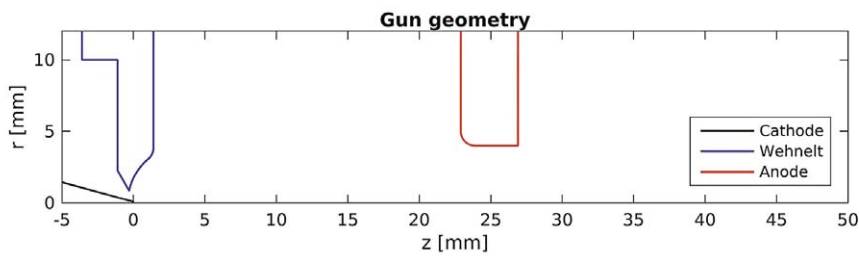

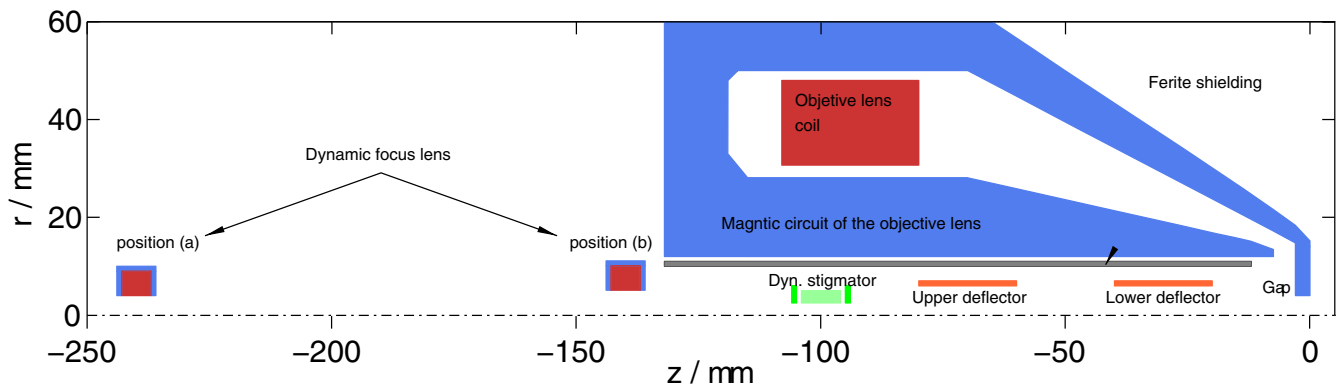

■ Design of low-energy environmental SEM with dynamically corrected deflection systems

- M. Oral, V. Neděla, G. Danillatos: "Dynamic Correction of Higher-Order Deflection Aberrations in the Environmental SEM"; *Microscopy and Microanalysis* **21**, S4, 194–199, 2015

■ Simulation of thermionic electron sources with space-charge-limited emission.

- J. Zelinka, M. Oral, T. Radlička: "Simulation of Space Charge Effects in Electron Optical System Based on the Calculations of Current Density"; *Microscopy and Microanalysis* **21**, S4, 246–251, 2015

Design of a low-energy environmental SEM objective lens with a dynamically corrected deflection system

MAIN COLLABORATING PARTNERS

Collaboration with academic partners

Brno University of Technology (Brno, CZ)
Technische Universität Wien (Vienna, A)

Collaboration with companies

FEI CR (Brno, CZ); now Thermo-Fisher Scientific
Delong Instruments, a.s. (Brno, CZ)
Nion Company, (Kirkland, USA)

EXPECTATIONS

Offers

- Partnership in international projects
- Design of electron and ion optical systems
- Simulation and design of electron and ion sources
- Computationally intensive calculations of acceptance diagrams for description of contrast mechanism including Monte-Carlo simulation of signal electron emission
- Consulting in the field of charge particle optics

Requirements

Collaboration with industrial partners in projects dedicated to charged particle optics.

Collaboration with academic partners on development of custom instruments using charged particles.

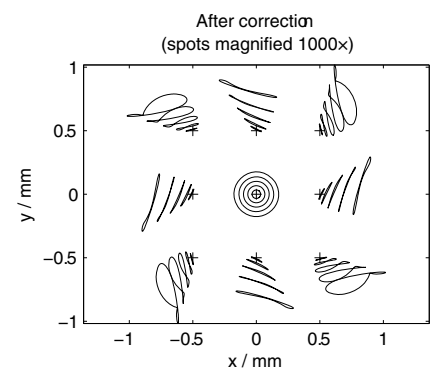
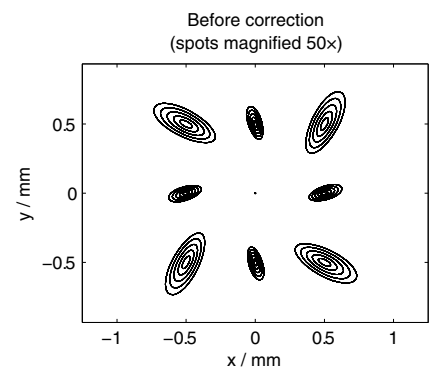

Deflection aberration patterns without and with dynamic corrections

**Institute of Scientific Instruments
of the CAS, v. v. i.**

Czech Academy of Sciences

Královopolská 147, 612 64 Brno,
The Czech Republic
www.lem.isibrno.cz

Head: Dr. Eliška Materna Mikmeková
Phone: +420 541 514 450
E-mail: Eliska.Mikmekova@isibrno.cz

THEMATIC RESEARCH FOCUS

Research area

- Low energy scanning electron microscopy
- Low energy transmission electron microscopy and time-of-flight spectroscopy
- Auger electron spectroscopy and spectromicroscopy
- Surface physics
- Micro- and nanostructure of advanced materials
- Technology and diagnostics of 2D crystals and thin films
- Computer simulations of formation and detection of electron beams

Excellence

Contrast formation at low and very low energies in the scanning electron microscopy and spectroscopy both in the reflection and transmission mode with lateral resolution of units of nm, with an application to the study of advanced materials and biostructures; generation, acquisition and processing of electron micrographs

Mission

Development of advanced methods of scanning electron microscopy and their application in materials and biomedical sciences and technologies

UP-TO-DATE ACTIVITIES

Research orientation

- Methodology for the formation of beams of very slow electrons and their manipulation aimed at the illumination of solid surfaces or free-standing films, including vortex electron beams
- Theory of interaction of slow electrons with matter, generation of signals released under impact of electrons, analysis of information carried by species emitted under electron bombardment, electron crystallography, examination of 2D crystals
- Detection of electrons emitted from surfaces or transmitted through films, including multichannel detection of angular and energy distribution of emitted electrons in SEM and STEM, aiming at ultimate angular, energy and lateral resolution, simulation of signal generation and detection
- Interpretation of scanned electron beam micrographs and Auger electron spectromicrographs
- Quantitative scanning electron microscopy, especially at low energies
- Examination of treatment of solid surfaces with slow electrons
- Questions of the coherence of electron beams

Main capabilities

Basic research

- Interaction of slow electrons with matter
- Reflectivity and transmissivity of slow and very low electrons from/through solids
- Generation of Auger electrons
- Theory of contrast mechanisms in scanning electron microscopy
- Relations between the state of surface and its response to electron bombardment
- Principles of detection of low energy electrons
- 3D distribution of electromagnetic field and motion of charged particles therein

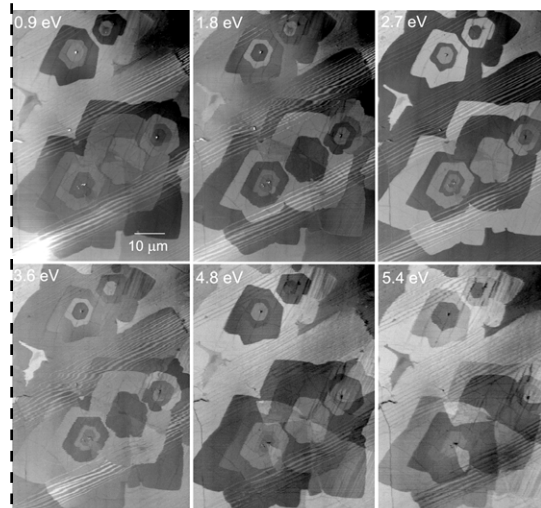

Multilayer graphene deposited by the CVD technique on a Cu foil; variations in brightness of graphene islands originates in fluctuations of their reflectivity and number of reflectivity minima indicates the number of overlapped graphene layers

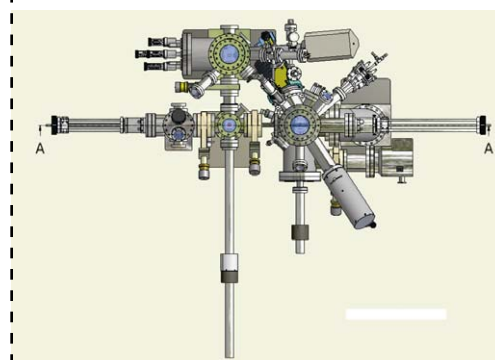

Design of the innovated preparation chambers and air-lock for the ultrahigh vacuum microscope, which is currently assembled

Applied research

- Ultrahigh vacuum scanning low energy electron microscopy
- Analysis of phases in complex materials, e.g. steels
- Visualization of crystal orientation and internal stress
- Analysis of surface coatings and thin films, Auger electron spectromicroscopy
- Analysis of ultrathin tissue sections and free-standing films and 2D crystals
- Simulation of electron trajectories in electron optical elements and systems
- Design of multichannel electron detectors and the time-of-flight velocity analyser

Innovations

- Extension of the scanning electrons microscopy to arbitrarily low energy in reflection and transmission modes
- Electron-beam-induced release of hydrocarbons from solid surfaces
- Counting of graphene layers upon reflection as well as transmission of slow electrons
- Acquisition of high contrast images of tissue sections not treated with any heavy metal species

Subfields of group activities

- Materials science (micro- and nanostructure of materials)
- Life sciences (ultrathin tissue sections, biological crystals)
- Nanotechnologies
- Industry of scientific instrumentation
- Metallurgy
- Industry of polymers, composites, surface coatings, etc.
- Medicine

KEY RESEARCH EQUIPMENT

List of devices

- Ultrahigh vacuum scanning low energy electron microscope of in-house design consisting of the observation and preparation chambers, equipped with in-situ technologies for specimen treatment, namely ion beam cleaning, heating and deposition of thin films, and auxiliary techniques, namely Auger electron spectroscopy, mass spectroscopy of released gases and reflection high-energy electron diffraction from crystals
- Ultrahigh vacuum scanning low energy electron microscope of in-house design equipped with time-of-flight analysis of energies of electrons transmitted through ultrathin films and 2D crystals and two-dimensional position sensitive detection of the angular distributions of reflected electrons
- Attachments for several commercial scanning electron microscopes allowing sample observation with low and very low energy electrons
- Equipment for the preparation of clean, smooth or coated specimens and for the CVD technology grown thin films

ACHIEVEMENTS

■ Study of transmissivity of ultrathin free standing foils at very low energies in scanning electron microscope with a high contrast and a high lateral resolution in the nm scale

- I. Müllerová, M. Hovorka, L. Frank: "A method of imaging ultrathin foils with very low energy electrons"; *Ultramicroscopy* **119**, 78–81, 2012

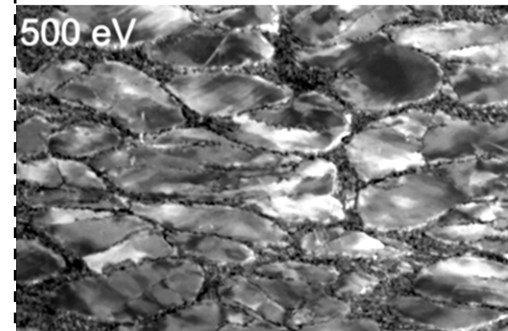
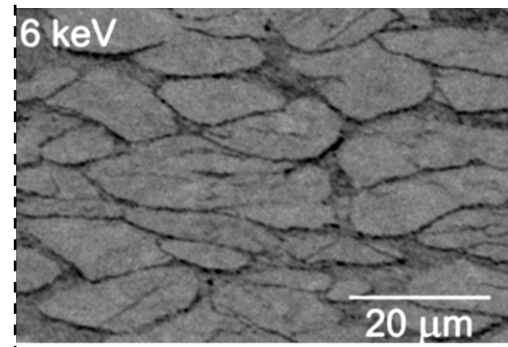

X210Cr12 ledeburitic steel heated to a semisolid state, heavily deformed and cooled; standard micrograph at 6 keV does not visualize the distribution of internal stress that is well shown in the cathode lens mode at 500 eV

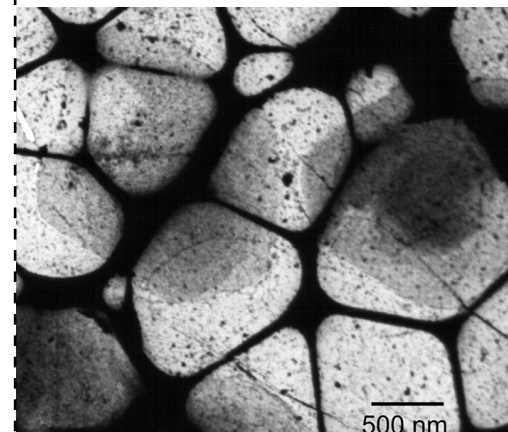

CVD graphene samples deposited on lacey carbon lying on a copper mesh, commercially available sample declared as three- to five-layer graphene; image in transmitted electrons at 220 eV clearly visualizes sites differing by a single carbon atom in thickness

■ **Imaging of graphene multilayers with a high contrast, counting the graphene layers upon reflectivity as well as transmissivity of very slow electrons, identification of the grow mechanism of graphene**

- L. Frank, E. Mikmeková, I. Müllerová, M. Lejeune: "Counting graphene layers with very slow electrons"; *Applied Physics Letters* **106**, 013117:1-5, 2015
- E. Mikmeková, L. Frank, I. Müllerová, B.W. Li, R.S. Ruoff, M. Lejeune: "Study of multi-layered graphene by ultra-low energy SEM/STEM"; *Diamond and Related Materials* **63**, 136-142, 2016

■ **Characterisation of crystal orientation with a high lateral resolution from the reflectivity of electrons at impact energies below 40 eV**

- Z. Pokorná, Š Mikmeková, I. Müllerová, L. Frank: "Characterization of the local crystallinity via reflectance of very slow electrons"; *Appl. Phys. Lett.* **100**, 261602: 1-4, 2012
- A. Knápek, Z. Pokorná: "A method for extraction of crystallography-related information from a data cube of very-low-energy electron micrographs"; *Ultramicroscopy* **148**, 52-56, 2015

■ **Imaging at high contrast and resolution of ultrathin tissue sections not treated with any agents containing heavy metal salts for contrast enhancement**

- L. Frank, J. Nebesářová, M. Vancová, A. Paták, I. Müllerová: "Imaging of tissue sections with very slow electrons"; *Ultramicroscopy* **148**, 146-150, 2015
- J. Nebesářová, P. Hozák, L. Frank, P. Štěpán, M. Vancová: "The Cutting of Ultrathin Sections With the Thickness Less Than 20 nm From Biological Specimens Embedded in Resin Blocks"; *Microscopy Research Technique* **79**, 512-517, 2016

■ **Applications of low energy SEM in nanotechnology**

- I. Müllerová, M. Hovorka, F. Mika, E. Mikmeková, Š. Mikmeková, Z. Pokorná, L. Frank: "Very low energy scanning electron microscopy in nanotechnology"; *International Journal of Nanotechnology* **9**, 695-716, 2012

■ **Development of new highly sensitive method for the determination of crystallographic orientation of grains from maximum anisotropy of reflected electrons**

- Š. Mikmeková, M. Hovorka, I. Müllerová, O. Man, L. Pantělejev, L. Frank: "Grain contrast imaging in UHV SLEEM"; *Materials Trans.* **51**, 292-296, 2010

■ **A method for quantitative measurements of dopant level in semiconductors using optimum primary beam energy**

- L. Frank, I. Müllerová, D. Valdaitsev, A. Gloskovskii, S. Nepijko, H. Elmers, G. Schönhense: "The origin of contrast in the imaging of doped areas in silicon by slow electrons"; *J. Appl. Phys.* **100**, 093712: 1-5, 2006
- I. Müllerová, M.M. El Gomati, L. Frank: "Imaging of the boron doping in silicon using low energy SEM"; *Ultramicroscopy* **93**, 223-243, 2002

■ **An overview about the development of the scanning low energy electron microscopy**

- I. Müllerová, L. Frank: "Scanning low energy electron microscopy"; *Advances in imaging and electron physics* **128**, 309-443, 2003

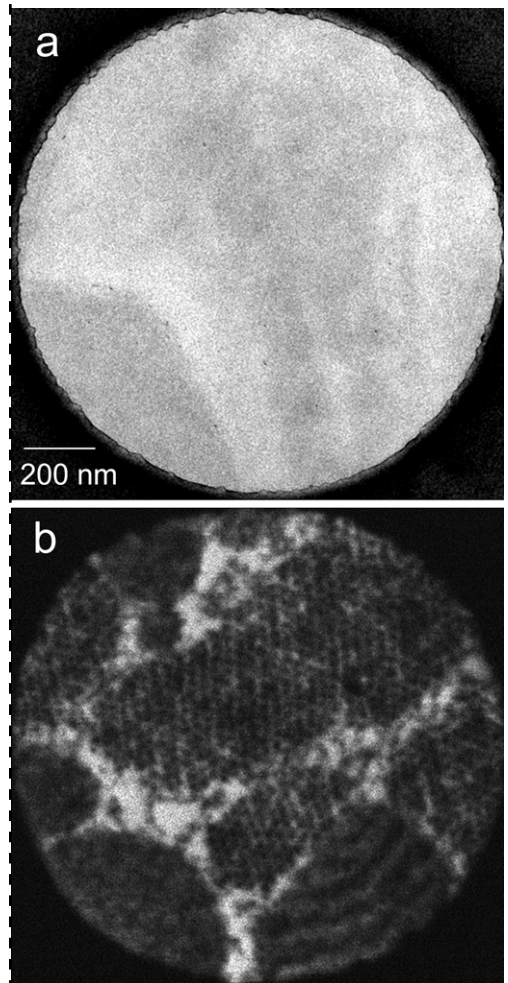

Section of mouse heart muscle, not fixed with osmium tetroxide and not stained; (a) 10 nm section imaged by conventional TEM at 80 keV, (b) micrograph taken at 500 eV by means of the cathode lens, showing drastically enhanced contrast

Identification of crystal grains in Al on the basis of reflectivity of very slow electrons; EBSD map (a), micrographs acquired using the cathode lens (b and c), and energy dependence of the reflectivity of selected grains (d)

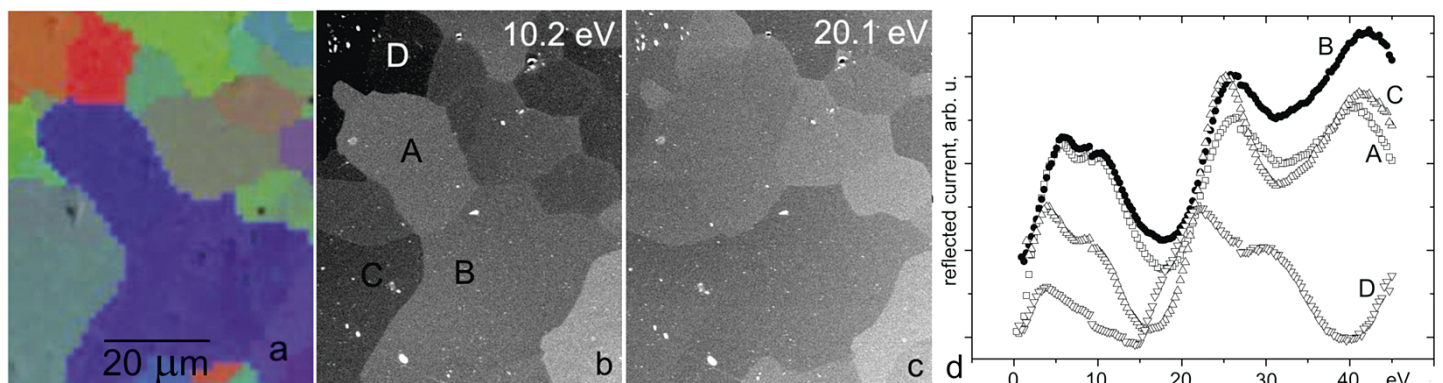

■ An automatic method for non-charging imaging of uncoated and nonconductive specimens by fine-tuning the primary beam energy

- L. Frank, M. Zdražil, I. Müllerová: "Scanning electron microscopy of nonconductive specimens at critical energies in a cathode lens system", Scanning **23**, 36–50, 2001

M+AIN COLLABORATING PARTNERS

Collaboration with academic partners

- University of Toyama (Toyama, Japan)
- University of York (York, UK)
- University of Zürich (Zürich, CH)
- University of West Bohemia (Plzeň, CZ)
- Biology Centre of the CAS (CZ)
- Institute of Macromolecular Chemistry of the CAS (CZ)
- Brno University of Technology (Brno, CZ)
- Masaryk University (Brno, CZ)

Collaboration with companies

- JFE Steel Corporation (Tokyo, Japan)
- Voestalpine Stahl (Wien, Austria)
- Research and Testing Institute (Plzeň, CZ)
- DeLong Instruments (Brno, CZ)
- Thermo Fisher (FEI Czech Republic, Brno, CZ)
- Thermo Fisher (FEI Company, Hillsboro, OR, USA)
- Crytur (Turnov, CZ)

EXPECTATIONS

Offers

- Partnership in international projects
- Analysis of samples of advanced materials
- Cooperation on nanostructure tasks difficult to solve with traditional electron microscopic methods
- Design of detection systems for instruments using charged particles (electron and ion microscopes and lithographs)
- Contrast formation in electron and ion microscopes and lithographs, study of signal trajectories and interaction of charged particles with matter
- Design and manufacture of ultrahigh vacuum components and systems

Requirements

- Provision of samples of advanced materials
- Cooperation on nanostructure tasks difficult to solve with traditional electron microscopic methods
- Collaboration with industrial and academic partners
- Cooperation on vortex electron beams

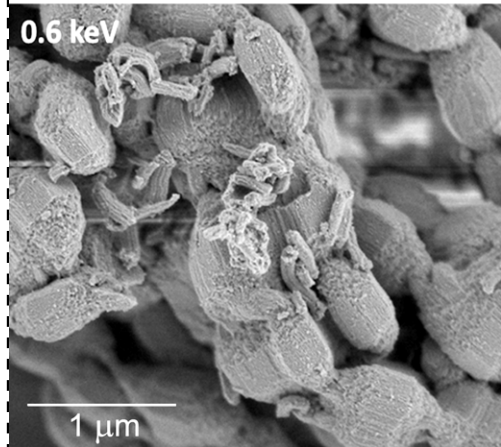
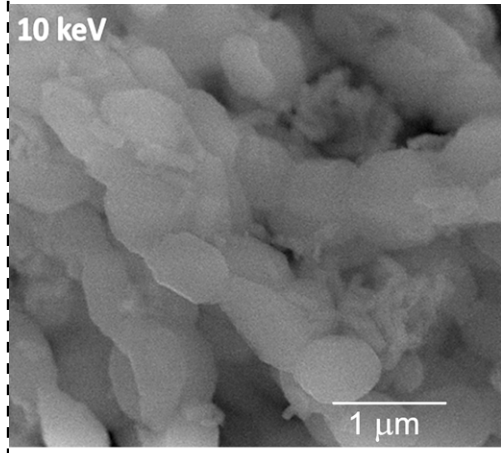

Mesoporous carbon nitride foam as a carrier for catalytic gold nanoparticles; when reducing the energy of electrons, we diminish the interaction volume from which we receive the image information so the image gets „sharper“

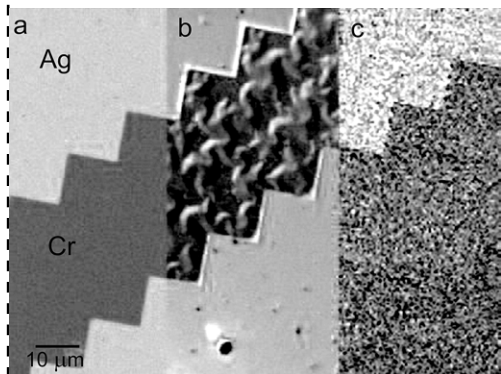

Surface analysis tools demonstrated on a 100 nm microcrystalline chromium foil, electron beam lithograph patterned on a silver-coated silicon wafer; (a) conventional image; (b) low energy image; (c) corrected Auger mapping in Cr

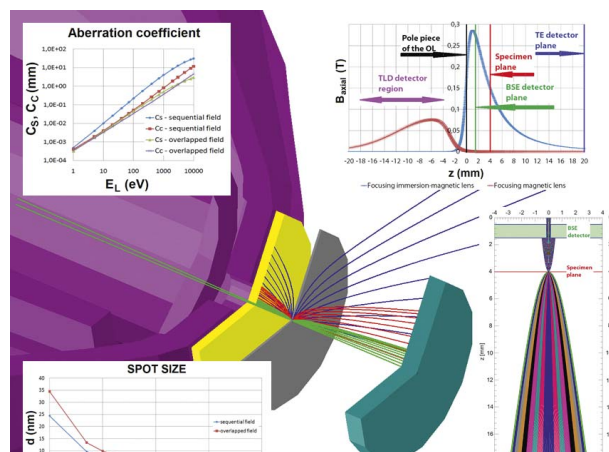

Examples of simulated configurations and results of simulations of electron-optical properties and trajectories of signal species

Group of Microscopy and Microanalysis

Department of Electron Microscopy



Institute of Scientific
Instruments
The Czech Academy
of Sciences

THEMATIC RESEARCH FOCUS

Research area

- High resolution scanning electron microscopy (SEM)
- Imaging of nonconductors in SEM
- Low energy SEM
- Scanning transmission electron microscopy (STEM)
- Energy dispersive X-ray analysis (EDX)
- Electron backscattered diffraction analysis (EBSD)
- Cathodoluminescence (CL)
- Imaging using energy-filtered secondary electrons

Excellence

- Imaging of samples (biological specimens) without metal coating in standard vacuum high resolution SEM
- Imaging of materials at low energies of impact electrons

Mission

Be in the forefront in the development of new high resolution SEM imaging methods and analysis for different kinds of materials even at low energies.

UP-TO-DATE ACTIVITIES

Research focus

- Experimental and theoretical activities related to imaging of specimens with electrons of energy below 1000 eV, high resolution imaging without metal coating. Imaging in reflected and transmitted detection mode
- Determination of elemental composition using energy-dispersive X-ray analysis (EDX)
- Determination of crystallographic orientation, defect studies, phase and grain boundary identification in many materials with electron back scattered diffraction (EBSD)
- STEM imaging
- Cathodoluminescence imaging and spectroscopy
- Energy-filtered imaging using secondary electrons. This technique allows discerning otherwise identical-looking materials of similar chemical composition.

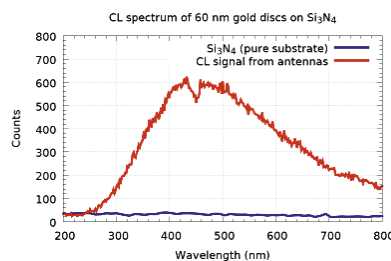
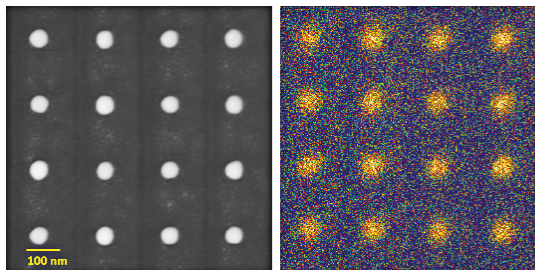

Gold disk antenna array imaged using secondary electrons (left) and using panchromatic cathodoluminescence signal (center), the spectrum of which is shown on the right.

Institute of Scientific Instruments
of the CAS, v. v. i.

Czech Academy of Sciences

Královopolská 147, 612 64 Brno,
Czech Republic

E-mail: institute@isibrno.cz

www.lem.isibrno.cz

Head: Dr. Filip Mika

Phone: +420 541 514 298

E-mail: mika@isibrno.cz

Expert: Dr. Zuzana Pokorná

Phone: +420 541 514 243

E-mail: zuzana.pokorna@isibrno.cz

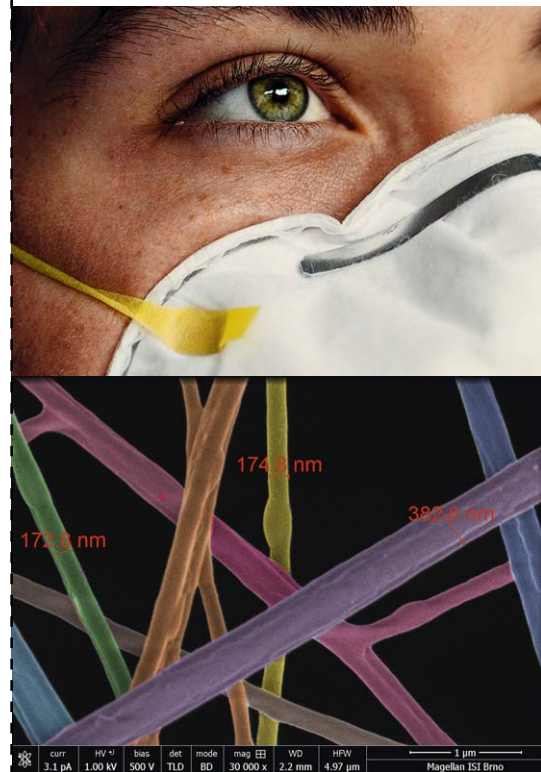

Fibers in a N95 face mask imaged
using non-charging low-energy
electron microscopy.

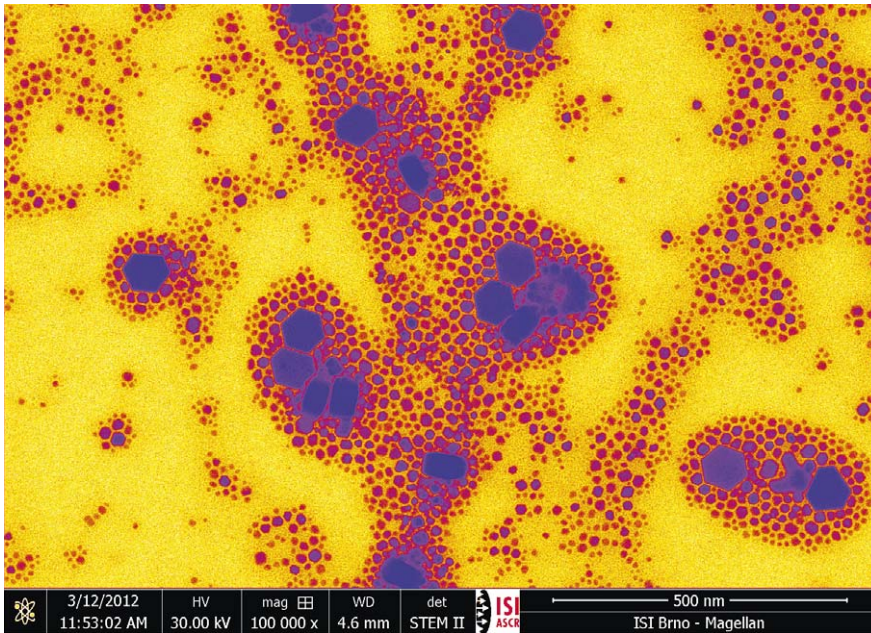

NaYF₄ nanoparticles imaged using Scanning Transmission Electron Microscopy.

Main capabilities

Basic research

- Mechanisms of signal electron generation and detection in SEM

Applied research

- Imaging a wide variety of samples with specific observation requirements (metals and alloys, composite materials and polymers, electronics materials, ceramic materials, natural and biological materials)
- Complex sample analysis

Sub-fields of group activities

- Material engineering
- Life-sciences (especially molecular biology, biochemistry)
- Measuring instruments
- Plastics, polymers
- Glass, ceramics

KEY RESEARCH EQUIPMENT

List of devices

Scanning electron microscopes:

- FEI MAGELLAN 400
- JEOL JSM 6700F
- TESCAN VEGA 5130

Analysers:

- Energy dispersive X-ray analysis (EDAX Octane Elect, INCA 350)
- Electron Back Scattered Diffraction Analyzer (EDAX Hikari)
- Cathodoluminescence detector (Gatan MonoCL)

Other equipment:

- Evaporators
- Sputter coater (Quorum Q150T ES)
- Cutting machine

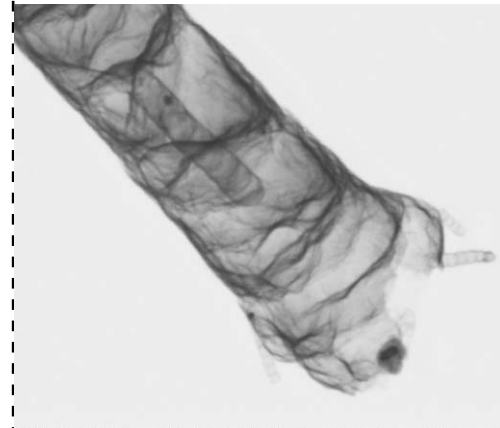

Carbon multiwall nano tube imaged with STEM bright field detector

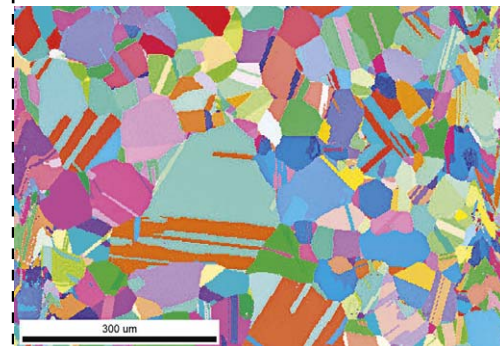

Different orientations of polycrystalline copper imaged with EBSD detector

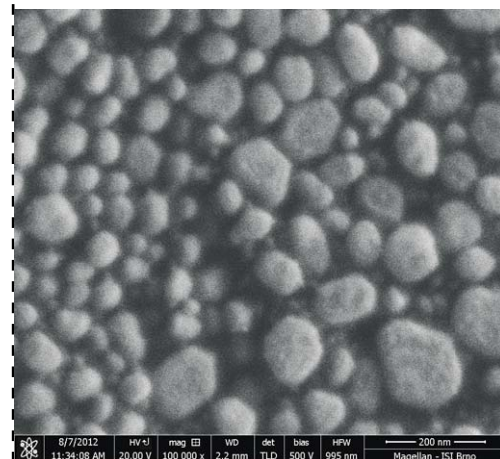
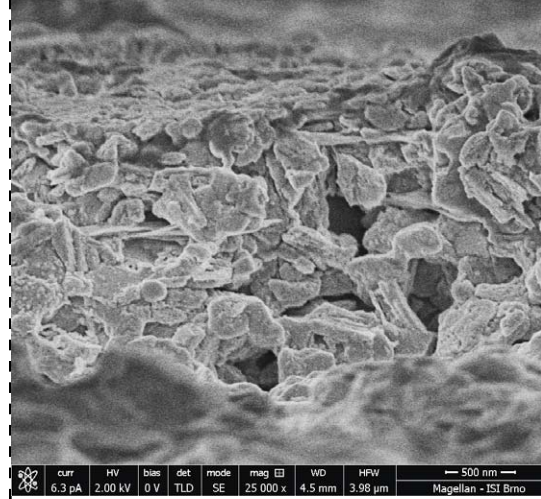

Image of gold on carbon test specimen at the incident electron energy of 20 eV, demonstrating the resolution possibilities of very low energy electron microscopy.

ACHIEVEMENTS

- Original methods of non-conductive specimen imaging with electrons of energy below 1000 eV without the need for conductive specimen coating.** This method reveals the real nanostructure and microstructure of the studied sample. Recently we have focused on microstructure of dielectric layers, plasmonic nanoparticles, natural photonic crystals with interesting optical properties.
 - J. Buršík, M. Soroka, R. Uhrecký, R. Kužel, F. Mika, Š. Huber: “Thin (111) oriented CoFe_2O_4 and Co_3O_4 films prepared by decomposition of layered cobaltates”, *Applied Surface Science* **376**, 209–218, 2016
 - O. Brzobohatý, M. Šiler, J. Trojek, L. Chvátal, V. Karásek, A. Paták, Z. Pokorná, F. Mika, P. Zemánek: “Three-Dimensional Optical Trapping of a Plasmonic Nanoparticle using Low Numerical Aperture Optical Tweezers”, *Scientific Reports*, **5**, JAN **29**, 08106:1–9, 2015
 - J. Buršík, M. Soroka, R. Kužel, F. Mika: “Growth and characterization of thin oriented Co_3O_4 (111) films obtained by decomposition of layered cobaltates”, *Journal of Solid State Chemistry* **227**, 17–24, 2015
 - F. Mika, J. Matějková-Plšková, S. Jiwajinda et al.: “Photonic Crystal Structure and Coloration of Wing Scales of Butterflies Exhibiting Selective Wavelength Iridescence”, *MATERIALS* **5**, 754–771, 2012
- Simulation methods describing the generation of signal electrons and their detection mechanism in SEM.**
 - F. Mika, Ch. Walker, I. Konvalina, I. Müllerová: “Imaging with STEM Detector, Experiments vs. Simulation”, *Microscopy and Microanalysis* **21**, S4, 66–71, 2015
 - L. Frank, F. Mika, I. Müllerová: “Optimizing the Recognition of Surface Crystallography”, *Microscopy and Microanalysis* **21**, S4, 124–129, 2015
- Discerning similar-looking materials with slightly different chemical structure using secondary electrons.**
 - M. Dapor, R. C. Masters, I. Ross, D. Lidzey, A. Pearson, I. Abril, R. Garcia-Molina, J. Sharp, M. Uncovsky, T. Vystavel, F. Mika, C. Rodenburg: “Secondary electron spectra of semi-crystalline polymers—A novel polymer characterisation tool”, *Journal of Electron Spectroscopy and Related Phenomena*, 2018, 222: 95–105.
 - K. J. Abrams, M. Dapor, N. Stehling, M. Azzolini, S. J. Kyle, J. Schäfer, A. Quade, F. Mika, S. Kratky, Z. Pokorna, I. Konvalina, D. Mehta, K. Black, and C. Rodenburg: “Making sense of complex carbon and metal/carbon systems by secondary electron hyperspectral imaging”, *Advanced Science*, 2019, 6.19: 1900719.



Cross-section of a dielectric layer imaged without any conductive coating, using low-energy electron microscopy.

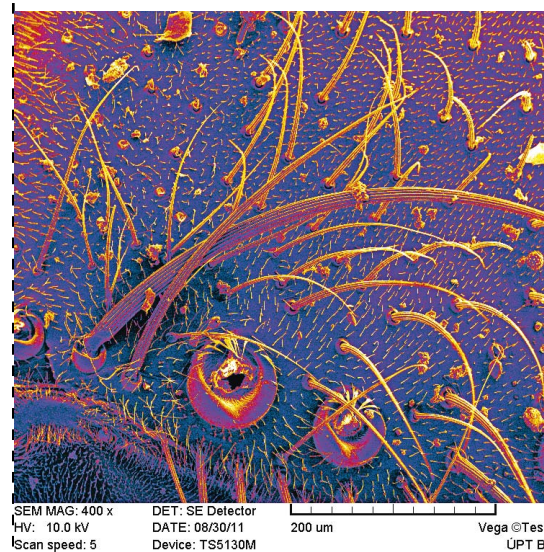

Detail of a housefly (*Musca domestica*) imaged with SE detector

High-resolution SEM Magellan 400

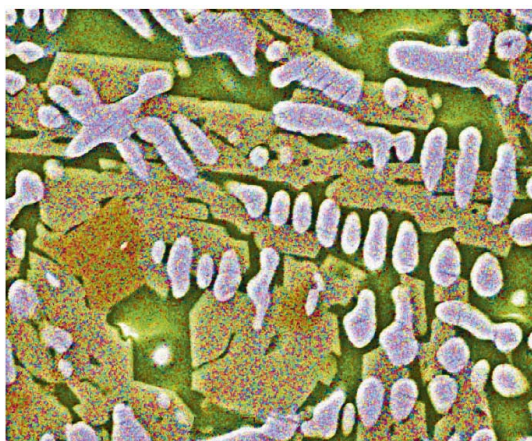

- O K α
- Al K α
- Si K α
- Ca K α
- Fe K α

EDX elemental map of an iron slag. Courtesy of Associate Professor Antonín Rek



MAIN COLLABORATING PARTNERS

Collaboration with academic partners

- Brno University of Technology (Brno, CZ)
- Masaryk University (Brno, CZ)
- Tomas Bata University (Zlín, CZ)
- Institute of Inorganic Chemistry AS CR, v.v.i. (Praha, CZ)
- Institute of Analytical Chemistry AS CR, v.v.i. (Praha, CZ)
- University of Sheffield (Sheffield, UK)
- Leibniz Institute for Plasma Science and Technology (Greifswald, Germany)
- Institute of Physics of Materials AS CR, v.v.i. (Brno, CZ)
- National University of Singapore (Singapore)

Collaboration with companies

- Ratiochem (Brno, CZ)
- Braiins Systems (Praha, CZ)
- Cronite CZ (Brno, CZ)
- Siemens Electric Machines (Drásov, CZ)
- Contipro (Dolní Dobrouč, CZ)
- Synthesia (Pardubice, CZ)
- EID Industrial Diamonds (London, GB)
- BVT Technologies, a.s. (Brno, CZ)
- Solartec s.r.o (Rožnov pod Radhoštěm, CZ)
- SURO s.r.o. (Praha, CZ)
- Koito (Žatec, CZ)
- Precision s.r.o. (Zlín, CZ)
- HARIS DIVISION s.r.o. (Psáry, CZ)
- Automotive s.r.o. (Velké Meziříčí, CZ)
- Inventec s.r.o. (Brno, CZ)
- Autopal (Uherské Hradiště, CZ)

EXPECTATIONS

Offers

- Know-how in the field of scanning electron microscopy imaging and interpretation of results from different detection modes
- Know-how in the field of energy dispersive X-ray analysis
- Know-how in the field of Electron backscattered diffraction analysis
- Know-how in the field of Cathodoluminescence imaging and spectroscopy

Requirements

- Collaboration with industrial partners in common projects dedicated to applied science
- Knowledge and technologies for material analysis
- New complementary technologies

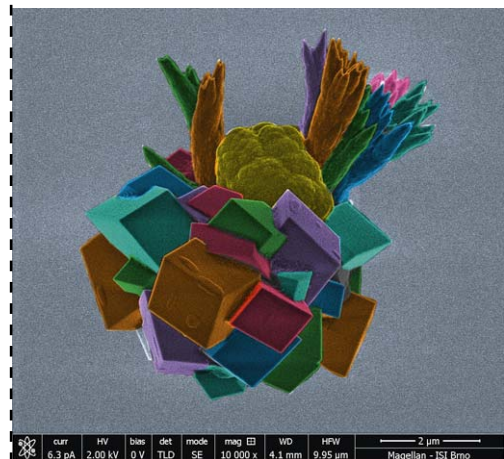

Particles in the water from Brno Dam

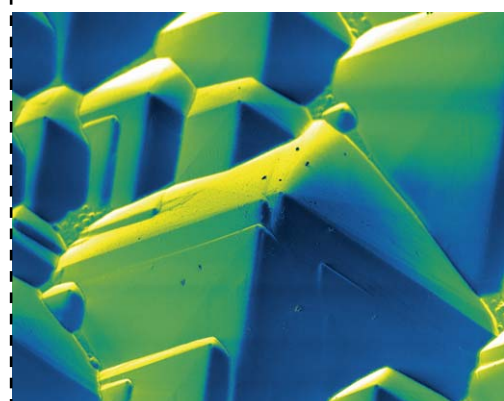

Surface of a solar cell panel

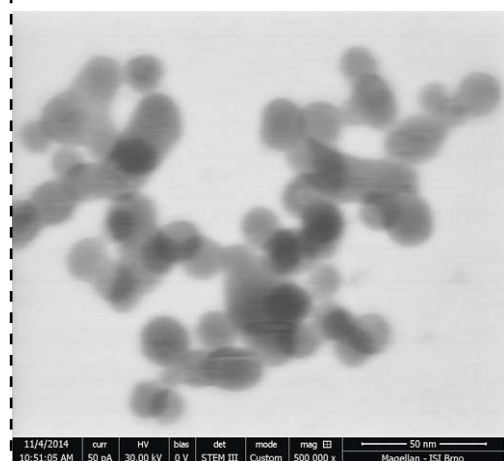

NaYF₄ nano particles imaged with STEM brightfield detector

Group of Microscopy for Biomedicine

Department of Electron Microscopy



ISI
CAS
Institute of Scientific
Instruments
The Czech Academy
of Sciences

Institute of Scientific Instruments
of the CAS, v. v. i.

The Czech Academy of Sciences
Královopolská 147, 612 64 Brno,
Czech Republic
<http://www.isibrno.cz/bioem/>

Head: Dr. Vladislav Krzyžánek
Phone: +420 541 514 302
E-mail: krzyzane@isibrno.cz

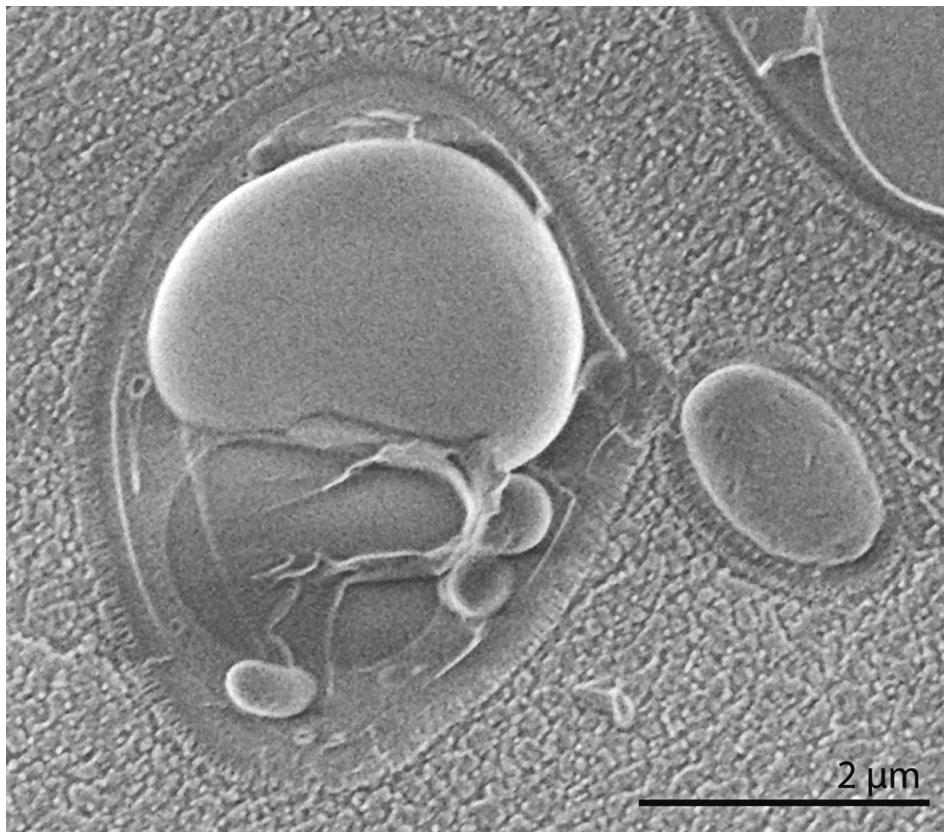

Cryo-SEM micrograph of *Sporobolomyces shibatanus*

THEMATIC RESEARCH FOCUS

Research area

- Scanning electron microscopy (SEM)
- Scanning transmission electron microscopy (STEM)
- Cryo scanning electron microscopy (cryo-SEM)
- Quantitative imaging
- Cathodoluminescence (CL)

Excellence

- Methodology and instrumentation of cryo-SEM of hydrated samples
- Quantitative imaging using annular dark-field mode in SEM, detection of very low signals, mass measurement with STEM
- Cathodoluminescence and photon collection in scintillators and screens for image formation in electron microscopy

Mission

To improve the performance of imaging and analytical systems in electron microscopy including developments of hardware, software and specific cryo sample preparation methods for soft and full-hydrated materials

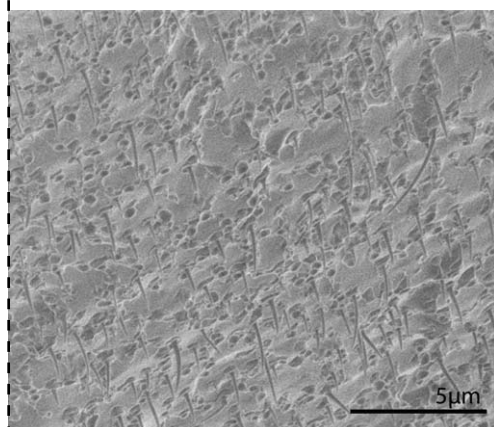

Freeze-fracture of bacteria
Cupriavidus necator containing
PHB granules, elastic under LN₂
temperatures

UP-TO-DATE ACTIVITIES

Research orientation

- Theoretical and experimental activities related to quantitative imaging using SEM/STEM of very thin samples and nanoparticles
- Development of cryo-techniques in SEM encompassing sample processing and imaging using combined signal detection
- Conventional SEM of biological and beam sensitive samples including EDX and CL analysis
- Cathodoluminescence kinetics of fast scintillators including thin and bulk single crystals
- Scintillation detection systems design with high signal photon collection efficiency

Main capabilities

Basic research

- Theoretical simulations of electron scattering for quantitative imaging
- Experimental activities related to sample preparation for quantitative imaging and low temperature SEM (physical fixation of hydrated samples, sublimation measurements etc.)
- Study of very weak cathodoluminescence using Time Correlated Single Photon Counting (TCSPC)
- Examination of cathodoluminescence efficiency and kinetics using time-resolved spectroscopy in a large temperature range

Applied research

- Design and production of cryo-devices for sample processing and detection systems for quantitative imaging
- Applications in cryo-SEM of biological and chemical samples, and in quantitative imaging such as mass-thickness mapping and mass loss measurements of soft materials
- Cathodoluminescence characterization of new scintillator materials

Sub-fields of group activities

- Electron microscopy
- Cryo-electron microscopy
- Materials sciences (polymers, soft matter, etc.)
- Life sciences (molecular biology, tumor biology, clinical and environmental microbiology)
- Nanotechnology
- Solid state physics
- Nuclear radiation detection

KEY RESEARCH EQUIPMENT

List of devices

- Cryo-equipment extending the SEM Magellan 400 (FEI) to cryo-SEM
- Cryo-high-vacuum preparation chamber ACE600 with freeze-fracture system, and cryo-vacuum transfer system VCT100 (Leica microsystems)
- Cryo-fixation systems (plunger, propane jet)
- Detection systems for quantitative STEM imaging
- Equipment for chemical processing of biological samples (chemical fixation, critical point dryer, etc.)
- Electron beam excitation unit with an electrostatic deflection system and a blanking diaphragm
- UV light collection and transmission system with a Horiba Jobin Yvon iHR320 spectrometer
- Utilization of equipment of the Group of Microscopy and Microanalysis



Equipment for cryo-SEM sample preparation

ACHIEVEMENTS

We have been focused on instrumental and methodological research in the fields of signal detection with its theoretical description and calibration, sample preparation and sublimation experiments for the low temperature SEM. In the last five years we published about 30 papers in impacted journals with a good citation response, and about 40 longer contributions in conference proceedings or local journals.

■ Cryogenic scanning electron microscopy (cryo-SEM)

Instrumental and methodological developments in cryo-SEM, e.g. combination of high-pressure-freezing on sapphire discs with cryo-SEM imaging.

- V. Krzyžánek, K. Hrubanová, J. Nebesářová, F. Růžička: "Cryo-SEM of Perpendicular Cross Freeze-Fractures Through a High-Pressure-frozen Biofilm", *Microscopy and Microanalysis* **20**, S3, 1232–1233, 2014
- FEI/CSMS scholarship awarded to Kamila Hrubanová (2015–2017)
Structure investigations of bacterial and yeast biofilms using cryo-SEM
- O. Samek, S. Bernatová, J. Ježek, M. Šiler, M. Šerý, V. Krzyžánek, K. Hrubanová, P. Zemánek, V. Holá, F. Růžička: "Identification of individual biofilm-forming bacterial cells using Raman tweezers", *Journal of Biomedical Optics* **20**, 051038:1–6, 2015
Investigations of PHB granules produced by bacteria under specific conditions
- S. Obruca, P. Sedlacek, V. Krzyzaneck, F. Mravec, K. Hrubanova, O. Samek, D. Kucera, P. Benesova, I. Marova: "How accumulation of poly(3-hydroxybutyrate) helps bacterial cells to survive freezing", *PLoS ONE* **11**, e0157778, 2016

■ Quantitative imaging using the transmission mode in SEM

Instrumental and methodological developments in quantitative imaging including samples preparation, electron scattering simulation, data recording with required calibrations.

- S. Tacke, V. Krzyzaneck, H. Nüsse, R. Wepf, J. Klingauf, R. Reichelt: "A versatile high-vacuum cryo transfer system for cryo microscopy and analytics", *Biophysical Journal* **110**, 758–765, 2016
- V. Krzyžánek, S. Tacke, K. Hrubanová, R. Reichelt: "Beyond Imaging: Scanning Electron Microscope for the Quantitative Mass Measurement", *Microscopy and Microanalysis* **19**, S2, 130–131, 2013
Applications of STEM quantitative imaging.
- J. Hajduová, K. Procházka, V. Raus, M. Šlouf, V. Krzyžánek, V. M. Garamus, M. Štěpánek: "Structure of polymeric nanoparticles in surfactant-stabilized aqueous dispersions of high-molar-mass hydrophobic graft copolymers", *Colloids and Surfaces. A - Physicochemical and Engineering Aspects* **456**, 10–17, 2014
- V. Novotná, K. Hrubanová, J. Nebesářová, V. Krzyžánek: "Investigation of Electron Beam Induced Mass Loss of Embedding Media in the Low Voltage STEM", *Microscopy and Microanalysis* **20**, S3, 1270–1271, 2014

■ Conventional electron microscopy of biological, medical and chemical samples

- S. Voběrková, S. Hermanová, K. Hrubanová, V. Krzyžánek: "Biofilm formation and extracellular polymeric substances (EPS) production by *Bacillus subtilis* depending on nutritional conditions in the presence of polyester film", *Folia Microbiologica* **61**, 91–100, 2016
- Y. Resch, K. Blatt, U. Malkus, C. Fercher, I. Swoboda, M. Focke, K.-W. Chen, S. Seiberler, I. Mittermann, C. Lupinek, A. Rodriguez-Dominguez, P. Zieglmayer, R. Zieglmayer, W. Keller, V. Krzyzaneck, P. Valent, R. Valenta, S. Vrtala: "Molecular, Structural and Immunological Characterization of Der p 18, a Chitinase-Like House Dust Mite Allergen", *PLoS ONE* **11**, e0160641, 2016

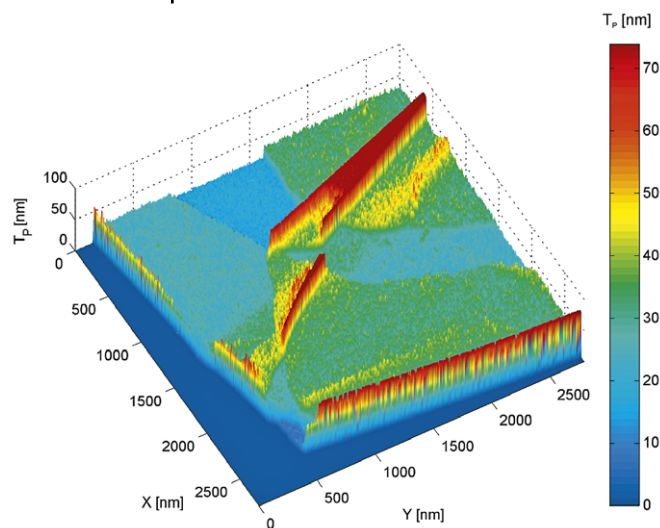

Randomly folded very thin carbon film: ADF STEM image and projected thickness map

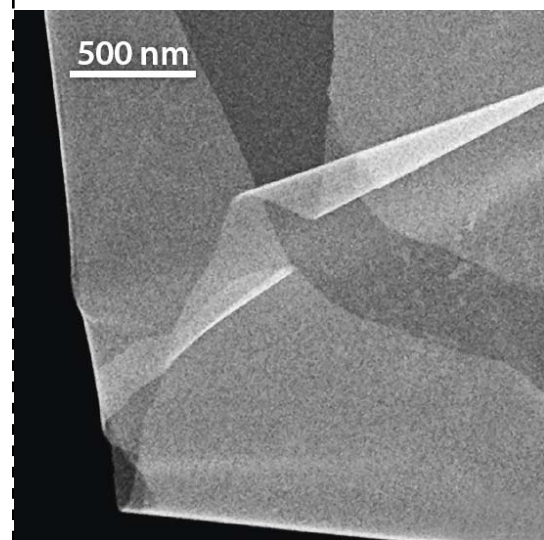

■ Cathodoluminescence (CL) measurements

New method of performance characterization of SEM detectors.

- J. Bok, P. Schauer: "Performance of SEM scintillation detector evaluated by modulation transfer function and detective quantum efficiency function", *Scanning* **36**, 384–393, 2014
Promising scintillator improving SEM detectors efficiency.
- J. Bok, O. Lalinský, M. Hanuš, Z. Onderišinová, J. Kelar, M. Kučera: "GAGG:ce single crystalline films: New perspective scintillators for electron detection in SEM", *Ultramicroscopy* **163**, 1–5, 2016
Strong innovation of the CL apparatus enabling much deeper CL studies thanks to the temperature-controlled specimen holder.
- J. Bok, P. Schauer: "Apparatus for temperature-dependent cathodoluminescence characterization of materials", *Measurement Science and Technology* **25**, 075601, 2014
Cooperation with CRYTUR company on improving scintillators.
- J. Bok, P. Horodský, V. Krzyžánek: "Effect of oxidation annealing on optical properties of YAG:Ce single crystals", *Optical Materials* **46**, 591–595, 2015

For more details and publications see www.isibrno.cz/bioem.

MAIN COLLABORATING PARTNERS

Collaboration with academic partners

- University of Münster (Münster, DE)
- ETH (Zurich, CH)
- National Institute of Health (Bethesda, USA)
- The University of Queensland (Brisbane, Australia)
- Brno University of Technology (Brno, CZ)
- Masaryk University (Brno, CZ)
- St. Anne's University Hospital (Brno, CZ)
- Biology Centre of the CAS (České Budějovice, CZ)
- Institute of Macromolecular Chemistry of the CAS (Praha, CZ)
- Charles University (Praha, CZ)
- Institute of Physics of the CAS (Praha, CZ)
- Tomáš Baťa University in Zlín (Zlín, CZ)

Collaboration with companies

- CRYTUR (Turnov, CZ)
- Microscopy Improvements (Eisenstadt, Austria)
- Leica Microsystems (Vienna, Austria)

EXPECTATIONS

Offers

- We offer collaboration in our areas of expertise
- Partnership in international projects

Requirements

We look for cooperation with academic partners as well as companies in the fields of electron microscopy, nanotechnologies, applications of SEM/STEM techniques including cryo-techniques in biological, medical and soft matter research, material characteristics, applications of scintillators and imaging screens.

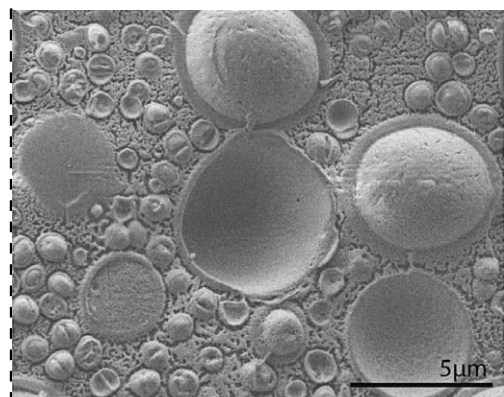
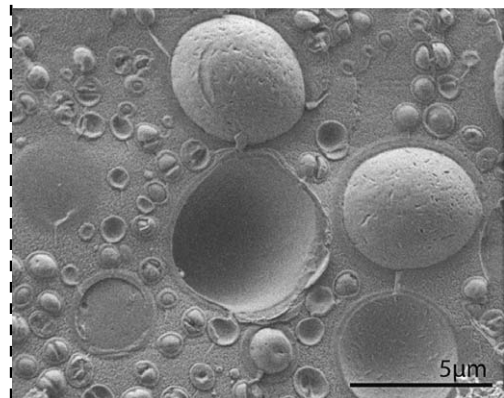

Progressive sublimation exposing inner structure of microbial biofilm (Staphylococcus epidermidis, Candida parapsilosis)

Group of Environmental Electron Microscopy (EEM)

Department of Electron Microscopy



Institute of Scientific
Instruments
The Czech Academy
of Sciences

THEMATIC RESEARCH FOCUS

Research area

- Scanning & Environmental scanning electron microscopy (SEM/ESEM)
- Environmental and scanning transmission electron microscopy (Wet-STEM/STEM)
- Signal electron and photon detection systems
- Energy dispersive X-Ray spectroscopy
- Computer based simulations for SEM/ESEM

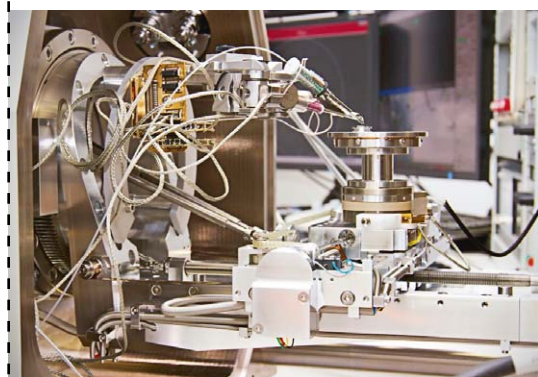

Laboratory of environmental electron microscopy with high resolution ESEM QUANTA 650 FEG (left) equipped with micromanipulators (right)

Excellence

- Low dose micro-morphological characterisation of untreated wet biological samples and polymers in ESEM
- Dynamical in-situ observation on the phase boundaries/transitions of matters and under well balanced thermodynamic conditions in ESEM & electron microscopy for ice chemistry
- Monte-Carlo simulations of electron-gas, electron-water and electron-solid interactions in ESEM
- High-resolution imaging and X-ray micro-analysis of non/semi conductive samples in ESEM
- Research, development, and manufacturing of very high efficient detectors of signal electrons for SEM/ESEM
- Gas flow and heat transfer simulations for R&D of custom instrumentation for SEM/ESEM

Mission

To be the world leader in the low dose/energy environmental scanning electron microscopy and at the forefront in the field of static or dynamic in-situ characterisation of low emissive, beam sensitive, mostly non-conductive wet samples observed in their native state. To invent new methods, instrumentation, and applications for further exploration of the nano-world.

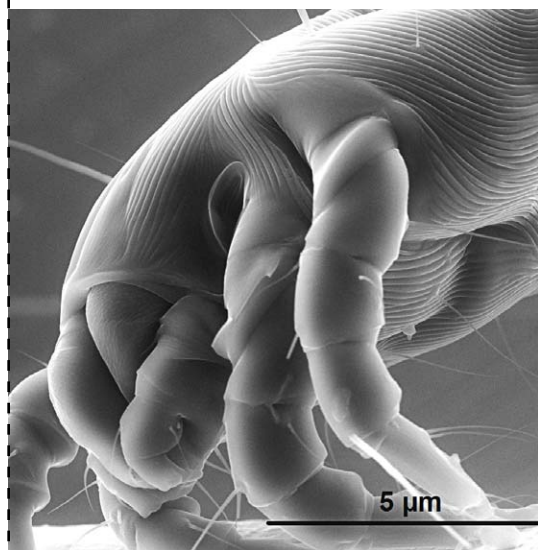

Live Mite observed in the ESEM AQUASEM II

UP-TO-DATE ACTIVITIES

Research focus

- Theoretical and experimental activities related to pushing boundaries of ESEM capabilities (development of new ESEM designs, new detectors)
- Dynamical in situ characterisation of samples under different physical and chemical impacts, etc.
- Morphological and structural analysis of natural or live samples

Main capabilities

Basic research

- Theoretical simulations of electron-gas, electron-water and solid interactions
- Theoretical simulations of gas flow and heat transfer in ESEM
- New methodology for low dose observation and chemical analysis of native biological samples

Applied research

- Design and conversion of SEM Vega (Tescan) to experimental ESEM AQUASEM II
- Design and manufacturing of the HAADF detector for Hitachi TEM, the BSE detector for Jeol SEM-JSM 5600LV, the new „edge-free“ detector for Hitachi SEM, the YAP detector for Jeol SEM, the Scintillation SE detector for ESEM and other prototypes of BSE detectors (over 50 pieces) for Jeol, Hitachi & FEI

Innovations

- New Ionisation SE detector with electrostatic separator for ESEM (EU patent No. 2195822)

Sub-fields of group activities

- Micro/nanotechnology
- Biology/biotechnology, chemistry
- Semiconductor industry/electronics
- Pharmaceutical industry
- Textile industry
- Building materials
- Automotive

KEY RESEARCH EQUIPMENT

List of devices

- Environmental scanning electron microscopes AQUASEM II, QUANTA 650 FEG
- Scintillation BSE detectors (YAG, YAP and CRY018 scintillators)
- X-Ray EDS analyzer Bruker XFlash 6/60 + mapping (EDS microanalysis in SEM/ESEM)
- Many types of special detectors (ET, GAD, LFD, GSED, ICD, DBS, CL, scintillation SE detector, ISEDS)
- Kleindiek micromanipulators, EBIC, RCI amplifier, gas and liquid micro-injectors & hydration system
- Peltier cooling stage and heating stage (from -20°C to +1000°C)
- Retractable solid state WetSTEM/STEM detector

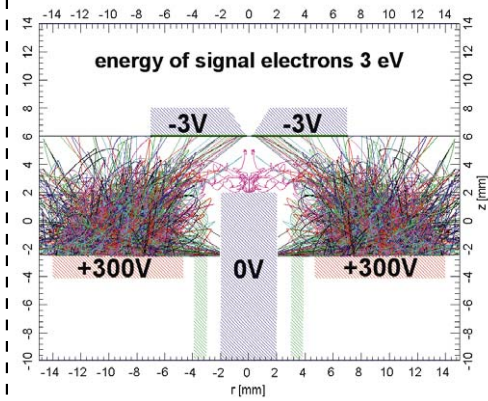
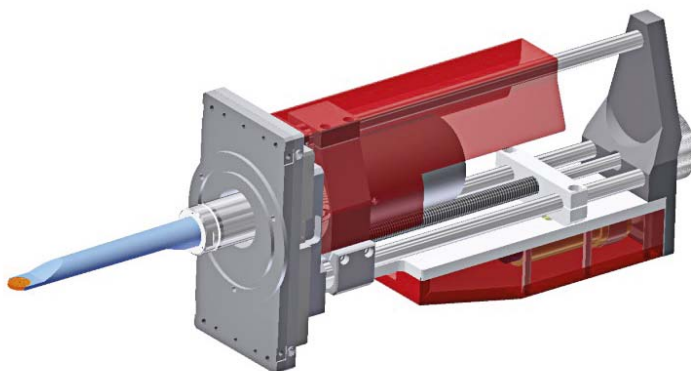

Monte Carlo simulation of electron trajectories in gas (ESEM conditions)

Monte Carlo simulations of electron-solid sample interactions (C-Si multilayer)

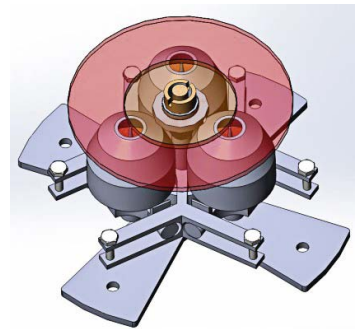
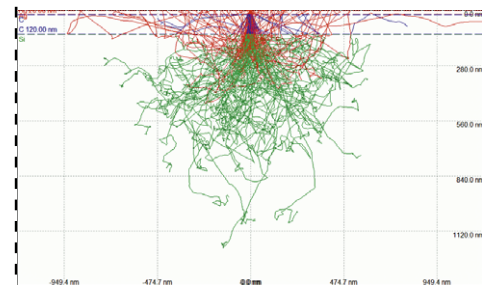

New version of patented ISEDS with magnetic field (new detector for ESEM)

New scintillation BSE detector for SEM and ESEM (left) and hydration system (right)

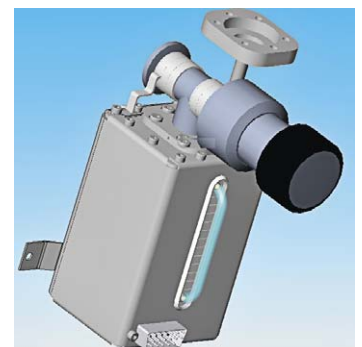

ACHIEVEMENTS

Awards

Kenbikyo Award 2016 – excellent paper of the journal for last two years (Japanese society of microscopy award). The best Ph.D. thesis (Czechoslovak Microscopy Society award), 2nd place in the event the Best doctoral thesis in the field of Building rehabilitation and reconstruction (Scientific and Technical Association for Building Rehabilitation and Monument Preservation award).

Papers

We are pushing the limits of possibilities of imaging and analysis of untreated, electrically non-conductive/semi-conductive and wet or liquid samples in ESEM. We are specialized in the characterization of difficult to see and advanced materials using our developed new methods and unique instrumentation.

■ **Pioneering theoretical results of Monte Carlo simulations of electron-gas interactions and signal electron transportation in gas owing to the collection efficiency of segmented ionization detector for signal electrons with selected energies from units of eV to 18 keV.**

- V. Neděla, et al., *Microscopy and Microanalysis* **21**(4), 264, 2015
- V. Neděla, et al., *Microscopy and Microanalysis* **21**(3), 1109, 2015

■ **Significant theoretical work focused on calculations of higher-order deflections aberrations of the electron-optical system used for environmental scanning electron microscopy and possibility of their dynamical corrections. This work indicates future trends in the ESEM.**

- M. Oral et al., *Microscopy and Microanalysis* **21** (4), 194, 2015

■ **World unique experimental results were attained by studying ice contamination processes at grain boundaries in environmentally compatible conditions of a high gas pressure and a relatively high temperature in a specially modified ESEM in a combination with fluorescence microscopy.**

- J. Krausko et al., *Langmuir* **30** (19), 5441, 2014

■ **A new method for the high-resolution morphological study of plant samples in their native state. Method also allows increasing sample resistance to radiation damage by the electron beam. This method was invented and experimentally tested on many types of plant biological samples in our laboratories.**

- V. Neděla et al., *Microsc Res Tech*. **78**, 13, 2015
- V. Neděla et al., *Biologia Plantarum* **56** (3), 595, 2012

■ **Based on the results of Monte Carlo simulations of an electron beam with water involving study of free radicals concentration, a new, extremely sample-preserving method was introduced. It allows studying of small live and surviving animals like mites in ESEM. The method presents basic research in the new field of live organism observation in the conditions of a high pressure, a low electron energy, and a low beam current, utilizing advanced instrumentation systems.**

- E. Tihlaříková et al., *Microscopy and Microanalysis* **19** (4), 914, 2013
- V. Neděla et al., *Kenbikyo*. **49** (1), 64, 2014

■ **Based on optimization of the new method for study of live samples and in combination with our unique high efficient detectors of signal electrons for ESEM, a new method for morphological characterization of very beam sensitive wet polyelectrolyte complex microcapsules containing a semi liquid core with live cells was introduced. Our**

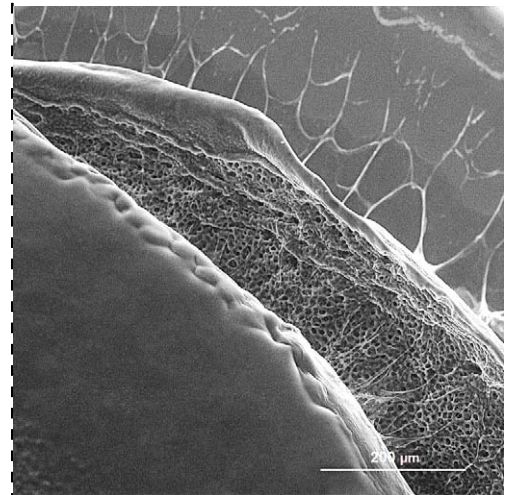

Wet polyvinyl-alcohol lances (LentiCat™) in native state in ESEM

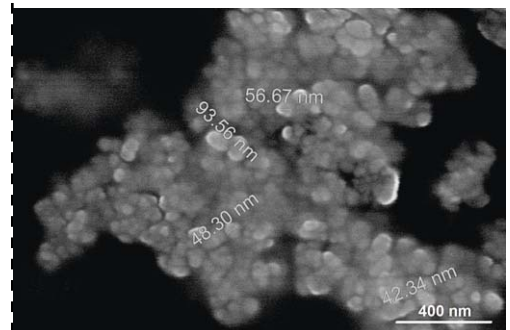

Uncoated zinc oxide nanoparticles in ESEM

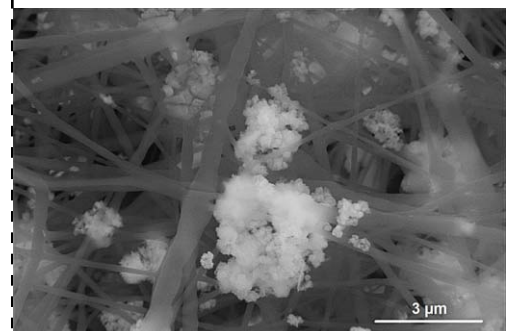

Uncoated surface of PUR with 10% CuO₂ nanoparticles (ESEM for textile industry)

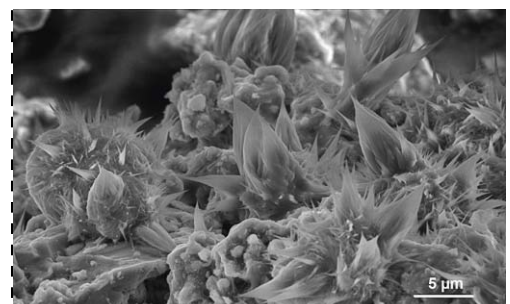

Alkali-activated steel making slag in ESEM (Uncoated surface)

laboratory is the only one in the world able to observe these types of samples free of destruction or damage.

- A. Bertóková et al., *Biocatalysis and Biotransformation* **33** (2), 111, 2015
- A. Schenk Mayerová et al., *Applied Biochemistry and Biotechnology*, **174** (5), 1834, 2014

Patents

The ISEDS allows to reach one of the world highest detection efficiency and is possible to detect low energy signal electrons within optional energy range and with very high signal to noise ration.

New Ionisation SE detector with electrostatic separator for ESEM (CZ patent No. 299864, EU patent No. 2195822)

For more details and publications see eem.isibrno.cz

MAIN COLLABORATING PARTNERS

Collaboration with academic partners

- University of Cambridge (Cambridge, GB)
- University of Kyoto (Kyoto, JP)
- University of Nagoya (Nagoya, JP)
- Wrocław University of Science and Technology (Wrocław, PL)
- University of technology Sydney (Sydney, AS)
- Charles University (Praha, CZ)
- Brno University of Technology (Brno, CZ)
- Masaryk University (Brno, CZ)
- Mendel University (Brno, CZ)
- Institute of Experimental Botany CAS (Praha, CZ)
- Institute of Chemistry, Slovak Academy of Sciences (Bratislava, SK)

Collaboration with companies

- Hitachi High Technologies (Tokyo, JP)
- Jeol (Tokyo, JP)
- FEI Czech Republic, s.r.o. (Brno, CZ)
- Tecpa s.r.o. (Brno, CZ)
- AutraDet (Brno, CZ)

EXPECTATIONS

Offers

We offer collaboration in the field of research and testing of a wide range of difficult to observe samples in SEM/ESEM. Study of materials under dynamically changing conditions using unique electron microscopes, advanced instrumentations and methods. Partnership in local and international scientific or company projects.

Custom research, development and manufacturing of special detection systems and advanced instrumentation for electron microscopes. Theoretical studies from the field of electron-gas/liquid/solid interactions and gas flow simulations for R&D of environmental electron microscopes.

Requirements

We look for cooperation with academic partners as well as companies in the fields of electron microscopy, physical, life and applied sciences as biology, chemistry, pharmacy, micro & nano-technologies, automotive, etc.

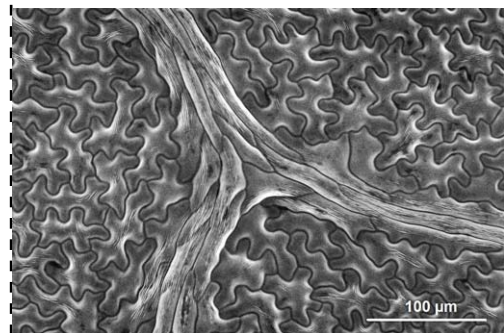

Fully expanded apple leaf, adaxial epidermis formed by puzzle-like cells (ESEM for plant biology)

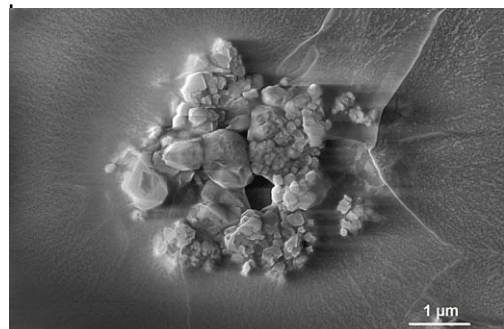

Uncoated SiO₂ nanoparticles in epoxy resin (ESEM for micro/nanotechnology and electronics)

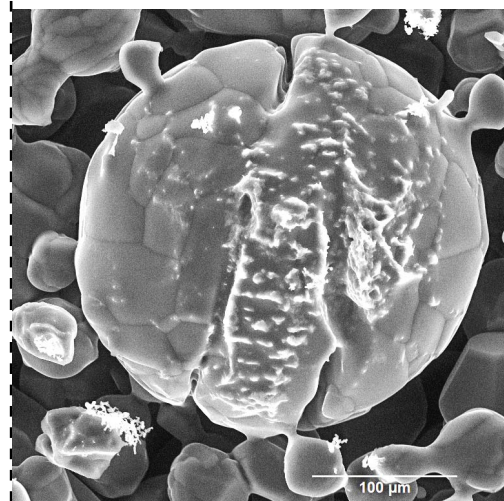

Ice particle with pollutants (ESEM for ice chemistry)

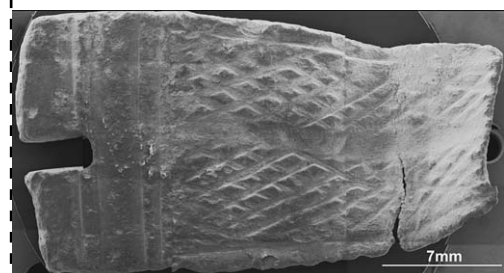

Uncoated buckle (ESEM for archaeology)

Group of Electron Beam Technologies (EBT)
Department of Electron and Plasma Technologies



**Institute of Scientific Instruments
of the CAS v. v. i.**
The Czech Academy of Sciences
Královopolská 147, 612 64 Brno,
Czech Republic
<http://ebt.isibrno.cz>

Head: Dr. Martin Zobač
Phone: +420 541 514 315
E-mail: Martin.Zobac@isibrno.cz

Expert: Dr. Ivan Vlček
Phone: +420 541 514 297
E-mail: Ivan.Vlcek@isibrno.cz

Expert: Dr. Libor Dupák
Phone: +420 541 514 316
E-mail: Libor.Dupak@isibrno.cz



Electron guns for electron beam welding

THEMATIC RESEARCH FOCUS

Research area

- Electron beam welding
- Vacuum brazing
- Vacuum feedthroughs
- High-voltage DC power supplies
- Special electronics

Electron beam welding





Electron beam welder

Excellence

Electron beam welding of dissimilar metals; custom-made vacuum feedthroughs; precise high voltage supplies

Mission

Development of the new joining techniques of various metals, as well as design of the necessary equipment for such, as electron beam welders, vacuum furnaces and analytical electron-optics devices

UP-TO-DATE ACTIVITIES

Research focus

- Electron beam welding of dissimilar metals
- Development of electron beam welders including high-voltage power supplies
- High voltage power supplies for particle optics devices
- Brazing of metals with brittle non-metallic materials using pliable active filler metals
- Development of vacuum feedthroughs based on glass-to-metal seal

Main capabilities

Basic research

- Study of homogenous and heterogeneous joints of various metals

Applied research

- Design of technological devices such as electron beam welders, vacuum furnaces, etc.
- Development of high voltage power supplies for both high power and precise electron optics
- Various types of vacuum feedthroughs based on glass-to-metal seal (matched kovar-glass or compression seal) both standard types (e.g. D-sub) or custom made

Sub-fields of group activities

- Precision engineering
- Automotive and aerospace industry
- Nuclear industry
- Vacuum technology
- Scientific instruments
- Semiconductor manufacturing

Electrical vacuum feedthroughs



KEY RESEARCH EQUIPMENT

List of devices

- Three electron beam welders (up to 60 kV, up to 2kW) developed and produced at ISI with two different types of vacuum chambers
- Upgraded vacuum furnace PZ-810 produced by former Czech company Tesla Rožnov
- Laboratory vacuum furnace for brazing and heat treatment of smaller parts (made by team)
- Furnace for glass-to-metal seal processing
- Helium leak detector QualyTest™ Dry HLT 270 by Pfeiffer Vacuum
- Precise 100 kV high voltage power supply with stability better than 2 ppm per 24 hours (made by team in collaboration with TESCAN Brno)
- Precise reference high voltage divider for voltage measurements up to 120 kV (made by team)

ACHIEVEMENTS

- **We developed a new improved version of the welding electron gun. The new electron beam generator has improved functionality, better X-ray protection and lower manufacturing costs. A special version of the gun with output power of 6 kW was developed for nuclear research facility.**
- **Our partners from academic institutions and from industry bring continuously new challenges in the field of metal joining. We dealt with dissimilar metal welding and braising, e.g. welding of Inconel alloys, refractory metals, steels, copper alloys and lot of others.**
- **During the fruitful cooperation with the leading electron microscopy manufacturer TESCAN a new precise high voltage supply was developed. The device can generate up to 100 kV with long term stability better than 2 ppm per 24 hour period. For testing and calibration a highly stable precise reference voltage divider was built.**
- **New types of vacuum feedthroughs were developed, among others quad SMB connector on ISO-KF 25 flange, MIL-C-5015 14S-2P on ISO-KF 25 flange and 12 way circular Hypcon-type connector for welding.**
- **We replaced old manual control of our vacuum and glass-processing furnaces with state-of-the-art PLC control systems. The new control systems support easy temperature profiling, remote control, data logging and system diagnostics.**

MAIN COLLABORATING PARTNERS

Collaboration with academic partners

- Brno University of Technology (Brno, CZ)
- University of West Bohemia in Pilsen (Plzeň, CZ)
- Masaryk University (Brno, CZ)
- Institute of Atmospheric Physics CAS (Prague, CZ)
- Institute of Physics of Materials CAS (Brno, CZ)

Collaboration with companies

- Focus GmbH (Hünstetten, Germany)
- TESCAN Brno, s.r.o. (Brno, CZ)
- První brněnská strojírna, a.s. (Velká Bíteš, CZ)

High voltage reference divider for voltages up to 120 kV





Improved vacuum furnace

- PBS ENERGO, a.s. (Velká Bíteš, CZ)
- Honeywell, spol. s r. o. (Brno, CZ)
- KOMO mark s.r.o. (Ostrava, CZ)
- ATEKO a.s. (Hradec Králové, CZ)
- Lavat a.s. (Chotutice, CZ)
- MESIT AEROSPACE, s.r.o. (Uherské Hradiště, CZ)
- Rigaku Innovative Technologies Europe s.r.o. (Praha, CZ)
- ŠKODA JS a.s. (Plzeň, CZ)
- VUES Brno s.r.o. (Brno, CZ)
- Glatt - Pharma, spol. s r.o. (Hradec Králové, CZ)
- VÚHŽ a.s. (Dobrá, CZ)
- ÚJP PRAHA a.s. (Praha, CZ)
- LAPP Insulators Alumina s.r.o. (Hradec Králové, CZ)
- Siemens, s.r.o., odštěpný závod Industrial Turbomachinery (Brno, CZ)
- Thermo Fisher Scientifics (Brno, CZ)
- DELONG INSTRUMENTS a.s. (Brno, CZ)
- Hanon Systems Autopal s.r.o. (Nový Jičín, CZ)
- Howden ČKD Compressors s.r.o. (Praha, CZ)

EXPECTATIONS

Offers

- Know-how in field of electron beam welding and vacuum brazing
- Welding and brazing equipment capacities for job shop production
- Development and small-lot production of vacuum feedthroughs
- Special electronics development skills, in particular high-voltage DC supplies design

Requirements

- Collaboration with industrial partners in joint projects dedicated to applied science
- Knowledge and technologies for material analysis
- New complementary technologies

Group of Thin Layers

Department of Electron and Plasma Technologies



ISI
CAS
Institute of Scientific
Instruments
The Czech Academy
of Sciences

Institute of Scientific Instruments
of the CAS, v. v. i.

The Czech Academy of Sciences
Královopolská 147, 612 64 Brno,
Czech Republic
<http://ebt.isibrno.cz/en/about-us>

Head: Dr. Tomáš Fořt
Phone: +420 541 514 339
E-mail: fortt@isibrno.cz

Expert: Dr. Josef Daniel
Phone: +420 541 514 339
E-mail: jdaniel@isibrno.cz



Computer controlled magnetron
sputtering system Aurion

Aurion chamber

THEMATIC RESEARCH FOCUS

Research area

- Deposition of thin films by magnetron sputtering
- Dynamic impact testing of coated components and bulk materials



Excellence

- Multilayers for x-ray and EUV optics
- Precise nanostructures as a tool to magnetic field sensing, electrochemical sensors, and plasmonics
- Dynamic impact testing

Mission

Search for new practical application of well-handled technologies, e.g. deposition of x-ray and EUV optics, in particular in new brand of industry (space research). Development of instrumentation for testing of impact resistance of various materials. The technological support of other departments on the ISI CAS.

UP-TO-DATE ACTIVITIES

Research orientation & focus

- Sputtering and characterization of nanostructured layers used in soft x-ray lasers
- Deposition of precise nanostructures used in sensors
- Deposition of nanostructured coatings for plasmonics
- Deposition of multi-layered systems for x-ray and EUV optics
- Dynamic impact testing of coated systems and/or various bulk materials

Main capabilities

Basic research

- Study of deposition of thin films, thin films growth, and optical properties of thin films
- Study of structures intended as various types of sensors
- Study of mechanisms of dynamic impact wear of materials

Applied research

- New types and features of the multi-layered systems for x-ray and EUV optics
- Wear resistant and impact resistant coatings used in mechanical engineering, automotive industry, defence industry, and power engineering
- Impact resistance and impact lifetime of industry used materials and 3D printed components

Fields of group activities

- Material science (study of coating/substrate system under dynamical load)
- Measuring instruments (construction of impact testers)
- Renewable energy (solar cells, testing of protective coatings used in boilers)
- Automotive industry and mechanical engineering (wear resistant and impact resistant coatings)
- Optics (multilayer x-ray and EUV optics)
- Co-organisation of Workshops on X-ray and EUV Optics and applications

KEY RESEARCH EQUIPMENT

List of devices

- Magnetron sputtering system Aurion equipped with two RF and one DC magnetrons (\varnothing 152 mm) enabling development and production of the multi-layered and nanostructured coatings (x-ray and EUV optics, magnetic field sensing)
- Magnetron sputtering system Leybold Heraeus – Z550 equipped with three RF magnetrons (\varnothing 152 mm) enabling development and production of the wear resistant coatings (e.g. DLC-based coatings)
- Magnetron sputtering system equipped with one RF magnetron (\varnothing 76 mm)
- 3D laser confocal microscope Keyence VK-X 1100
- Laser confocal microscope Olympus LEXT OLS-3100
- Calotest – CSM Instruments
- Disc polishing and grinding machine MTH kompakt 1031 + head APX010

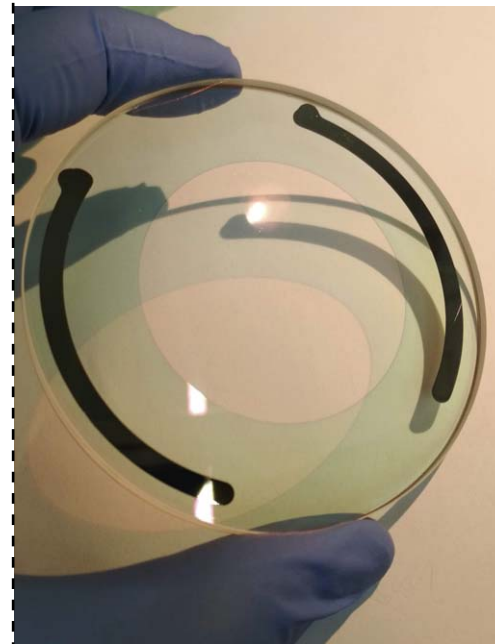

ITO transparent conductive coatings on glass.



Example of an Ag-based laser mirror on a glass substrate.

Measurement of X-ray mirror parameters at Cu K α .

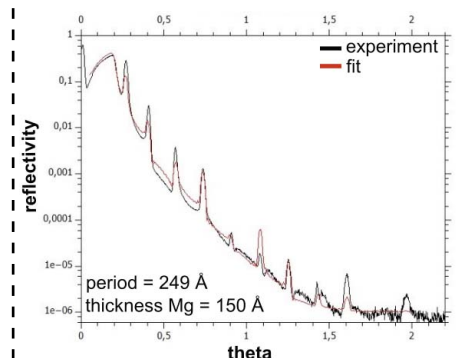

- Contact profilometer Taylor-Hobson with enhanced measurement repeatability
- Dynamic impact tester for evaluating impact resistance and impact lifetime of protective coatings and bulk materials

ACHIEVEMENTS

- Preparation of multi-layered systems with an exactly defined layer thickness and the repeatability of the bilayer thickness better than 0.1 nm, used for x-ray or EUV optics.**
 - Bernstorff S., Holý V., Endres J., Valeš V., Sobota J., Siketić Z., Bogdanović-Radović I., Buljan M., Dražić G.: *Co nanocrystals in amorphous multilayers—a structure study*, Journal of Applied Crystallography, 2013, 46(6), pp. 1711–1721.
 - Schmidt J., Kolářek K., Štraus J., Frolov O., Prukner V., Melich R., Psota P., Sobota J., Fořt T.: *Reflectivity of a mirror in XUV spectral region (46.9 nm)*, Proceedings of the 3rd IW FX & XUVOA, Prague, 2017, O-05.
- Deposition of thin films for electrochemical sensors.**
 - Sbartai A., Namour F., Barbier F., Krejčí J., Kučerová R., Krejčí T., Neděla V., Sobota J., Jaffrezic-Renault N.: *Electrochemical Performances of Diamond Like Carbon Films for Pb(II) Detection in Tap Water Using Differential Pulse Anodic Stripping Voltammetry Technique*, Sensor Letters, 2013, 11(8), pp. 1524–1529.
- Deposition of thin films for electron microscopy.**
 - Konvalina, I.; Paták, A.; Zouhar, M.; Müllerová, I.; Fořt, T.; Unčovský, M.; Materna Mikmeková, E.: *Quantification of STEM Images in High Resolution SEM for Segmented and Pixelated Detectors*. Nanomaterials 2022, 12, 71.
- Deposition of films with exactly defined thickness for plasmonics.**
 - Hlubina P., Gryga M., Ciprian D., Pokorný P., Gembalová L., Sobota J.: *High performance liquid analyte sensing based on Bloch surface wave resonances in the spectral domain*, Optics and Laser Technology, 2022, 145.
- Deposition of thin films for low-temperature physics.**
 - Musilová V., Králík T., Fořt T., Macek M.: *Strong suppression of near-field radiative heat transfer by superconductivity in NbN*, Physical Review B, 2019, 99(2), 024511.
- Deposition of thin films with an exactly defined thickness for interferometry and metrology.**
 - Pikálek T.; Fořt T.; Buchta Z.: *Detection techniques in low-coherence interferometry and their impact on overall measurement accuracy*, Applied Optics, 2014, 53(36), pp. 8463–8470.
- Deposition and study of nanocomposite and carbon-based wear-resistant films for industry.**
 - Sobota J.; Grossman J.; Buršíková V.; Dupák L.; Vyskočil J.: *Evaluation of hardness, tribological behaviour and impact load of carbon-based hard composite coatings exposed to the influence of humidity*, Diamond and Related Materials, 2011, 20(4), pp. 596-599.
- Investigation of the response of materials to the repeated dynamic impact using dynamic impact tester; analyses of impact wear and impact lifetime of various types of coated specimens (e.g. PVD films, HVOF coatings, HVOF coatings, etc.) and bulk materials.**
 - Daniel J., Žemlička R., Grossman J., Luemkemann A., Tapp P., Galamand C., Fořt T.: *Comparison of Lifetime of the PVD Coatings in Laboratory Dynamic Impact Test and Industrial Fine Blanking Process*, Materials, 2020, 13(9), 2154.
 - Daniel J., Grossman J., Houdková Š., Bystrianský M.: *Impact Wear of the Protective Cr₃C₂-Based HVOF-Sprayed Coatings*, Materials, 2020, 13(9), 2132.



Cross section of the Si/C multilayer on silicon substrate



Impact tester in chamber with controlled atmosphere

Impact crater displayed by laser confocal microscope.

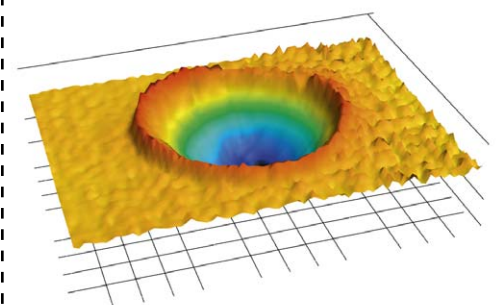

MAIN COLLABORATING PARTNERS

Collaboration with academic partners

- Masaryk University (Brno, CZ)
- Institute of Physics of Materials of the ASCR, v.v.i. (Brno, CZ)
- University of West Bohemia (Plzeň, CZ)
- Institute of Physics of the ASCR, v.v.i. (Praha, CZ)
- Institute of Photonics and Electronics (Praha, CZ)
- Czech Technical University in Praha (Praha, CZ)
- Charles University (Praha, CZ)
- Institute of Plasma Physics (Praha, CZ)
- Tomas Bata University (Zlín, CZ)
- PALS – Prague asterix laser system (Praha, CZ)
- The University of Sheffield (Sheffield, UK)
- Aristoteles University of Thessaloniki, (Thessaloniki, Greece)

Collaboration with companies

- Solartec s.r.o. (Rožnov pod Radhoštěm, CZ)
- HVM Plasma Ltd. (Praha, CZ)
- Rigaku Innovative Technologies Europe, s.r.o. (Praha, CZ)
- Czech Metrology Institute (Brno, CZ)
- VUHZ a.s. (Dobrá, CZ)
- Research and Testing Institute (Plzeň, CZ)

EXPECTATIONS

Offers

We offer collaboration in the areas of our expertise. Deposition of thin films and multilayers with exactly defined thickness from various materials. Deposition and development of new types of nanostructured thin films for optics, x-ray and EUV optics, sensors, plasmonics, metrology, mechanical engineering and industry, etc. Testing of impact wear and impact lifetime of various types of coated specimens and bulk materials. We also offer a partnership in international projects.

Requirements

We look for cooperation with academic partners as well as companies in the fields of EUV and x-ray optics, deposition of thin films and dynamic impact testing of coated specimens and bulk materials.

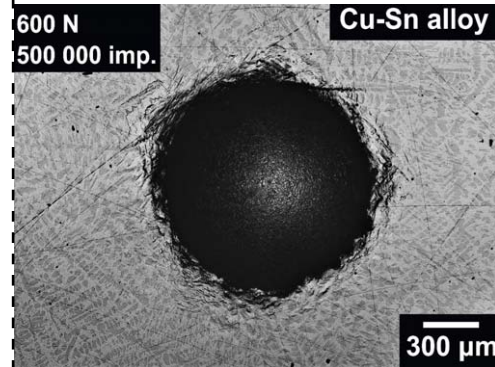

Example of impact crater on the Cu-Sn alloy.

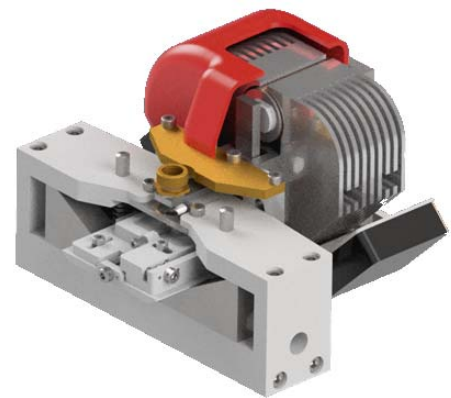

New prototype impact tester.



Computer controlled magnetron sputtering system Aurion

Group of Electron Beam Lithography (EBL)

Department of Electron and Plasma Technologies



Institute of Scientific Instruments
of the CAS, v. v. i.

The Czech Academy of Sciences
Královopolská 147, 612 64 Brno,
Czech Republic
www.isibrno.cz
<http://ebl.isibrno.cz/>

Head: Assoc. Prof. Vladimír Kolařík
Phone: +420 541 514 400
E-mail: vladimir.kolarik@isibrno.cz

Expert: Dr. Milan Matějka
Phone: +420 541 514 221
E-mail: mmatejka@isibrno.cz

THEMATIC RESEARCH FOCUS

Research area

- Electron beam lithography (EBL)
- Diffractive optically variable image devices (DOVIDs)

Excellence

- Planar relief micro and nano structures on silicon wafers and glass masks
- Laser beam shaping by computer generated holograms (CGH)
- Diffractive optically variable image devices (DOVIDs)
- Masks for photo and UV lithography and special purposes

Mission

To be highly specialized EBL team with focus on relief and multilevel structures for large range of particular applications

UP-TO-DATE ACTIVITIES

Research orientation

- Theoretical and experimental activities related to the e–beam lithography writing process (electron emitter preparation and characterization, current density distribution, benchmarking patterns, proximity effect correction, writing strategies, sequencing, partitioning)
- Theoretical and experimental activity in the field of technologies related to e–beam nanopatterning (coating process, resist development, etching techniques, evaluation methodology, technology of nano structured nitride membranes)
- Diffractive structures (gratings, Fourier and Fresnel structures, DOVIDs, laser beam shaping)
- Micro-sensors and microscopy calibration specimens

Main capabilities

Basic research

- Study and evaluation of electron scattering effects, simulation and correction algorithms
- Experimental activities related to electron emitter preparation and characterisation
- Calculation and optimization of computer generated holograms (CGH)

Applied research

- Phase and amplitude computer generated hologram structures
- Diffractive optically variable image devices
- Electrochemical and biological sensors
- MMS and MEMS, e.g. micro and nano structured free standing nitride membranes

Sub-fields of group activities

- Scanning electron microscopy – calibration samples
- Optical microscopy – resolution and calibration samples
- Microtechnology, nanotechnology
- Laser beam shaping and splitting



EBPG data testing pattern.

KEY RESEARCH EQUIPMENT

List of devices

- E-beam writer (pattern generator) with shaped beam Tesla BS600: electron energy 15 keV, field deflection up to 3 mm × 3 mm, resolution 50 nm, rectangular stamp size range 50–6300 nm (standard mode), 17–2100 nm (TZ mode), writing speed > 1 cm² / hour (stamp size 1 μm × 1 μm, area filling factor 50 %)
- E-beam writer with Gaussian beam Vistec EBP5000plusES: electron energy 50 or 100 keV, field deflection up to 0.25 mm × 0.25 mm, resolution 8 nm, beam size down to 2 nm, writing speed up to 1 cm² / hour (at beam step size 50 nm and area filling factor 50 %)

ACHIEVEMENTS

- **We deepened the methodology of e-beam lithography process using both the pattern generators as well as their combination. We also tuned up the technology processes with results useful in numerous application domains. Within the period 2012–2020 we published over 100 contributions in conference proceedings and journals. Within the same period we performed over 1597 e-beam exposure runs.**
- **Sharp tungsten tips are produced using an automated electrochemical etching set-up. Tips can then be used to operate as pure field emitters or to operate in thermal-field/ Schottky mode when they get additionally coated by oxide. Other applications of ultra-sharp tips (tip diameter < 100 nm) include the usage as STM probes or nanomanipulators. The tunneling tip performance can be analyzed using current-voltage characteristics, the Murphy-Good analysis, by emission pattern observation, by measuring fluctuations and the stability of the electron beam. The activation of uncoated tips and testing of the thermal-field emitters (or of Schottky emitters) can be done in situ, within our field emission microscope.**
- A. Knápek et al.: "Programmable set-up for electrochemical preparation of STM tips and ultra-sharp field emission cathodes", *Microelectronic Engineering*, 2017, 173: 42–47
- A. Knápek et al.: "Polymer graphite pencil lead as a cheap alternative for classic conductive SPM probes." *Nanomaterials*, 2019, 9.12: 1756.
- A. Knápek et al.: "Fluctuations of focused electron beam in a conventional SEM." *Ultramicroscopy*, 2019, 204: 49–54.

Field-emission microscope: ultra-high vacuum system for development and testing of single-crystal and alternative electron emitters.

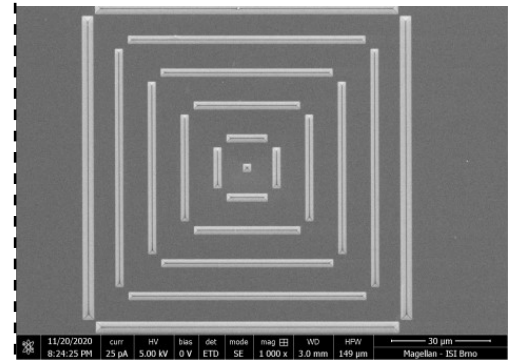
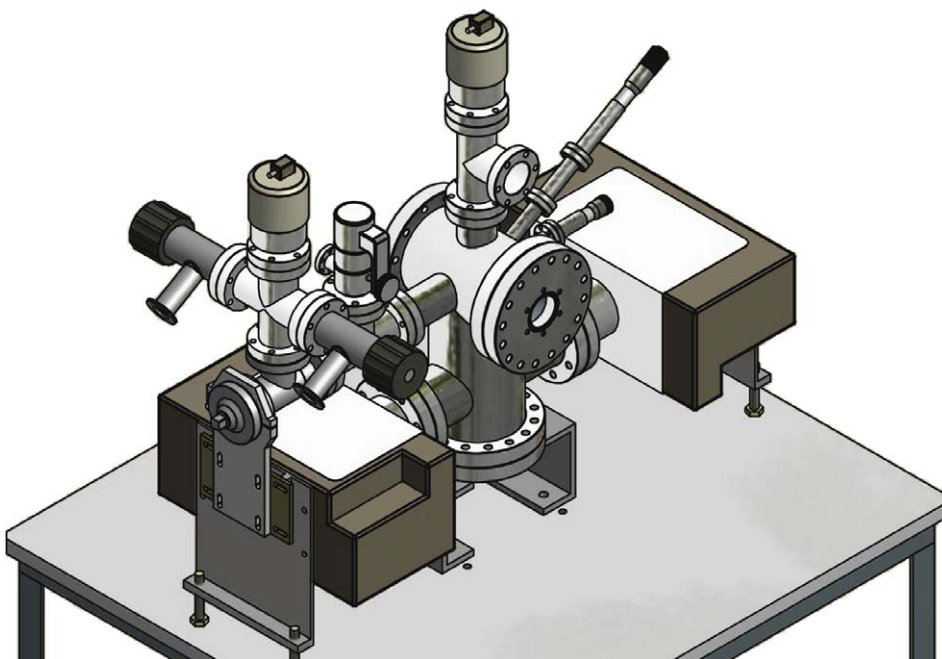

μSCALE calibration sample for SEM.

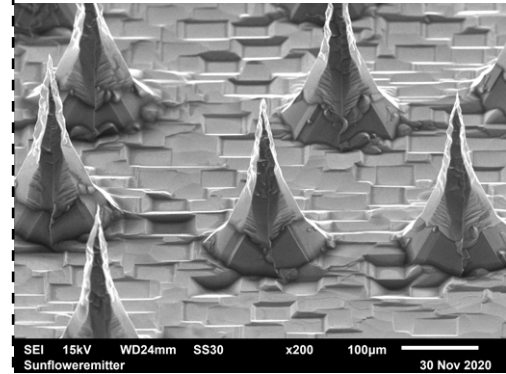

Non-orthogonally oriented field emission array made by direct laser nanostructuring in collaboration with OTH Regensburg.

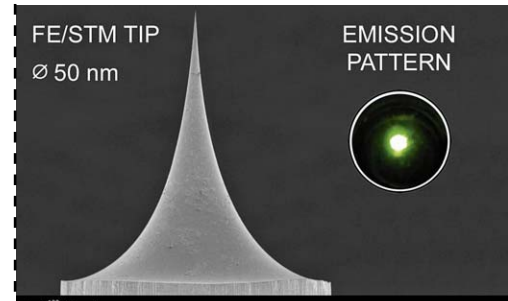

Electrochemically etched micro/nano tungsten wire with controllable tip profile for the field emission cathodes and SPM probes applications.

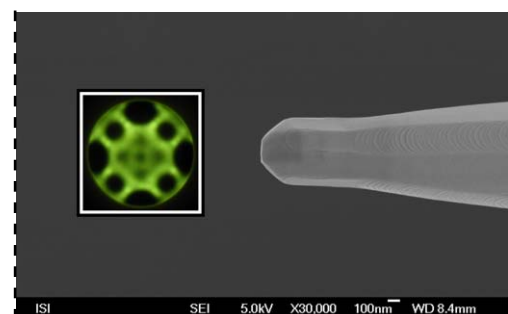

ZrO coated <100> oriented tip in thermal-field emission mode.

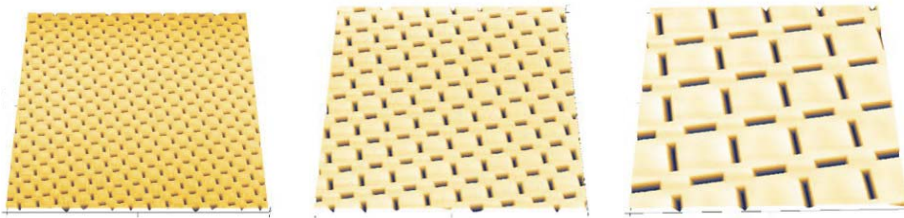

μ SCALE calibration sample for SEM. Grid image with a line period of 3 μ m (left), 5 μ m (middle), 10 μ m (right). AFM images.

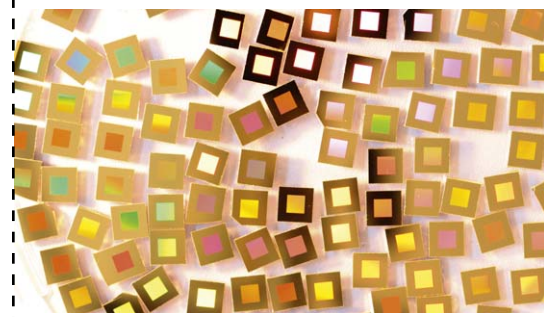

Specimens for Raman spectroscopy — etched silicon with Au nano-islands.

Recent publications

- M. Horáček, V. Kolařík: "Optically Variable Image Devices and method of preparing the same". Patent specification 306 956., 2017
- M. Matějka, S. Krátký, T. Řiháček, A. Knápek, V. Kolařík: "Functional nano-structuring of thin silicon nitride membranes". Journal of Electrical Engineering 2020, 71(2)
- M. Saqib, J. Jelenc, L. Pirker, S. D. Škapin, L. De Pietro, U. Ramsperger, A. Knápek, I. Müllerová, M. Remškar: "Field emission properties of single crystalline W5O14 and W18O49 nanowires". Journal of Electron Spectroscopy and Related Phenomena. 2020, 241(MAY)
- A. Knápek, J. Šikula, M. Bartlová: "Fluctuations of focused electron beam in a conventional SEM". Ultramicroscopy. 2019, 204(SEP)
- Z. Pilát, M. Kizovský, J. Ježek, S. Krátký, J. Sobota, M. Šiler, O. Samek, T. Buryška, P. Vaňáček, J. Damborský, Z. Prokop, P. Zemánek: "Detection of chloroalkanes by surface-enhanced raman spectroscopy in microfluidic chips". Sensors. 2018, 18(10)
- D. Sobola, S. Ramazanov, M. Konečný, F. Orudzhev, P. Kaspar, N. Papež, A. Knápek, M. Potoček: "Complementary SEMAFM of Swelling Bi-Fe-O Film on HOPG Substrate." Materials. 2020, 10(13)
- K. J. Abrams, M. Dapor, N. Stehling, M. Azzolini, S. J. Kyle, J. S. Schäfer, A. Quade, F. Mika, S. Krátký, Z. Pokorná, I. Konvalina, D. Mehta, K. Black, C. Rodenburg: "Making Sense of Complex Carbon and Metal/Carbon Systems by Secondary Electron Hyperspectral Imaging." Advanced Science. 2019, 6(19)
- A. Al Soud, A. Knápek, M. S. Mousa: "Analysis of the Various Effects of Coating W Tips with Dielectric Epoxylite 478 Resin or UPR-4 Resin Coatings under Similar Operational Conditions." Jordan Journal of Physics. 2020, 13(3)
- S. Krátký, V. Kolařík, M. Horáček, P. Meluzín, S. Král: "Combined e-beam lithography using different energies." Microelectronic Engineering. 2017, 177(JUN)
- A. Knápek, D. Sobola, D. Burda, A. Daňhel, M. Mousa, V. Kolařík: "Polymer Graphite Pencil Lead as a Cheap Alternative for Classic Conductive SPM Probes." Nanomaterials. 2019, 9(12)
- S. Ramazanov, D. Sobola, F. Orudzhev, A. Knápek, J. Polčák, M. Potoček, P. Kašpar, R. Dallaev: "Surface Modification and Enhancement of Ferromagnetism in BiFeO3 Nanofilms Deposited on HOPG." Nanomaterials. 2020, 10(10)
- P. Kaspar, D. Sobola, K. Částková, A. Knápek, D. Burda, F. Orudzhev, R. Dallaev, P. Tofel, T. Trčka, L. Grmela, Z. Hadaš: "Characterization of Polyvinylidene Fluoride (PVDF) Electrospun Fibers Doped by Carbon Flakes." Polymers. 2020, 12(NOV)
- A. Knápek, R. Dallaev, D. Burda, D. Sobola, M. M. Allaham, M. Horáček, P. Kaspar, M. Matějka, M. S. Mousa: "Field Emission Properties of Polymer Graphite Tips Prepared by Membrane Electrochemical Etching." Nanomaterials. 2020, 10(7)

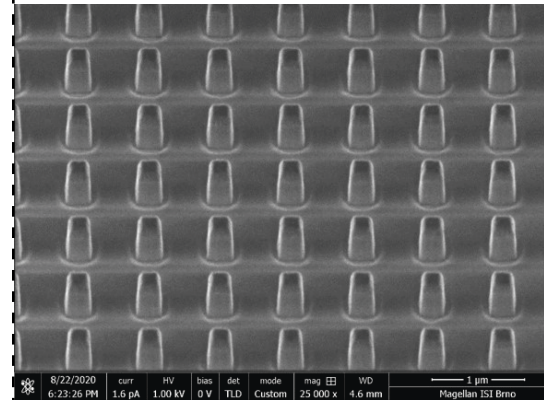

Pillar light guide structures etched in a thin layer of SiO₂ on a YAG:Ce substrate.

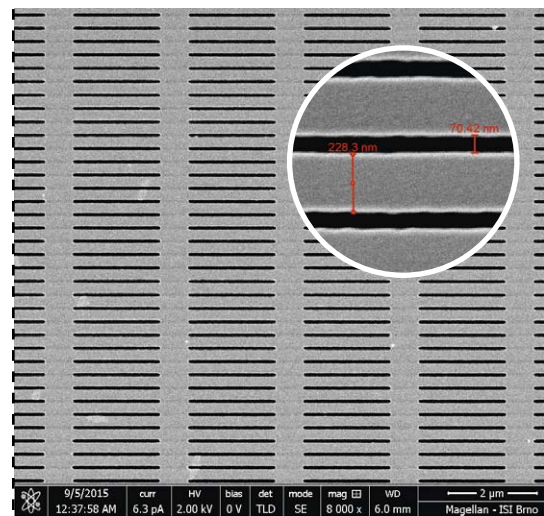

SEM image of the final holey grating structure fabricated in the thin silicon nitride membrane. Size of the rectangle shape opening in the membrane is 70 × 2000 nm.



Example of a security hologram pattern in the layer of PMMA resist (left) and acrylic glass (right) specimens.

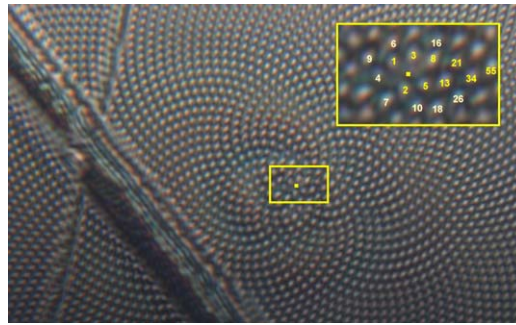

Diffractive Optical Variable Image Device (DOVID) using phyllotaxy arrangement. Real photo (left), light microscope image (right).

MAIN COLLABORATING PARTNERS

Collaboration with academic partners

- Brno University of Technology (Brno, CZ)
- CEITEC (Brno, CZ)
- Czech Technical University in Prague (CZ)
- Institut NEEL (Grenoble, FR)
- Institute of Informatics SAV (Bratislava, SK)
- Institute of Thermomechanics CAS (Praha, CZ)
- Karlsruher Institut für Technologie (Karlsruhe, DE)
- Masaryk University (Brno, CZ)
- Mu'tah University (Al-Karak, JO)
- Ostbayerische Technische Hochschule (Regensburg, DE)
- Tomas Bata University in Zlín, Centre of Polymer Systems (Zlín, CZ)
- University Olomouc (Olomouc, CZ)

Collaboration with companies

- Crytur, s.r.o. (Turnov, CZ)
- Czech Metrology Institute (Brno, CZ)
- DeLong Instruments (Brno, CZ)
- IQS Group holding (Řež u Prahy, CZ)
- Meopta - optika, s. r. o. (Přerov, CZ)
- Nenovision, s.r.o. (Brno, CZ)
- NETWORK Group, s.r.o. (Brno, CZ)
- TESCAN Brno, s.r.o. (Brno, CZ)
- Thermofisher Scientific (Brno, CZ)

EXPECTATIONS

Offers

We offer collaboration in the areas of our expertise. Custom development and manufacturing of particular planar microstructures and nanostructures, e.g. optical focusing / splitting / beam shaping elements, photolithography masks, dimension and material calibration samples for microscopy.

Requirements

We look for cooperation with academic partners as well as application partners in the fields of lithography and complementary techniques, microtechnologies, nanotechnologies, applications of planar nanostructures.

Samples of Diffractive optically variable image devices based on deterministic aperiodic mesh of nano-pillars and/or nano-holes.

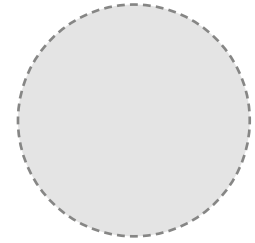

Complex diffractive structure: CGH structures, diffraction gratings and phyllotactic spiral gratings.

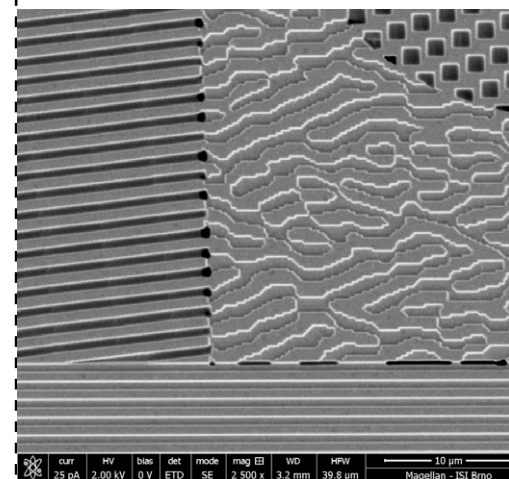

Group of Magnetic Resonance (MR)

Department of Magnetic Resonance and Cryogenics



Institute of Scientific
Instruments
The Czech Academy
of Sciences

THEMATIC RESEARCH FOCUS

Research areas

- Customization and development of methods and applications of ultra-high-field magnetic resonance imaging and spectroscopy of small laboratory animals (mouse, rat, rabbit), excised organs, and in vitro samples for selected areas of multidisciplinary research.
- Quantitative MR imaging of relaxation, diffusion, perfusion, blood flow, metabolites, water/fat:
 - perfusion measurement, mathematical modelling of pharmacokinetics,
 - MR spectroscopic data analysis, MR physics simulation for metabolite quantitation and method development.

Excellence

- In vivo MR spectroscopy – computer simulation of NMR dynamics of coupled spin systems
- In vivo MR measurement of perfusion, and pharmacokinetics modelling

Mission

- Transform own research in MR physics and related areas into progress in quantitative MR imaging and spectroscopy – transform the prevailing MR paradigm of marker detection into quantitative, robust, accurate and precise measurement of well-defined biophysical, biochemical or physiological properties, whose potential of interinstitutional transferability will support biomedical research and development and medical diagnostics and will contribute to better understanding of pathophysiological processes.
- Provide MR measurements implementing the goals stated above, including adequate animal services, to external research and development clients under the framework of large research infrastructures Czech-Biolmaging and Euro-Biolmaging, and to contribute to the establishment of high-quality standards in these consortia.

UP-TO-DATE ACTIVITIES

Research focus

- MR-data quality improvement by
 - artefact avoidance and quality-assurance filtering of raw data
 - advanced data modelling, robust estimation of model parameters
- Experimental and data-analysis techniques for quantitative MR imaging and spectroscopy – hierarchical data modelling of MR physics and physiology:
 - perfusion measurement protocols, data analysis algorithms for pharmacokinetics modelling, development of web-based perfusion analysis software PerfLab
 - spectroscopy protocols, development of program NMRScopeB for quantum-mechanical simulation, and collaborative improvement of quantitation software jMRUI
- Exploration of the potential of synergies of multiparametric/multimodal imaging
- Method optimization with regard to animal measurement constraints and economics. Extending the current MR spectroscopic simulation possibilities of program NMRScopeB to more complex experiments and improving the utility of

Institute of Scientific Instruments
of the CAS, v. v. i.

Czech Academy of Sciences

Královopolská 147, 612 64 Brno,
Czech Republic

<http://www.isibrno.cz/mr>

Head: Zenon Starčuk jr.

Phone: +420 739 451 114

E-mail: starcuk@isibrno.cz



Biomedical 9.4T MR scanner equipped for
mouse, rat and rabbit imaging

the current quantitation software jMRUI, based on users' feedback, own testing and using modern computer technology

- Development of perfusion measurement protocols, pharmacokinetic models and data analysis algorithms based on own validation experiments, and development of web-based perfusion analysis software PerfLab

Main capabilities

Basic research

- Development of customized MR protocols (sample preparation, MR measurement, data analysis)
- MR data analysis for the measurement of relaxation, diffusion, perfusion, spectroscopy
- Pulse sequence design and analysis by computer simulation of spin system evolution
- Validation of measurement protocols and data analysis by phantom studies

Applied research

- Support for studies in pathophysiology, development of diagnostics, therapeutic procedures and drugs in translational research in oncology, neurology, cardiology or regenerative medicine by multiparametric MR examinations of small laboratory animals
- Testing of experimental molecule or nanoparticle-based carriers for targeted delivery of imaging markers and drugs by relaxometric in vitro and multiparametric in vivo MR imaging
- Support for plant research, study of the properties of technical and natural gels (e.g. for geology or industries), characterization of porous materials

Sub-fields of group activities

- Biomedical research - (patho)physiology, diagnostics, therapy monitoring
- Nanotechnologies for (bio)medicine
- Pharmaceuticals
- Processes in natural and industrial gels



Rack for individually ventilated cages for accommodation of mice

KEY RESEARCH EQUIPMENT

List of devices

- MR scanner 9.4T/30cm Bruker Avance III 94/30 (¹H 400 MHz), 200 mT/m gradients, 660 mT/m gradient insert for microimaging, multinuclear equipment (³¹P, ¹³C, ¹⁹F, ²³Na, ¹²⁹Xe), RF coils for mouse/rat/rabbit measurement, 2 transmit, 4 receive channels, software ParaVision 5.1 and 6.0.1
- general anesthesia (isoflurane, N₂O), vital function monitor SAI 1030, artificial ventilation, animal bed heating
- minisurgery room

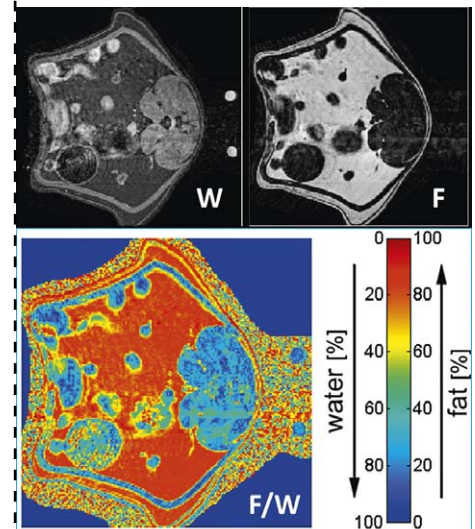

Quantification of water and fat fractions in the mouse body

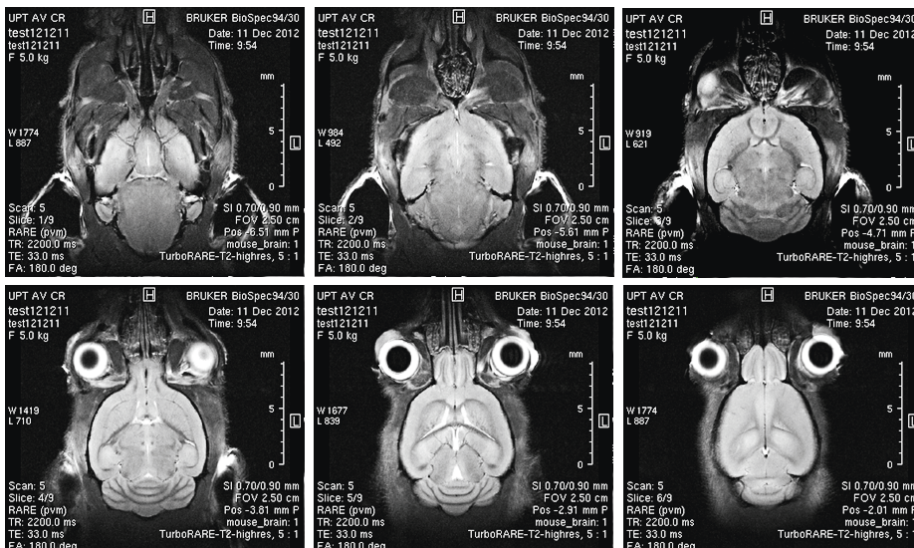

Anatomical T₂ weighted images of a mouse brain

- animal facility for about 200 mice and 100 rats with overpressure and EU14 filtration, animals in individually ventilated cages, hygienic loop, autoclave, UV sterilization chamber, laminar flow boxes for animal handling, minisurgery room
- wet lab with fume chamber, deep freezer (-80°C), cadaver freezer
- MR scanner 4.7T/20cm with magnet Magnex Sci. Ltd., console and electronics MR Solutions MR6000, 1kW RF amplifier CPCamps 5T1000M, gradients 180 mT/m, Gz insert 1000 mT/m

ACHIEVEMENTS

- **Ultra-short echo-time spectroscopic techniques exhibiting particularly robust water suppression and low contamination, developed in ISI long ago, have become a worldwide standard and make it possible to reliably determine more than 20 metabolites in brain MR spectra.**

- I. Tkáč, Z. Starčuk, I.-Y. Choi, R. Gruetter: "In Vivo 1H NMR Spectroscopy of Rat Brain at 1 ms Echo Time", *Magnetic Resonance in Medicine* **41**, 649–656, 1999

- **A simulator of coupled spin systems undergoing relaxation and spatially/frequentially-inhomogeneous excitation (NMRScopeB) has been developed and integrated into jMRUI software, used at over 2500 institutions worldwide.**

- D. Stefan, F. Di Cesare, A. Andrasescu, E. Popa, A. Lazariiev, E. Vescovo, O. Strbak, S. Williams, Z. Starčuk, M. Cabanas, D. van Ormondt, D. Graveron-Demilly:

"Quantitation of magnetic resonance spectroscopy signals: the jMRUI software package", *Meas. Sci. Technol.* **20**, 104035, 9p., 2009

- Z. Starčuk, J. Starčuková: "Quantum-mechanical simulations for in vivo MR spectroscopy: principles and possibilities demonstrated with the program NMR-ScopeB", *Analytical Biochemistry* **529**, 79–97, 2017

- **Techniques or protocols for accurate measurement of material properties (magnetic susceptibility, relaxivity) have been developed and applied in practical studies.**

- J. Tuček, Z. Sofer, D. Bouša, M. Pumera, K. Holá, A. Malá, K. Poláková, M. Havrdová, K. Čepe, O. Tomanec, R. Zbořil: "Air-stable superparamagnetic metal nanoparticles entrapped in graphene oxide matrix", *Nature Communications* **7**, DOI: 10.1038/ncomms12879, 2016

- J. Starčuková, Z. Starčuk, H. Hubálková, I. Linetskiy: "Magnetic susceptibility and electrical conductivity of metallic dental materials and their impact on MR imaging artifacts", *Dental materials* **24**, 715–723, 2008

- R. Kořínek, J. Vondrák, K. Bartušek, M. Sedlaříková: "Experimental investigations of relaxation times of gel electrolytes during polymerization by MR methods", *J. Solid State Electrochem* DOI 10.1007/s10008-012-1715-6, 2012

- **Models and algorithms have been developed for the analysis of perfusion based on MR measurement in animals and humans. This development aids the diagnostics, therapy development, and basic research of pathophysiology.**

- M. Bartoš, R. Jiřík, J. Kratochvíla, M. Standara, Z. Starčuk, T. Taxt: "The precision of DCE-MRI using the tissue homogeneity model with continuous formulation of the perfusion parameters", *Magnetic Resonance Imaging* **32**, 505-513, 2014

- J. Kratochvíla, R. Jiřík, M. Bartoš, M. Standara, Z. Starčuk, T. Taxt: "Distributed capillary adiabatic tissue homogeneity model in parametric multi-channel blind AIF estimation using DCE-MRI", *Magnetic Resonance in Medicine* **75**, 1355-1365, 2016

- E. Eskilsson, G.V. Rosland, K.M. Talasila, S. Knappskog, O. Keunen, A. Sottoriva, S. Foerster, G. Solecki, T. Taxt, R. Jiřík, S. Fritah, P. N. Harter, K. Vålk, J. Al Hossein, J. V. Joseph, R. Jahedi, H. S. Saed, S. G. Piccirillo, I. Spiteri, P. Euskirchen, G. Graziani, T. Daubon, M. Lund-Johansen, P. Ø. Enger, F. Winkler, C. A. Ritter, S. P. Niclou, C. Watts, R. Bjerkvig, H. Miletic: "EGFRVIII mutations can emerge as late

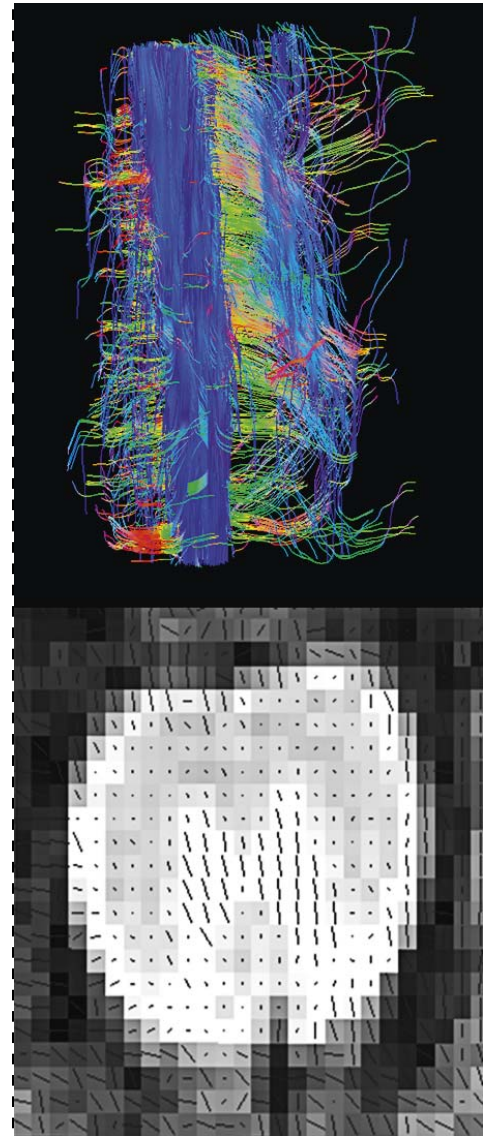

Neuronal fibre tracking based on diffusion tensor imaging in rat spinal cord

and heterogenous events in glioblastoma development and promote angiogenesis through Src activation”, Neuro-Oncology DOI: 10.1093/neuonc/now113, 2016

■ Diffusion measurement has been applied in the search for potential early-stage markers of Parkinson’s disease

- A. Khairnar, P. Latta, E. Dražanová, J. Rudá-Kučerová, N. Szabó, A. Arab, B. Hutter-Paier, D. Havas, M. Windisch, A. Šulcová, Z. Starčuk, I. Rektorová: “Diffusion Kurtosis Imaging Detects Microstructural Alterations in Brain of α -Synuclein Overexpressing Transgenic Mouse Model of Parkinson’s Disease: A Pilot Study”, Neurotoxicity Research **28**, 281–289, 2015
- A. Khairnar, J. Rudá-Kučerová, E. Dražanová, N. Szabó, P. Latta, A. Arab, B. Hutter-Paier, D. Havas, M. Windisch, A. Šulcová, Z. Starčuk, A. Király, I. Rektorová: “Late-stage α -synuclein accumulation in TNWT-61 mouse model of Parkinson’s disease detected by diffusion kurtosis imaging”, Journal of Neurochemistry **136**, 1256–1269, 2016

MAIN COLLABORATING PARTNERS

Collaboration with academic partners

- Masarykova univerzita (Brno, CZ), Vysoké učení technické (Brno, CZ), Fakultní nemocnice u sv. Anny – ICRC (Brno, CZ), Biofyzikální ústav AV ČR (Brno, CZ), Univerzita Palackého (Olomouc, CZ), Veterinární a farmaceutická univerzita (Brno, CZ), Ústav makromolekulární chemie AV ČR (Praha, CZ), Ústav živočišné fyziologie a genetiky AV ČR (Brno, CZ), Ústav molekulární genetiky AV ČR (Praha, CZ), Výzkumný ústav veterinárního lékařství (Brno, CZ)
- Katholieke Universiteit Leuven (Leuven, BE), Ecole Polytechnique Fédérale de Lausanne (Lausanne, CH), Université Claude Bernard Lyon 1 (Lyon, FR), University of Manchester (Manchester, UK), Max Planck Institute for Human Cognitive and Brain Sciences (Leipzig, DE), Radboud University Nijmegen Medical Centre (Nijmegen, NL), Universitat Autònoma de Barcelona (Barcelona, ES), Universitat de Barcelona (Barcelona, ES), University of Bern (Bern, CH), University of Bergen (Bergen, NO)

Collaboration with companies

- Philips Healthcare (Nijmegen, NL), Siemens Healthcare (Erlangen, DE), GE Healthcare (USA), icoMetrix (Leuven, BE)

EXPECTATIONS

Offers

- Development and execution of MR measurement protocols and data analysis methods for specific applications (multiparametric testing of contrast agents, pharmacokinetics, pharmacodynamics, therapeutic procedures in animal models, characterization of gels or porous materials, MR imaging of small diamagnetic objects)
- Collaboration in development, preparation, validation of an animal model, assistance in animal use protocol preparation, arrangement of complementary examinations
- Open access via Czech-Biolmaging (www.isibrno.cz/czbi, www.czech-bioimaging.cz)

Requirements

- We seek scientifically interesting applications with societal impact on medicine or industry.
- We offer collaboration in MR technology development.

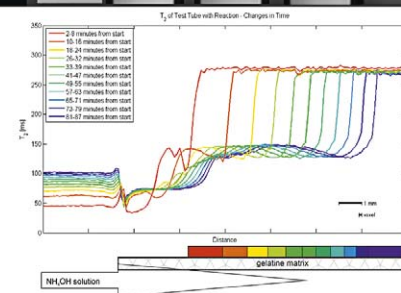
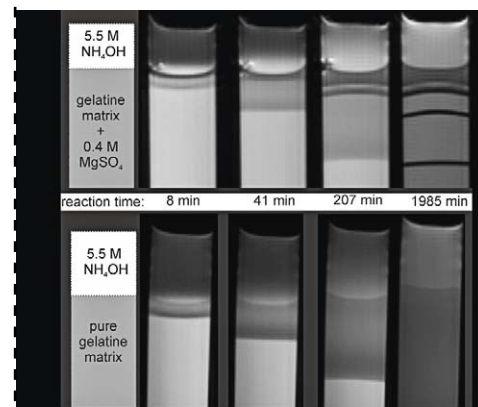

Dynamic study of the formation of Liesegang rings in a reaction-diffusion process in a gel modelling a natural geologic process; MR-observation of changes in T_2 relaxation

T_2 -weighted images of rat heart

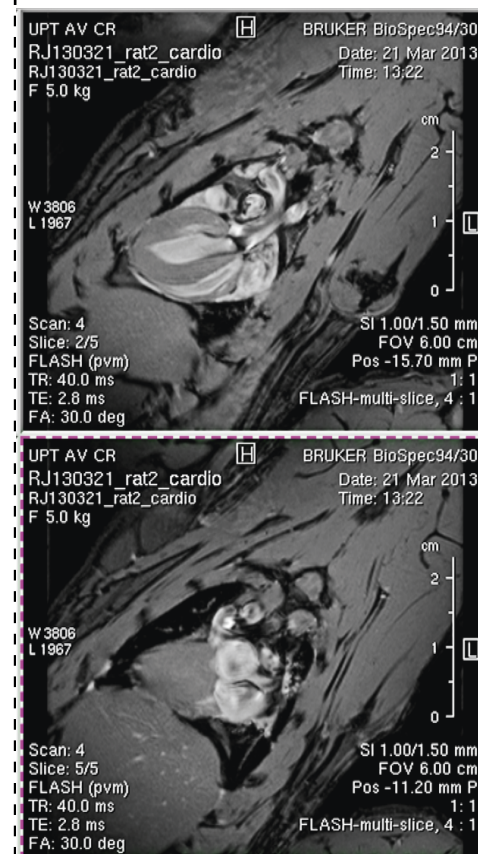

THEMATIC RESEARCH FOCUS

Research area

- Low temperature physics
- Cryogenics
- Thermal radiation and near field heat transfer
- Fluid dynamics, turbulence
- Quantum phase transitions
- Applied superconductivity

Excellence

- Basic research in fluid dynamics – Rayleigh-Bénard cryogenic convection
- Characterization of thermal radiative properties of materials for cryogenics and space applications
- Near field heat transfer at low temperatures
- Quantum phase transitions in mesoscopic systems
- Design and optimization of special cryogenic systems
- Design of special superconducting magnet systems

Mission

- Deeper understanding of turbulence – one of unsolved problems of modern physics on both classical and quantum levels
- Experimental verification of theory of near field heat transfer
- Expanding of our unique material database of thermal radiative properties and understanding how they are affected by surface topology and its treatment
- Analysing of thermal conductivity of insulating materials, especially those used in multilayer insulations
- Theoretical understanding of quantum phase transitions – structural changes in mesoscopic systems, like atomic nuclei, molecules and low-dimensional crystals at zero temperature

UP-TO-DATE ACTIVITIES

Research orientation

- Modelling of natural turbulent flows at stationary or rotating conditions and different boundary conditions (constant or harmonically modulated temperatures, constant heat flux) in table-top experiments using cryogenic helium within the paradigmatic model system – the Rayleigh-Bénard Convection (RBC). Study of heat and mass flows in two-phase 4He vapour-liquid RBC system
- Studying transitions between different regimes of classical RBC flows at extreme values of Rayleigh numbers, and determining respective heat transfer scaling laws
- Understanding connections between the classical and quantum turbulence via theoretical and experimental analyses of heat transfer laws
- Low temperature measurements of near field radiative heat transfer between metals beyond Planck's black-body limit. Effect of superconducting transition on the near field radiative heat transfer

a) Experimental cryostat developed at ISI Brno for studies of RBC in a very wide range of Rayleigh numbers

b) Schematic depiction of the He parts of the cryostat

c) Section through a 3D model of the existing cryogenic RBC cell

Institute of Scientific Instruments
 of the CAS, v. v. i.

The Czech Academy of Sciences

Královopolská 147, 612 64 Brno,
 Czech Republic

<http://www.isibrno.cz/en/cryogenics-and-superconductivity>

Head: Dr. Aleš Srnka

Phone: +420 541 514 264

E-mail: srnka@isibrno.cz

Expert: Dr. Pavel Urban

Phone: +420 541 514 269

E-mail: urban@isibrno.cz

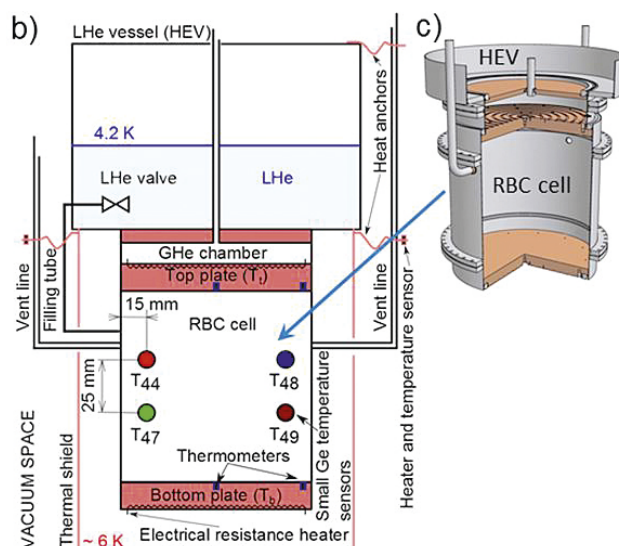

- Systematic measurements of cryogenic emissivities and absorptivities of various materials with primary focus of further developing our unique public database
- Developing group theoretical models to study collective dynamics in mesoscopic systems, which display quantum phase transitions

Main capabilities

Basic research

- Many systems found in Nature, like interiors of giant planets and, rapidly rotating stars, the Earth's outer liquid core, as well as open ocean deep convection are affected by thermal forcing and also by rotation. Stationary and rotating Rayleigh-Bénard convection (RBC) represents a universally recognized physical model used to study flows affected by both forces. The objective of our research is to measure and model the stationary and rotating RBC at extreme values of the control parameters, the Rayleigh (Ra) and the Ekman number (Ek) number. Our laboratory is equipped with a unique RBC apparatus with rotating platform, using cryogenic helium gas (5 K) as a working fluid, allowing to reach of the following dimensionless control parameters: $1E6 < Ra < 1E15$ and $1E-8 < Ek < 1E-5$
- Study of the near-field radiative heat transfer over a microscopic gap between various thin films including superconducting ones on dielectric substrates with variable temperatures (5 K–15 K for the colder sample and 9 K–60 K for the hotter sample). The results measured on plane parallel configuration are directly compared with present theory
- Collaboration with CERN on the cryogenic part of the project NA58 "COMPASS". Project studies hadron structure and spectroscopy via interactions between low temperature target and high intensity muon and hadron beams

Applied research

- Assessment of thermal emissivities and absorptivities of different surfaces that are essential for ground-based cryogenics and space applications, covering various materials and wide range of temperatures
- Design of special thermal insulation pads, characterized by low thermal conductance, high mechanical stiffness and small dimensions. These pads are used in UHV SEM/SPM microscopy as sample holders at variable temperatures (20–700 K)
- Design of flow cooling systems using cryogenic helium (5 K) or nitrogen (77 K) as a coolant. Systems consist of a flow cryostat and a flexible low-loss transfer line connecting a Dewar vessel with the flow cryostat
- Analysis of thermal conductivity performance of insulating materials under controlled conditions

Sub-fields of group activities

- Materials science (physical properties of materials for cryogenics and space)
- Two-phase cryogenic convection
- Special measuring instruments for cryogenics
- Low temperature thermometry
- Cryogenic safety

KEY RESEARCH EQUIPMENT

List of devices

- Helium cryostat for study of natural turbulent flows up to very high Rayleigh number about $Ra \sim 1E15$, utilizing the cryogenic helium gas (up to 3 bars) in a cylindrical (30 cm diameter and height, aspect ratio one) Rayleigh-Bénard cell
- Unique small helium bath cryopump made by the research team
- Helium liquefier L1410 (Linde Process Plants) with 500 l Dewar, 18 l of liquid helium per hour, complete helium recovery system for helium gas savings
- Helium Dewars with up to 50 mm neck diameter and 30–100 litre volumes
- Low temperature controllers Lakeshore (Model 340, 350, 372, 332, 218) for precise temperature measurement and control with different sensor types

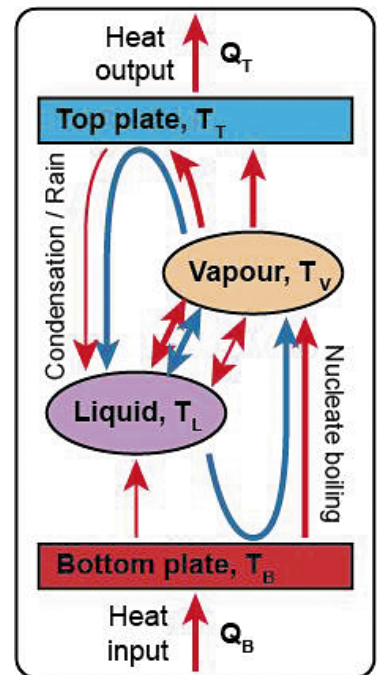

Schematic illustration of heat flows (red arrows) and mass flows (blue arrows) in two-phase He vapour-liquid system

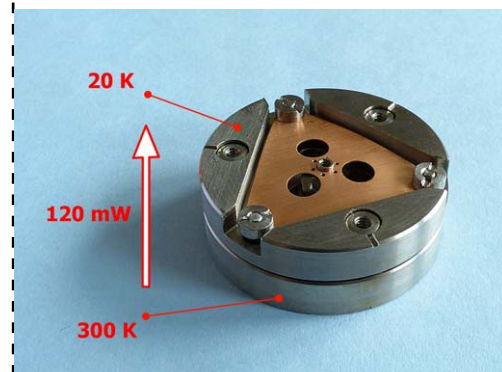

Thermal insulation pad (InBallPad)

- Helium leak detector ASM 310 (Adixen Vacuum Products)
- Mass spectrometer PrismaPlus (Pfeiffer Vacuum) up to mass number A=100
- Apparatuses for research of near-field and far-field radiative heat transfer made by the research team
- Thermal conductivity meter, made by the research team, for analysis of various insulating materials

ACHIEVEMENTS

We contributed to elucidation of the thermally driven turbulence processes and developed special cryogenic apparatuses for characterization of thermal radiative properties of materials at low temperatures. We published about 30 papers in impacted journals with very good citation response and about 25 contributions in conference proceedings or local journals in last five years. Our research results has had impact on the space research

For more details and publications see <http://www.isibrno.cz/en/cryogenics-and-superconductivity>

The most important results:

Ultimate state of turbulent natural convection/RBC

- P. Urban, P. Hanzelka, T. Králík, M. Macek, V. Musilová and L. Skrbek: "Elusive transition to the ultimate regime of turbulent Rayleigh-Bénard convection." *Physical Review E* **99**, 011101(R), 2019
- L. Skrbek, P. Urban: "Has the ultimate state of turbulent thermal convection been observed?," *J. Fluid Mech.* **785**, 270–282, 2015
- P. Urban, P. Hanzelka, T. Králík, V. Musilová, A. Srnka, L. Skrbek: "Reply: Effect of Boundary Layers Asymmetry on Heat Transfer Efficiency in Turbulent Rayleigh-Bénard Convection at Very High Rayleigh Numbers," *Phys. Rev. Lett.* **110**, 199402, 2013

Two-fluid convection

- P. Urban, D. Schmoranzer, P. Hanzelka, K. R. Sreenivasan, L. Skrbek: "Anomalous heat transport and condensation in convection of cryogenic helium," *Proc. Natl. Acad. Sci. USA* **110** (20), 8036–8039, 2013

Thermal insulation pad (InBallPad) for a sample holder of UHV SEM/SPM microscope

- P. Hanzelka, L. Dupák, V. Krutil, V. Krzyžánek, R. Skoupý, A. Srnka, I. Vlček, P. Urban: "Low conductive thermal insulation pad with high mechanical stiffness." *Int. Journal of Refrigeration* **132**, 92–99., 2021

Investigation of radiative heat transfer by near-field effect at low temperatures

- V. Musilová, T. Králík, T. Fořt, M. Macek: "Strong suppression of near-field radiative heat transfer by superconductivity in NbN." *Physical Review B* **99**, 024511, 2019

Emissivity and absorptivity at low temperatures

- T. Králík, V. Musilová, P. Hanzelka, J. Frolec: "Method for measurement of emissivity and absorptivity of highly reflective surfaces from 20 K to room temperatures," *Metrologia* **53**, 743–753, 2016
- J. Frolec, T. Králík, V. Musilová, P. Hanzelka, A. Srnka, J. Jelínek: "A database of metallic materials emissivities and absorptivities for cryogenics." *Cryogenics* **97**, 85–99, 2019

Thermal properties of spacers for multilayer insulation

- The unique apparatus for thermal characterization of materials used as spacers under precisely controlled compression was designed. Apparatus measures simultaneously heat transfer by conduction and radiation across sample

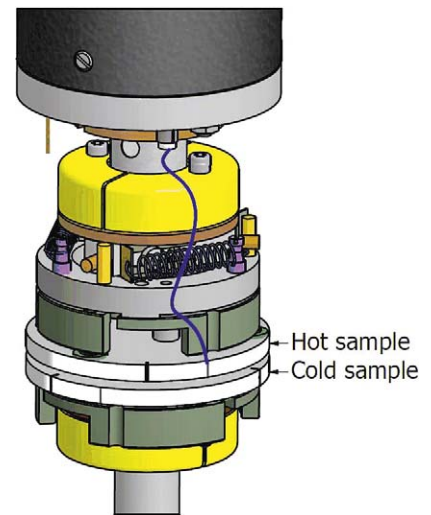

Schematic view of the apparatus for near-field heat transfer measurement

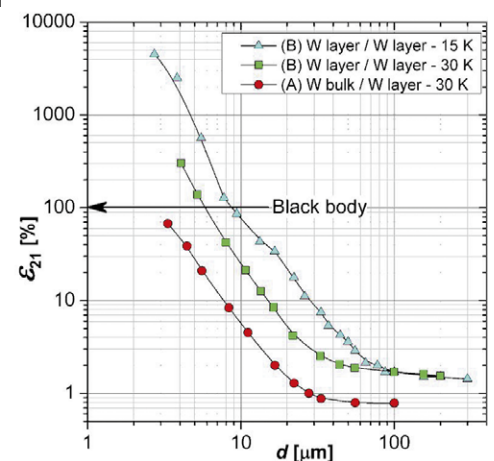

Example plot of normalized emissive power versus gap between samples

Opened chamber of the apparatus for measurement of thermal emissivities and absorptivities

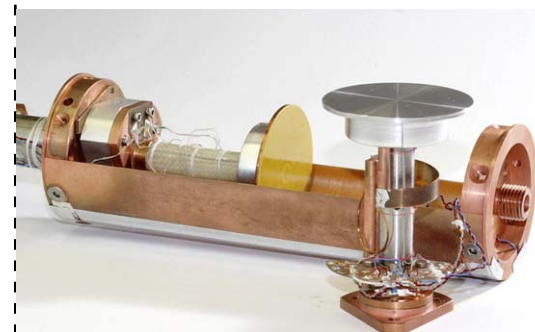

■ Unified theory of excited state quantum phase transitions in systems with low number of degrees of freedom:

- P. Cejnar, P. Stránský, M. Kloc, M. Macek: "Excited-state quantum phase transitions." Invited Review, Journal of Physics A: Mathematical and Theoretical **54**, 133001, 2021

MAIN COLLABORATING PARTNERS

Collaboration with academic partners

- CERN (Geneva, Switzerland)
- Technical University Ilmenau (Ilmenau, Germany)
- New York University (New York, USA)
- Yale University (New Haven, USA)
- Hebrew University (Jerusalem, Israel)
- Florida State University (Tallahassee, USA)
- Institut Néel CNRS/UGA (Grenoble, France)
- Charles University (Praha, CZ)
- Brno University of Technology (Brno, CZ)
- Masaryk University (Brno, CZ)
- Palacky University (Olomouc, CZ)

Collaboration with companies

- RUAG Space GmbH (Vienna, Austria)
- ESA's European Space Research and Technology Centre (Noordwijk, The NL)
- Frentech Aerospace s.r.o. (Brno, CZ)
- Chart Ferox, a.s. (Děčín, CZ)
- Thermo Fischer Scientific, s.r.o. (Brno, CZ)
- První brněnská strojírna, a.s. (Velká Bíteš, CZ)

EXPECTATIONS

Offers

We offer partnership in international projects and collaboration in the areas of our expertise, namely:

- Development, optimization and design of special cryogenic devices
- Calculation and measurement of parasitic heat flows at cryogenic temperatures
- Theoretical and experimental studies based on thermally driven cryogenic turbulence
- Measurements of low temperature properties of materials (electrical and thermal conductivities, emissivity and absorptivity of thermal radiation) in the range 4.2 – 320 K
- Cryogenic cooling systems, calculation of cooling capacities of different liquids and gases
- Low temperature measurement and its accuracy determination
- Vacuum in cryogenic systems
- Expertise in cryogenic safety, training in cryogenic safety

Requirements

We look for cooperation with academic partners as well as companies in the fields:

- Radiative heat transfer (metrology, standardization)
- Partners for EU research projects in the field of cryogenic helium turbulence
- Co-operative research and development of new materials for the thermal insulation of cryogenic systems
- Collaboration with industrial partners on common projects dedicated to applied science in the field of cryogenics (e.g. special cryogenic devices)

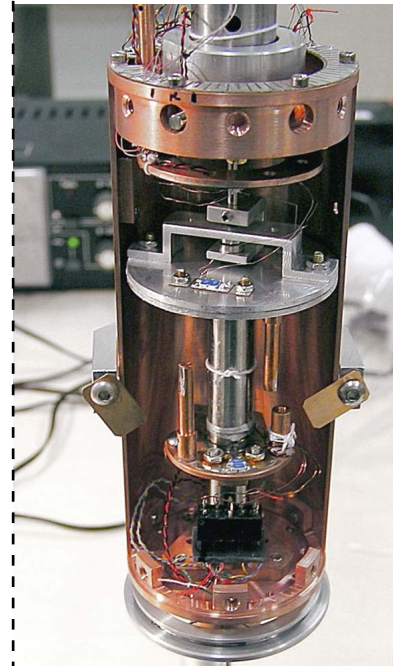

Sample sandwiched between two discs - hot radiator and cold absorber in the thermal conductivity meter

Examples of spacers installed on the absorber



HEMATIC RESEARCH FOCUS

Research area

- Biomedical engineering
- Signal processing methods
- Architectures of deep-learning models for ECG analysis
- Software design and development for real-time signal processing
- Cardiac electrophysiology
- Blood circulation control
- Advanced acquisition technologies

Excellence

- Blood circulation and hemodynamic control (stroke volume, pulse wave velocity, heart rate and blood pressure variability)
- Heart repolarization abnormalities identification
- Development of the novel acquisition technologies in cardiology (the multichannel whole-body bioimpedance monitor, PulseWave software, high frequency and dynamic ECG recorders)
- High frequency high dynamic range ECG for early diagnostics of heart pathologies
- New software solutions for large data visualization and processing – SignalPlant open access platform

Mission

To contribute to the development of novel diagnostic markers, technologies, protocols and analytical methods that will allow physicians to see more and that improve the quality of life

UP-TO-DATE ACTIVITIES

Research orientation

- Artificial intelligence in real-time and cloud signal processing
- Design and implementation of new technologies. Includes: high dynamic acquisition system, new software for the analysis of high frequency ECG, interpretation of results and diagnostic applications
- Analysis of time-spatial distribution of electrical heart activation
- Open access tools of large data visualization and processing

Main capabilities

Basic research

- Design and implementation of automated AI-powered server software for processing telemedicine data
- Distribution of high frequency components during ventricular depolarization period, detection of ventricular dyssynchrony in high temporal resolution
- Dynamic properties of blood circulation parameters

Institute of Scientific Instruments
of the ASCR, v.v.i.

Czech Academy of Sciences

Královopolská 147, 612 64 Brno,
Czech Republic
www.isibrno.cz

Head: Dr. Filip Plešinger

Phone: +420 541 514 518

E-mail: fplesinger@isibrno.cz

Expert: Dr. Pavel Jurak

Phone: +420 541 514 312

E-mail: jurak@isibrno.cz

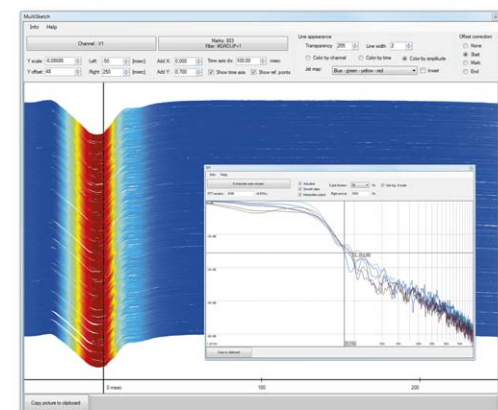
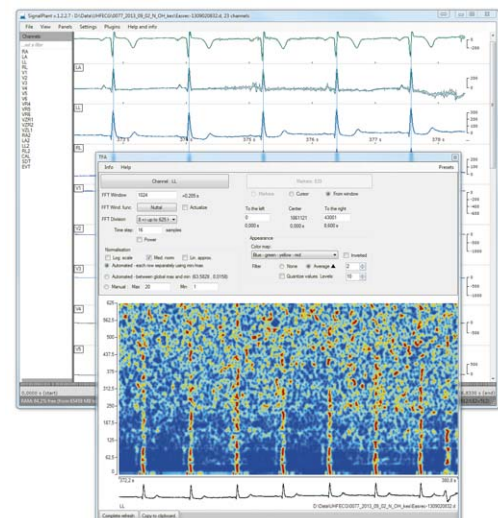

SignalPlant. SignalPlant is free software tool for signal examination, scoring and post-processing. Although it is originally aimed to biological signals, it contains tools useful for any other area of signal processing

Applied research

- Design and implementation of automated AI-powered server software for processing telemedicine data
- Development and realization of Multichannel PulseWave Monitor – medical device intended for novel non-invasive diagnostics of the state of the arterial system
- High frequency ECG monitor – experimental device for advanced acquisition of multi-lead high frequency and high dynamic electrocardiography
- High frequency ECG methods for identification of ventricular dyssynchrony (patent: <https://patents.google.com/patent/WO2015090260A3/en>)
- Cardiac pacing therapy optimization
- SignalPlant – free signal processing and visualization software tools (<https://signalplant.codeplex.com/>)

Sub-fields of group activities

- Artificial intelligence (Machine learning & Deep learning models)
- Clinical end experimental medicine – cardiology
- Biomedical engineering
- Signal acquisition and processing

KEY RESEARCH EQUIPMENT

List of devices

- GPU server for training deep-learning models: Supermicro SYS-4029GP-TRT with 8x GPU Quadro RTX 5000
- Computing facilities intended for large data interactive processing (64 core parallel computing, high-speed SSD storages, SW support)
- Software for FPGA development – signal processing tool (Xilinx System Generator for DSP), logic analyser tool (Xilinx ChipScope Pro)

ACHIEVEMENTS

Awards

- 2014: ESGCO 2014 Award for Technology Transfer, Influence of Tilt Load on Pulse Wave Velocity in Lower Limbs
- 2014: Physionet challenge, Robust Detection of Heart Beats in Multimodal Data, 4th prize (Boston, USA) for QRS multimodal detection algorithm.
- 2015: Physionet challenge (Nice, France), Reducing False Arrhythmia Alarms in the ICU, the 1st and 2nd prize (two different categories) for arrhythmias detection methods.
- 2017: Clinical Needs Translational Award (CTA), European Society of Cardiology, Rennes, France
- 2018: 1st prize, LBBB Initiative of the International Society for Computerized Electrocardiology (Park City, Utah, USA)

Publications

- **J. Halánek, J.P. Couderc, P. Jurák, V. Vondra, W. Zareba, I. Višćor, P. Leinveber:**
"Measure of the QT-RR Dynamic Coupling in Patients with the Long QT Syndrome", Annals of Noninvasive Electrocardiology 17, 4, 323–330, 2012
- **F. Plesinger, J. Jurco, J. Halamek, P. Jurak:**
"SignalPlant: an open signal processing software platform", Physiol Meas 37(7), 38–48, 2016

VDI system to assess electrical ventricular dyssynchrony in a real-time

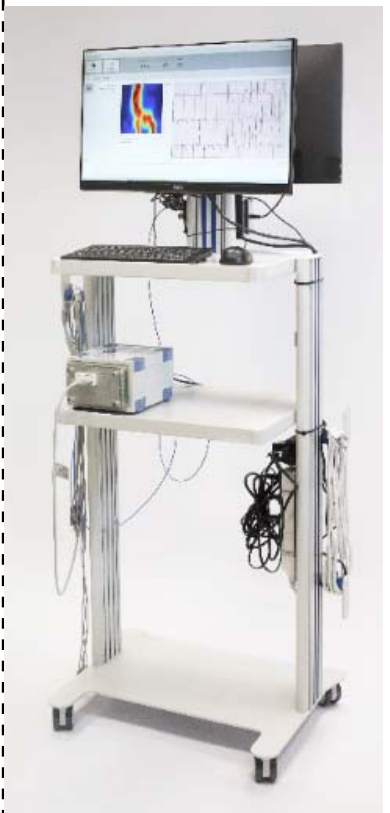



A hand-held device for instant screening of the heart activity (HACT-FV3) implements machine learning embedded on the FPGA chip

■ **P. Jurak, J. Halamek, J. Meluzin, F. Plešinger, T. Postranecka, J. Lipoldova, M. Novak, V. Vondra, I. Višcor, L. Soukup, P. Klimeš, P. Vesely, J. Šumbera, K. Zeman, S. Asirvatham, J. Tri, S. J. Asirvatham, P. Leinveber:**
“Ventricular dyssynchrony assessment using ultra-high frequency ECG technique”, Journal of Interventional Cardiac Electrophysiology 49, 3, 245–254, 2017

■ **F. Plesinger, P. Jurak, J. Halamek, P. Nejedly, P. Leinveber, I. Viscor, V. Vondra, S. McNitt, B. Polonsky, A. J. Moss, W. Zareba, and J. P. Couderc:**
“Ventricular Electrical Delay Measured From Body Surface ECGs Is Associated With Cardiac Resynchronization Therapy Response in Left Bundle Branch Block Patients From the MADIT-CRT Trial (Multicenter Automatic Defibrillator Implantation-Cardiac Resynchronization Therapy)”, Circulation: Arrhythmia and Electrophysiology, 2018;11:e005719

■ **K. Curila, R. Prochazkova, P. Jurak, M. Jastrzebski, J. Halamek, P. Moskal, P. Stros, J. Vesela, P. Waldauf, I. Viscor, F. Plesinger, O. Sussenbek, D. Herman, P. Osmancik, R. Smisek, P. Leinveber, D. Czarnecka, P. Widimsky:**
“Both selective and nonselective His bundle, but not myocardial, pacing preserve ventricular electrical synchrony assessed by ultra-high-frequency ECG”, HEART RHYTHM, 17(4), 607-614 (2020), best of Heart Rhythm Journal 1–6 2020.

■ **P. Jurak, K. Curila, P. Leinveber, F. W. Prinzen, I. Viscor, F. Plesinger, R. Smisek, R. Prochazkova, P. Osmancik, J. Halamek, M. Matejkova, J. Lipoldova, M. Novak, R. Panovsky, P. Andrla, V. Vondra, P. Stros, J. Vesela, D. Herman:**
“Novel ultra-high-frequency electrocardiogram tool for the description of the ventricular depolarization pattern before and during cardiac resynchronization”, JOURNAL OF CARDIOVASCULAR ELECTROPHYSIOLOGY, 31(1), 300–307 (2020),

Patents:

- Method of ventricular repolarization analysis: U.S. Pat. No. 8,600,485 B2, 2013
- Device for blood flow property measurement and method of its connection: U.S. Pat. No. 9,167,984 B2, 2015
- Ultra-high-frequency ECG technology: U.S. Pat. No. 9,949,655, 2018; European Patent Application, EP 19212534.2., 2019, 2020

MAIN COLLABORATING PARTNERS

Collaboration with academic partners

- International Clinical Research Centre (St. Anne's University Hospital, Brno, CZ)
- Fakultya hospital Kralovske Vinohrady (Prague, CZ)
- Maastricht University (Maastricht, NL)
- University of Rochester (Rochester, NY, USA)
- Imperial College London (London, UK)
- Brno University of Technology (Brno, CZ)
- Masaryk University (Brno, CZ)
- National Institute of Mental Health (Klecany, CZ)

Collaboration with companies

- M&I (Prague, CZ)
- Cardion (Brno, CZ)
- MDT – medical data transfer (Brno, CZ)

EXPECTATIONS

Offers

We offer collaboration in the areas of our expertise:

- Machine learning methods for ECG signal analysis
- Biomedical signal acquisition and analysis
- Development of diagnostic technologies and data processing methods
- Cooperation in clinical evaluation of new technologies
- Partnership in international scientific and technology-transfer projects

Requirements

We look for cooperation with academic partners as well as companies in the fields of signal processing and application of new analysis and technologies especially in cardiology and artificial intelligence.

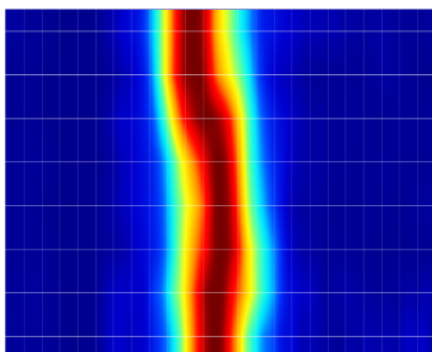
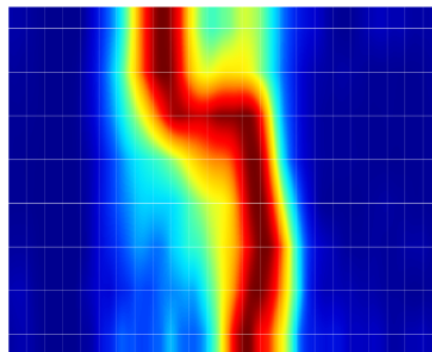
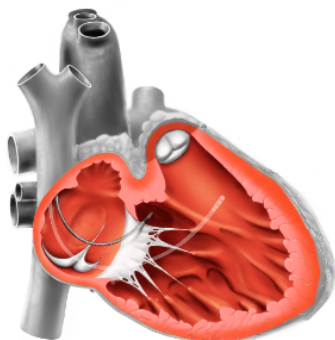

Real-time UHF-ECG analysis shows direct effect of electrode placement on heart dyssynchrony

THEMATIC RESEARCH FOCUS

Research area

- Biomedical engineering
- Signal processing
- Neuro electrophysiology, electro-encephalography (EEG)
- Advanced acquisition technologies
- Epileptic seizure localization
- Surgical outcome prediction (Epilepsy, Parkinson's disease)
- Motor and cognitive processes of the human brain

Excellence

- Deep brain electrophysiology – basic neuroscience research regarding the spatio-temporal distribution of brain activities
- Predictive models for rapid identification and localization of epileptic sources
- Advanced statistical and machine learning models for artifact rejection and detection of pathological events in EEG
- Development of open-source signal processing toolboxes and libraries for computational neurology and neuroscience

Mission

Development of advanced technologies in computational neuroscience and subsequent implementation of these tools to basic research and clinical practice in order to improve medical treatment, lower risk and reduce patient's time in a hospital.

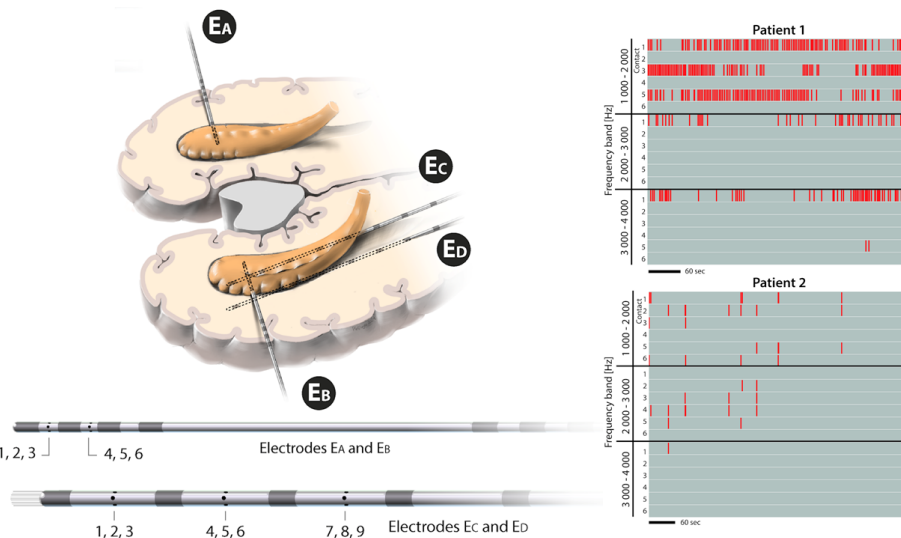

Institute of Scientific Instruments
of the ASCR, v.v.i.

Czech Academy of Sciences
Královopolská 147, 612 64 Brno,
Czech Republic
www.isibrno.cz

Head: Dr. Petr Klimeš
Phone: +420 541 514 517
E-mail: klimes@isibrno.cz

Expert: Dr. Pavel Jurak
Phone: +420 541 514 312
E-mail: jurak@isibrno.cz

*Implantation of human hippocampus
by depth macro and micro electrodes
(left). Detection of ultra fast oscillations
in epileptic (patient 1) and non-epileptic
(patient 2) hippocampus.*

UP-TO-DATE ACTIVITIES

Research orientation

- Methods for broadband EEG signal analysis
- Detection of pathological waveforms in EEG traces, e.g. interictal epileptic discharges and ultra-high frequency oscillations
- Connectivity and mutual interactions between anatomical structures of the human brain

Main capabilities

Basic research

- The basic research of motor and cognitive processes of human brain
- Spectral analysis of invasive and scalp EEG signals
- Analysis of the epileptogenic zone function and dynamics of epileptic seizures

Applied research

- Effectivity of deep brain stimulation (DBS) in epilepsy, Parkinson's disease
- Machine learning models:
 - localization of the epileptogenic zone
 - prediction of surgical outcome in epilepsy surgery
 - seizure forecasting and seizure prediction
 - prediction of the effect of vagal nerve stimulation (non-invasive scalp EEG study).
 - Implementation of the developed tools into clinical practice.

Sub-fields of group activities

- Clinical and experimental medicine – neurology
- Biomedical engineering
- Signal acquisition and processing

KEY RESEARCH EQUIPMENT

List of devices

- Computing facilities intended for large data interactive processing (64 core parallel computing, high-speed SSD storages, SW support)

ACHIEVEMENTS

Awards

- Dr. Klimeš received The Molson Neuro-Engineering Fellowship – “Towards a more accurate and time efficient presurgical epilepsy work-up: development of seizure-independent biomarkers of the epileptic focus”. Awarded by The Montreal Neurological Institute and Hospital, QC, Canada, 2019.
- Dr. Josef Halánek received “František Křižík” Honorable Medal from the Czech Academy of Sciences for his lifetime work in the field of signal processing in medicine. 2018.
- Poster “Relative entropy between iEEG signals as a powerful tool for localization of epileptogenic tissue” by Dr. Klimeš et al. was shortlisted for the Best Poster Award at the European Congress on Epileptology (ECE), Vienna, 2018.

Publications

■ **D. DEUTSCHOVÁ, P. KLIMEŠ, Z. JORDAN, P. JURÁK, L. EROSS, M. LAMOŠ, J. HALÁNEK, P. DANIEL, I. REKTOR, D. FABO:**

“Thalamic oscillatory activity may predict response to deep brain stimulation of the anterior nuclei of the thalamus”. *Epilepsia*. 2021, <https://doi.org/10.1111/epi.16883>.

■ **J. CIMBALNIK, M. PAIL, P. KLIMES, V. TRAVNICEK, R. ROMAN, A. VAJCNER, M. BRAZDIL:**

“Cognitive Processing Impacts High Frequency Intracranial EEG Activity of Human Hippocampus in Patients With Pharmacoresistant Focal Epilepsy”. *Frontiers in neurology*. 2020, 11, 578571. ISSN 1664-2295.

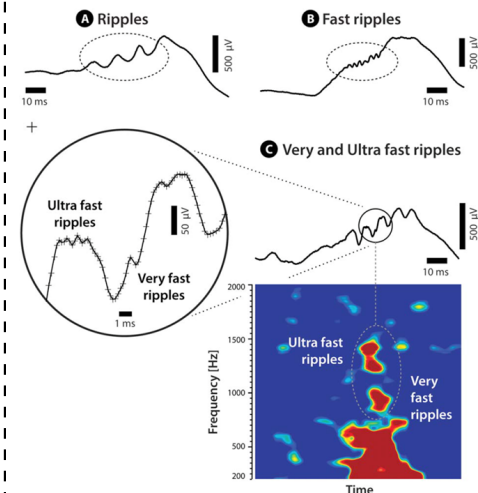

Examples of different types of oscillation recorded at high frequencies with high dynamicity (Brazdil et al., 2017).

- **P. NEJEDLY, V. KREMEN, V. SLADKY, J. CIMBALNIK, P. KLIMES, F. PLESINGER, F. MIVALT, V. TRAVNICEK, I. VISCOR, M. PAIL, J. HALAMEK, B. H. BRINKMANN, M. BRAZDIL, P. JURAK, G. WORRELL:**

"Multicenter intracranial EEG dataset for classification of graphoelements and artifactual signals". Nature – Scientific Data. 2020, doi:10.1038/s41597-020-0532-5

- **L. PETER-DEREX, P. KLIMES, V. LATREILLE, S. BOUHADOUN, F. DUBEAU, B. FRAUSCHER:**

"Sleep Disruption in Epilepsy: Ictal and Interictal Epileptic Activity Matter". Annals of neurology. 2020, 88(5), 907–920. ISSN 0364-5134.

- **P. KLIMES, J. CIMBALNIK, M. BRAZDIL, J. HALL, F. DUBEAU, J. GOTMAN, B. FRAUSCHER:**

"NREM sleep is the state of vigilance that best identifies the epileptogenic zone in the interictal electroencephalogram". Epilepsia. 2019, 60(12), 2404–2415. ISSN 0013-9580.

- **J. CIMBALNIK, P. KLIMES, V. SLADKY, P. NEJEDLY, P. JURAK, M. PAIL, R. ROMAN, P. DANIEL, H. GURAGAIN, B. BRINKMANN, M. BRAZDIL, G. WORRELL:**

"Multi-feature localization of epileptic foci from interictal, intracranial EEG". Clinical neurophysiology. 2019, 130(10), 1945–1953. ISSN 1388-2457.

- **P. NEJEDLY, V. KREMEN, V. SLADKY, J. CIMBALNIK, P. KLIMES, F. PLESINGER, I. VISCOR, M. PAIL, J. HALAMEK, B. H. BRINKMANN, M. BRAZDIL, P. JURAK, G. WORRELL:**

"Exploiting Graphoelements and Convolutional Neural Networks with Long Short Term Memory for Classification of the Human Electroencephalogram". Nature – Scientific reports. 2019, 9(1), 11383. ISSN 2045-2322.

- **P. NEJEDLY, V. KREMEN, V. SLADKY, M. NASSERI, H. GURAGAIN, P. KLIMES, J. CIMBALNIK, Y. VARATHARAJAH, B. H. BRINKMANN, G. A. WORRELL:**

"Deep-learning for seizure forecasting in canines with epilepsy". Journal of neural engineering. 2019, 16(3), 036031. ISSN 1741-2560.

- **P. NEJEDLY, J. CIMBALNIK, P. KLIMES, F. PLESINGER, J. HALAMEK, V. KREMEN, I. VISCOR, B. H. BRINKMANN, M. PAIL, M. BRAZDIL, G. WORRELL, P. JURAK:**

"Intracerebral EEG Artifact Identification Using Convolutional Neural Networks". Neuroinformatics. 2019, 17(2), 225–234. ISSN 1539-2791.

- **M. BRÁZDIL, M. PAIL, J. HALÁMEK, F. PLEŠINGER, J. CIMBÁLNÍK, R. ROMAN, P. KLIMĚŠ, P. DANIEL, J. CHRÁSTINA, E. BRICHTOVÁ, I. REKTOR, G. A. WORRELL, P. JURÁK:**

"Very high-frequency oscillations: Novel biomarkers of the epileptogenic zone". Annals of neurology. 2017, 82(2), 299–310. ISSN 0364-5134.

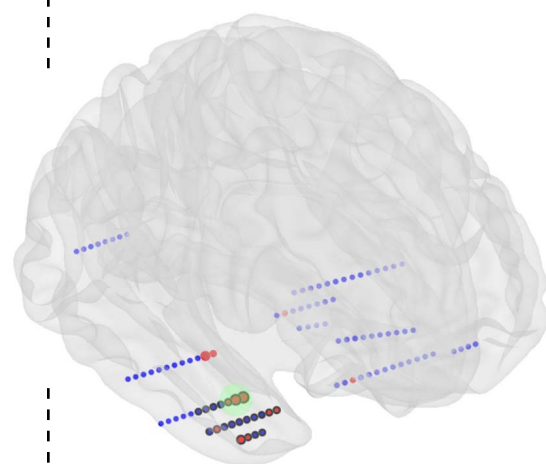

Schematic illustration of the pathological tissue localization using machine learning model based on multiple EEG features. Red disks represent the channels identified by the model as pathological. The cluster (green circle) with the highest mean probability is selected as the final localization (Cimbalnik and Klimes et al., 2019)

MAIN COLLABORATING PARTNERS

Collaboration with academic partners

- International Clinical Research Center (ICRC), St. Anne's University Hospital, Brno (CZ)
- Medical Faculty, Masaryk University, Brno (CZ)
- Central European Institute of Technology (CEITEC), Brno (CZ)
- Mayo Clinic, Rochester (MN, USA)
- Montreal Neurological Institute and Hospital (QC, Canada)

Collaboration with companies

- M&I (Prague, CZ)

EXPECTATIONS

Offers

We offer collaboration in the areas of our expertise:

- Biomedical signal acquisition and analysis
- Development of diagnostic technologies and data processing methods in clinical evaluation of new technologies
- Partnership in international scientific and technology-transfer projects

Requirements

We look for cooperation with academic partners as well as companies in the fields of signal processing and application of new analysis and technologies in neurology.

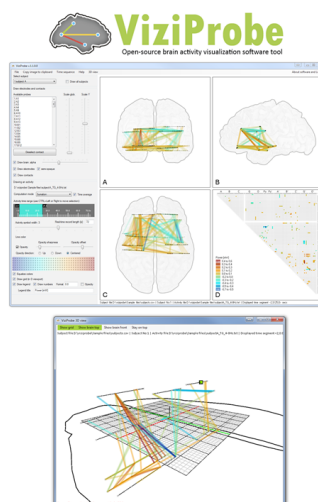
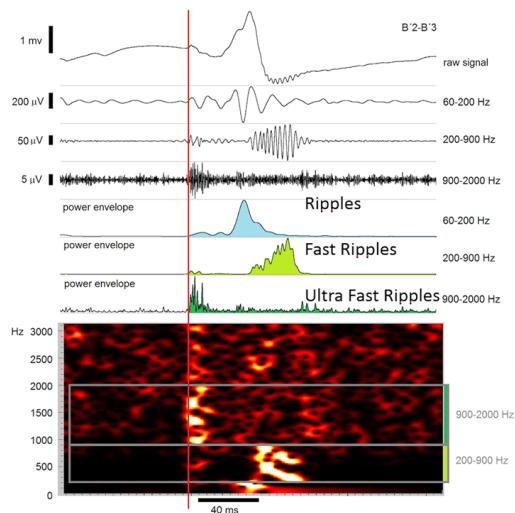

Intracerebral EEG recordings and analysis – brain structures involvement in cognition process, pathological and functional connectivity.

Group of Levitational Photonics

Department of Microphotonics



Institute of Scientific
Instruments
The Czech Academy
of Sciences

Institute of Scientific Instruments
of the CAS, v. v. i.

The Czech Academy of Sciences
Královopolská 147, 612 64 Brno,
The Czech Republic
[https://www.isibrno.cz/
en/levitational-photonics](https://www.isibrno.cz/en/levitational-photonics)

Head: Dr. Oto Brzobohatý
Phone: +420 541 514 283
E-mail: otobrzo@isibrno.cz

Head of the Department:
Prof. Pavel Zemánek
Phone: +420 541 514 202
E-mail: zemanek@isibrno.cz

THEMATIC RESEARCH FOCUS

Research area

- Light-matter interaction
- Nonlinear stochastic processes with optically trapped objects
- Laser cooling of optically levitated nanoobjects
- Quantum optomechanics

Excellence

- Force interaction between light and objects (theoretical and experimental aspects)
- Applications of focused laser beams (laser microdissection, optical tweezers, optical cell sorters, long-range optical delivery of micro(nano)objects, polymerization of micro-structures)
- Laser beam shaping by spatial light modulators

Mission

To be at the forefront in developing new optical methods appropriate for contactless, nondestructive investigation of living or inanimate parts of the micro, nano and quantum worlds.

UP-TO-DATE ACTIVITIES

Research orientation

- Investigation of underdamped and overdamped stochastic object motion in nonlinear optical potentials
- Investigation of colloidal photonic crystals assembled by light
- Laser cooling of nanoparticles at low pressures
- Optically-induced rotation and self-arrangement of several objects
- Optical trapping and characterization of plasmonic nanoparticles

Main capabilities

Basic research

- Theoretical and experimental activities related to optical manipulations with micro and nanoobjects

Sub-fields of group activities

- Optical microscopy
- Colloidal chemistry
- Laser spectroscopy
- Optical levitation of nanoobjects in vacuum

KEY RESEARCH EQUIPMENT

List of devices

- Various CW high power lasers working at 1550 nm, 980 nm, 785 nm, 532nm, 680-1000 nm (Coherent, Spectra Physics, IPG, Sacher)

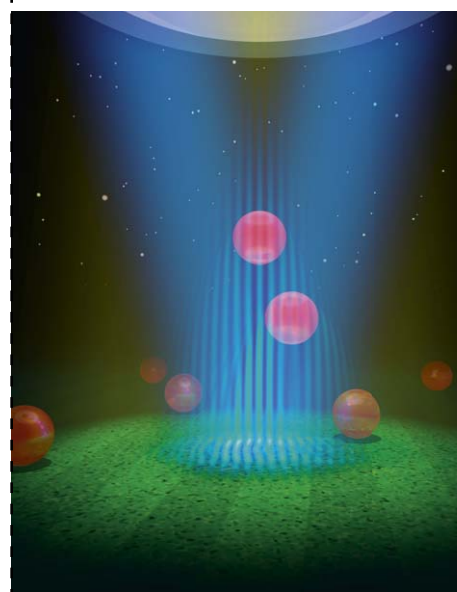

Visualization of the optical tractor beam pulling objects against the photon flow.

- Femtosecond laser systems Mira 800 HP, Mai Tai HP Deep See (NKT, Coherent, ...)
- Several different flexible systems for advanced optical micromanipulation
- Experiments (holographic tweezers, dual-beam holographic traps)
- Fast CCD cameras (thousands fps)

ACHIEVEMENTS

Awards

- Werner von Siemens Excellence Award for the best result of the basic research in 2013
- Oto Brzobohatý was awarded the Otto Wichterle Award for talented young scientists by the Czech Academy of Sciences in 2014
- Zdeněk Pilát was awarded the best Ph.D. Thesis in 2015 by the Czechoslovak Microscopy Society
- Jana Damková was awarded Young Scientist Award 2016 by the Czech and Slovak Society for Photonics
- Pavel Zemánek was awarded Praemium Academiae in 2020
- Vojtěch Svak received The “Josef, Marie and Zdeňka Hlávkas Talent Award” in 2021

Publications

We deepened the understanding of the force interaction between light and micro/nanoobjects and developed original methods how to manipulate with individual particles or even thousands of particles, how to sort and self-arrange them. We published more than 50 papers in impacted journals with very good citation response in the period 2012–2022.

■ Experimental demonstration of optical “tractor” beam and its utilization in optical sorting and self-arrangement of microobjects

- O. Brzobohatý, V. Karásek, M. Šiler, L. Chvátal, T. Čížmár, P. Zemánek: “Experimental demonstration of optical transport, sorting and self-arrangement using a ‘tractor beam’”, *Nature Photon.* **7**, 123–127, 2013
This result attracted strong interest of media all over the world:
http://www.isibrno.cz/index.php?lang=_an&co=/intranet/novinky.php&nalogovan=&id_druh_menu=3&Nerolovat=1
- J. Damkova, L. Chvatal, J. Ježek, J. Oulehla, O. Brzobohaty and P. Zemanek: “Enhancement of the ‘tractor-beam’ pulling force on an optically bound structure”, *Light: Science & Applications* **7**, 17135, 2018

■ Optical sorting of microobjects

- P. Jákl, A. V. Arzola, M. Šiler, L. Chvátal, K. Volke-Sepúlveda, P. Zemánek: “Optical sorting of nonspherical and living microobjects in moving interference structures”, *Optics Express* **22**, 29746–29760, 2014
- Optical cell-sorter based on fluorescences or Raman spectra of microorganisms (utility model in cooperation with Photon Systems Instruments)

■ Confirmation of an extraordinary optical momentum and force directed perpendicular to the wavevector, and proportional to the optical spin (degree of circular polarization), introduced by Belinfante in field theory in 1975, and revealing a new type of transverse force, exhibiting polarization-dependent contribution, determined by the imaginary part of the complex Poynting vector

- M. Antognozzi, C. R. Bermingham, R. L. Harniman, S. H. Simpson, J. Senior, R. Hayward, H. Hoerber, M. R. Dennis, A. Y. Bekshaev, K. Y. Bliokh, F. Nori: “Direct measurements of the extraordinary optical momentum and transverse spin-dependent force using a nano-cantilever”, *Nature Physics*, **12**, 731–735, 2016

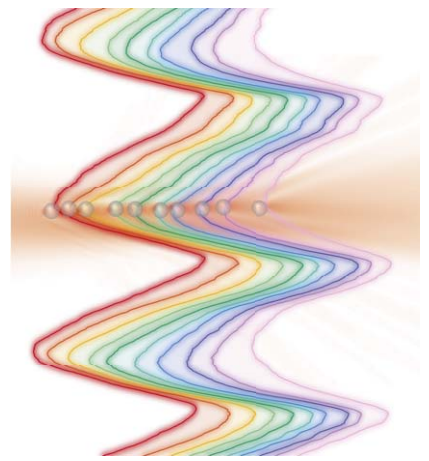

An example of a system of self-arranging optically bound particles in water existing far from the thermodynamic equilibrium in the form of self-sustained oscillations.

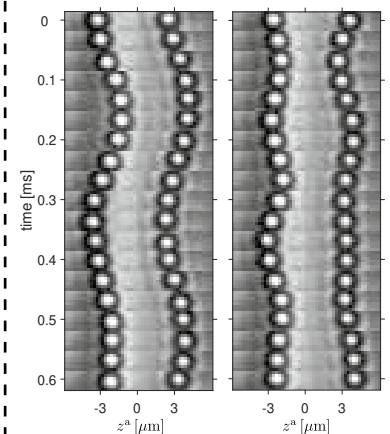

Examples of center of mass motion mode and breathing mode of two optically bound particles levitating in vacuum.

Transport of multiple microobjects using the optical ratchet

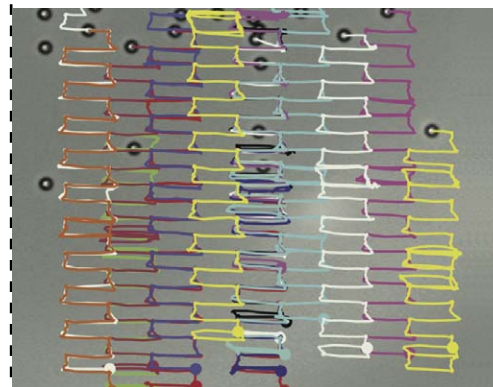

■ Description of stochastic behaviour of a Brownian particle in nonlinear potential

- R. Filip, P. Zemánek: "Noise-to-signal transition of a Brownian particle in the cubic potential: I. general theory", *Journal of Optics* **18**, 065401, 2016
- P. Zemánek, M. Šiler, O. Brzobohatý, P. Jákl, R. Filip: "Noise-to-signal transition of a Brownian particle in the cubic potential: II. optical trapping geometry", *Journal of Optics* **18**, 065402, 2016
- A. Ryabov, P. Zemánek, R. Filip: "Thermally induced passage and current of particles in a highly unstable optical potential". *Phys. Rev.* **E 94**, 042108, 2016
- M. Šiler, P. Jákl, O. Brzobohatý, A. Ryabov, R. Filip, P. Zemánek. "Thermally induced micro-motion by inflection in optical potential", *Scientific Reports*, **7**, 1697, 2017
- M. Šiler, L. Ornigotti, O. Brzobohatý, P. Jákl, A. Ryabov, V. Holubec, P. Zemánek, R. Filip: "Diffusing up the Hill: Dynamics and Equipartition in Highly Unstable Systems". *Phys. Rev. Lett.* **121**, 23601, 2018

■ Omnidirectional transport in fully reconfigurable 2D optical ratchets

- A. V. Arzola, M. Villasante-Barahona, and K. Volke-Sepúlveda, P. Jákl and P. Zemánek: "Omnidirectional Transport in Fully Reconfigurable Two Dimensional Optical Ratchets", *Phys. Rev. Lett.* **118**, 138002, 2017

■ Pioneering results related to optically induced alignment or rotation of microobjects and nanoobjects

- M. G. Donato, O. Brzobohatý, S. H. Simpson, A. Irrera, A. A. Leonardi, M. J. L. Faro, V. Svak, O. M. Maragò, P. Zemánek: "Optical trapping, optical binding, and rotational dynamics of silicon nanowires in counter-propagating beams", *Nano Lett.* **19**, 342–352, 2019
- S. H. Simpson, P. Zemánek, O. M. Maragò, P. H. Jones, and S. Hanna: "Optical Binding of Nanowires", *Nano Lett.*, **17** (6), 3485–3492, 2017
- A. Irrera, A. Magazzu, P. Artoni, S. H. Simpson, S. Hanna, P. H. Jones, F. Priolo, P. G. Gucciard, and O. M. Marago: "Photonic Torque Microscopy of the Nonconservative Force Field for Optically Trapped Silicon Nanowires", *Nano Lett.* **16** 4181–4188, 2016
- S. H. Simpson, L. Chvátal, P. Zemánek: "Synchronization of colloidal rotors through angular optical binding", *Physical Review A* **93**, 023842, 2016
- O. Brzobohatý, A. V. Arzola, M. Šiler, L. Chvátal, P. Jákl, S. Simpson, P. Zemánek "Complex rotational dynamics of multiple spheroidal particles in a circularly polarized, dual beam trap", *Optics Express* **22**, 7273–7287, 2015
- O. Brzobohatý, M. Šiler, J. Trojek, L. Chvátal, V. Karásek, A. Paták, Z. Pokorná, F. Mika, P. Zemánek: "Three-Dimensional Optical Trapping of a Plasmonic Nanoparticle using Low Numerical Aperture Optical Tweezers", *Scientific Reports* **5**, 8106, 2015
- A. V. Arzola, P. Jákl, L. Chvátal, P. Zemánek: "Rotation, oscillation and hydrodynamic synchronization of optically trapped oblate spheroidal microparticles", *Optics Express* **22**, 16207–1622, 2014

■ Experimental demonstration of non-equilibrium particle dynamics caused by optical spin force and showing a transition between stochastic Brownian motion and deterministic orbital motion

- V. Svak, O. Brzobohatý, M. Šiler, P. Jákl, J. Kaňka, P. Zemánek, S. H. Simpson: "Transverse spin forces and non-equilibrium particle dynamics in a circularly polarized vacuum optical trap." *Nature Commun.*, **9**, 5453, 2018

■ Optical manipulation and electrical tuning of microlasers formed from liquid crystal droplets

- A. Jonáš, Y. Pilát, J. Ježek, S. Bernatová, P. Jedlička, M. Aas, A. Kiraz, P. Zemánek: "Optically transportable optofluidic microlasers with liquid crystal cavities tuned by the electric field". *ACS Applied Materials & Interfaces* **13**, 50657–50667, 2021

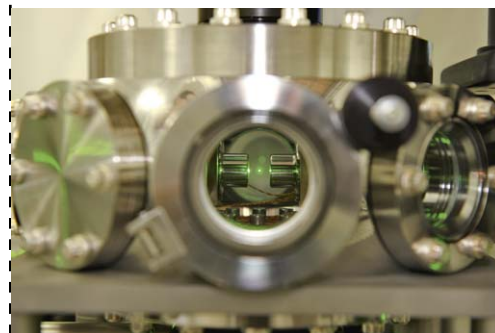

An optically trapped nanoparticle inside the vacuum chamber

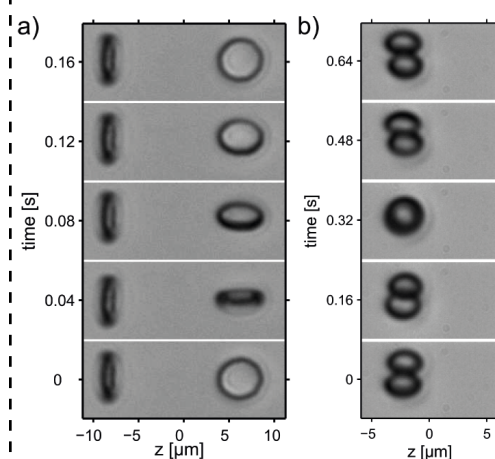

An example of simultaneous trapping and rotation of disc-like objects in counter-propagating laser beams with circular polarizations

An example of optically self-arranged colloidal waveguide. The distance between the particles is tuneable by the width of two counter-propagating beams which is followed with different spectral properties of the whole structure shown at red, yellow and green wavelengths

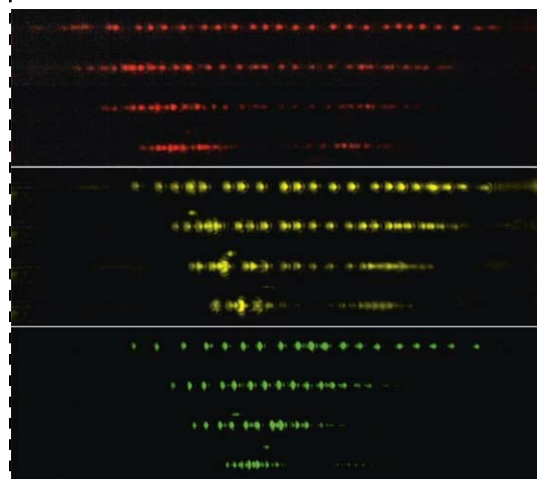

■ Conversion of spin to orbital angular light momentum and its detection

- A. C. Valero D. Kislov, E. A. Gurvitz, H. K. Shamkhi, A. A. Pavlov, D. Redka, S. Yankin, P. Zemánek, A. S. Shalin: "Nanovortex-driven all-dielectric optical diffusion boosting and sorting concept for lab-on-a-chip platforms". *Advanced Science* **7**, 2020
- A. V. Arzola, L. Chvátal, P. Ják, P. Zemánek: "Spin to orbital light momentum conversion visualized by particle trajectory". *Scientific Reports* **9**, 4127:1–7, 2019

■ Optical formation of colloidal waveguides and demonstration of tunability of their spectral properties

- O. Brzobohatý, L. Chvátal, A. Jonáš, M. Šiler, J. Kaňka, J. Ježek, P. Zemánek: "Tunable Soft-Matter Optofluidic Waveguides Assembled by Light". *ACS Phot.* **6**, 403-410, 2019

■ Properties of optically levitating systems

- J. Flajšmanová, M. Šiler, P. Jedlička, F. Hrubý, O. Brzobohatý, R. Filip, P. Zemánek: "Using the transient trajectories of an optically levitated nanoparticle to characterize a stochastic Duffing oscillator". *Scientific Reports* **10**, 14436, 2020
- Y. Arita, S. H. Simpson, P. Zemánek, K. Dholakia: "Coherent oscillations of a levitated birefringent microsphere in vacuum driven by nonconservative rotation-translation coupling". *Science Advances* **6**, 2020
- V. Svak, J. Flajšmanová, L. Chvátal, M. Šiler, A. Jonáš, J. Ježek, S. H. Simpson, P. Zemánek, O. Brzobohatý: "Stochastic dynamics of optically bound matter levitated in vacuum". *Optica* **8**, 220–229, 2021
- S. H. Simpson, Y. Arita, K. Dholakia, P. Zemánek: "Stochastic Hopf bifurcations in vacuum optical tweezers". *Phys. Rev. A* **104**, 043518, 2021

■ Extensive review on an optically induced transport of objects

- P. Zemánek, G. Volpe, A. Jonáš, O. Brzobohatý: "Perspective on light-induced transport of particles: from optical forces to phoretic motion". *Advances in Optics and Photonics* **11**, 577–678, 2019

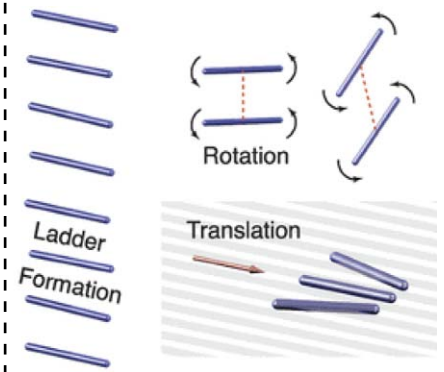

Optical Binding of Nanowires

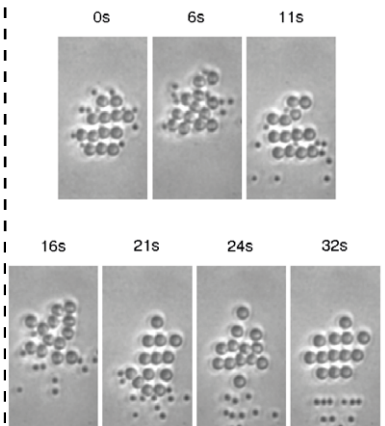

Example of optical sorting of suspension of polystyrene particles of sizes 800 nm and 1600 nm in travelling interference fringes

MAIN COLLABORATING PARTNERS

Collaboration with academic partners

- Brno University of Technology (Brno, CZ)
- Consiglio Nazionale delle Ricerche (Messina, IT)
- Institute of Experimental Physics, Slovak Academy of Sciences (Košice, SK)
- Istanbul Technical University (Istanbul, TR)
- Koc University (Istanbul, TR)
- Lehigh University (Bethlehem, USA)
- Masaryk University (Brno, CZ)
- Palacký University Olomouc (Olomouc, CZ)
- Universidad Nacional Autónoma de México (Mexico City, MX)
- University of Bristol (Bristol, UK)
- University of Dundee (Dundee, UK)
- University of Naples Federico II (Naples, IT)
- University of St. Andrews (St. Andrews, UK)

EXPECTATIONS

Offers

- Collaboration in the areas of our expertise
- Partnership in international projects

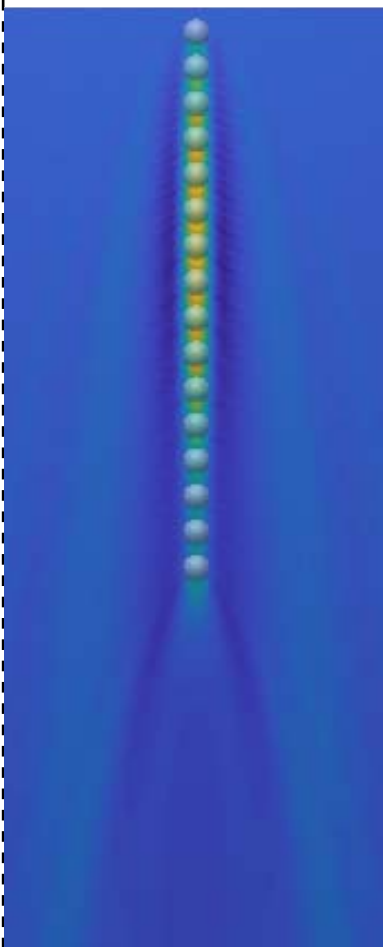

R&D PROFILE

Research area

- Optics
- Holography
- Microscopy
- *In-vivo* imaging technology
- Endoscopy
- Lasers
- Neuroscience
- Immunology

Excellence

- Light propagation and image formation in optical fibres
- Effects of fibre bending or heating on image formation and recovery
- Laser beam shaping by spatial light modulators and digital micro-mirror devices
- On demand design and manufacturing of imaging systems
- Chemical micro-endoscopy (Raman spectroscopy, CARS or SRS)
- Imaging of biological tissues including brain and lymphoid organs

Mission

Our understanding of (biological) life has huge repercussions for our health and wellbeing. The tremendous complexity of living organisms poses challenging scientific questions. In particular, multiple scattering effects prevent current technologies from retrieving sufficiently detailed information from deep within biological tissue.

Amongst other activities we develop a new class of endoscopes that can break through this barrier. This technology can potentially go as far as reaching super-resolution with instruments having a footprint comparable to the dimensions of a single cell.

UP-TO-DATE ACTIVITIES

New technologies in holographic endoscopy

- Employ multimode fibres for holographic endoscopic techniques. Study the image formation and degradation due to fibre bending or inhomogeneous heating.
- Software development for fast reconstruction of images obtained by multimode fibres (CUDA, OpenCL, Matlab, LabView).
- Design and employ new types of fibre probes, materials and new endings for broadening spectrum of imaging techniques.
- Design and prototype a new type of Digital Micromirror Device that allows fast modulation of the light spatial phase profile with small phase steps.

Broadening the understanding and control possibilities of light propagation in optical waveguides

- Linear propagation and shaping of light in ideal, cylindrically symmetric multimode optical fibres including continuous wave and pulse propagation, with applications to non-linear Raman and light sheet imaging.

Institute of Scientific Instruments
of the CAS, v. v. i.
Czech Academy of Sciences
Královopolská 147, 612 64 Brno,
Czech Republic
<http://complexphotonics.isibrno.cz>
<http://www.isibrno.cz/omitec/>

Head: Prof. Tomáš Čížmár
Phone: +420 541 514 131
E-mail: cizmart@isibrno.cz

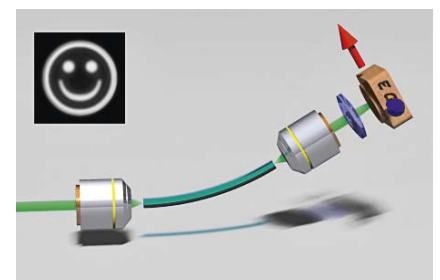

Schematic description of fibre bending experiments.

- Effects of small, geometric or optical perturbations, how they influence image formation and how these effects can be ameliorated.
- Methods for efficient optical fibre calibration and measurement.
- Image reconstruction via mode separation and processing.

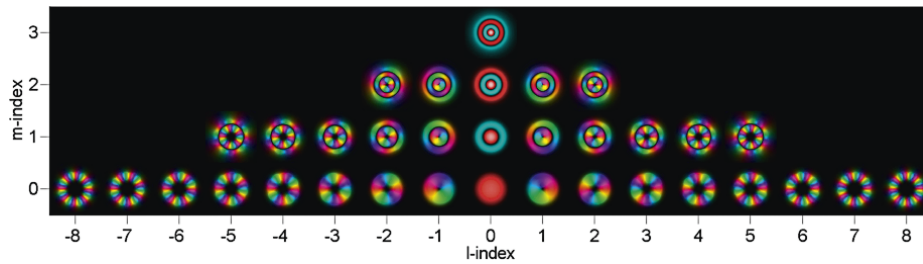

Discrete modes in a multimode optical fibre.

Micro-endoscopy with chemical contrast

- Raman microscopy is a form of label-free imaging with chemical contrast, which means that we can detect the composition of the tissue without staining it.
- Raman imaging and spectroscopy is useful for applications such as identifying bacteria and imaging lipid distribution in cells (relevant for cell metabolism and related disease conditions). Combined with holographic endoscopy, it has promise as a method for diagnosing tumors in situ, without performing a biopsy and associated time consuming histopathology.
- We will implement Raman imaging in a light sheet configuration, for faster imaging than point scanning allows.
- We aim to develop non-linear Raman imaging, in the form of CARS or SRS, through a multimode fibre.
- We aim to apply this for diagnosing tumors in sensitive locations such as the brain or pancreas.

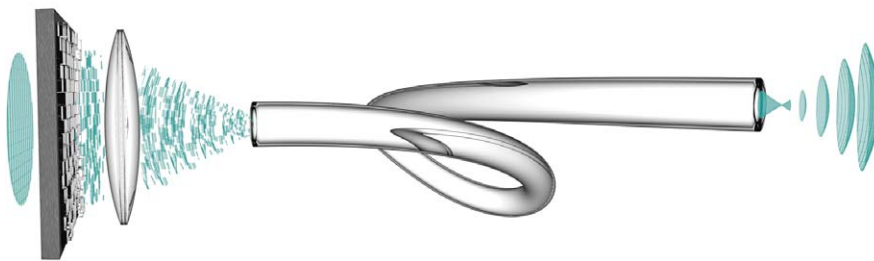

Synthesis of laser focus through a randomizing optical fibre.

In-vivo imaging for neuroscience and immunology

- One of the primary challenges facing bio-medical research today is imaging cells and cell functions in native tissues which is typically absorbing and scattering light and therefore appears opaque.
- Imaging of structures and functions deep in the tissue often requires invasive procedures including removal of the above-lying layers.
- We are developing imaging strategies for multimode optical fibres to be used as endoscopic probes. Such endoscopes have very small footprints and can therefore interrogate and image regions of the sample which would, otherwise, be inaccessible. Simultaneously they provide high-resolution images.
- Using these endoscopes we aim to study the function of two systems *in vivo*: brain and lymphoid organs.
- We will take advantage of well-defined stimulation such as selective, optogenetically-evoked activation of different cell populations, pharmacological manipulations as well as behaviour/memory-related tasks.

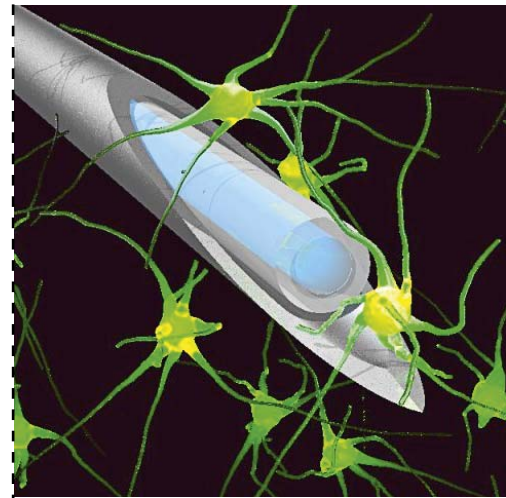

An artist's impression of endoscopic imaging of neurons in the brain. The fibre is inserted using a hypodermic needle.

- Our ultimate goal is to have a versatile tool for online, high-resolution observation of 1. fundamental neurological processes such as neurovascular coupling, memory formation and neuronal plasticity in awake, freely moving animals; 2. immune processes in tissues inaccessible by classical multiphoton microscopy.

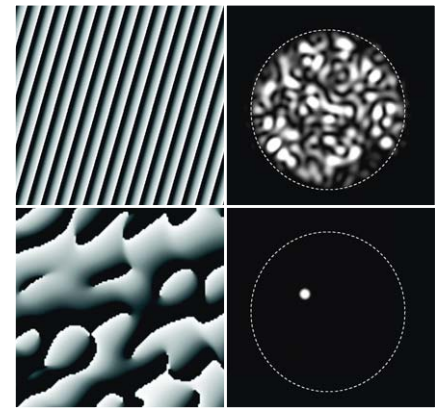
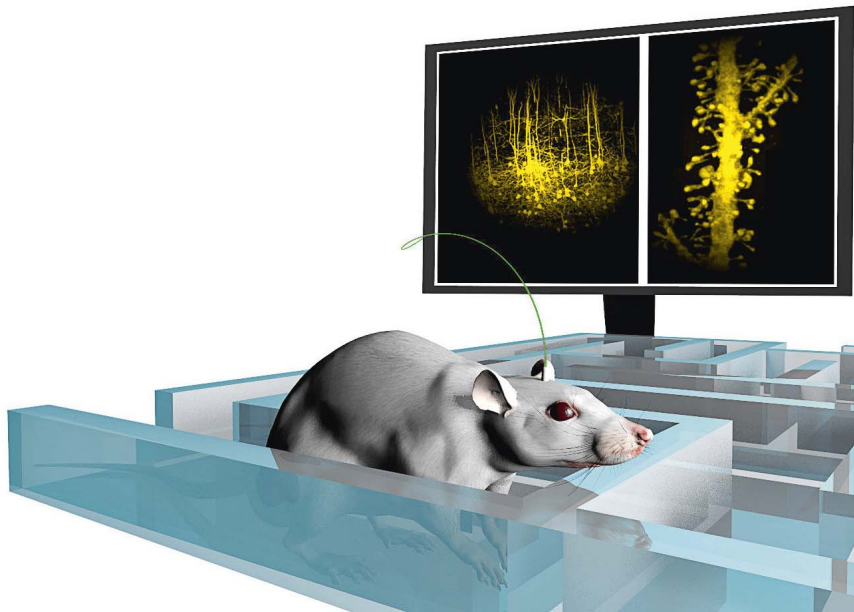

The fibre scrambles the light from a plane wave illumination to a speckle pattern (↗). The plane wave is created by the phase grating on the SLM (↖). By applying an appropriate pattern on the SLM (↙) we create a focus at the output of the fibre (↘).

KEY RESEARCH EQUIPMENT

List of devices

- High power CW laser & tunable single frequency Ti:sapphire laser
- Multiphoton/confocal microscope centre (2019 onwards)
- Femtosecond laser system (2019 onwards)
- Various liquid crystal Spatial Light Modulators and Digital Micromirror Devices
- Centre of 3D printing enabling various 3D print techniques: Polyjet printing (Stratasys Objet Prime) including biocompatible materials, Fused Deposition Modelling (Zortax M300, Felix Pro 2) and Digital Light Processing (Dwarf 3)
- Surgical equipment for *in-vivo* imaging studies (IVC rack, isoflurane anaesthetic centre, stereotactic frame, stereo microscope, autoclave, homeothermic blanket, MouseOx mouse monitoring system, dental drill)
- Cell-culture equipment (laminar flow-box, CO₂ incubator, centrifuge)
- Equipment for *in-vivo* microscopy and endoscopy (pneumatic pico pump, pulse stimulator, pipette puller, micro-manipulators)

ACHIEVEMENTS

- **Sergey Turtaev, Ivo T. Leite, Kevin J. Mitchell, Miles J. Padgett, David B. Phillips, & Tomáš Čižmár, "Comparison of nematic liquid-crystal and DMD based spatial light modulation in complex photonics," Opt. Express 25, 29874-29884 (2017)**
- **Ivo T. Leite, Sergey Turtaev, Xin Jiang, Martin Šiler, Alfred Cuschieri, Philip St.J. Russell, & Tomáš Čižmár, "3-D holographic optical manipulation through high-NA soft-glass multimode fibre," Nature Photonics 12, 33-39 (2018)**

Experimental setup for fibre imaging

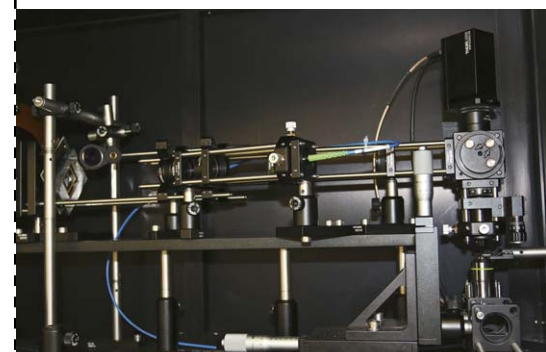

- **Dirk E. Boonzajer Flaes, Jan Stopka, Sergey Turtaev, Johannes F. de Boer, Tomáš Tyc, & Tomáš Čižmár, "Robustness of Light-Transport Processes to Bending Deformations in Graded-Index Multimode Waveguides," Phys. Rev. Lett. 120, 233901 (2018)**

MAIN COLLABORATING PARTNERS

Collaboration with academic partners

- Leibniz-Institut für Photonische Technologien (Jena, DE)
- University of Edinburgh (Edinburgh, UK)
- Oxford University (Oxford, UK)
- University of Exeter (Exeter, UK)
- Stanford University (Stanford, USA)
- Max Planck Institute for the Science of Light (Erlangen, DE)
- Vrije Universiteit Amsterdam (Amsterdam, NL)
- Masaryk University (Brno, CZ)
- University of Dundee (Dundee, UK)
- University of Glasgow (Glasgow, UK)
- University of St. Andrews (St. Andrews, UK)

EXPECTATIONS

Offers

We offer to share our expertise in the areas of waveguide optics, fluorescence imaging, nonlinear microscopy and digital holography.

Requirements

We look for cooperation with academic partners in the fields of *in-vivo* imaging, neuroscience, & optical manipulation.

FUNDING

European Regional Development Fund,
Project No. CZ.02.1.01/0.0/0.0/15_003/0000476



EUROPEAN UNION
European Structural and Investing Funds
Operational Programme Research,
Development and Education



MINISTRY OF EDUCATION,
YOUTH AND SPORTS

THEMATIC RESEARCH FOCUS

Research area

- Optics
- Laser spectroscopy
- Biophotonics
- Nanophotonics
- Lab-on-a-chip

Excellence

- Applications of focused laser beams (optical tweezers, optical cell sorters)
- Raman micro-spectroscopy combined with optical manipulations (Raman tweezers) for detection and identification of bacteria using techniques of AI
- Analysis of the relationship between a bacteriophage and its host bacterium
- Manufacturing of tailored microfluidic chips

Mission

Our main goal is to design and develop analytical techniques based on microfluidics and Raman spectroscopy to solve emerging tasks targeted on basic and applied biological research ranging from microorganisms to enzymes.

UP-TO-DATE ACTIVITIES

Research orientation

- Optical trapping
- Characterization of living microorganisms (e.g. bacteria, yeast and algae cells) using Raman microspectroscopy, Raman tweezers and microfluidic chips
- Optical monitoring of chemical reactions running in emulsion droplets and lab-on-a-chip

Main capabilities

Basic research

- Determination of selected chemical content in living microorganisms using Raman microspectroscopy combined with optical micromanipulation and microfluidic techniques

Applied research

- Design and manufacturing of microfluidic chips
- Monitoring of polymers inside the cells with industrial biotechnological applications
- Identification of bacteria with clinical applications

Innovations

- Tailored microfluidic chips for clinical investigations

Subfields of group activities

- Optical microscopy
- Microtechnology, nanotechnology
- Biophotonics

Institute of Scientific Instruments
of the CAS, v.v.i.

Czech Academy of Sciences

Královopolská 147, 612 64 Brno,
Czech Republic

<http://www.isibrno.cz/>

[en/biophotonics-and-optofluidics](http://www.isibrno.cz/en/biophotonics-and-optofluidics)

Head: Dr. Ota Samek

Phone: +420 541 514 284

E-mail: osamek@isibrno.cz

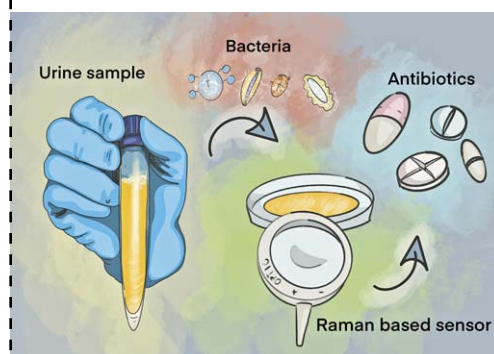

Imagine this wishful scenario in a clinical practice: A sick person enters a hospital emergency ward and the doctor collects a urine specimen from this person. Consequently, in an ideal case, pathogens are identified quickly and appropriate antibiotics are prescribed. Thus, we aim to introduce Raman spectroscopy as potential method of choice for POC measurement which excels in speed and sensitivity in clinical setting.

- Cell biology
- Biochemistry
- Laser spectroscopy
- Microfluidics
- Lab-on-a-chip systems
- Microbiology

KEY RESEARCH EQUIPMENT

List of devices

- Renishaw In Via Reflex Raman microspectrometer
- Raman tweezers made by the research team
- Optical cell sorters made by the research team
- Fast CCD cameras (thousands fps)

SELECTED PUBLICATIONS

■ Identification and differentiation of bacteria, bacteriophage, and yeast

- K. Rebrošová, S. Bernatová, M. Šiler, M. Uhlířová, O. Samek, J. Ježek, V. Holá, F. Růžička, P. Zemánek: "Raman spectroscopy—a tool for rapid differentiation among microbes causing urinary tract infections." *Analytica Chimica Acta*, **1191**, 339292 (2022).
- O. Samek, S. Bernatová, F. Dohnal: "The potential of SERS as an AST methodology in clinical settings." *Nanophotonics*, 2537–2561 (2021).
- S. Bernatová, K. Rebrošová, Z. Pilát, M. Šerý, A. Gjevik, O. Samek, J. Ježek, M. Šiler, M. Kizovský, T. Klementová, V. Holá, F. Růžička, P. Zemánek: "Rapid detection of antibiotic sensitivity of *Staphylococcus aureus* by Raman tweezers." *Eur. Phys. J. Plus*, **136**, 233 (2021).
- A. Němcová, D. Gonová, O. Samek, M. Sipiczki, E. Breierová, I. Márová: "The Use of Raman Spectroscopy to Monitor Metabolic Changes in Stressed *Metschnikowia sp. Yeasts*." *Microorganisms*, **9**, 277 (2021).
- Z. Pilát, A. Jonáš, J. Pilátová, T. Klementová, S. Bernatová, M. Šiler, T. Maňka, M. Kizovský, F. Růžička, R. Panůček, U. Neugebauer, O. Samek, P. Zemánek: "Analysis of bacteriophage-host interaction by Raman tweezers." *Analytical Chemistry*, **92**, 12304–12311 (2020).
- K. Rebrošová, M. Šiler, O. Samek, F. Růžička, S. Bernatová, J. Ježek, P. Zemánek, V. Holá: "Identification of ability to form biofilm in *Candida parapsilosis* and *Staphylococcus epidermidis* by Raman spectroscopy." *Future Microbiology*, **14**, 509–517 (2019).
- S. Bernatová, Donato M. Grazia, J. Ježek, Z. Pilát, O. Samek, A. Magazzu, OM. Maragò, P. Zemánek, PG. Gucciardi: "Wavelength-Dependent Optical Force Aggregation of Gold Nanorods for SERS in a Microfluidic Chip." *J. Phys. Chem. C*, **123**, 5608–5615 (2019)

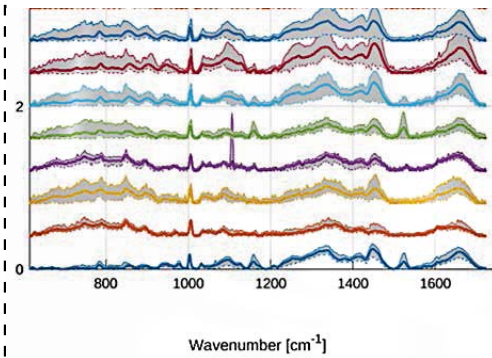
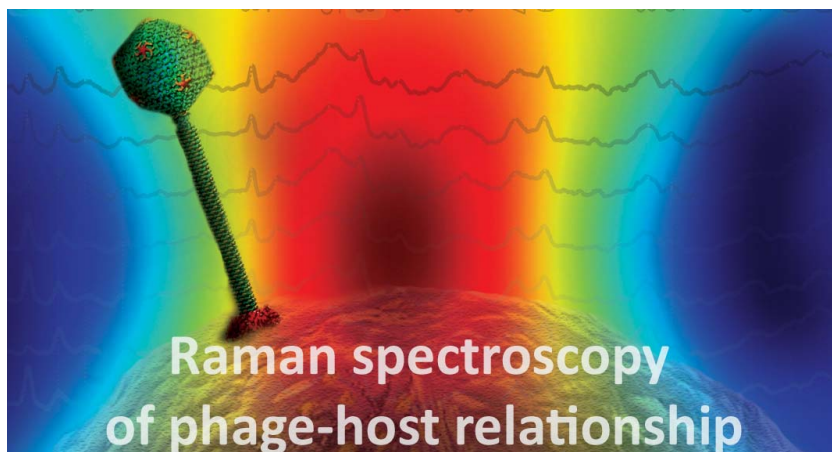

Selected Raman spectra of *Staphylococcus* species from our spectral library used for identification employing techniques of artificial intelligence.

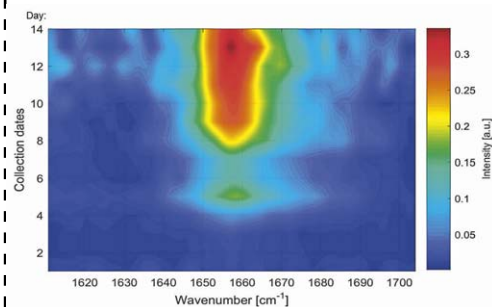

Spectral map of *Metschnikowia andauensis*, plotted using Raman signal intensities of unsaturated oil indicators during 14 days of cultivation. The map monitors the unsaturated oil content within the cells.

We have a system for Raman spectroscopic analysis of the relationship between a bacteriophage and its host bacterium. Raman spectroscopy combined with optical tweezers provides real-time, non-invasive measurement of the biochemical changes that occur in a single bacterium during the various phases of the phage infection.

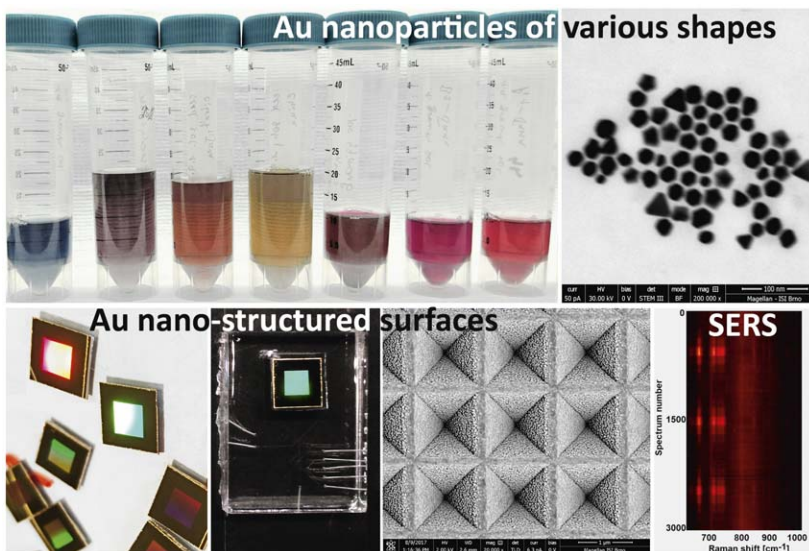

We create Au nanoparticles of various sizes and nanostructured surfaces optimized for surface-enhanced Raman spectroscopy (SERS). We use SERS for highly sensitive detection of extremely dilute analytes, such as pesticide residues, secondary metabolites, or individual bacteria.

- O. Samek, K. Mlynáriková, S. Bernatová, J. Ježek, V. Krzyžánek, M. Šiler, P. Zemánek, F. Růžička, V. Holá, M. Mahelová: "Candida parapsilosis biofilm identification by Raman spectroscopy". *Int. J. Mol. Sci.* **15**, 23924–23935, 2014.
- K. Mlynáriková, O. Samek, S. Bernatová, F. Růžička, J. Ježek, A. Haroniková, M. Šiler, P. Zemánek, V. Holá: "Influence of culture media on microbial fingerprints using Raman spectroscopy". *Sensors* **15**(11), 29635–29647, 2015.
- S. Bernatová, O. Samek, Z. Pilát, M. Šerý, J. Ježek, P. Jákl, M. Šiler, V. Krzyžánek, P. Zemánek, V. Holá, M. Dvořáčková, F. Růžička: "Following the mechanisms of bacteriostatic versus bactericidal action using Raman spectroscopy". *Molecules* **18**(11), 13188–13199, 2013.

■ Applications to microorganisms containing polymers and algae

- M. Kizovský, Z. Pilát, M. Mylenko, P. Hrouzek, J. Kuta, R. Skoupý, V. Krzyžánek, K. Hrubanová, O. Adamczyk, J. Ježek, S. Bernatová, T. Klementová, A. Gjevik, M. Šiler, O. Samek, P. Zemánek: "Raman Microspectroscopic Analysis of Selenium Bioaccumulation by Green Alga *Chlorella vulgaris*." *Biosensors*, **11**, 115 (2021).
- S. Obruča, P. Sedláček, F. Mravec, V. Krzyžánek, J. Nebesářová, O. Samek, D. Kucera, P. Benešová, K. Hrubanová, M. Milerová, I. Márová: "The presence of PHB granules in cytoplasm protects non-halophilic bacterial cells against the harmful impact of hypertonic environments". *New Biotechnology* **39**, 68–80, 2017.

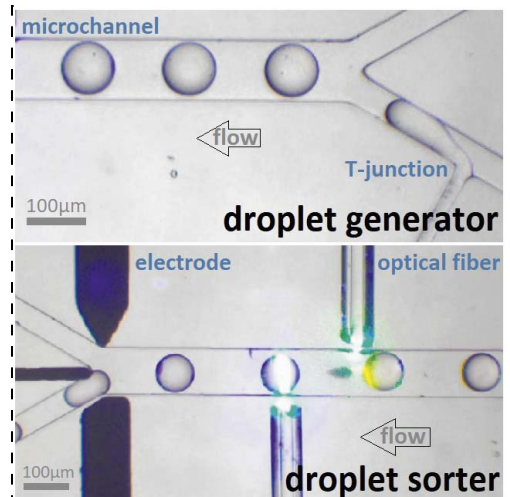

In digital microfluidics, emulsion droplets are used as miniature test tubes, each with a separate chemical reaction, or a living cell. The droplets are generated in the T-junction, incubated, analyzed via optical fiber and automatically sorted (based on fluorescence or Raman spectra) into different output channels by electric pulses. We use droplets for analysis of enzymatic reactions involving dehalogenases.

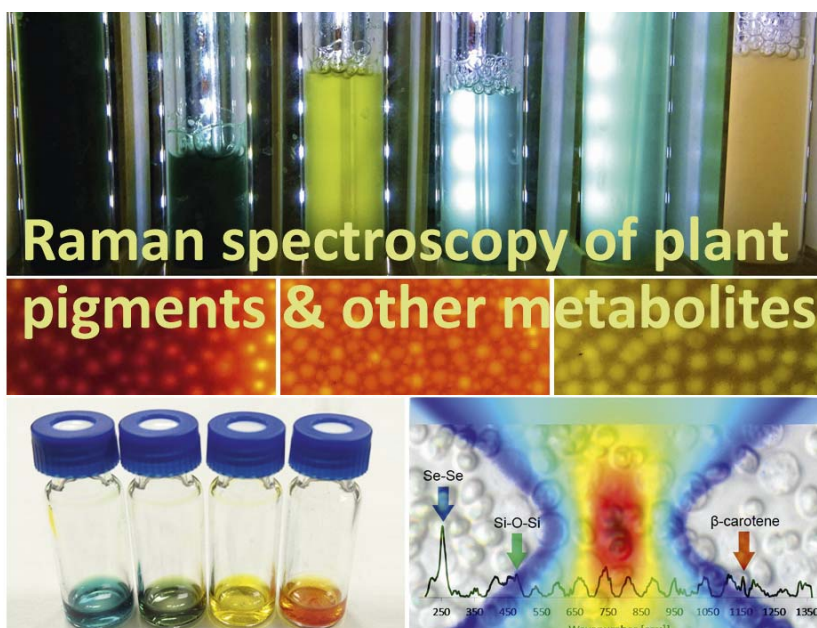

We have know-how in Raman spectroscopy of algal and plant pigments and various other metabolites and biomolecules in general. We specialize in development of complex instrumentation hardware, software and methods for specific Raman-based analytical tasks.

- Z. Pilát, A. Jonáš, J. Ježek, P. Zemánek: “Effects of Infrared Optical Trapping on *Saccharomyces cerevisiae* in a Microfluidic System”. *Sensors* **17**, 2640, 2017.
- O. Samek, S. Obruca, M. Šiler, P. Sedlacek, P. Benesova, D. Kucera, I. Marova, J. Jezek, S. Bernatova, P. Zemanek: “Quantitative Raman Spectroscopy Analysis of Polyhydroxyalkanoates Produced by *Cupriavidus necator* H16”. *Sensors* **16**, 2016

■ Optofluidic applications

- Z. Pilát, M. Kizovský, J. Ježek, S. Krátký, J. Sobota, M. Šiler, O. Samek, T. Buryška, P. Vaňáček, J. Damborský, Z. Prokop, P. Zemánek: “Detection of chloroalkanes by surface-enhanced Raman spectroscopy in microfluidic chips.” *Sensors*, **18**, 3212 (2018).
- T. Buryška, M. Vašina, F. Gielen, P. Vaňáček, L. Van Vliet, J. Ježek, Z. Pilát, P. Zemánek, J. Damborský, F. Hollfelder, Z. Prokop: “Controlled oil/water partitioning of hydrophobic substrates extending the bioanalytical applications of droplet-based microfluidics.” *Analytical Chemistry*, **91**, 10008–10015 (2019).
- A. Jonáš, Z. Pilát, J. Ježek, S. Bernatová, P. Jedlička, M. Aas, A. Kiraz, P. Zemánek: “Optically transportable optofluidic microlasers with liquid crystal cavities tuned by the electric field.” *ACS Applied Materials & Interfaces*, **13**, 50657–50667 (2021).
- A. Jonáš, Z. Pilát, J. Ježek, S. Bernatová, T. Fořt, P. Zemánek, M. Aas, A. Kiraz: “Thermal tuning of spectral emission from optically trapped liquid-crystal droplet resonators.” *J. Opt. Soc. Am. B*, **34**, 1855–1864 (2017).
- M. Šiler, J. Ježek, P. Ják, Z. Pilát, P. Zemánek: “Direct measurement of the temperature profile close to an optically trapped absorbing particle.” *Optics Letters*, **41**, 870–873 (2016).
- Z. Pilát, S. Bernatová, J. Ježek, J. Kirchhoff, A. Tannert, U. Neugebauer, O. Samek, P. Zemánek: “Microfluidic cultivation and laser tweezers Raman spectroscopy of *E. coli* under antibiotic stress.” *Sensors*, **18**, 1623 (2018).

MAIN COLLABORATING PARTNERS

Collaboration with academic partners

- Brno University of Technology (Brno, CZ)
- Consiglio Nazionale delle Ricerche (Messina, IT)
- Institute of Experimental Physics, Slovak Academy of Sciences (Košice, SK)
- Masaryk University (Brno, CZ)
- Universität für Bodenkultur (Wien, Austria)
- University of Graz (Graz, Austria)
- University of Life Sciences (As, Norway)
- University of Naples Federico II (Naples, IT)
- University of Jena (Jena, Germany)
- IPHT Jena (Jena, Germany)

Collaboration with companies

- Photon Systems Instruments (Drásov, CZ)
- Meopta (Prerov, CZ)

EXPECTATIONS

Offers

- We offer collaboration in the areas of our expertise
- Partnership in international projects
- Custom manufacturing of microfluidic chips

Requirements

We would like to cooperate with academic partners as well as companies in the fields of optics, biophotonics, biotechnology, microtechnologies and applications of microfluidic chips.

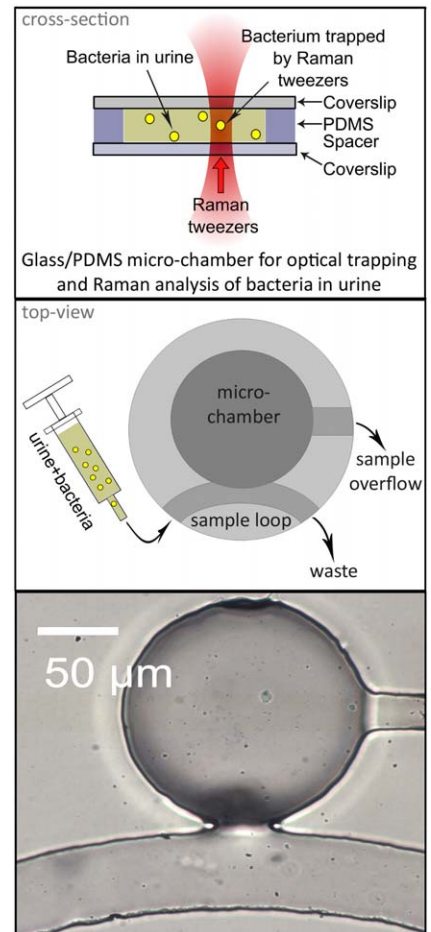

We use microfluidic systems for optical trapping and Raman spectroscopy of individual bacteria in clinical samples (e.g. urine) or in cultivation media. The cells can be automatically identified, sorted and separated based on their Raman spectra.

R&D PROFILE

Research area

- Optical design
- Precise mechanics
- Optical lithography
- Spectroscopy
- Multispectral and hyperspectral imaging
- Integrated photonics
- Machine learning and artificial intelligence
- Surface topography and local mechanical properties

Excellence

- Opto-mechanical design of optical instruments
- Two-photon lithography techniques on in house developed systems
- Hyperspectral microscopy and imaging spectrography systems
- On-demand design and manufacturing of imaging and spectroscopy systems
- Photonics system and integrated optics design and manufacturing

Mission

Using our knowledge, we design and fabricate micro-optical elements including devices for their production.

Integration of micro-optics, photonic optics and bulk optics into scientific instruments opens new possibilities to develop new classes of systems for understanding more about matter interaction and allows us complex investigation of biological and chemical processes in the samples and also miniaturization of the instruments.

Currently, our team is concentrated on the development of advanced imaging and hyperspectral imaging systems using specially designed optical elements. These are widely applicable in plant agriculture and microbiology.

We also work on image processing software to analyze morphological composition at a sub-micrometer scale. We process large datasets acquired by our instruments using machine learning algorithms.



Illustration photo of a hyperspectral camera being used in the field.

**Institute of Scientific Instruments
of the CAS, v.v.i.**

Czech Academy of Sciences

Královopolská 147, 612 64 Brno,
Czech Republic

<http://aip.isibrno.cz>

Head: Dr. Mojmir Šerý

Phone: +420 541 514 534

E-mail: sery@isibrno.cz

Head of the Department:

Prof. Pavel Zemánek

Phone: +420 541 514 202

E-mail: zemanek@isibrno.cz

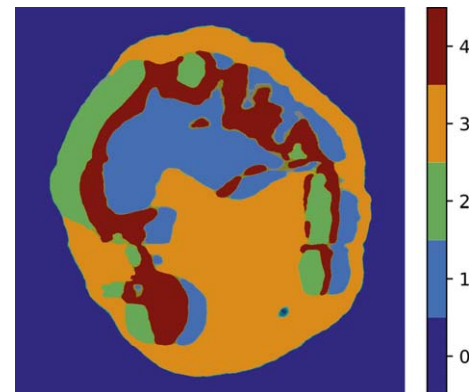

Hyperspectral imaging allows us to locate areas with a similar spectral response.

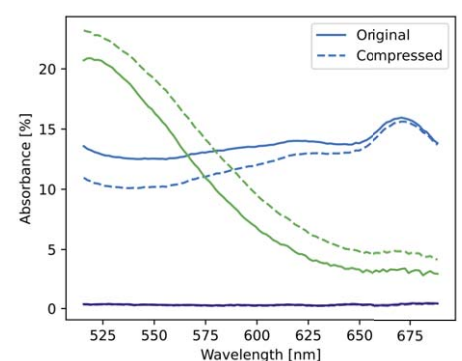

Hyperspectral data can be compressed using ML methods without significant loss of spectral attributes.

UP-TO-DATE ACTIVITIES

New technologies in hyperspectral imaging

- Development of imaging spectrographs with submicron spectral resolution
- Development of snapshot imaging spectrographs
- Design of MEMS based spectrographic systems
- Software development based on machine learning and artificial intelligence that allow fast spatial and spectral recognition of objects
- Hyperspectral imaging is useful for inline sorting and quality control

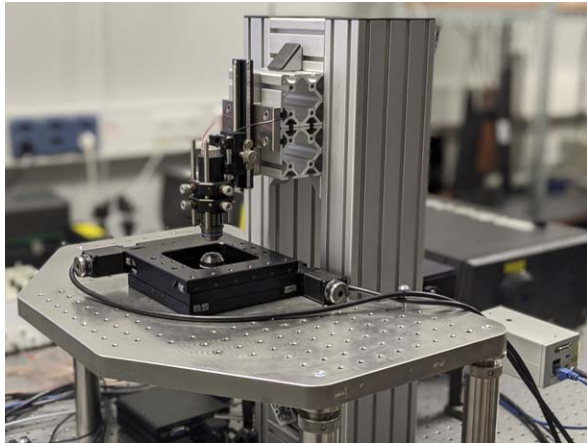

Developed hyperspectral microscope for cell examination.

Single and two-photon lithography

- Single photon large volume lithography system with a digitally addressable projection system for biological and material applications
- High accuracy positioning of sample stage and objective using an interferometric closed loop
- Precision two-photon lithography system with acousto-optics laser beam steering system for very fast and accurate microstructures writing
- Development of writing strategies and special techniques for high-volume, high-resolution printing
- Interference and holographic recording of microstructures using modulators and DLP technology
- Beam shaping of writing beam by spatial modulators
- Refraction and diffraction optics design and manufacturing

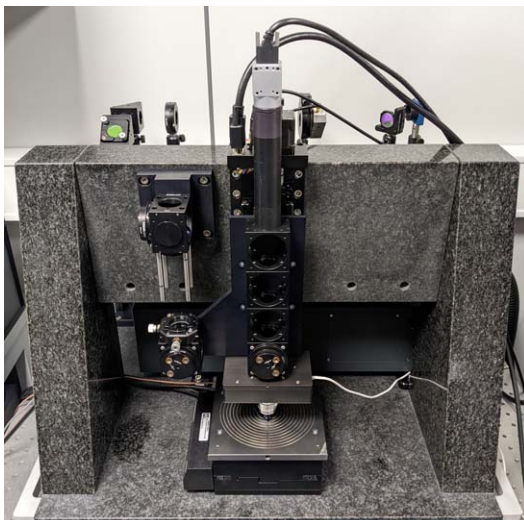

Experimental two-photon lithography system.

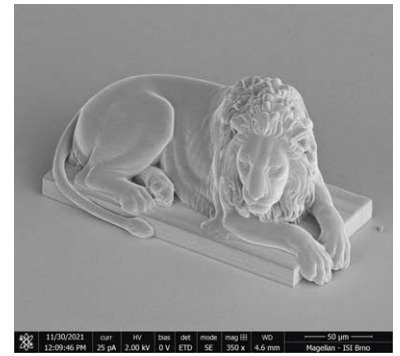

Structure of lion prepared by two photon lithography system. With permission of IQSnano.

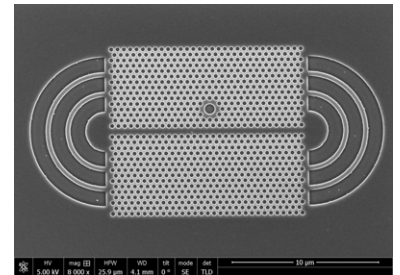

Photonic element designed to trap particles (SEM image).

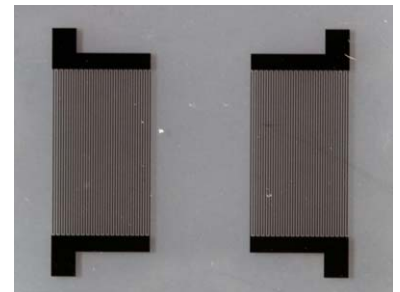

Gold electrodes on LiNbO₃ designed to generate standing surface acoustic wave (SSAW).

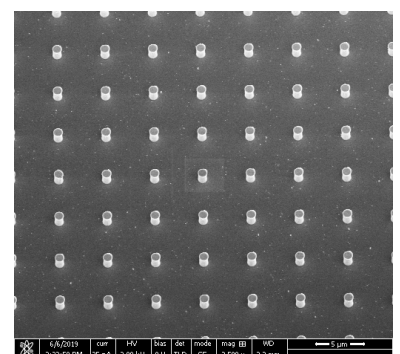

Sub-micrometer columns, prepared into silicon by reactive ion etching.

Applied and integrated photonics

- Compact optical tweezers system with MEMS steering optics and optomechanics for biomedical applications
- The use of photolithographic methods, wet and dry etching to produce optical elements, microfluidics and metasurfaces
- Microchip for optical trapping of micro-objects under low pressure
- Metaoptics structures for aberration-free imaging and spectroscopy systems
- Inspection by Scanning Probe Microscopy with emphasis on the surface topography of prepared nanostructures and films & coatings
- Determination of mechanical properties such as elastic modulus, hardness or film adhesion by nanoindentation measurements and scratch testing
- Microfluidic acoustic wave based sorting chips
- Arbitrary shaped optical gratings and micro-optical elements.

We are involved in achieving synergy between optomechanics and integrated photonics to create systems with better functionality and properties.

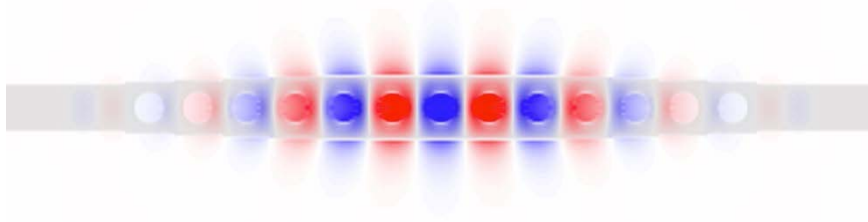

Electric field mode profile of photonic crystal nanobeam cavity for optical trapping.

KEY RESEARCH EQUIPMENT

List of devices

- Hyperspectral VNIR and SWIR microscope system
- Single photon lithography system
- Two-photon lithography system
- Deep reactive ion etching system
- Spin coating system, wet benches, hot plates, class ISO 2 cleanroom facility
- Digital Light Processing printer, FDM printer, CNC machine
- Optical metrology equipment
- Lasers, microscopes, precision motorized stages, optics tables, etc

ACHIEVEMENTS

Articles

- PLICHTA, T., R. ZAHRADNICEK and V. CECH. 2022. *Surface topography affects the nanoindentation data*. Thin Solid Films. 745.
- PLICHTA, T., V. SIRJOVOVA, M. ZVONEK, G. KALINKA and V. CECH. 2021. *The adhesion of plasma nanocoatings controls the shear properties of GF/polyester composite*. Polymers. 13(4).
- TRAEGAARDH, J., T. PIKALEK, M. SERY, T. MEYER, J. POPP and T. CIZMAR. 2019. *Label-free CARS microscopy through a multimode fiber endoscope*. Optics Express. 27(21).
- JAKL, P., T. CIZMAR, M. SERY and P. ZEMANEK. 2008. *Static optical sorting in a laser interference field*. Applied Physics Letters. 92(16).
- CIZMAR, T., M. SILER, M. SERY, P. ZEMANEK, V. GARCES-CHAVEZ and K. DHOLAKIA. 2006. *Optical sorting and detection of submicrometer objects in a motional standing wave*. Physical Review B. 74(3).

Utility model

- Compact optical tweezers modules compatible with a majority of optical microscopes (utility model awarded in cooperation with Meopta-Optika)



Compact device for creating optical tweezers attachable to a Raman microscope.

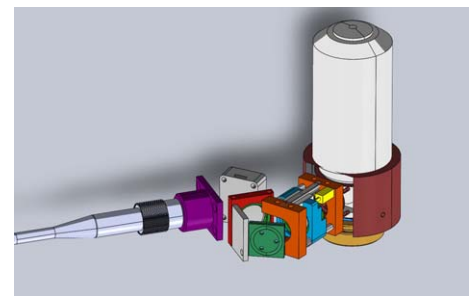

CAD model of optical tweezers with MEMS mirror used for beam steering.

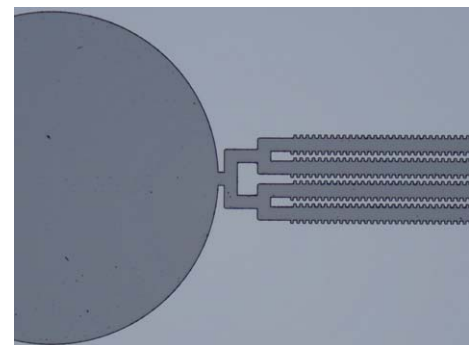
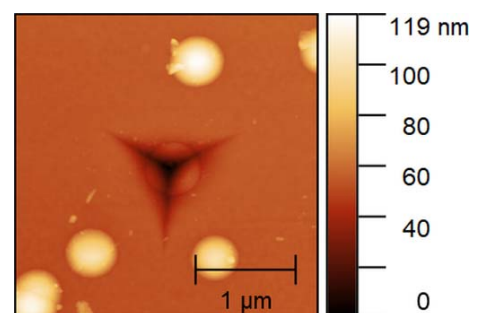
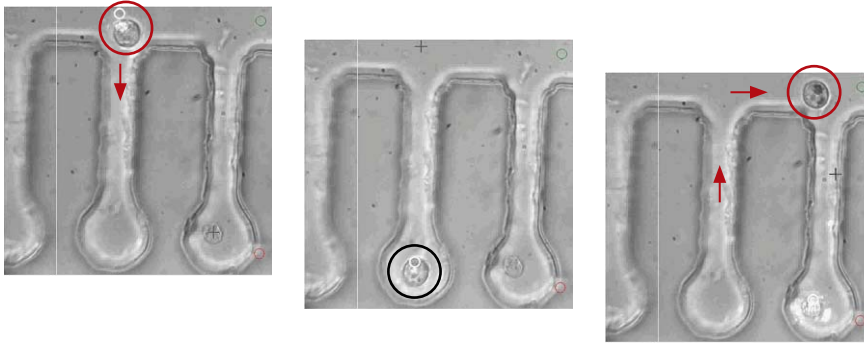

Image of a microfluidic channel observed by optical microscope.



Surface topography of indent residual imprint observed by AFM on top of a-CSi:H grain.



Algae cells inside incubation microfluidic channel can be manipulated by steerable optical tweezers system of our design. Red arrows indicate the direction of movement induced by the optical tweezers.

MAIN COLLABORATING PARTNERS

Collaboration with academic and industrial partners

- Brno University of Technology (Brno, CZ)
- Charles University (Prague, CZ)
- Consiglio Nazionale delle Ricerche (Messina, IT)
- Masaryk University (Brno, CZ)
- Institute of Experimental Physics, Slovak Academy of Sciences (Košice, SK)
- Photon Systems Instruments (Drásov, CZ)
- IQS nano (Brno, CZ)
- Meopta (Přerov, CZ)

EXPECTATIONS

Offers

We offer to share our expertise in the areas of spectroscopy, imaging, optical lithography, applied and integrated optics.

Requirements

We look for cooperation with academic and industrial partners in the fields of spectroscopy, micro and nano optics development and manufacturing.

FUNDING

HyPerSpec - Development of Hyperspectral Camera for Biotechnology Applications and Element Analysis, FV40455 Ministry Industry and Trade CR

Technology for Advanced Optics and Its Industrial Application, CZ.01.1.02/0.0/0.0/19_262/0020294 Ministry Industry and Trade CR.

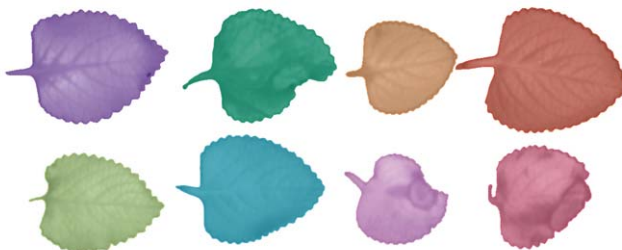

Multispectral images provide information about object reflectance in wide spectral bands. By comparing their values, we can monitor plant vitality and stress.

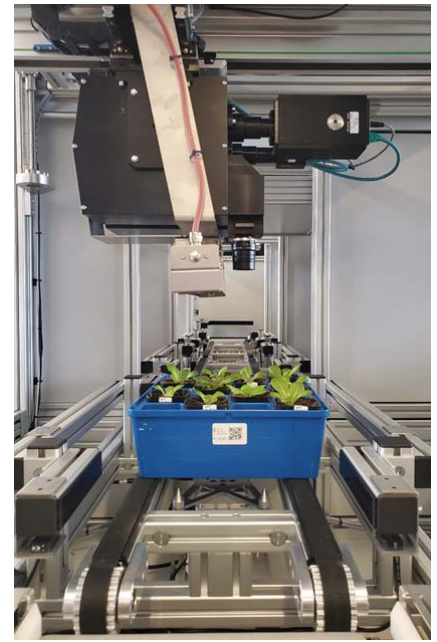

Hyperspectral camera system used for inline monitoring of plant vitality based on spectral reflectance.

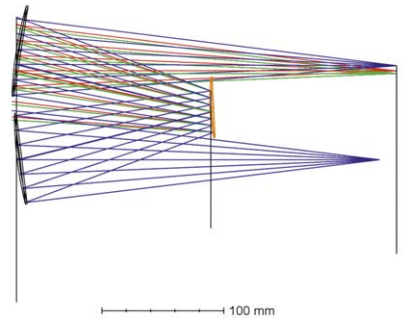

Optical design simulation of hyperspectral camera.

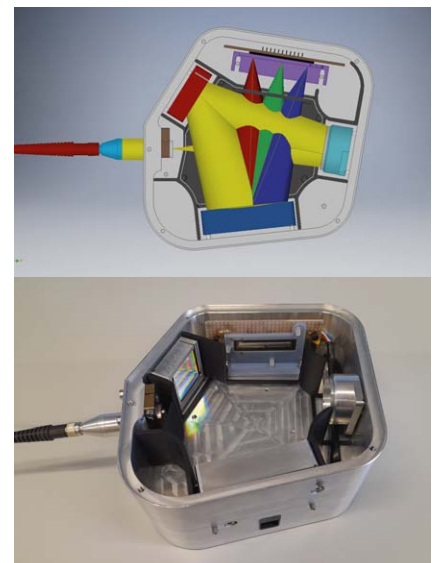

Custom-designed Czerny-Turner spectrometer from off the shelf components.

Group of Coherent Lasers and Interferometry

Department of Coherence Optics



Institute of Scientific
Instruments
The Czech Academy
of Sciences

THEMATIC RESEARCH FOCUS

Research area

Fundamental optical metrology

- Optical ion clocks
- Femtosecond laser based optical frequency synthesis
- Standards of optical frequencies and distribution of highly stable optical frequencies
- High resolution interferometry and nanometrology

Industrial metrology and measuring methods

- Industrial interferometry
- Optical sensing and measuring techniques
- Fibre Bragg grating based fibre-optic sensors

Special instrumentation in optics and electronics

Excellence

- Quantum mechanics with trapped Calcium ions with the goal of development of optical laser oscillator
- Optical frequency synthesis with a technique of locking optical frequency to a mechanical standard
- Technology of time and frequency transfer through long haul optical networks
- Contactless gauge blocks calibration and diagnostics combining through novel interferometric technique
- High resolution interferometry for nanometrology
- Refractometry and interferometry with compensation for variations of the refractive index of air
- World leader in technology of high purity absorption cells for fundamental metrology
- Methods and techniques for industrial dimensional optical metrology
- Fibre strain and deformation sensing via a of FBG strain sensors
- Real-time dissemination of process values via industrial networks (CANbus and Ethernet)

Institute of Scientific Instruments
of the ASCR, v. v. i.

The Czech Academy of Sciences
Královopolská 147, 612 64 Brno,
Czech Republic
www.isibrno.cz/kgs

Head: Dr. Ondřej Číp

Phone: +420 541 514 254

E-mail: Ondrej.Cip@isibrno.cz

Head of the department: Prof. Josef Lazar

Phone: +420 541 514 253

E-mail: Josef.Lazar@isibrno.cz

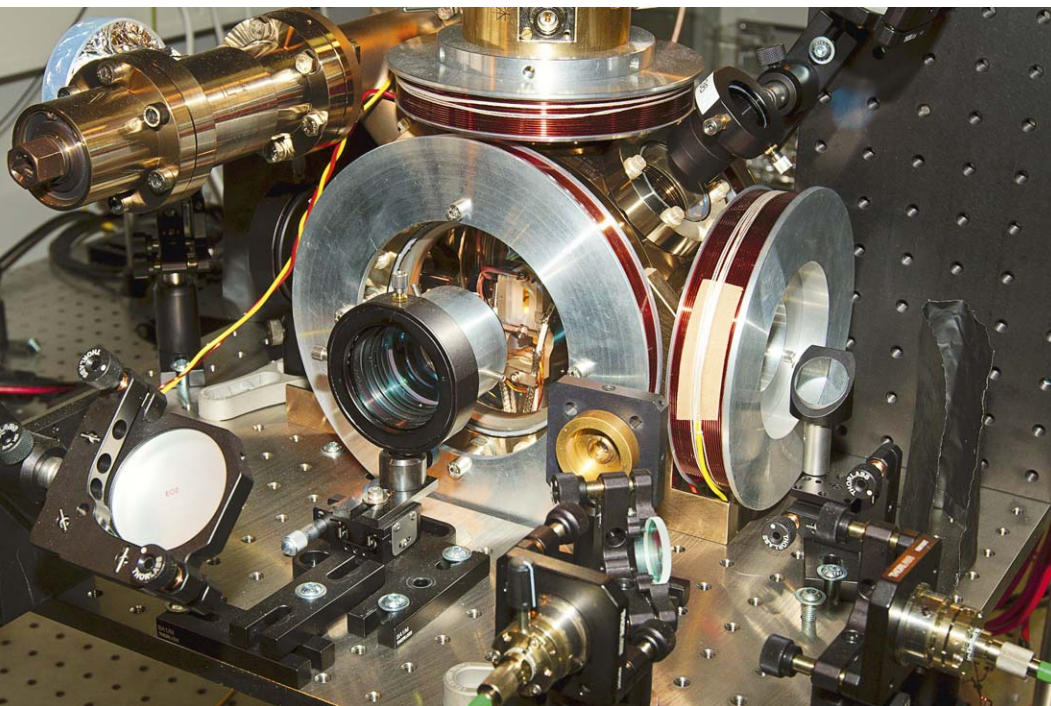

Experimental arrangement of the ion trap for Calcium ions oriented to development of ultrastable laser optical frequency standard

Mission

Our mission is research on the border between physics and technical sciences, which includes fundamental, targeted and applied research as well. Our research is methodologically oriented. The goal of most of our projects is an introduction of a novel method, technique or approach and its experimental verification. This includes design of often highly complex and sophisticated experimental assemblies. In optical metrology it often means pushing the limits of resolution and precision. Fundamental research in our case means predominantly research in fundamental metrology. Our involvement in applied research is motivated by the tradition of the institute, which has always tried to promote technology transfer and applications of its research in practice.

DEVELOPED TECHNOLOGIES

Content of research

- Stabilized lasers – standards of optical frequencies for fundamental and industrial metrology and interferometry
- Laser interferometric systems for coordinate measurement and various special applications
- References of optical frequencies – absorption cells for metrology and laser spectroscopy
- Technology and electronic control systems for femtosecond laser based optical frequency synthesis
- Special optical sensors for various applications
- Technology and electronic control of phase coherent optical frequency transfer via fiber links
- Laser induced fluorescence for body fluid level measurement and tissue necrosis detection
- Electronics and control electronics for experiments and special instrumentation
- Methodology and instrumentation for contactless gauge blocks calibration and diagnostics
- Design, fabrication and employment of Fibre Bragg Grating (FBG) elements for length measurement

Main capabilities

- Technology of ultra-precise measurement of lengths with stable, tuneable and femtosecond lasers
- Methods of suppression of fluctuation of the refractive index of air for length measurement in the air
- Interferometry using a novel digital derivative technique for detection of the interference signal
- Method for scale linearization of interference fringe for ultra-precise laser interferometry
- Techniques of locking tuneable lasers to optical frequency components of femtosecond laser spectrum
- Technology of high purity absorption gas cell production (also custom-made) and high purity gas production.
- Methods for real-time dissemination of process values through network (CAN-bus and Ethernet)

Fields of research results application

- Optics
- Precision engineering
- Medical technology
- Automotive industry
- Software
- Telecommunications



Operation of the Hydrogen maser – a radiofrequency reference



Controller and supporting circuitry for single-frequency laser diode operating in the visible spectral range



Highly coherent semiconductor laser for the telecommunication applications

Stabilized laser source designed as optical frequency reference in the near-infrared spectral range

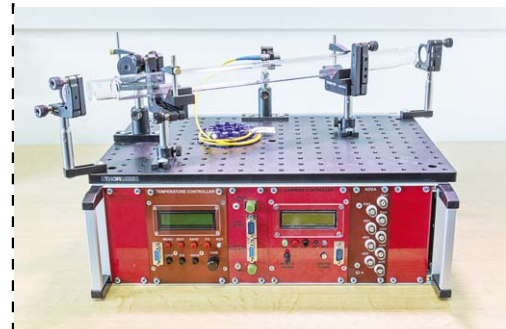

KEY RESEARCH EQUIPMENT

List of devices

- Optical frequency synthesizers (optical “combs”) based on femtosecond lasers (visible and IR)
- Set of optical frequency standards operating at 532 nm, 633 nm and 1550 nm wavelengths
- Active H-maser – highly stable radiofrequency time and frequency standard
- Laboratory instrumentation for experiments with optics, vacuum technology and electronics

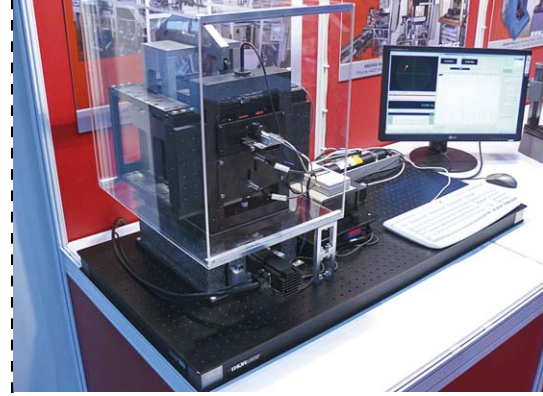

Nanocomparator for interferometric calibration of displacement sensors for the automotive industry

ACHIEVEMENTS

■ A method for non-linearity compensation of interference fringes in homodyne laser interferometer

- O. Číp, F. Petrů: “A scale-linearization method for precise laser interferometry”, MEASUREMENT SCIENCE & TECHNOLOGY **11**, 133-141, 2000

■ A method for the suppression of refractive index of air fluctuation in interferometric measurement of precise length

- J. Lazar, M. Holá, O. Číp, M. Čížek, J. Hrabina, Z. Buchta: “Displacement interferometry with stabilization of wavelength in air”, OPTICS EXPRESS **20**, 27830–27837, 2012

■ Tunable extended cavity laser (ECL) as an optical frequency standard working at 633 nm

- J. Lazar, O. Číp, P. Jedlička: “Tunable extended cavity laser (ECL) as an optical frequency standard working at 633 nm”, APPLIED OPTICS **39**, 3085-3088, 2000

■ A method for the measurement of coefficient of thermal expansion of stable materials (Zerodur, ULE)

- O. Číp, R. Šmíd, M. Čížek, J. Lazar: “Study of the thermal stability of Zerodur glass ceramics suitable for a scanning probe microscope”, CENTRAL EUROPEAN JOURNAL OF PHYSICS, **10**, 447–453, 2012

■ A novel method of contactless gauge block calibration by combination of coherent light and white light produced by mode-locked laser

- Z. Buchta, S. Řeřucha, B. Mikel, M. Čížek, J. Lazar, O. Číp: “Novel Principle of Contactless Gauge Block Calibration”, SENSORS **12**, 3350-3358, 2012

■ Gold medal of 54th International Engineering Fair in Brno (2012) for Contactless laser interferometer system for gauge block calibration by combination of coherent light and white light produced by picosecond laser (in cooperation with an industrial partner – the Mesing company)

■ Werner von Siemens Excellence Award (2012) for Novel method of contactless gauge block calibration by combination of coherent light and white light produced by mode-locked laser

■ The editors of the Technický týdeník (Technical Weekly) along with the editors of the periodical Automatizace (Automatization) awarded their prize at the 50th International Engineering Fair in Brno (2008) to the joint team of researchers that developed the Laser nano-comparator. The research group for the first time presented a unique method for



Fibre-optic hub for distribution of precise optical frequencies

Positioning platform with six-axis interferometric measurement and motion control for nanometrology

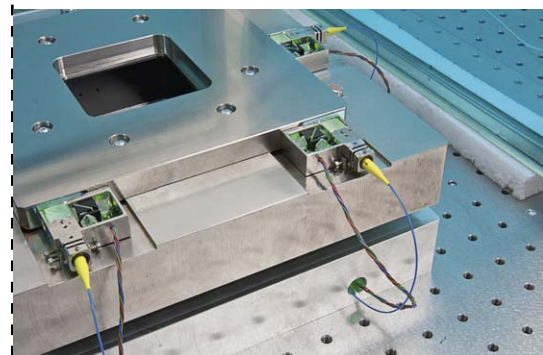

THEMATIC RESEARCH FOCUS

Research area

- Laser welding including wobbling, hybrid welding (Laser-MIG, Laser-TIG)
- Laser 2D/3D cutting
- Process diagnostics
- Micromachining with a picosecond power laser
- WAAM – 3D metal printing
- Numerical simulations of laser welding, hybrid welding and WAAM
- Optical layers

Excellence

- Diagnostics of laser welding process
- Numerical simulations
- Micromachining with IR, VIS and UV laser wavelengths

Mission

- Theoretical and experimental research of laser welding process
- Study, monitoring and control of the laser welding process
- Application of laser welding technology for the high-tech industry and green technology
- Application of picosecond micromachining for optical elements
- Thin optical layers for laser optics and interferometry

UP-TO-DATE ACTIVITIES

Research orientation/focus

- Study of the welding process by means of of back reflected radiation image processing
- Numerical simulations of laser welding process
- Study of microstructure and mechanical properties of 3D printed (WAAM) samples, WAAM simulations
- Picosecond laser micromachining of materials - IR, VIS and UV wavelengths

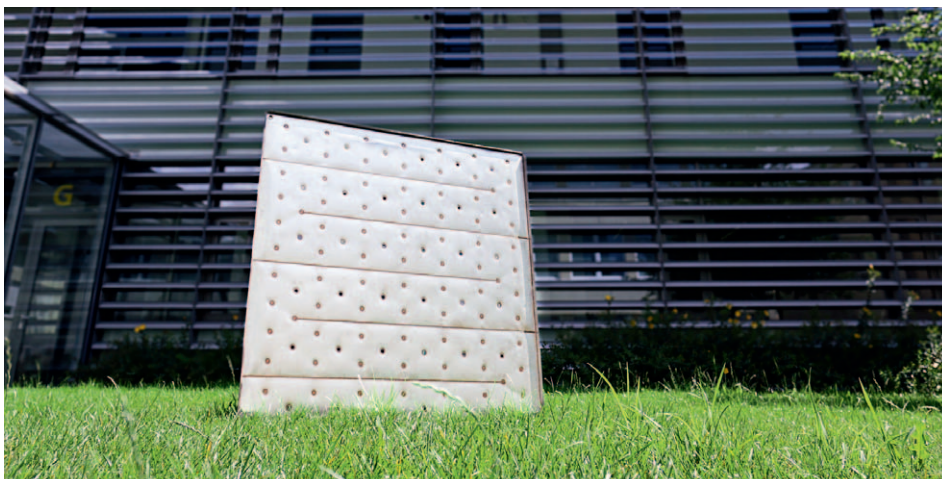

Laser welded solar collectors

**Institute of Scientific Instruments
of the CAS, v. v. i.**

The Czech Academy of Sciences
Královopolská 147, 612 64 Brno,
Czech Republic
<http://www.isibrno.cz/omitec/>

Head: Assoc. Prof. Libor Mrňa
Phone: +420 541 514 369,
+420 731 462 192
E-mail: mrna@isibrno.cz

- Development of optical elements using picosecond micromachining technology
- Theoretical and experimental study of laser induced damage threshold of thin film optical coatings

Main capabilities

Basic research

- Study of laser welding process based on image analysis of back reflected laser radiation
- Numerical modeling and simulations of welding, including hybrid processes
- Microstructural and mechanical characterization of samples 3D printed with WAAM technology
- Investigation of picosecond laser micromachining

Applied research

- New type of a sensor for monitoring of the laser welding process
- Hybrid laser welding technology
- New type laser welded heat exchangers and solar absorbers with controlled circulation
- Development of picosecond micromachining technology for the manufacturing of optical elements
- Laser induced damage threshold test station

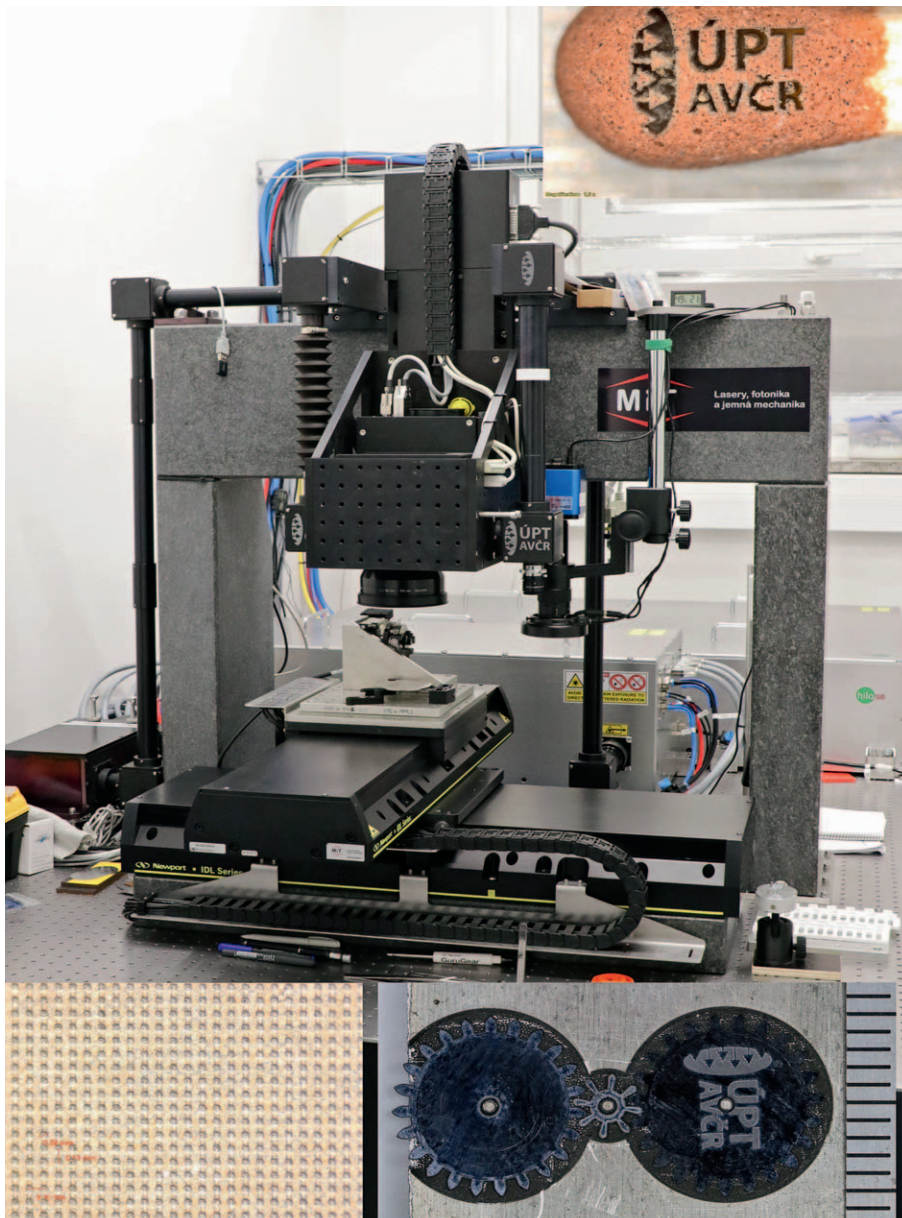

Micromachining station with a picosecond laser, rotary axis and two scanning heads (for 1070/515 nm and 257 nm).

Detail in the top right: example of “cold” engraving – match head with ISI logo.

Detail in the bottom left: microstructuring of stainless steel. Bottom right: Micromechanism on alumina pads with metal and silicon gears.

Innovations

- Licence agreement about utilization of methods of monitoring laser welding process based on patent CZ303797

Sub-fields of group activities

- Engineering industry related to modern methods of materials processing
- Renewable energy
- Materials science
- Optics for high-power lasers

KEY RESEARCH EQUIPMENT

List of devices

- Laser YLS2000 (IPG photonics)
- Welding head YW30 (Precitec)
- Cutting head YRC100, (Precitec)
- Wobble head IPG D30 (IPG photonics)
- Scanning welding head Fiber RHINO (ARGES)
- Robotic arm IRB2400 and 2-axis rotary positioner IRBP250 (ABB)
- Power picosecond laser Perla 100 IR, VIS, UV (HiLASE)
- Micromachining station (Newport)
- Infrared Camera FLIR A310
- BeamWatch BW-NIR-2-55 (Ophir)
- PIAD Electron beam evaporation coating system SYRUSpro 710 (Leybold Optics)
- Electron beam evaporation coating system Balzers BAK550
- Spectrophotometer Varian CARY 5E

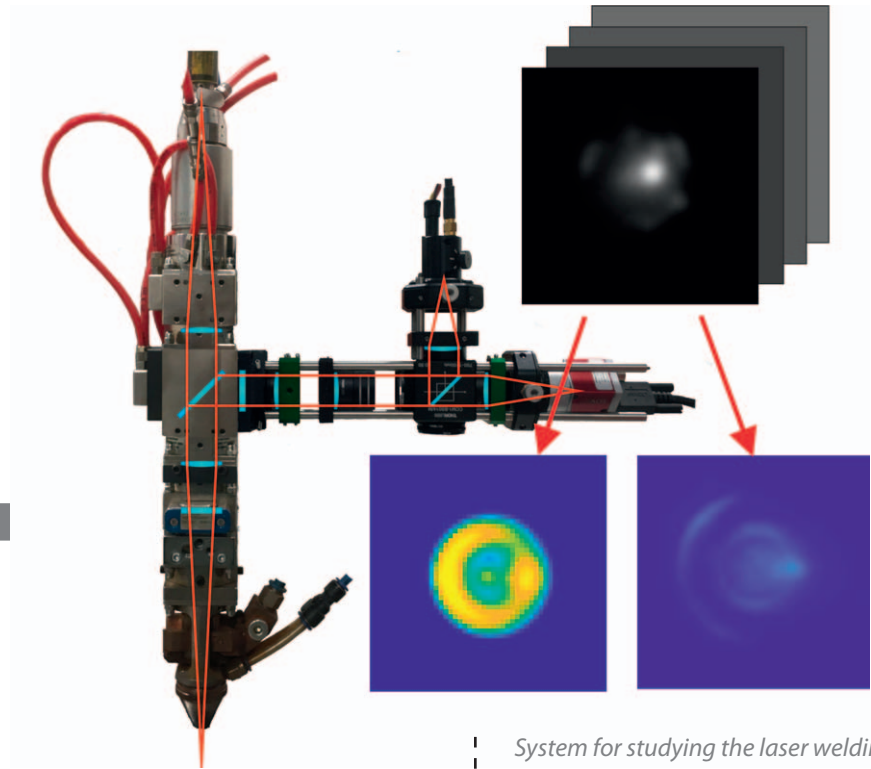

System for studying the laser welding process based on the analysis of backscattered laser radiation. Detail in the top right: set of shots from HS camera. Detail in the bottom right: evaluation of a set of images according to various statistical criteria.

ACHIEVEMENTS

- Šebestová H, Horník P, Mikmeková Š, Mrňa L, Doležal P, Novotný J. Microstructural Characterization of Laser Weld of Hot-Stamped Al-Si Coated 22MnB5 and Modification of Weld Properties by Hybrid Welding. *Materials*. 2021; 14(14):3943. <https://doi.org/10.3390/ma14143943>
- Šebestová H, Horník P, Mrňa L, Jambor M, Horník V, Pokorný P, Hutař P, Ambrož O, Doležal P. Fatigue properties of laser and hybrid laser-TIG welds of thermo-mechanically rolled steels. *Materials Science and Engineering: A*. 2020; 772: 138780. <https://doi.org/10.1016/j.msea.2019.138780>
- Darwish M, Mrňa L, Orazi L, Reggiani B. Modeling and analysis of the visualized gas-assisted laser cutting flow from both conical and supersonic nozzles. *International Journal of Advanced Manufacturing Technology*. 2020; 106: 4635–4644. <https://doi.org/10.1007/s00170-019-04915-4>
- Darwish M, Mrňa L, Orazi L, Reggiani B. Numerical modeling and Schlieren visualization of the gas-assisted laser cutting under various operating stagnation pressures. *International Journal of Heat and Mass Transfer*. 2020; 147: 118965. <https://doi.org/10.1016/j.ijheatmasstransfer.2019.118965>
- Horník P, Šarbort M, Šebestová H, Mrňa L. Study of the influence of focal position on back-reflected radiation during deep penetration laser welding and its simulation. *Optics and Measurement International Conference 2019. Proceedings of SPIE*. 2019; 11385: 1138505. <https://doi.org/10.1117/12.2542806>
- Mrňa L, Řiháček J, Šarbort M, Horník P. Solar absorber with a structured surface – A way to increase efficiency. *Acta Polytechnica*. 2019; 59 (2):134-143. <https://doi.org/10.14311/AP.2019.59.0134>

- Šebestová H, Horník P, Mrňa L, Doležal P, Mikmeková E. The Effect of Arc Current on Microstructure and Mechanical Properties of Hybrid LasTIG Welds of High-Strength Low-Alloy Steels. *Metallurgical and Materials Transactions B*. 2018; 49: 3559–3569. <https://doi.org/10.1007/s11663-018-1385-6>

MAIN COLLABORATING PARTNERS

Collaboration with academic partners

- Brno University of Technology (Brno, CZ)
- Masaryk University (Brno, CZ)

Collaboration with companies

- Tescan Orsay (Brno, CZ)
- EBZ Hoffmann (Ostržská n. Ves, CZ)
- Garrett motion CZ (Brno, CZ)
- Narran (Praha, CZ)
- Lascam (Praha, CZ)

EXPECTATIONS

Offers

- Licensing of the patent for automatic optimization of the laser beam geometry in laser welding
- Partnership in international projects
- Contractual research in laser welding, cutting, etc.
- Consulting in the field of laser welding, cutting, surface hardening etc.
- Cooperation in the development of solar absorbers and heat exchangers
- Design and production of custom thin film optical coatings
- Consulting in the field of optical coating deposition

Requirements

- Real interest in applied research and innovation
- Knowledge of grant projects
- Collaboration with industrial partners in common projects dedicated to applied science
- New complementary technologies

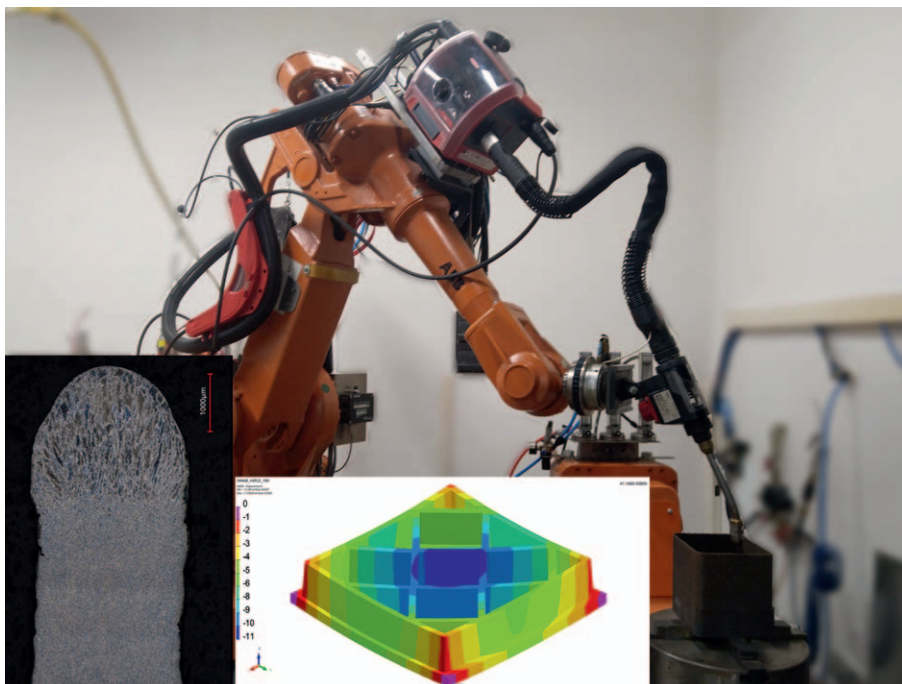

Robotic arm modified for 3D printing using the WAAM method.
 Detail on the left: microstructure of the deposited steel wall.
 Detail in the center: simulation of deformation of a deposited rib reinforcement.

EXPECTATIONS

Offers

- Licensing of the patent for automatic optimization of the laser beam geometry in laser welding
- Partnership in international projects
- Contractual research in laser welding, cutting, etc.
- Consulting in the field of laser welding, cutting, surface hardening etc.
- Cooperation in the development of solar absorbers and heat exchangers
- Design and production of custom thin film optical coatings
- Consulting in the field of optical coating deposition

Requirements

- Real interest in applied research and innovation
- Knowledge of grant projects
- Collaboration with industrial partners in common projects dedicated to applied science
- New complementary technologies

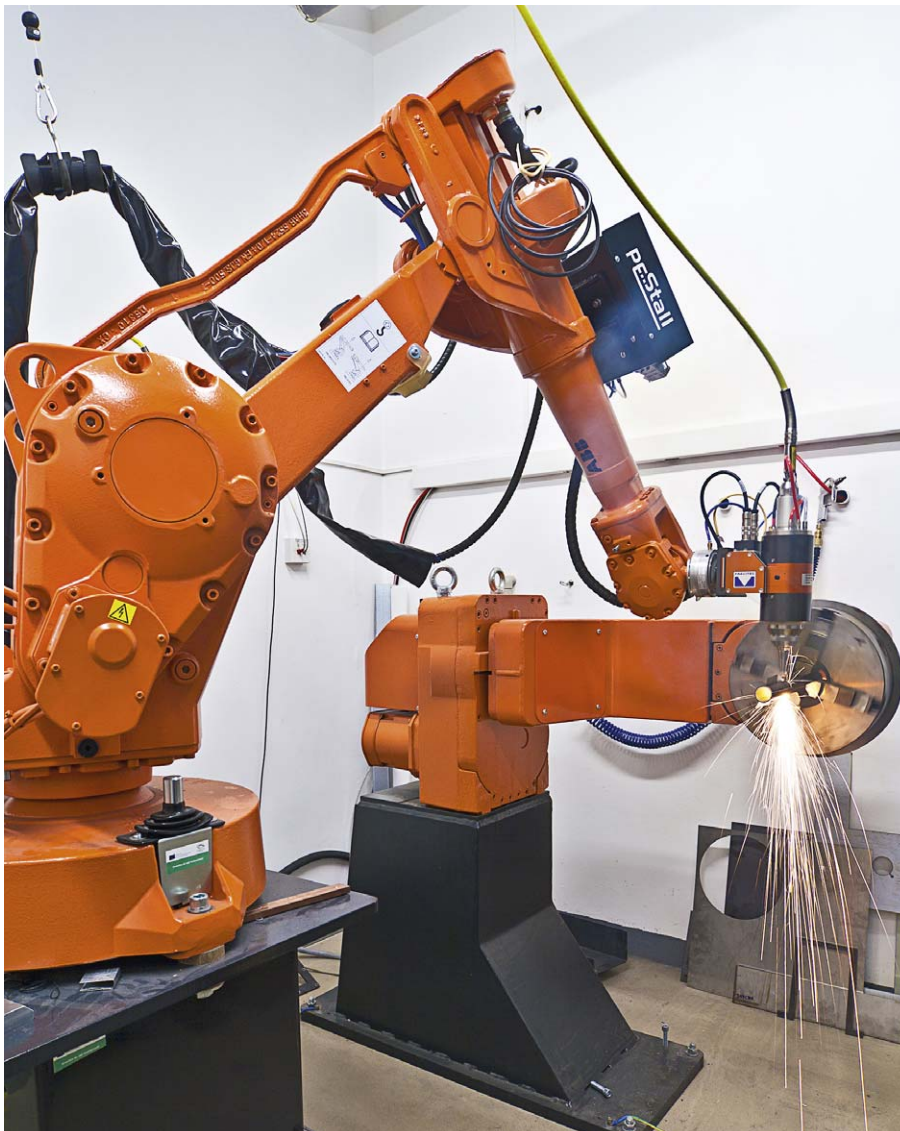

Laser cutting in action