

Leica CM1950

Cryostat

Instructions for Use
English

Order No.: 14 0477 80101 - Revision X

Always keep this manual with the instrument.
Read carefully before working with the instrument.

CE



The information, numerical data, notes and value judgments contained in this Instructions for Use represent the current state of scientific knowledge and state-of-the-art technology as we understand it following thorough investigation in this field.

We are under no obligation to update the present Instructions for Use periodically and on an ongoing basis according to the latest technical developments, nor to provide our customers with additional copies, updates etc. of this Instructions for Use.

To the extent permitted in accordance with the national legal system as applicable in each individual case, we shall not be held liable for erroneous statements, drawings, technical illustrations etc. contained in this Instructions for Use. In particular, no liability whatsoever is accepted for any financial loss or other consequential damage caused by or related to compliance with statements or other information in this Instructions for Use.

Statements, drawings, illustrations and other information regarding the contents or technical details of the present Instructions for Use are not to be considered warranted characteristics of our products.

These are determined only by the contract provisions agreed between ourselves and our customers.

Leica reserves the right to change technical specifications as well as manufacturing processes without prior notice. Only in this way is it possible to continuously improve the technology and manufacturing techniques used in our products.

This document is protected under copyright laws. All copyrights to this documentation are held by Leica Biosystems Nussloch GmbH.

Any reproduction of text and illustrations (or of any parts thereof) by means of print, photocopy, microfiche, web cam or other methods – including any electronic systems and media – requires express prior permission in writing by Leica Biosystems Nussloch GmbH.

For the instrument serial number and year of manufacture, please refer to the nameplate on the back of the instrument.



Leica Biosystems Nussloch GmbH

Heidelberger Strasse 17 - 19

69226 Nussloch

Germany

Tel.: +49 - (0) 6224 - 143 0

Fax: +49 - (0) 6224 - 143 268

Web: www.LeicaBiosystems.com

Table of Contents







1. Important Information	6
1.1 Symbols in the text and their meanings	6
1.2 Instrument type	10
1.3 Qualification of personnel	10
1.4 Intended purpose	10
2. Safety and Design	11
2.1 Safety notes	11
2.2 Warnings	11
2.3 General safety notes	12
2.4 Unpacking and installation	12
2.5 Safety devices	15
2.6 Securing/locking the handwheel	16
2.7 Cleaning, disinfection – Turning the instrument back on	18
2.8 Handling specimens – Defrosting	18
2.9 Removing the microtome	19
2.10 Maintenance	19
2.10.1 Replacing the fuses	19
2.10.2 Replacement of the UVC lamp	19
2.10.3 Cleaning up a broken UVC lamp	20
3. Technical Data	21
4. Standard Delivery	25
5. General Overview	28
5.1 Control panel fields and cryostat chamber	29
6. Installation	30
6.1 Site requirements	30
6.2 Transport to the site	30
6.3 Installing the handwheel	32
6.3.1 Locking/unlocking the handwheel	33
6.3.2 Installing the footswitch dummy (instruments with cutting motor)	34
6.4 Electrical connection	34
6.5 Installing accessories/inserting chamber accessories	35
6.5.1 Installing the adjustable footrest (optional)	35
6.5.2 Installing the storage systems (optional)	36
6.5.3 Shelf, movable (optional)	36
6.5.4 Inserting the section waste tray	37
6.5.5 Installing the heat extractor, stationary (optional)	37
6.5.6 Installing the knife/blade holder and adjusting the clearance angle	38
6.5.7 Inserting/changing the HEPA filter	39
6.5.8 Assembling the filter bag	39
6.5.9 Installing the section extraction (optional) – Use with blade holder CE only	40

7.	Instrument Controls	42
7.1	Control panels on the Leica CM1950	42
7.1.1	Control panel 1	42
7.1.2	Control panel 2 – Electric coarse feed, sectioning and trimming thickness	44
7.1.3	Control panel 3 – Motorized sectioning (optional)	46
8.	Working with the Instrument	49
8.1	Preparing cutting tools, specimen discs and preparation aids	49
8.2	Switching on the instrument.....	49
8.3	Configuring the parameters	50
8.4	Working with the precooled cryostat.....	54
8.4.1	Preparatory work.....	54
8.4.2	Trimming with extraction – 1. Anti-roll guide installed.....	56
8.4.3	Cutting with extraction – Anti-roll guide installed	59
9.	Troubleshooting	61
9.1	Problems during work.....	61
10.	Temperature selection chart	64
11.	Optional Accessories	65
11.1	Ordering information	65
12.	Maintenance and Cleaning	84
12.1	General maintenance instructions	84
12.2	Changing fuses.....	85
12.3	Replacing the UVC lamp	85
12.4	Replacement of LED illumination	90
13.	Decontamination Confirmation	91
14.	Warranty and service	92

1 Important Information

1. Important Information

1.1 Symbols in the text and their meanings

Symbol: 	Title of the symbol: Description:	Warning Warnings appear in a white box and are marked by a warning triangle.
Symbol: 	Title of the symbol: Description:	Note Notes, i. e. important user information, appear in a white box and are marked by an information symbol.
Symbol: 	Title of the symbol: Description:	Warning, biological hazard Instrument parts close to this symbol may be contaminated with substances that pose a threat to health. Avoid direct contact or use appropriate protective clothing.
Symbol: 	Title of the symbol: Description:	Warning, low temperature / freezing conditions Instrument parts close to this symbol are exposed to low temperatures / freezing conditions that pose a threat to health. Avoid direct contact or use appropriate protective clothing, e.g. frost protection gloves.
Symbol: 	Title of the symbol:	Caution – UVC radiation! Parts near this label emit ultraviolet radiation when UV disinfection is turned on. Avoid any unprotected contact.
Symbol: 	Title of the symbol: Description:	Caution: UVC lamp contains mercury The UVC lamp contains mercury, which poses a health hazard when released. Any damaged UVC lamp needs to be replaced immediately. Further safety measures apply. Follow the instructions in (→ p. 19 – 2.10.2 Replacement of the UVC lamp) and (→ p. 20 – 2.10.3 Cleaning up a broken UVC lamp) if a UVC lamp is damaged or even broken. Also follow the instructions of the manufacturer of the UVC lamp.
Symbol: 	Title of the symbol: Description:	Flammable freezing sprays prohibited This symbol alerts the user that the use of flammable freezing sprays in the cryostat chamber is prohibited due to explosion hazard.
Symbol: → "Fig. 7-1"	Title of the symbol: Description:	Item number Item numbers for numbering illustrations. Numbers in red refer to item numbers in illustrations.

Symbol:



Title of the symbol:

CE Label

Description:

The CE marking is the manufacturer's declaration that the medical product meets the requirements of the applicable EC directives and regulations.

Symbol:



Title of the symbol:

UKCA Label

Description:

The UKCA (UK Conformity Assessed) marking is a new UK product marking that is used for goods being placed on the market in Great Britain (England, Wales and Scotland). It covers most goods which previously required the CE marking.

Symbol:



Title of the symbol:

Serial number

Description:

Indicates the manufacturer's serial number so that a specific medical device can be identified.

Symbol:



Title of the symbol:

Article number

Description:

Indicates the manufacturer's catalog number so that the medical device can be identified.

Symbol:



Title of the symbol:

Consult Instructions for Use

Description:

Indicates the need for the user to consult the Instructions for Use.

Symbol:



Leica Microsystems (UK) Limited
Larch House, Woodlands Business Park, Milton Keynes
England, United Kingdom, MK14 6FG

Title of the symbol:

UK Responsible Person

Description:

The UK Responsible Person acts on behalf of the non-UK manufacturer to carry out specified tasks in relation to the manufacturer's obligations.

Symbol:



Title of the symbol:

Manufacturer

Description:

Indicates the manufacturer of the medical product.

Symbol:



Title of the symbol:

Manufacturing date

Description:

Indicates the date when the medical device was manufactured.

Symbol:



Title of the symbol:

In vitro diagnostic medical device

Description:

Indicates a medical device that is intended to be used as an in vitro diagnostic medical device.

Symbol:



Title of the symbol:

WEEE Symbol

Description:

The WEEE symbol, indicating separate collection for WEEE – Waste of electrical and electronic equipment, consists of the crossed-out wheeled bin (§ 7 ElektroG).

1 Important Information

Symbol:



Title of the symbol:

China RoHS

Description:

Environmental protection symbol of the China ROHS directive. The number in the symbol indicates the "Environment-friendly Use Period" of the product in years. The symbol is used if a substance restricted in China is used in excess of the maximum permitted limit.

Symbol:



Title of the symbol:

CSA Statement (Canada/USA)

Description:

The CSA test mark means that a product has been tested and fulfills the applicable safety and/or performance standards, including the relevant standards defined or administered by the American National Standards Institute (ANSI), Underwriters Laboratories (UL), the Canadian Standards Association (CSA), the National Sanitation Foundation International (NSF) and others.

Symbol:

Country of Origin: Germany

Title of the symbol:

Country of Origin

Description:

The Country of Origin box defines the country where the final character transformation of the product has been performed.

Symbol:



Title of the symbol:

Fragile; handle with care

Description:

Indicates a medical device that can be broken or damaged if not handled carefully.

Symbol:



Title of the symbol:

Keep dry

Description:

Indicates a medical device that needs to be protected from moisture.

Symbol:

Transport temperature range:

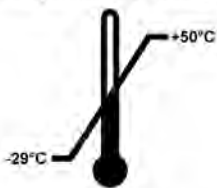

Title of the symbol:

Temperature limits for transport

Description:

Indicates the transport temperature limits to which the medical device can be safely exposed.

Symbol:

Storage temperature range:

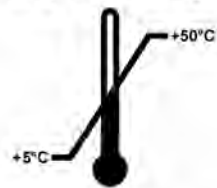

Title of the symbol:

Temperature limits for storage

Description:

Indicates the storage temperature limits to which the medical device can be safely exposed.

Symbol:



Title of the symbol:

Humidity limitation for storage and transport

Description:

Indicates the storage and transport range of humidity to which the medical device can be safely exposed.

Symbol:



Title of the symbol:

Do not stack

Description:

To indicate that the items shall not be vertically stacked, either because of the nature of the transport packaging or because of the nature of the items themselves.

Symbol:

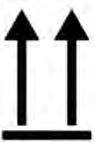

Title of the symbol:

This way up

Description:

To indicate correct upright position of the transport package

Symbol:

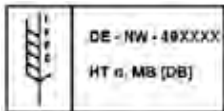

Title of the symbol:

IPPC

Description:

The IPPC symbol includes:

- IPPC symbol
- Country code in accordance with ISO 3166, e.g. DE for Germany
- Regional identifier, e.g. NW for North Rhine-Westphalia
- Registration number, unique number beginning with 49
- Treatment method, e.g. HT (heat treatment)

Symbol:



Title of the symbol:

Tilt indicator

Description:

Indicator to monitor whether the shipment has been transported and stored in upright position according to your requirements. With a pitch of 60° or more, the blue quartz sand flows into the arrow-shaped indicator window and sticks there permanently. Improper handling of the shipment is immediately detectable and can be proven definitively.

Symbol:



Title of the symbol:

Refrigerant

Description:

Designation of the refrigerant used

Symbol:



Title of the symbol:

Filling weight

Description:

Weight of the refrigerant used

Symbol:	Title of the symbol:	Maximum operating pressure
	Description:	Maximum operating pressure of the refrigeration circuit

1.2 Instrument type

All information given in these Instructions for Use applies only to the instrument type indicated on the title page. A nameplate indicating the instrument serial number is attached to the rear side of the instrument. Precise data for the various versions is specified in ([→ p. 21 – 3. Technical Data](#)).

1.3 Qualification of personnel

The Leica CM1950 may be operated by trained laboratory personnel only. The instrument is intended for professional use only.

Prior to operating the instrument, the operator must thoroughly read and understand these Instructions for Use and must familiarize him/herself with all technical details of the instrument.



Note

Despite chemical and/or UVC-light disinfection, personal safety precautions as per the applicable laboratory regulations must still be taken (i.e. safety goggles, gloves, laboratory coat and mask must be worn).

This type of disinfection reduces the number of germs by at least 99.99 %.

1.4 Intended purpose

The Leica CM1950 is a semi-motorized (motorized specimen feeding), high-performance cryostat with an option for motorized sectioning. It is used to freeze and section varying human specimen material quickly. These sections are used for histological medical diagnosis by a pathologist, e.g. for cancer diagnosis.

The Leica CM1950 is suitable for in-vitro diagnostic applications.

The instrument may only be operated within the scope of its intended purpose as described above and as per the instructions given in these Instructions for Use.

Any other use of this instrument is considered as improper operation.

2. Safety and Design



Warning

The safety and caution notes in this chapter must be observed at all times. Be sure to read these notes even if you are already familiar with the operation and use of other Leica products.

2.1 Safety notes

These Instructions for Use include important instructions and information related to the operating safety and maintenance of the instrument.

The Instructions for Use are an important part of the product, and must be read carefully prior to startup and use and must always be kept near the instrument.

This instrument has been built and tested in accordance with the safety requirements for electrical equipment for measurement, control, and laboratory use.

To maintain this condition and ensure safe operation, the user must observe all notes and warnings contained in these Instructions for Use.



Note

For the instrument's EC Declaration of Conformity, the UKCA Declaration of Conformity and up-to-date certificates pertaining to UVC disinfection, visit us online at: www.LeicaBiosystems.com.



Note

These Instructions for Use must be appropriately supplemented as required by the existing regulations on accident prevention and environmental safety in the operator's country.



Warning

- The protective devices located on the instrument and the accessories must not be removed or modified. The instrument must only be opened and repaired by service technicians authorized by Leica.
- Only original spare parts and permitted original accessories may be used!
- Use only one of the power cords approved by Leica. This must not be replaced with a different power cord! If the power plug does not fit in the socket, then contact our service.

2.2 Warnings

The safety devices installed in this instrument by the manufacturer only constitute the basis for accident prevention. Operating the instrument safely is, above all, the responsibility of the owner, as well as the designated personnel who operate, service or repair the instrument.

2 Safety and Design

To ensure trouble-free operation of the instrument, make sure to comply with the following instructions and warnings.



Note

The instrument has been designed and constructed with the latest state-of-the-art technology and according to recognized standards and regulations with regard to safety technology. Operating or handling the instrument incorrectly can place the user or other personnel at risk of injury or can cause damage to the instrument or other property. The instrument may be used only as intended and only if all of its safety features are in proper working condition. Malfunctions that impede safety must be remedied immediately.

2.3 General safety notes

The Leica CM1950 is a cryostat with an encapsulated microtome and separate specimen cooling. It is primarily used for work in the area of fast-cut diagnostics.

The displays and instrument controls are easy to operate due to their largely self-explanatory symbols. LED displays make it easy to read. The cryochamber is made of seamlessly welded, high-quality stainless steel that is free of difficult-to-access corners and thus easy to clean and disinfect.



Warning

Due to explosion hazard, the use of flammable freezing sprays inside the cryostat chamber, while the instrument is turned on, is prohibited.



Note

Flammable substances may not be used in the Leica CM1950 when it is turned on and plugged in. Do not place staining solutions or other liquids on top of the instrument.

2.4 Unpacking and installation

To ensure proper function of the instrument, it must be set up with a minimum distance on all sides from walls and furniture (→ p. 30 – 6.1 Site requirements)).

- The instrument may only be transported in an upright or slightly inclined position.
- To ensure a safe transport with a forklift 3 people are required: one operating the forklift, and the other 2 holding the instrument on either side to prevent it from sliding down.
- Before connecting to the power supply system, please observe (→ p. 21 – 3. Technical Data).
- Never connect the instrument to a power socket that does not have a protective conductor terminal.
Length of the power cord: up to 3.5m extension possible: **NO**



Note

After transporting, wait at least 4 hours before turning the instrument on. This waiting period is necessary to allow the compressor oil, which may have been displaced during transport, to return into its original location. Any condensation on electrical parts that has formed due to temperature differences during transport must be allowed to dry completely. Failure to comply with this can cause severe damage to the instrument!



Note



- When the instrument is delivered, check the tilt indicators on the packaging.
- If the arrowhead is blue, the shipment was transported laying flat, was tilted at too great an angle or fell over during transport. Note this on the shipping documents and check the shipment for possible damage.
- Two persons are required to unpack the instrument!
- Instrument figures and pictures are only to be used as examples to explain the unpacking procedure.

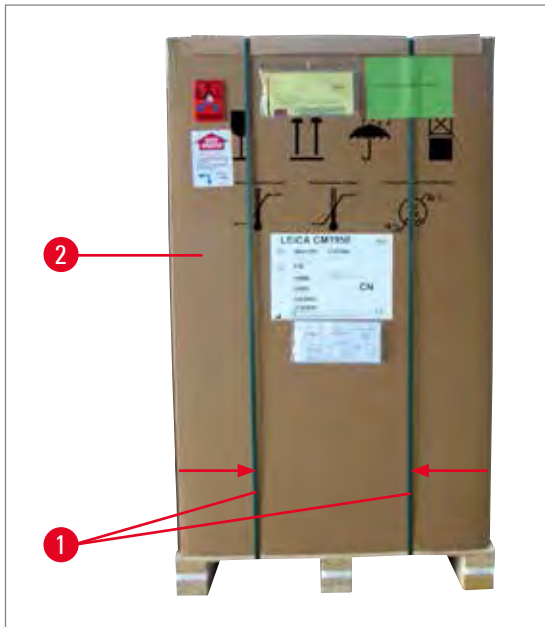

Fig. 1

1. To remove the strips (→ Fig. 1-1), suitable shears and protective gloves are required.
2. Stand next to the crate and cut the strips at the location shown (see arrows in (→ Fig. 1)).
3. Lift the outer carton (→ Fig. 1-2) upwards and out.



Warning

Caution when removing the strips! There is a risk of injury (the strip has sharp edges and is under tension)!

2 Safety and Design



Fig. 2



Fig. 3

- Carefully remove the adhesive tape (→ Fig. 2-3) holding the two transport anchors (→ Fig. 2-4) on both sides of the instrument and remove them.
- Pull the dust cover (→ Fig. 2-5) from the instrument.
- Remove the two white and the two blue transport anchors (→ Fig. 2-6), which protect the chamber window.
- Remove all accessories (→ Fig. 2-7).

- Lift and remove the wooden edge (→ Fig. 3-9).
- Remove the ramp (→ Fig. 4-13) from the pallet.
- Properly insert the ramp. Make sure that the ramp components designated "L" (left) and "R" (right) click into place in the intended guide channel (→ Fig. 4-14). When correctly assembled, the guide rails (→ Fig. 4-16) are located inside, while the arrows (→ Fig. 4-15) point toward each other.

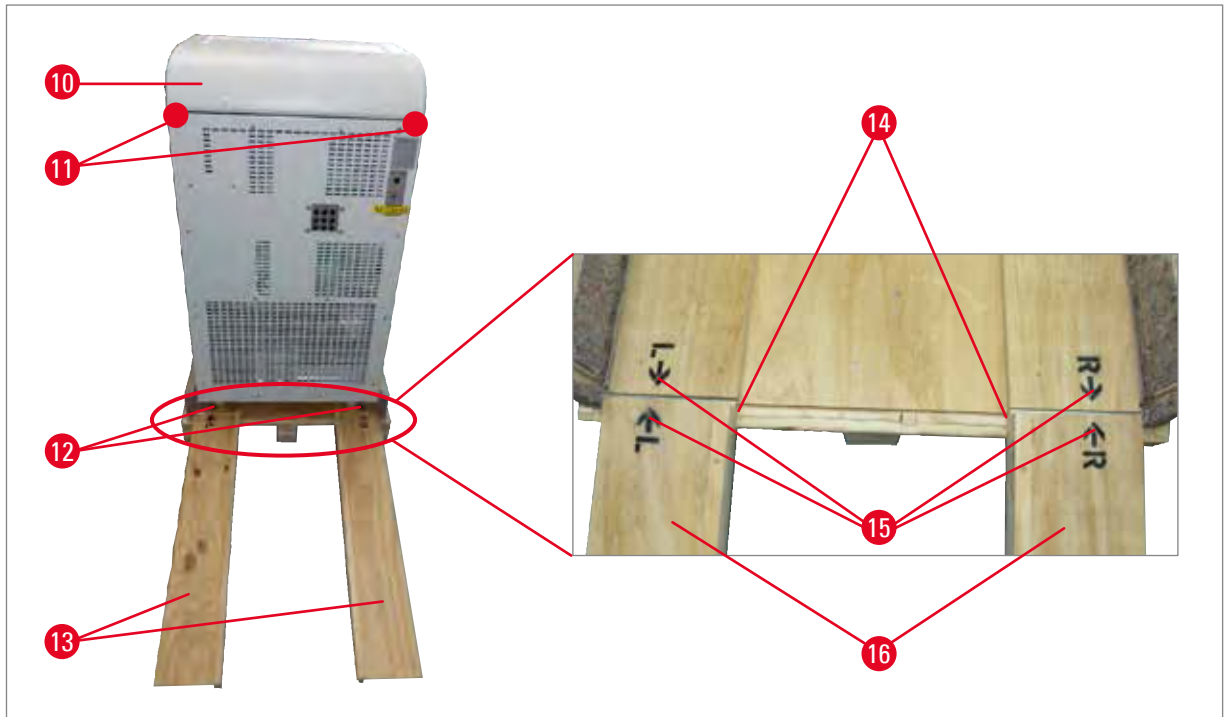

Fig. 4



Warning

- Do not push the device by its hood (→ Fig. 4-10)!
- Instead, use transport grip points ● (→ Fig. 4-11)!
- The front and rear rollers (→ Fig. 4-12) must stay on the ramp (→ Fig. 4-13). Danger of tipping!

11. Carefully roll the instrument backwards over the ramp from the pallet.
12. Push the instrument to the installation location on the castors (→ Fig. 4-12).

2.5 Safety devices

The Instructions for Use include important instructions and information related to the operating safety and maintenance of the instrument.

These Instructions for Use are an important part of the product, and must be read carefully **BEFORE** startup and use and must always be kept near the instrument.

If additional requirements on accident prevention and environmental protection apply in the country of operation, these Instructions for Use must be supplemented by appropriate instructions to ensure compliance with such requirements.

The instrument is equipped with the following safety devices: an emergency stop switch (motorized instruments only), a handwheel lock and centering system (motorized instruments only), safety guard on the blade and knife holder, and a blade ejector.

**Warning**

To prevent adverse health effects from UVC radiation, the UVC disinfection cycle can be started only after the sliding window has been properly closed. Closing the window activates the corresponding safety features.

The consistent use of these safety features and strict observation of the warnings and cautions in these Instructions for Use will safeguard the operator from accidents and/or personal injury to a great extent.

Microtome knives

- Take care when handling microtome knives/disposable blades. The cutting edge is extremely sharp and can cause serious injuries!
- Never leave knives and knife holders with a knife/blade mounted lying around!
- Never place a knife on a table with the cutting edge facing upward!

**Note**

We strongly recommend using the safety gloves included with the standard delivery.

- **NEVER** try to catch a falling knife!
- Before handling the specimen or the knife, or changing the specimen, lock the handwheel and ensure that the knife is covered by the safety guard.
- Avoid contact with cold parts of the instrument as this can cause freezer burn – wear the safety gloves supplied!

Safety guard**Warning**

Prior to making modifications to the knife and specimen, changing the specimen or knife, or taking a break, always lock the handwheel and cover the cutting edge with the safety guard!

The CE, CN and CN-Z knife holders feature safety guards; the glass anti-roll plate of the CE knife holder also serves as a safety guard.

2.6 Securing/locking the handwheel**Warning**

Always lock the handwheel prior to making modifications to the knife or specimen, changing the specimen, or taking a break!



Fig. 5



Fig. 6

To lock the handwheel, press the lever (→ Fig. 6-1) outward. Continue turning the handwheel slowly until the grip is in the upper or lower position and the handwheel is locked. Press the lever fully outward; gently rock the handwheel back and forth until the locking mechanism clicks into place noticeably.

To release the handwheel, press the lever (→ Fig. 6-2) on the handwheel toward the cryostat housing.

Centering of the handwheel (motorized instruments only)



Fig. 7

Pull out the handwheel's handle and position it in the middle of the handwheel. The handle automatically engages in this position.



Note

An important safety device on the cryostat is the centering of the handwheel on motorized instruments.



Warning

Rotate the handwheel only if the refrigeration system is on and the cryochamber is cold.

2.7 Cleaning, disinfection – Turning the instrument back on**Note**

It is not necessary to remove the microtome for disinfection.

- The instrument has been designed for UVC disinfection.

**Note**

Remove section waste after EVERY sectioning operation and BEFORE changing specimens. Remove the section waste using the extraction nozzle (optional) or by using a paper towel soaked in an alcohol based disinfectant. Do not start the disinfection before swiveling the anti-roll plate to the side. Each new specimen is a potential source of contamination.

- When disinfecting the instrument, take appropriate protective measures (gloves, mask, protective clothing, etc.).
- When using detergents and disinfectants please comply with the safety precautions of the disinfectant manufacturer!
- The integrated glass anti-roll guide of the blade holders CE, CN and CN-Z can be cleaned either with acetone or alcohol.
- Dispose of waste liquid according to the waste disposal regulations.
- Do not use external heaters for drying the cryochamber. This can cause damage to the cooling system!
- Do not turn the instrument on before the cryochamber is completely dry. Frost formation!
- All components removed from the cold cryostat must be carefully dried before returning them to the cryochamber!
- The front panel and the slit cover of the microtome must be completely dry before turning on the instrument!

**Note**

For more detailed information about disinfection, visit the Leica Biosystems Division website at www.LeicaBiosystems.com

2.8 Handling specimens – Defrosting

- When working with contaminated or infected material, the general safety guidelines for laboratories must be applied!
- Before defrosting the cryochamber remove all samples!
- Before defrosting the specimen head, remove all samples!

**Note**

Never leave samples in the cryochamber! – The instrument is not suitable for storing frozen specimens, as the refrigeration dehydrates the specimens!



Warning

The quick freeze shelf can become very hot during the defrosting process. Therefore, do not touch it!

2.9 Removing the microtome

- The microtome is encapsulated and therefore does not require removal by the user.

2.10 Maintenance

2.10.1 Replacing the fuses

- Turn the instrument off and disconnect the power plug before replacing the fuses!
- Use only the fuse types specified in (→ p. 21 – 3. [Technical Data](#))! The use of fuses other than those specified by the manufacturer may cause severe damage to the instrument!

2.10.2 Replacement of the UVC lamp

- Turn the instrument off and disconnect the power plug before replacing the UVC lamp.



Warning

It is possible to break the UVC lamp during replacement. If this happens, the lamp change must be completed by Technical Service. If any metallic mercury is released, handle it carefully and dispose of it properly.



Note



If both disinfection indicator lights are blinking alternately, the UVC lamp must be replaced!



2.10.3 Cleaning up a broken UVC lamp



Warning

- In case a UVC lamp is broken, open the windows of the working area and leave the room. Let the air clear for 15 to 30 minutes before returning.
- Keep out other persons of the working area until cleanup is completed.
- Do not use a vacuum cleaner to clean up broken UVC lamps. Vacuuming spreads mercury vapor and dust and contaminates the vacuum cleaner.
- Wear protective clothing (cut-resistant gloves, safety goggles) to protect yourself from broken glass and prepare a sealable disposal container (i. e. sealable plastic bag or a glass container with screw cap).

Cleaning up a broken UVC lamp

1. Carefully collect larger pieces of glass and debris using two stiff pieces of paper or cardboard. Pick up smaller pieces and dust using sticky tape.
2. Put all debris and cleanup materials into the prepared disposal container and seal it properly.
3. Mark the container with: **WARNING: MAY CONTAIN MERCURY RESIDUES FROM UVC LAMPS** and store the container outside of the building in a safe place.
4. Finally dispose of the container in accordance with the local applicable disposal regulations.

3. Technical Data



Note

All specifications related to temperature are valid only up to an ambient temperature of 18 °C to 35 °C and a relative humidity of no more than 60 %!

Instrument type	-1	-2	-3
Model numbers	14047742460, 14047742461, 14047742463, 14047742462	14047742464, 14047742465, 14047742466, 14047742467, 14047743909, 14047743908, 14047743907, 14047743906, 14047744626	14047742456, 14047742457, 14047742458, 140477442459, 14047743905, 14047743904, 1404774625
Nominal voltage (±10 %)	100 VAC	120 VAC	230 VAC
Nominal frequency	50/60 Hz	60 Hz	50 Hz
Power consumption (with/ without object head cooling)	1500/1300 VA	1500/1300 VA	1500/1300 VA
Max. start-up current for 5 sec.	35 A eff.	35 A eff.	25 A eff.
Power supply	IEC 60320-1 C-20	IEC 60320 C-20	IEC 60320-1 C-20
Mains input fuse (automatic circuit breaker)	T15 A M3	T15 A T1	T10 A T1
Other fuses	F1 T4A 250 VAC (5x20 heater - object head) F2 T4A 250 VAC (5x20 sectioning motor) F3 T4A 250 VAC (5x20 power supply 5V and 24V electronics, keyboards, valves, slaveboard, feed) F4 T4A 250 VAC (5x20 heater - drip pan) F5 T4A 250 VAC (5x20 heaters - window, grid and drain tube) F6 T0.630A 250 VAC (5x20 illumination and UVC disinfection) F7 T2A 250 VAC (5x20 peltier element) F8 T2A 250 VAC (5x20 clutch) F9 T3.15A 250 VAC (5x20 extraction)		
Dimensions and weights			
	Overall size of device, without handwheel (width x depth x height)	700 x 850 x 1215 mm	
	Overall size of device, with handwheel (width x depth x height)	835 x 850 x 1215 mm	
	Working height (armrest)	1025 mm	
	Overall size of packing (width x depth x height)	960 x 820 x 1420 mm	
	Empty weight (without accessories)	145-193 kg depending on configuration	

3 Technical Data

Environmental specification

Operating altitude ¹	Max. 2000 m above sea level
Operating temperature	+18 °C to +35 °C
Relative humidity (operation)	20 to 60 % RH non-condensing
Transport temperature	-29 °C to +50 °C
Storage temperature	+5 °C to +50 °C
Relative humidity (transport / storage)	10 to 85 % RH non-condensing
Minimum distance to walls	Back: 150 mm Right: 300 mm Left: 150 mm

Emissions and boundary conditions

Overvoltage category ¹	II
Pollution degree ¹	2
Means of protection ¹	Class I (PE connected)
Degree of protection according to IEC 60529	IP20
Heat emission (max., with / without object head cooling)	1500/1300 J/s
A-weighted noise level, measured at 1 m distance	< 70 dB (A)
EMC class	A (FCC Rules part 15) A (CISPR 11, IEC 61326, CAN ICES-3 (A)/NMB)

¹ in acc. with IEC-61010-1



Warning

Observe item (→ p. 30 – 6.1 Site requirements)!

Refrigeration system

Cryochamber

Temperature range	0 °C to -35 °C ±5 K, adjustable in 1 K increments, at ambient temperature of 20 °C
Cool down time to -25 °C at starting point and ambient temperature of 20 °C	approx. 5 h
Cool down time to -35 °C at starting point and ambient temperature of 20 °C	approx. 8 h
Max. operating pressure	25 bar
Refrigerant*	320 g, refrigerant R-452A*
Defrosting	Hot gas defrosting
Manual defrosting	Yes

Automatic defrosting

Refrigeration system	
Programmable	Yes (hot gas defrost), selectable time
Defrosting intervals	1 defrost in 24 h or manual hot gas defrost
Defrost time	12 minutes
Automatic shutoff defrost	At chamber temperature of more than -5 °C
Object head cooling	
Optional feature included in model number	At 230 V/50 Hz: 14047742456, 14047742457, 14047742458, 14047742459 At 120 V/60 Hz: 14047742464, 14047742465, 14047742466, 14047742467 At 100 V/50 Hz and 60 Hz: 14047742460, 14047742461, 14047742462, 14047742463
Temperature range	-10 to -50 °C ± 3 K
Refrigerant and quantity	At 230 V/50 Hz: 137 g, refrigerant R-452A* At 120 V/60 Hz: 147 g, refrigerant R-452A* At 100 V/50/60 Hz: 147 g, refrigerant R-452A*
Max. operating pressure	25 bar
Defrosting object head cooling	
Defrosting	Electrical heater
Automatic defrosting	No
Manual defrosting	Yes
Defrost duration	15 min.
Defrost temperature	45 °C ±2K
Quick-freeze shelf	
Lowest temperature	-42 °C (±5 K), at chamber temp. -35 °C (+5 K)
Number of freezing stations	15+2
Defrosting	Manual hot gas defrost
Peltier element	
Max. difference in temperature to quick-freez shelf	-17 K, at chamber temperature of -35 °C +5 K
Number of freezing stations	2



Warning

* Refrigerant and compressor oil must be replaced by qualified, authorized service personnel only!

Microtome

Type	Rotary microtome, encapsulated
Section thickness range ²	1 to 100 µm
Trimming thickness range ²	Clinical: 10 to 40 µm
	Research: 1 to 600 µm
Horizontal specimen feed	25 mm + 1 mm
Vertical specimen stroke	59 mm ± 0.5 mm
Specimen retraction	20 µm (can be deactivated)
Maximum specimen size	50 x 80 mm
Sectioning speed	Slow: 0 to 50 strokes/min Fast: 0 to 85 strokes/min Max. speed: 85 to 90 strokes/min
Specimen orientation	±8° (x-, y-axis)
Coarse feed	Slow: 300 µm/s Fast: 900 µm/s

² for additional details, see (→ p. 45 – [Setting section/trim thickness](#))

UVC disinfection

Manual start	Yes
Automatic start	No
Manual abort	Yes
Duration disinfection cycle	Short cycle: 30 min Long cycle: 180 min

4. Standard Delivery

Basic instrument WITHOUT motor/WITHOUT extraction, in the specific voltage variant

Qty.		Part No.
1	Handwheel, manual	14 0477 41346
5	Specimen discs, 30 mm	14 0477 40044
1	Section waste tray	14 0477 40062
1	Position holder for freeze shelf	14 0477 40080
1	Freeze shelf cover	14 0477 43763
1	Tool set	14 0436 43463
1	Brush, fine	14 0183 28642
1	Leica brush w/magnet	14 0183 40426
1	Hexagon key, size 1.5	14 0222 10050
1	Hexagon key, size 2.5	14 0222 04137
1	Hexagon key, size 3.0	14 0222 04138
1	Hexagon key, size 4.0	14 0222 04139
1	Hexagon key with ball head, size 4.0	14 0222 32131
1	Hexagon key, size 5.0	14 0222 04140
1	Key with handle, size 5.0	14 0194 04760
1	Hexagon key, size 6.0	14 0222 04141
1	Double-head wrench, sizes 13/16	14 0330 18595
1	Bottle of cryostat oil, 50 ml	14 0336 06098
1	Bottle of OCT freezing compound, 125 ml	14 0201 08926
1	pair of safety gloves, size M*, for cryosectioning	14 0340 29011
1	International bundle Instructions for Use (incl. English printout and additional languages on a data storage device 14 0477 80200)	14 0477 80001

* Note: for the Japanese version: 100 V, 50/60 Hz; 1 pair of safety gloves, size S (14 0340 40859) is included.

Basic instrument WITHOUT motor and WITH extraction

Qty.		Part No.
Standard scope of delivery as above, additionally:		
1	Accessory kit (extraction)	14 0477 43300
–	Hose adapter 1	14 0477 40293
–	Hose adapter 2	14 0477 40294
–	Suction nozzle	14 0477 40295
–	Silicone hose	14 0477 43302
–	Silicone stopper	14 0477 43304
–	Chamber suction nozzle	14 0477 43779
–	Set of filters (5 pieces)	14 0477 43792

Qty.	Part No.
Compare the delivered components with the parts list and your order. Should you find any discrepancies, please contact your Leica Biosystems sales office without delay. The country specific power cord needs to be ordered separately. Please find a list of all power cords available for your device on our website www.LeicaBiosystems.com within the product section.	

**Note**

A choice of different blade/knife holders is available for the Leica CM1950.

Basic instrument WITH motor/WITHOUT extraction, in the specific voltage variant

Qty.	Part No.	
1	Handwheel, motorized	14 0477 41347
5	Specimen discs, 30mm	14 0477 40044
1	Section waste tray	14 0477 40062
1	Position holder for freeze shelf	14 0477 40080
1	Freeze shelf cover	14 0477 43763
1	Tool set	14 0436 43463
1	Brush, fine	14 0183 28642
1	Leica brush w/magnet	14 0183 40426
1	Hexagon key, size 1.5	14 0222 10050
1	Hexagon key, size 2.5	14 0222 04137
1	Hexagon key, size 3.0	14 0222 04138
1	Hexagon key, size 4.0	14 0222 04139
1	Hexagon key with ball head, size 4.0	14 0222 32131
1	Hexagon key, size 5.0	14 0222 04140
1	Key with handle, size 5.0	14 0194 04760
1	Hexagon key, size 6.0	14 0222 04141
1	Double-head wrench, sizes 13/16	14 0330 18595
1	Bottle of cryostat oil, 50 ml	14 0336 06098
1	Footswitch dummy	14 0443 30420
1	Bottle of OCT freezing compound, 125 ml	14 0201 08926
1	pair of safety gloves, size M*, for cryosectioning	14 0340 29011
1	International bundle Instructions for Use (incl. English printout and additional languages on a data storage device 14 0477 80200)	14 0477 80001

* Note: for the Japanese version: 100 V/50/60 Hz; 1 pair of safety gloves, size S (14 0340 40859) is included.

Basic instrument WITH motor and WITH extraction, in the specific voltage variant

Qty.	Part No.	
Standard scope of delivery as above, additionally:		
1	Accessory kit (extraction)	14 0477 43300
–	Hose adapter 1	14 0477 40293
–	Hose adapter 2	14 0477 40294
–	Suction nozzle	14 0477 40295

Qty.		Part No.
–	Silicone hose	14 0477 43302
–	Silicone stopper	14 0477 43304
–	Chamber suction nozzle	14 0477 43779
–	Set of filters (5 pieces)	14 0477 43792

Compare the delivered components with the parts list and your order. Should you find any discrepancies, please contact your Leica Biosystems sales office without delay. The country specific power cord needs to be ordered separately. Please find a list of all power cords available for your device on our website www.LeicaBiosystems.com within the product section.

**Note**

A choice of different blade/knife holders is available for the Leica CM1950.

5. General Overview

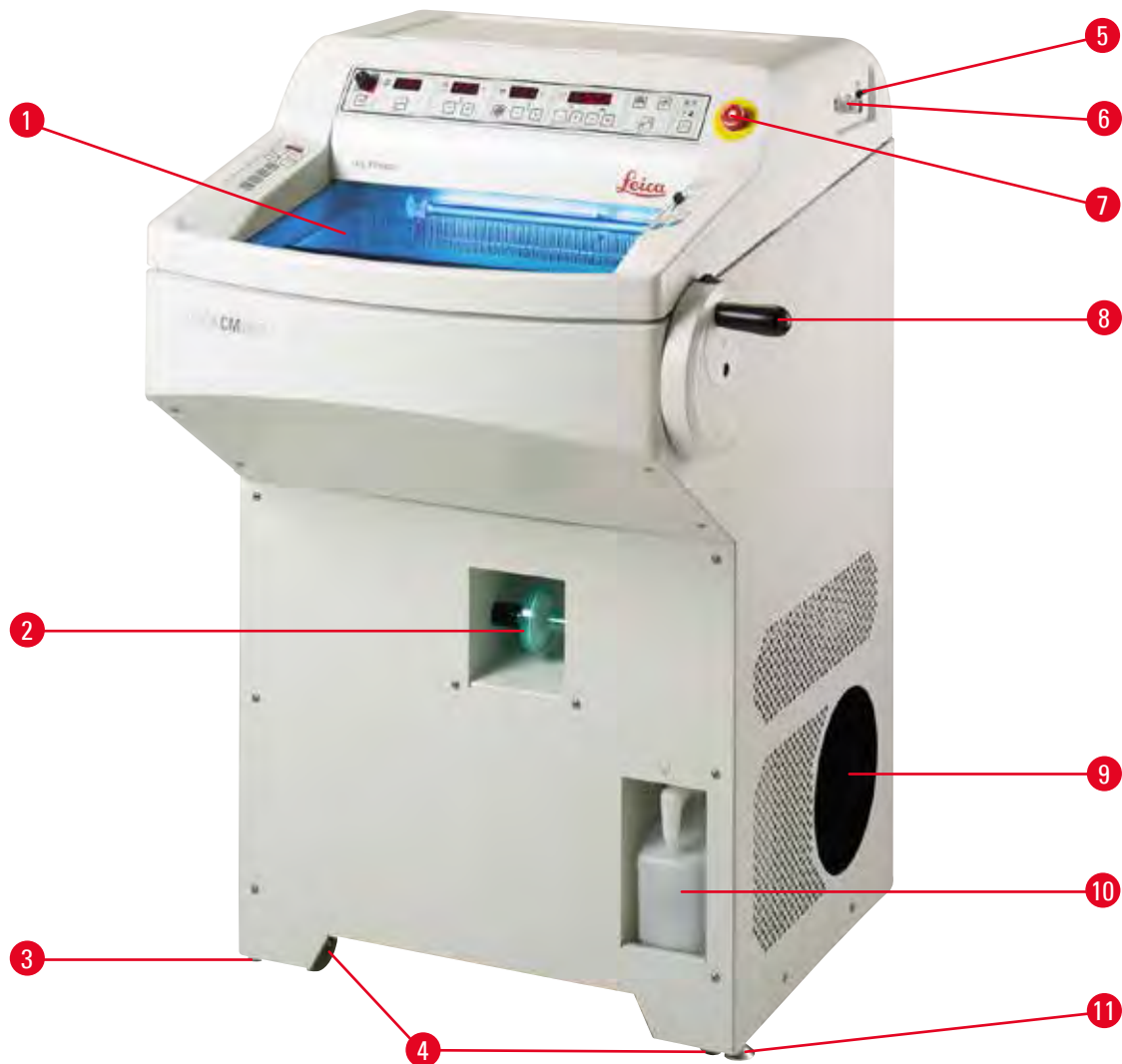

Fig. 8

- | | |
|--|---|
| 1 Cryostat chamber (with activated UVC disinfection) and closed heated sliding window | 6 Footswitch dummy (motorized instruments only) |
| 2 HEPA filter (optional, only for instruments with filter) | 7 Emergency-stop switch (motorized instruments only) |
| 3 Unscrew and align adjusting feet after transport | 8 Handwheel in 12 o'clock position |
| 4 Castors for safe transport over short distances | 9 Condenser |
| 5 On/off switch, also circuit breaker | 10 Catch tank for condensate |
| | 11 Align adjusting feet for secure upright position |

5.1 Control panel fields and cryostat chamber

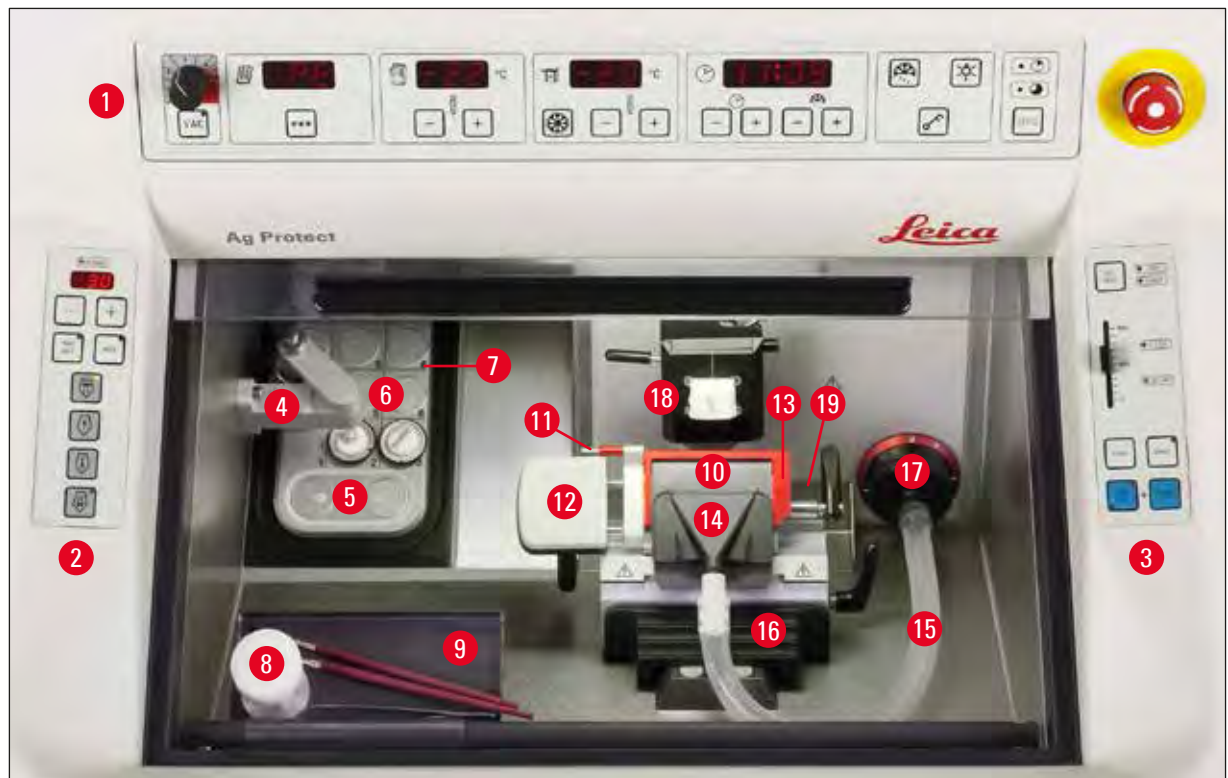

Fig. 9

- | | |
|----|---|
| 1 | Control panel 1: Extraction, temperature and time control, illumination, UVC disinfection |
| 2 | Control panel 2: Electric coarse feed (sectioning and trimming thickness adjustment) |
| 3 | Control panel 3: Motorized sectioning, optional (adjustment of stroke type, cutting speed etc.) |
| 4 | Heat extractor, stationary (optional) |
| 5 | Peltier element (with 2 stations) |
| 6 | Freeze shelf, 15 positions |
| 7 | Position holder on freeze shelf |
| 8 | Heat and cold extractor, mobile (opt.) |
| 9 | Shelf, movable (optional) |
| 10 | Blade holder CE |
| 11 | Blade ejector |
| 12 | Finger rest on the blade holder CE |
| 13 | Safety guard on the blade holder CE |
| 14 | Extraction nozzle on the extraction hose |
| 15 | Extraction hose for section waste |
| 16 | Brush shelf (optional) |
| 17 | Adapter piece for extraction hose (the coarse filter insert is behind it) |
| 18 | Object head, directional |
| 19 | Waste tray |

6. Installation

6.1 Site requirements



Warning

Do not operate the instrument in rooms with explosion hazard.

In addition to the requirements listed in (→ p. 21 – 3. Technical Data) the following restrictions apply:

- The instrument is designed for indoor use only.
- The power plug/circuit breaker must be freely and easily accessible.
- The power supply must be within the range of the length of the power cord: An extension cable must **NOT** be used.
- The floor must be largely vibration-free and have sufficient load capacity and rigidity for the weight of the instrument.
- Avoid impacts, direct sunlight, and excessive temperature fluctuations. Furthermore, this instrument must **NOT** be operated directly under the outlet of an air-conditioning system, since the increased air circulation accelerates icing of the chamber.
- The instrument must be connected to a grounded power socket. Use **ONLY** the power cord provided, which is intended for the local power supply.
- The chemicals generally to be used are easily inflammable and hazardous to health. Therefore the installation location must be well ventilated, and must contain no sources of ignition of any kind.
- The installation location must be protected against electrostatic charge.



Note

Room temperatures and humidity levels in excess of the requirements will affect the cryostat's cooling capacity and the lowest stated temperatures will not be reached.



Warning

To ensure proper function of the instrument, it must be set up while maintaining a minimum distance from walls and furniture (→ p. 21 – 3. Technical Data). No heat dissipating appliances must be placed in the vicinity.

6.2 Transport to the site

- First, check if the location meets the conditions specified in (→ p. 30 – 6.1 Site requirements) and (→ p. 21 – 3. Technical Data).
- Transport the instrument to the desired location.
- Observe the following:



Warning

- The instrument must be transported in an upright position or slightly tilted (max. 30°)!
- When tilting the instrument 2 people must counterbalance from the front side to prevent the instrument from falling over and causing severe damage to the instrument as well as injury to the transport personnel!

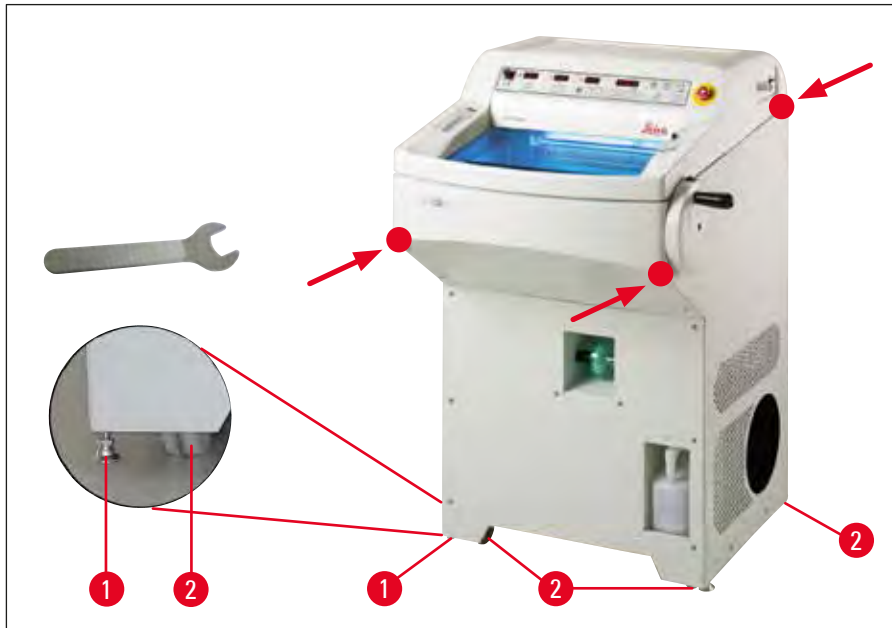

Fig. 10

- When transporting the instrument on wheels, (→ Fig. 10-2) grip the cabinet only at the marked locations (●).
- Unscrew the adjustable feet using the No. 13 open-end wrench (when subsequently transporting the instrument on castors, screw the feet back in as far as they will go). To ensure a secure upright position at its intended location, align both adjusting feet (→ Fig. 10-1).

**Note**

Before transport or relocation, remove the filter bag from the chamber. If you fail to do this, the filter bag will thaw, then freeze solid when the instrument is reconnected. When subsequently removed, the filter will be destroyed, causing section waste to get into the HEPA filter (also refer to (→ p. 39 – 6.5.8 Assembling the filter bag)).

**Warning**

When not using the extraction for a long period, tightly close the opening for the extraction hose using the silicone stopper included in the standard scope of delivery (→ Fig. 27-6)!

6 Installation

Transport with a forklift

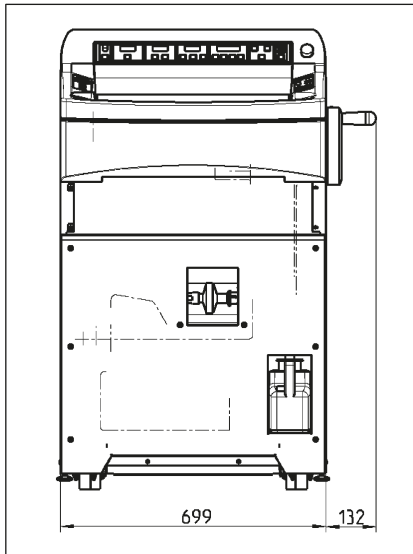

(→ Fig. 11), Total width with handwheel

Fig. 11

- The instrument can be transported with a forklift.



Warning

To ensure a safe transport with a forklift 3 people are required: one operating the forklift, and the other 2 holding the instrument on either side to prevent it from sliding down.

- At the installation location, unscrew the adjusting feet (→ Fig. 10-1) using the open-end wrench (13 mm). This is absolutely necessary for the instrument to stand stably.

6.3 Installing the handwheel



Warning

Rotate the handwheel only if the refrigeration system is on and the cryochamber is cold.



Fig. 12

- Insert the pin (→ Fig. 12-1) of the handwheel shaft into the hole (→ Fig. 12-2) of the handwheel.
- Tighten the screw (→ Fig. 12-3) using the size 6 Hexagon key.
- Place the protective cap on the screw (→ Fig. 12-3).

To de-install, proceed in reverse order.

6.3.1 Locking/unlocking the handwheel



Fig. 13



Warning

- Rotate the handwheel only if the refrigeration system is on and the cryochamber is cold.
- Always lock the handwheel prior to making modifications to the knife or specimen, changing the specimen, or taking a break!



Fig. 14

To lock the handwheel, move its handle to the 12 or 6 o'clock position. Press the lever (→ Fig. 14-1) fully outward; gently rock the handwheel back and forth until the locking mechanism clicks into place noticeably.

To release the handwheel, press the lever (→ Fig. 14-2) on the handwheel toward the cryostat housing.

Centering the Handwheel (Optional)



Note

An important safety device on the cryostat is the feature for centering the handwheel in motorized sectioning mode.



Fig. 15

To do so, pull out the handwheel's handle and position it in the middle of the handwheel. The handle automatically engages in this position.

6.3.2 Installing the footswitch dummy (instruments with cutting motor)



Fig. 16

- The footswitch dummy must be installed on the outer right side of the instrument (→ p. 28 – 5. [General Overview](#)) if no footswitch (optional) is used.

If the red LED (→ Fig. 33-4) in the **E-STOP** field in control panel 3 is illuminated, either:

- Emergency-stop function is active, or
- Footswitch dummy (opt. foot switch) is not connected or incorrectly connected.

6.4 Electrical connection



Warning

After transporting, wait at least 4 hours before turning the instrument on. This waiting period is necessary to allow the compressor oil, which may have been displaced during transport, to return into its original location. Furthermore, any condensation that has formed during this time due to temperature fluctuations must be allowed to dry completely.

Failure to comply with this can cause severe damage to the instrument!

During the start-up of the compressor the nominal voltage must not drop below the values specified in the (→ p. 21 – 3. [Technical Data](#))!

Please note that the compressor requires a start-up current between 25 and 35 A. The electric circuit at the installation site must be inspected by an electrical engineer to ensure that it meets the requirements for a smooth operation of the instrument.

Failure to comply with the above will cause severe damage to the instrument!

- Check power supply voltage and frequency to comply with the specification on the type plate.
- Do not connect any other appliances to this electric circuit.



Warning

Never connect the instrument to a power socket that does not have a protective conductor terminal.

Only for instruments sold in Japan



Fig. 17

Selecting the frequency

- After unpacking the instrument and setting it up at its intended location, use the lever (→ Fig. 17-1) to select the frequency corresponding to the conditions of the existing power system.

6.5 Installing accessories/inserting chamber accessories

6.5.1 Installing the adjustable footrest (optional)

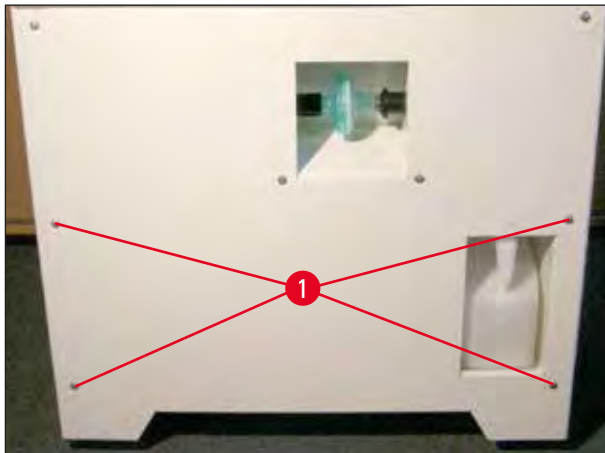

Fig. 18

- To install the optional footrest, the screws (→ Fig. 18-1) must be unscrewed using the size 3 Hexagon key provided.



Note

When installing the holder (→ Fig. 19-2), ensure that the cutout faces downwards so that the support (→ Fig. 19-3) can be hooked in.

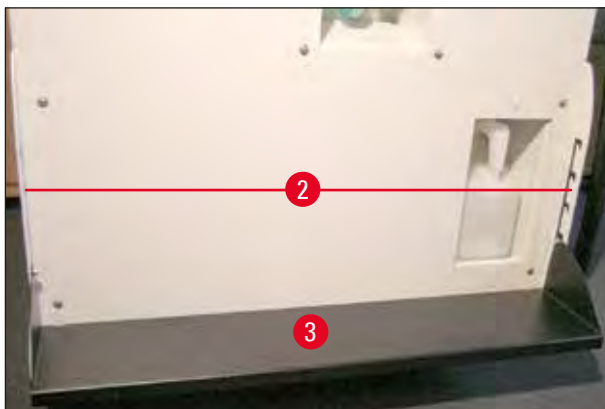

Fig. 19

- Attach the holders (→ Fig. 19-2) for the footrest on the left and right to the front wall of the housing from the **OUTSIDE**. To do so, use the Hexagon screws you used earlier. Ensure that the screws are tight.
- Hook the footrest (→ Fig. 19-3) into the installed holder according to individual requirements (height).
- Once installed, the user can adjust the height of the footrest at any time by relocating it (→ Fig. 19-3) to the desired height on both sides in the holder (→ Fig. 19-2).

6.5.2 Installing the storage systems (optional)

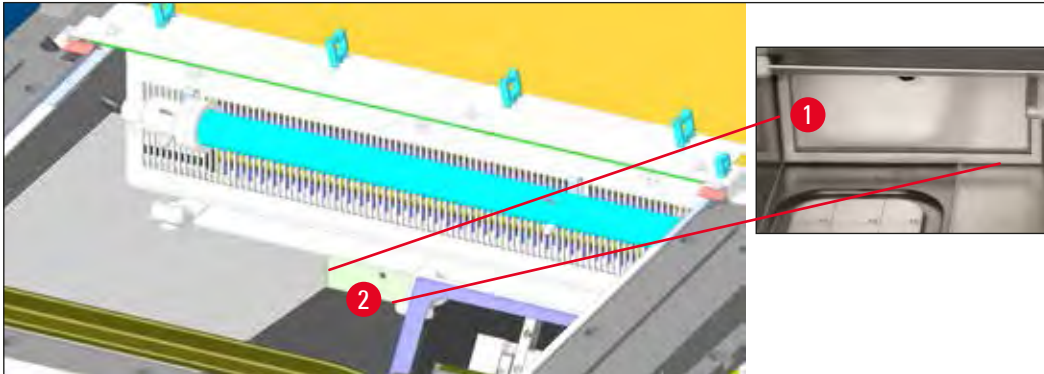

Fig. 20

For reasons of accessibility, the (optional) storage system must always be installed first.

To do so, remove the insert (→ Fig. 20-1), place the frame (→ Fig. 20-2) in front of the bore and tighten the screws/washer on the cryostat housing using the size 4 Hexagon key. Afterwards, insert the insert (→ Fig. 20-1) into the frame and fold it up.

6.5.3 Shelf, movable (optional)



Fig. 21

Attach the rod for the shelf to the inner front side of the cryostat housing using the provided screws (→ Fig. 21-1) and the size 3 Hexagon key, then attach the caps (→ Fig. 21-3). (The rear side of the movable shelf has white plastic screws (→ Fig. 21-2) that prevent the interior of the chamber from being scratched.) Now hook the movable shelf into the guide rod.

6.5.4 Inserting the section waste tray

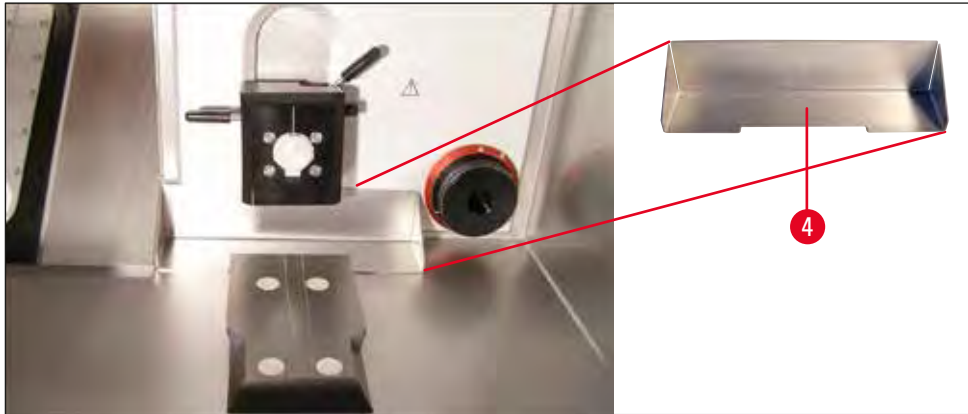

Fig. 22

Before installing the knife/blade holder base, insert the section waste tray with the cutout (→ Fig. 22-4) facing the user.

6.5.5 Installing the heat extractor, stationary (optional)

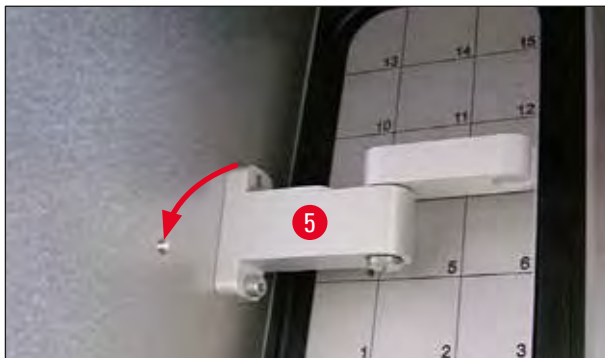

Fig. 23

The holder (→ Fig. 23-5) of the heat extractor is screwed to the left housing wall using the size 4 Hexagon key provided (it is better to begin with the bottom screw). Then, rotate the holder upwards (see arrow) and insert and tighten the top screw.



Note

- Now attach the cover for the quick freeze shelf to protect the shelf from frost.
- For temperature reasons, install the knife/blade holder on an appropriate base.

6 Installation

6.5.6 Installing the knife/blade holder and adjusting the clearance angle

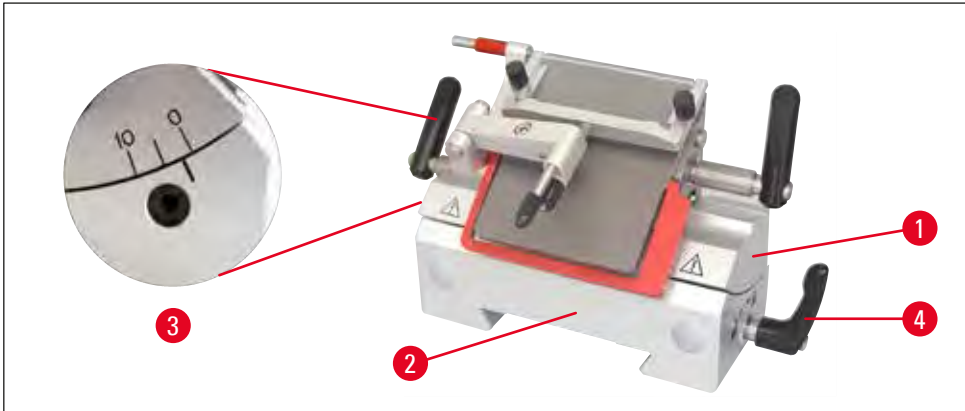

Fig. 24

- Set the knife or blade holder (→ Fig. 24-1) on the base (→ Fig. 24-2), adjust the clearance angle (on the left of the knife/blade holder) to approx. 2° - 5° and secure it in the bore (→ Fig. 24-3) on the base (→ Fig. 24-2) using the size 4 Hexagon key.

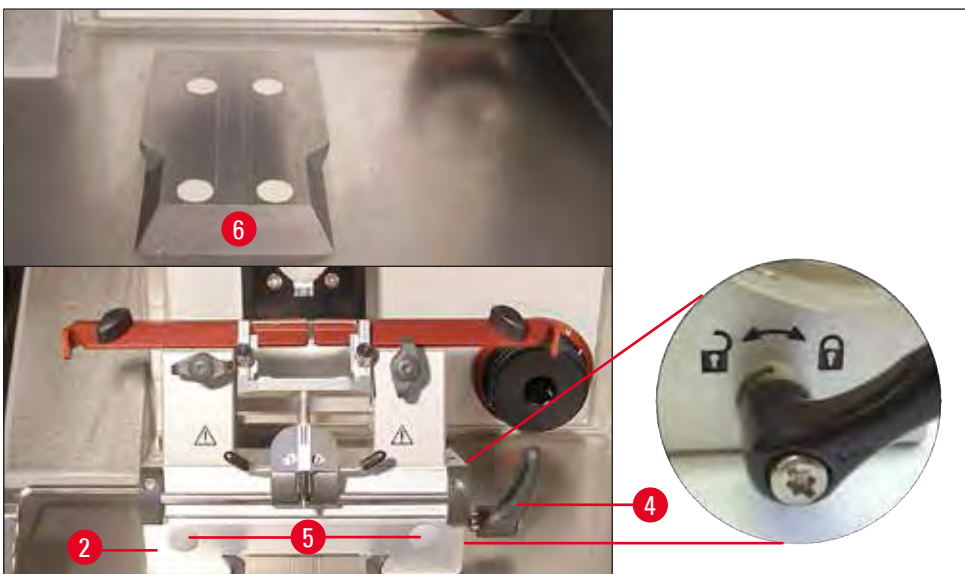

Fig. 25

- Push the knife/blade holder base (→ Fig. 25-2) on the dovetail guide (→ Fig. 25-6) from the front and tighten it using the clamping lever (→ Fig. 25-4). Move the clamping lever clockwise (toward the closed lock symbol) on the right side of the blade/knife holder base (see detail of (→ Fig. 25)). To move the base, open the clamping lever only a little to prevent accidental sliding in the direction of the specimen head! Move the clamping lever counterclockwise (toward the open lock symbol) on the right side of the blade/knife holder base (see detail of (→ Fig. 25)).

**Note**

When removing the knife holder base (→ Fig. 25-2) from the refrigerated cryostat chamber, hold it by the grip points (→ Fig. 25-5) – front and rear) to keep your fingers from freezing. Safety gloves must be worn!

- If the clamping distance is not sufficient, the clamping lever (→ Fig. 25-4) can be moved. To do so, pull the lever out and move it to the next position.

6.5.7 Inserting/changing the HEPA filter



Fig. 26

The holder for the HEPA filter (optional) is visible in the front of the instrument.

- To insert the filter, hold it with one hand, press on the right of the socket, then guide the filter into the tube from the left.
- To change the HEPA filter, follow the opposite procedure: press the filter to the right, then pull it to the left and out of the tube.
- The filter must be changed approx. every 3 months (we recommend writing the date on the filter using a marker).

**Note**

The filter must be disposed of according to valid laboratory specifications. If completely defrosted, HEPA filters and filter bags **MUST** be removed. The HEPA filter absorbs the moisture during defrosting and becomes unusable!

6.5.8 Assembling the filter bag

- Set the mark (→ Fig. 27-1) of the extraction opening to open (→ Fig. 27-2) and pull it out. Plug the filter (→ Fig. 27-5) into the extraction hose connecting piece (→ Fig. 27-4) until there is an audible click.

Now push the connected parts back into the opening in the cryostat chamber (filter first) and set it to the "closed" mark (→ Fig. 27-3).

6 Installation

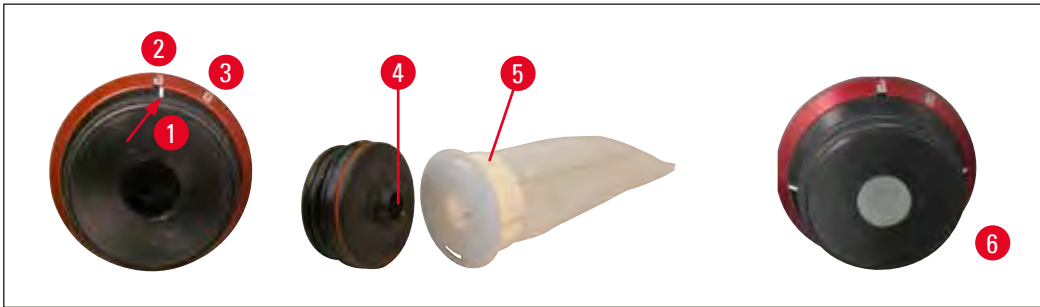

Fig. 27



Note

When not using the extraction, tightly close the opening for the extraction hose using the silicone stopper (→ Fig. 27-6) included in the scope of delivery.

Reasons:

1. To prevent section waste from falling into the opening.
2. To prevent cold from escaping from the chamber.
3. To prevent moisture from penetrating the chamber.

6.5.9 Installing the section extraction (optional) – Use with blade holder CE only

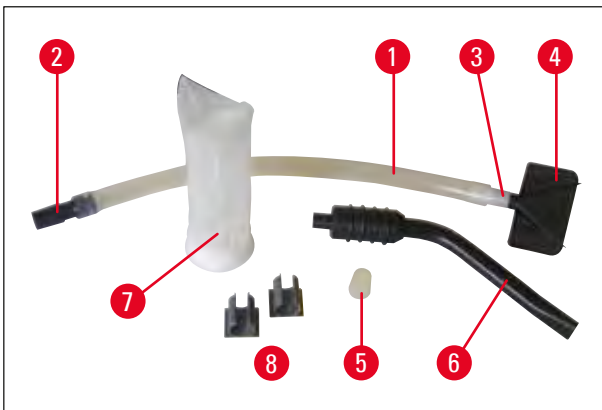

Fig. 28

- Silicone hose (→ Fig. 28-1) with hose adapter 1 (→ Fig. 28-2), for filter in instrument), hose adapter 2 (→ Fig. 28-3) (for suction nozzle (→ Fig. 28-4) or (→ Fig. 28-6)) and suction nozzle (→ Fig. 28-4) – factory pre-assembled
- Silicone stopper (→ Fig. 28-5)
- Chamber suction nozzle (→ Fig. 28-6)
- Filter (→ Fig. 28-7)
- Plastic clips (→ Fig. 28-8), for parking the chamber suction nozzle.

When the suction nozzles are changed, the adapter (white) remains in the silicone hose. Pull off the nozzle by rotating and pulling it gently and firmly plug in the desired nozzle.



Note

Ensure that the hose with the nozzle is not installed against its "natural" curvature on the pressure plate of the knife holder.

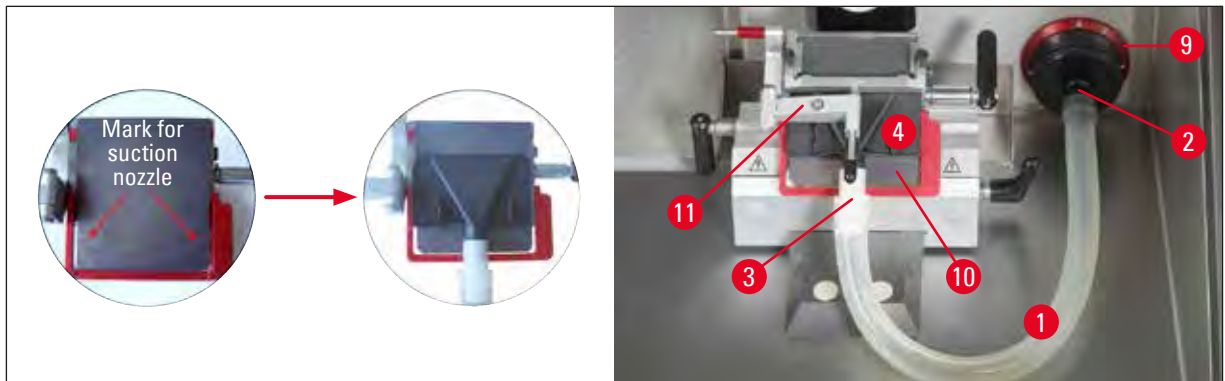

Fig. 29

The tension acting on the hose can be minimized by turning the red ring (→ Fig. 29-9) clockwise so that the suction nozzle presses against the pressure plate (→ Fig. 29-10).

Afterwards, fold the anti-roll guide (→ Fig. 29-11) back onto the pressure plate.

- The scope of delivery also includes 2 plastic clips (→ Fig. 28-8). These enable comfortable "parking" of the chamber suction nozzle (→ Fig. 28-6) during sectioning.

The clip must be glued in **BEFORE** switching on the refrigeration. Before doing so, briefly degrease the surface to ensure a secure hold.

Preferably, the clip should be attached outside the working area, e.g. on the left inside wall of the instrument.



Note

- If the suction nozzle (→ Fig. 29-4) is not being used, it can be "parked" on one of the two magnetic surfaces indicated in the interior of the instrument.
- If the extraction is not used for a long time, it is absolutely necessary to clean the extraction hose in order to ensure maximum extraction capacity. To do so, place the hose in commercially available disinfectant or alcohol. After several cleanings, the hose must be replaced (→ p. 65 – 11.1 Ordering information)!

7. Instrument Controls

7.1 Control panels on the Leica CM1950

7.1.1 Control panel 1

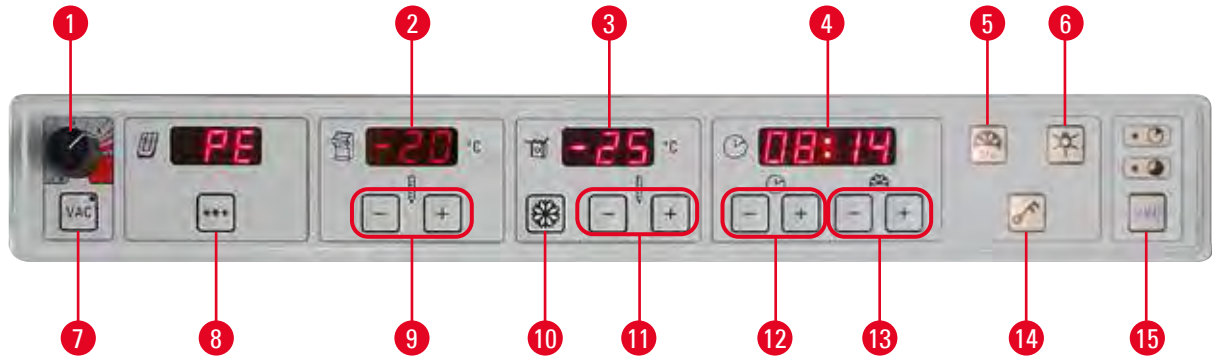

Fig. 30

- | | | | |
|---|--|----|--|
| 1 | Extraction force intensity selectable from 1-5 (see following page for more information) | 9 | +/- buttons to select chamber temperature |
| 2 | Display of actual and target chamber temperatures | 10 | Max-Cool button to select the maximum low temperature of the specimen head directly (-50 °C) |
| 3 | Display of actual and target specimen head temperatures | 11 | +/- buttons to select specimen head temperature |
| 4 | Display of real time, defrost time and error messages | 12 | +/- buttons to select real time |
| 5 | "Melting Snowflake" button to activate manual defrost | 13 | +/- buttons to select defrost time |
| 6 | ON/OFF button of illumination | 14 | Press the key button to lock/unlock the entire keypad. (Refer to following page for activation of the specimen head) |
| 7 | Button to enable/disable extraction system | 15 | UVC disinfection, (short time 30 min, long time 180 min) |
| 8 | Button to enable/disable the Peltier element | | |

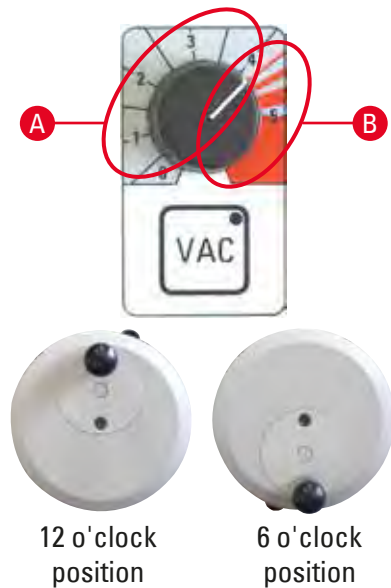

Fig. 31

Emergency Stop switch to the right of control panel 1 (motorized instruments only)

For danger situations during motorized sectioning.

- **IMMEDIATE** stop of the sectioning process – motor stops – LED (→ Fig. 33-4) in **E-STOP** is illuminated in red.
- Turning in direction of arrow cancels the stop – LED (→ Fig. 33-4) in **E-STOP** goes out.
- Select single stroke (Single) or continuous stroke (Cont.) operating mode again.



- Press the **VAC** button to enable the vacuum extractor. The LED in the **VAC** button is lit while the extractor is on. Press the button again to disable it.
- Use the knob to adjust the intensity of the vacuum.

A Optimal area for trimming and sectioning

- Trimming: Handwheel position 12-6 o'clock, valve open
Handwheel position 6-12 o'clock, valve closed
- Sectioning: Handwheel position 12-3 o'clock, valve open all the way
Handwheel position 3-6 o'clock, valve half open
Handwheel position 6-12 o'clock, valve closed

B Optimal area for extraction from the chamber

- To clean the chamber, turn the knob to the red range.



Note

The strength of the required extraction force depends on the following:

- Size of the specimen
- Sectioning speed
- Section thickness used

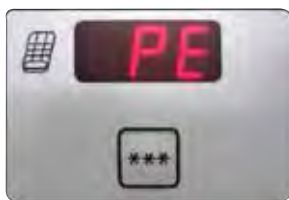

- The Peltier element provides additional cooling for the freezing stations. After the **PE** button is pressed, the display changes from "PE" to "10", indicating an additional cooling period of 10 minutes. The countdown of the remaining cooling time is permanently displayed. Once only 4 minutes are remaining, a dot will appear after the "4". As of this time, the Peltier element may be switched off early by pressing the **PE** button again.



Note

- Caution:
The specimen head and Peltier do not switch on until the chamber temperature reaches -5°C , in order to prevent icing.
- If the condenser (resting phase) is off and the Peltier cooling is activated, the number 10 flashes until the condenser switches on again to prevent the Peltier from being destroyed when the condenser is not running. When the condenser starts up, the flashing stops and the 10 minutes are counted down.
- (For exact instructions for using the chamber, specimen head and real time display fields, refer to the chapter on (→ p. 49 – 8. Working with the Instrument)).

7.1.2 Control panel 2 – Electric coarse feed, sectioning and trimming thickness

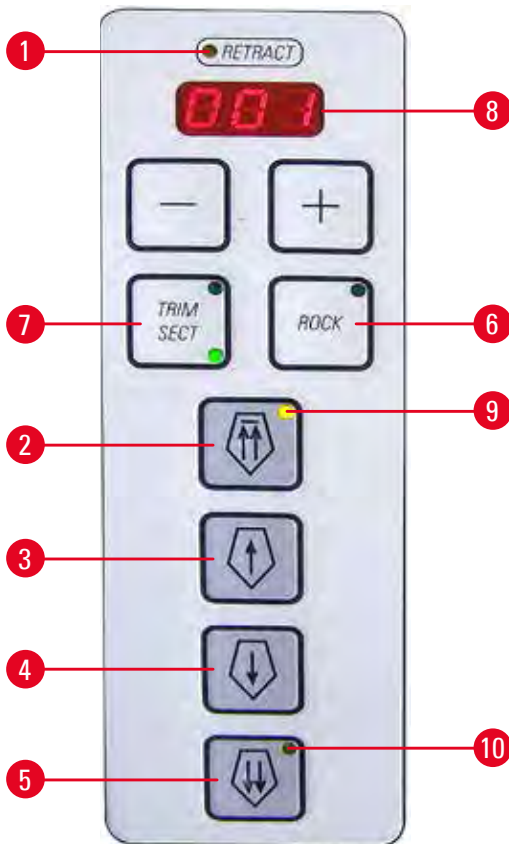

Fig. 32

- 1 Illuminates in yellow when the specimen is in retraction.
- 2 Move specimen head backwards quickly to home position (latched)
- 3 Move specimen head backwards slowly – pressing briefly retracts the specimen 20 μm
- 4 Specimen head forwards – pressing briefly advances the specimen 20 μm
- 5 Specimen head fast forward
- 6 Rocking mode – only in manual mode; in rear area, i.e. approx. 12-3 o'clock position of the handwheel (rock handwheel back and forth a short distance).
- 7 Toggle **TRIM** and **SECT** (LED active). Press approx. 3 sec.; "on" or "off" appears (for the retraction). Toggle using the "+" or "-" button
Retraction: off = 0
 on = 20 μm
in manual mode.
For **motorized sectioning**, the retraction value is fixed and cannot be changed.

**Note**



In the "off" setting, there is no retraction in manual, automatic or rocking mode.

- 8 LED for trimming and section thickness display

**Note**

For trimming values with a section thickness greater than 200 μm , the display flashes to expressly notify the user of thick sections!

Setting section/trim thickness

Use the  -  buttons on the control panel for setting; 2nd setting range **section thickness**:

1 - 100 μm

Values

1.0 μm	–	5.0 μm	in	0.5 μm	increments
5.0 μm	–	20.0 μm	in	1.0 μm	increments
20.0 μm	–	60.0 μm	in	5.0 μm	increments
60.0 μm	–	100.0 μm	in	10.0 μm	increments

Trimming section thickness setting range:

1 - 600 μm (Recommended for research applications)

Values

1.0 μm	–	10.0 μm	in	1.0 μm	increments
10.0 μm	–	20.0 μm	in	2.0 μm	increments
20.0 μm	–	50.0 μm	in	5.0 μm	increments
50.0 μm	–	100.0 μm	in	10.0 μm	increments
100.0 μm	–	600.0 μm	in	50.0 μm	increments

Trimming section thickness setting range:

(Recommended for clinical applications)

Values: 10 μm , 20 μm , 30 μm , 40 μm .

Coarse feed functions

The electric coarse feed at two speeds is used for a rapid movement of the specimen towards and away from the knife. With the double-arrow buttons, the coarse feed operates at 900 $\mu\text{m}/\text{s}$; with the single-arrow buttons, it runs at 300 $\mu\text{m}/\text{s}$.

Retracting the specimen head from the knife

fast



slow

- Pressing once starts the rapid backwards movement to the rear end position (**Home Position**).
- LED (\rightarrow Fig. 32-9) flashes, while the specimen head is in motion.
- The LED (\rightarrow Fig. 32-9) lights up when the rear end position (**HP.**) has been reached.
- The return movement can be stopped by pressing one of the coarse feed buttons.
- The rapid backwards movement to the rear end position (**HP.**) starts. The advance movement operates as long as the button is pressed.
- A brief press of the button retracts the specimen by 20 μm .

Advancing the specimen toward the knife

slow



fast

- Start the slow forwards movement to the knife. To feed the specimen, press and hold the button.
- Pressing the button briefly results in a feed motion of 20 μm .
- Start the fast forwards movement to the knife.
- The LED (\rightarrow Fig. 32-10) flashes while the specimen head is in motion. The LED (\rightarrow Fig. 32-10) lights up when the forward end position has been reached.

Manual sectioning mode

Select **ROCK** operating mode (→ Fig. 32-6) (LED active) – retraction must be enabled!

- For sectioning, turn the handwheel a short distance (approx. 1/4 turn) forwards and back (rocking mode) – only possible at rear (handwheel in approx. 12-3 o'clock position). Every change in rotation direction is electronically detected and automatically translated into a specimen feed or retraction movement.

7.1.3 Control panel 3 – Motorized sectioning (optional)

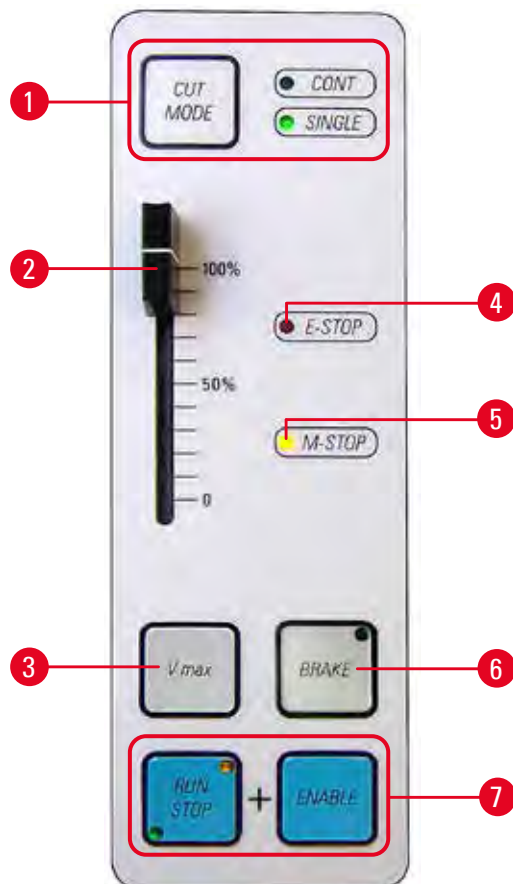

Fig. 33

- 1 Switching the sectioning mode (**CUT MODE**) from continuous stroke (**CONT**) to single stroke (**SINGLE**) (active)



Note

If emergency stop has been activated, the cutting mode must be selected again.

- 2 Motor speed controller (0-100%)
- 3 Hold the button to section at maximum speed. Release the button to continue sectioning at the previously selected speed (see controller, above).



Note

To switch from slow speed range to fast speed range: while switching on the instrument, press and hold down the Vmax button.

Speed ranges

slow: 0 – 50 strokes/min
 fast: 0 – 85 strokes/min
 Vmax: 85 – 90 strokes/min

- 4 The red LED in the **E-STOP** field indicates either:
 - Emergency-stop function active, or
 - Footswitch dummy (opt. footswitch) not connected or incorrectly connected.
- 5 The mechanical handwheel brake is enabled when the yellow LED is lit in the **M-STOP** field.



Warning

The handwheel must also be locked when working on the specimen head.

- 6 Press to brake the handwheel electronically (LED lit) – specimen stops in lower (6 o'clock) position. Can be used in any position.
 1. Press the buttons (→ Fig. 33-7) at the same time to start motorized sectioning.
 2. To end the sectioning process, press **RUN/STOP**, **ENABLE** or **BRAKE** – Specimen head stops at bottom (for **BRAKE**, automatic electronic braking takes place).
 3. Does not have to be unlocked during motorized sectioning; continue working by pressing both the **RUN/STOP** and **ENABLE** buttons.
 4. When working with the handwheel, if you have braked using **BRAKE**, also use **BRAKE** to release!

Sectioning modes

The microtome can be used both in manual and motorized operation.

The following settings are available:

- Single stroke (**SINGLE**) or continuous stroke (**CONT**) in motorized mode, and
- **ROCK** (sectioning using handwheel) in manual mode.



Note

When switching the instrument on, no operating mode is active for safety reasons.

Disinfection



Duration – 30 min

Duration – 180 min

UVC button (→ Fig. 30-15) – to activate/deactivate the disinfection cycle and/or to acknowledge interruption of a disinfection cycle.

Fig. 34

To start disinfection, the sliding window must be completely closed.

- Press **UVC** button once briefly to start the 30 min. mode
- **UVC** button – press 1x for a longer time (approx. 4 sec), 180 min mode

For current information about certificates and recommendations, visit www.leicabiosystems.com.

**Warning**

UVC disinfection is effective when disinfecting surfaces and air within the irradiated working area of the Leica CM1860 UV and Leica CM1950 cryostats at -20 °C (Table 1, see Certificate from I. Maier).

For powerful disinfection, we recommend irradiation for three hours (CM1860 UV/Leica CM1950). Vegetative bacteria including *Mycobacterium tuberculosis*, bacterial endospores (*Bacillus* sp.) and fungi are killed during this time. Viruses, including such resistant species as, for example, hepatitis viruses, are also deactivated to at least 4 log₁₀ units (99.99%).

Medium disinfection can be attained through short irradiation for 30 minutes (CM1860 UV / Leica CM1950). This reduces vegetative bacteria including *Mycobacterium tuberculosis* and sensitive viruses such as the influenza A virus and the polio virus by at least 5 log₁₀ units (99.999%).

UVC irradiation within the working area of the cryostats can provide reliable and efficient disinfection of surfaces and the air and significantly reduces the risk of infection.

We recommend wiping off visible contamination in the cryostat with an alcohol-based disinfectant prior to using the UVC lamps. The germicidal effect of the irradiation is restricted to the directly irradiated areas, which is why UVC irradiation cannot be a replacement for regular chemical disinfection of the cryostat chamber.

**Note**

Specimens and section waste must be removed completely from the cryochamber first (e. g. using the vacuum extractor (optional), or a paper towel soaked in an alcohol based disinfectant). Before UVC disinfection, move the anti-roll guide to the side to allow complete disinfection.

Opening the sliding window cancels the disinfection cycle. Press the **UVC** button to acknowledge this.

When the keypad lock is activated (via the key button) the UVC lamp can be shut off only by opening the glass, as the UVC keys are locked.

The cancellation can be acknowledged only if the keypad lock is disabled. Only then can the UVC lamp be switched back on.

8. Working with the Instrument

8.1 Preparing cutting tools, specimen discs and preparation aids



Warning

The knives are extremely sharp! Handle with care!
Never try to catch a falling knife!

- Place working materials such as the blade box or knives (in the knife case), brush, forceps or preparation needles and, where applicable, specimen discs into the cryostat chamber.

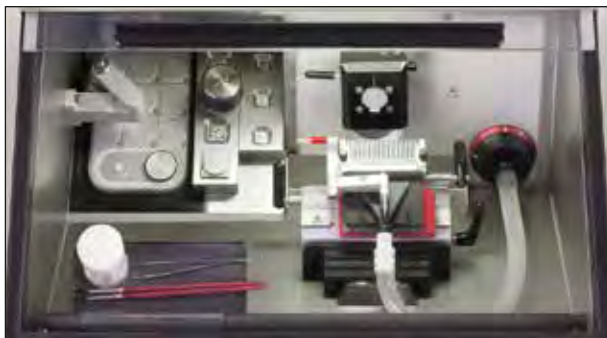

Fig. 35

- The necessary tools and preparation aids can be precooled on the (optional) movable shelf, making them available at all times in a convenient position for the user.
- Additionally, specimen discs can be precooled and stored in the storage system see (→ p. 36 – 6.5.2 Installing the storage systems (optional)).



Note

For installation of knife/blade holder and installation in the chamber see (→ p. 65 – 11. Optional Accessories).

8.2 Switching on the instrument



Note

The instrument must be switched on at least 5 hours before the planned use.



Fig. 36

The circuit breaker also serves as the power switch. The switch must be in the top position for switching on and in the bottom position for switching off. The switch must be accessible without obstruction.

- Close the sliding window.

**Note**

To avoid frost formation always put the cover on the quick freeze shelf.
Always cover the quick freeze shelf during breaks and overnight.

8.3 Configuring the parameters**Note**

The instrument must be switched on at least 5 hours before the planned use.



- Turns the LED illumination on or off.



- This button activates or deactivates the manual defrost of the cooling chamber, specimen head or freeze shelf. (For more detailed handling instructions, refer to the chapter on (→ p. 49 – 8. Working with the Instrument) in these Instructions for Use.)



- Pressing the key button for approx. 5 sec. locks the entire keyboard (the LEDs in the clock go out).
- Pressing the key button briefly, then the "-" button in the specimen head control panel, switches off the specimen head.
- Pressing the key button briefly, then the "+" button in the specimen head control panel, switches the specimen head back on.

Programming the temperature of the cryochamber

- The temperature of the cryochamber is set and indicated on the control panel marked with the cryostat symbol. The actual temperature is the standard indication. Briefly pressing the "+" or "-" button displays the target temperature. Set the desired value via the "+" / "-" buttons. Pushing the "+" or "-" button for more than 1 sec. increases or decreases the chamber temperature continuously.
- The actual value will be indicated 5 seconds after finishing the programming.

**Note**

Refer to (→ p. 64 – 10. Temperature selection chart) for a table with guide values. The temperature values given there are based on experience, but are intended solely as guide values, as any tissue may require particular adjustments.

Programming the specimen temperature

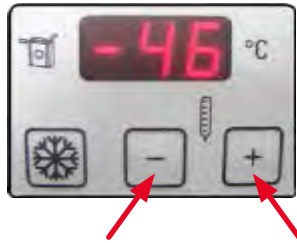

- Select the desired temperature of the specimen.
- The specimen temperature is set and indicated on the control panel marked with the specimen head symbol. The actual temperature is the standard indication. Briefly pressing the "+" or "-" button displays the target temperature. Set the desired value via the "+" / "-" buttons. Pushing the "+" or "-" button for more than 1 sec. increases or decreases the specimen temperature continuously. The actual value will be indicated 5 seconds after finishing the programming.



Note

Caution:

The specimen head and Peltier do not switch on until the chamber temperature reaches -5 °C, in order to prevent icing.

Specimen temperature – "Max-Cool" function



- The snowflake button for the "Max-Cool" function is in the specimen temperature field. Pressing the  button sets the lowest possible specimen head temperature (-50 °C) as the target temperature. The instrument adjusts the maximum low temperature of the specimen head, i.e. -50 °C.
- Push the snowflake button again to stop the "Max-Cool" function. The temperature adjusts to the value programmed prior to activating the "Max-Cool"-function.
- Alternate flashing of "LL" and the actual temperature indicates activation of the Max-Cool function.

Setting the time



- The clock time is set with the +/- buttons in the control panel marked with the clock symbol. To do so, set the current time using the "+" or "-" button below the small clock symbol. Pushing the "+" or "-" button for more than 1 sec. increases or decreases the time continuously (auto-repeat function).

Programming the defrost cycle



- Set the beginning of the automatic defrost cycle. The automatic defrost cycle takes place once within 24 hours. It is set with the "+" / "-" buttons on the right of the panel with the clock symbol. The two buttons are marked by a melting snowflake .

- Briefly press the "+" or "-" button for indication of the beginning of the defrost cycle which has actually been set. At the same time, the LEDs between the indication of hours and minutes are flashing.
- To change the beginning of the defrost cycle in steps of 15 minutes, push the "+" or "-" button. When the "+" or "-" button is pushed for more than 1 sec., the defrost time value increases or decreases continuously.







Note

Before starting the defrost cycle remove all samples from the cryochamber!

- When the automatic defrost cycle begins, the specimen head temperature adjusts to a temperature between -10°C and -5°C (reduction of ice formation). The specimen head cooling turns off. This is confirmed by the flashing of the decimal points on the panel for the specimen cooling. The specimen cooling (controlled to set value) automatically turns back on after 4 hours, once the chamber temperature varies by less than 5 K from the target temperature.
- If you want to turn the specimen cooling back on manually before the automatic activation sets in, push the "+" or "-" button on the control panel for the specimen cooling and then the key button.
- The temperature of the specimen cooling first raises to $+10^{\circ}\text{C}$ and then adjusts to the programmed specimen temperature.

Manual defrost for the freeze shelf (including Peltier element)



- Press the  button for manual defrost, then press the  button. The manual defrost takes 12 min.
- Press the  button again, then the  button to stop manual defrosting again.



Note

After defrosting the freeze shelf, carefully wipe it out, as otherwise a lot of water collects in the channel. Ice does not melt during normal defrosting.

Manual defrosting of the cryochamber



- Push the manual defrost button (with the melting snowflake) on the left over the key button to activate the defrost cycle of the cryochamber on demand.
- Activation is confirmed by an audible signal.
- Then, push the "+" or "-" button on the panel for the cryochamber temperature.
- The manual defrost cycle (12 min.) is activated.
- There is a flashing indication of the temperature of the cryochamber during the whole defrost cycle.
- If necessary, push the manual defrost button again to deactivate the manual defrost cycle.

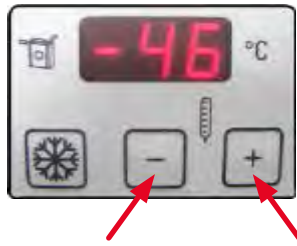

- When the manual defrost begins, the specimen head adjusts to a temperature between -10°C and -5°C (reduction of ice formation). The specimen head cooling turns off. This is confirmed by the flashing of the decimal points on the panel for the specimen cooling.
- Ten seconds after the manual defrost cycle has been completed, the specimen cooling turns back on.



Warning

Before starting the defrost cycle, remove all specimens from the cryochamber!

Manual defrosting of the specimen cooling



- Push the manual defrost button (with the melting snowflake) on the left over the key button to activate the defrost cycle of the specimen head.
- Activation is confirmed by an audible signal.

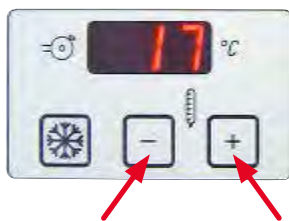

- Then, push the "+" or "-" button on the panel for the specimen temperature.
- There is a flashing indication of the specimen temperature during the defrost cycle.
- For 15 minutes, the specimen head is adjusted to a temperature of 45°C.
- Subsequently, the instrument adjusts to the specimen temperature which has been programmed prior to the manual defrost cycle.
- If necessary, push the manual defrost button again to deactivate the manual defrost cycle.



Note

Press the key button, then the "+" button = specimen head on
Press the key button, then the "-" button = specimen head off

Entering the trimming thickness



Note

To switch from a trimming section thickness for research applications (1 - 600 µm) to a thickness for clinical applications (10, 20, 30 or 40 µm), press and hold down the **TRIM/SECT** button (→ Fig. 32-7) while switching on the instrument.





- Press the **TRIM/SECT** button. **TRIM** mode is active if the LED at the top right is illuminated.
- Set the desired trimming thickness using the "+" or "-" button in control panel 2 (for the adjustable sequence of steps, see (→ p. 44 – 7.1.2 [Control panel 2 – Electric coarse feed, sectioning and trimming thickness](#))).

Entering the section thickness



- Press the **TRIM/SECT** button. **SECT** mode is active if the LED at the bottom right is illuminated.
- Set the desired section thickness using the "+" or "-" button in control panel 2 (for the adjustable sequence of steps, see (→ p. 44 – 7.1.2 [Control panel 2 – Electric coarse feed, sectioning and trimming thickness](#))).

Switching the retraction on or off in manual sectioning mode

- Press the **TRIM/SECT** button for approx. 3 sec. The LED in control panel 2 displays on  or off .
- You can switch by pressing the "+" or "-" button.
- "Retraction on" means a specimen retraction of 20 µm in manual mode.



Note

During motorized sectioning, the retraction value is speed-dependent and cannot be changed by the user.

8.4 Working with the precooled cryostat

8.4.1 Preparatory work



Fig. 37

- Lock the handwheel in the top (12 o'clock) position.
- Cut the specimen to size outside of the cryostat.
- Select the precooled specimen disc, cover it with freezing compound, then attach and orient the specimen.

**Warning**

The safety gloves included in the standard scope of delivery must be worn when working inside the cryostat chamber!



Fig. 38

- Attach the specimen disc and specimen to the Peltier position on the freeze shelf. Activate the Peltier element and wait until the specimen is completely frozen.

**Note**

Specimens that have been frozen on the Peltier element are often too cold and split apart during sectioning. Allow time for the specimens to become acclimated.

- Insert the specimen disc into the specimen head.

**Note**

Specimen head adjustment:

After extended use, it is possible for the specimen head (→ Fig. 39-2) to loosen and cause artifacts when sectioning. In this case, a simple re-adjustment is necessary.

To prevent injuries, remove the blade/knife holder before adjusting the dovetail guide. Place the blade/knife holder within the cryochamber so that it does not get warm and can be reused right after the adjustment.

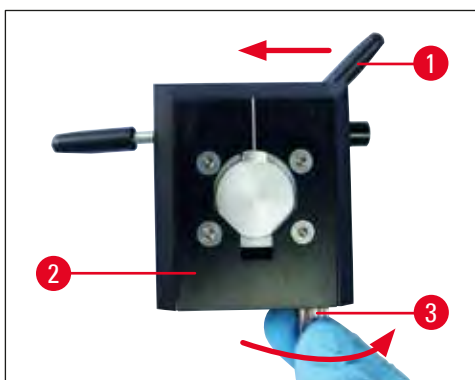

Fig. 39

- Move the specimen head forwards and out, into the front end position.
- Move the locking lever (→ Fig. 39-1) for orientation on the specimen head (→ Fig. 39-2) to the left to loosen the specimen head.
- Now turn the setscrew (→ Fig. 39-3) on the bottom of the specimen head clockwise until you feel the specimen head click into place.
- Move the locking lever for orientation back to the right to lock the specimen head and make sure that the specimen head is now stable.
- Repeat the procedure if necessary.

**Note**

Check the stability of the specimen head each time it clicks back into place. This can prevent it from becoming difficult to set the zero position.

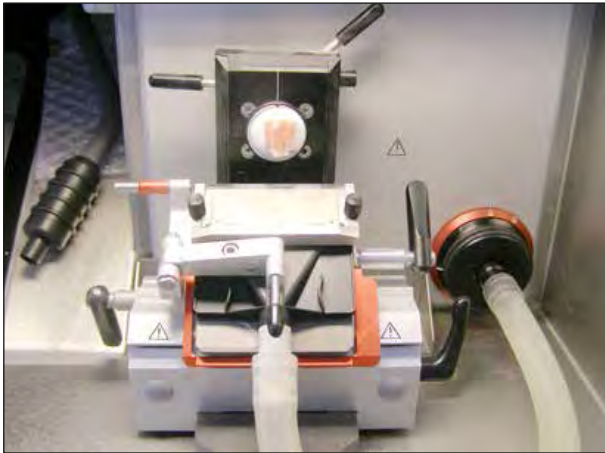

Fig. 40

**Note**

Before using them for the first time, degrease new knives using acetone or alcohol.

- Approach the specimen with the knife or blade holder:
 - To do so, open the clamping lever of the base, approach the specimen and close the lever again.
 - Open the lever of the orientation. Orient the specimen (move it into a favorable position relative to the knife/blade) and close the lever again.



- Approach the knife or blade holder using the coarse feed buttons and gentle movements of the handwheel.

**Note**

If the sections are cracked, the specimen head temperature is too cold. Set a warmer temperature.
If the sections smear, the specimen head temperature is too warm. Set a colder temperature.

8.4.2 Trimming with extraction – 1. Anti-roll guide installed

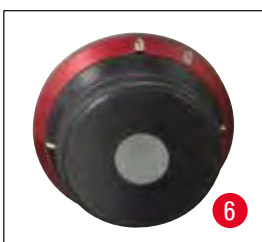

Fig. 41

- Remove the silicone stopper (→ Fig. 41-6) from the filter cover (and keep it in a safe place).
- Insert the extraction hose with the black adapter.
- Fold the anti-roll guide to the side and fasten the extraction nozzle to the pressure plate (using 4 magnets on the rear side of the nozzle) – see mark (→ Fig. 42-1) – (using 4 magnets on the rear side of the nozzle).
- Fold the anti-roll guide back into position.

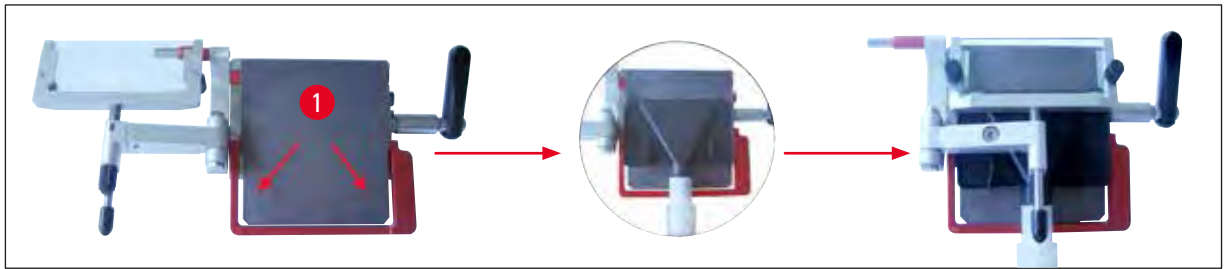

Fig. 42

**Note**

Ensure that the hose with the nozzle is not installed against its "natural" curvature on the pressure plate of the knife holder.

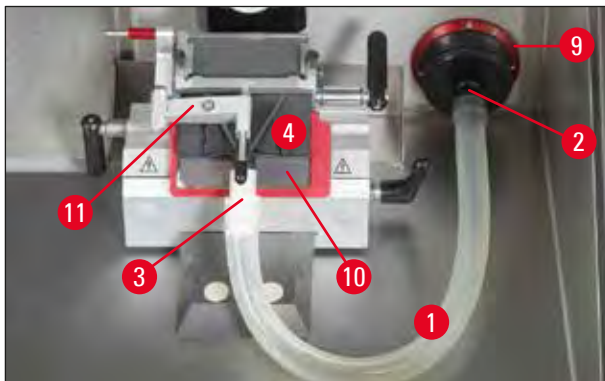

Fig. 43

The tension acting on the hose can be minimized by turning the red ring (→ Fig. 43-9) clockwise so that the suction nozzle presses against the pressure plate (→ Fig. 43-10).



- Check that the anti-roll guide is parallel and correctly adjusted. Read just if necessary (→ p. 72 – Adjusting the blade holder with anti-roll guide).
- Activate trimming mode.
- Select the trimming thickness.



- Switch on the VAC and select a low extraction level (between 1 and 2).



- Start trimming by manually moving the handwheel or press the **RUN/STOP** and **ENABLE** buttons simultaneously to start motorized sectioning.

**Note**

For motorized sectioning, always begin at low speed for safety reasons.

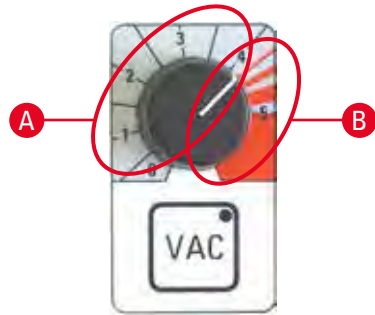

12 o'clock position

6 o'clock position

- Optimize the vacuum settings if necessary.
- Press the **VAC** button to enable the vacuum extractor. The LED in the **VAC** button is lit while the extractor is on. Press the button again to disable it.
- Use the knob to adjust the intensity of the vacuum.

A Optimal area for trimming and sectioning

- Trimming: Handwheel position 12-6 o'clock, valve open
Handwheel position 6-12 o'clock, valve closed
- Sectioning: Handwheel position 12-3 o'clock, valve open all the way
Handwheel position 3-6 o'clock, valve half open
Handwheel position 6-12 o'clock, valve closed

B Optimal area for extraction from the chamber

- To clean the chamber, turn the knob to the red range.



Note

If the handwheel is not moved for approx. 5 sec, the valves close and the fan remains on.
If the handwheel is not moved for approx. 1 min, the valves close, the fan shuts off (the LED in the **VAC** button goes off to prevent icing).
To continue working, you now have to reactivate the **VAC** button.

Trimming with extraction – 2. Brush technique, finger rest installed

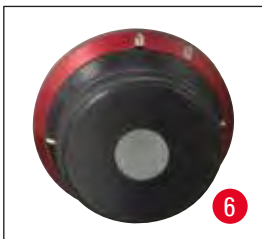

Fig. 44

- Remove the silicone stopper (→ Fig. 44-6) from the filter cover (and keep it in a safe place).
- Insert the extraction hose with the black adapter.
- Fasten the suction nozzle to the pressure plate (using 4 magnets on the rear side of the nozzle) as far as possible towards the blade.



Note

Ensure that the hose with the nozzle is not installed against its "natural" curvature on the pressure plate of the blade holder.



Fig. 45

The tension acting on the hose can be minimized by turning the red ring (→ Fig. 29-9) clockwise so that the suction nozzle presses against the pressure plate.

- Check that the suction nozzle is seated optimally (by gently turning the handwheel).
- Activate trimming mode.
- Select the trimming thickness.
- Switch on the VAC and select a low extraction level (between 1 and 2).
- Start trimming by manually moving the handwheel or press the **RUN/STOP** and **ENABLE** buttons simultaneously to start motorized sectioning.
- Use a brush to apply the section to a precooled specimen slide, then warm it from below using your finger.
- Move the safety guard forward after removing the section.
- Remove the knife or disposable blade (using the blade ejector!).
- Insert the knife into the knife case.

8.4.3 Cutting with extraction – Anti-roll guide installed

- Shut off VAC (LED in **VAC** button goes out).
- Switch from trimming to sectioning mode (important for section stretching, as the valves work differently than in trimming mode).
- Set the desired section thickness.
- Switch on the VAC and begin at level 1. If the section does not stretch correctly, turn the **VAC** knob (→ Fig. 30-1) higher in small increments.
- Once the desired section is on the pressure plate, switch off the VAC!
- Carefully fold the anti-roll guide to the side and remove the section from the side.



Note

- After removing the section, wipe off moisture/condensate from the pressure plate – otherwise, the next sections will become jammed.
- Sectioning with extraction without anti-roll guide (brush technique) is not possible, as the position of the pressure plate means that no suitable air flow is obtained.

A few rules:

- Always begin at a low extraction level, then slowly increase it.
- Do not use high extraction levels unless absolutely necessary.
- Different specimen sizes require different extraction levels.
- The faster the trimming or sectioning speed, the lower the extraction level should be.
- The larger and/or thicker the specimen to be trimmed, the lower the extraction value.
- For section specimens with a diameter of 0.5 cm, the anti-roll guide stretches the section adequately. For larger specimens, we recommend using the vacuum function.

After trimming or sectioning:

Specimen:

- Unclamp and thaw.
- Immerse in fixative for further processing.

Cleaning:

- Use the brush to sweep up the section waste (section waste tray) and remove it from the cryostat (follow applicable laboratory regulations for disposal).

or

- Clean the cryostat chamber using the chamber suction nozzle:

- To do so, turn the (flat) suction nozzle of the extraction hose by holding the hose on the white adapter and removing it with a quick twist. "Park" the flat suction nozzle in a designated place in the chamber – e.g. on the right inside wall of the cryochamber.
- Remove the chamber suction nozzle from the plastic clip and attach it firmly to the white adapter.

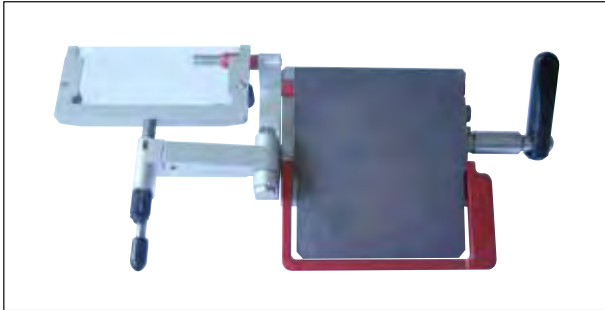

Fig. 46

- Check the remaining capacity of the filter (in the interior of the chamber) and change the filter if necessary (→ p. 39 – 6.5.8 Assembling the filter bag).
- Check the HEPA filter (in the front of the unit), (→ p. 39 – 6.5.7 Inserting/changing the HEPA filter), change it at least every 3 months.
- Move the anti-roll guide to the side (→ Fig. 46).
- Wipe the cryostat chamber using a paper towel soaked in an alcohol based disinfectant.
- Activate the UVC disinfection.



Warning

Before switching on the instrument again, proper ventilation of the chamber shall be ensured. Ensure that the chamber is completely dry and ventilated before you plug the instrument back in and turn it on.

9. Troubleshooting

9.1 Problems during work

Problem	Cause	Remedy
Frost on chamber walls and microtome	Cryostat is exposed to air currents (open windows and doors, air conditioning).	Move to a draft-free location.
	Frost built-up by breathing into the cryochamber.	Wear mouth protection.
Sections smear	Specimen not cold enough.	Select lower temperature.
	Anti-roll plate not yet cold enough, thus warming the section.	Wait until knife and/or anti-roll plate have reached chamber temperature.
Sections splinter	Specimen too cold.	Select higher temperature.
Sections not properly flattened	Static electricity/air currents.	Remove cause.
	Specimen not cold enough.	Select lower temperature.
	Large area specimen.	Trim the specimen parallel, increase section thickness.
	Anti-roll plate poorly positioned.	Reposition anti-roll plate.
	Anti-roll plate poorly aligned with knife edge.	Align correctly.
Sections not properly flattened despite correct temperature and correctly aligned anti-roll plate	Incorrect clearance angle.	Set correct angle.
	Blunt knife.	Use different part of the knife.
	Knife and/or anti-roll plate not clean.	Clean with dry cloth or brush.
Sections curl up on anti-roll plate	Edge of anti-roll plate damaged.	Replace anti-roll plate.
	Blunt knife.	Use different part of the knife.
Sections curl up on anti-roll plate	Anti-roll plate does not protrude far enough beyond the knife edge.	Readjust correctly.
Scraping noise during sectioning and specimen return movement	Anti-roll plate protrudes too far beyond the knife edge and is scraping against the specimen.	Readjust correctly.
Ridged sections	Uneven sections	Use different part of the knife.
	Knife/blade damaged.	Replace anti-roll plate.
	Edge of anti-roll plate damaged.	
Chatter during sectioning	Specimen insufficiently frozen onto the specimen disc.	Refreeze specimen onto the disc.
	Specimen disc not clamped tightly.	Check disc clamping.
	Knife not clamped tightly enough.	Check knife clamping.

Problem	Cause	Remedy
	Specimen has been sectioned too thickly and has detached from disc.	Refreeze specimen onto the disc.
	Very hard, inhomogenous specimen.	Increase section thickness; reduce specimen surface area if necessary.
	Blunt knife.	Use different part of the knife.
	Knife profile inappropriate for specimen cut.	Use knife with different profile.
	Incorrect clearance angle selected.	Set correct angle.
Condensation on anti-roll plate and knife during cleaning	Brush, forceps and/or cloth too warm.	Store all tools on storage shelf in the cryochamber.
Anti-roll plate damaged after adjustment	Anti-roll plate too high above the knife edge. The adjustment was carried out in the direction of the cutting edge.	Replace anti-roll plate. Be more careful next time!
Thick/thin sections	Temperature incorrect for the tissue cut.	Select correct temperature.
	Knife profile inappropriate for the specimen cut.	Use knife with different profile (c or d).
	Ice buildup on the knife back.	Remove ice.
	Handwheel speed not uniform or turned at incorrect speed.	Adapt speed.
	Knife not clamped tightly enough.	Check knife clamping.
	Specimen disc not clamped tightly enough.	Check disc clamping.
	Cryocompound applied to cold specimen disc; specimen detached from disc after freezing.	Apply cryocompound to warm disc, mount specimen and freeze.
	Blunt knife	Use different part of the knife.
	Inappropriate section thickness.	Select correct section thickness.
	Incorrect clearance angle selected.	Set correct angle.
	Microtome not dried thoroughly enough.	Dry microtome.
	Dried specimen.	Prepare new specimen.

Problem	Cause	Remedy
Tissue sticks to the anti-roll plate	Anti-roll plate is too warm or incorrectly positioned.	Cool down anti-roll plate, or reposition correctly.
	Fat on the corner or edge of anti-roll plate.	Remove fat from anti-roll plate.
	Anti-roll plate not correctly fixed.	Fix correctly.
	Rust on the knife.	Remove rust.
Flattened sections curl up when anti-roll plate is folded up	Anti-roll plate too warm.	Cool down anti-roll plate.
Sections tear or separate	Temperature too low for the tissue cut.	Set alternative temperature and wait.
	Blunt part, dirt, dust, frost or rust on the knife.	Remove cause.
	Top edge of the anti-roll plate damaged.	Replace anti-roll plate.
	Hard particles in the tissue.	- - -
	Dirt on knife back.	Clean.
Cryostat non-operational	Power plug not properly connected.	Check if properly connected.
	Defective fuses, or circuit breaker has triggered.	Replace fuses, or switch circuit breaker back on. If not possible, call technical service.
Specimen disc cannot be removed	Moisture on the underside causes the specimen to freeze to the freezing shelf or specimen head.	Apply concentrated alcohol to the contact point.
No or insufficient refrigeration of the cryochamber	Cooling system or electronic drive defective.	Call technical service.
Sliding window collects condensation	Air humidity and room temperature too high.	Comply with the requirements for the installation site.
No or insufficient refrigeration of the specimen	Cooling system or electronic drive defective.	Call technical service.
Both disinfection LEDs flash alternately	UVC radiation provided by UVC lamp no longer sufficient.	Replace UVC lamp following the manufacturer's instructions.

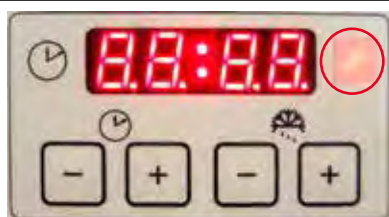

Fig. 47

Image of an open-ended wrench appears due to fault to be rectified

Contact technical service and follow the instructions given.

10 Temperature selection chart

10. Temperature selection chart

Tissue type	Chamber temperature	Specimen head temperature
Spleen	-15 °C to -20 °C	-11 °C
Liver	-10 °C -15 °C	-20 °C off until -15 °C
Intestine	-10 °C -15 °C	-20 °C A*: off until -20 °C E*: -20 °C
Heart	-10 °C -15 °C	A: -20 °C E: -20 °C to -30 °C off until -20 °C
Ovaries	-10 °C -15 °C	E: -20 °C off until -15 °C
Fallopian tube	-10 °C -15 °C	E: -20 °C off until -15 °C
Kidney	-10 °C -15 °C -20 °C	-20 °C A: off until -15 °C -20 °C
Muscle	-18 °C to -20 °C	-15 °C
Skin with fat	-19 °C	-32 °C to -40 °C
Hard fat	-19 °C	-21 °C to -25 °C
Stomach	-10 °C -15 °C	-20 °C off until -15 °C
Brain	-15 °C	-10 °C, *E

***A = mounted, *E = completely embedded**

The temperature values given in this table are based on experience; however, these are only approximate values as any tissue may require particular adjustments.

11. Optional Accessories

11.1 Ordering information

	Part No.
Specimen disc ø 20 mm assembly	14 0477 43739
Specimen disc ø 30 mm assembly	14 0477 40044
Specimen disc ø 40 mm assembly	14 0477 40045
Specimen disc ø 55 mm assembly	14 0477 40046
Specimen disc 80 x 50 mm assembly	14 0477 43714
O-ring blue (10 pieces), ø 20 mm and 30 mm	14 0477 43247
O-ring red (10 pieces), ø 20 mm and 30 mm	14 0477 43248
O-ring blue (10 pieces), ø 40 mm	14 0477 43249
O-ring red (10 pieces), ø 40 mm	14 0477 43250
O-ring blue (10 pieces), ø 55 mm	14 0477 43251
O-ring red (10 pieces), ø 55 mm	14 0477 43252
Blade holder base, assembly	14 0477 40351
Blade holder CE-BB, assembly	14 0477 43005
Low-profile straightedge, assembly	14 0477 42488
Finger rest, assembly	14 0477 40387
Anti-roll plate 70-50 µm assembly	14 0477 42491
Anti-roll plate 70-100 µm assembly	14 0477 42492
Anti-roll plate 70-150 µm assembly	14 0477 42493
Glass insert 70 mm, polished	14 0477 42497
Glass insert 50 mm, for knife holder CN	14 0419 33816
Knife holder base assembly	14 0477 42359
Knife holder attachment CN, assembly	14 0477 42358
Knife support CN short	14 0477 42380
Knife support CN	14 0477 42370
Knife holder attachment CN-Z, assembly	14 0477 42363
Anti-roll plate assembly glass 50 mm	14 0419 33981
Heat and cold extractor, assembly	14 0477 41039
Cold extractor, assembly	14 0477 43737
Heat extractor, assembly	14 0477 43126
Section waste tray	14 0477 40062
Brush shelf	14 0477 43036
Storage system, assembly	14 0477 42618
Shelf, movable	14 0477 43037
Retaining device freezing shelf	14 0477 40080
Cover freezing shelf	14 0477 43763
Specimen disc, 37 x 37 mm	14 0477 42603
Specimen disc, 28 x 28 mm	14 0477 42604
Shelf, large	14 0477 42600

	Part No.
Shelf, medium size	14 0477 42601
Shelf, small	14 0477 42602
Heat extractor, Dr.Peters, assembly	14 0477 41338
Freezing griddle/heat extractor	14 0201 39119
Dispensing slides 8 pieces	14 0201 39127
Foot rest assembly	14 0477 42832
Accessory kit extraction	14 0477 43300
HEPA filter 350/5865	14 0477 40296
Hose set, 5 pieces	14 0477 44469
Filter assembly, 25 pieces, with coarse filter insert	14 0477 44307
Safety gloves size M	14 0340 29011
Safety gloves size S	14 0340 40859
Footswitch, dummy plug CM3050	14 0443 30420
Laboratory chair on sliders (8030442)	14 0710 34911
Footswitch assembly	14 0505 33888
Easy Dip staining container white	14 0712 40150
Easy Dip staining container pink	14 0712 40151
Easy Dip staining container green	14 0712 40152
Easy Dip staining container yellow	14 0712 40153
Easy Dip staining container blue	14 0712 40154
Easy Dip staining rack gray	14 0712 40161

**Note**

Leica blade holders are optimized for use with Leica Biosystems disposable blades with the blade dimensions for low-profile blades of: L x H x W (mm) 80 +/-0.05 x 8 +0/-0.1 x 0.254 +/-0.008 and blade dimensions for high-profile blades of: L x H x W (mm) 80 +/-0.05 x 14 +0/-0.15 x 0.317 +/-0.005.

Bladeholder CE with anti-roll guide (for low-profile, LP, and high-profile, HP)

Fig. 48

- With blade ejector (→ Fig. 48-3)
- With safety guard (→ Fig. 48-1)
- Integrated lateral shift and stable base
- Clearance angle adjustment (→ Fig. 48-7) using size 4 Hexagon key (see detail fig. left on the blade holder) – recommended angle between 2° and 5°.
- With anti-roll guide (→ Fig. 48-9)
- Lever (→ Fig. 48-6) for the lateral shift
- Lever (→ Fig. 48-5) for clamping the blade
- Lever (→ Fig. 48-4) for clamping the base (→ Fig. 48-2) to the dovetail guide in the chamber
- Pressure plate (→ Fig. 48-8) for section extraction
- When using low-profile blades, the straightedge (→ Fig. 51-11) must be inserted.

Assembling the anti-roll guide system (for the blade holder CE)

Fig. 49

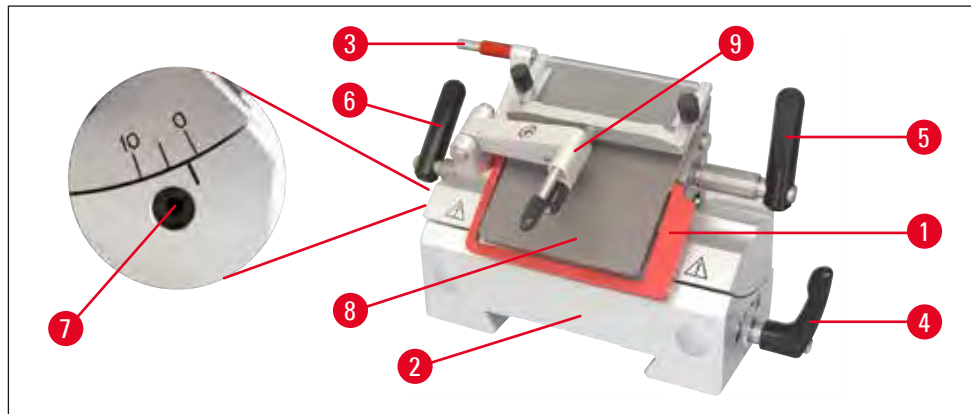
1. Insert the glare-minimizing glass insert into the interchangeable frame and tighten it evenly using the knurled screw (→ Fig. 49-1).
2. Insert the shaft (→ Fig. 49-2) of the metal frame for exchangeable glass inserts from above into the bore of the swing arm (12) in such a way that the pin rests in the notch.

11 Optional Accessories

3. Push the white plastic plate (→ Fig. 49-5) from below onto the shaft (→ Fig. 49-3).
4. Screw the knurled nut (→ Fig. 49-4) from below onto the shaft (→ Fig. 49-3).

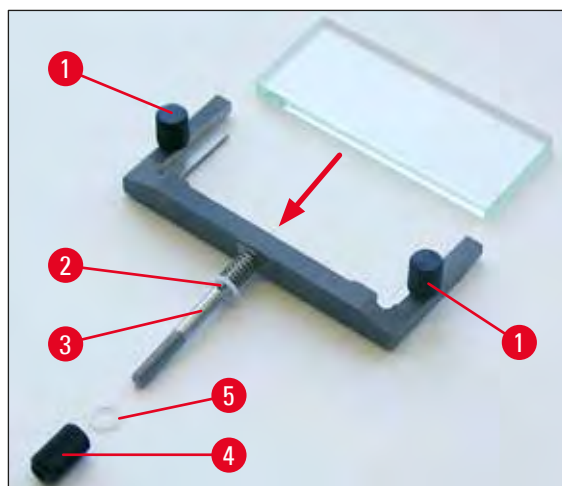

Note

The glass of the anti-roll guide can be used from all 4 sides when replacement is necessary (the glass stage plate can be reordered).

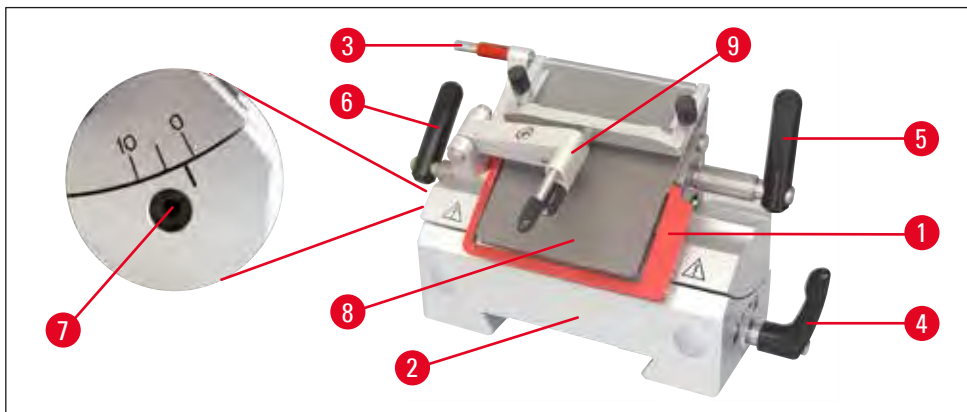

Fig. 50



Note

Red elements on the blade and knife holders, such as the safety guard and ejector, are protective devices that may not be removed.

The anti-roll guide (→ Fig. 50-9) and pressure plate (→ Fig. 50-8) must be parallel to each other.

- Blade ejector (→ Fig. 50-3) and safety guard (→ Fig. 50-1)
- Integrated lateral shift and stable base
- Clearance angle adjustment (→ Fig. 50-7) using size 4 Hexagon key (recommended angle between 2° and 5°)
- With finger rest (→ Fig. 51-9) for brush specimen
- Clamping lever (→ Fig. 50-4) for lateral shift must point downward to permit unhindered shifting of finger rest.
- When using high-profile blades, remove the blade rest (→ Fig. 51-11).

Blade holder CE with finger rest (for LP + HP)

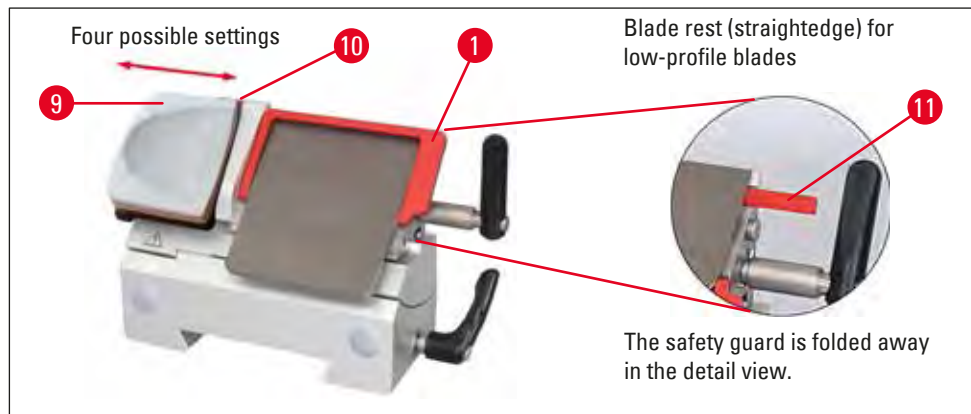

Fig. 51

Conversion of blade holder with anti-roll guide to blade holder with finger rest

- Screw off the anti-roll guide.
- Unscrew left Hexagon screw using size 2.5 Hexagon key and remove base of anti-roll guide.
- Attach the finger rest (→ Fig. 51-9) from the left, tighten the Hexagon screw using the size 2.5 key – be careful of the blade ejector!



Note

If you are working with the brush technique, the safety guard must be folded upwards.

Inserting/ejecting the blade into/from the blade holder CE



Warning

The safety gloves included in the standard scope of delivery must be worn when inserting the blade!

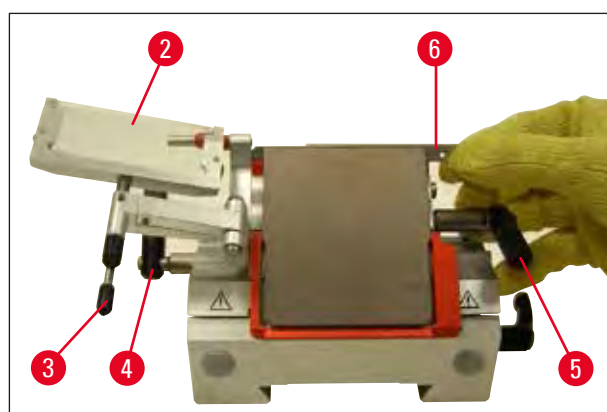

Fig. 52

1. Fold the anti-roll guide system (→ Fig. 52-2) to the left – while doing so, hold the lever (→ Fig. 52-3) (**NOT** the adjusting screw of the anti-roll guide) so that the height of the anti-roll guide remains unchanged.

11 Optional Accessories

2. Open the clamping lever (→ Fig. 52-5) by turning it counterclockwise.
3. Carefully insert the blade (→ Fig. 52-6) from above or from the side between the pressure plate and the blade rest. Make sure that the blade is inserted so that it is centered.
4. Rotate lever (→ Fig. 52-5) clockwise to clamp.
5. Fold the anti-roll guide system (→ Fig. 52-2) back to the right (toward the blade) using the lever (→ Fig. 52-3).

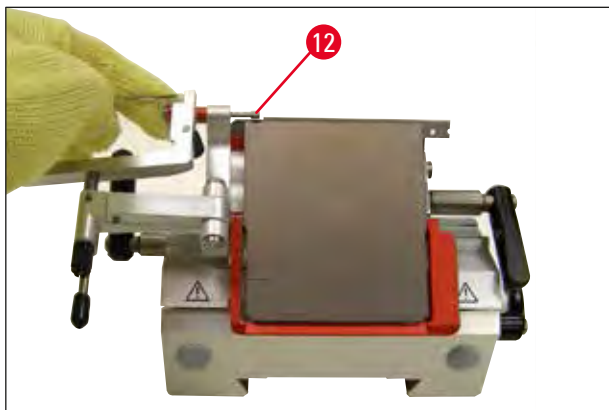

Fig. 53



Note

Anti-roll guide system functions as a safety guard here!
Use the blade ejector (→ Fig. 53-12) to eject the blade!

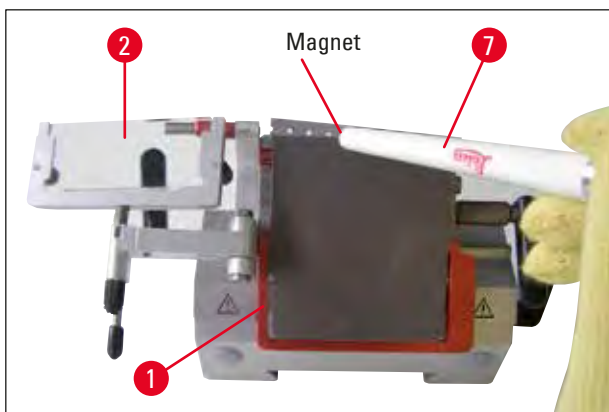

Fig. 54

6. Another option for removing the blade is to use the brush with magnet (→ Fig. 54-7).
To do so, fold the clamping lever (→ Fig. 52-5) downwards counterclockwise. Likewise, fold the safety guard (→ Fig. 54-1) downward.
Guide the brush with magnet to the blade and lift it upwards and out.



Warning

The safety gloves included in the standard scope of delivery must be worn when disposing of the blade!



Fig. 55

Once the blade has been removed from the blade holder, it is disposed of into the dispenser container (storage compartment in bottom, (→ Fig. 55)), or according to laboratory regulations.

Lateral shift for blade holder CE

If the sectioning results are not satisfactory, the knife holder can be shifted sideways in order to use another part of the blade.

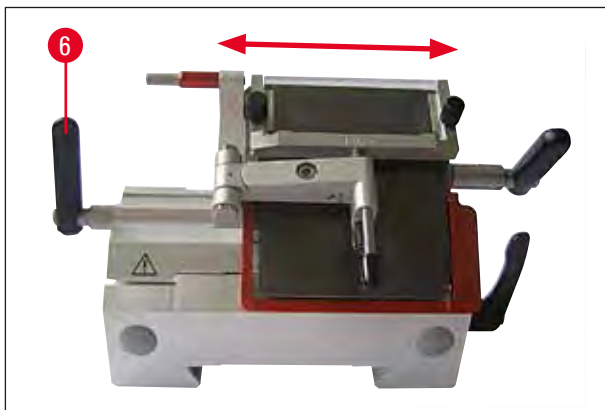

Fig. 56

To do so, follow these steps:

1. Release the clamping lever (→ Fig. 56-6) by folding it back and move the knife holder back until the desired position is reached (3-point click stop enables you to accurately find a new cutting position).
2. Fold the clamping lever (→ Fig. 56-6) forwards for clamping.

11 Optional Accessories



Fig. 57

(→ Fig. 57), Knife holder CN with glass anti-roll guide

Adjusting the blade holder with anti-roll guide



Fig. 58

(→ Fig. 58), Blade holder CE with glass anti-roll guide

You can adjust the height of the anti-roll guide system using the knurled nut (→ Fig. 58-10):

- If you turn the nut counterclockwise, the antiroll guide system moves toward the blade.
- If you turn the nut clockwise, the anti-roll guide system moves away from the blade.

If the anti-roll guide system is in the wrong position relative to the cutter, the following problems will result:

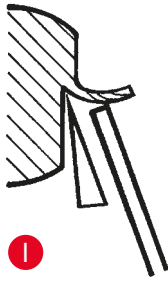

Fig. I: The section rolls over the glass insert of the anti-roll guide system.

Error: Glass insert not high enough.

Remedy: Turn the knurled nut counterclockwise until the section is pushed between the blade and anti-roll guide as shown in **Fig. III**.



Fig. II: Section tears and block hits the glass insert after sectioning.

Error: Anti-roll guide system is set too high.

Remedy: Turn the knurled nut clockwise until the section is pushed between the blade and anti-roll guide as shown in **Fig. III**.

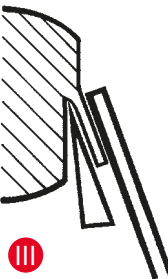

Fig. III: Correct position of the anti-roll guide to the cutter



Note

Generally, we recommend pre-adjusting the anti-roll guide system at a high section thickness (e.g. 10 μm). Start from there and work your way down to the desired section thickness in small increments, readjusting the anti-roll guide system at each increment using the knurled nut.

Cleaning the blade holder CE

Daily cleaning



Warning

The safety gloves included in the standard scope of delivery must be worn when cleaning the blade holder to prevent frostbite of the skin.

11 Optional Accessories

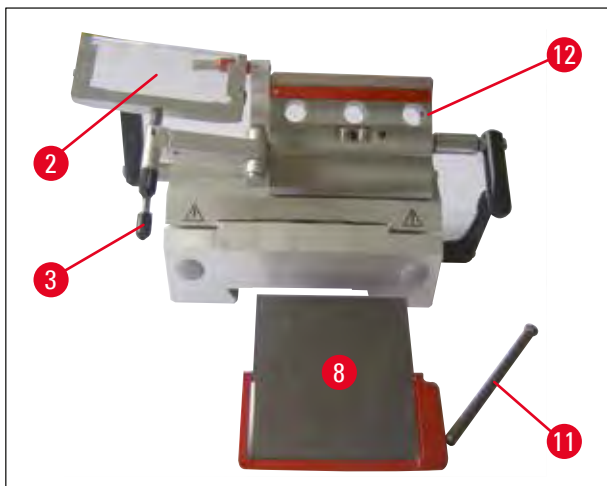

Fig. 59

1. Fold the anti-roll guide system (→ Fig. 59-2) to the left while holding it down by the lever (→ Fig. 59-3).
2. Unscrew the bolts (→ Fig. 59-11) of the pressure plate.
3. Afterwards, the pressure plate (→ Fig. 59-8) can be removed for cleaning (with alcohol or acetone).



Note

For disinfection, a paper towel soaked in an alcohol based disinfectant can be used.

Cleaning the knife holder CN

Daily cleaning



Fig. 60

For daily cleaning, it is enough to fold the anti-roll guide system forwards and remove the section waste from the knife holder using a dry brush. Please use a cold brush, as otherwise the section waste will thaw and stick to the knife holder.

**Note**

It is not necessary to oil parts, such as the T-piece on the microtome base plate, clamping lever etc.

Disinfection**Warning**

Before switching on the instrument again, proper ventilation of the chamber shall be ensured. Ensure that the chamber is completely dry and ventilated before you plug the instrument back in and turn it on.

Wipe the contaminated surfaces with a paper towel soaked in an alcohol based disinfectant.

Knife holder CN with anti-roll guide – Moving the clamping jaws and inserting the knife**Note**

The specimen disc 50x80 mm is suitable only for section thicknesses up to approx. 5 µm (due to the large specimen size).

The large specimen disc (80x50 mm) should preferably be used with knife holder CN and the 16 cm C-profile steel knife.

The clamping jaws are factory-installed in the knife holder with a clearance of 64 mm. If necessary, both clamping jaws can be offset with a clearance of 84 mm.

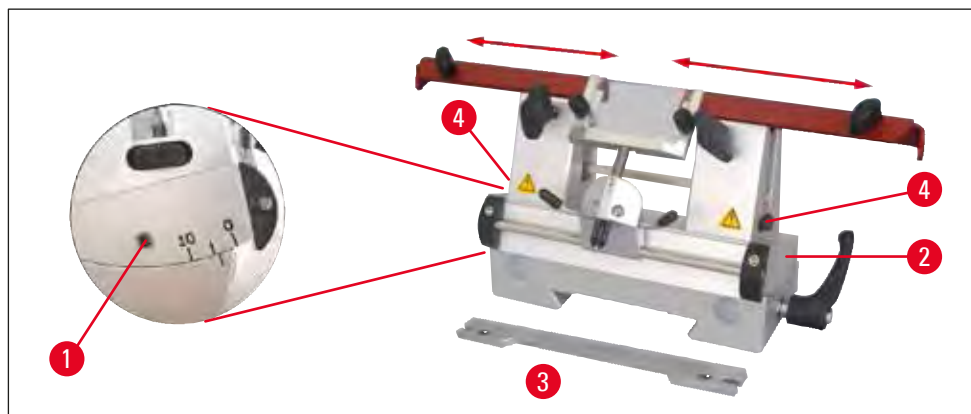

Fig. 61

Perform the following steps:

- Use a size 4 Hexagon key to loosen the screw over the clearance angle adjustment (→ Fig. 61-1) and remove the segment arc (→ Fig. 61-2) from the knife holder base.

11 Optional Accessories

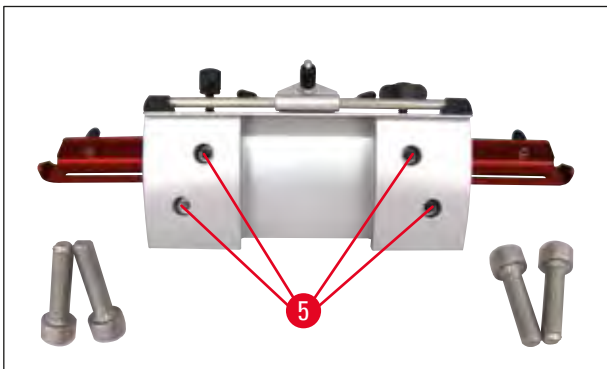

Fig. 62

- Use a size 4 Hexagon key to loosen the screws (→ Fig. 62-5) on the underside of the segment arc.



Fig. 63

- Carefully pull the clamping jaw (→ Fig. 63-6) on the right upward and insert it in the neighboring hole (→ Fig. 63-7). Tighten the screws from the underside of the segment arc. Repeat on the left side.
- Insert the long knife support (→ Fig. 61-3) on the side over the knurled screw (→ Fig. 61-4) so that the recess faces the user – turn the height adjustment knurled screws until the lower stop is reached.
- The knife can now be inserted from the side and its height adjusted via the knurled screws (→ Fig. 61-4).



Warning

Never work with only one clamping jaw, as this does not ensure the stability required for the sectioning process. Also, a long knife will not be sufficiently protected by the safety guard in this instance.

Safety guard/lateral movement for knife holder CN

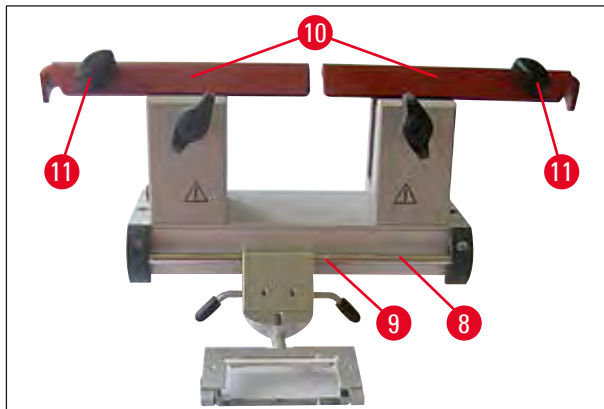

Fig. 64

The safety guard (→ Fig. 64-10) is fixed and integrated into the clamping jaws. The safety guard has handles (→ Fig. 64-11) that allow it to be moved. The safety guard is adequate for knives up to 22 cm in length. Always cover exposed parts of the knife blade after sectioning.

The anti-roll guide system can be moved sideways (only for the 84 mm variant). To better find the mid position, a groove (→ Fig. 64-9) is provided in the shaft (→ Fig. 64-8).

Knife holder CNZ with anti-roll guide

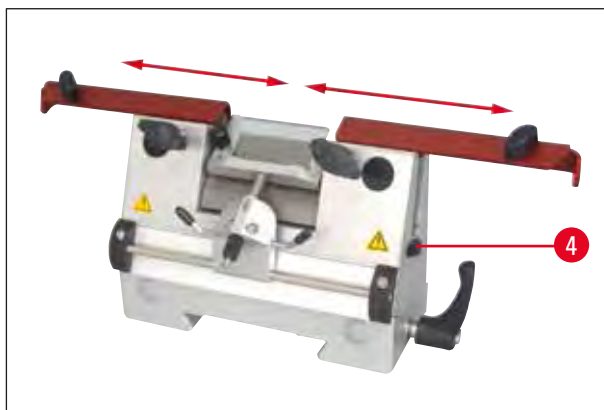

Fig. 65

- Pressure plate permits the full length of the knife to be utilized.
- Use hard metal and steel knives here.



Note

The height of resharpened knives must be adjusted using knurled screws (→ Fig. 65-4) (approx. 1 mm under the edge of the clamping jaw).

Ensure that the knife is adjusted in parallel vertically.

11 Optional Accessories



Warning

The safety gloves included in the standard scope of delivery must be worn when inserting/ejecting the knife!

After removing the knife from the knife holder, place it safely into the knife case. **NEVER** place it onto the work surface next to the instrument!



Fig. 66

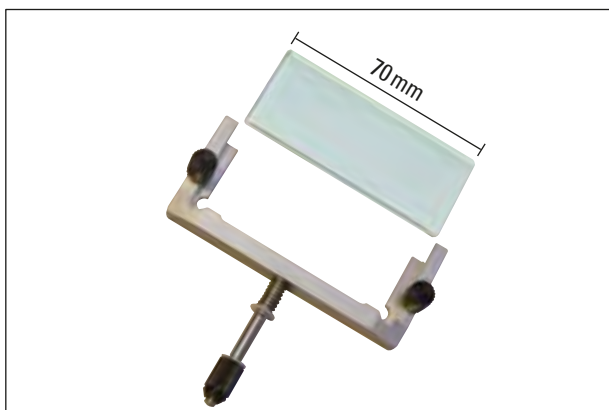

Fig. 67

Anti-roll guide system

Anti-roll plate (with glass stage plate)

Available with various spacers:

- 70 mm - 50 μm , for section thickness: $< 4 \mu\text{m}$
- 70 mm - 100 μm , for section thickness: 5 μm - 50 μm
- 70 mm - 150 μm , for section thickness: $> 50 \mu\text{m}$



Note

The 50 μm and 100 μm anti-roll plates are included in the standard scope of delivery of the blade holder CE.

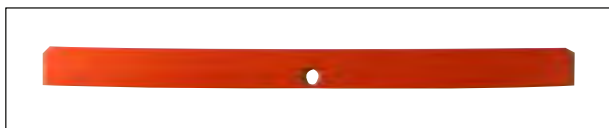

Fig. 68

Straightedge (blade rest)

Insert for low-profile blades for blade holder CE (14 0477 43005) replacement



Note

The blade rest is also included in the standard scope of delivery of the blade holder CE.

When using low-profile blades, the blade rest (→ Fig. 51-11) must be inserted into the blade holder CE first, then the low-profile blade.



Fig. 69

HEPA filter

HEPA filter 350/5865, pack of 1.
Recommendation: HEPA filters should be replaced every 3 months.

(Write the installation date on the filter)

Order no. 14 0477 40296



Warning

Filter bags and HEPA filter must be disposed of according to applicable laboratory regulations for infectious material. Filters must be replaced, not cleaned.



Fig. 70

Replacement filter for extraction system

Pack of 25, with coarse filter insert (→ Fig. 70-1)
14 0477 44307

11 Optional Accessories

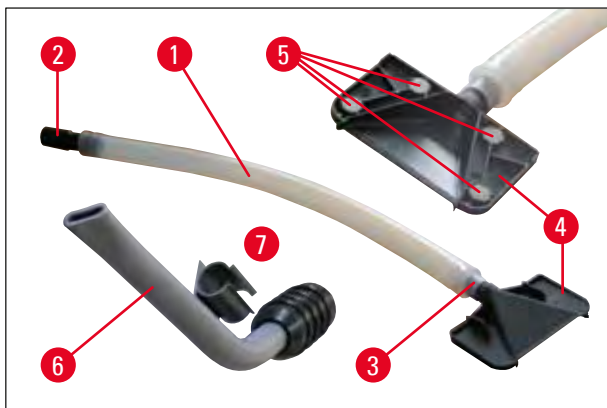

Fig. 71

Vacuum extraction system

- 1 Hose
- 2 Hose adapter, black (for filter bag in instrument)
- 3 Hose adapter, white (for suction nozzle (→ Fig. 71-4) or extraction nozzle (→ Fig. 71-6))
- 4 Suction nozzle – with 4 magnets (→ Fig. 71-5) on knife holder
- 7 Plastic clip (for parking the extraction nozzle)



Fig. 72

Storage system, assembly ("hidden")

- Storage system for installation in the rear part of the cryostat for cooled storage of specimen discs and cutting accessories (For assembly, refer to (→ p. 36 – 6.5.2 Installing the storage systems (optional)))

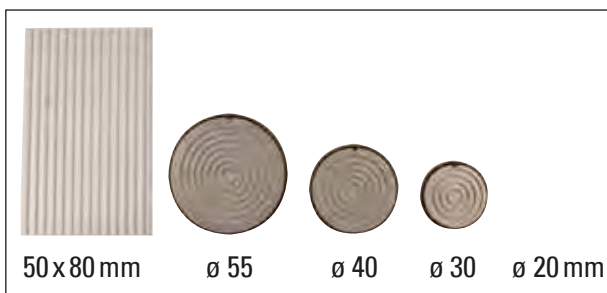

Fig. 73

- Specimen discs in various dimensions



Note

The specimen disc 50x80 mm is suitable only for section thicknesses up to approx. 5 µm (due to the large specimen size).



Fig. 74

O-rings in various colors

- for plate Ø 20 mm (red or blue), 10x each
- for plate Ø 30 mm (red or blue), 10x each
- for plate Ø 40 mm (red or blue), 10x each
- for plate Ø 55 mm (red or blue), 10x each for labeling specimen discs using color



Fig. 75

A Heat extractor with parking station, stationary

- Heat extractor for installation in the cryostats. Consisting of: suspension, heat extractor and parking station.

B Heat and cold extractor

- Dual use: For extracting cold from warm storage location; for extracting heat from cold storage location.

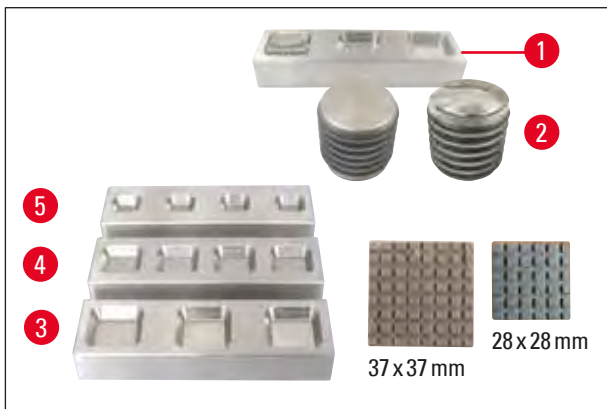

Fig. 76

- The specimen discs of the **DR. PETERS CRYOEMBEDDING SYSTEM** (→ Fig. 76-1) can be conveniently removed from the shelf using the underside of the heat extractor (removal aid (→ Fig. 76-2)). Slide the underside over the specimen disc in the direction of the arrow so that the disc remains in the slot and can be removed from the rack.

3 Large shelf with 3 recesses L x W x H:
30 x 30 x 7 mm

4 Medium shelf with 4 recesses L x W x H:
24 x 24 x 6 mm

5 Small shelf with 4 recesses L x W x H:
18 x 18 x 6 mm



Fig. 77

Footswitch,

for use with motorized instruments only.

The foot switch can be used to control the motorized sectioning process. It also has a function that is similar to the emergency stop function.



Warning

Caution!

All control panel functions and all buttons on the instrument remain active along with the foot switch.

- Using the **CUT MODE** button (→ Fig. 33-1), select the desired operating mode **CONT** or **SINGLE** on the control panel.



CONT (continuous stroke) operating mode

- Press the foot switch once briefly to start motorized sectioning.



Note

If the foot switch remains pressed for longer than half a second, the specimen stops in the next upper end position.

- Press the foot switch again to stop it.
The specimen then stops in the end position.



SINGLE (single stroke) operating mode

- Press the foot switch once briefly to start motorized sectioning. After each section, the specimen stops automatically in the end position.

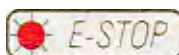

How to activate the emergency stop function

- Press the foot switch strongly to activate the emergency stop function. Sectioning stops immediately.
The red LED (→ Fig. 33-4) in the **E-STOP** field on the instrument is lit up as long as the foot switch remains depressed.
- To resume the sectioning process, select the sectioning type (**CONT** or **SINGLE**) and restart the system using the foot switch.

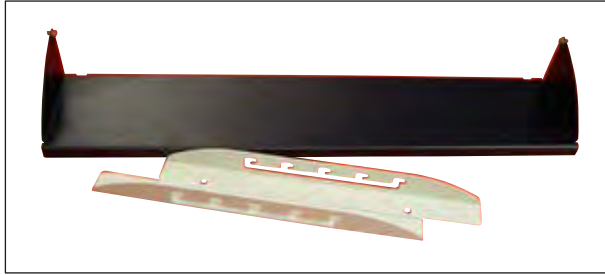

Fig. 78

Footrest,

individually height-adjustable footrest with 5 adjustment options.



Fig. 79

Brush shelf,

for use with blade holder CE

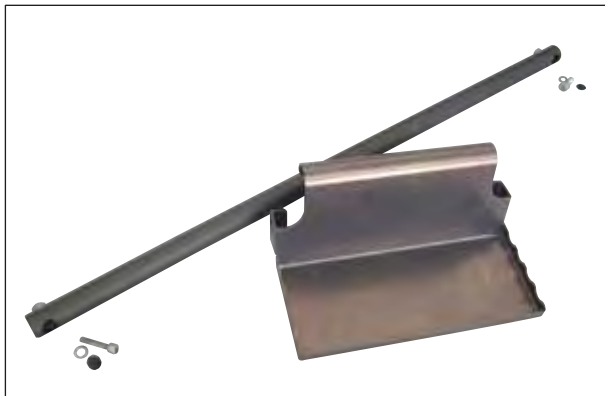

Fig. 80

Storage system, movable

for installation in the front part of the cryostat for cooled storage of preparation aids

12 Maintenance and Cleaning

12. Maintenance and Cleaning

12.1 General maintenance instructions

The microtome is virtually maintenance-free. To ensure a smooth operation of the instrument over several years we recommend the following:

- At least **ONCE** a year, have the instrument inspected by a qualified service engineer authorized by Leica.
- Enter into a service contract at the end of the warranty period. For more information, please contact your local Leica technical service center.
- Clean the instrument daily.



Warning

If completely defrosted, HEPA filters and filter bags **MUST** be removed. The HEPA filter absorbs the moisture during defrosting and thus becomes unusable!

- Every day, remove frozen section waste from the cryostat using a cold brush or use the (optional) extraction device.
- Remove the section waste tray for emptying.
- Remove the storage shelves and the brush shelf for cleaning.
- Remove the closed sliding window from the front by gently lifting it (→ p. 85 – 12.3 Replacing the UVC lamp)).



Note

Do not use organic solvents or any other aggressive substances for cleaning and disinfecting! Use disinfectants common alcohol-based disinfectants.

- Drain the cleaning liquid through the hose after the recommended exposure time is over and collect it in the waste container (→ Fig. 81-1).

Emptying the condensate bottle



Fig. 81

Check the fill level of the condensate bottle (→ Fig. 81-1) visible in the front panel of the instrument at regular intervals.

- The bottle collects the condensate that accumulates during defrosting.



Note

Dispose of the contents of the bottle in accordance with laboratory regulations.

Basically, we recommend UVC disinfection (for application, see (→ p. 47 – Disinfection)).

The cryostat has to be disinfected after each daily use.



Note

- Comply with the instructions for use!
The glass anti-roll plate can remain in place during disinfection.
- It is not necessary to oil parts, such as the T-piece on the microtome base plate, clamping lever etc.

In case of visible pollution (such as dust), clean the air inlet opening (→ p. 28 – Fig. 8) of the condenser on the bottom right-hand side of the instrument using a brush, broom or extraction cleaner in the direction of the louvers.



Warning

- Be exceptionally careful when cleaning the louvers as they have sharp edges and can cause cutting injuries if cleaned improperly.
- Do not turn the instrument on before the cryochamber is completely dry! Frost formation!
- The front panel and the slit cover of the microtome must be completely dry before turning on the instrument!
- All parts that have been removed from the cold cryostat must be dried thoroughly before they are put back into the chamber.

12.2 Changing fuses

- In case of power supply faults, please contact an authorized Leica service technician immediately.



Warning

Do not carry out any repairs on your own as this will invalidate the warranty.
Repairs may only be carried out by qualified service engineers authorized by Leica.

12.3 Replacing the UVC lamp



Warning

Turn the instrument off and disconnect the power plug before replacing the UVC lamp.
If the lamp is broken, it must be replaced by the technical service, as the replacement involves a high risk of injury. Beware of the metallic mercury in the UVC lamp; handle it carefully and dispose of it properly.

A UVC lamp has an estimated service life of approx. 9,000 hours.

Each on/off switching cycle reduces the lamp life by approx. one hour plus burning time (30 minutes or 180 minutes respectively).

12 Maintenance and Cleaning



Note



When both LEDs (short and long-term disinfection) are blinking alternately in control panel 1, the UVC lamp must be replaced.

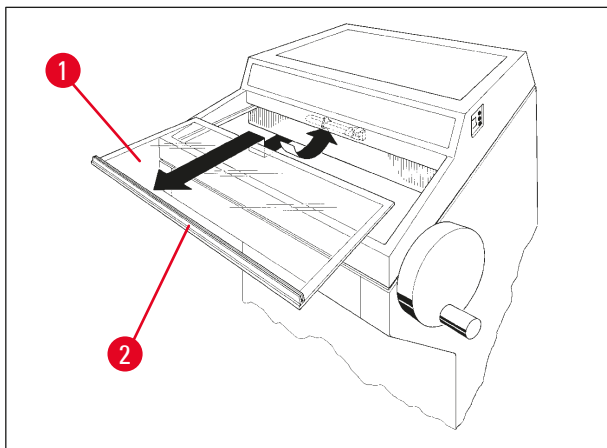

Fig. 82

- Switch off the instrument at the circuit breaker.
- Disconnect the power plug.
- Slightly lift the sliding window (→ Fig. 82-1) using the grip (→ Fig. 82-2) and pull it out to the front.



Note

For the Leica CM1950, two different variants of the connection piece inside the instrument and the UVC-Lamp are available. You need to check which variant is built-in in the instrument prior to the exchange of the UVC lamp with a new one.

The procedure to exchange the UVC lamp is similar with both variants.

Identifying the built-in variant and matching UVC lamp

Variant 1: Connection piece with 2-pin inlet (→ Fig. 83-1), UVC lamp 2-pin (→ Fig. 83-2).

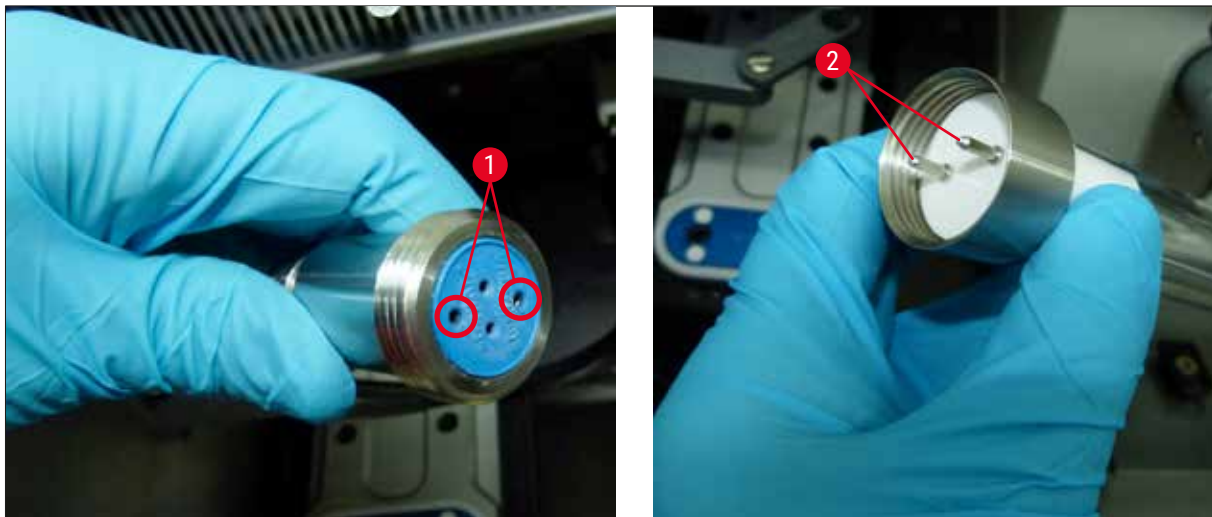

Fig. 83

Variant 2: Connection piece with 4-pin inlet (→ Fig. 84-1), UVC lamp 4-pin (→ Fig. 84-2).

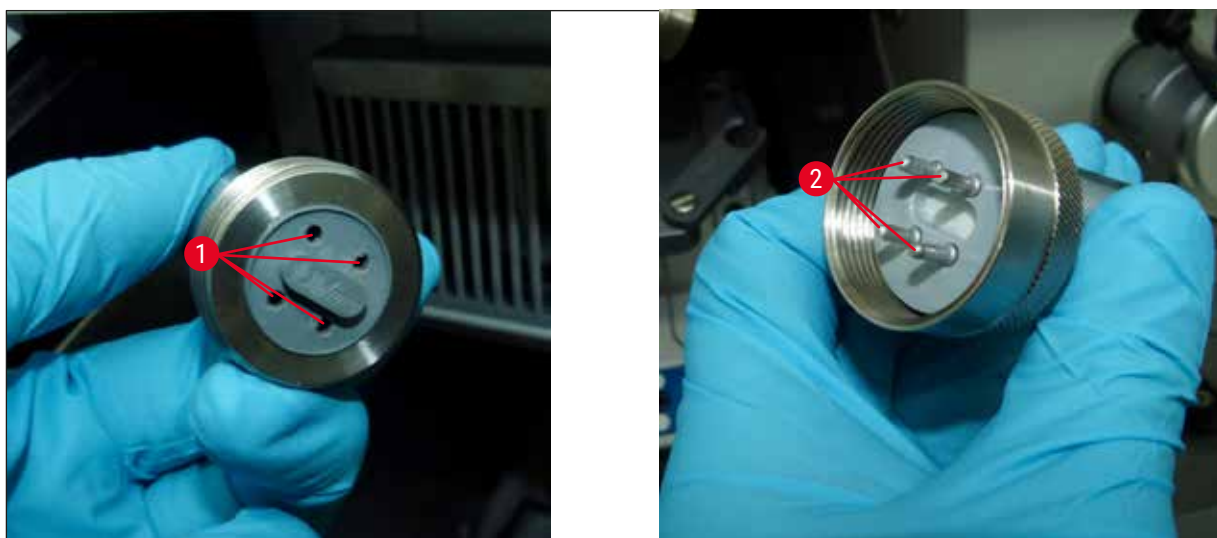

Fig. 84

Removal of the lamp

The UVC lamp (→ Fig. 85-3) is installed in front of the protection screen for chamber illumination (→ Fig. 85-4).

12 Maintenance and Cleaning



Fig. 85

- Hold the lamp with both hands and carefully pull it out of the clips (→ Fig. 85-5) with a slight forward movement.
- Detach the metal ring (→ Fig. 86-7) on the holder (→ Fig. 86-6) in the direction of the arrow (→ Fig. 86-8) and carefully pull the lamp out of the holder with your right hand.



Fig. 86

Installation of the new lamp

- Carefully slide the metal ring (→ Fig. 86-7) over the lamp from the left (→ p. 86 – Identifying the built-in variant and matching UVC lamp).
- Push the lamp into the holder on the left side until it engages.
- Screw the metal ring onto the holder, then hold the lamp with both hands and carefully push it into the clips (→ Fig. 85-5).
- Replace the sliding window.
- Connect the instrument to the power supply again and switch it on.



Fig. 87



Note

If the UVC button is depressed for more than 30 seconds, the running-time meter for the UVC lamp is reset. This is required every time the UVC lamp is replaced to ensure sufficient power for disinfection!



Warning

Dispose of the UVC lamp separately!

UVC lamp ordering information



Fig. 88

UVC fluorescent tube - 2-pin

Order No.: 14 0477 43192



12.4 Replacement of LED illumination

The LED illumination is designed for maximum life span. In case of damage, please contact Leica customer service to arrange replacement. For further details, see ([→ p. 92 – 14. Warranty and service](#)).

13. Decontamination Confirmation

Every product that is returned to Leica Biosystems or that requires on-site maintenance must be properly cleaned and decontaminated. You can find the dedicated template of the decontamination confirmation on our website www.LeicaBiosystems.com within the product menu. This template has to be used for gathering all required data.

When returning a product, a copy of the filled and signed confirmation has to be enclosed or passed on to the service technician. The responsibility for products that are sent back without this confirmation or with an incomplete confirmation lies with the sender. Returned goods that are considered to be a potential source of danger by the company will be sent back at the expense and risk of the sender.

14. Warranty and service

Warranty

Leica Biosystems Nussloch GmbH guarantees that the contractual product delivered has been subjected to a comprehensive quality control procedure based on the Leica in-house testing standards, and that the product is faultless and complies with all technical specifications and/or agreed characteristics warranted.

The scope of the warranty is based on the content of the concluded agreement. The warranty terms of your Leica sales organization or the organization from which you have purchased the contractual product shall apply exclusively.

Service information

If you are in need of technical customer support or spare parts, please contact your Leica representative or the Leica dealer where you purchased the instrument.

Please provide the following information:

- Model name and serial number of the instrument
- Location of the instrument and name of the person to contact
- Reason for the service call
- Delivery date

Yearly Preventive Maintenance

Leica recommends to conduct a yearly preventive maintenance. This has to be performed by a qualified Leica Service Representative.

Shutdown and disposal of the instrument

The instrument or parts of the instrument must be disposed of according to existing applicable, local regulations. Dispose of the UVC lamp separately and in accordance with the local applicable disposal regulations.

www.LeicaBiosystems.com



Leica Biosystems Nussloch GmbH
Heidelberger Strasse 17 - 19
69226 Nussloch
Germany

Tel.: +49 - (0) 6224 - 143 0
Fax: +49 - (0) 6224 - 143 268
Web: www.LeicaBiosystems.com