

HistoCore Arcadia H

Paraffin Embedding Station

Instructions for Use
English

Order No.: 14 0393 81101 - Revision 0

Always keep this Instructions for Use with the instrument.
Read carefully before working with the instrument.

CE



The information, numerical data, notes and value judgments contained in this Instructions for Use represent the current state of scientific knowledge and state-of-the-art technology as we understand it following thorough investigation in this field.

We are under no obligation to update the present Instructions for Use periodically and on an ongoing basis according to the latest technical developments, nor to provide our customers with additional copies, updates etc. of this Instructions for Use.

To the extent permitted in accordance with the national legal system as applicable in each individual case, we shall not be held liable for erroneous statements, drawings, technical illustrations etc. contained in this Instructions for Use. In particular, no liability whatsoever is accepted for any financial loss or consequential damage caused by or related to compliance with statements or other information in this Instructions for Use.

Statements, drawings, illustrations and other information regarding the contents or technical details of the present Instructions for Use are not to be considered warranted characteristics of our products.

These are determined only by the contract provisions agreed between ourselves and our customers.

Leica Biosystems reserves the right to change technical specifications as well as manufacturing processes without prior notice. Only in this way is it possible to continuously improve the technology and manufacturing techniques used in our products.

This document is protected under copyright laws. All copyrights to this documentation are held by Leica Biosystems Nussloch GmbH.

Any reproduction of text and illustrations (or of any parts thereof) by means of print, photocopy, microfiche, web cam or other methods – including any electronic systems and media – requires express prior permission in writing by Leica Biosystems Nussloch GmbH.

For the instrument serial number and year of manufacture, please refer to the nameplate on the back of the instrument.



Leica Biosystems Nussloch GmbH

Heidelberger Strasse 17 - 19

D-69226 Nussloch

Germany

Tel.: +49 - (0) 6224 - 143 0

Fax: +49 - (0) 6224 - 143 268

Web: www.LeicaBiosystems.com

Assembly contracted to Leica Microsystems Ltd. Shanghai

Table of contents

1.	Important Information	6
1.1	Naming conventions	6
1.2	Symbols in the text and their meanings.....	6
1.3	Instrument type	10
1.4	Intended use of instrument.....	10
1.5	Qualification of personnel.....	10
2.	Safety	11
2.1	Safety Notes	11
2.2	Warnings.....	12
2.3	Integrated safety devices.....	13
3.	Instrument Components and Specifications.....	14
3.1	Overview – Instrument components	14
3.2	Main features of the instrument.....	15
3.3	Technical Data	16
4.	Setting up the instrument	17
4.1	Site requirement	17
4.2	Standard delivery – packing list.....	17
4.3	Unpacking and installation.....	18
4.4	Necessary assembly work.....	19
4.5	Electrical connection	21
4.6	Moving the instrument.....	21
5.	Operation.....	22
5.1	Instrument parts/functions.....	22
5.2	Switching the instrument on.....	27
5.3	Control panel functions.....	28
5.4	Operation modes.....	32
5.5	Instrument heater	33
6.	Maintenance and Cleaning.....	34
6.1	Cleaning the instrument.....	34
6.2	Maintenance instructions.....	35
7.	Troubleshooting	36
7.1	Error message	36
7.2	Possible faults	39
7.3	Changing a fuse	41
8.	Optional Accessories.....	42
8.1	Magnifier.....	42
8.2	Foot switch.....	42
8.3	Pre-filter cup.....	44
8.4	Basket handle.....	44
8.5	Ordering information	44

9. Warranty and Service 46

10. Decontamination Confirmation 47

1 Important Information

1. Important Information

1.1 Naming conventions



Note

The full name of the device is HistoCore Arcadia H Paraffin Embedding Station. The device is called HistoCore Arcadia H to ensure that the Instructions for Use are well legible.

1.2 Symbols in the text and their meanings

Symbol:



Title of the symbol:

Warning

Description:

Warnings appear in a white box and are marked by a warning triangle.

Symbol:



Title of the symbol:

Note

Description:

Notes, i. e. important user information, appear in a white box and are marked by an information symbol.

Symbol:

→ "Fig. 7-1"

Title of the symbol:

Item number

Description:

Item numbers for numbering illustrations. Numbers in red refer to item numbers in illustrations.

Symbol:

Save

Title of the symbol:

Function key

Description:

Function keys, that have to be pressed on the display screen displayed as bold, gray text.

Symbol:



Title of the symbol:

Warning, hot surface

Description:

Instrument surfaces which become hot during operation are marked with this symbol. Avoid direct contact to prevent risk of burning.

Symbol:



Title of the symbol:

Flammable

Description:

Flammable reagents, solvents and cleaning agents are labeled with this symbol.

Symbol:



Title of the symbol:

Caution

Description:

Indicates the need for the user to consult the Instructions for Use for important cautionary information such as warnings and precautions that cannot, for a variety of reasons, be presented on the medical device itself.

Symbol:













Title of the symbol:

ON (Power)

Description:

The power supply is connected upon pushing the power switch.

Symbol: 	Title of the symbol: Description:	OFF (Power) The power supply is disconnected upon pushing the power switch.
Symbol: 	Title of the symbol: Description:	Consult Instructions for Use Indicates the need for the user to consult the Instructions for Use.
Symbol: 	Title of the symbol: Description:	Manufacturer Indicates the manufacturer of the medical product.
Symbol: 	Title of the symbol: Description:	Manufacturing date Indicates the date when the medical device was manufactured.
Symbol: 	Title of the symbol:	Alternating current
Symbol: 	Title of the symbol:	PE terminal
Symbol: 	Title of the symbol: Description:	Article number Indicates the manufacturer's catalog number so that the medical device can be identified.
Symbol: 	Title of the symbol: Description:	Serial number Indicates the manufacturer's serial number so that a specific medical device can be identified.
Symbol: 	Title of the symbol: Description:	China ROHS Environmental protection symbol of the China RoHS directive. The number in the symbol indicates the "Environment-friendly Use Period" of the product in years. The symbol is used if a substance restricted in China is used in excess of the maximum permitted limit.
Symbol: 	Title of the symbol: Description:	WEEE Symbol The WEEE symbol, indicating separate collection for WEEE – Waste of electrical and electronic equipment, consists of the crossed-out wheeled bin (§ 7 ElektroG).
Symbol: 	Title of the symbol: Description:	CE Compliance The CE marking is the manufacturer's declaration that the medical product meets the requirements of the applicable EC directives.

1 Important Information

Symbol:



Title of the symbol:

CSA Statement (Canada/USA)

Description:

This product fulfills the requirements of the CAN/CSA-C22.2 No. 61010.

Symbol:



Title of the symbol:

Fragile, handle with care

Description:

Indicates a medical device that can be broken or damaged if not handled carefully.

Symbol:



Title of the symbol:

Store dry

Description:

Indicates a medical device that needs to be protected from moisture.

Symbol:

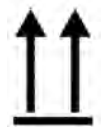

Title of the symbol:

This way up

Description:

Indicates correct upright position of the transport package.

Symbol:



Title of the symbol:

Stack limit

Description:

It allows maximum 2 stacks layers.

Symbol:

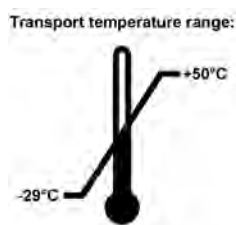

Title of the symbol:

Temperature limit for transport

Description:

Indicates the temperature limits for transport to which the medical device can be safely exposed.

Symbol:

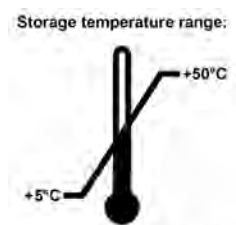

Title of the symbol:

Temperature limit for storage

Description:

Indicates the temperature limits for storage to which the medical device can be safely exposed.

Symbol:

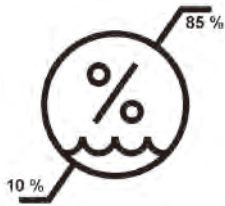

Title of the symbol:

Humidity limitation for transport and storage

Description:

Indicates the range of humidity for transport and storage to which the medical device can be safely exposed.

Symbol:



Title of the symbol:

Shockdot Impact Indicator

Description:

In the Shockwatch system, a shock dot shows shocks or impacts that are above a specified intensity through red coloration. Exceeding a defined acceleration (g value) causes the indicator tube to change color.

Symbol:



Title of the symbol:

Recycling

Description:

Indicates, that the item can be recycled where correct facilities exist.

Symbol:



Title of the symbol:

Regulatory Compliance Mark (RCM)

Description:

The Regulatory Compliance Mark (RCM) indicates a device's compliance with applicable ACMA technical standards of New Zealand and Australia – that is, for telecommunications, radio communications, EMC and EME.

1.3 Instrument type

All information provided in these Instructions for Use applies only to the instrument type indicated on the cover page. A nameplate is attached to the back of the instrument and a serial number label is on the side of the instrument.

1.4 Intended use of instrument

The HistoCore Arcadia H is a modern paraffin embedding station with a microprocessor control system.

The HistoCore Arcadia H is designed for embedding histological tissue specimens in molten paraffin for use in pathology laboratories.

It is only for the following tasks:

- Melt solid paraffin for sample embedding and maintain the molten paraffin at the required temperature.
- Dispense paraffin into embedding molds where the specimens are placed.
- Heat and maintain the temperatures of embedding cassettes with specimens and molds as well as the required forceps.



Warning

Any other use of the instrument will be considered as improper use!

1.5 Qualification of personnel

- The HistoCore Arcadia H may be operated by trained laboratory personnel only. The instrument is intended for professional use only.
- All laboratory personnel designated to operate this instrument must read these Instructions for Use carefully and must be familiar with all technical features of the instrument before attempting to operate it.

2. Safety

2.1 Safety Notes



Warning

The safety and caution notes in this chapter must be observed at all times. Be sure to read these notes even if you are already familiar with the operation and use of other Leica Biosystems products.

These Instructions for Use include important instructions and information related to the operating safety and maintenance of the instrument.

The Instructions for Use are an important part of the product, and must be read carefully prior to startup and use and must always be kept near the instrument.

This instrument has been built and tested in accordance with the safety requirements for electrical equipment for measurement, control, and laboratory use.

To maintain this condition and ensure safe operation, the user must observe all notes and warnings contained in these Instructions for Use.



Note

These Instructions for Use must be appropriately supplemented as required by the existing regulations on accident prevention and environmental safety in the operator's country.



Warning

- The protective devices on the instrument and its accessories must not be removed or modified. Only service personnel qualified by Leica Biosystems may repair the instrument and access the instrument's internal components.
- Only use the provided power cable. This power cable must be replaced if the power plug does not fit your country's socket. Please contact Leica Biosystems Service.
- The maximum load of the paraffin tank lid is 1 kg. Do not exceed 1 kg, otherwise damage could occur to the paraffin tank lid.

Residual risks

- The instrument has been designed and constructed with the latest state-of-the-art technology and according to recognized standards and regulations with regard to safety technology. Operating or handling the instrument incorrectly can place the user or other personnel at risk of injury or can cause damage to the instrument or other property. The instrument may be used only as intended and only if all of its safety features are in proper working condition. Malfunctions that impede safety must be remedied immediately.



Note

For current information about applicable guidelines, please refer to the CE declaration of conformity and on our Internet site at:

<http://www.LeicaBiosystems.com>

2.2 Warnings

The safety devices installed in this instrument by the manufacturer only constitute the basis for accident prevention. Operating the instrument safely is, above all, the responsibility of the owner, as well as the designated personnel who operate, service or repair the instrument.

To ensure trouble-free operation of the instrument, make sure to comply with the following instructions and warnings.

Warnings – Safety notes on the instrument itself



Warning

- Safety notes on the instrument itself, which are marked with a warning triangle, indicate that the correct operating instructions (as defined in these Instructions for Use) must be followed when operating or replacing the item marked. Nonobservance can cause accidents, injuries and/or damage to the instrument/accessories.



- Certain surfaces of the instrument are hot during operation under normal conditions. They are marked with this warning sign. Touching these surfaces without suitable safety measures can cause burns.

Safety instructions – Transport and installation



Warning

- After unpacking the instrument it may only be transported in an upright position.
- Place the instrument on a laboratory table and ensure it is level.
- The instrument must not be exposed to direct sunlight (window)!
- Only plug the instrument into a grounded power socket. If an extension cable has to be used, make sure that it has a protective grounding conductor.
- Connect the instrument with the right power socket voltage 100~120V or 220~240V according to the instrument type.
- The installation location must be well-ventilated; there should be no ignition sources there of any kind.
- The instrument may not be operated in hazardous locations.
- Extreme temperature fluctuations between storage facility and setup site as well as high humidity may cause condensation to form. In this case, wait at least two hours before switching on.

Safety instructions – Working with the instrument**Warning**

- Paraffin is flammable and should therefore be handled with due care.
- Do not use sharp tools to remove solidified paraffin from the work areas, as this may destroy the coating on the surface. Use the plastic spatula supplied with the instrument.
- During operation, the paraffin tank, embedding mold tray, cassette tray, work area as well as the forceps holder are hot.
- Risk of burning!
- Do not move the instrument during operation.
- Do not store any combustible and flammable substances near the instrument. There is a fire hazard if work with an exposed flame (e.g. Bunsen burner) is carried out in the direct vicinity of the instrument (solvent vapors). Therefore, keep all ignition sources at least 2 meters away from the instrument!
- Please allow 30 minutes before touching the instrument after shutting down.
- Failure to observe the instructions specified by the manufacturer may result in damage to the protection provided by the instrument.

Hazards – Servicing and cleaning**Warning**

- Switch off the instrument each time before servicing and pull out the power plug.
- When using cleaners, please comply with the safety instructions of the manufacturer and the laboratory safety regulations.
- Before changing defective fuses, the instrument has to be disconnected from the power supply. Fuses in the fuse holder on the back panel can be replaced by the user.
- Liquid must not get into the instrument while operating or cleaning it.

2.3 Integrated safety devices

The instrument is equipped with the following safety features and devices:

Fuses in the heating elements

All of the instrument's AC heating elements are equipped with overheating fuses, which trip if an AC heating element overheats and switches the element off.

**Warning**

- Fuses will only automatically reset when the instrument is disconnected from AC power and the heating element temperature drops below 50 °C.
- Note the only way the user can disconnect the instrument from a power source is to remove the power plug.

3 Instrument Components and Specifications

3. Instrument Components and Specifications

3.1 Overview – Instrument components

Instrument front view



Fig. 1

- | | | | |
|---|-------------------|----|---------------------------|
| 1 | Power switch | 8 | Cold spot |
| 2 | Control panel | 9 | Paraffin collection trays |
| 3 | Dispenser | 10 | Lid for right tray |
| 4 | Forceps holder | 11 | Right tray |
| 5 | Left tray | 12 | Work area illumination |
| 6 | Lid for left tray | 13 | Paraffin tank |
| 7 | Working surface | | |

Instrument rear view

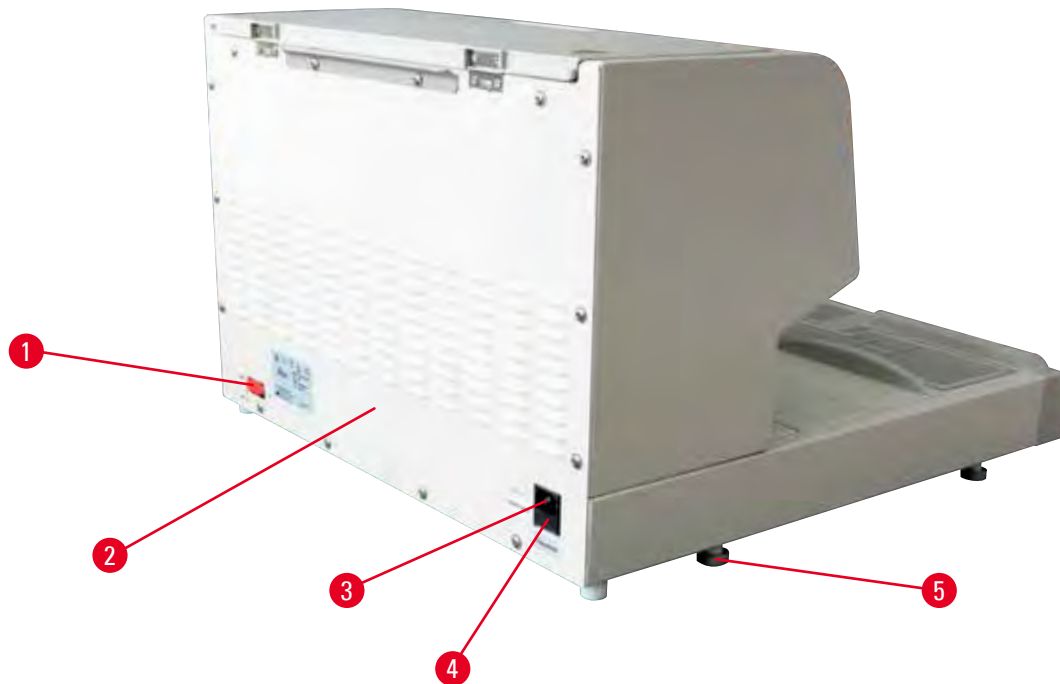

Fig. 2

1	Port for foot switch	4	AC fuses
2	Back panel	5	Foot
3	Port for power inlet		

3.2 Main features of the instrument

- Paraffin tank with a capacity of 4 litres.
- 5.7 inch LCD display and integrated capacitive touch keys.
- The paraffin flow is activated by means of a height-adjustable, pivotable clip – activated either manually by pushing or via a foot switch (optional).
- Controllable flow rate.
- Removable paraffin collection trays.
- Spacious, easy-to-clean, heated work area, with integrated cold spot, also for extra large cassettes ("Super Cassettes") with paraffin drain system.
- Trays for cassettes and/or molds with foldable lid, removable and interchangeable.
- Removable, heated forceps holder for 6 forceps, accessible from both sides.
- Optimum illumination of the working surface by LED lamp, controlled by the key on LCD control panel.
- Temperature range of cassette and embedding mold tray, work area and paraffin tank adjustable from 50 °C (122 °F) to 75 °C (167 °F).
- The beginning and end of the work time and work days can be programmed.
- Provide the error message for operation condition monitoring.
- Provide the enhance heating function for quicker paraffin melting.

3.3 Technical Data

General data

Voltage of power supply	100-120 VAC, 220-240 VAC, 50/60 Hz
Nominal current	10 A max.
Protection class ¹⁾	I
Pollution degree ¹⁾	2
Over-voltage category	II
Operating temperatures	50 °C (122 °F) to 75 °C (167 °F), adjustable in 1 °C (or 1 °F) increments
IP protection class	IP20
IP protection class (Foot switch)	IPX8

Operating environment

Environmental operating temperature	+20 °C to +30 °C
Environmental operating relative humidity	20 % to 80 % non-condensing
Environmental operating altitude	Up to 2000 m

Transport and storage environment

Transport temperature	-29 °C to +50 °C
Storage temperature	+5 °C to +50 °C
Transport and storage relative humidity	10 % to 85 % non-condensing

Electromagnetic environment

Basic electromagnetic environment

Fuses

Time-lag fuses 5 x 20 mm	2 x T10A, 250 V
--------------------------	-----------------

Dimensions and weights

Height	384 mm
Width	560 mm
Depth	636 mm
Weight	27 kg

Capacities

Paraffin tank	Max. 4 L
Removable trays	<ul style="list-style-type: none"> • Cassette tray: max. 150 standard-sized histology cassettes (40 x 27 mm) • Embedding mold tray: max. 500 embedding molds

Programmable parameters

Temperature	<ul style="list-style-type: none"> • Paraffin tank/dispenser • Embedding mold tray/cassette tray • Work surface/forceps holder
Time	<ul style="list-style-type: none"> • Working day, current weekday • Working times (start, end), current time

¹⁾ according to IEC-61010, EN 61010

4. Setting up the instrument

4.1 Site requirement

- Stable, vibration-free laboratory table with horizontal, flat table top, as far as possible vibration-free ground.
- The instrument must not be placed in the vicinity of the air outlet of an air conditioner and must be shielded from strong sunlight (window).
- To ensure a fully functional heat sink, there must be gap of at least 15 cm behind the instrument.
- The instrument must be installed in a place that ensures an easy disconnection from the power supply. The power cable must be in a place that can be easily reached.
- The vicinity of the work area must be free of oil and chemical vapors.



Warning

The installation location must be well-ventilated and free of ignition sources of any kind. The instrument should not be operated in hazardous locations.

4.2 Standard delivery – packing list

Qty.	Designation	Order No.
1	Basic unit HistoCore Arcadia H,	
	220-240 VAC	14 0393 57257
	220-240 VAC, China	14 0393 57259
	100-120 VAC	14 0393 57258
2	Left/right trays, removable	14 0393 57311
2	Lids for left/right trays	14 0393 57665
1	Paraffin scraper	14 0393 53643
1	Forceps holder, removable	14 0393 55225
1	Paraffin tank filter	14 0393 53559
4	Sets of spare fuses, 250 V 10 A	14 6000 04975
1	Instructions for Use (printed English, with language CD 14 0393 81200)	14 0393 81001

The country specific power cord needs to be ordered separately. Please find a list of all power cords available for your device on our website www.LeicaBiosystems.com within the product section.



Note

Please compare the delivered components against the packing list, delivery note, and your order. Should there be any discrepancy, please contact the Leica Biosystems distributor handling your order.

4 Setting up the instrument

4.3 Unpacking and installation



Note

The packaging has the ShockDot Impact Indicator, that indicates improper transport. When the instrument is delivered, check this first. If the indicator is triggered, the package was not handled as prescribed. In this case, please mark the shipping documents accordingly and check the shipment for damage.



Warning

These unpacking instructions only apply if the box is placed with the symbols  facing upwards.



Fig. 3

1. Remove the packing strap (→ Fig. 3-1) and the adhesive tape (→ Fig. 3-2).
2. Open the package. Lift up and remove the carton wall (→ Fig. 3-3).



Fig. 4

3. Remove the accessory box (→ Fig. 4-4).
4. Remove the foam pads (→ Fig. 4-5) one by one.



Fig. 5

5. Ensure that when removing the instrument (→ Fig. 5-6) from the pallet this is carried out by two people lifting four lower corners of the housing base (→ Fig. 5).



Fig. 6

6. Place the instrument on a stable laboratory table.
7. Remove the accessories from the accessory box (→ Fig. 6-7) on the base of the pallet.

**Note**

The packaging must be retained for the duration of the warranty period. To return the instrument, follow the instructions above in reverse order.

4.4 Necessary assembly work

Install the following accessories and make the appropriate adjustments to make the instrument ready for use:

- Install accessories.
- Install magnifier (optional), (→ p. 42 – 8.1 Magnifier).
- Connect foot switch (optional), (→ p. 42 – 8.2 Foot switch).
- Connect to the power supply.
- Install the pre-filter cup (optional), (→ p. 44 – 8.3 Pre-filter cup).

4 Setting up the instrument

Installing the accessories

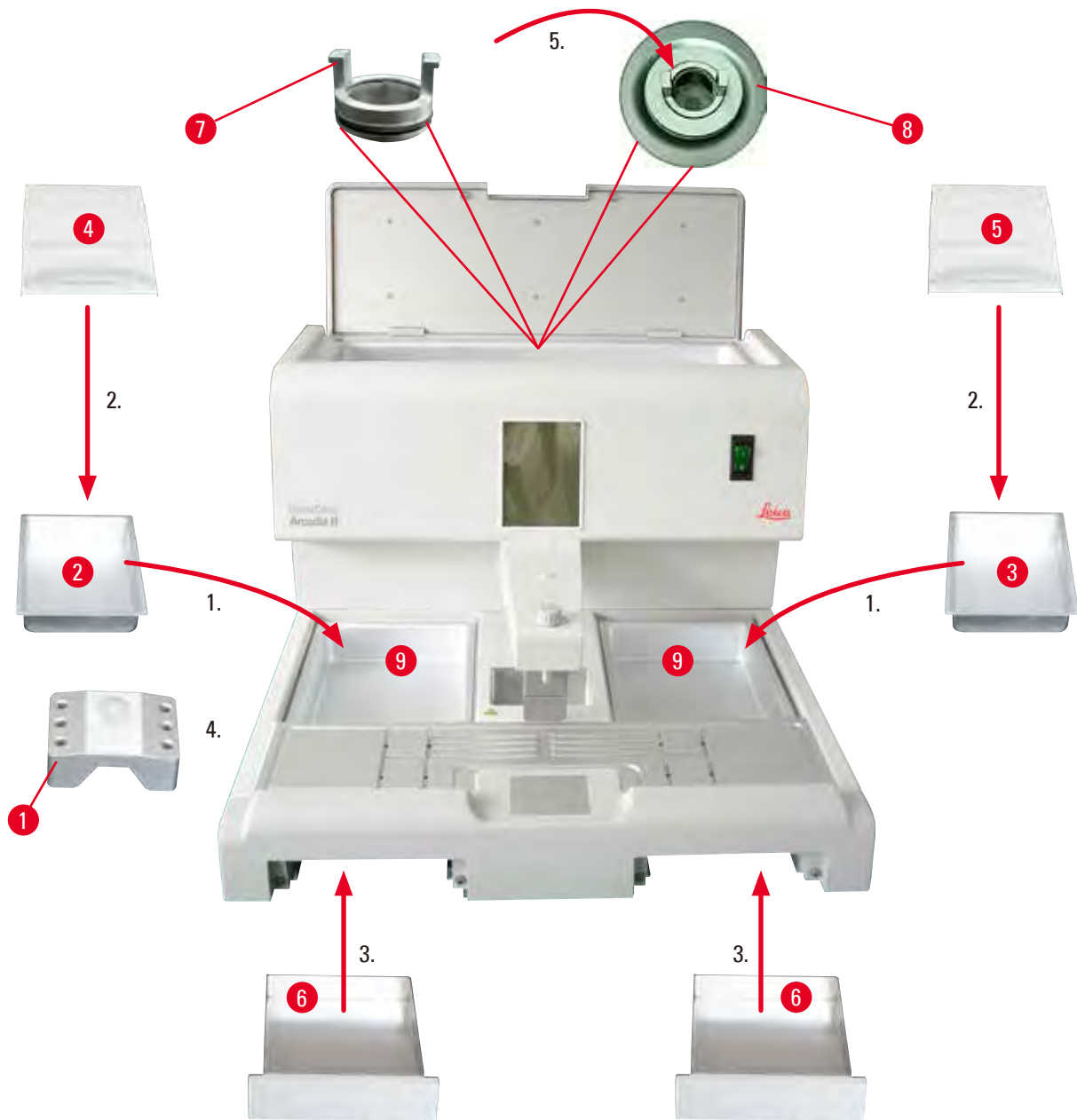

Fig. 7

1. Install left tray (→ Fig. 7-2) and right tray (→ Fig. 7-3). Depending on the preferred working direction, the two heated trays (→ Fig. 7-9) can be used for molds or cassettes as required.
2. Close left/right tray with the corresponding lids (→ Fig. 7-4), (→ Fig. 7-5).
3. Push the paraffin collection tray (→ Fig. 7-6) into the respective guide underneath the working surface.
4. Insert the forceps holder (→ Fig. 7-1).
5. Insert the paraffin filter (→ Fig. 7-7) in the paraffin outlet hole (→ Fig. 7-8) inside the paraffin tank so that the black O-ring seals the hole.

4.5 Electrical connection



Warning

The instrument **MUST** be connected to a grounded power socket and right AC voltage.

Connecting the power cord

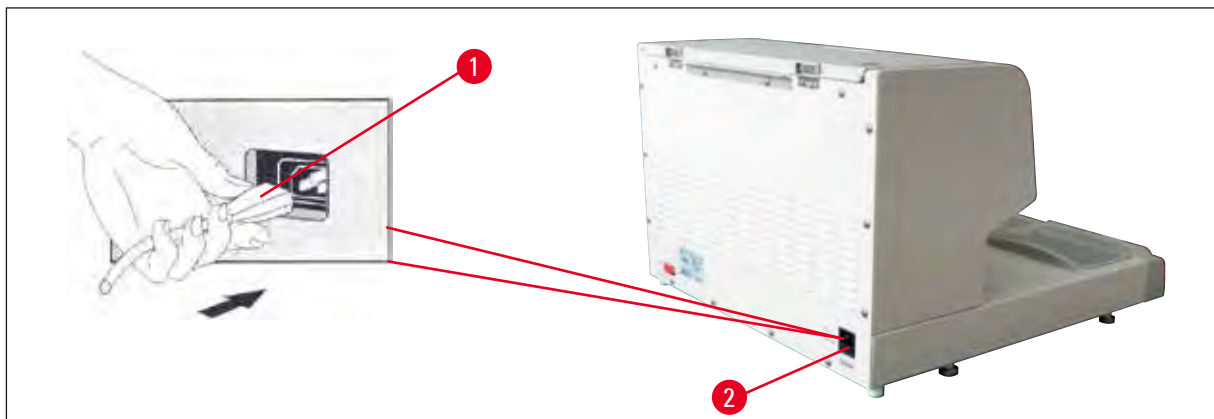

Fig. 8

- Connect the plug (→ Fig. 8-1) of the power cord to the connection socket (→ Fig. 8-2) on the rear of the instrument.
- Plug the power cord into the wall outlet.

4.6 Moving the instrument



Warning

- Do not move the instrument during operation.
- Before moving the instrument, make sure that no paraffin is in paraffin tank or two trays, the instrument is cooled down, and the power cord is disconnected from the power supply.
- Lifting the instrument by the dispenser (→ Fig. 9-2) or paraffin tank (→ Fig. 9-3) can cause serious damage.



Fig. 9

Hold the instrument at the front and rear part of the lower housing base and move.

5 Operation

5. Operation

5.1 Instrument parts/functions

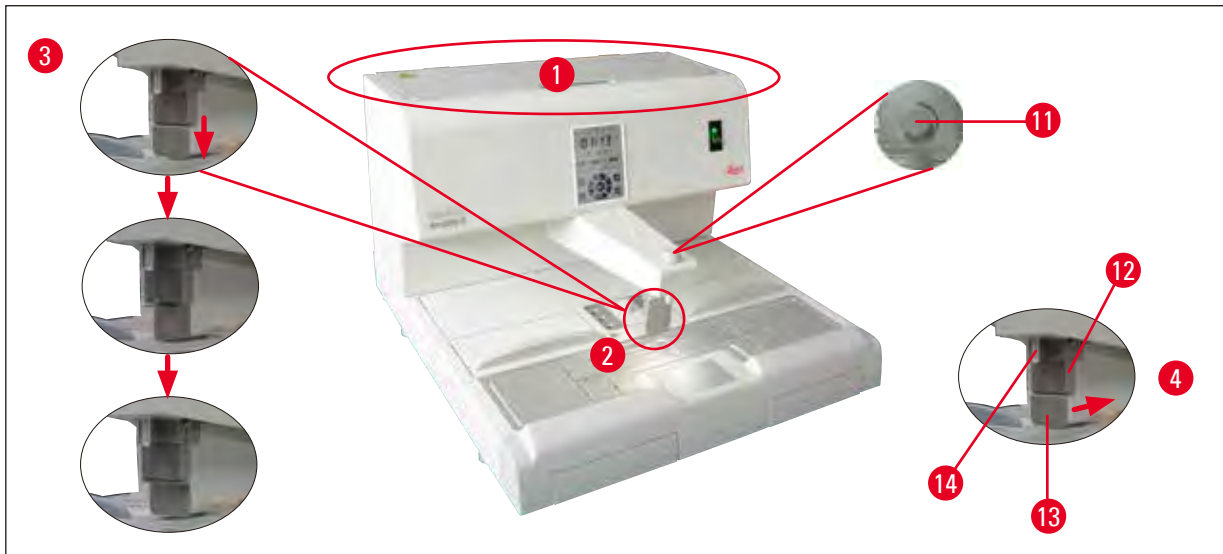

Fig. 10

Paraffin tank (→ Fig. 10-1)

- The paraffin tank has a capacity of max. 4 litres. The paraffin temperature can be set between 50 °C (122 °F) and 75 °C (167 °F) in 1 °C (or 1 °F) increments. The lid should always be in place otherwise the adjusted temperature cannot be maintained. An over-temperature cutout is provided to prevent overheating of the paraffin if temperature control fails.
- A built-in filter prevents any particles contained in the paraffin from getting in the tubing system.



Warning

- Carefully close the paraffin tank lid. Risk of pinching!
- Recycled paraffin may NOT be used in the HistoCore Arcadia H due to the danger of contamination.
- Bad quality paraffin may lead to blockage. Please use correct and proper paraffin.
- Refilling with different paraffin may lead to cracks in paraffin blocks. It is recommended to use the same type of paraffin.
- Carefully refill the paraffin. Risk of burning!

Dispenser (→ Fig. 10-2)

- The dispenser is heated separately. The temperature setting of the dispenser and paraffin tank is coupled.
- The quantity of paraffin released from the filler tube (→ Fig. 10-14) can be adjusted continuously with the metering screw (→ Fig. 10-11).
- The dispenser handle (→ Fig. 10-12) is used for manually operating the paraffin flow. It is provided with a pressure clip (→ Fig. 10-13). The pressure clip can be reversed to leave more space for mega cassettes under the filler tube (→ Fig. 10-14), (→ Fig. 10-3)

- The dispenser handle can be operated by simply pushing the mold (or a finger) against the pressure clip. Slightly pushing the handle backwards will open the dispenser valve (→ Fig. 10-4). Once released, the handle springs back in the original position and the valve shuts.



Note

The flow cannot be stopped completely with the metering screw (→ Fig. 10-11). It must not be turned while cold!



Warning

Do not use the dispenser when the instrument is powered off. Otherwise, mechanical damage will be caused to the dispenser.



Fig. 11

Working surface (→ Fig. 11-3)

- The working surface includes the embedding area (→ Fig. 11-3), forceps holder (→ Fig. 11-5) and the cold spot (→ Fig. 11-4).
- The temperature of the embedding area (→ Fig. 11-3) and forceps holder (→ Fig. 11-5) can be adjusted between 50 °C (122 °F) and 75 °C (167 °F) in 1 °C (or 1 °F) increments.
- The working area has grooves and several drain holes (→ Fig. 11-15), through which excess paraffin rapidly drains.

Cold spot (→ Fig. 11-4)

- The cold spot is an integral part of the work area.
- To orientate the specimen, the mold is filled about one third with liquid paraffin. The liquid paraffin begins to solidify rapidly on the cold spot.
- While the paraffin is semi-liquid, the specimen can be oriented as required. Finally, the mold can rapidly be filled up with paraffin.

5 Operation

Forceps holder (→ Fig. 11-5)

The removable forceps holder under the dispenser can accommodate up to 6 forceps.



Note

- While orienting the tissue, the paraffin should not become too solid, as this may cause different phases in the finished block, including fissures inside, as a result of which the block may break during sectioning.
- It is recommended to clean the forceps before using.



Warning

The forceps holder is heated to between 50 °C (122 °F) and 75 °C (167 °F) during operation.
Risk of burning!



Fig. 12

Paraffin collection tray (→ Fig. 12-8)

Two indirectly-heated paraffin collection trays for excess paraffin are located under the working surface.



Warning

- The paraffin collection tray must be emptied daily or whenever it is full. To prevent contamination, do not reuse paraffin collected in this tray.
- If the instrument is operated without the paraffin collection trays, there is risk of burning.

Embedding mold tray and cassette tray (→ Fig. 12-16)

- Depending on the preferred working direction, the two heated instrument trays (→ Fig. 12-6), (→ Fig. 12-7) can be used for embedding molds or cassettes. The temperature is adjustable between 50 °C (122 °F) and 75 °C (167 °F).
- A removable tray (→ Fig. 12-16) for cassettes or embedding molds can be placed in each instrument tray.
- A lid (→ Fig. 12-17) is provided for each of the trays (→ Fig. 12-16) to prevent loss of heat and contamination inside the tray. For easy access, the lid can be folded up.



Warning

- Only use the cassette, embedding mold tray and paraffin tank with the supplied lids.
- Wear gloves when opening the lids.
- It is recommended to clean the cassette tray before adding new specimen.



Note

- When working with half-open lids (→ Fig. 12-17), adjust the temperature to ensure that the paraffin remains molten.
- Use the removable trays in the cassette/mold tray in normal work-flow.
- Use the compatible basket with the trays. Use correct molds.
- Make sure all cassettes are fully covered during operation.
- Do not fill excessive paraffin to the cassette/mold tray. Risk of burning!



Fig. 13

Power switch (→ Fig. 13-9)

- Press the power switch ON/OFF to connect/cut the main power.
"I" = **ON** "O" = **OFF**
- A lamp lights up in the switch to indicate that the instrument is connecting to the main power.
- After the instrument has been commissioned, the power switch should only be used if the instrument is to be switched off for a longer period of time.

5 Operation



Note

If programmed procedures are to be carried out: the power switch (→ Fig. 13-9) must be switched on and the instrument must be in standby mode.
For more information, (→ p. 32 – 5.4 Operation modes).

Work area illumination (→ Fig. 13-10)

- An LED light system for the working area provides homogeneous diffuse illumination of the embedding area and cold spot. This produces optimum visibility conditions when dispensing the paraffin and positioning the specimen.
- The light can be controlled by pressing the light button (→ Fig. 13-15), (→ Fig. 17-15) on the control panel.

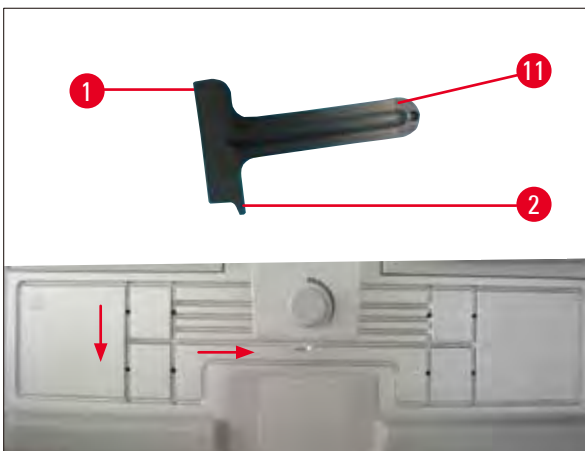

Fig. 14

Scraper (→ Fig. 14-11)

- Use the scraper head (→ Fig. 14-1) to remove any remaining paraffin on the instrument.
- Use the scraper finger (→ Fig. 14-2) to remove any remaining paraffin in the grooves on the working surface.



Warning

Move the scraper finger (→ Fig. 14-2) along the grooves on the working surface as shown in (→ Fig. 14). Otherwise, the scraper finger (→ Fig. 14-2) may break.

5.2 Switching the instrument on

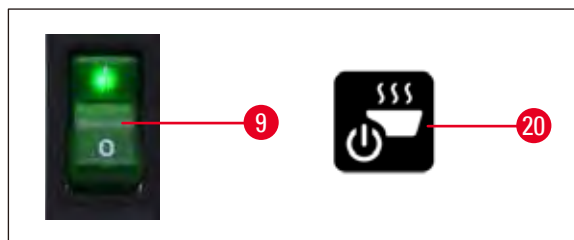

Fig. 15

To switch on the instrument for the first time, follow these steps.

- Fill the paraffin tank with paraffin.
- Set the power switch (right-hand side, next to control panel) to "I" position (→ Fig. 15-9), (→ Fig. 16-9).
- The instrument performs a self-test. All icons on the touchscreen light up shortly and go out. Then, 4 buttons, Up, Right, Down, Left, are shown on the screen repeatedly in sequence for a few seconds. When the 4 buttons go out, the **Operate/Standby** button (→ Fig. 15-20), (→ Fig. 17-20) and the light button is shown on the screen. The instrument enters standby mode.
- Touch the **Operate/Standby** button no less than 1 second, and the instrument enters operating mode.



Note

- The normal modes of the instrument are Standby and Operating. Switch between the two modes by using the **Operate/Standby** button.
- Use the power switch only if the instrument is to be switched off for an extended period or to apply new settings of the Start time and End time.

- Set the temperature of the heating area, the working day, local time, Start time and End time. To set these values, (→ p. 28 – 5.3 Control panel functions).
- The heaters become active. The melting indicator (→ Fig. 17-13) flashes once per second during the heating phase. The temperature settings can be modified during the heating phase.



Note

Prior to leaving the factory, the HistoCore Arcadia H is tested thoroughly under laboratory conditions. Please check the paraffin tank and the dispenser before using or after service. There will be a small quantity of clean paraffin in the paraffin tank or dropped from the dispenser. You can work with this paraffin without any problem.



Warning

- During operation, it is recommended not to fill the instrument with solid paraffin when the paraffin in the paraffin tank is already melted.
- Risk of burning!
- Risk of blockage in the paraffin tank where it connects with the filler tube.
- Do not add more than 4 L paraffin into the tank.

5 Operation

5.3 Control panel functions

Overview of the control panel

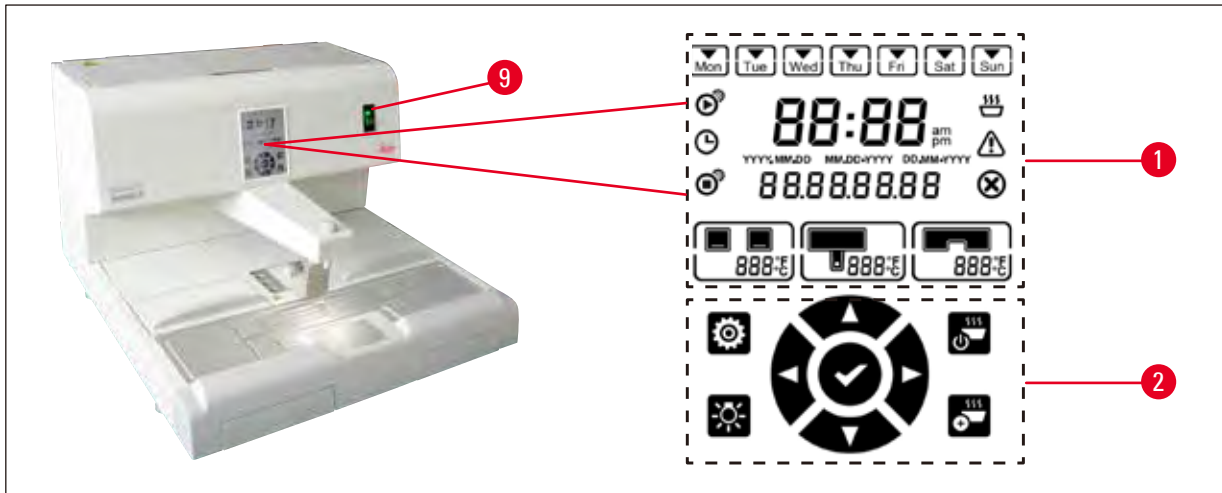

Fig. 16

The control panel beside the power switch (→ Fig. 16-9) is a backlit touchscreen. It consists of icons (→ Fig. 16-1) and touchable control and programming buttons (→ Fig. 16-2).

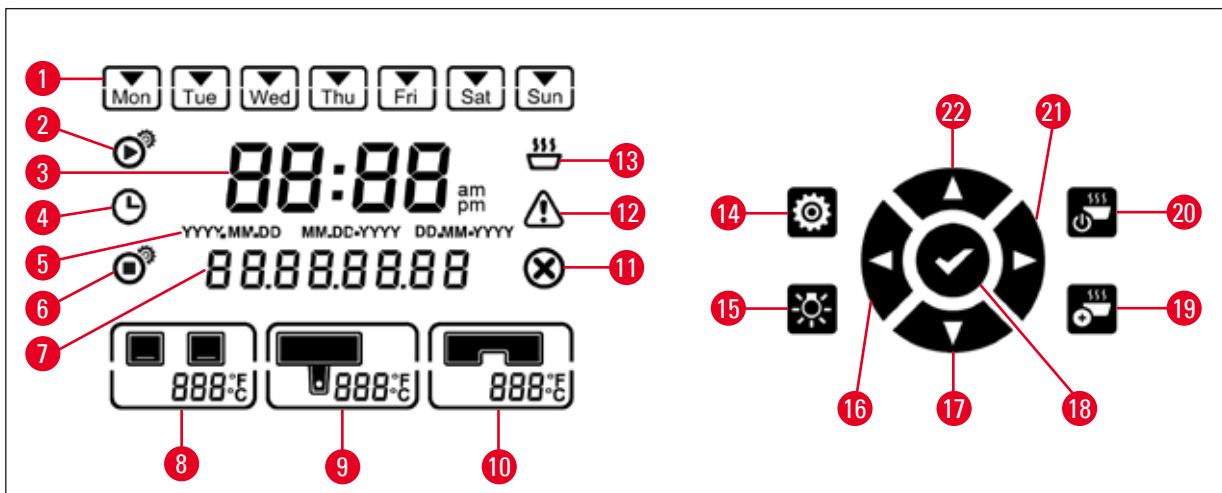

Fig. 17

- | | | | | | |
|---|---------------------|----|-----------------------------|----|-----------------|
| 1 | Weekday/Working day | 9 | Paraffin tank temperature | 16 | Left |
| 2 | Start time | 10 | Working surface temperature | 17 | Down |
| 3 | Current time | 11 | Error | 18 | Enter |
| 4 | Scheduler | 12 | Warning | 19 | Enhance heating |
| 5 | Date format | 13 | Melting indicator | 20 | Operate/Standby |
| 6 | End time | 14 | Setup | 21 | Right |
| 7 | Date/Message code | 15 | Light | 22 | Up |
| 8 | Trays temperature | | | | |



Note

If no touch action is received within 60 seconds, the setting mode exits automatically. All the settings are stored until they are changed, even if the instrument is switched off with the power switch.

Setting the temperature

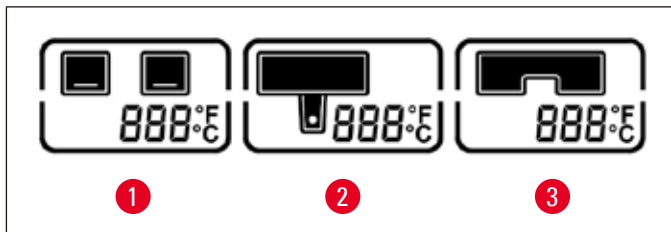

Fig. 18

- | | |
|---|---|
| <p>1 Temperature of trays</p> <p>2 Temperature of paraffin tank/dispenser</p> | <p>3 Temperature of working surface/forceps holder</p> |
|---|---|

The temperatures for the instruments different heating areas can be adjusted separately from 50 °C (122 °F) and 75 °C (167 °F) in 1 °C (or 1 °F) increments.



Warning

When setting the temperature, please observe the paraffin manufacturer's specifications for the maximum permissible temperature.

1. Touch the **Setup** (→ Fig. 17-14) button and the temperature of the trays will flash.
2. Set the temperature value with the **Up** (→ Fig. 17-22)/**Down** (→ Fig. 17-17) buttons. Press the **Up/Down** button for more than 2 seconds, and the setting value is changed continuously. Touch the **Left** (→ Fig. 17-16)/**Right** (→ Fig. 17-21) button to switch between the trays temperature, paraffin tank/dispenser temperature, working surface/forceps holder temperature, temperature unit (°C or °F).
3. If necessary, touch the **Up** (→ Fig. 17-22)/**Down** (→ Fig. 17-17) buttons to select Celsius degree (°C) or Fahrenheit degree (°F).
4. Touch the **Enter** (→ Fig. 17-18) button to save the setting. After 75 °C (167 °F) has been reached, the temperature will revert to 50 °C (122 °F). Once set, the temperature value for one range will be retained until it is changed.

Setting the working days

The automatic switch-on feature is linked with the individual weekdays. It is therefore necessary to define the days for which the automatic switch-on feature shall operate.



Note

Only on those days of week that have been defined as working days, the instrument will be at the required temperature and ready to operate.

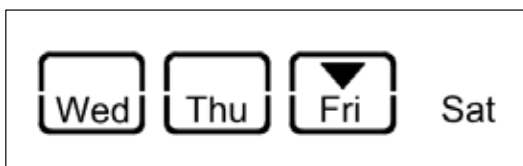

Fig. 19

1. Touch the **Setup** (→ Fig. 17-14) button.
2. Touch the **Enter** (→ Fig. 17-18) button as many times as required until the icon of Mon (Monday) flashes.
3. Touch the **Left** (→ Fig. 17-16)/**Right** (→ Fig. 17-21) buttons to switch between days of week, and set the working days with the **Up** (→ Fig. 17-22)/**Down** (→ Fig. 17-17) buttons. The selected working day is outlined with a rectangle. The current day is identified with a reversed triangle.
4. Touch the **Enter** (→ Fig. 17-18) button to save the setting.

Setting the date and time

The date and time shown on the control panel must be set to the current local time to ensure the correct operation of the time program control.

1. Touch the **Setup** (→ Fig. 17-14) button.
2. Touch the **Enter** (→ Fig. 17-18) button as many times as required until the date format flashes.
3. Touch the **Up** (→ Fig. 17-22)/**Down** (→ Fig. 17-17) buttons to select the date format.
Date formats:
 - **YYYY.MM.DD**. Under this date format, the time format is 24-hour.
 - **MM.DD.YYYY**. Under this date format, the time format is 12-hour.
 - **DD.MM.YYYY**. Under this date format, the time format is 24-hour.
4. Touch the **Right** (→ Fig. 17-21) button.
5. Set the date and time with the **Up** (→ Fig. 17-22)/**Down** (→ Fig. 17-17) buttons. Touch the **Left** (→ Fig. 17-16)/**Right** (→ Fig. 17-21) button to switch between the values of Year, Month, Day, Hour, Minute, am and pm (only in 12-hour format). Press the **Up/Down** button for more than 2 seconds, and the setting value is changed continuously.
6. Touch the **Enter** (→ Fig. 17-18) button to save the setting.

Setting the Start time

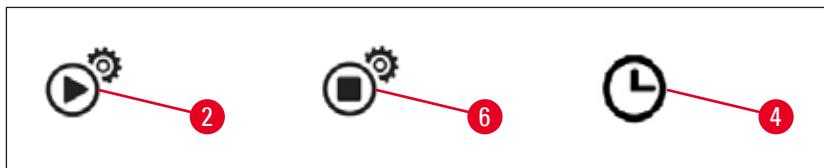

Fig. 20

The Start time is the time at which the instrument automatically enters operating mode.

1. Touch the **Setup** (→ Fig. 17-14) button.
2. Touch the **Enter** (→ Fig. 17-18) button as many times as required until the icon of Start time (→ Fig. 20-2) shows up and the value of Hour flashes.
3. Set the Hour with the **Up** (→ Fig. 17-22)/**Down** (→ Fig. 17-17) buttons.
Press the **Up/Down** button for more than 2 seconds, and the setting value is changed continuously.
4. Touch the **Right** (→ Fig. 17-21) button and the value of the Minute flashes.
5. Set the Minute with the **Up** (→ Fig. 17-22)/**Down** (→ Fig. 17-17) buttons.
If 12-hour format is selected, touch the **Right** (→ Fig. 17-21) button and use the **Up** (→ Fig. 17-22)/**Down** (→ Fig. 17-17) buttons to set am and pm.
6. Touch the **Enter** (→ Fig. 17-18) button to save the setting.

Setting the End time

The End time is the time at which the instrument automatically switches from operating mode to standby.

1. Touch the **Setup** (→ Fig. 17-14) button.
2. Touch the **Enter** (→ Fig. 17-18) button as many times as required until the icon of End time (→ Fig. 20-6) shows up and the value of Hour flashes.
3. Follow steps 3, 4, 5 and 6 in the **Setting the Start time**, to set the End time.

After the Start time and End time are set, switch off and on the instrument using the physical button (→ Fig. 15-9), and the scheduler icon is displayed on the control panel (→ Fig. 20-4).

To disable the scheduler (→ p. 32 – 5.4 Operation modes).



Warning

- The scheduler works only when the instrument is powered on.
- The Start time and End time are still effective in the standby mode.

5.4 Operation modes

Standby mode

If the scheduler is enabled, the instrument enters operation mode and standby mode automatically at the programmed Start time and End time.

During the standby mode:

- All heating elements (paraffin tank/dispenser, working surface/forceps holder, and trays) are switched off.
- Cold spot cooling is switched off.
- The dispenser control is disabled.
- Only the **Operate/Standby** button, the **Enhance heating** button, the **Light** button and the **Scheduler** icon (if it is already enabled the day before) are shown on the control panel.

Enabling operating mode



Fig. 21

- Touch the **Operate/Standby** (→ Fig. 21-20) button no less than 1 second.
- The instrument switches from standby mode to operating mode. The current time and icons of the currently selected values are shown on the control panel.

24-hour mode – working in shift mode

If the Start time and End time are set to the same value, the instrument will run continuously, even on days that are not defined as work days.

Example: Start time = **00:00** and End time = **00:00**.

To set the scheduler, (→ p. 28 – 5.3 Control panel functions).



Warning

Important

The scheduler is disabled if the end time is before the start time. The scheduler icon is not displayed. For example, Start time: 08:00 and End time: 06:00.



Note

In 24-hour mode, activate enhance heating mode (→ p. 33 – 5.5 Instrument heater) to accelerate the melting process after replenishing solid paraffin.

5.5 Instrument heater

Pre-heating mode

When the scheduler is enabled and the available pre-heating time is no less than 5 hours, the instrument goes into the pre-heating mode 5 hours before the Start time.

- All heating elements (paraffin tank/dispenser, working surface/forceps holder, and trays): Heating starts 5 hours before the Start time.
- Cold spot and fan: Starts 25 minutes before the Start time.

During the pre-heating phase, only the **Operate/Standby** button, the **Scheduler** icon, the **Light** button and blinking **Melting** icon are shown on the control panel.

Enhance heating mode

A large amount of heat is needed for melting paraffin. This is only accounted for in standby mode for a respective preliminary time. In the operating mode, the paraffin tank is heated just enough to maintain the paraffin at the selected temperature. Therefore the melting process can be sped up by increasing the heat supply (enhance heating mode) whenever necessary (e.g. when solid paraffin has to be added to the tank when working in shifts). The paraffin tank is then heated to a higher temperature (enhance heating mode).

To activate the enhance heating mode during operation mode, touch the enhance heating button.

The enhance heating button shows up and the melting indicator flashes faster while enhance heating mode is enabled.

The enhance heating mode can be switched off at any time by touching the same button.



Warning

Important

Do not use the instrument during the enhance heating mode. Otherwise, it may cause damage to the specimen.

Do not use the instrument if the warning symbol (→ Fig. 17-12) flashes. Please wait till the warning symbol disappears.

6. Maintenance and Cleaning**6.1 Cleaning the instrument****Warning**

- Do not use xylene for cleaning. Xylene vapors are heavier than air and can ignite at a considerable distance from the source of heat.
- A fire hazard exists!
- Do not use non-recommended cleaning products. The residual cleaning reagent may cause contamination to the specimen.
- To avoid scratching the surface of the instrument only the paraffin scraper that is supplied with the instrument should be used for cleaning – on no account use metal tools!

Work surfaces

- All common laboratory cleaning products suitable for the removal of paraffin (e.g. Polyguard or xylene substitutes) can be used to clean the work area.
- Avoid prolonged contact of organic solvents on the surface of the instrument.
- Use a dry, lint-free tissue paper to clean the condensed water on the cold spot when necessary.

Control panel

- Use a dry, lint-free cloth to clean the control panel weekly.
- If any paraffin has solidified onto the control panel, carefully remove it.

Paraffin tank

- Keep contaminants out of the paraffin tank.
- Drain the paraffin through the dispenser. Ensure that a residual amount of paraffin remains in the tank after draining to prevent solid contaminants from entering the dispenser.
- Absorb this paraffin with tissue or a paper towel. Do not remove the paraffin filter until the residual paraffin has been removed.
- The interior surfaces of the tank can then be cleaned with a tissue.

**Warning**

The molten paraffin and the paraffin tank are hot. Risk of burning!

Forceps holder

The forceps holder is often a source of contamination and extremely susceptible to dirt. Use a lint-free cloth dipped with the cleaning reagent to clean the forceps holder and the cavity weekly.

**Warning**

The forceps holder is heated to between 50 °C (122 °F) and 75 °C (167 °F) during operation. Risk of burning!

Illumination

Poor illumination may affect daily operation, e.g. incorrect orientation of the specimen. Use a lint-free cloth dipped with the cleaning reagent to clean the LED protective cover monthly.

Paraffin collection tray

Before the paraffin collection trays can be emptied, any excess paraffin on the work area must be removed with cellulose wadding in order to prevent any paraffin from penetrating into the instrument.



Warning

Use care with paraffins with a low melting point - risk of burning when removing the paraffin collection trays due to liquid paraffin.

- Only remove and empty the paraffin collection trays while they are warm.
- The paraffin in the collection trays must not be reused. Danger of paraffin carry-over into the instrument.
- Empty both paraffin collection trays regularly in order to prevent them from overflowing into the instrument. While emptying intervals may vary depending on use, the trays should be emptied at least daily.



Warning

- If the paraffin collection trays are not emptied regularly, excess paraffin may flow into the instrument or onto the work surface.
- This presents a burn hazard and may damage the instrument.

6.2 Maintenance instructions



Warning

Only Leica Biosystems service technicians are authorized to open the instrument for maintenance and repair work.

Please observe the following points to ensure the instrument's reliability.

- Clean the instrument with care daily.
- Regularly remove dust from the ventilation slots on the back of the instrument with a brush or vacuum cleaner.
- Enter into a service contract at the end of the warranty period. For more information, contact the relevant customer service organization.

7. Troubleshooting

7.1 Error message

When an instrument error occurs, a flashing error message is displayed in the "Date/Message code" area (→ Fig. 17-7). Touch the **Enter** button (→ Fig. 17-18) to stop the flashing of the error message. The error message will not disappear until the instrument is rebooted.

Follow the instructions in the column of **USER ACTION**. For further instructions, please refer to (→ p. 46 – 9. Warranty and Service).

The table below lists the error messages that may be displayed on the control panel.

No.	Error Message	Description	Instrument Behavior	User action
1	2_11	The temperature of the dispenser is higher than the upper temperature limit.	1. Stop dispenser heating 2. Error Message & Error Icon blinking	Contact customer service.
2	2_12	The temperature of the dispenser drops below the lower temperature limit of the target.	Error Message & Error Icon blinking	Contact customer service.
3	2_15	The temperature of the dispenser rises too fast.	Error Message & Error Icon blinking	Contact customer service.
4	2_21	The temperature of the paraffin tank is higher than the upper temperature limit.	1. Stop tank heating 2. Error Message & Error Icon blinking	Contact customer service.
5	2_22	The temperature of the paraffin tank drops below the lower temperature limit of target.	Error Message & Error Icon blinking	Contact customer service.
6	2_23	The paraffin tank cannot reach the target temperature after 5 hours the system starts heating up.	1. Stop tank heating 2. Error Message & Error Icon blinking 3. Alarm beep	Shut down the instrument and contact customer service.
7	2_25	The temperature of the paraffin tank rises too fast.	Error Message & Error Icon blinking	1. Take out the specimen from the instrument. 2. Make sure that the input voltage is right for the instrument. 3. Contact customer service.

No.	Error Message	Description	Instrument Behavior	User action
8	2_31	The temperature of the left tray is higher than the upper temperature limit.	<ol style="list-style-type: none"> 1. Stop left tray heating 2. Error Message & Error Icon blinking 3. Alarm beep 	Take out the specimen from the instrument and contact customer service.
9	2_32	The temperature of the left tray drops below the lower temperature limit of the target.	Error Message & Error Icon blinking	Contact customer service.
10	2_33	The left tray cannot reach target temperature after 5 hours the system starts heating up.	Error Message & Error Icon blinking	Contact customer service.
11	2_35	The temperature of the left tray rises too fast.	Error Message & Error Icon blinking	<ol style="list-style-type: none"> 1. Take out the specimen from the instrument. 2. Make sure that the input voltage is right for the instrument. 3. Contact customer service.
12	2_41	The temperature of the right tray is higher than the upper temperature limit.	<ol style="list-style-type: none"> 1. Stop right tray heating 2. Error Message & Error Icon blinking 3. Alarm beep 	Take out the specimen from the instrument and contact customer service.
13	2_42	The temperature of the right tray drops below the lower temperature limit of the target.	Error Message & Error Icon blinking	<ol style="list-style-type: none"> 1. Restart the instrument. 2. If the error message persists after restarting the instrument, contact customer service.
14	2_43	The right tray cannot reach target temperature after 5 hours the system is switched on.	Error Message & Error Icon blinking	<ol style="list-style-type: none"> 1. Make sure that the input voltage is right for the instrument. 2. Contact customer service.
15	2_45	The temperature of the right tray rises too fast.	Error Message & Error Icon blinking	<ol style="list-style-type: none"> 1. Take out the specimen from the instrument. 2. Make sure that the input voltage is right for the instrument. 3. Contact customer service.

No.	Error Message	Description	Instrument Behavior	User action
16	2_51	The temperature of the working surface is higher than the upper temperature limit.	<ol style="list-style-type: none"> 1. Stop working surface heating 2. Error Message & Error Icon blinking 3. Alarm beep 	Shut down the instrument and contact customer service.
17	2_52	The temperature of the working surface drops below the lower temperature limit of the target.	Error Message & Error Icon blinking	<ol style="list-style-type: none"> 1. Make sure that the input voltage is right for the instrument. 2. Contact customer service.
18	2_55	The temperature of the working surface rises too fast.	Error Message & Error Icon blinking	<ol style="list-style-type: none"> 1. Stop embedding workflow. 2. Make sure that the input voltage is right for the instrument. 3. Contact customer service.
19	2_71	The temperature of the cold spot is below the lower temperature limit.	Error Message & Error Icon blinking	<ol style="list-style-type: none"> 1. Make sure that the room temperature is 20~30 °C. 2. Contact customer service.
20	2_72	The temperature of the cold spot rises higher than the upper temperature limit.	Error Message & Error Icon blinking	<ol style="list-style-type: none"> 1. Make sure that the room temperature is 20~30 °C. 2. Contact customer service.
21	2_73	The temperature of the cold spot is higher than the upper temperature limit after 1 hour the system is switched on.	Error Message & Error Icon blinking	<ol style="list-style-type: none"> 1. Make sure that the room temperature is 20~30 °C. 2. Contact customer service.
22	2_61	The temperature of the forceps holder is higher than the upper temperature limit.	<ol style="list-style-type: none"> 1. Stop forceps holder heating 2. Error Message & Error Icon blinking 3. Alarm beep 	Take out the forceps from the forceps holder and contact customer service.
23	2_62	The temperature of the forceps holder drops below the lower temperature limit of the target.	Error Message & Error Icon blinking	Contact customer service.

No.	Error Message	Description	Instrument Behavior	User action
24	/	Tank Temperature Warning. The tank temperature is higher than 80 °C (176 °F).	Warning icon blink at 1 Hz	Do not use the instrument and wait until the icon disappears. If the blinking persists, shut down the instrument and contact customer service.

7.2 Possible faults

This section will help you diagnose problems that may occur when working with the instrument.

If a problem cannot be resolved by following the instructions, please contact your Leica Biosystems technical service center. For further instructions, please refer to ([→ p. 46 – 9. Warranty and Service](#)).

The table below lists the most common problems that may occur as well as possible causes and remedies.

Problem	Possible cause	Corrective action
<p>1. Control panel</p> <p>The control panel button has no response.</p> <p>The melting indicator is still blinking when the defined melting time is over.</p>	<ul style="list-style-type: none"> • The cable/connector is loose. • The touch panel is contaminated by the paraffin. • The control panel is broken. • Software malfunction. 	<ul style="list-style-type: none"> • Contact customer service. • Clean the paraffin on the touch panel. • Contact customer service. • Restart the instrument. • Contact customer service.
<p>2. Paraffin tank</p> <p>Paraffin does not completely melt.</p> <p>The paraffin tank is overheated.</p>	<ul style="list-style-type: none"> • The Start time is not correct. • The control board has failed. • The heating limiter is broken. 	<ul style="list-style-type: none"> • Check the scheduler setup. • Contact customer service. • Contact customer service.
<p>3. Illumination does not work.</p>	<ul style="list-style-type: none"> • The circuit board is broken. • The LED cable is broken. • The LED is broken. 	<ul style="list-style-type: none"> • Contact customer service. • Contact customer service. • Contact customer service.
<p>4. Working surface/Cassette mold Tray/Cold spot</p> <p>The Start time and End time is invalid.</p>	<ul style="list-style-type: none"> • The local time setting is wrong. • The battery on the board is discharged. 	<ul style="list-style-type: none"> • Check the local time setup. • Contact customer service.
<p>Specimens are not covered in paraffin in the cassette tray.</p> <p>The paraffin in the cassette tray is not melting.</p> <p>The paraffin on the working surface cools down.</p> <p>The specimen get burnt.</p>	<ul style="list-style-type: none"> • The paraffin in the cassette tray is not filled to the correct level. • The temperature setting of the cassette tray is not correct. • The temperature setting of the working surface is not correct. • The cassette tray temperature is too high. 	<ul style="list-style-type: none"> • Add paraffin. • Adjust the temperature setting for the tray. • Adjust the temperature setting for the working surface. • Contact customer service.
<p>5. No paraffin flow down from the dispenser tube.</p>	<ul style="list-style-type: none"> • The paraffin in the paraffin tank has not melted yet. • The dispenser is blocked. 	<ul style="list-style-type: none"> • Adjust the temperature setting for the paraffin tank. • Contact customer service.
<p>6. The instrument can't shut down.</p>	<ul style="list-style-type: none"> • The power switch button is stuck by paraffin. 	<ul style="list-style-type: none"> • Clean the paraffin on the power switch.

7.3 Changing a fuse



Warning

Before changing a fuse switch the instrument off and pull out the power plug. Use ONLY the provided replacement fuses.

Important!

Observe the following instructions exactly to ensure that the correct spare fuse is used for the matching fuse holder.

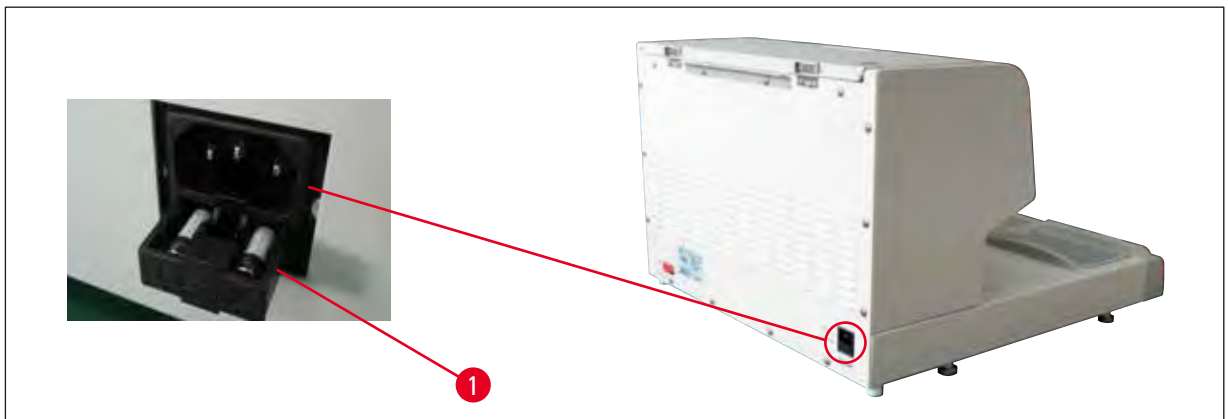

Fig. 22

Fuse rating: 10 A, 250 V

Use a screw driver to release the fuse drawer (→ Fig. 22-1). Once released, the drawer can be pulled out to expose the fuses.

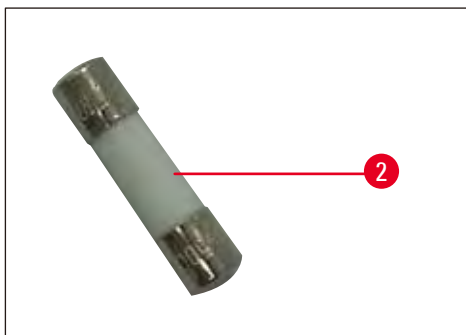

Fig. 23

Take the defective fuse (→ Fig. 23-2) out of the fuse drawer and insert the new spare fuse.

Push back the fuse drawer to its original location.

8. Optional Accessories

8.1 Magnifier

The magnifier provides a magnified view of the work area. When properly adjusted, an enlarged view of the dispenser and cold spot is available.

Installing the magnifier

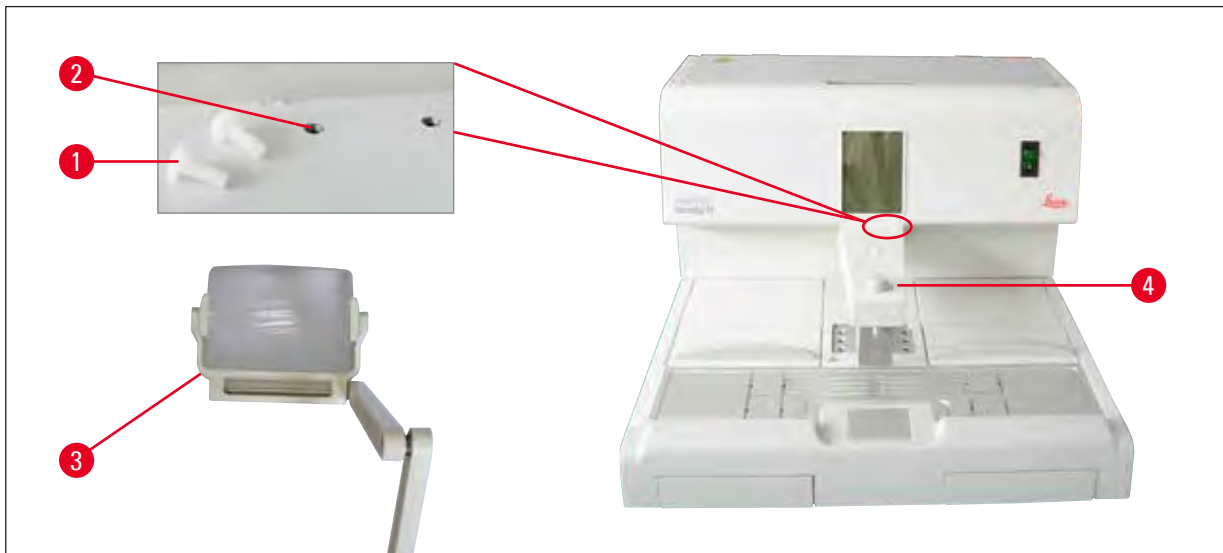

Fig. 24

- On the dispenser (→ Fig. 24-4) tap holes (→ Fig. 24-2) are provided, which are closed with nylon screws (→ Fig. 24-1).
- Remove the screws (→ Fig. 24-1) with a screwdriver and store them in a safe place. Then install the magnifier (→ Fig. 24-3) either on the left-hand or the right-hand, and align the magnifier.

8.2 Foot switch



Warning

- Before connecting the power cord to the foot switch, ensure that the standby switch (→ Fig. 25-1) is set to "0" ("0" = **OFF**).
- The plug of the foot switch **MUST** be screwed to the socket. Otherwise hot paraffin can escape, even if the switch is not activated.
- **DO NOT** keep pressing down the foot switch by putting weight on it.

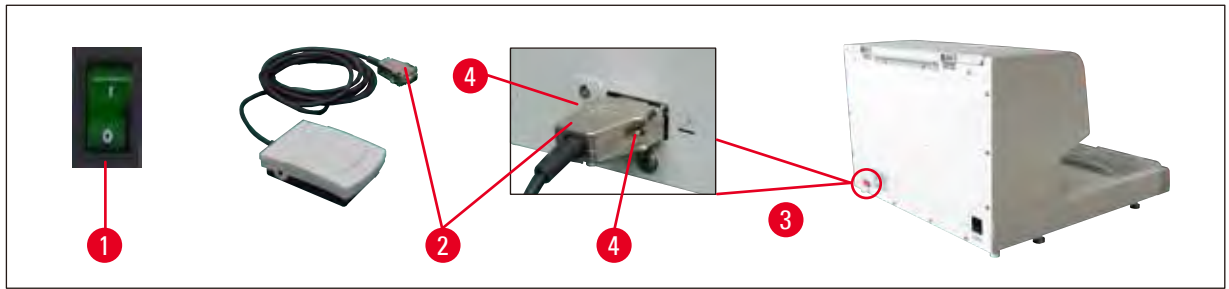

Fig. 25

- Insert the plug (→ Fig. 25-2) of the foot switch into the connecting port (→ Fig. 25-3) on the rear of the instrument.
- Tighten the screws (→ Fig. 25-4) of the plug.

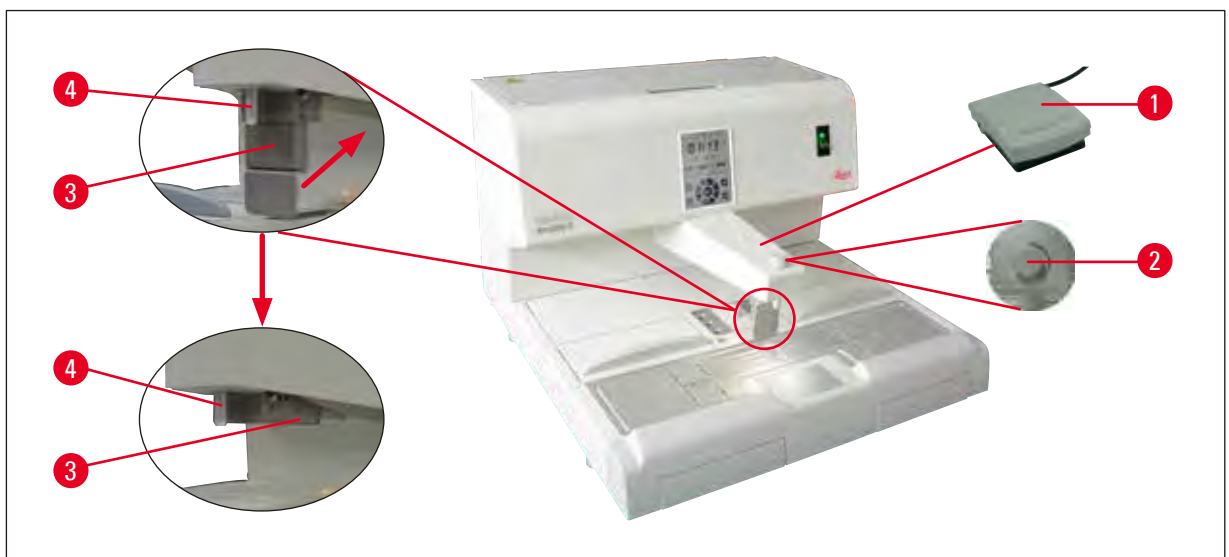

Fig. 26

- Pressing the foot switch (→ Fig. 26-1) opens the valve, releasing it closes it. This keeps the operator's hands free to work with the instrument.
- The flow volume can be adjusted with the metering screw (→ Fig. 26-2).
- The dispenser handle (→ Fig. 26-3) is not required when using the foot switch and can be folded upwards.

Proceed as follows:

- Set the metering screw (→ Fig. 26-2) to minimum.
- Carefully push and fold the dispenser handle (→ Fig. 26-3) back/up with your thumb and index finger.



Warning

Take care when folding back the dispenser handle! Hot paraffin may come out of the filler tube (→ Fig. 26-4).

DANGER OF BURNING!

8.3 Pre-filter cup

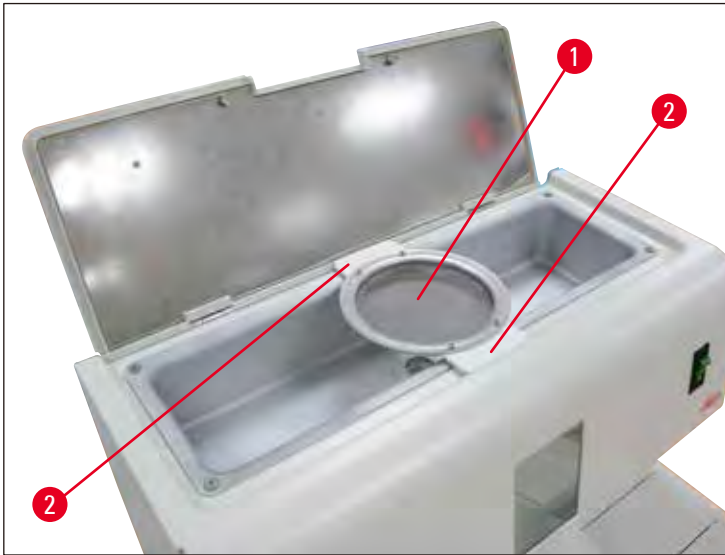

Fig. 27

- The pre-filter cup (→ Fig. 27-1) is designed to remove the impurities from the melted paraffin.
- Place the pre-filter cup (→ Fig. 27-1) on the paraffin tank (→ Fig. 27).
- Fill the melted paraffin in the paraffin tank through the pre-filter cup.



Warning

- Hold the plastic handles (→ Fig. 27-2) when placing the pre-filter cup on the paraffin tank. DO NOT touch the metal sieve. Risk of burning.
- Do not put the solid paraffin on the pre-filter cup.

8.4 Basket handle



Fig. 28

The basket handle is designed for transferring dedicated tissue baskets that can hold 150 cassettes.

8.5 Ordering information

	Order No.
Foot switch (2.8 m cable, DB9 connector)	14 0393 54121
Magnifier (magnification 1)	14 0393 54116
Pre-filter cup (D=148 mm)	14 0393 53705
Set of spare fuse (10A, 250VAC)	14 6000 04975

	Order No.
Paraffin scraper (130 mm x 75 mm)	14 0393 53643
Paraffin tank filter (D=28 mm)	14 0393 53559
Basket handle	14 0393 57357

9. Warranty and Service**Warranty**

Leica Biosystems Nussloch GmbH guarantees that the contractual product delivered has been subjected to a comprehensive quality control procedure based on the Leica Biosystems in-house testing standards, and that the product is faultless and complies with all technical specifications and/or characteristics warranted.

The scope of the warranty is based on the content of the concluded agreement. The warranty terms of your Leica Biosystems sales organization or the organization from which you have purchased the contractual product shall apply exclusively.

Service Information

If you require technical service or replacement parts, please contact your Leica Biosystems sales representative or dealer who sold the product.

Please provide the following information:

- Model name and serial number of the instrument.
- Location of the instrument and name of the person to contact.
- Reason for the service call.
- Date of delivery.

Decommissioning and disposal

The instrument or parts of the instrument must be disposed of in compliance with the local laws.

10. Decontamination Confirmation

Every product that is returned to Leica Biosystems or that requires on-site maintenance must be properly cleaned and decontaminated. You can find the dedicated template of the decontamination confirmation on our website www.LeicaBiosystems.com within the product menu. This template has to be used for gathering all required data.

When returning a product, a copy of the filled and signed confirmation has to be enclosed or passed on to the service technician. The responsibility for products that are sent back without this confirmation or with an incomplete confirmation lies with the sender. Returned goods that are considered to be a potential source of danger by the company will be sent back at the expense and risk of the sender.

Note

www.LeicaBiosystems.com



Leica Biosystems Nussloch GmbH
Heidelberger Strasse 17 - 19
D-69226 Nussloch
Germany

Tel.: +49 - (0) 6224 - 143 0
Fax: +49 - (0) 6224 - 143 268
Web: www.LeicaBiosystems.com