

# Leica VT1200 / Leica VT1200 S

Vibrating-blade microtome



Instructions for Use  
English

**Order No.: 14 0481 80101 - Revision L**

Always keep this manual with the instrument.  
Read carefully before working with the instrument.

**CE**



The information, numerical data, notes and value judgments contained in this Instructions for Use represent the current state of scientific knowledge and state-of-the-art technology as we understand it following thorough investigation in this field.

We are under no obligation to update the present Instructions for Use periodically and on an ongoing basis according to the latest technical developments, nor to provide our customers with additional copies, updates etc. of this Instructions for Use.

To the extent permitted in accordance with the national legal system as applicable in each individual case, we shall not be held liable for erroneous statements, drawings, technical illustrations etc. contained in this Instructions for Use. In particular, no liability whatsoever is accepted for any financial loss or consequential damage caused by or related to compliance with statements or other information in this Instructions for Use.

Statements, drawings, illustrations and other information regarding the contents or technical details of the present Instructions for Use are not to be considered warranted characteristics of our products.

These are determined only by the contract provisions agreed between ourselves and our customers.

Leica reserves the right to change technical specifications as well as manufacturing processes without prior notice. Only in this way is it possible to continuously improve the technology and manufacturing techniques used in our products.

This document is protected under copyright laws. All copyrights to this documentation are held by Leica Biosystems Nussloch GmbH.

Any reproduction of text and illustrations (or of any parts thereof) by means of print, photocopy, microfiche, web cam or other methods – including any electronic systems and media – requires express prior permission in writing by Leica Biosystems Nussloch GmbH.

For the instrument serial number and year of manufacture, please refer to the nameplate on the back of the instrument.



Leica Biosystems Nussloch GmbH  
Heidelberger Strasse 17 - 19  
69226 Nussloch  
Germany  
Tel.: +49 - (0) 6224 - 143 0  
Fax: +49 - (0) 6224 - 143 268  
Web: [www.LeicaBiosystems.com](http://www.LeicaBiosystems.com)

Assembly contracted to Leica Microsystems Ltd. Shanghai

# Table of contents

---

<b>1. Important Information</b>	<b>6</b>
1.1 Symbols in the text and their meanings	6
1.2 Instrument model	8
1.3 Qualification of personnel	8
1.4 Intended use/improper use	8
<b>2. Safety</b>	<b>9</b>
2.1 General safety notes	9
2.2 Warnings	9
2.3 Transport, unpacking and setting up	10
<b>3. Instrument characteristics</b>	<b>11</b>
3.1 Technical data for the Leica VT1200	11
3.1.1 Technical data for the Leica VT1200 S	12
3.2 General overview – Leica VT1200 / Leica VT1200 S	14
3.3 Leica VT1200 control Panel	16
3.3.1 Leica VT1200 S control panel	17
<b>4. Installation</b>	<b>19</b>
4.1 Standard scope of delivery for the Leica VT1200	19
4.1.1 Standard scope of delivery for the Leica VT1200 S	19
4.2 Packing and setting up the instrument	20
4.3 Before commissioning the instrument	22
<b>5. Working with the Instrument</b>	<b>24</b>
5.1 Description of the typical application	24
5.2 Control elements on the Leica VT1200 control panel	25
5.2.1 Moving the specimen receptacle vertically	25
5.2.2 Fine-adjusting the blade-to-specimen proximity and feeding to the section thickness	25
5.2.3 Moving the blade	26
5.2.4 Selecting the sectioning parameters	26
5.3 Control elements on the Leica VT1200 S control panel	27
5.4 Installing the accessories	35
5.4.1 Installing the ice tray and buffer tray	35
5.4.2 Installing the double-walled buffer tray	36
5.4.3 Preparing a specimen	37
5.4.4 Installing and removing the blade holder	37
5.4.5 Inserting the blade	39
5.4.6 Adjusting the clearance angle	40
5.5 Routine daily maintenance and switching off the instrument – Leica VT1200 / Leica VT1200 S	40
<b>6. Operating the VibroCheck</b>	<b>41</b>
6.1 Using the VibroCheck with the Leica VT1200	41
6.2 Using the VibroCheck with the Leica VT1200 S	43
<b>7. Malfunctions: Meaning and Troubleshooting</b>	<b>46</b>
7.1 Error messages and troubleshooting	46
7.2 Replacing the main fuse	50







<b>8. Cleaning and Maintenance .....</b>	<b>51</b>
8.1 Cleaning the instrument .....	51
<b>9. Ordering Information for Optional Accessories, Consumables and Spare Parts .....</b>	<b>52</b>
9.1 Extension accessories for standard specimens .....	53
9.1.1 Buffer trays.....	53
9.1.2 Specimen plate .....	54
9.1.3 VibroCheck.....	55
9.1.4 Blades .....	56
9.1.5 Microscope, assembly.....	56
9.1.6 Magnifier, assembly .....	56
9.1.7 Installing the magnifier support or microscope support .....	57
9.1.8 Fiber-optic illumination, cold light source .....	58
9.1.9 Cyanoacrylate adhesive.....	59
9.1.10 Foot switch.....	59
9.1.11 Julabo FL300 – recirculating cooler/chiller .....	60
<b>10. Warranty and Service .....</b>	<b>61</b>
<b>11. Decontamination Confirmation .....</b>	<b>62</b>









# 1 Important Information

---

## 1. Important Information

### 1.1 Symbols in the text and their meanings

Symbol: 	Title of the symbol: Warning Description: Warnings appear in a gray box and are marked by a warning triangle.
Symbol: 	Title of the symbol: Caution Description: Cautions appear in a gray box and are marked by a caution triangle.
Symbol: 	Title of the symbol: Note Description: Notes, i. e. important user information, appear in a gray box and are marked by an information symbol.
Symbol: → Fig. 7-1	Title of the symbol: Item number Description: Item numbers for numbering illustrations. Numbers in red refer to item numbers in illustrations.
Symbol: Supervisor	Title of the symbol: Software designations Description: Software designations that have to be displayed on the input screen are displayed as bold, gray text.
Symbol: <u>Save</u>	Title of the symbol: Function key Description: Function keys to be pressed on the instrument are displayed as bold, gray and underlined text.
Symbol: 	Title of the symbol: Manufacturer Description: Indicates the manufacturer of the medical product.
Symbol: 	Title of the symbol: Manufacturing date Description: Indicates the date when the medical device was manufactured.
Symbol: 	Title of the symbol: CE Compliance Description: The CE marking is the manufacturer's declaration that the medical product meets the requirements of the applicable EC directives and regulations.
Symbol: 	Title of the symbol: UKCA Label Description: The UKCA (UK Conformity Assessed) marking is a new UK product marking that is used for goods being placed on the market in Great Britain (England, Wales and Scotland). It covers most goods which previously required the CE marking.

<p><b>Symbol:</b></p> 	<p><b>Title of the symbol:</b></p> <p><b>Description:</b></p>	<p>Country of Origin</p> <p>The Country of Origin box defines the country where the final character transformation of the product has been performed.</p>
<p><b>Symbol:</b></p> 	<p><b>Title of the symbol:</b></p> <p><b>Description:</b></p>	<p>UK Responsible Person</p> <p>The UK Responsible Person acts on behalf of the non-UK manufacturer to carry out specified tasks in relation to the manufacturer's obligations.</p>
<p><b>Symbol:</b></p> 	<p><b>Title of the symbol:</b></p> <p><b>Description:</b></p>	<p>Consult Instructions for Use</p> <p>Indicates the need for the user to consult the Instructions for Use.</p>
<p><b>Symbol:</b></p> 	<p><b>Title of the symbol:</b></p> <p><b>Description:</b></p>	<p>Article number</p> <p>Indicates the manufacturer's catalog number so that the medical device can be identified.</p>
<p><b>Symbol:</b></p> 	<p><b>Title of the symbol:</b></p> <p><b>Description:</b></p>	<p>Serial number</p> <p>Indicates the manufacturer's serial number so that a specific medical device can be identified.</p>
<p><b>Symbol:</b></p> 	<p><b>Title of the symbol:</b></p> <p><b>Description:</b></p>	<p>Regulatory Compliance Mark (RCM)</p> <p>The Regulatory Compliance Mark (RCM) indicates a device's compliance with applicable ACMA technical standards of New Zealand and Australia – that is, for telecommunications, radio communications, EMC and EME.</p>
<p><b>Symbol:</b></p> 	<p><b>Title of the symbol:</b></p> <p><b>Description:</b></p>	<p>China ROHS</p> <p>Environmental protection symbol of the China RoHS directive. The number in the symbol indicates the "Environment-friendly Use Period" of the product in years. The symbol is used if a substance restricted in China is used in excess of the maximum permitted limit.</p>
<p><b>Symbol:</b></p> 	<p><b>Title of the symbol:</b></p> <p><b>Description:</b></p>	<p>CSA Statement (Canada/USA)</p> <p>The CSA test mark means that a product has been tested and fulfills the applicable safety and/or performance standards, including the relevant standards defined or administered by the American National Standards Institute (ANSI), Underwriters Laboratories (UL), the Canadian Standards Association (CSA), the National Sanitation Foundation International (NSF) and others.</p>
<p><b>Symbol:</b></p> 	<p><b>Title of the symbol:</b></p> <p><b>Description:</b></p>	<p>WEEE Symbol</p> <p>The WEEE symbol, indicating separate collection for WEEE – Waste of electrical and electronic equipment, consists of the crossed-out wheeled bin (§ 7 ElektroG).</p>

## 1.2 Instrument model

All information provided in these Instructions for Use applies only to the instrument type indicated on the title page.

A nameplate is attached to the rear side of the instrument. The series and REF numbers are attached to a separate label on the right side of the instrument.

## 1.3 Qualification of personnel

The Leica VT1200 and the Leica VT1200 S may be operated by trained laboratory personnel only. The instrument is intended for professional use only.

All laboratory personnel designated to operate this instrument must read these Instructions for Use carefully and must be familiar with all technical features of the instrument before attempting to operate it.

## 1.4 Intended use/improper use

The Leica VT1200 and Leica VT1200 S are used for sectioning in the fields of medicine, biology and industry, and are especially designed for sectioning fixed or unfixed fresh tissue in buffer.



### Warning

The Leica VT1200 / Leica VT1200 S may be used for research purposes only. Sections made using the Leica VT1200 / Leica VT1200 S must **NOT** be used for diagnostics.

The instrument must be used exclusively according to the instructions contained in these Instructions for Use.

Any other use of the instrument is considered improper.



## 2. Safety

These Instructions for Use includes important information related to the operating safety and maintenance of the instrument.

The Instructions for Use are an important part of the product, and must be read carefully prior to startup and use and must always be kept near the instrument.

If additional requirements on accident prevention and environmental protection apply in the country of operation, these Instructions for Use must be supplemented by appropriate instructions to ensure compliance with such requirements.

Make sure to read all of these Instructions for Use before you work on or operate the instrument.

### 2.1 General safety notes

These instruments have been built and tested in accordance with the safety regulations for electrical measuring, control, regulating and laboratory devices.

In order to maintain this condition and to ensure safe operation, the user must follow the instructions and warnings contained in this operating manual.

The current EC Declarations of Conformity and UKCA Declaration of Conformity can be found on the Internet:  
[www.LeicaBiosystems.com](http://www.LeicaBiosystems.com)

### 2.2 Warnings

The safety devices installed in this instrument by the manufacturer only constitute the basis for accident prevention. Operating the instrument safely is, above all, the responsibility of the owner, as well as the designated personnel who operate, service or clean the instrument.

To ensure trouble-free operation of the instrument, make sure to comply with the following instructions and warnings.



#### Warning

- Extremely sharp blades pose risk of injury when touched!
- Fresh tissue poses risk of infection!
- Fire hazard from uncovered magnifier! Cover the magnifier during work breaks!

#### Proper handling



#### Warning

The instrument **MUST** be connected to a grounded power socket. Use only a provided power cable that is intended for the local power supply.



### Note

- Always be exceptionally careful when handling the blades!
- Do not leave open blades lying around after removal.
- Always make sure to handle the blade in a way that will not cause you injury.
- All appropriate safety precautions must be met to avoid the risk of infection.
- Wearing safety gloves, a mask and safety goggles – in accordance with the "Working with Substances that Pose a Health Risk" guidelines – is absolutely mandatory.
- The instrument may be opened by authorized service personnel only.
- Always disconnect the power plug before opening the instrument.
- Always switch off the instrument using the power switch and disconnect the power plug before replacing the fuse. The use of fuses other than those installed at the factory is not permitted.

### 2.3 Transport, unpacking and setting up

- When unpacking the instrument, compare the parts received with the parts ordered. If the parts received do not match your order, contact the sales company responsible for your order immediately.
- Before connecting to the power supply system, please observe (→ p. 11 – 3.1 Technical data for the Leica VT1200) and (→ p. 12 – 3.1.1 Technical data for the Leica VT1200 S)!
- Never connect the instrument to a power socket that does not have a protective conductor terminal.



### Warning

The instrument must be set up so that the main power switch (→ Fig. 10-3) on its right side is easily accessible at any time.



### Note

Because the weight of the instrument is approx. 56 kg, carrying the instrument requires 2 persons (1 carrying handle per person).

### 3. Instrument characteristics

#### 3.1 Technical data for the Leica VT1200

##### Electrical Specifications

Nominal supply voltage	100 V - 240 V
Nominal supply frequencies	50/60 Hz
Mains supply voltage fluctuations	Not to exceed $\pm 10\%$ of the nominal supply voltage
Power consumption	50 VA
Mains input fuses	2x T1.0A L 250VAC

##### Dimensions and Weight Specification

Overall size of device in operating mode (Width x Depth x Height, mm)	600 mm x 250 mm x 230 mm
Overall size serial packaging (Width x Depth x Height, mm)	740 mm x 491 mm x 669 mm
Empty weight (without accessories, kg)	56 kg
Overall weight (with accessories, kg)	63.3 kg
Device weight including packaging (kg)	88.5 kg

##### Environmental Specification

Operating altitude (meters)	up to 2000 m above sea level
Temperature (operation) (min/max)	min. +10 °C to max. +35 °C
Relative humidity (operation) (min/max)	max. 60 %
Temperature (transit) (min/max)	-29 °C to +50 °C
Temperature (storage) (min/max)	+5 to +55 °C
Relative humidity (transit/storage)	< 60 %
Operating noise level	<70 dB

##### Emissions and Boundary Conditions

Overvoltage category to IEC 61010-1	II
Pollution degree to IEC 61010-1	2
Means of protection to IEC 61010-1	Class I
Degree of protection to IEC 60529	IP20
Heat emission	50J/s
A-weighted noise level, measured at 1 m distance	<70 dB
EMC class Class	B

##### Electrical Connections and Interfaces

Power supply	Power socket
Electrical Connections	Leica VT1200 control panel, Leica VibroCheck, Foot switch

##### Mechanical Connections

Interfaces to other devices	Magnifier, Microscope, Module LED Hi-Power spots, 2-arm, Module Hi-Power spot, LED 1000, Blade holder
-----------------------------	---

##### Other Specifications

Sectioning frequency ( $\pm 10\%$ )	85 Hz ( $\pm 10\%$ )
Amplitude	from 0 - 3 mm, in 0.05 mm increments

Cutting range	45 mm (adjustable)
Specimen orientation, rotating	360 °
Specimen plate, swiveling	0 - 10 °
Electrical overload protection	Yes
Internal current limit for the electronics	Yes
Height with magnifier support	600 mm x 250 mm x 320 mm
Height with microscope	600 mm x 250 mm x 469 mm
L x W x H control unit (when the bases are folded in)	165 mm x 120 mm x 72 mm
Control unit	1 kg
Magnifier support	2 kg
Microscope support with stereomicroscope	4.3 kg
CE	Yes
CSA	Yes
Sectioning speed ( $\pm 10\%$ )	0.01 - 1.5 mm/s
Return speed ( $\pm 10\%$ )	2.5 mm/s
Total vertical specimen stroke	20 mm (motorized)
Specimen retraction	0 - 100 $\mu\text{m}$ (adjustable; can be deactivated)
Maximum specimen size: with standard knife holder	33 x 50 mm
Section thickness selection	manual in 1 $\mu\text{m}$ increments

### 3.1.1 Technical data for the Leica VT1200 S

#### Electrical Specifications

Nominal supply voltage	100 V - 240 V
Nominal supply frequencies	50/60 Hz
Mains supply voltage fluctuations	Not to exceed $\pm 10\%$ of the nominal supply voltage
Power consumption	50 VA
Mains input fuses	2x T1.0A L 250VAC

#### Dimensions and Weight Specification

Overall size of device in operating mode (Width x Depth x Height, mm)	600 mm x 250 mm x 230 mm
Overall size serial packaging (Width x Depth x Height, mm)	740 mm x 491 mm x 669 mm
Empty weight (without accessories, kg)	56 kg
Overall weight (with accessories, kg)	63.3 kg
Device weight including packaging (kg)	88.5 kg

#### Environmental Specification

Operating altitude (meters)	up to 2000 m above sea level
Temperature (operation) (min/max)	min. +10 °C to max. +35 °C
Relative humidity (operation) (min/max)	max. 60 %
Temperature (transit) (min/max)	-29 °C to +50 °C
Temperature (storage) (min/max)	+5 to +55 °C
Relative humidity (transit/storage)	< 60 %

Operating noise level	<70 dB
<b>Emissions and Boundary Conditions</b>	
Overvoltage category to IEC 61010-1	II
Pollution degree to IEC 61010-1	2
Means of protection to IEC 61010-1	Class I
Degree of protection to IEC 60529	IP20
Heat emission	50J/s
A-weighted noise level, measured at 1 m distance	<70 dB
EMC class Class	B
<b>Electrical Connections and Interfaces</b>	
Power supply	Power socket
Electrical Connections	Leica VT1200 S control panel, Leica VibroCheck, Foot switch
<b>Mechanical Connections</b>	
Interfaces to other devices	Magnifier, Microscope, Module LED Hi-Power spots, 2-arm, Module Hi-Power spot, LED 1000, Blade holder
<b>Other Specifications</b>	
Sectioning frequency ( $\pm 10\%$ )	85 Hz ( $\pm 10\%$ )
Amplitude	from 0 - 3 mm, in 0.05 mm increments
Cutting range	45 mm
Sectioning window	0.5 mm - 45 mm
Specimen orientation, rotating	360 °
Specimen plate, swiveling	0 - 10 °
Electrical overload protection	Yes
Internal current limit for the electronics	Yes
Height with magnifier support	600 mm x 250 mm x 320 mm
Height with microscope	600 mm x 250 mm x 469 mm
L x W x H control unit (when the bases are folded in)	190 mm x 150 mm x 72 mm
Control unit	1 kg
Magnifier support	2 kg
Microscope support with stereomicroscope	4.3 kg
CE	Yes
CSA	Yes
Sectioning speed ( $\pm 10\%$ )	0.01 - 1.5 mm/s
Return speed ( $\pm 10\%$ )	1.0 - 5 mm/s, in increments of 0.5 mm/s
Total vertical specimen stroke	20 mm (motorized)
Specimen retraction	0 - 100 $\mu\text{m}$ (adjustable; can be deactivated)
Maximum specimen size: with standard knife holder	33 x 50 mm
Section thickness selection	manual in 1 $\mu\text{m}$ increments or automatic max. 1000 $\mu\text{m}$

### 3 Instrument characteristics

#### 3.2 General overview – Leica VT1200 / Leica VT1200 S



Fig. 1

## Attachments on dovetail receptacle



Fig. 2

- |                                    |   |
|------------------------------------|---|
| 1 Basic instrument                 | 12 Buffer tray, plastic                           |
| 2 Cutting head                     | 13 Buffer tray, metal                             |
| 3 Blade holder                     | 14 Specimen plate for specimens 1 cm in height    |
| 4 Magnifier                        | 15 Specimen plate for specimens 2 cm in height    |
| 5 Microscope                       | 16 Specimen plate, directional                    |
| 6 Module LED Hi-Power spots, 2-arm | 17 Cyanoacrylate adhesive                         |
| 7 Module Hi-Power spot, LED 1000   | 18 Double-walled buffer tray                      |
| 8 Foot switch                      | 19 Julabo FL300 (recirculating cooler/chiller)    |
| 9 Leica VT1200 control panel       | 20 VibroCheck                                     |
| 10 Leica VT1200 S control panel    | 21 Blades for the blade holder:<br>Sapphire blade |
| 11 Ice tray                        |   |



## 3 Instrument characteristics

### 3.3 Leica VT1200 control Panel

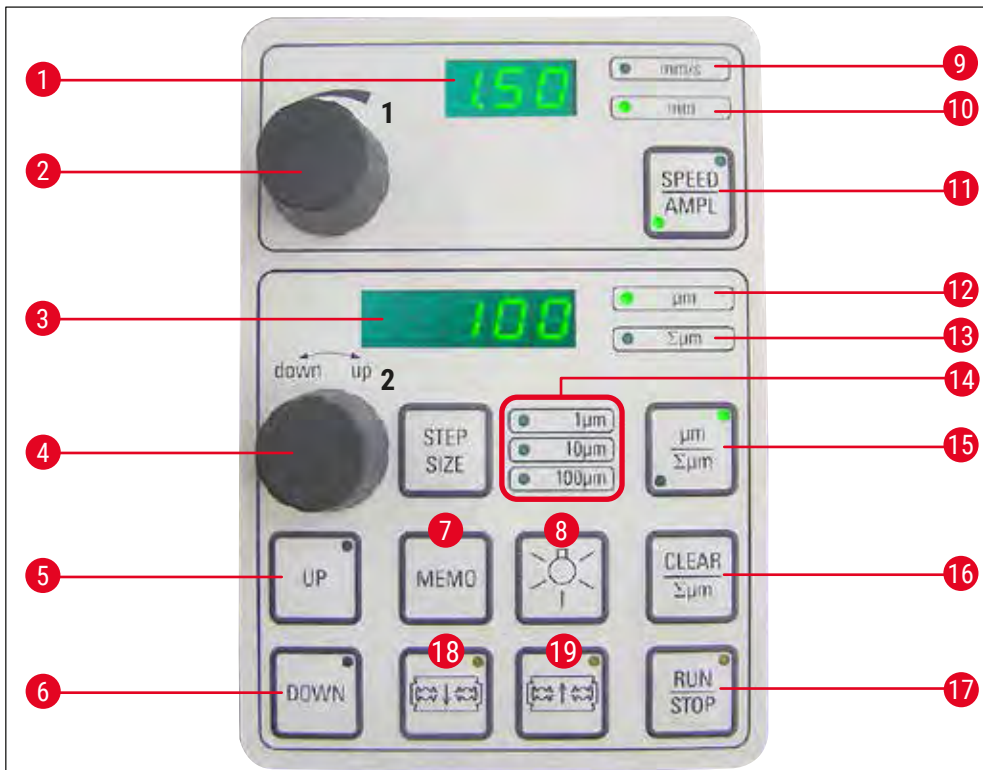

Fig. 3

- |  |   |
|--|---|
| <p>1 LED display for blade feed rate and amplitude</p> <p>2 Setting dial 1, for blade feed rate and amplitude</p> <p>3 LED display for section thickness and section thickness totalizing</p> <p>4 Setting dial 2, for section thickness and moving the specimens vertically</p> <p>5 Quickly moves the specimen upwards (press the button until the desired position is reached)</p> <p>6 Quickly moves the specimen downwards (press once to adjust to the lowest position)</p> <p>7 Press this button (for approx. 3 sec.) to save a frequently used feed value (pressing it more than once feeds by the saved section thickness multiple times)</p> <p>8 ON/OFF lamp</p> <p>9 LED for feed rate</p> <p>10 LED on, for enabled amplitude adjustment</p> | <p>11 Toggles between <b>SPEED</b> (blade feed rate) and <b>AMPL</b> (amplitude)</p> <p>12 Section thickness</p> <p>13 Sets the current specimen position between 0 (lower) and 20,000 <math>\mu\text{m}</math> (upper) or - after zero, totals the section thicknesses</p> <p>14 Selection of the step size, 1 <math>\mu\text{m}</math>, 10 <math>\mu\text{m}</math> or 100 <math>\mu\text{m}</math> steps</p> <p>15 Pressing this button toggles between <math>\mu\text{m}</math> and <math>\Sigma\mu\text{m}</math> (actively illuminated)</p> <p>16 Resets the totalized section thickness display <math>\Sigma\mu\text{m}</math> to zero.</p> <p>17 Immediately starts or stops the sectioning process</p> <p>18 Moves the blade towards the specimen</p> <p>19 Moves the blade away from the specimen</p> <p><b>CAUTION:</b> Keep it pressed down until the desired position is reached. When the end position is reached, the LED lights up.</p> |
|--|---|



**Note**

The Leica VT1200 is a semiautomatic microtome with a vibrating blade. Before each cut, a manual feed to the desired section thickness must be carried out using the setting dial for section thickness. The Leica VT1200 does not include an automatic specimen retraction; however, retraction can be performed manually.

**3.3.1 Leica VT1200 S control panel**

Fig. 4

- |  |  |
|--|--|
| <p>1 Sets the blade feed rate. Select the values using setting dial 1.</p> <p>2 Setting dial 1, for blade feed rate (<b>SPEED</b>), <b>AMPL</b>itude or section thickness for automatic mode (<b>AUTO FEED</b>)</p> <p>4 Setting dial 2, for section thickness and moving the specimens vertically</p> <p>5 Moves the specimen upwards (as long as the button is pressed). When the uppermost position is reached, the LED lights up.</p> <p>6 Moves the specimen into the lowest position, (LED is illuminated when the lowest position is reached)</p> | <p>7 First cutting window edge, LED illuminates when the window edge is set</p> <p>8 Second cutting window edge, LED illuminates when the window edge is set</p> <p>9 Possible in automatic sectioning mode only. Select the desired section thickness for the automatic feed using setting dial 1.</p> <p>10 ON/OFF lamp</p> <p>11 Sets the amplitude. Select the values using setting dial 1.</p> <p>12 Toggles between automatic (<b>AUTO</b>) and semiautomatic (<b>MAN</b>) sectioning mode</p> |
|--|--|

- 13** Interrupts the sectioning process in automatic mode. Pressing the button again reactivates the sectioning process.
- 14** Selection of the step size, 1  $\mu\text{m}$ , 10  $\mu\text{m}$  or 100  $\mu\text{m}$  steps
- 15** Toggling between single stroke (**SINGLE**) and continuous stroke (**CONT**) in automatic mode is possible. In semiautomatic mode, only single stroke (**SINGLE**) is possible.
- 16** Sets the totalized section thickness display  $\Sigma\mu\text{m}$  to 0
- 17** Starts or stops the sectioning process. In semiautomatic mode, the sectioning process stops immediately; in automatic mode, the sectioning process is finished completely.
- 18** Moves the blade towards the specimen
- 19** Moves the blade away from the specimen
- CAUTION:** Keep it pressed down until the desired position is reached. When the end position is reached, the LED lights up.

**Note**

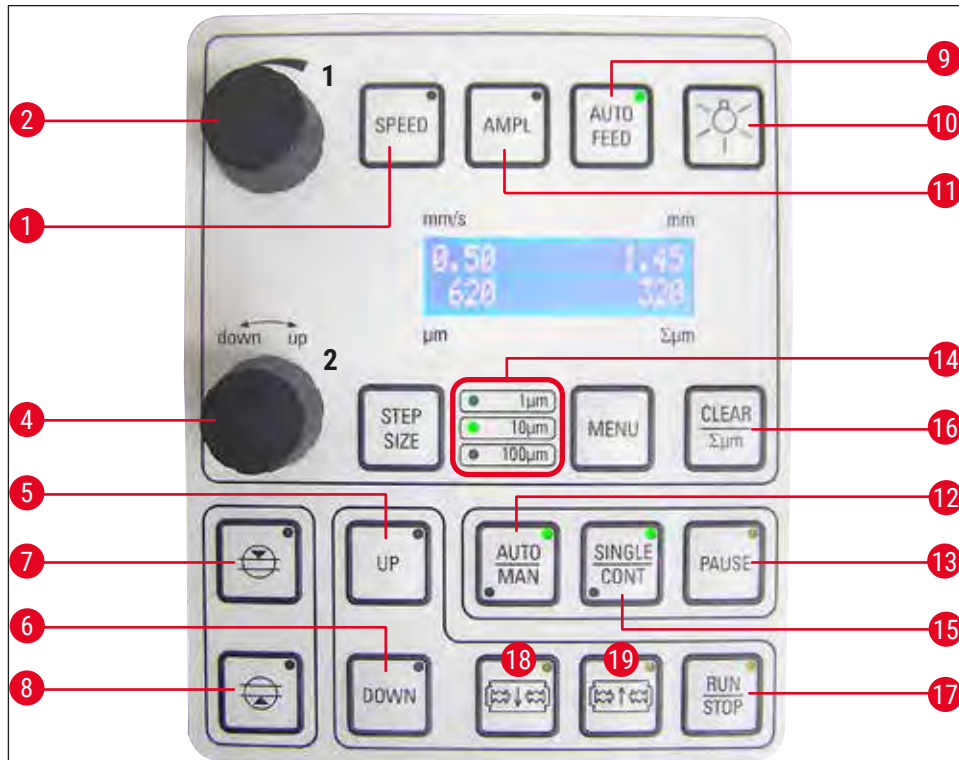
The Leica VT1200 S is a fully automatic microtome with vibrating blade. It can be operated in automatic as well as semiautomatic sectioning mode.

In semiautomatic sectioning mode, a manual feed to the desired section thickness must be carried out before each cut. There is no automatic specimen retraction in this mode; however, retraction can be performed manually.

In automatic mode, an automatic feed (**AUTO FEED**) to the selected section thickness is carried out before each cut, and the specimen is lowered to the desired retraction value after each cut to prevent the specimen surface and the blade from coming into contact while the blade is being retracted.

## 4. Installation

### 4.1 Standard scope of delivery for the Leica VT1200

Qty.		Part No.
1	Leica VT1200 basic instrument	14 0481 42065
1	Control panel	14 0481 43395
1	Tool set – consisting of:	
1	Allen key, size 3.0	14 0194 04764
1	Allen key, size 6.0	14 0222 04141
1	Cryo-manipulator	14 0462 28930
1	Replacement fuse T 1 A	14 6943 01000
1	Dust cover (basic instrument), small	14 0212 43742
1	Bottle of cyanoacrylate adhesive, contents 10 gr	14 0371 27414
1	Instructions for Use printed (English, with Language CD 14 0481 80200)	14 0481 80001
<b>Leica VT1200 configuration</b>		14 9120 00001
The above scope of delivery, plus:		
	Ice tray, assembly	14 0481 42010
	Buffer tray (metal), assembly	14 0481 42084

If the supplied local power cord is defective or lost, please contact your local Leica Biosystems representative.



#### Note

When ordering additional accessories, compare the parts received with the parts ordered. If the parts received do not match your order, contact the sales company responsible for your order immediately.

### 4.1.1 Standard scope of delivery for the Leica VT1200 S

Qty.		Part No.
1	Leica VT1200 S basic instrument	14 0481 42066
1	Control panel	14 0481 43396
1	Tool set – consisting of:	
1	Allen key, size 3.0	14 0194 04764
1	Allen key, size 6.0	14 0222 04141
1	Cryo-manipulator	14 0462 28930
1	Replacement fuse T 1 A	14 6943 01000
1	Dust cover (basic instrument), small	14 0212 43742
1	Bottle of cyanoacrylate adhesive, contents 10 gr	14 0371 27414
1	Instructions for Use printed (English, with Language CD 14 0481 80200)	14 0481 80001

## 4 Installation

Qty.	Part No.
<b>Leica VT1200 S configuration</b>	14 9120 0S001
The above scope of delivery, plus:	
Ice tray, assembly	14 0481 42010
Buffer tray (metal), assembly	14 0481 42084

If the supplied local power cord is defective or lost, please contact your local Leica Biosystems representative.



### Note

When ordering additional accessories, compare the parts received with the parts ordered. If the parts received do not match your order, contact the sales company responsible for your order immediately.

### 4.2 Packing and setting up the instrument



### Note

Ensure that the instrument is standing on a work surface that is as free of vibrations as possible.

Before each transport, the handles must be screwed onto the instrument using the provided screws (→ Fig. 9). Check to ensure that the handles are firmly in place and will hold reliably!

### Packing the instrument

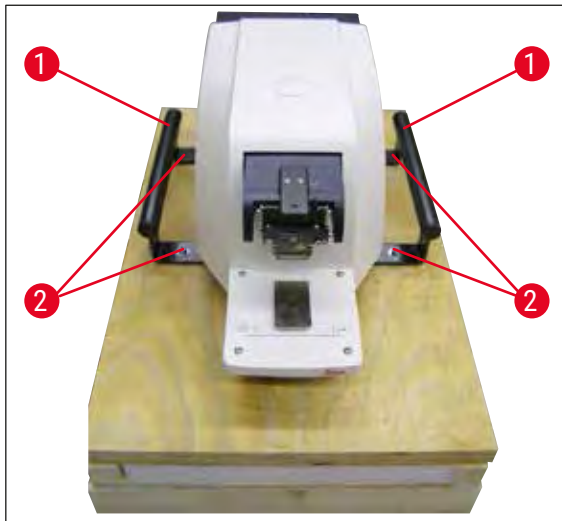

Fig. 5

1. Have 2 people grab the instrument by the transport handles (→ Fig. 5-1), place it on the wooden pallet and screw it to the pallet using the 4 size 6 Allen screws (→ Fig. 5-2).
2. Pull the transparent protective hood (→ Fig. 6-3) over the instrument. Place the wooden box (→ Fig. 6-4) on the baseplate. Insert the inner carton ring (→ Fig. 7-5).

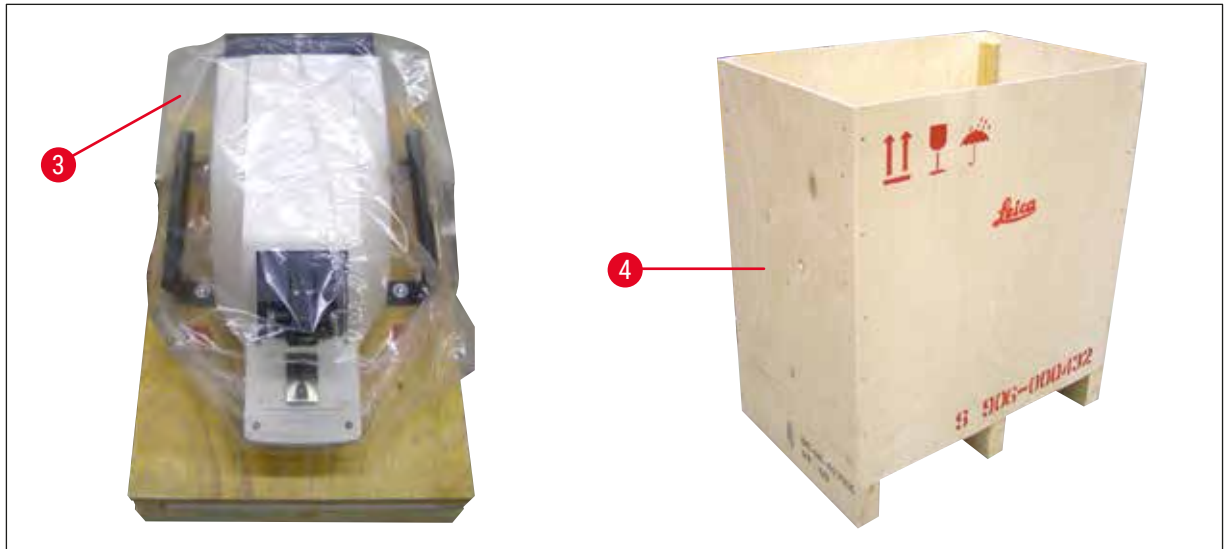

Fig. 6



Fig. 7

3. Insert the accessories box (→ Fig. 7-6) – contains accessories) and fill it with packing material (→ Fig. 8-7).

## 4 Installation

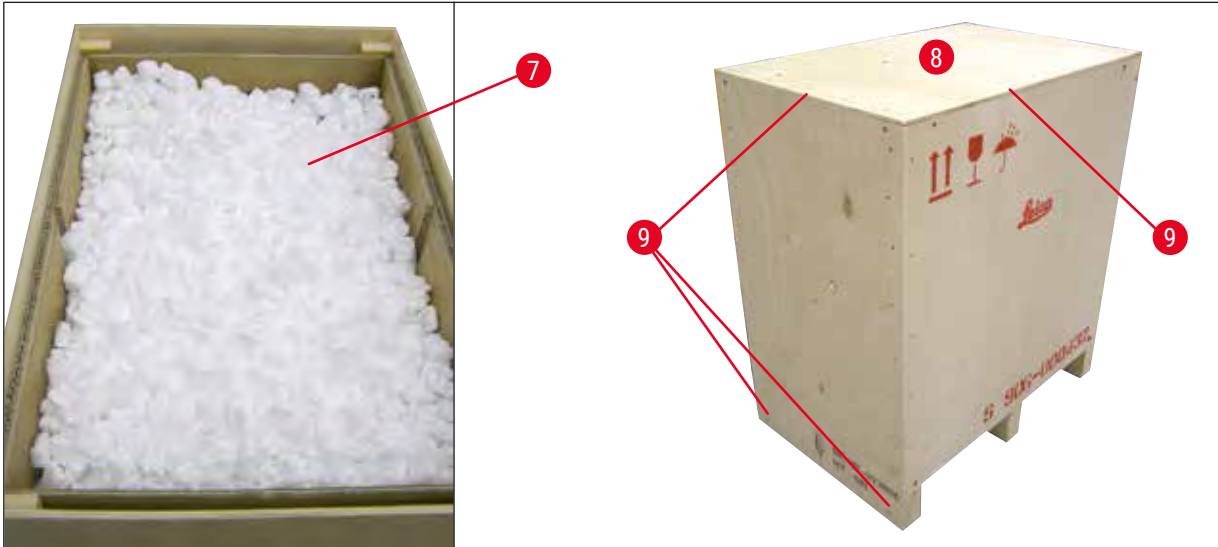

Fig. 8

4. Attach the cover (→ Fig. 8-8) and screw it into place using 8 Phillips screws (→ Fig. 8-9).

### 4.3 Before commissioning the instrument



Fig. 9

Once the instrument is in its final location, unscrew the transport handles (→ Fig. 9-1) from the instrument using the size 6 Allen key provided and store them, along with the screws, in a safe place.



Fig. 10

1. Set the power switch (→ Fig. 10-3) on the right side of the instrument to **OFF** (0).
2. Make sure the power cable is correctly connected in the power socket (→ Fig. 10-2) on the right side of the instrument.
3. Connect the control panel to the socket (→ Fig. 10-4).
4. Install the ice tray (→ Fig. 10-5).
5. Install the buffer tray (→ Fig. 10-6).
6. Install any optional accessories, such as the magnifier, microscope, foot switch, etc. according to (→ p. 53 – 9.1 Extension accessories for standard specimens).
7. Use the power switch (→ Fig. 10-3) to switch on the instrument.

**Note**

To make it easier to insert the specimen, adjust the specimen receptacle to its lowest position, and adjust the blade holder to its rearmost position during the first reference run.

## 5. Working with the Instrument

### 5.1 Description of the typical application

The Leica VT1200 / Leica VT1200 S is a microtome with a vibrating blade and is predominately used for sectioning fixed and unfixed specimens during neurological research.

1. To simplify the process of inserting the specimen, you can quickly move the specimen receptacle to the lowest position by pressing the **DOWN** key.
2. To prepare high-quality sections, especially for unfixed tissue, Leica suggests using the optional VibroCheck measuring instrument to determine the height amplitude of the blade after each blade change, and then to minimize it using the setting screw on the blade holder.  
To perform the aforementioned process, install the VibroCheck instrument (see (→ p. 41 – 6.1 Using the VibroCheck with the Leica VT1200) for the Leica VT1200 or (→ p. 43 – 6.2 Using the VibroCheck with the Leica VT1200 S) for the Leica VT1200 S), install the blade and adjust the clearance angle to the desired position. Then take the measurement and make the appropriate adjustments to the placement of the blade holder.  
Remove the VibroCheck according to the instructions, and turn the blade 90° toward the top to ensure that the ice tray and buffer tray can be installed safely.
3. Insert the buffer tray into the ice tray and cover it with the lid. Fill the ice tray with crushed ice.
4. Remove the cover and fill the buffer tray with pre-cooled physiological buffer.
5. Push the ice tray and buffer tray onto the dovetail guide and clamp them down.
6. Use cyanoacrylate adhesive to adhere the specimen to the specimen plate and use a manipulator to place it in the buffer tray. Insert the hose for gassing the buffer into the hose clamp.
7. Use the **UP** key to lift the specimen to the sectioning level of the blade quickly. Fineadjusting the blade-to-specimen proximity can be performed using the desired step size 1, 10 or 100 µm.
8. Advance the blade toward the specimen using the **Blade forward** key.
9. After sectioning the specimen, use the setting dial to feed to the desired section thickness using the selected step size (1, 10 or 100 µm). This raises the specimen receptacle to the desired value.
10. Start the sectioning process by pressing the **RUN/STOP** key. The process can be stopped again by pressing this key after the cut has been completed. Use the **Blade back** key to move the blade in front of the specimen. Select the section thickness for the next cut and start the sectioning process again.
11. After completing the sectioning process, remove the blade, dispose of the specimen receptacle by pushing the **DOWN** key into its lowest position, and unclamp, empty and clean out the ice tray and buffer tray.



## 5.2 Control elements on the Leica VT1200 control panel



### Warning

To practice the key functions, always make sure there are no blades installed! Do not install the blades until you are familiar with all of the key functions.



Switch on the instrument.  
0 = on I = off

When the instrument is switched on, to make it easier to insert a specimen, the specimen receptacle automatically moves into the lowest position (the LED in the **DOWN** key lights up) and the blade holder moves into the rearmost position (the LED in **Blade back** from the specimen lights up).

The parameters last used before switching off the instrument: The blade feed rate (**SPEED**), selected amplitude (**AMPL**) and section thickness saved by the **MEMO** key are called up again.

The LED illumination is switched on automatically. You can switch it off using the **ON/OFF** switch (lamp symbol).

### 5.2.1 Moving the specimen receptacle vertically



When the **DOWN** key is pressed, the specimen receptacle automatically moves quickly into the lowest position. (The LED in the **DOWN** key lights up when the lower end position is reached.) The  $\Sigma\mu\text{m}$  display is set to 0. If the **DOWN** key is pressed a second time while the specimen receptacle is moving downwards, the specimen receptacle comes to a stop. The current position appears on the  $\Sigma\mu\text{m}$  display (lowest position = 0). The  $\Sigma\mu\text{m}$  display does not change while the specimen receptacle is in motion.



When the **UP** key is pressed and held, the specimen receptacle moves quickly upwards into the desired position. After the **UP** key has been released, the current position of the specimen receptacle appears on the  $\Sigma\mu\text{m}$  display. If the specimen receptacle reaches the upper end position, the LED in the **UP** key lights up (uppermost position = 20,000  $\mu\text{m}$ ). The  $\Sigma\mu\text{m}$  display does not change while the specimen receptacle is in motion.



You can reset the display for the current position of the specimen holder to zero at any point using the **CLEAR/ $\Sigma\mu\text{m}$**  key. The section thicknesses are then added in the  $\Sigma\mu\text{m}$  display.

### 5.2.2 Fine-adjusting the blade-to-specimen proximity and feeding to the section thickness



The rotary knob 2 for moving the specimen receptacle vertically can be used both for fine-adjusting the blade-to-specimen proximity and for adjusting the desired section thicknesses. The step size: 1, 10 or 100  $\mu\text{m}$  can be selected by pressing the **STEP SIZE** key.

Turning the setting dial clockwise carries out the desired feed; turning the setting dial counterclockwise lowers the specimen (minus sign). The value appears in the lower display when  $\mu\text{m}$  is selected. After each sectioning process has been completed, the  $\mu\text{m}$  display is set to zero.



Save a commonly used section thickness by adjusting the setting dial for the section thickness and pressing the **MEMO** key for 3 seconds. An audible signal confirms that the value has been accepted.

Feed to the saved value by quickly pressing the **MEMO** key. Pressing the **MEMO** multiple times feeds to the value multiple times.



#### Note

Neither negative values nor a section thickness of over 1000  $\mu\text{m}$  are permitted. If an attempt is made to save impermissible values, an audible warning signal sounds three times and the last (permissible) value is retained.

### 5.2.3 Moving the blade



forward



back

The **Blade forward** and **Blade back** keys have to be held down until the desired position is reached. The blade feed rate is 2.5 mm/s. When each end point has been reached, the corresponding LED lights up in the key.

### 5.2.4 Selecting the sectioning parameters



#### SPEED

Blade feed rate – upper display – LED mm/s. The desired blade feed rate can be adjusted from 0.01 to 1.5 mm/s using rotary knob 1:

0.01 - 0.1	in	0.01 mm/s increments
0.10 - 0.5	in	0.02 mm/s increments
0.50 - 1.5	in	0.10 mm/s increments

#### AMPL

Upper display – LED mm: Display of the amplitude in mm:

from	0 - 3	in	0.05 mm/s increments
------	-------	----	----------------------

### Starts the sectioning process







Starts the sectioning process using the selected amplitude and blade feed rate. You can start the sectioning process by pressing the **RUN/STOP** key a second time, or you can stop the process immediately by pressing the **Blade back** or **Blade forward** key. The  $\mu\text{m}$  display is then reset to 0.



To start a new sectioning process, use the **Blade back** key to move the blade to the beginning of the specimen, set the desired section thickness and restart the sectioning process.



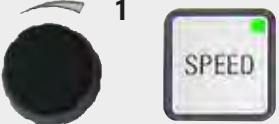
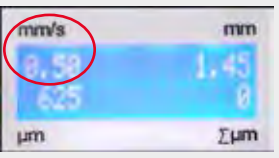
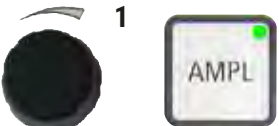
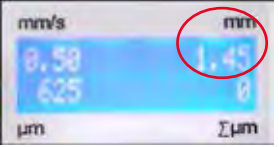
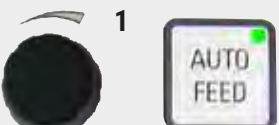
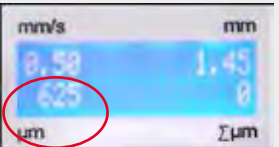

### 5.3 Control elements on the Leica VT1200 S control panel

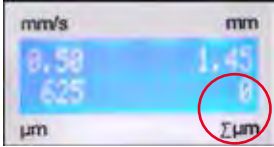
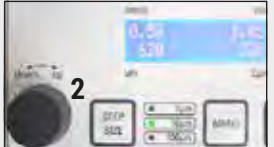



The Leica VT1200 S is a fully automatic microtome with a vibrating blade that can be operated in semiautomatic or automatic sectioning mode.





Key/setting dial	Semiautomatic sectioning mode	Automatic sectioning mode
 <p>Switch on the instrument. O = on   = off</p>	<p>When the instrument is switched on, to make it easier to insert a specimen, the specimen receptacle automatically moves into the lowest position (the LED in the <b>DOWN</b> key lights up) and the blade holder moves into the rearmost position (the LED in <b>Blade back</b> from the specimen lights up).</p> <p>If semiautomatic sectioning mode was selected before the instrument was last switched off, the following saved parameters are called up again once it is switched back on: Blade feed rate (<b>SPEED</b>), Selected amplitude (<b>AMPL</b>)</p>	<p>ditto</p> <p>Blade feed rate (<b>SPEED</b>), Selected amplitude (<b>AMPL</b>) Saved section thickness (<b>AUTO FEED</b>)</p>
	<p>The LED illumination is switched on automatically. You can switch it off using the <b>ON/OFF</b> switch.</p>	<p>ditto</p>
	<p>The LED <b>MAN</b> is active. The semiautomatic sectioning mode is enabled.</p> <p>In semiautomatic sectioning mode, before each cut, a manual feed to the desired section thickness must be carried out using the setting dial for section thickness.</p> <p>There is no automatic specimen retraction in this mode; however, retraction can be performed manually.</p>	<p>The LED <b>AUTO</b> is active. The automatic sectioning mode is enabled.</p> <p>In automatic mode, the selected section thickness feed (<b>AUTO FEED</b>) is carried out along the 1st selected cutting window edge automatically before each cut. To prevent the specimen surface and the blade from coming into contact while the blade is being retracted, the specimen is lowered by the desired retraction value along the 2nd cutting window edge after each complete cut.</p>

Key/setting dial	Semiautomatic sectioning mode	Automatic sectioning mode
<p><b>Toggle from <u>AUTO</u> to <u>MAN</u></b></p> 	<p>The following key functions are disabled in semiautomatic mode:</p> <ul style="list-style-type: none"> <li>• Setting cutting window edges</li> <li>• Selecting the continuous stroke (<b>CONT</b>)</li> <li>• Selecting the section thickness for the automatic feed (<b>AUTO FEED</b>)</li> <li>• <b>PAUSE</b> not active.</li> </ul>	
<p><b>Toggle from <u>MAN</u> to <u>AUTO</u></b></p> 	<p>An audible warning signal sounds when these keys are pressed.</p>	<p>The following functions keys become enabled again in automatic mode:</p> <ul style="list-style-type: none"> <li>• Cutting window edges that have already been set</li> <li>• Section thickness (<b>AUTO FEED</b>) and continuous stroke (<b>CONT</b>)</li> </ul>
<p><b>1</b></p>  	<p>The blade feed rate can be adjusted from 0.01 to 1.5 mm/s:</p> <p>0.01 - 0.1 in 0.01 mm/s increments, 0.10 - 0.5 in 0.02 mm/s increments, 0.50 - 1.5 in 0.10 mm/s increments.</p>	ditto
<p><b>1</b></p>  	<p>Adjusting the amplitude from 0 to 3 mm in 0.05 mm increments</p>	ditto
<p><b>1</b></p>  	<p>Not possible.</p>	<p>Setting the section thickness for automatic mode – max. 1000 μm.</p>



Key/setting dial	Semiautomatic sectioning mode	Automatic sectioning mode
 <b>1</b> 	<p>Display for the current specimen holder position (lowest position = 0 µm, uppermost position = 20,000 µm.)</p> <p>You can reset the display to <b>0</b> at any point by pressing the <b>CLEAR/Σµm</b> key. The section thicknesses are then added in the Σµm display.</p>	ditto
 <b>2</b>	<p>The rotary knob for moving the specimen receptacle vertically can be used for fine-adjusting the blade-to-specimen proximity. Turning the setting dial clockwise moves the specimen up into the desired proximity; turning the setting dial counterclockwise lowers the specimen (minus sign).</p> <p>The step size: 1, 10 or 100 µm can be selected by pressing the <b>STEP SIZE</b> key.</p> <p>After the setting dial is turned clockwise or counterclockwise, the specimen receptacle position is updated in the Σµm display.</p> <p>In semiautomatic mode, the desired section thickness is selected using the setting dial.</p> <p>The selected section thickness appears in the µm display and the current specimen receptacle position appears in the Σµm display.</p> <p>After each sectioning process has been completed, the µm display is set to <b>0</b>.</p>	ditto
	<p>When the <b>DOWN</b> key is pressed, the specimen receptacle automatically moves quickly into the lowest position. (The LED in the <b>DOWN</b> key lights up when the lower end position is reached.) The Σµm display is set to <b>0</b>.</p>	ditto

Key/setting dial	Semiautomatic sectioning mode	Automatic sectioning mode
	If the <b>DOWN</b> key is pressed a second time while the specimen receptacle is moving downwards, the specimen receptacle comes to a stop and the current position appears on the $\Sigma\mu\text{m}$ display (lowest position = 0, uppermost position = 20,000 $\mu\text{m}$ ). The $\Sigma\mu\text{m}$ display does not change while the specimen receptacle is in motion.	ditto
	When the <b>UP</b> key is pressed and held down, the specimen receptacle moves quickly upwards into the desired position. After the <b>UP</b> key has been released, the current position of the specimen receptacle appears on the $\Sigma\mu\text{m}$ display. If the specimen receptacle reaches the upper end position, the LED in the <b>UP</b> key lights up (uppermost position = 20,000 $\mu\text{m}$ ). The $\Sigma\mu\text{m}$ display does not change while the specimen receptacle is in motion.	ditto
 Blade forward  Blade back	The <b>Blade forward</b> and <b>Blade back</b> keys have to be held down until the desired position is reached. The blade feed rate can be set in the menu: 1 - 5 mm/s, in increments of 0.5 mm/s. Each time an end point is reached, the corresponding LED lights up in the key.	ditto

Key/setting dial	Semiautomatic sectioning mode	Automatic sectioning mode
General information about the cutting window	Not possible.	The horizontal cutting path can be reduced to the specimen size. The two cutting window edges can be adjusted and changed <b>INDEPENDENTLY</b> . Holding the key down for a longer duration (audible warning signal) sets the beginning or end (depending on the key) of the cutting window to the maximum value.  Smallest possible sectioning window: 0.5 mm. If a window smaller than 0.5 mm is set or the user reverses the beginning and end, the last entered value is accepted and the previous value is set to the maximum value. The cutting window is not saved when the instrument is switched off; however, it is retained when you switch from automatic mode ( <b>AUTO</b> ) to semiautomatic mode ( <b>MAN</b> ).
 <b>Note</b>	Activated cutting window edges can be deactivated by pressing the corresponding key for approx. three seconds.	
	Not possible.	Advance the blade toward the specimen using the <b>Blade forward</b> key. Press the <b>1st cutting window edge</b> key until the LED in the key lights up.
	Not possible.	Advance the blade to the end of the specimen using the <b>Blade forward</b> key and press <b>2nd cutting window edge</b> until the LED in the key lights up.
	Only single stroke ( <b>SINGLE</b> ) is possible. If an attempt is made to switch to continuous stroke ( <b>CONT</b> ), an audible warning signal sounds.	Toggles between single ( <b>SINGLE</b> ) and continuous stroke ( <b>CONT</b> ). The corresponding LED lights up to indicate the current selection.

Key/setting dial	Semiautomatic sectioning mode	Automatic sectioning mode
	Starts the sectioning process using the selected amplitude ( <b>AMPL</b> ) and blade feed rate ( <b>SPEED</b> ). Pressing the <b>RUN/STOP</b> key a second time stops the sectioning process immediately.  The $\mu\text{m}$ display is then reset to 0.	Starts the sectioning process using the selected section thickness ( <b>AUTO FEED</b> ) amplitude ( <b>AMPL</b> ) and the blade feed rate ( <b>SPEED</b> ). If single stroke ( <b>SINGLE</b> ) is selected, only one sectioning process is carried out. If continuous stroke ( <b>CONT</b> ) is selected, a continuous sectioning process takes place. Pressing the <b>RUN/STOP</b> key a second time stops the sectioning process that is in progress. The blade moves to the 1st cutting window edge and stays there.  The programmed section thickness ( <b>AUTO FEED</b> ) appears in the $\mu\text{m}$ display continuously.
	Not possible.	A sectioning process in progress can be interrupted immediately by pressing the <b>PAUSE</b> key and restarted by pressing the <b>PAUSE</b> key again. If <b>PAUSE</b> has been pressed to interrupt a sectioning process, pressing the <b>RUN/STOP</b> key or the <b>Blade forward</b> or <b>Blade back</b> keys discontinues the sectioning process.
	Press the <b>MENU</b> key.	ditto
	8 sets of user parameters can be saved;  Current user selection – User 1: turn rotary knob 2 clockwise, then press <b>MENU</b> again.	

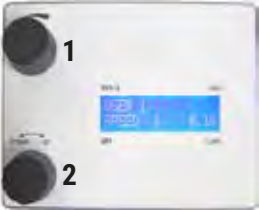







Key/setting dial	Semiautomatic sectioning mode	Automatic sectioning mode
	The blade feed rate ( <b>SPEED</b> ) can be set from 0 to 1.5 mm/s using rotary knob 1.	
	->Rotary knob 2	
	The amplitude ( <b>AMPL</b> ) can be set to 0 - 3 mm using rotary knob 1.	
	->Rotary knob 2	
	The automatic section thickness feed ( <b>AUTO FEED</b> ) can be adjusted using predefined step sizes (1, 10 or 100 µm) max. 1000 µm using rotary knob 1.	



**Note**

The values can be selected; however, automatic feed is not possible in semiautomatic sectioning mode. If the **AUTO FEED** key is pressed, one feed motion takes place according to the value programmed in automatic mode. If the key is pressed more than once, several feed motions take place.

	->Rotary knob 2 Mode: Choice between <b>AUTO</b> and <b>MAN</b> with rotary knob 1; for semiautomatic sectioning mode, <b>MAN</b> must be selected.	->Rotary knob 2 Mode: Choice between <b>AUTO</b> and <b>MAN</b> with rotary knob 1; for the automatic sectioning mode, <b>AUTO</b> must be selected.
	->Rotary knob 2 Stroke type ( <b>CUT</b> ): Only single stroke ( <b>SINGLE</b> ) can be selected using rotary knob 1. If continuous stroke ( <b>CONT</b> ) is selected, an audible warning signal sounds.	->Rotary knob 2 Stroke type ( <b>CUT</b> ): Choice between single stroke ( <b>SINGLE</b> ) and continuous stroke ( <b>CONT</b> ) with rotary knob 1.

Key/setting dial	Semiautomatic sectioning mode	Automatic sectioning mode
	<p>-&gt;Rotary knob 2</p> <p>Specimen retraction (<b>RETRACT</b>) cannot be set.</p> <p><b>Note: Value cannot be changed. NO automatic retraction is possible in semiautomatic sectioning mode.</b></p>	<p>-&gt;Rotary knob 2</p> <p>The specimen retraction (<b>RETRACT</b>) can be set from 0 to 100 <math>\mu\text{m}</math> in 10 <math>\mu\text{m}</math> increments using rotary knob 1.</p>
	<p>-&gt;Rotary knob 2</p> <p>The LED illumination can be adjusted to 5 different levels of brightness using rotary knob 1.</p>	ditto
	<p>-&gt;Rotary knob 2</p> <p>The feed rate (<b>FOR/REV</b>) for the <b>Blade forward</b> and the <b>Blade back</b> keys can be set between 1 and 5 mm/s in 0.5 mm/s increments with rotary knob 1.</p>	ditto
	<p>-&gt;Rotary knob 2</p> <p>Switches the vibration movement (<b>FOR/VIB</b>) of the <b>Blade forward</b> key either on or off using rotary knob 1.</p>	ditto
	<p>-&gt;Rotary knob 2</p> <p>Key acknowledgment (<b>BEEP</b>) on or off with rotary knob 1.</p>	ditto
	<p>Save the parameter and leave by pressing the <b>MENU</b> key.</p> <p><b>Note: Leaving the menu and saving the parameter is possible at any point in the menu.</b></p>	ditto



### Note

If you want to call up the parameters of a certain user (for example, user 3), press the **MENU** key and select **user 3**. Then confirm by pressing the **MENU** key 2x. The parameters stored under **user 3** are now enabled.

## 5.4 Installing the accessories

### 5.4.1 Installing the ice tray and buffer tray



Fig. 11

- A lever (→ Fig. 11-2), which needs to be pushed forward, is located on the underside of the ice tray (→ Fig. 11-1).
- Now push the tray onto the dovetail holder (→ Fig. 11-3) from the front. Clamp it down by pushing the lever (→ Fig. 11-2) towards the rear.



#### Note

The ice tray can be placed on the stage separately for preparation.

- Push the buffer tray (→ Fig. 12-5) in as far as it will go (small pins (→ Fig. 11-4) guide it at the side and front).  
It is held in place by three strong magnets, which are integrated into the bottom of the 2 buffer tray.

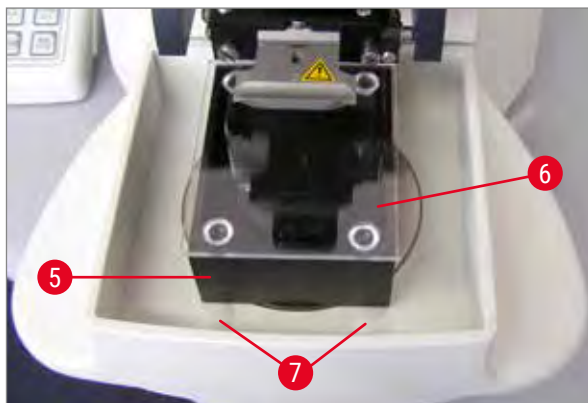

Fig. 12

- Cover the buffer tray (→ Fig. 12-5) with a Plexiglas lid (→ Fig. 12-6).
- Now fill the ice tray with crushed ice.
- Cover the buffer tray and fill it with cooled buffer solution.



#### Note

To remove the buffer tray from the ice tray, pull on the rounded edges (→ Fig. 12-7) carefully. They help to remove the tray, as they are not magnetic.

## 5 Working with the Instrument

### 5.4.2 Installing the double-walled buffer tray



Fig. 13

Clamps for holding the gassing hose for the buffer in the proper position can be added to the double-walled buffer tray.



#### Note

When using the double-walled buffer tray, the recirculating cooler/chiller must be installed **PRIOR TO** working with specimens.



Fig. 14

Connect hoses (→ Fig. 14-8), in the scope of delivery of the double-walled buffer tray) to the empty buffer tray (bottom of (→ Fig. 14)). Access is easier if you make the left connection first. To do this, pull back the closure coupling (→ Fig. 14-9), fit the hose until it engages audibly, and then make the right-hand connection.

### 5.4.3 Preparing a specimen



Fig. 15

- Fix the specimen to the specimen plate using the cyanoacrylate (included in the standard scope of delivery (→ p. 19 – 4.1 Standard scope of delivery for the Leica VT1200), (→ p. 19 – 4.1.1 Standard scope of delivery for the Leica VT1200 S)).
- Screw the manipulator (→ Fig. 15-10) onto the specimen plate, place it in the buffer tray and adjust it to the desired position.
- The specimen plate is held in place in the buffer tray magnetically.

### 5.4.4 Installing and removing the blade holder



#### Warning

Always remove the blade **BEFORE** installing or removing the blade holder!



#### Note

For quality and service reasons, the blade holder (→ Fig. 16-11) is available as a complete unit only.

## 5 Working with the Instrument

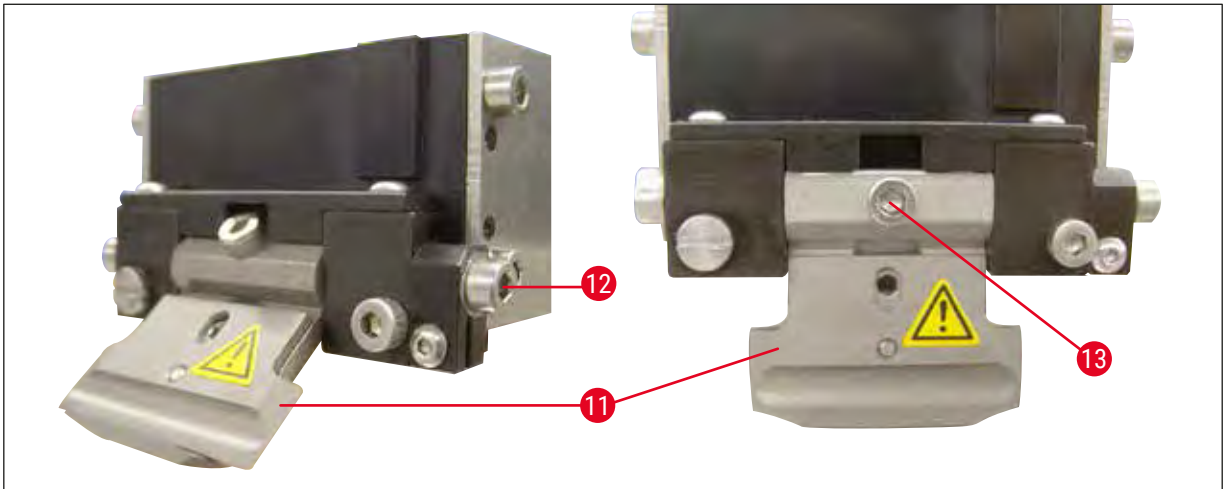

Fig. 16

- Before the blade holder can be replaced, it must be brought into a 45° inclined position. To do so, insert the size 3 Allen key sideways into the blade holder through the hole (→ Fig. 16-12) and rotate it 45° clockwise.
- Turning the screw (→ Fig. 16-13) counterclockwise releases the blade holder, allowing it to be replaced.
- The installation is carried out in reverse order.

### Cleaning the blade holder

To clean the blade holder after removal, spray it with alcohol. It can then be wiped down with a piece of cellulose and placed on a cellulose towel to dry completely.

## 5.4.5 Inserting the blade

**Note**

The blade holder can be used for razor blades, injector blades and sapphire blades (universal blade holder).



Fig. 17

- Insert a size 3 Allen key sideways into the blade holder through the hole (→ Fig. 17-12) and rotate it 90° clockwise.

Clamp the blade as follows:

1. Insert the provided size 3 Allen key from the top through the opening (→ Fig. 18-14) into the blade holder (→ Fig. 18-11) and open the blade holder (BH).
2. Hold the entire razor blade (→ Fig. 18-13) (not separated) on the left and right with both hands and insert it into the blade holder. Hook in the blade over bottom pressure plate (→ Fig. 18).
3. Clamp down the BH by turning the size 3 Allen key clockwise until hand-tight.

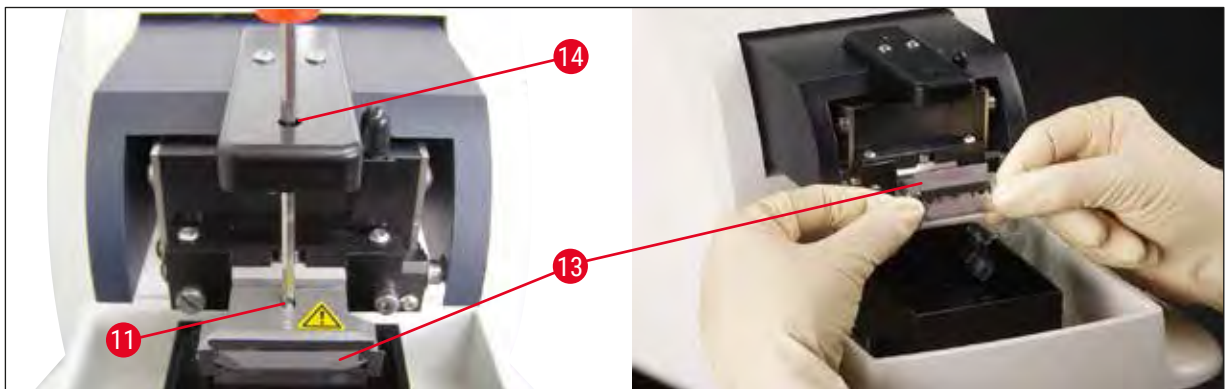

Fig. 18

**Warning**

The clamping screw (→ Fig. 18-11) on the blade holder must not be tightened too much!



## 5 Working with the Instrument

4. Now return the blade holder to the cutting position.
5. To do so, insert a size 3 Allen key sideways into the blade holder through the hole (→ Fig. 17-12) and rotate approx. 90° counterclockwise.

✓ For more information about adjusting the clearance angle, see (→ Fig. 19).

### 5.4.6 Adjusting the clearance angle

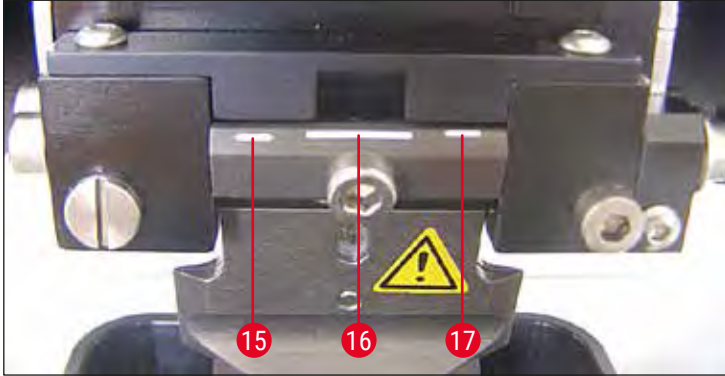

Fig. 19

15 15°    16 18°    17 21°

Insert a size 3 Allen key sideways into the blade holder through the hole (→ Fig. 17-12) and rotate it to the desired clearance angle mark.



#### Note

For 15°, the effective clearance angle is 0. The most commonly used setting is 18° (→ Fig. 19-16).

### 5.5 Routine daily maintenance and switching off the instrument – Leica VT1200 / Leica VT1200 S

After all daily procedures have been finished, perform the following:

- Switch off the power switch on the side of the instrument.
- Place the magnifier cover on the magnifier.
- Remove the blade from the blade holder and dispose of it safely.
- Pull the ice tray and buffer tray off of the dovetail guide and place them on the stage.
- Remove and empty out the buffer tray. Dispose of the contents of the buffer tray properly.
- Remove the specimen plate and lay it flat on the stage.
- Remove the specimen using a single-sided blade and remove any cyanoacrylate adhesive residue from the specimen plate.



#### Caution

The contents of the ice tray can become contaminated if buffer solution is spilled over it.



## 6. Operating the VibroCheck

### 6.1 Using the VibroCheck with the Leica VT1200



#### Warning

The following instructions must be adhered to exactly. Noncompliance can cause serious damage to the instrument.

We recommend using the VibroCheck after each blade change to check the optimum position of the blade and minimize the vertical vibration.

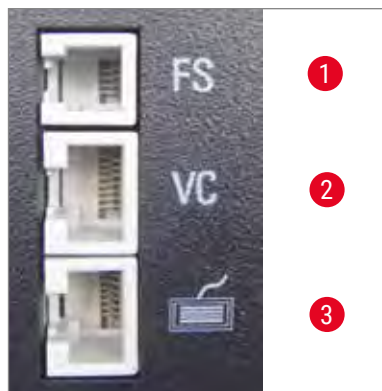

- 1 Foot switch for VT
- 2 VibroCheck
- 3 Control panel for VT

Fig. 20

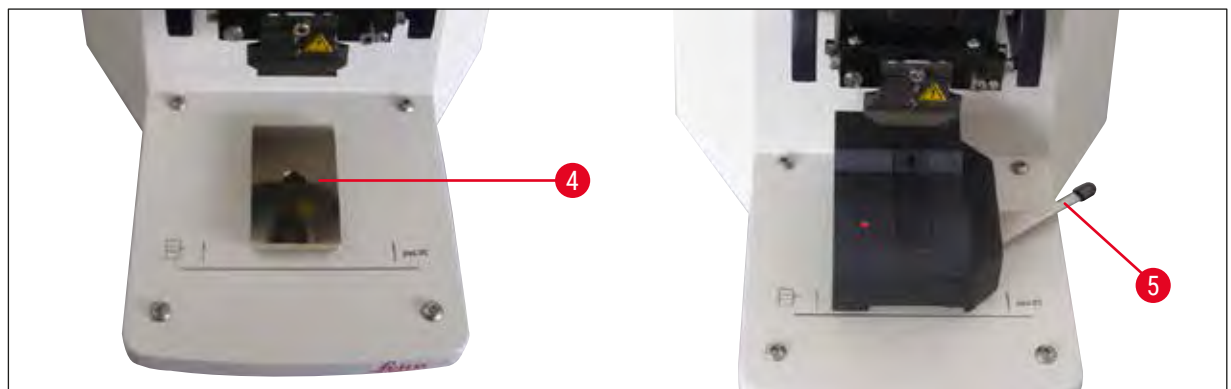

Fig. 21

Prior to assembly, the dovetail guide (→ Fig. 21-4) is brought down to the lowest position using the **DOWN** key!

1. The user installs the VibroCheck: Push the VC along the dovetail guide (→ Fig. 21-4) to behind the mark on the baseplate of the instrument (rear stop) and clamp it down using the lever (→ Fig. 21-5). Insert the blade and clamp tightly. Return the blade to the cutting position see (→ Fig. 17).
2. Plug the connecting plug of the VibroCheck (VC) into the socket (→ Fig. 20-2) on the left side panel. Short red flash of LED on VC → control panel acknowledges VC. LED then remains red. The LED in the **DOWN** key flashes green.
3. The user presses the **DOWN** key. The VC moves to the bottom position, after that the blade moves to the rearmost position – the LED in the **RUN/STOP** key flashes. Short red flash of LED on VC → it then remains red.

## 6 Operating the VibroCheck

- The user presses the **RUN/STOP** key: First, the blade moves forward (into the position exactly above the VibroCheck), then the VC moves into a position in which the blade partially covers the light barrier. (If the VC does not receive any signal via the light barrier, the operation is canceled and **DOWN** is enabled.) LED on VC flashes green – **RUN/STOP** flashes yellow. When LED on VC is green and LED in **RUN/STOP** is yellow, the blade starts to vibrate with the amplitude set. Speed = 0, amplitude can be changed at any time.

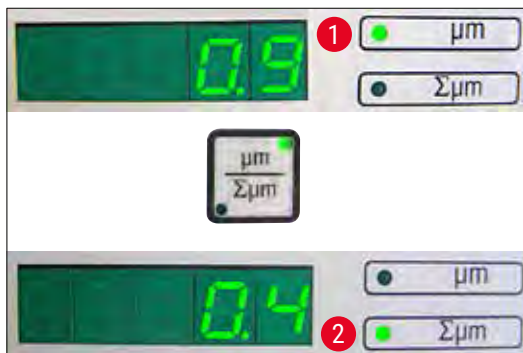

Fig. 22

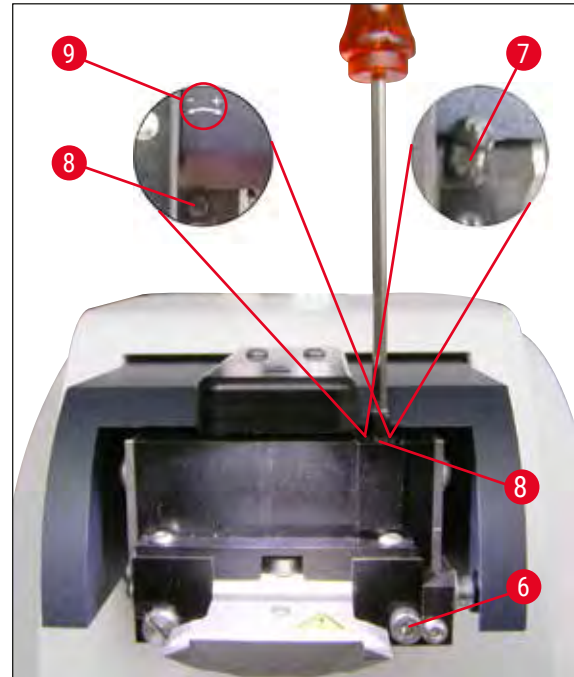

Fig. 23

On the (5-digit) display, the deviation in height amplitude is shown in  $\mu\text{m}$  (e.g. 0.9  $\mu\text{m}$ ). This value can be either positive or negative. The display can be switched using the  $\mu\text{m}/\Sigma\mu\text{m}$  key. Then a number appears (e.g. 0.4). This means clockwise rotation by a turn of 0.4 (+ see (→ Fig. 23-9) – (Neg. operational sign means counterclockwise rotation – see (→ Fig. 23-9).) If the value is 0, no improvement of the height amplitude is possible.

- Press the **STOP** key. Using a size 3 Allen key, unscrew the clamping screw (→ Fig. 23-6) only slightly, pull off the cap (→ Fig. 23-7) by pulling it upwards (keep it in a safe place) and turn the adjusting screw (→ Fig. 23-8) by the corresponding value (here, a turn of 0.4) clockwise (in the + direction, (→ Fig. 23-9)) using a size 3 Allen key. Tighten the clamping screw (→ Fig. 23-6) clockwise.



### Note

If the display shows  $\Sigma\mu\text{m}$  (→ Fig. 22-2) 0 (optimal) and the value in  $\mu\text{m}$  (→ Fig. 22-1) is unacceptably high, the blade must be replaced.

- Press the **RUN** key, check the value, repeat steps 5-7 if necessary.
- If the measured value is accepted, press **DOWN** (flashes green). VC moves to lowest position – blade is moved to the rear. LED on VC illuminates red again (LED on **RUN/STOP** is off).
- The instrument now expects the VibroCheck to be removed. To do so, disconnect the USB plug connection of the VC to the basic instrument and pull the VC off of the dovetail guide. LED in **DOWN** key continues to flash – wait until LED in **DOWN** key goes out. The normal operating status is now restored.

## 6.2 Using the VibroCheck with the Leica VT1200 S



### Warning

The following instructions must be adhered to exactly. Noncompliance can cause serious damage to the instrument.

We recommend using the VibroCheck after each blade change for checking the optimum position of the blade and important sectioning parameters.

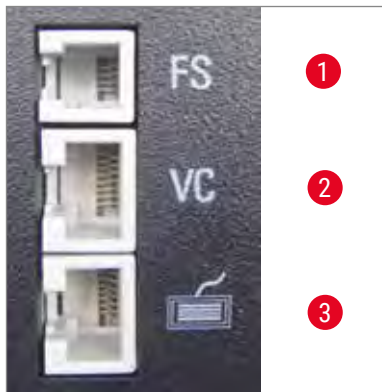

- 1 Foot switch for VT
- 2 VibroCheck
- 3 Control panel for VT

Fig. 24



Fig. 25

Prior to assembly, the dovetail guide (→ Fig. 25-4) is brought down to the lowest position using the **DOWN** key!

1. The user installs the VibroCheck: Push the VC along the dovetail guide (→ Fig. 25-4) to behind the mark on the baseplate of the instrument (rear stop) and clamp it down using the lever (→ Fig. 25-5). Insert the blade and clamp tightly. Return the blade to the cutting position (see (→ Fig. 17)).
2. Plug the connecting plug of the VibroCheck (VC) into the corresponding socket (→ Fig. 24-2) on the left side panel. Short red flash of LED on VC → it then remains red. Control panel detects VC see (→ Fig. 26). The LED in the **DOWN** key flashes green.

## 6 Operating the VibroCheck



Fig. 26



Fig. 27

- The user presses the **DOWN** key. The VC moves to the bottom position, in addition to that the blade moves to the rearmost position – the LED in the **RUN/STOP** key flashes. Short red flash of LED on VC --> it then remains red.
- The user presses the **RUN/STOP** key: First, the blade moves forward (into the position exactly above the VibroCheck), then the VC moves into a position in which the blade partially covers the light barrier. LED on VC flashes green – **RUN/STOP** flashes yellow. Control panel shows: **VIBRO search** see (→ Fig. 27). A search can last up to 1 minute. When LED on VC is green and LED in **RUN/STOP** is yellow, the blade starts to vibrate.

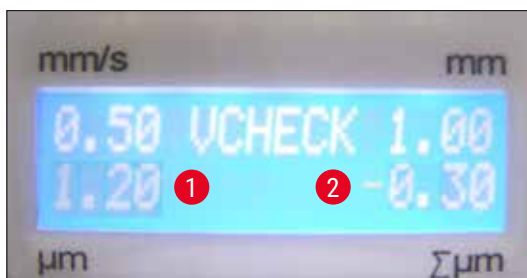

Fig. 28

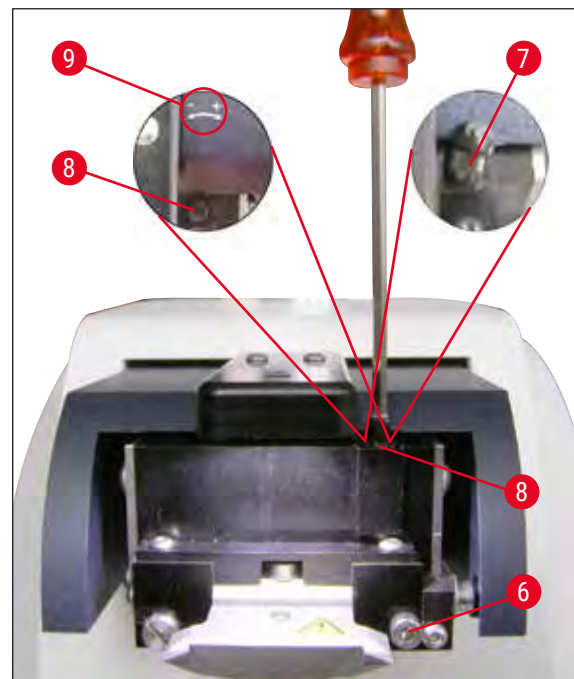

Fig. 29

The deviation of the height amplitude is shown on the display in  $\mu\text{m}$  (→ Fig. 28-1). This value can be either positive or negative. A number (e.g. -0.3) (→ Fig. 28-2) appears in the  $\Sigma\mu\text{m}$  display. This means a **COUNTERCLOCKWISE** rotation (because of the - (→ Fig. 29-9)) by a turn of 0.3 and reduces the height amplitude to a minimum. (If there is no operation sign, the rotation is in a clockwise direction + (→ Fig. 29-9).) If the value is 0, no improvement of the height amplitude is possible.

- Press the **STOP** key. Unscrew the clamping screw (→ Fig. 29-6) only slightly using the size 3 Allen key, pull the cap (→ Fig. 29-7) up and off (keep it in a safe place) and turn the adjusting screw (→ Fig. 29-8) **COUNTERCLOCKWISE** (the - direction, (→ Fig. 29-9)) by a turn of 0.3 using the size 3 Allen key. Tighten the clamping screw (→ Fig. 29-6) clockwise.

6. Press the **RUN** key, check the value, repeat steps 5-7 if necessary.

**Note**

If the display shows  $\Sigma\mu\text{m}$  ( $\rightarrow$  Fig. 28-2) 0 (optimal) and the value in  $\mu\text{m}$  ( $\rightarrow$  Fig. 28-1) is unacceptably high, the blade must be replaced.

7. If the measured value is accepted, press **DOWN** (flashes green). VC moves to lowest position – blade is moved to the rear. Control panel of the VT shows: **VIBRO END** ( $\rightarrow$  Fig. 30). The LED on the VC is again illuminated in red.



Fig. 30

8. The instrument now expects the VibroCheck to be removed. To do so, disconnect the USB plug connection of the VC to the basic instrument and pull the VC off of the dovetail guide. LED in **DOWN** key continues to flash – wait until LED in **DOWN** key goes out. The normal operating status is now restored.

## 7. Malfunctions: Meaning and Troubleshooting

### 7.1 Error messages and troubleshooting

Error No. / INF No.	Error	Troubleshooting	Comment
<b>Error 01</b>	<ul style="list-style-type: none"> <li>Wrong control panel (Leica VT1200 or Leica VT1200 S)</li> </ul>	<ul style="list-style-type: none"> <li>Use the correct control panel for the instrument.</li> </ul>	<ul style="list-style-type: none"> <li>Using an incorrect control panel does not harm the instrument, but no functions whatsoever are available.</li> </ul>
<b>Error 21</b>	<ul style="list-style-type: none"> <li>Head does not swing into place.</li> </ul>	<ol style="list-style-type: none"> <li>1. Check to see if an amplitude value has been selected.</li> <li>2. Try to make the head swing into place by gently striking it with your hand.</li> <li>3. If head does not swing into place, inform service.</li> </ol>	
<b>Error 22</b>	<ul style="list-style-type: none"> <li>Timeout while initializing the x-axis. (Timeout)</li> </ul>	<ul style="list-style-type: none"> <li>Inform service!</li> </ul>	
<b>Error 23</b>	<ul style="list-style-type: none"> <li>DC motor of x-axis does not rotate (during initialization or in normal operation).</li> </ul>	<ul style="list-style-type: none"> <li>Inform service!</li> </ul>	
<b>Error 24</b>	<ul style="list-style-type: none"> <li><b>X-Start</b> limit switch is not reached.</li> </ul>	<ul style="list-style-type: none"> <li>Inform service!</li> </ul>	
<b>Error 25</b>	<ul style="list-style-type: none"> <li><b>X-Start</b> limit switch cannot be moved away from.</li> </ul>	<ul style="list-style-type: none"> <li>Inform service!</li> </ul>	
<b>Error 26</b>	<ul style="list-style-type: none"> <li><b>X-Stop</b> limit switch is not reached.</li> </ul>	<ul style="list-style-type: none"> <li>Inform service!</li> </ul>	



#### Note

After all error messages, the instrument **MUST** be switched off, then on again using the power switch.

<b>Error 27</b>	<ul style="list-style-type: none"> <li><b>Bottom</b> limit switch of the Z-axis is not reached during initialization or operation.</li> </ul>	<ul style="list-style-type: none"> <li>Check whether an obstacle is blocking the travel path of the ice tray. Remove the obstacle. If there is no obstacle and the error message persists after the instrument is switched on again: Inform service.</li> </ul>
-----------------	---	---

Error No. / INF No.	Error	Troubleshooting	Comment
<b>Error 28</b>	<ul style="list-style-type: none"> <li>The top limit switch of the Z-axis is not reached.</li> </ul>	<ul style="list-style-type: none"> <li>Check whether an obstacle is blocking the travel path of the ice tray. Remove the obstacle. If there is no obstacle and the error message persists after the instrument is switched on again: Inform service.</li> </ul>	
<b>Error 31</b>	<ul style="list-style-type: none"> <li>Both X sensors activated (during initialization or in normal operation)</li> </ul>	<ul style="list-style-type: none"> <li>Inform service!</li> </ul>	
<b>Error 32</b>	<ul style="list-style-type: none"> <li>Both Z sensors activated (during initialization or in normal operation)</li> </ul>	<ul style="list-style-type: none"> <li>Inform service!</li> </ul>	

**Note**



After all error messages, the instrument **MUST** be switched off, then on again using the power switch.

<b>InF 41</b>	<ul style="list-style-type: none"> <li>Control board (C1/back panel) and keyboard (C2) have different software versions.</li> </ul>	<ul style="list-style-type: none"> <li>It is possible that due to different software versions, some or all functions of the instrument may be partly or entirely unavailable. Inform service and have the software updated to the latest version.</li> </ul>	
<b>InF 42</b>	<ul style="list-style-type: none"> <li>Control board (C1/back panel) and VibroCheck (C3) have different software versions.</li> </ul>	<ul style="list-style-type: none"> <li>It is possible that due to different software versions, some or all functions of the instrument may be partly or entirely unavailable.</li> </ul>	





**Note**

- InF messages can be removed by pressing the **CLEAR** key.
- The message appears once each time the instrument is switched **ON**.
- InF messages do not cause the instrument to be locked.
- After all error messages, the instrument **MUST** be switched off, then on again using the power switch. – Exceptions are InF 41 and 42.



Error No. / INF No.	Error	Troubleshooting	Comment
<b>Error 51</b>	<ul style="list-style-type: none"> <li>Horizontal calibration of VibroCheck is not possible.</li> </ul>	<ul style="list-style-type: none"> <li>Possible operating error, see the Instructions for Use.</li> <li>Great deal of damage or dirt on the blade or blade holder. Use a new blade or blade holder.</li> <li>Controllers have different software versions. Have the software updated.</li> <li>VibroCheck is defective. Have it checked by service.</li> </ul>	<ul style="list-style-type: none"> <li>A calibration is carried out even if the blade is jagged.</li> <li>A great deal of obvious damage or dirt must be present before a blade calibration is canceled automatically.</li> </ul>
<b>Error 52</b>	<ul style="list-style-type: none"> <li>Basic calibration of light barrier is not possible for VibroCheck.</li> </ul>	<ul style="list-style-type: none"> <li>Emitter diode or receiver is defective.</li> <li>VibroCheck is defective.</li> <li>Inform service!</li> </ul>	
<b>Error 53</b>	<ul style="list-style-type: none"> <li>VibroCheck blade search not successful.</li> </ul>	<ul style="list-style-type: none"> <li>No blade and/or blade holder swung out or not installed.</li> <li>Emitter diode or receiver dirty. Clean.</li> <li>VibroCheck is defective.</li> </ul>	<ul style="list-style-type: none"> <li>Leica VT1200 drives to the lowest Z position using the stepper motor after an unsuccessful search. (Allows blade installation)</li> </ul>
<b>Communication between keyboard – Leica VT1200 S</b>	<ul style="list-style-type: none"> <li>Communication error between control unit and VT</li> </ul>	<ul style="list-style-type: none"> <li>Leica VT1200 S display lights up, but remains blank.</li> <li>Leica VT1200: row of dots flashes.</li> <li>Inform service!</li> </ul>	
<b>The knife/blade collides with the buffer tray</b>	<ul style="list-style-type: none"> <li>The buffer tray was not pushed in up to the rear pin or was not clamped down during installation.</li> </ul>	<ul style="list-style-type: none"> <li>Push in the buffer tray as far as it will go and clamp it down with the lever.</li> </ul>	
<b>The VibroCheck collides with the blade</b>	<ul style="list-style-type: none"> <li>The VibroCheck was not pushed all the way in or was not clamped down during installation.</li> </ul>	<ul style="list-style-type: none"> <li>Push in the VibroCheck as far as it will go and clamp it down with the lever.</li> </ul>	
	<ul style="list-style-type: none"> <li>Switching from <b>SINGLE</b> to <b>CONT</b> is not possible.</li> </ul>	<ul style="list-style-type: none"> <li>In <b>MAN</b> mode, only single cuts are possible.</li> </ul>	
	<ul style="list-style-type: none"> <li>The cutting window cannot be defined.</li> </ul>	<ul style="list-style-type: none"> <li>In <b>MAN</b> mode, only single cuts are possible.</li> <li>If multiple cuts are required, switch to <b>AUTO</b> mode.</li> </ul>	



Error No. / INF No.	Error	Troubleshooting	Comment
	<ul style="list-style-type: none"> <li>• <b>NOT</b> accepted:                             <ul style="list-style-type: none"> <li>– Negative values</li> <li>– Values of more than 1000 µm</li> </ul> </li> </ul>		
	<ul style="list-style-type: none"> <li>• In <b>MAN</b> mode, pressing the <b>AUTO FEED</b> key feeds the last saved value.</li> </ul>		<b>Note: Blocked when <b>RUN</b> is active!</b>
	<ul style="list-style-type: none"> <li>• When a key is pressed, a beep sounds.</li> </ul>		<ul style="list-style-type: none"> <li>• In <b>MAN</b> mode, if the <b>PAUSE</b> key has not been assigned a function, a short beep sounds.</li> </ul>
		<b>Note</b> If the 1000 hour limit is exceeded while the instrument is in normal operating mode, a flashing <b>SEr</b> appears in the upper 3-digit LED for approx. three seconds after the sectioning process has been ended with the <b>RUN/STOP</b> key. This indicates that the vibrating component needs to be serviced.	
<b>The instrument is not working</b>	<ul style="list-style-type: none"> <li>• The plug connections are loose or the instrument is connected to the power supply improperly or not at all.</li> <li>• The power fuses are defective.</li> </ul>	<ul style="list-style-type: none"> <li>• VT connection cable: Check the control unit and power plug.</li> <li>• Replace the power fuses.</li> </ul>	

**7.2 Replacing the main fuse****Caution**

Always unplug the power supply before replacing the fuses!

**Fig. 31****Fig. 32****Fig. 33**

- Remove the fuse housing on the right side of the instrument above the power switch. To do so, push an appropriate tool (small screwdriver) into the slots on the left and right (→ Fig. 31) and carefully pull it out.
- Remove the defective fuse and replace it with the replacement fuse included in the standard scope of delivery (→ Fig. 32).
- Reinsert the fuse housing into the holder on the instrument as shown in (→ Fig. 33) and gently push it in until you hear it click into place.

## 8. Cleaning and Maintenance

### 8.1 Cleaning the instrument



#### Warning

- Always put the blades back into the blade case/dispenser when not in use.
- When using cleaners, comply with the safety instructions from the manufacturer and the labor-safety regulations at your laboratory.
- When cleaning the outer surfaces of the instrument, do not use xylene or solvents containing acetone or xylene. The finished surfaces are not resistant to xylene or acetone!
- Ensure that liquids do not enter the interior of the instrument during cleaning.

#### Before each cleaning, carry out the following preparatory steps:

- Switch off the power switch on the side of the instrument.
- Place the magnifier cover on the magnifier.
- Remove the blade from the blade holder and dispose of it safely.
- Pull the ice tray and buffer tray off of the dovetail guide and place them on the stage.
- Remove and empty out the buffer tray. Dispose of the contents of the buffer tray properly.
- Remove the specimen plate and lay it flat on the stage.
- Remove the specimen using a single-sided blade and remove any cyanoacrylate adhesive residue from the specimen plate.

#### Instrument and outside surfaces

If necessary, the varnished outside surfaces of the control panels can be cleaned with a mild commercial household cleaner or soap water and then be wiped with a cloth.

The instrument must be completely dry before it can be used again.

#### Cleaning the blades



#### Warning

Always wipe the blade from the back of the blade (sapphire blade) to the cutting edge.  
**NEVER** wipe in the opposite direction – risk of injury!

Clean using an alcohol-based solution or acetone.

## 9. Ordering Information for Optional Accessories, Consumables and Spare Parts

Designation	Order No.
<b>Ice tray</b>	14 0481 42010
<b>Buffer tray</b>	
Buffer tray, assembly (plastic)	14 0481 42089
Buffer tray, assembly (metal)	14 0481 42084
Buffer tray, double-walled, assembly	14 0481 44837
Lids for covering the buffer trays made of plastic or metal	14 0481 42090
Hose clamp	14 0481 41952
<b>Specimen plate</b>	
Specimen plate, non-directional (for 20 mm high specimens)	14 0481 42086
Specimen plate, non-directional (for 10 mm high specimens)	14 0481 43399
Specimen disc, orienting	14 0481 42068
<b>Blade</b>	
Sapphire blade, knife angle of 22°	14 0216 39372
Blade holder, assembly	14 0481 42030
<b>VibroCheck</b>	14 0481 42075
<b>Display</b>	
Microscope, assembly	14 0481 42024
Cover for the LED connection	14 0481 43402
Magnifier, assembly	14 0481 42035
<b>LED illumination</b>	
Module Hi Power Spot, LED 1000	14 6000 04825
Module LED Hi-Power spots, 2-arm	14 6000 04826
<b>Adhesive</b>	
Cyanoacrylate adhesive containing 10 gr.	14 0371 27414
<b>Foot switch</b>	14 0481 43397
<b>Protective cover, small</b>	14 0212 43742
<b>Protective cover, large</b>	14 0212 43743
<b>Fuse: cut-out T1A, 5*20</b>	14 6943 01000
<b>Cover for the LED connection</b>	14 0481 43402
<b>Julabo FL300, recirculating cooler/chiller</b>	
100 V/50-60 Hz	14 0481 48439
115 V/50 Hz	14 0481 48437
230 V/50-60 Hz	14 0481 48436
230 V/60 Hz	14 0481 48438
<b>Antifrogen N</b>	14 0481 45443

9.1 Extension accessories for standard specimens



Fig. 34

**Ice tray**

- Removable
- Drawer design
- Remains stable on the stage when preparing specimen
- Integrated hand rests for use with Leica VT1200 / Leica VT1200 S.

**Order No. ....14 0481 42010**

9.1.1 Buffer trays



Fig. 35

**Buffer tray, assembly (plastic)**

- Buffer tray and lid
- Magnetic holder for the specimen plate
- Specimen plate, non-directional
- Clamp (2x) for holding the hose in position in the buffer tray
- Volume: 125 cm<sup>3</sup> \*
- Autoclavable

**Order No. ....14 0481 42089**

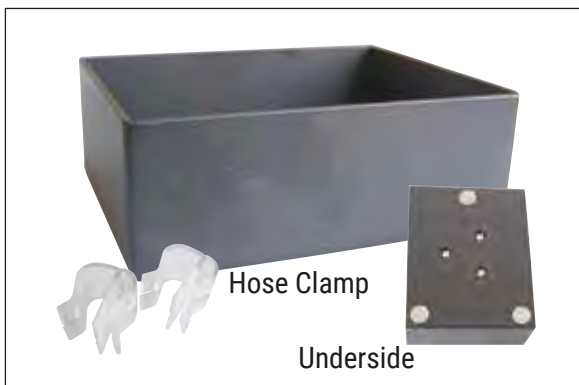

Fig. 36

**Buffer tray, assembly (metal)**

- Buffer tray and lid
- Magnetic holder for the specimen plate (see the minimized illustration)
- Specimen plate, non-directional
- Clamp (2x) for holding the hose in position in the buffer tray
- Volume: 125 cm<sup>3</sup> \*
- Non-autoclavable

**Order No. ....14 0481 42084**

\* (Specifications without the blade holder, measured 4 mm below the upper edge of the buffer tray)

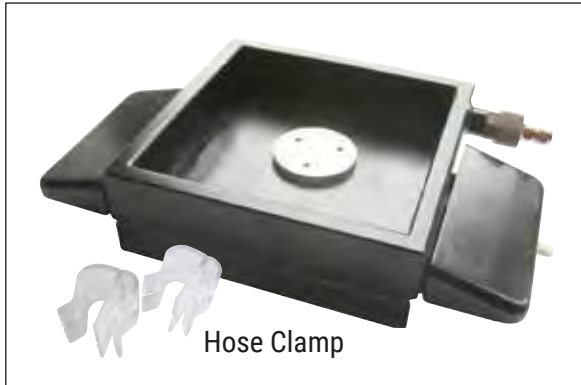

Fig. 37

**Buffer tray, double-walled, incl. integrated hand rest, assembly**

- Buffer tray, double-walled
- Magnetic holder for the specimen plate
- Specimen plate, non-directional
- Clamp for holding the hose in position in the buffer tray
- Volume: 400 cm<sup>3</sup> \*
- Non-autoclavable
- Hose set for connecting a recirculating cooler/ chiller (e.g. 14 0481 48436)

**Order No. ....14 0481 44837**



Fig. 38

**Lid for covering the buffer tray**

- The buffer tray is available in plastic (14 0481 42089) or metal (14 0481 42084)

**Order No. ....14 0481 42090**

**9.1.2 Specimen plate**

Fig. 39

**Specimen plate, non-directional**

- For specimens 2 cm in height
- Can be rotated 360°
- Attached with magnets in the buffer tray

**Order No. ....14 0481 42086**

\* (Specifications without the blade holder, measured 4 mm below the upper edge of the buffer tray)



Fig. 40

**Specimen plate, non-directional**

- For specimens 1 cm in height
- Can be rotated 360°
- Attached with magnets in the buffer tray

**Order No. ....14 0481 43399**



Fig. 41

**Specimen disc, orienting**

- Inc. swivel handle
- Inc. marks for angling specimen 2.5° and 5°

**Order No. ....14 0481 42068**

**9.1.3 VibroCheck**

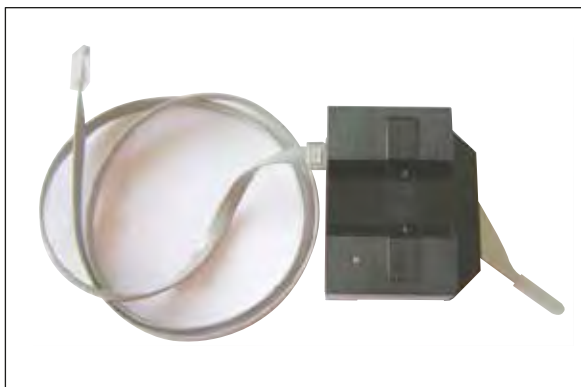

Fig. 42

Optional measuring instrument for displaying the vertical deviation of the blade (in  $\mu\text{m}$ ) and for displaying the direction of rotation of the screws used to minimize the vertical deviation of the blade. Can be adjusted using the adjusting screw on the blade holder.

**Order No. ....14 0481 42075**

9.1.4 Blades



Fig. 43

Sapphire blade, knife angle of 22°

The blade can be reground.

Order No. ....14 0216 39372

9.1.5 Microscope, assembly



Fig. 44

- Microscope support
- S9E Stereozoom microscope
- 2 eyepieces, 10x23 B, adjustable
- Protective objective glass
- Bearing cylinder with 3 screws
- Dust cover, large
- Adapter for module LED Hi-Power spots 2-arm slot
- Cover for the LED connection

Order No. ....14 0481 42024

9.1.6 Magnifier, assembly



Fig. 45

- Magnifier support
- Lens (2x magnification) with lens cover (→ Fig. 45-1)
- Bearing cylinder with 3 screws
- Dust cover, large
- Adapter for module LED Hi-Power spots 2-arm slot

Order No. ....14 0481 42035



## 9.1.7 Installing the magnifier support or microscope support



Fig. 46

- First, remove the cover (→ Fig. 46-1) from the basic instrument and store it in a safe place.
- Insert the provided Allen screws (→ Fig. 46-2) into the hole (→ Fig. 46-3) in the bearing bush. Use the size 3 Allen key to screw the screws into the open slot on the top side of the basic instrument.
- Push the magnifier support or microscope support into the bearing bush as far as it will go.



Fig. 47

- Adjust the magnifier to the desired inclination angle and screw in the screw (→ Fig. 47-4) using the size 3 Allen key, or
- Insert the S9E Stereozoom microscope into the ring holder and attach it by screwing it down (→ Fig. 48-5).
- Determine the desired inclination angle of the microscope and fix it in place by tightening the screw (→ Fig. 48-6) clockwise using a size 3 Allen key.
- The microscope height can be adjusted using the setting dials for height adjustment (→ Fig. 48-7) and adapted to the respective specimen.

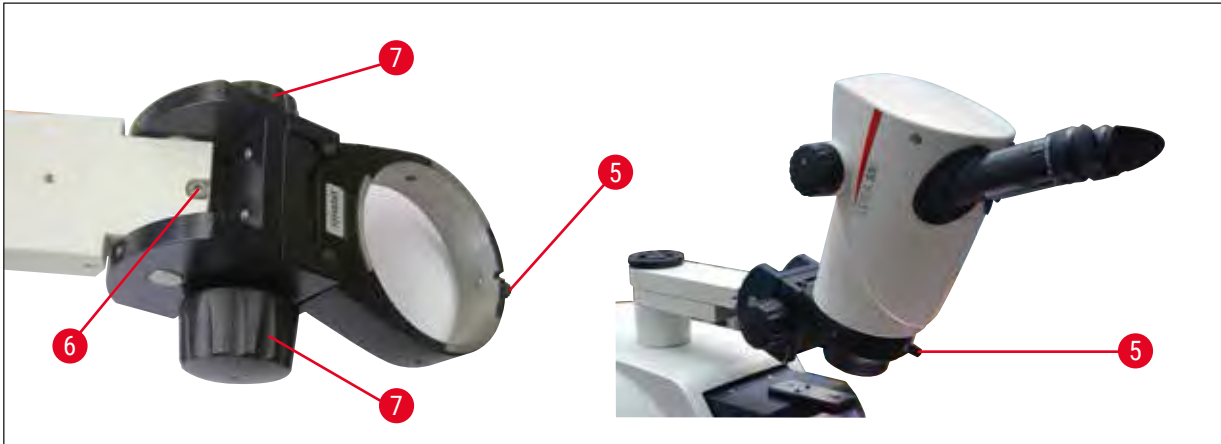

Fig. 48

### 9.1.8 Fiber-optic illumination, cold light source



Fig. 49



#### Note

Before use, carefully read the separately provided Instructions for Use!



Fig. 50

**Module LED Hi-Power spots, 2-arm**

- The module LED Hi-Power spots with 2-arm is installed after the magnifier has been installed in the magnifier holder and then connected to the module Hi-Power spot, LED 1000.

**Order No. ....14 6000 04826**

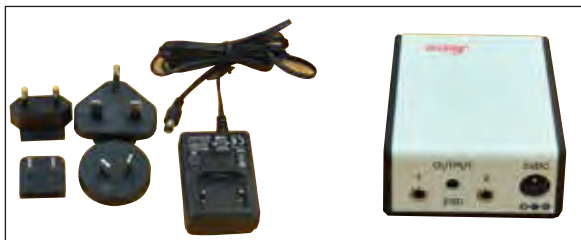

Fig. 51

**Module Hi-Power spot, LED 1000**

- Serves as a light source for the module LED Hi-Power spots, 2-arm.

**Order No. ....14 6000 04825**



**Warning**

The LED illumination must be operated at the power supply voltage specified on the nameplate (on the underside of the adapter).

**9.1.9 Cyanoacrylate adhesive**

Single-component adhesive for adhering specimens to the specimen plate – contains 10 gr.

**Order No. ....14 0371 27414**

**9.1.10 Foot switch**

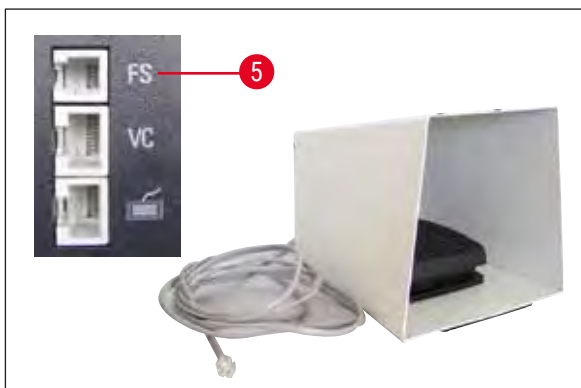

Fig. 52

Insert the foot switch into the uppermost socket marked FS (→ Fig. 52-5) on the left side of the basic instrument.

- The foot switch performs the START/STOP function.

**Order No. ....14 0481 43397**

## 9.1.11 Julabo FL300 – recirculating cooler/chiller



Fig. 53

Recirculating cooler/chiller for connecting to the double-walled buffer tray in the Leica VT1000 S and Leica VT1200 / Leica VT1200 S.

Selectable temperature range: -20 °C to +40 °C

Recommended cooling medium: Antifrogen N  
(14 0481 45443)

Mixture with water  
(50 %/50 %)

**Application example:**

If (at an ambient temperature of 20 to 22 °C) a temperature of 4 °C is to be reached in the buffer tray, a setting value of 0.5 to 2 °C must be selected.

**Note**

For additional information, refer to the Instructions for Use provided with this instrument.

## **10. Warranty and Service**

### **Warranty**

Leica Biosystems Nussloch GmbH guarantees that the contractual product delivered has been subjected to a comprehensive quality control procedure based on the Leica in-house testing standards, and that the product is faultless and complies with all technical specifications and/or agreed characteristics warranted.

The scope of the warranty is based on the content of the concluded agreement. The warranty terms of your Leica sales organization or the organization from which you have purchased the contractual product shall apply exclusively.

### **Service information**

If you are in need of technical customer support or spare parts, please contact your Leica representative or the Leica dealer where you purchased the instrument.

Please provide the following information:

- Model name and serial number of the instrument
- Location of the instrument and name of the person to contact
- Reason for the service call
- Delivery date

### **Decommissioning and disposal**

The instrument or parts of the instrument must be disposed of according to existing applicable, local regulations.

## **11** Decontamination Confirmation

---

### **11. Decontamination Confirmation**

Every product that is returned to Leica Biosystems or that requires on-site maintenance must be properly cleaned and decontaminated. You can find the dedicated template of the decontamination confirmation on our website [www.LeicaBiosystems.com](http://www.LeicaBiosystems.com) within the product menu. This template has to be used for gathering all required data.

When returning a product, a copy of the filled and signed confirmation has to be enclosed or passed on to the service technician. The responsibility for products that are sent back without this confirmation or with an incomplete confirmation lies with the sender. Returned goods that are considered to be a potential source of danger by the company will be sent back at the expense and risk of the sender.



[www.LeicaBiosystems.com](http://www.LeicaBiosystems.com)



Leica Biosystems Nussloch GmbH  
Heidelberger Strasse 17 - 19  
69226 Nussloch  
Germany

Tel.: +49 - (0) 6224 - 143 0  
Fax: +49 - (0) 6224 - 143 268  
Web: [www.LeicaBiosystems.com](http://www.LeicaBiosystems.com)